

## RF Test Report

Applicant : Askey Computer Corp  
Product Type : Wi-Fi and Bluetooth functionalities module  
Trade Name : ASKEY  
Model Number : STI625X  
Applicable Standard : FCC 47 CFR PART 15 SUBPART C  
ANSI C63.10:2013  
Received Date : Aug. 17, 2021  
Test Period : Aug. 27 ~ Sep. 09, 2021  
Issued Date : Sep. 24, 2021

### Issued by

A Test Lab Techno Corp.  
No. 140-1, Changan Street, Bade District,  
Taoyuan City 33465, Taiwan (R.O.C.)  
Tel : +886-3-2710188 / Fax : +886-3-2710190



Taiwan Accreditation Foundation accreditation number: 1330

Frequency Range : 9 kHz to 40 GHz

Test Firm MRA designation number: TW0010

#### **Note:**

- 1.The test results are valid only for samples provided by customers and under the test conditions described in this report.
- 2.This report shall not be reproduced except in full, without the written approval of A Test Lab Technology Corporation.
- 3.The relevant information is provided by customers in this test report. According to the correctness, appropriateness or completeness of the information provided by the customer, if there is any doubt or error in the information which affects the validity of the test results, the laboratory does not take the responsibility.



### Revision History

Rev.	Issued Date	Revisions	Revised By
00	Sep. 24, 2021	Initial Issue	Tobey Cheng

## Verification of Compliance

Applicant : Askey Computer Corp

Product Type : Wi-Fi and Bluetooth functionalities module

Trade Name : ASKEY

Model Number : STI625X

FCC ID : H8N-STI625X

EUT Rated Voltage : VBAT DC 3.3 V & VDDIO DC 1.8 V

Test Voltage : 120 Vac / 60 Hz

Applicable Standard : FCC 47 CFR PART 15 SUBPART C  
ANSI C63.10:2013

Test Result : Complied

Performing Lab. : A Test Lab Techno Corp.  
No. 140-1, Changan Street, Bade District,  
Taoyuan City 33465, Taiwan (R.O.C.)  
Tel : +886-3-2710188 / Fax : +886-3-2710190  
Taiwan Accreditation Foundation accreditation number: 1330  
<http://www.atl-lab.com.tw/e-index.htm>



A Test Lab Techno Corp. tested the above equipment in accordance with the requirements set forth in the above standards. All indications of Pass/Fail in this report are opinions expressed by A Test Lab Techno Corp. based on interpretations and/or observations of test results. The test results show that the equipment tested is capable of demonstrating compliance with the requirements as documented in this report.

Approved By :

\_\_\_\_\_  
(Kai Yu Yang)



## TABLE OF CONTENTS

<b>1</b>	<b>General Information</b>	<b>5</b>
1.1.	Summary of Test Result	5
1.2.	Measurement Uncertainty	6
<b>2</b>	<b>EUT Description</b>	<b>7</b>
<b>3</b>	<b>Test Methodology</b>	<b>8</b>
3.1.	Mode of Operation	8
3.2.	EUT Test Step	8
3.3.	Configuration of Test System Details	9
3.4.	Test Instruments	10
3.5.	Test Site Environment	11
<b>4</b>	<b>Measurement Procedure</b>	<b>12</b>
4.1.	AC Power Line Conducted Emission Measurement	12
4.2.	Radiated Emission Measurement	14
4.3.	Maximum Conducted Output Power Measurement	18
4.4.	6 dB RF Bandwidth Measurement	19
4.5.	Maximum Power Density Measurement	20
4.6.	Out of Band Conducted Emissions Measurement	21
4.7.	Antenna Measurement	21
<b>5</b>	<b>Test Results</b>	<b>22</b>
	Annex A. Conducted Emission	22
	Annex B. Conducted Test Results	24
	Annex C. Radiated Emission Measurement	37
<b>6</b>	<b>EUT Photos</b>	<b>67</b>



# 1 General Information

## 1.1. Summary of Test Result

Standard	Item	Result	Remark
15.207	AC Power Conducted Emission	PASS	----
15.247(d)	Transmitter Radiated Emissions	PASS	----
15.247(b)(3)	Max. Output Power	PASS	----
15.247(a)(2)	6 dB RF Bandwidth	PASS	----
15.247(e)	Maximum Power Spectral Density	PASS	----
15.247(d)	Out of Band Conducted Spurious Emission	PASS	----
15.203	Antenna Requirement	PASS	----

### Decision Rule

- Uncertainty is not included.
- Uncertainty is included.

Standard	Description
CFR47, Part 15, Subpart C	Intentional Radiators
ANSI C63. 10: 2013	American National Standard of Procedures for Compliance Testing of Unlicensed Wireless Devices
KDB 558074 D01 15.247 Meas Guidance v05r02	GUIDANCE FOR COMPLIANCE MEASUREMENTS ON DIGITAL TRANSMISSION SYSTEM, FREQUENCY HOPPING SPREAD SPECTRUM SYSTEM, AND HYBRID SYSTEM DEVICES OPERATING UNDER SECTION 15.247 OF THE FCC RULES



## 1.2. Measurement Uncertainty

Test Item	Frequency Range	Uncertainty
Conducted Emission	150 kHz ~ 30 MHz	2.7 dB
Radiated Emission	9 kHz ~ 30 MHz	2.2 dB
	30 MHz ~ 1000 MHz	5.1 dB
	1000 MHz ~ 18000 MHz	5.1 dB
	18000 MHz ~ 26500 MHz	4.4 dB
	26500 MHz ~ 40000 MHz	4.6 dB
Conducted Output Power	1.1 dB	
RF Bandwidth	4.7 %	
Power Spectral Density	1.1 dB	

## 2 EUT Description

Applicant	Askey Computer Corp 10F, No. 119, JIANKANG RD. ZHONGHE DIST, NEW TAIPEI CITY, Taiwan	
Manufacturer	Askey Computer Corp 10F, No. 119, JIANKANG RD. ZHONGHE DIST, NEW TAIPEI CITY, Taiwan	
Product Type	Wi-Fi and Bluetooth functionalities module	
Trade Name	ASKEY	
Model No.	STI625X	
FCC ID	H8N-STI625X	
Frequency Range	2402 ~ 2480 MHz	
Modulation Type	GFSK	
Operate Temp. Range	0 ~ 40 °C	
Antenna information	Type	Max. Gain (dBi)
	Dipole Antenna	2.45
RF Output Power	LE, GFSK:	0.00617 W
	2LE, GFSK:	0.00690 W
	BLR C2, GFSK:	0.00573 W
	BLR C8, GFSK:	0.00569 W

### 3 Test Methodology

#### 3.1. Mode of Operation

Decision of Test ATL has verified the construction and function in typical operation. All the test modes were carried out with the EUT in normal operation, which was shown in this test report and defined as:

Pre-Test Mode
Mode 1: Transmit mode
Mode 2: LE, GFSK Continuous TX Mode
Mode 3: 2LE, GFSK Continuous TX Mode
Mode 4: BLR C2, GFSK Continuous TX Mode
Mode 5: BLR C8, GFSK Continuous TX Mode

Final-Test Mode
Mode 1: Transmit mode
Mode 2: LE, GFSK Continuous TX Mode
Mode 3: 2LE, GFSK Continuous TX Mode

Software used to control the EUT for staying in continuous transmitting mode was programmed.

After verification, all tests were carried out with the worst case test modes.

By preliminary testing and verifying three axis (X, Y and Z) position of EUT transmitted status, it was found that “Z axis” position was the worst, then the final test was executed the worst condition and test data were recorded in this report.

Note: The EUT was programmed to be in continuously transmitting mode and the transmit duty cycle is not less than 98 %.

#### 3.2. EUT Test Step

1	Setup the EUT shown on “Configuration of Test System Details”.
2	Turn on the power of all equipment.
3	Turn on TX function.
4	EUT run test program.

Measurement Software			
No.	Description	Software	Version
1	Conducted Emission	EZ EMC	1.1.4.3
2	Radiated Emission	EZ EMC	1.1.4.4



### 3.3. Configuration of Test System Details

#### Conducted Emission

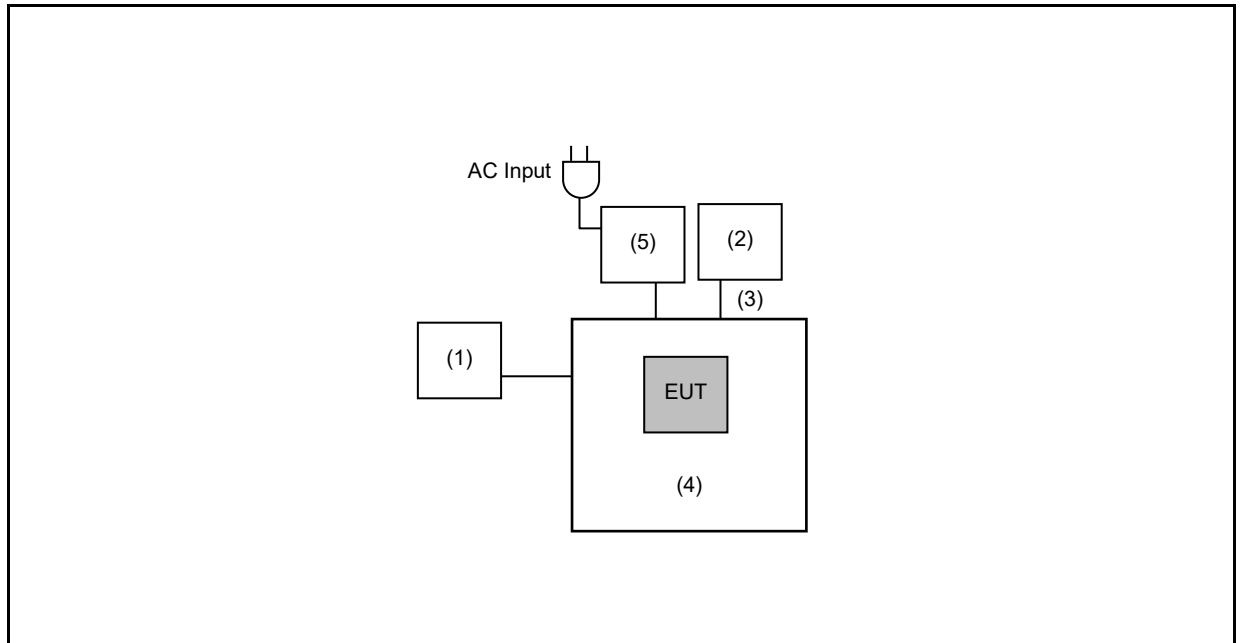

#### Radiated Emissions

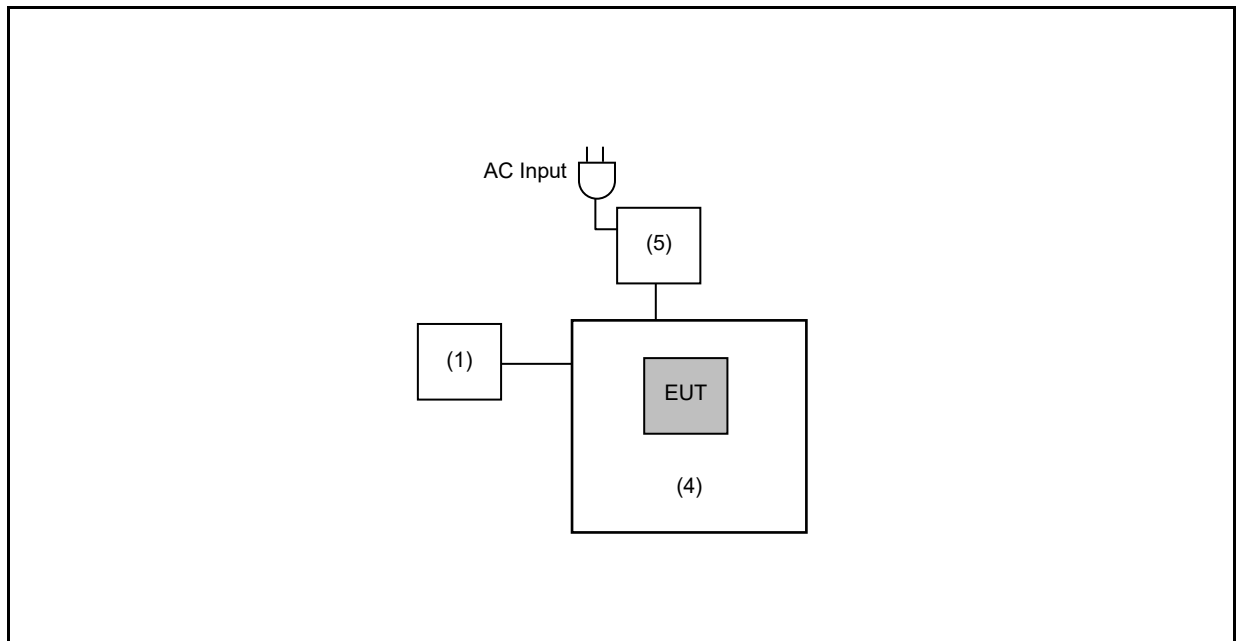



Devices Description					
	Product	Manufacturer	Model Number	Serial Number	Power Cord
(1)	Notebook	acer	N19C1	NXEG8TA008109033BD3400	---
(2)	LCD Monitor	ViewSonic	VS16861	UZJ195120842	---
(3)	HDMI Cable	Avier	K48GHS	---	---
(4)	Fixture	Askey	STI625x	---	---
(5)	AC Adapter	Delta	ADP-90WH KBA	---	---

### 3.4. Test Instruments

For Conducted Emission

Test Period: Sep. 09, 2021

Testing Engineer: Andy Lu

Equipment	Manufacturer	Model Number	Serial Number	Cal. Date	Cal. Period
Test Receiver	R&S	ESCI	100367	05/21/2021	1 year
LISN	R&S	ENV216	101040	03/29/2021	1 year
LISN	R&S	ENV216	101041	04/08/2021	1 year
RF Cable	Woken	00100D1380194M	TE-02-03	05/28/2021	1 year

Note: N.C.R. = No Calibration Request.



For Radiated Emissions

Test Period: Aug. 27 ~ Sep. 07, 2021

Testing Engineer: Hung Chou, Marc Yeh, Eva Lee

Equipment	Manufacturer	Model Number	Serial Number	Cal. Date	Cal. Period
Spectrum Analyzer (2 Hz~50 GHz)	Keysight	N9030B	MY57143537	04/19/2021	1 year
Pre Amplifier (100 kHz~1.3 GHz)	Agilent	8447D	2944A11119	01/15/2021	1 year
Pre Amplifier (1~26.5 GHz)	Agilent	8449B	3008A02237	10/21/2020	1 year
Broadband Antenna	Schwarzbeck	VULB9168	01146	07/19/2021	1 year
Horn Antenna (1~18 GHz)	SCHWARZBECK MESS-ELEKTRONIK	BBHA9120D	02207	07/09/2021	1 year
Horn Antenna (18~40 GHz)	ETS	3116	00086467	12/03/2020	1 year
Coaxial Cable	Titan	T0710AT327A10A 100	J11005	08/06/2021	1 year
Coaxial Cable	Titan	T0710AT327A10A 900	J11004	08/06/2021	1 year
Coaxial Cable	Titan	T0712AT340A12A 900	J11002	08/06/2021	1 year

For Conducted

Test Period: Aug. 27 ~ Sep. 07, 2021

Testing Engineer: Brian Lin, Andy Lu

Equipment	Manufacturer	Model Number	Serial Number	Cal. Date	Cal. Period
Power Sensor	Anritsu	MA2411B	1126022	09/01/2020 09/03/2021	1 year
Power Meter	Anritsu	ML2495A	1135009	09/01/2020 09/03/2021	1 year
Spectrum Analyzer	Keysight	N9010B	MY59071418	03/17/2021	1 year

Note: N.C.R. = No Calibration Request.

### 3.5. Test Site Environment

Items	Required (IEC 60068-1)	Actual
Temperature (°C)	15-35	20-30
Humidity (%RH)	25-75	45-75

## 4 Measurement Procedure

### 4.1. AC Power Line Conducted Emission Measurement

#### ■ Limit

Frequency (MHz)	Quasi-peak	Average
0.15 - 0.5	66 to 56	56 to 46
0.50 - 5.0	56	46
5.0 - 30.0	60	50

#### ■ Test Setup

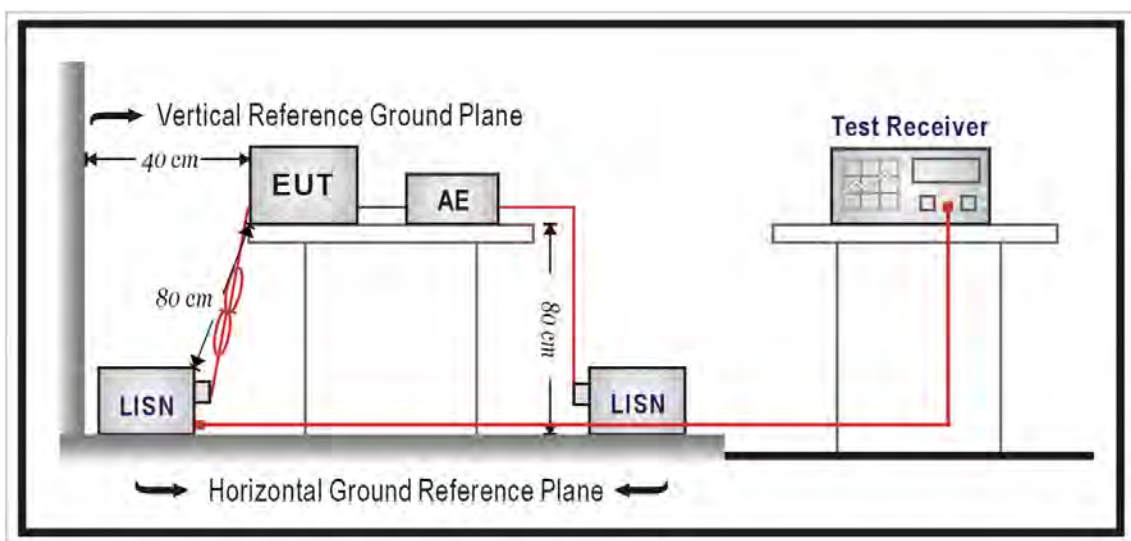

#### ■ Test Procedure

The EUT and simulators are connected to the main power through a line impedance stabilization network (L.I.S.N.). This provides a  $50 \Omega // 50 \mu\text{H}$  coupling impedance for the measuring equipment. The peripheral devices are also connected to the main power through a LISN that provides a  $50 \Omega // 50 \mu\text{H}$  coupling impedance with 50 ohm termination.

Tabletop device shall be placed on a non-conducting platform, of nominal size 1 m by 1.5 m, raised 80 cm above the reference ground plane. The wall of screened room shall be located 40 cm to the rear of the EUT. Other surfaces of tabletop or floor standing EUT shall be at least 80 cm from any other ground conducting surface including one or more LISNs. For floor-standing device shall be placed under the EUT with a 12 mm insulating material.

Conducted emissions were investigated over the frequency range from 0.15 MHz to 30 MHz using a resolution bandwidth of 9 kHz. The equipment under test (EUT) shall be meet the limits in section 4.1, as applicable, including the average limit and the quasi-peak limit when using respectively, an average detector and quasi-peak detector measured in accordance with the methods described of related standard. When all of peak value were complied with quasi-peak and average limit from 150 kHz to 30 MHz then quasi-peak and average measurement was unnecessary.

The AMN shall be placed 0.8 m from the boundary of the unit under test and bonded to a ground reference plane for AMNs mounted on top of the ground reference plane. This distance is between the closest points of the AMN and the EUT. All other units of the EUT and associated equipment shall be at least 0.8 m from the AMN. If the mains power cable is longer than 1 m then the cable shall be folded back and forth at the centre of the lead to form a bundle no longer than 0.4 m. All of interconnecting cables that hang closer than 40 cm to the ground plane shall be folded back and forth in the center forming a bundle 30 cm to 40 cm long. All of EUT and AE shall be separate place more than 0.1 m. All 50  $\Omega$  ports of the LISN shall be resistively terminated into 50  $\Omega$  loads when not connected to the measuring instrument.

If the reading of the measuring receiver shows fluctuations close to the limit, the reading shall be observed for at least 15 s at each measurement frequency; the higher reading shall be recorded with the exception of any brief isolated high reading which shall be ignored.

## 4.2. Radiated Emission Measurement

### ■ Limit

According to §15.209(a), except as provided elsewhere in this subpart, the emissions from an intentional radiator shall not exceed the field strength levels specified in the following table:

Frequency (MHz)	Field Strength ( $\mu\text{V}/\text{m}$ at meter)	Measurement Distance (meters)
0.009 – 0.490	$2400 / F$ (kHz)	300
0.490 – 1.705	$24000 / F$ (kHz)	30
1.705 – 30.0	30	30
30 - 88	100**	3
88-216	150**	3
216-960	200**	3
Above 960	500	3

\*\* Except as provided in paragraph (g), fundamental emissions from intentional radiators operating under this Section shall not be located in the frequency bands 54-72 MHz, 76-88 MHz, 174-216 MHz or 470-806 MHz. However, operation within these frequency bands is permitted under other sections of this Part, e.g., Sections 15.231 and 15.241.

### ■ Setup

9 kHz ~ 30 MHz

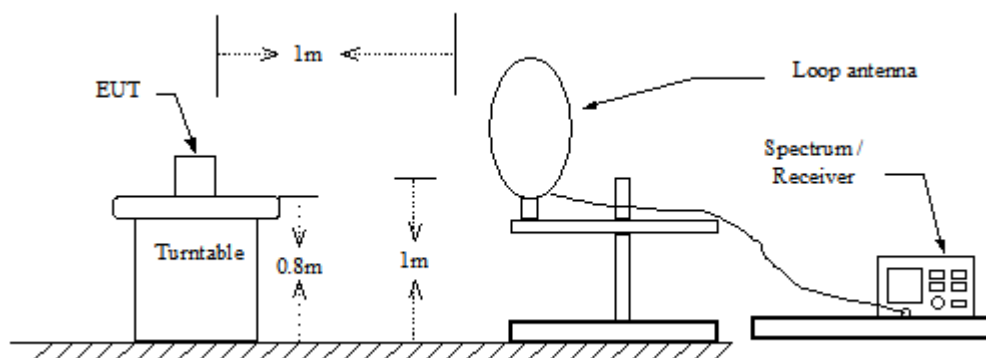

Below 1 GHz

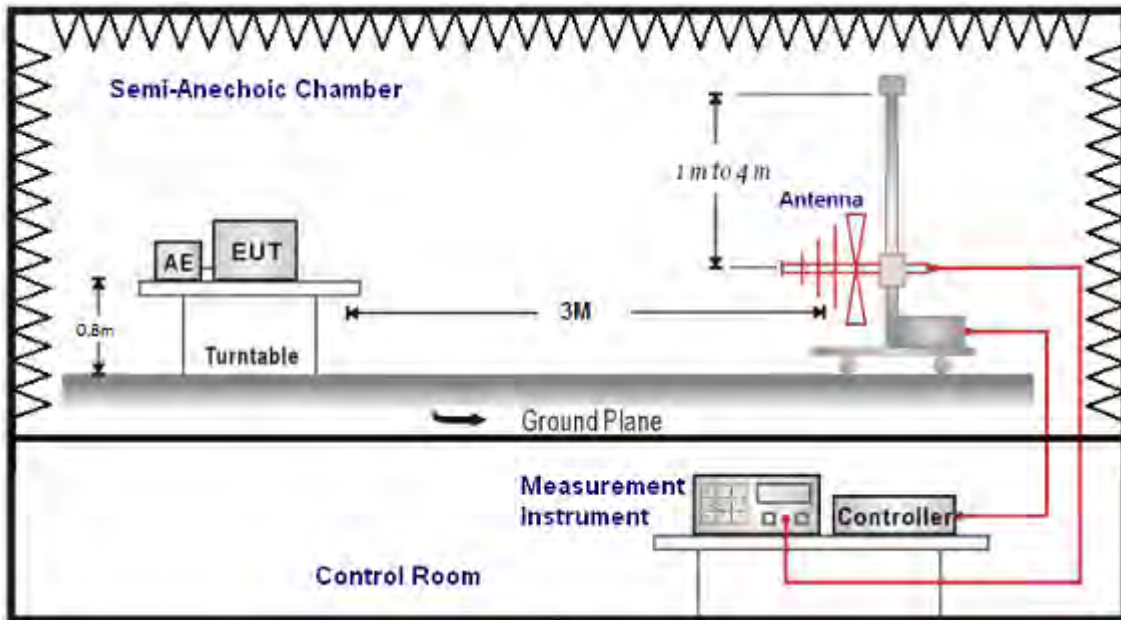

Above 1 GHz

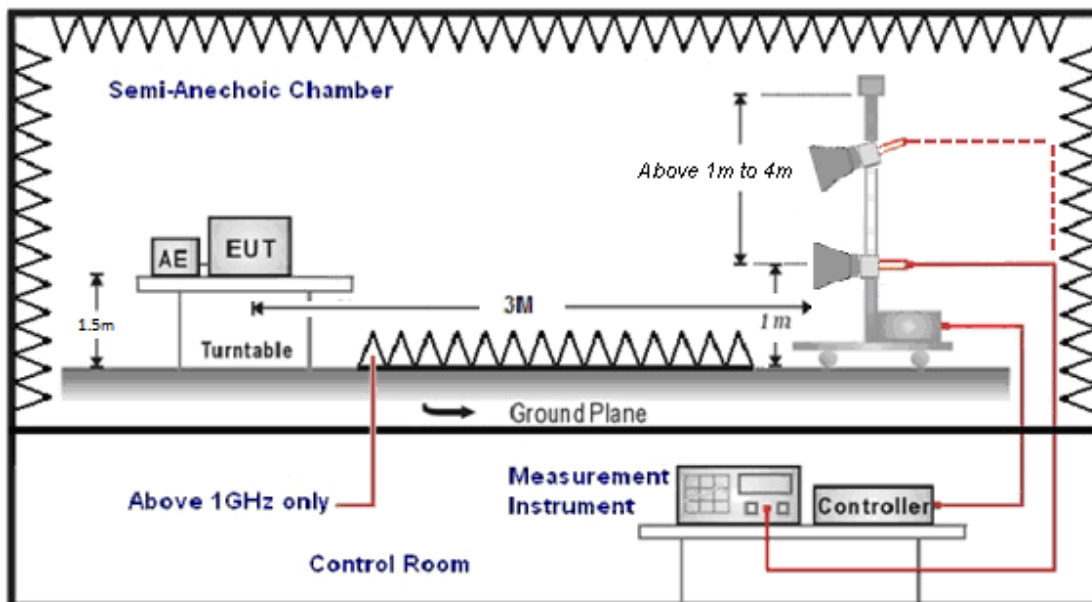

## ■ Test Procedure

Final radiation measurements were made on a three-meter, Semi Anechoic Chamber. The EUT system was placed on a nonconductive turntable which is 0.8 or 1.5 meters height, top surface 1.0 x 1.5 meter. The spectrum was examined from 250 MHz to 2.5 GHz in order to cover the whole spectrum below 10th harmonic which could generate from the EUT. During the test, EUT was set to transmit continuously & Measurements spectrum range from 9 kHz to 26.5 GHz is investigated.

For measurements below 1 GHz the resolution bandwidth is set to 100 kHz for peak detection measurements or 120 kHz for quasi-peak detection measurements. Peak detection is used unless otherwise noted as quasi-peak.

For measurements above 1 GHz the resolution bandwidth is set to 1 MHz, and then the video bandwidth is set to 3 MHz for peak measurements and 10 Hz for average measurements when Duty cycle  $>0.98$  /  $1/T$  for average measurements when Duty cycle  $<0.98$ . A nonconductive material surrounded the EUT to supporting the EUT for standing on three orthogonal planes. At each condition, the EUT was rotated 360 degrees, and the antenna was raised and lowered from one to four meters to find the maximum emission levels. Measurements were taken using both horizontal and vertical antenna polarization.

SCHWARZBECK MESS-ELEKTRONIK Biconilog Antenna at 3 Meter and the SCHWARZBECK Double Ridged Guide Antenna was used in frequencies 1 –26.5 GHz at a distance of 3 meter. The antenna at an angle toward the source of the emission. All test results were extrapolated to equivalent signal at 3 meters utilizing an inverse linear distance extrapolation Factor (20 dB/decade).

For testing above 1 GHz, the emission level of the EUT in peak mode was 20 dB lower than average limit (that means the emission level in peak mode also complies with the limit in average mode), then testing will be stopped and peak values of EUT will be reported, otherwise, the emissions will be measured in average mode again and reported.

Appropriate preamplifiers were used for improving sensitivity and precautions were taken to avoid overloading or desensitizing the spectrum analyzer. No post – detector video filters were used in the test.

The spectrum analyzer's 6 dB bandwidth was set to 1 MHz, and the analyzer was operated in the peak detection mode, for frequencies both below and up 1 GHz. The average levels were obtained by subtracting the duty cycle correction factor from the peak readings.

The following procedures were used to convert the emission levels measured in decibels referenced to 1 microvolt (dBuV) into field intensity in micro volts pre meter ( $\mu\text{V}/\text{m}$ ).

The actual field intensity in decibels referenced to 1 microvolt in to field intensity in micro volts per meter (dBuV/m).





The actual field intensity in referenced to 1 microvolt per meter (dBuV/m) is determined by algebraically adding the measured reading in dBuV, the antenna factor (dB), and cable loss (dB) and Subtracting the gain of preamplifier (dB) is auto calculate in spectrum analyzer.

$$(1) \text{ Amplitude (dBuV/m) = FI (dBuV) +AF (dBuV) +CL (dBuV)-Gain (dB)}$$

FI= Reading of the field intensity.

AF= Antenna factor.

CL= Cable loss.

P.S Amplitude is auto calculate in spectrum analyzer.

$$(2) \text{ Actual Amplitude (dBuV/m) = Amplitude (dBuV)-Dis(dB)}$$

The FCC specified emission limits were calculated according the EUT operating frequency and by following linear interpolation equations:

(a) For fundamental frequency : Transmitter Output < +30 dBm

(b) For spurious frequency : Spurious emission limits = fundamental emission limit /10

Data of measurement within this frequency range without mark in the table above means the reading of emissions are attenuated more than 20 dB below the permissible limits or the field strength is too small to be measured.

### 4.3. Maximum Conducted Output Power Measurement

#### ■ Limit

For systems using digital modulation in the 2400-2483.5 MHz, the limit for peak output power is 30 dBm.

#### ■ Test Setup

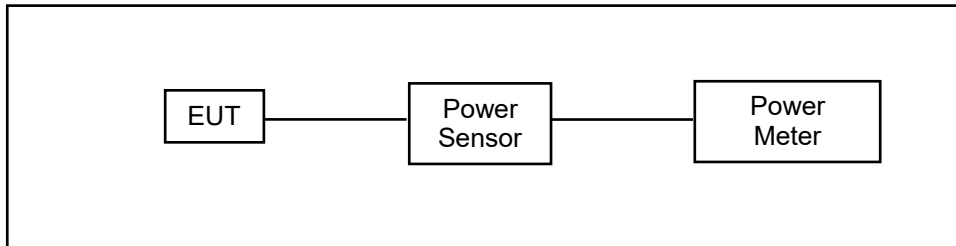

#### ■ Test Procedure

The testing follows the Measurement Procedure of ANSI C63.10:2013 section 11.9.2.3.2 Method AVGPM.

The tests below are run with the EUT's transmitter set at high power in TX mode. The EUT is needed to force selection of output power level and channel number. While testing, EUT was set to transmit continuously. Remove the Subjective device's antenna and connect the RF output port to power sensor..

#### 4.4. 6 dB RF Bandwidth Measurement

■ **Limit**

6 dB RF Bandwidth: Systems using digital modulation techniques may operate in the 2400–2483.5 MHz bands. The minimum 6 dB band-width shall be at least 500 kHz.

99 % Occupied Bandwidth: N/A

■ **Test Setup**

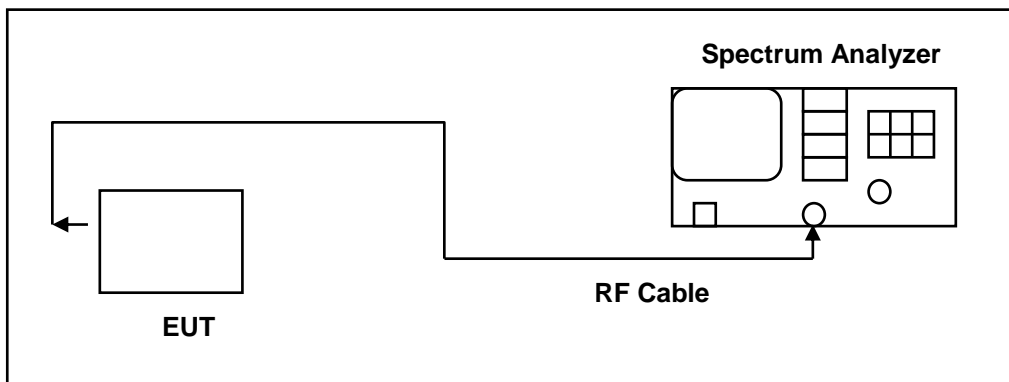

■ **Test Procedure**

The EUT tested to DTS test procedure of ANSI C63.10-2013 section 11.8.2 option2 for compliance to FCC 47CFR 15.247 requirements.

6 dB RF Bandwidth: The antenna port of the EUT was connected to the input of a spectrum analyzer. Analyzer RBW was set to 100 kHz. For each RF output channel investigated, the spectrum analyzer center frequency was set to the channel carrier. A peak output reading was taken, a DISPLAY line was drawn 6 dB lower than peak level. The 6 dB bandwidth was determined from where the channel output spectrum intersected the display line.

The test was performed at 3 channels (Channel low, middle, high)

## 4.5. Maximum Power Density Measurement

### ■ Limit

For digitally modulated systems, the power spectral density conducted from the intentional radiator to the antenna shall not be greater than 8 dBm in any 3 kHz band during any time interval of continuous transmission.

### ■ Test Setup

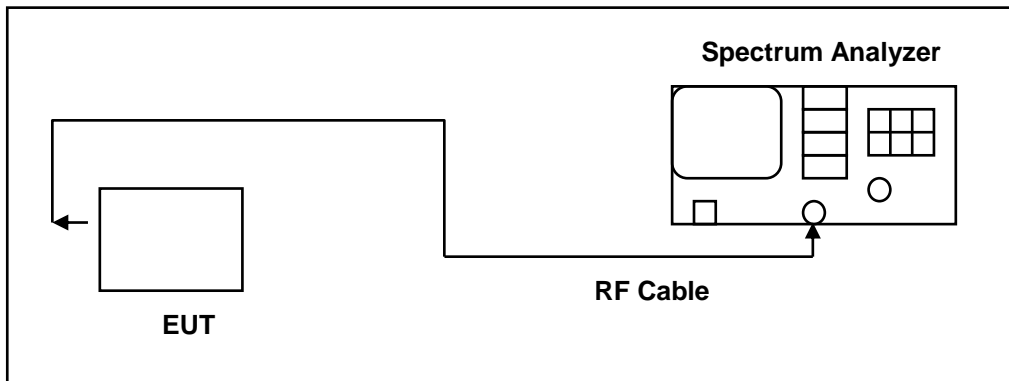

### ■ Test Procedure

The EUT tested to DTS test procedure of ANSI C63.10:2013 section 11.10.2 Method PKPSD.

1. Set analyzer center frequency to DTS channel center frequency.
2. Set the span to 1.5 times the DTS bandwidth.
3. Set the RBW to:  $3 \text{ kHz} \leq \text{RBW} \leq 100 \text{ kHz}$ .
4. Set the VBW  $\geq 3 \times \text{RBW}$ .
5. Detector = peak.
6. Sweep time = auto couple.
7. Trace mode = max hold.
8. Allow trace to fully stabilize.
9. Use the peak marker function to determine the maximum amplitude level within the RBW.
10. If measured value exceeds limit, reduce RBW (no less than 3 kHz) and repeat.

## 4.6. Out of Band Conducted Emissions Measurement

### ■ Limit

In any 100 kHz bandwidth outside the frequency band in which the spread spectrum or digitally modulated intentional radiator is operating, the radio frequency power that is produced by the intentional radiator shall be at least 20 dB below that in the 100 kHz bandwidth within the band that contains the highest level of the desired power

### ■ Test Setup

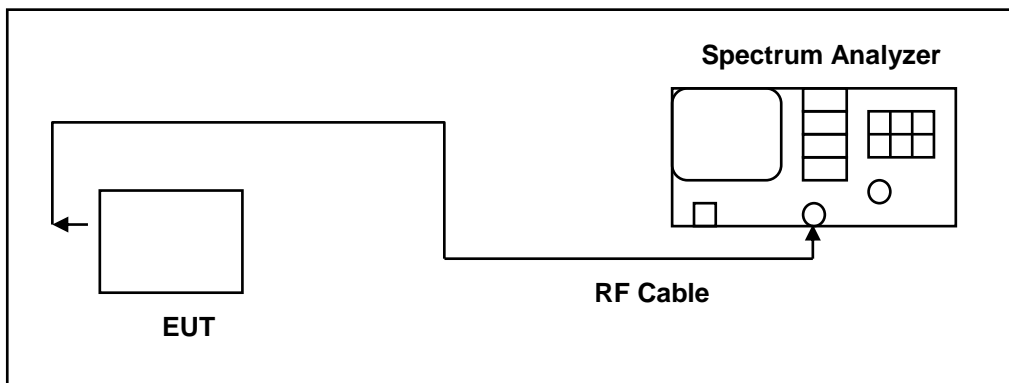

### ■ Test Procedure

In any 100 kHz bandwidth outside the EUT pass band, the RF power produced by the modulation products of the spreading sequence, the information sequence, and the carrier frequency shall be at least 20 dB below that of the maximum in-band 100 kHz emission, antenna output of the EUT was coupled directly to spectrum analyzer; if an external attenuator and/or cable was used, these losses are compensated for with the analyzer OFFSET function.

All other types of emissions from the EUT shall meet the general limits for radiated frequencies outside the pass band. The test was performed at 3 channels.

## 4.7. Antenna Measurement

### ■ Limit

For intentional device, according to 15.203, an intentional radiator shall be designed to ensure that no antenna other than that furnished by the responsible party shall be used with the device.

And According to 15.247 (b), if transmitting antennas of directional gain greater than 6 dBi are used, the power shall be reduced by the amount in dB that the directional gain of the antenna exceeds 6 dBi.

### ■ Antenna Connector Construction

See section 2 – antenna information.

## 5 Test Results

### Annex A. Conducted Emission

Standard:	FCC Part 15.247	Line:	L1
Test item:	Conducted Emission	Power:	AC 120 V/60 Hz
Mode:	Mode 1		
Description:			

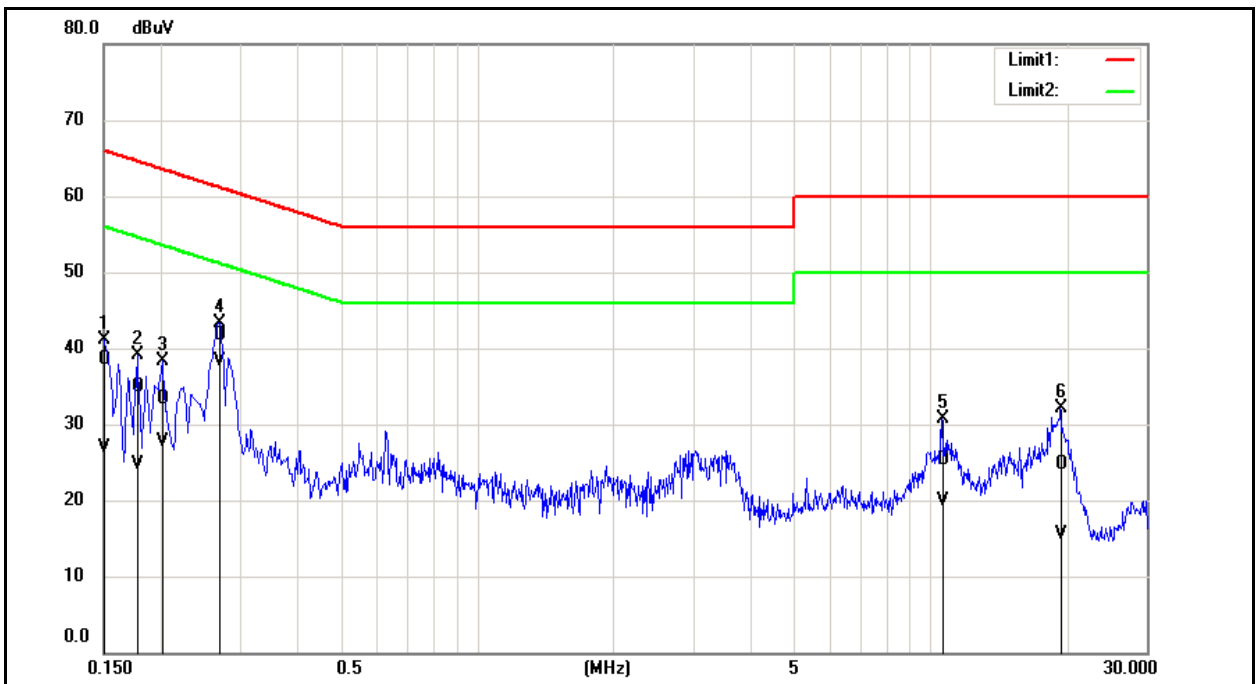

No.	Frequency (MHz)	QP reading (dBuV)	AVG reading (dBuV)	Correction factor (dB)	QP result (dBuV)	AVG result (dBuV)	QP limit (dBuV)	AVG limit (dBuV)	QP margin (dB)	AVG margin (dB)	Remark
1	0.1500	28.79	17.08	9.74	38.53	26.82	66.00	56.00	-27.47	-29.18	Pass
2	0.1780	25.13	15.05	9.74	34.87	24.79	64.58	54.58	-29.71	-29.79	Pass
3	0.2020	23.47	17.90	9.74	33.21	27.64	63.53	53.53	-30.32	-25.89	Pass
4	0.2700	32.01	28.54	9.74	41.75	38.28	61.12	51.12	-19.37	-12.84	Pass
5	10.5780	15.28	10.00	9.98	25.26	19.98	60.00	50.00	-34.74	-30.02	Pass
6	19.3660	14.65	5.44	10.05	24.70	15.49	60.00	50.00	-35.30	-34.51	Pass

Note: 1. Result (dBuV) = Correction factor (dB) + Reading(dBuV).

2. Correction factor (dB) = Cable loss (dB) + L.I.S.N. factor (dB).



Standard:	FCC Part 15.247	Line:	N
Test item:	Conducted Emission	Power:	AC 120 V/60 Hz
Mode:	Mode 1		
Description:			

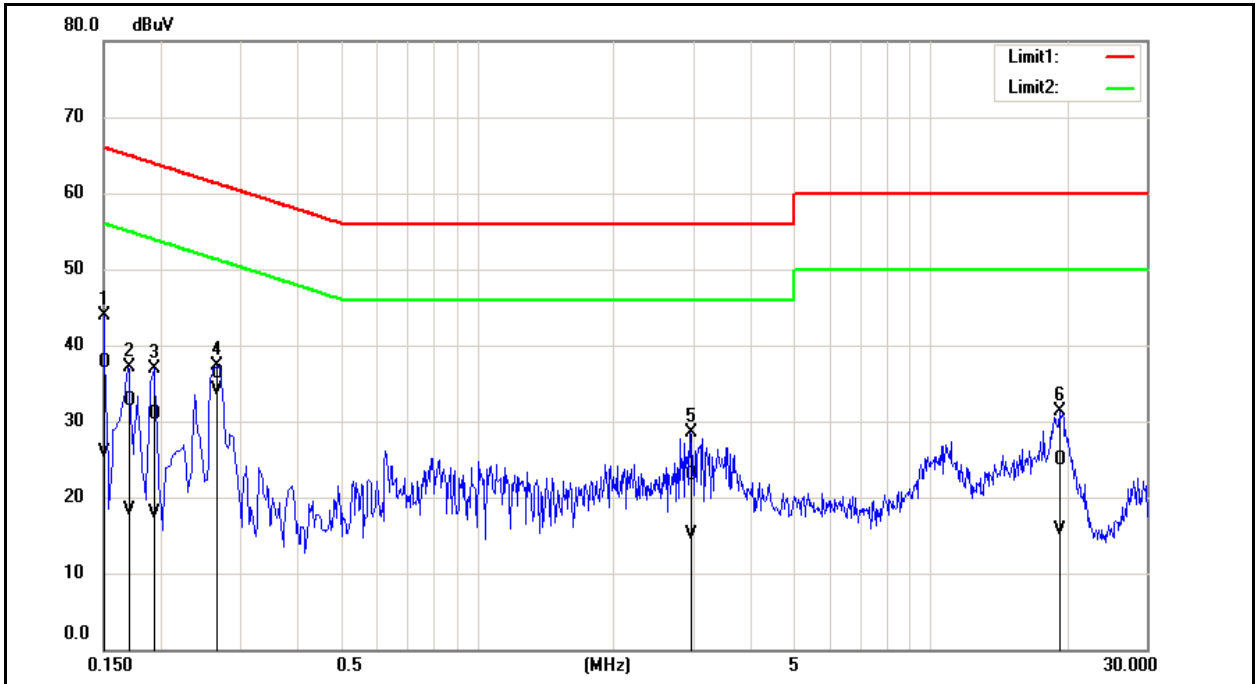

No.	Frequency (MHz)	QP reading (dBuV)	AVG reading (dBuV)	Correction factor (dB)	QP result (dBuV)	AVG result (dBuV)	QP limit (dBuV)	AVG limit (dBuV)	QP margin (dB)	AVG margin (dB)	Remark
1	0.1500	27.95	16.07	9.74	37.69	25.81	66.00	56.00	-28.31	-30.19	Pass
2	0.1700	23.00	8.53	9.74	32.74	18.27	64.96	54.96	-32.22	-36.69	Pass
3	0.1940	21.08	8.10	9.73	30.81	17.83	63.86	53.86	-33.05	-36.03	Pass
4	0.2660	26.63	24.37	9.73	36.36	34.10	61.24	51.24	-24.88	-17.14	Pass
5	2.9580	13.08	5.18	9.83	22.91	15.01	56.00	46.00	-33.09	-30.99	Pass
6	19.2900	14.69	5.46	10.18	24.87	15.64	60.00	50.00	-35.13	-34.36	Pass

Note: 1. Result (dBuV) = Correction factor (dB) + Reading(dBuV).  
2. Correction factor (dB) = Cable loss (dB) + L.I.S.N. factor (dB).



## Annex B. Conducted Test Results

### Maximum Conducted Output Power Measurement

Test Mode	Frequency (MHz)	RF Power setting in Test Software	Test Software Version
Mode 2	2402	Default	Ampak RFTestTool ver:7.1
	2440	Default	
	2480	Default	
Mode 3	2402	Default	
	2440	Default	
	2480	Default	

Test Mode	Mode 2: LE, GFSK Continuous TX Mode				
Frequency (MHz)	Average Power		Peak Power		Limit (dBm)
	(dBm)	(W)	(dBm)	(W)	
2402	7.02	0.00504	7.51	0.00564	≤ 30
2440	7.46	0.00557	7.71	0.00590	≤ 30
2480	7.68	0.00586	<b>7.90</b>	<b>0.00617</b>	≤ 30

Test Mode	Mode 3: 2LE, GFSK Continuous TX Mode				
Frequency (MHz)	Average Power		Peak Power		Limit (dBm)
	(dBm)	(W)	(dBm)	(W)	
2402	6.77	0.00475	7.89	0.00615	≤ 30
2440	7.20	0.00525	8.19	0.00659	≤ 30
2480	7.43	0.00553	<b>8.39</b>	<b>0.00690</b>	≤ 30

Test Mode	Mode 4: BLR C2, GFSK Continuous TX Mode				
Frequency (MHz)	Average Power		Peak Power		Limit (dBm)
	(dBm)	(W)	(dBm)	(W)	
2402	6.67	0.00465	7.20	0.00525	≤ 30
2440	7.11	0.00514	7.39	0.00548	≤ 30
2480	7.32	0.00540	<b>7.58</b>	<b>0.00573</b>	≤ 30

Test Mode	Mode 5: BLR C8, GFSK Continuous TX Mode				
Frequency (MHz)	Average Power		Peak Power		Limit (dBm)
	(dBm)	(W)	(dBm)	(W)	
2402	6.69	0.00467	7.19	0.00524	≤ 30
2440	7.11	0.00514	7.37	0.00546	≤ 30
2480	7.31	0.00538	<b>7.55</b>	<b>0.00569</b>	≤ 30

Note: The relevant measured result has the offset with cable loss already.





**6 dB RF Bandwidth Measurement**

Test Mode	Mode 2: LE, GFSK Continuous TX Mode	
Frequency (MHz)	Measurement Results (kHz)	Limit (kHz)
2402	715.300	≥ 500
2440	694.700	≥ 500
2480	696.000	≥ 500

Test Mode	Mode 3: 2LE, GFSK Continuous TX Mode	
Frequency (MHz)	Measurement Results (kHz)	Limit (kHz)
2402	1256.000	≥ 500
2440	1236.000	≥ 500
2480	1229.000	≥ 500

■ Test Graphs

Mode 2: LE, GFSK Continuous TX Mode													
2402 MHz	<p>Center 2.402000 GHz #Res BW 100.00 kHz #Video BW 300.00 kHz Span 3 MHz Sweep 1.00 ms (1001 pts)</p> <p>2 Metrics</p> <table border="1"> <tr> <td>Occupied Bandwidth</td> <td>1.0877 MHz</td> <td>Total Power</td> <td>14.1 dBm</td> </tr> <tr> <td>Transmit Freq Error</td> <td>-9.951 kHz</td> <td>% of OBW Power</td> <td>99.00 %</td> </tr> <tr> <td>x dB Bandwidth</td> <td>715.3 kHz</td> <td>x dB</td> <td>-6.00 dB</td> </tr> </table>	Occupied Bandwidth	1.0877 MHz	Total Power	14.1 dBm	Transmit Freq Error	-9.951 kHz	% of OBW Power	99.00 %	x dB Bandwidth	715.3 kHz	x dB	-6.00 dB
Occupied Bandwidth	1.0877 MHz	Total Power	14.1 dBm										
Transmit Freq Error	-9.951 kHz	% of OBW Power	99.00 %										
x dB Bandwidth	715.3 kHz	x dB	-6.00 dB										
2440 MHz	<p>Center 2.440000 GHz #Res BW 100.00 kHz #Video BW 300.00 kHz Span 3 MHz Sweep 1.00 ms (1001 pts)</p> <p>2 Metrics</p> <table border="1"> <tr> <td>Occupied Bandwidth</td> <td>1.0872 MHz</td> <td>Total Power</td> <td>14.6 dBm</td> </tr> <tr> <td>Transmit Freq Error</td> <td>-17.166 kHz</td> <td>% of OBW Power</td> <td>99.00 %</td> </tr> <tr> <td>x dB Bandwidth</td> <td>694.7 kHz</td> <td>x dB</td> <td>-6.00 dB</td> </tr> </table>	Occupied Bandwidth	1.0872 MHz	Total Power	14.6 dBm	Transmit Freq Error	-17.166 kHz	% of OBW Power	99.00 %	x dB Bandwidth	694.7 kHz	x dB	-6.00 dB
Occupied Bandwidth	1.0872 MHz	Total Power	14.6 dBm										
Transmit Freq Error	-17.166 kHz	% of OBW Power	99.00 %										
x dB Bandwidth	694.7 kHz	x dB	-6.00 dB										
2480 MHz	<p>Center 2.480000 GHz #Res BW 100.00 kHz #Video BW 300.00 kHz Span 3 MHz Sweep 1.00 ms (1001 pts)</p> <p>2 Metrics</p> <table border="1"> <tr> <td>Occupied Bandwidth</td> <td>1.0838 MHz</td> <td>Total Power</td> <td>14.8 dBm</td> </tr> <tr> <td>Transmit Freq Error</td> <td>-24.256 kHz</td> <td>% of OBW Power</td> <td>99.00 %</td> </tr> <tr> <td>x dB Bandwidth</td> <td>686.0 kHz</td> <td>x dB</td> <td>-6.00 dB</td> </tr> </table>	Occupied Bandwidth	1.0838 MHz	Total Power	14.8 dBm	Transmit Freq Error	-24.256 kHz	% of OBW Power	99.00 %	x dB Bandwidth	686.0 kHz	x dB	-6.00 dB
Occupied Bandwidth	1.0838 MHz	Total Power	14.8 dBm										
Transmit Freq Error	-24.256 kHz	% of OBW Power	99.00 %										
x dB Bandwidth	686.0 kHz	x dB	-6.00 dB										



Mode 3: 2LE, GFSK Continuous TX Mode	
2402 MHz	<p>Center Frequency: 2.4020000 GHz Span: 3.0000 MHz CF Step: 300.000 kHz Freq Offset: 0 Hz</p> <p>Occupied Bandwidth: 2.0644 MHz Total Power: 14.4 dBm Transmit Freq Error: 1.336 kHz % of OBW Power: 99.00 % x dB Bandwidth: 1.256 MHz x dB: -6.00 dB</p>
2440 MHz	<p>Center Frequency: 2.4400000 GHz Span: 3.0000 MHz CF Step: 300.000 kHz Freq Offset: 0 Hz</p> <p>Occupied Bandwidth: 2.0591 MHz Total Power: 14.9 dBm Transmit Freq Error: -5.358 kHz % of OBW Power: 99.00 % x dB Bandwidth: 1.236 MHz x dB: -6.00 dB</p>
2480 MHz	<p>Center Frequency: 2.4800000 GHz Span: 3.0000 MHz CF Step: 300.000 kHz Freq Offset: 0 Hz</p> <p>Occupied Bandwidth: 2.0577 MHz Total Power: 15.2 dBm Transmit Freq Error: -12.993 kHz % of OBW Power: 99.00 % x dB Bandwidth: 1.229 MHz x dB: -6.00 dB</p>



### Maximum Power Density Measurement

Test Mode	Mode 2: LE, GFSK Continuous TX Mode	
Frequency (MHz)	Measurement Results (dBm/ 3 kHz)	Limit (dBm)
2402	-7.560	$\leq 8$
2440	-7.310	$\leq 8$
2480	-6.860	$\leq 8$

Test Mode	Mode 3: 2LE, GFSK Continuous TX Mode	
Frequency (MHz)	Measurement Results (dBm/ 3 kHz)	Limit (dBm)
2402	-9.880	$\leq 8$
2440	-9.590	$\leq 8$
2480	-9.240	$\leq 8$

■ Test Graphs

Mode 2: LE, GFSK Continuous TX Mode	
2402 MHz	
2440 MHz	
2480 MHz	

Mode 3: 2LE, GFSK Continuous TX Mode	
2402 MHz	
2440 MHz	
2480 MHz	

### Out of Band Conducted Emissions Measurement

#### ■ Test Graphs

##### Reference level

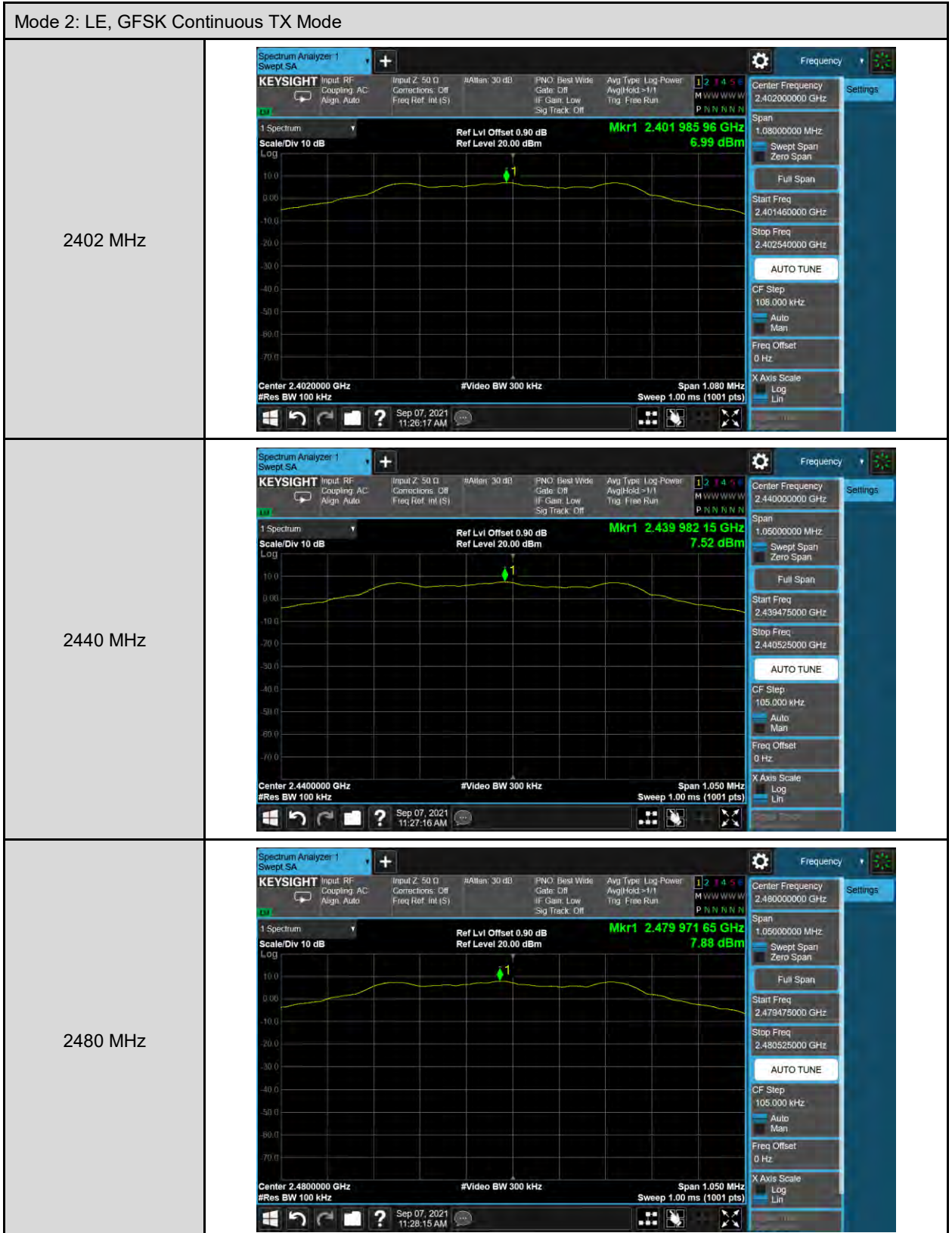

Mode 3: 2LE, GFSK Continuous TX Mode	
2402 MHz	
2440 MHz	
2480 MHz	



**Out of Band Conducted Emissions**

Mode 2: LE, GFSK Continuous TX Mode																																																									
2402 MHz	<table border="1"> <thead> <tr> <th>Mode</th> <th>Trace</th> <th>Scale</th> <th>X</th> <th>Y</th> <th>Function</th> <th>Function Width</th> <th>Function Value</th> </tr> </thead> <tbody> <tr> <td>1</td> <td>N</td> <td>f</td> <td>2.4017 GHz</td> <td>5.622 dBm</td> <td></td> <td></td> <td></td> </tr> <tr> <td>2</td> <td>N</td> <td>f</td> <td>26.0328 GHz</td> <td>-37.34 dBm</td> <td></td> <td></td> <td></td> </tr> <tr> <td>3</td> <td></td> <td></td> <td></td> <td></td> <td></td> <td></td> <td></td> </tr> <tr> <td>4</td> <td></td> <td></td> <td></td> <td></td> <td></td> <td></td> <td></td> </tr> <tr> <td>5</td> <td></td> <td></td> <td></td> <td></td> <td></td> <td></td> <td></td> </tr> <tr> <td>6</td> <td></td> <td></td> <td></td> <td></td> <td></td> <td></td> <td></td> </tr> </tbody> </table>	Mode	Trace	Scale	X	Y	Function	Function Width	Function Value	1	N	f	2.4017 GHz	5.622 dBm				2	N	f	26.0328 GHz	-37.34 dBm				3								4								5								6							
Mode	Trace	Scale	X	Y	Function	Function Width	Function Value																																																		
1	N	f	2.4017 GHz	5.622 dBm																																																					
2	N	f	26.0328 GHz	-37.34 dBm																																																					
3																																																									
4																																																									
5																																																									
6																																																									
2440 MHz	<table border="1"> <thead> <tr> <th>Mode</th> <th>Trace</th> <th>Scale</th> <th>X</th> <th>Y</th> <th>Function</th> <th>Function Width</th> <th>Function Value</th> </tr> </thead> <tbody> <tr> <td>1</td> <td>N</td> <td>f</td> <td>2.4401 GHz</td> <td>6.951 dBm</td> <td></td> <td></td> <td></td> </tr> <tr> <td>2</td> <td>N</td> <td>f</td> <td>26.0977 GHz</td> <td>-38.71 dBm</td> <td></td> <td></td> <td></td> </tr> <tr> <td>3</td> <td></td> <td></td> <td></td> <td></td> <td></td> <td></td> <td></td> </tr> <tr> <td>4</td> <td></td> <td></td> <td></td> <td></td> <td></td> <td></td> <td></td> </tr> <tr> <td>5</td> <td></td> <td></td> <td></td> <td></td> <td></td> <td></td> <td></td> </tr> <tr> <td>6</td> <td></td> <td></td> <td></td> <td></td> <td></td> <td></td> <td></td> </tr> </tbody> </table>	Mode	Trace	Scale	X	Y	Function	Function Width	Function Value	1	N	f	2.4401 GHz	6.951 dBm				2	N	f	26.0977 GHz	-38.71 dBm				3								4								5								6							
Mode	Trace	Scale	X	Y	Function	Function Width	Function Value																																																		
1	N	f	2.4401 GHz	6.951 dBm																																																					
2	N	f	26.0977 GHz	-38.71 dBm																																																					
3																																																									
4																																																									
5																																																									
6																																																									
2480 MHz	<table border="1"> <thead> <tr> <th>Mode</th> <th>Trace</th> <th>Scale</th> <th>X</th> <th>Y</th> <th>Function</th> <th>Function Width</th> <th>Function Value</th> </tr> </thead> <tbody> <tr> <td>1</td> <td>N</td> <td>f</td> <td>2.4805 GHz</td> <td>7.661 dBm</td> <td></td> <td></td> <td></td> </tr> <tr> <td>2</td> <td>N</td> <td>f</td> <td>25.9924 GHz</td> <td>-38.78 dBm</td> <td></td> <td></td> <td></td> </tr> <tr> <td>3</td> <td></td> <td></td> <td></td> <td></td> <td></td> <td></td> <td></td> </tr> <tr> <td>4</td> <td></td> <td></td> <td></td> <td></td> <td></td> <td></td> <td></td> </tr> <tr> <td>5</td> <td></td> <td></td> <td></td> <td></td> <td></td> <td></td> <td></td> </tr> <tr> <td>6</td> <td></td> <td></td> <td></td> <td></td> <td></td> <td></td> <td></td> </tr> </tbody> </table>	Mode	Trace	Scale	X	Y	Function	Function Width	Function Value	1	N	f	2.4805 GHz	7.661 dBm				2	N	f	25.9924 GHz	-38.78 dBm				3								4								5								6							
Mode	Trace	Scale	X	Y	Function	Function Width	Function Value																																																		
1	N	f	2.4805 GHz	7.661 dBm																																																					
2	N	f	25.9924 GHz	-38.78 dBm																																																					
3																																																									
4																																																									
5																																																									
6																																																									

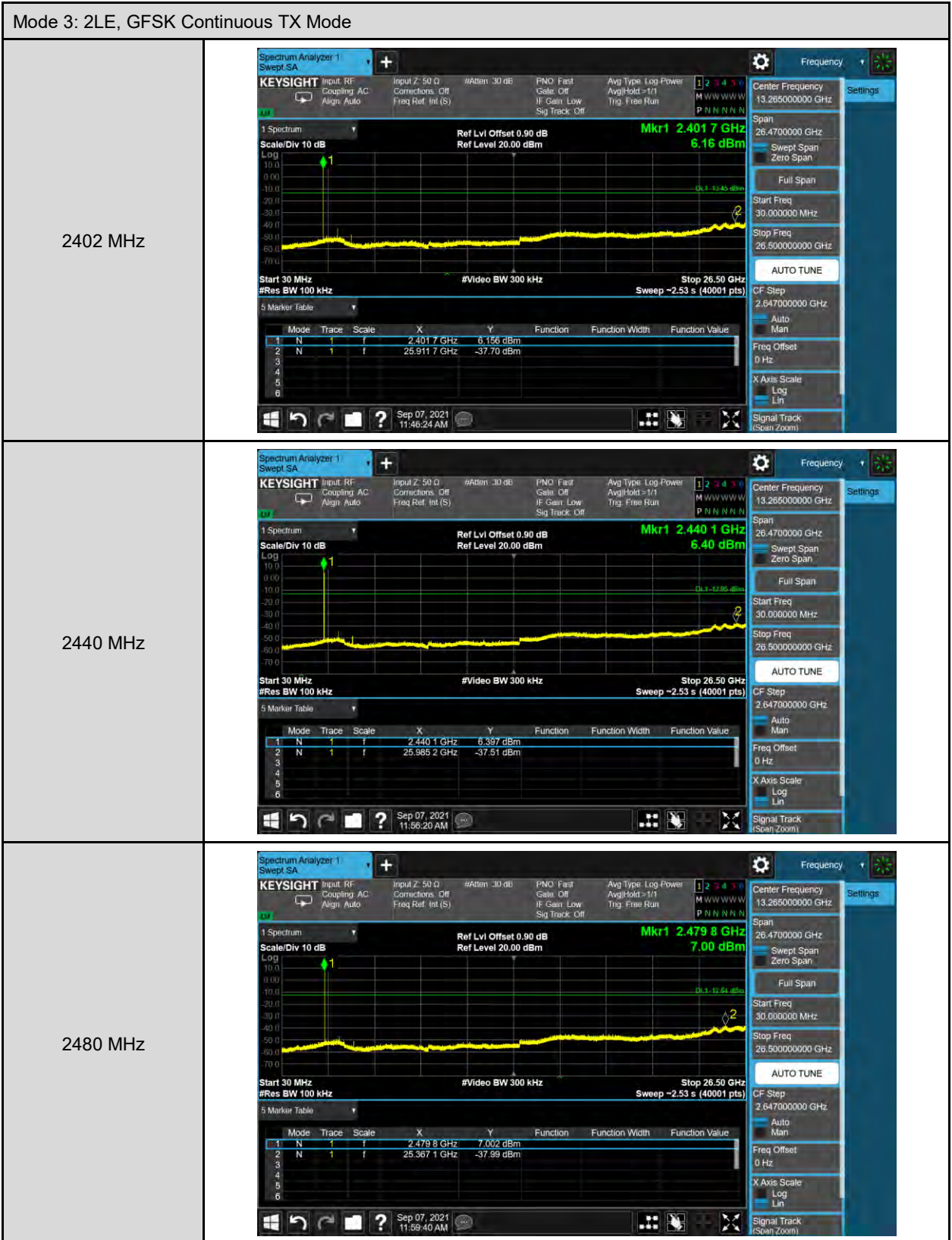

**Conducted Band Edge**

Mode 2: LE, GFSK Continuous TX Mode																																																									
2402 MHz	<table border="1"> <thead> <tr> <th>Mode</th> <th>Trace</th> <th>Scale</th> <th>X</th> <th>Y</th> <th>Function</th> <th>Function Width</th> <th>Function Value</th> </tr> </thead> <tbody> <tr> <td>1</td> <td>N</td> <td>1</td> <td>f</td> <td>2.402 242 0 GHz</td> <td></td> <td></td> <td>6.84 dBm</td> </tr> <tr> <td>2</td> <td>N</td> <td>1</td> <td>f</td> <td>2.400 000 0 GHz</td> <td></td> <td></td> <td>-55.76 dBm</td> </tr> <tr> <td>3</td> <td></td> <td></td> <td></td> <td></td> <td></td> <td></td> <td></td> </tr> <tr> <td>4</td> <td></td> <td></td> <td></td> <td></td> <td></td> <td></td> <td></td> </tr> <tr> <td>5</td> <td></td> <td></td> <td></td> <td></td> <td></td> <td></td> <td></td> </tr> <tr> <td>6</td> <td></td> <td></td> <td></td> <td></td> <td></td> <td></td> <td></td> </tr> </tbody> </table>	Mode	Trace	Scale	X	Y	Function	Function Width	Function Value	1	N	1	f	2.402 242 0 GHz			6.84 dBm	2	N	1	f	2.400 000 0 GHz			-55.76 dBm	3								4								5								6							
Mode	Trace	Scale	X	Y	Function	Function Width	Function Value																																																		
1	N	1	f	2.402 242 0 GHz			6.84 dBm																																																		
2	N	1	f	2.400 000 0 GHz			-55.76 dBm																																																		
3																																																									
4																																																									
5																																																									
6																																																									
2480 MHz	<table border="1"> <thead> <tr> <th>Mode</th> <th>Trace</th> <th>Scale</th> <th>X</th> <th>Y</th> <th>Function</th> <th>Function Width</th> <th>Function Value</th> </tr> </thead> <tbody> <tr> <td>1</td> <td>N</td> <td>1</td> <td>f</td> <td>2.479 975 5 GHz</td> <td></td> <td></td> <td>7.80 dBm</td> </tr> <tr> <td>2</td> <td>N</td> <td>1</td> <td>f</td> <td>2.483 500 0 GHz</td> <td></td> <td></td> <td>-56.71 dBm</td> </tr> <tr> <td>3</td> <td>N</td> <td>1</td> <td>f</td> <td>2.487 446 5 GHz</td> <td></td> <td></td> <td>-54.85 dBm</td> </tr> <tr> <td>4</td> <td></td> <td></td> <td></td> <td></td> <td></td> <td></td> <td></td> </tr> <tr> <td>5</td> <td></td> <td></td> <td></td> <td></td> <td></td> <td></td> <td></td> </tr> <tr> <td>6</td> <td></td> <td></td> <td></td> <td></td> <td></td> <td></td> <td></td> </tr> </tbody> </table>	Mode	Trace	Scale	X	Y	Function	Function Width	Function Value	1	N	1	f	2.479 975 5 GHz			7.80 dBm	2	N	1	f	2.483 500 0 GHz			-56.71 dBm	3	N	1	f	2.487 446 5 GHz			-54.85 dBm	4								5								6							
Mode	Trace	Scale	X	Y	Function	Function Width	Function Value																																																		
1	N	1	f	2.479 975 5 GHz			7.80 dBm																																																		
2	N	1	f	2.483 500 0 GHz			-56.71 dBm																																																		
3	N	1	f	2.487 446 5 GHz			-54.85 dBm																																																		
4																																																									
5																																																									
6																																																									

Mode 3: 2LE, GFSK Continuous TX Mode																																	
2402 MHz	<p>Center Frequency: 2.40200000 GHz Span: 20.0000000 MHz Start Freq: 2.392000000 GHz Stop Freq: 2.412000000 GHz Center Freq: 2.4019910 GHz Mkr1: 2.4019910 GHz 6.42 dBm</p> <table border="1"> <thead> <tr> <th>Mode</th> <th>Trace</th> <th>Scale</th> <th>X</th> <th>Y</th> <th>Function</th> <th>Function Width</th> <th>Function Value</th> </tr> </thead> <tbody> <tr> <td>1</td> <td>N</td> <td>1</td> <td>f</td> <td>2.4019910 GHz</td> <td></td> <td></td> <td>6.415 dBm</td> </tr> <tr> <td>2</td> <td>N</td> <td>1</td> <td>f</td> <td>2.4000000 GHz</td> <td></td> <td></td> <td>-37.32 dBm</td> </tr> </tbody> </table>	Mode	Trace	Scale	X	Y	Function	Function Width	Function Value	1	N	1	f	2.4019910 GHz			6.415 dBm	2	N	1	f	2.4000000 GHz			-37.32 dBm								
Mode	Trace	Scale	X	Y	Function	Function Width	Function Value																										
1	N	1	f	2.4019910 GHz			6.415 dBm																										
2	N	1	f	2.4000000 GHz			-37.32 dBm																										
2480 MHz	<p>Center Frequency: 2.48000000 GHz Span: 20.0000000 MHz Start Freq: 2.470000000 GHz Stop Freq: 2.490000000 GHz Center Freq: 2.4799690 GHz Mkr1: 2.4799690 GHz 7.30 dBm</p> <table border="1"> <thead> <tr> <th>Mode</th> <th>Trace</th> <th>Scale</th> <th>X</th> <th>Y</th> <th>Function</th> <th>Function Width</th> <th>Function Value</th> </tr> </thead> <tbody> <tr> <td>1</td> <td>N</td> <td>1</td> <td>f</td> <td>2.4799690 GHz</td> <td></td> <td></td> <td>7.297 dBm</td> </tr> <tr> <td>2</td> <td>N</td> <td>1</td> <td>f</td> <td>2.4835000 GHz</td> <td></td> <td></td> <td>-57.40 dBm</td> </tr> <tr> <td>3</td> <td>N</td> <td>1</td> <td>f</td> <td>2.4863460 GHz</td> <td></td> <td></td> <td>-54.91 dBm</td> </tr> </tbody> </table>	Mode	Trace	Scale	X	Y	Function	Function Width	Function Value	1	N	1	f	2.4799690 GHz			7.297 dBm	2	N	1	f	2.4835000 GHz			-57.40 dBm	3	N	1	f	2.4863460 GHz			-54.91 dBm
Mode	Trace	Scale	X	Y	Function	Function Width	Function Value																										
1	N	1	f	2.4799690 GHz			7.297 dBm																										
2	N	1	f	2.4835000 GHz			-57.40 dBm																										
3	N	1	f	2.4863460 GHz			-54.91 dBm																										

## Annex C. Radiated Emission Measurement

Below 1 GHz

Standard:	FCC Part 15.247	Test Distance:	3 m
Frequency:	2402 MHz		
Mode:	Mode 2		
Ant.Polar.:	Horizontal		

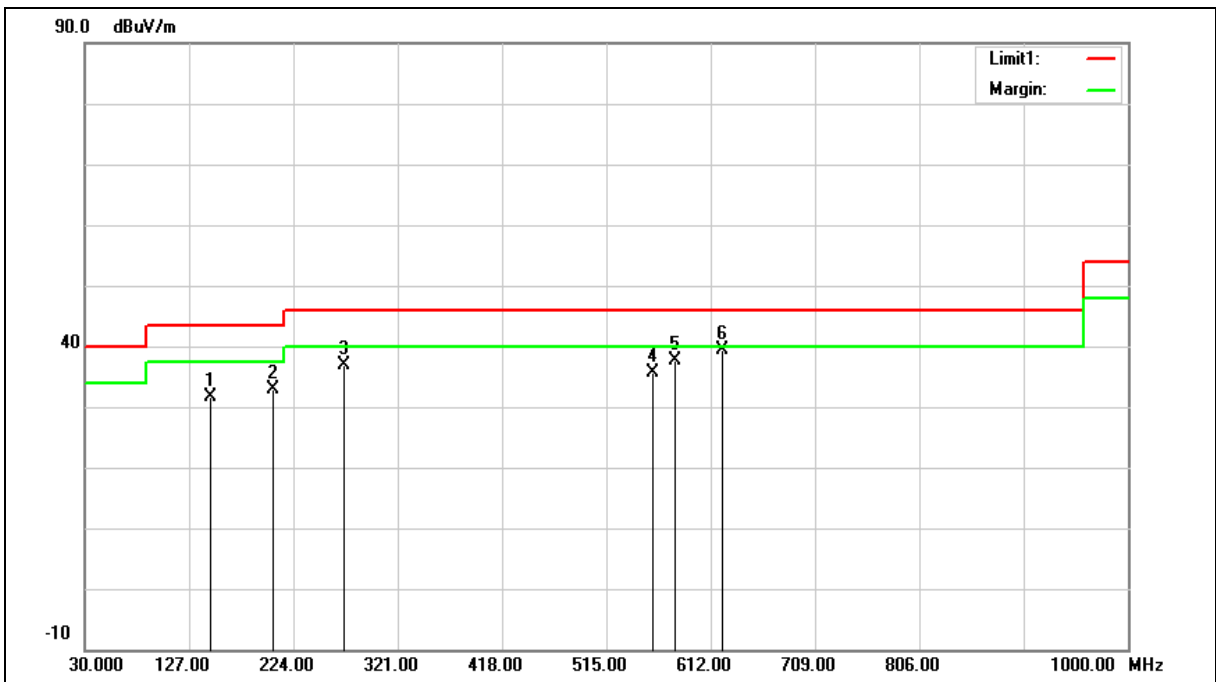

No.	Frequency (MHz)	Reading (dBuV)	Correct Factor (dB/m)	Result (dBuV/m)	Limit (dBuV/m)	Margin (dB)	Remark
1	147.3700	38.51	-6.83	31.68	43.50	-11.82	QP
2	205.5700	41.98	-9.14	32.84	43.50	-10.66	QP
3	270.5600	43.24	-6.33	36.91	46.00	-9.09	QP
4	557.6800	36.28	-0.66	35.62	46.00	-10.38	QP
5	579.0200	37.71	-0.04	37.67	46.00	-8.33	QP
6	622.6700	38.47	0.80	39.27	46.00	-6.73	QP

Note:1.Result (dBuV/m) = Correct Factor (dB/m) + Reading(dBuV).

Example:  $31.68 = -6.83 + 38.51$

2.Correction factor (dB/m) = Antenna Factor (dB/m) + Cable loss (dB) – Pre-Amplifier gain (dB).

3.When the peak results are less than average limit, so not need to evaluate the average.



Standard:	FCC Part 15.247	Test Distance:	3 m
Frequency:	2402 MHz		
Mode:	Mode 2		
Ant.Polar.:	Vertical		

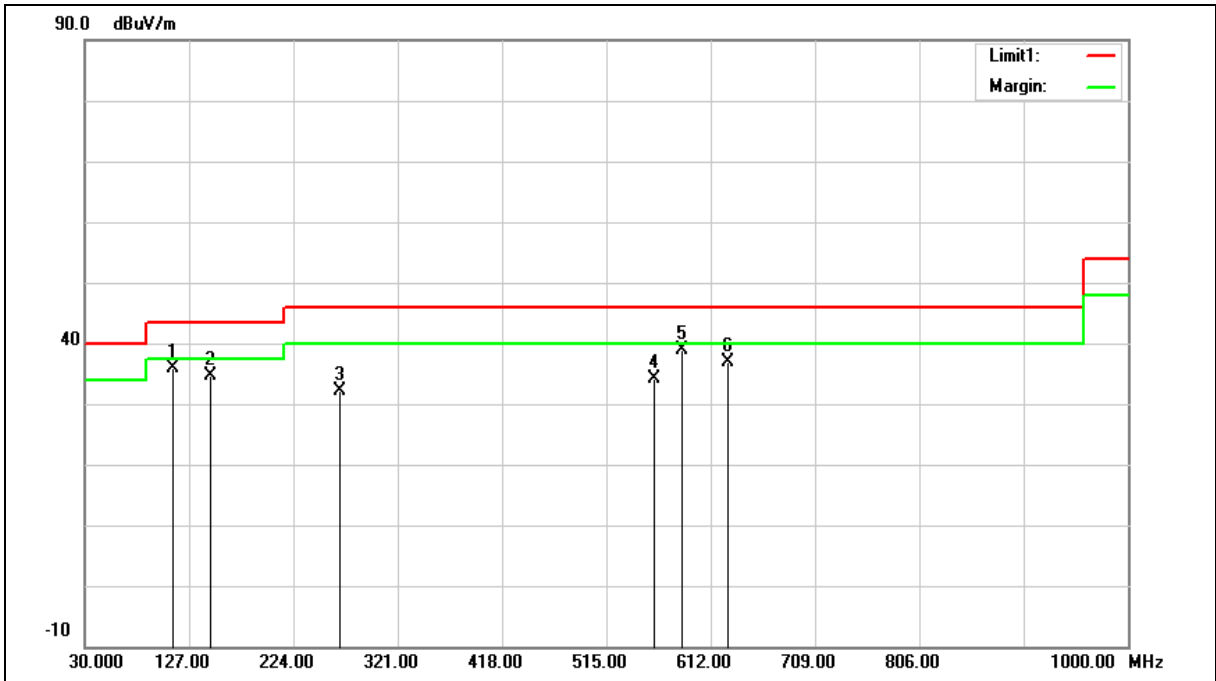

No.	Frequency (MHz)	Reading (dBuV)	Correct Factor (dB/m)	Result (dBuV/m)	Limit (dBuV/m)	Margin (dB)	Remark
1	111.4800	46.20	-10.25	35.95	43.50	-7.55	QP
2	147.3700	41.34	-6.83	34.51	43.50	-8.99	QP
3	267.6500	38.63	-6.43	32.20	46.00	-13.80	QP
4	559.6200	34.82	-0.60	34.22	46.00	-11.78	QP
5	584.8400	38.71	0.12	38.83	46.00	-7.17	QP
6	627.5200	35.91	0.86	36.77	46.00	-9.23	QP

Note:1.Result (dBuV/m) = Correct Factor (dB/m) + Reading(dBuV).

Example: 35.95 = -10.25 + 46.20

2.Correction factor (dB/m) = Antenna Factor (dB/m) + Cable loss (dB) – Pre-Amplifier gain (dB).

3.When the peak results are less than average limit, so not need to evaluate the average.



### Harmonic

Above 1 GHz

Standard:	FCC Part 15.247	Test Distance:	3 m
Test item:	Harmonic		
Frequency:	2402 MHz		
Mode:	Mode 2		
Ant.Polar.:	Horizontal		

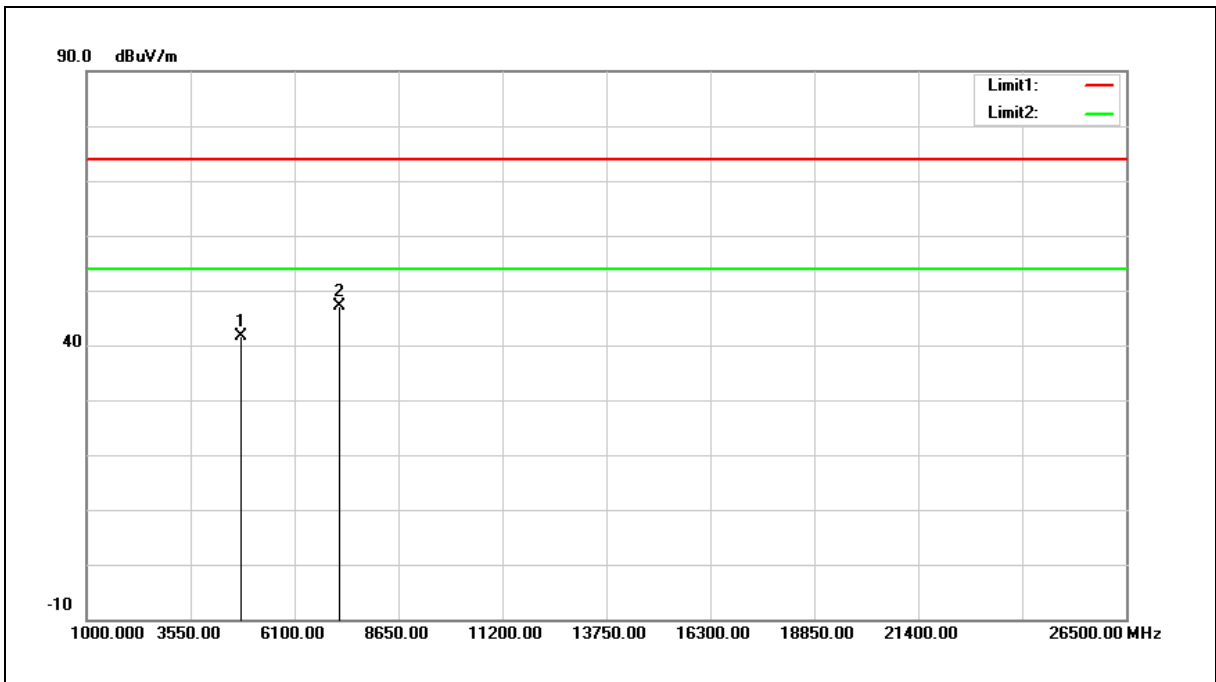

No.	Frequency (MHz)	Reading (dBuV)	Correct Factor (dB/m)	Result (dBuV/m)	Limit (dBuV/m)	Margin (dB)	Remark
1	4804.000	37.93	3.79	41.72	74.00	-32.28	peak
2	7206.000	37.32	9.76	47.08	74.00	-26.92	peak

Note: 1. Result (dBuV/m) = Correct Factor (dB/m) + Reading (dBuV).

Example:  $41.72 = 3.79 + 37.93$

2. Correction factor (dB/m) = Antenna Factor (dB/m) + Cable loss (dB) – Pre-Amplifier gain (dB).

3. When the peak results are less than average limit, so not need to evaluate the average.



Standard:	FCC Part 15.247	Test Distance:	3 m
Test item:	Harmonic		
Frequency:	2402 MHz		
Mode:	Mode 2		
Ant.Polar.:	Vertical		

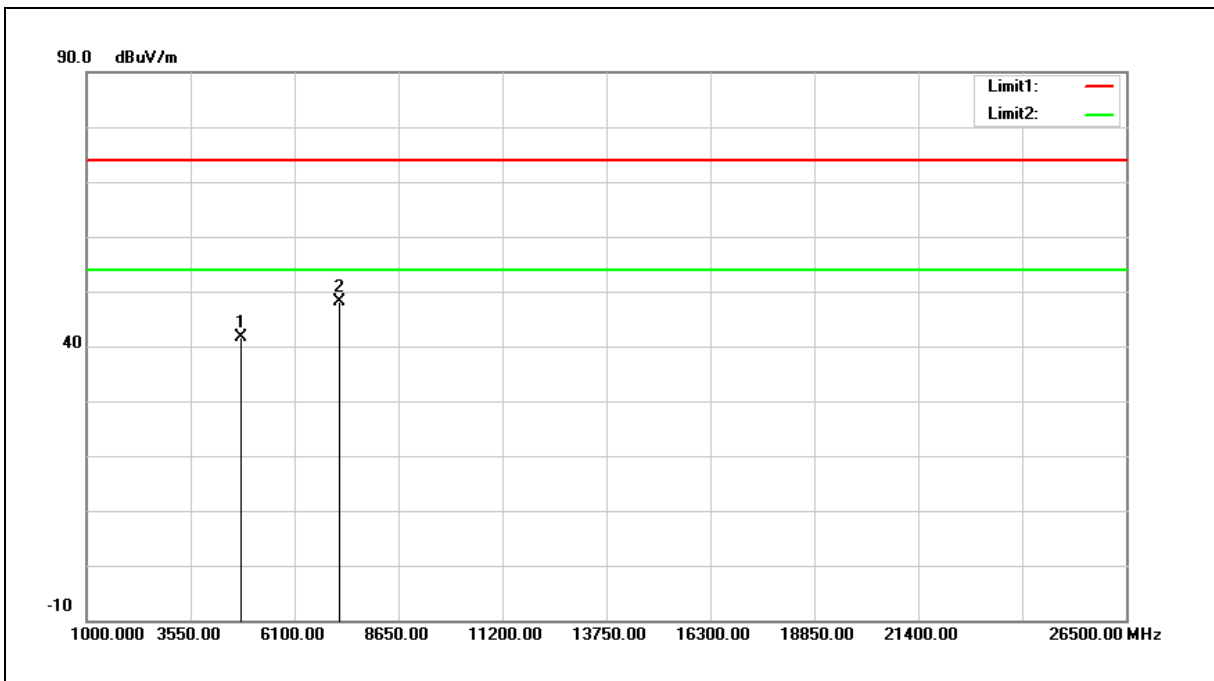

No.	Frequency (MHz)	Reading (dBuV)	Correct Factor (dB/m)	Result (dBuV/m)	Limit (dBuV/m)	Margin (dB)	Remark
1	4804.000	37.91	3.79	41.70	74.00	-32.30	peak
2	7206.000	38.26	9.76	48.02	74.00	-25.98	peak

Note: 1.Result (dBuV/m) = Correct Factor (dB/m) + Reading(dBuV).

Example: 41.70 = 3.79 + 37.91

2.Correction factor (dB/m) = Antenna Factor (dB/m) + Cable loss (dB) – Pre-Amplifier gain (dB).

3.When the peak results are less than average limit, so not need to evaluate the average.





Standard:	FCC Part 15.247	Test Distance:	3 m
Test item:	Harmonic		
Frequency:	2440 MHz		
Mode:	Mode 2		
Ant.Polar.:	Horizontal		

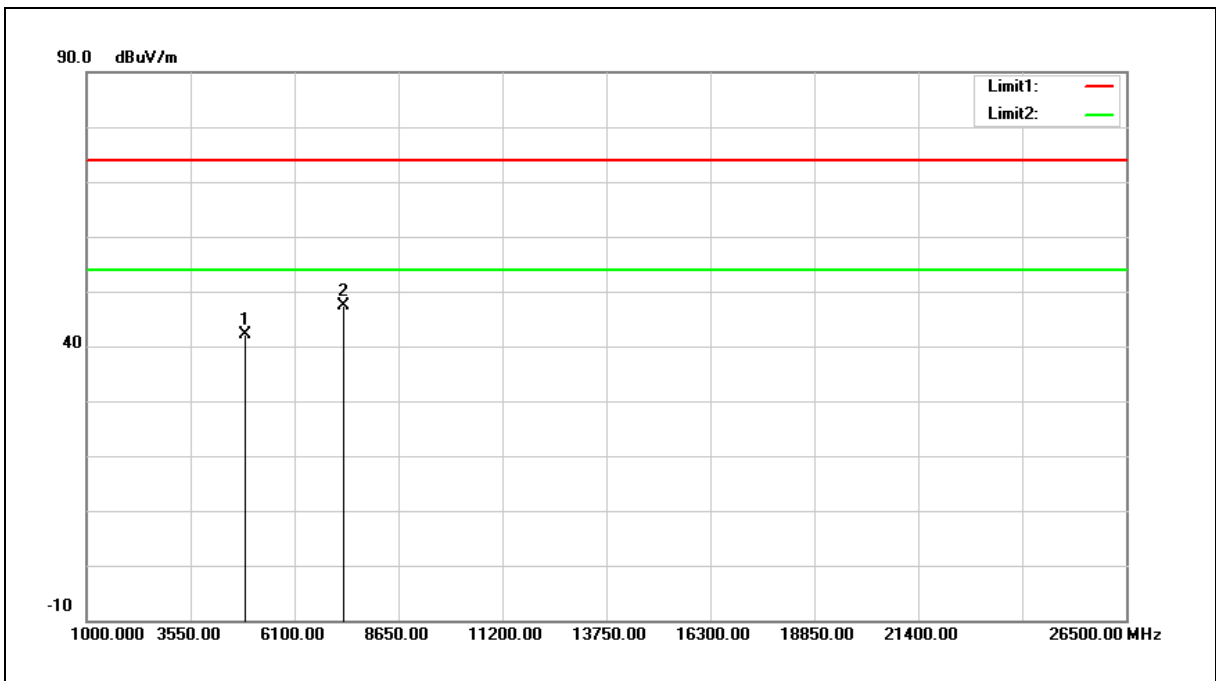

No.	Frequency (MHz)	Reading (dBuV)	Correct Factor (dB/m)	Result (dBuV/m)	Limit (dBuV/m)	Margin (dB)	Remark
1	4880.000	37.99	4.03	42.02	74.00	-31.98	peak
2	7320.000	37.20	10.16	47.36	74.00	-26.64	peak

- Note: 1.Result (dBuV/m) = Correct Factor (dB/m) + Reading(dBuV).  
 2.Correction factor (dB/m) = Antenna Factor (dB/m) + Cable loss (dB) – Pre-Amplifier gain (dB).  
 3.When the peak results are less than average limit, so not need to evaluate the average.



Standard:	FCC Part 15.247	Test Distance:	3 m
Test item:	Harmonic		
Frequency:	2440 MHz		
Mode:	Mode 2		
Ant.Polar.:	Vertical		

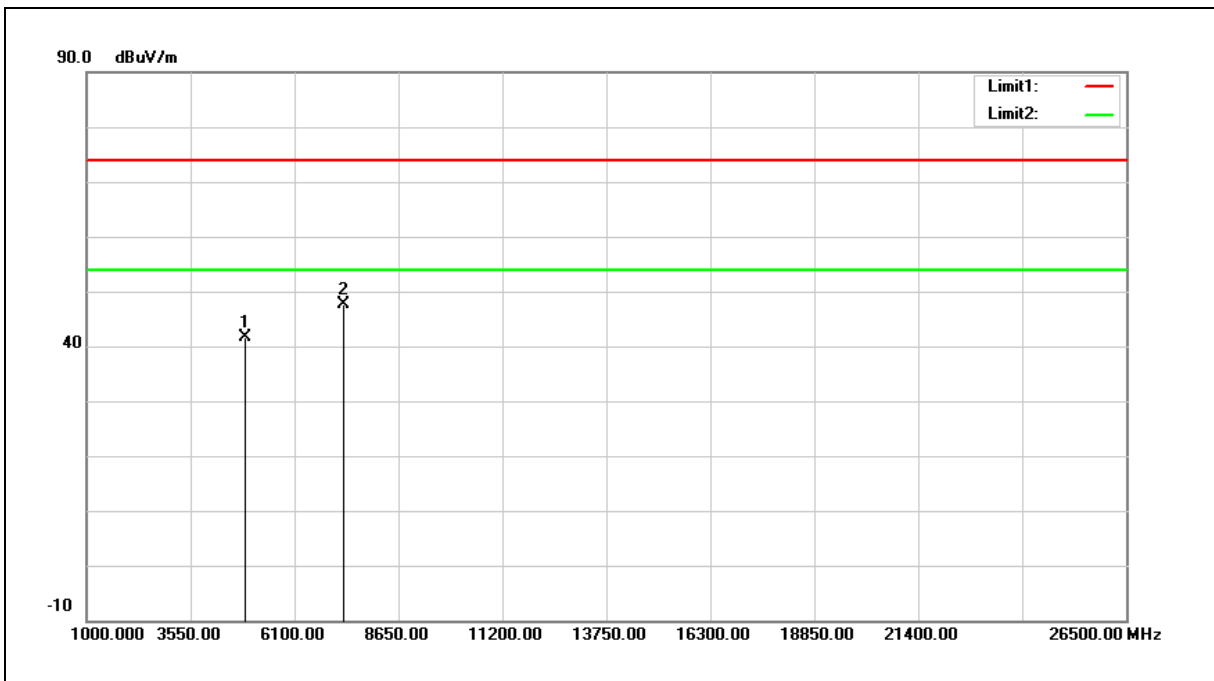

No.	Frequency (MHz)	Reading (dBuV)	Correct Factor (dB/m)	Result (dBuV/m)	Limit (dBuV/m)	Margin (dB)	Remark
1	4880.000	37.58	4.03	41.61	74.00	-32.39	peak
2	7320.000	37.36	10.16	47.52	74.00	-26.48	peak

- Note: 1. Result (dBuV/m) = Correct Factor (dB/m) + Reading(dBuV).  
 2. Correction factor (dB/m) = Antenna Factor (dB/m) + Cable loss (dB) – Pre-Amplifier gain (dB).  
 3. When the peak results are less than average limit, so not need to evaluate the average.



Standard:	FCC Part 15.247	Test Distance:	3 m
Test item:	Harmonic		
Frequency:	2480 MHz		
Mode:	Mode 2		
Ant.Polar.:	Horizontal		

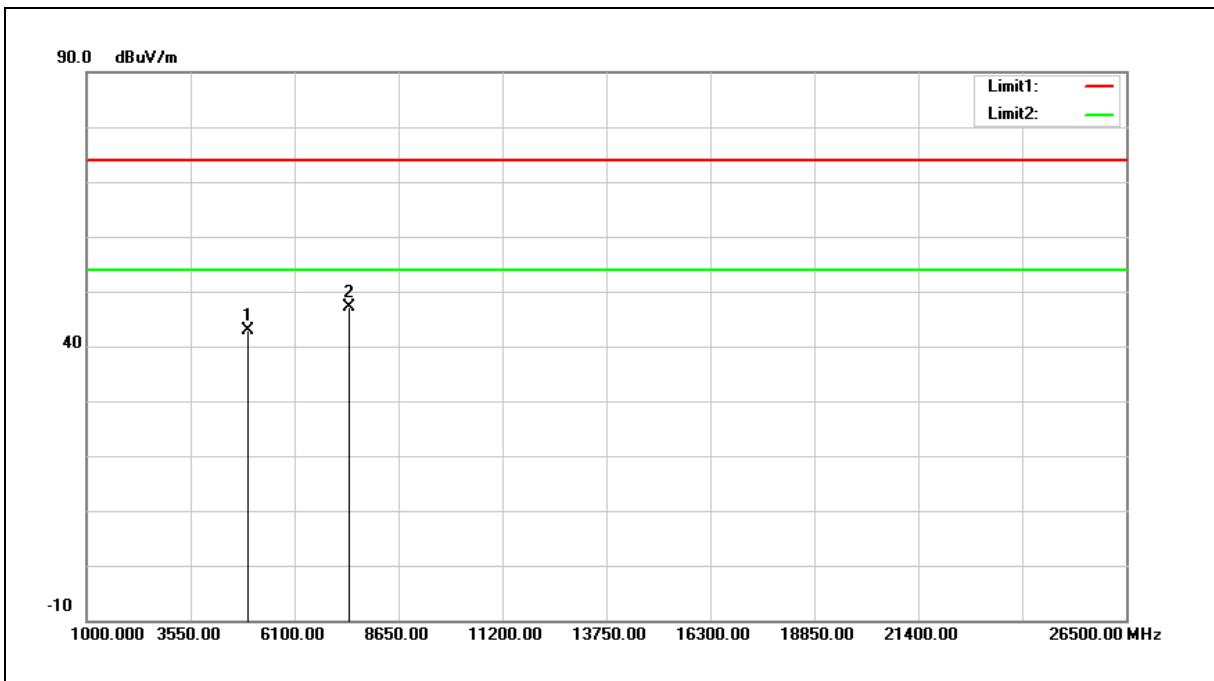

No.	Frequency (MHz)	Reading (dBuV)	Correct Factor (dB/m)	Result (dBuV/m)	Limit (dBuV/m)	Margin (dB)	Remark
1	4960.000	38.57	4.29	42.86	74.00	-31.14	peak
2	7440.000	36.66	10.59	47.25	74.00	-26.75	peak

Note: 1. Result (dBuV/m) = Correct Factor (dB/m) + Reading (dBuV).

2. Correction factor (dB/m) = Antenna Factor (dB/m) + Cable loss (dB) – Pre-Amplifier gain (dB).

3. When the peak results are less than average limit, so not need to evaluate the average.



Standard:	FCC Part 15.247	Test Distance:	3 m
Test item:	Harmonic		
Frequency:	2480 MHz		
Mode:	Mode 2		
Ant.Polar.:	Vertical		

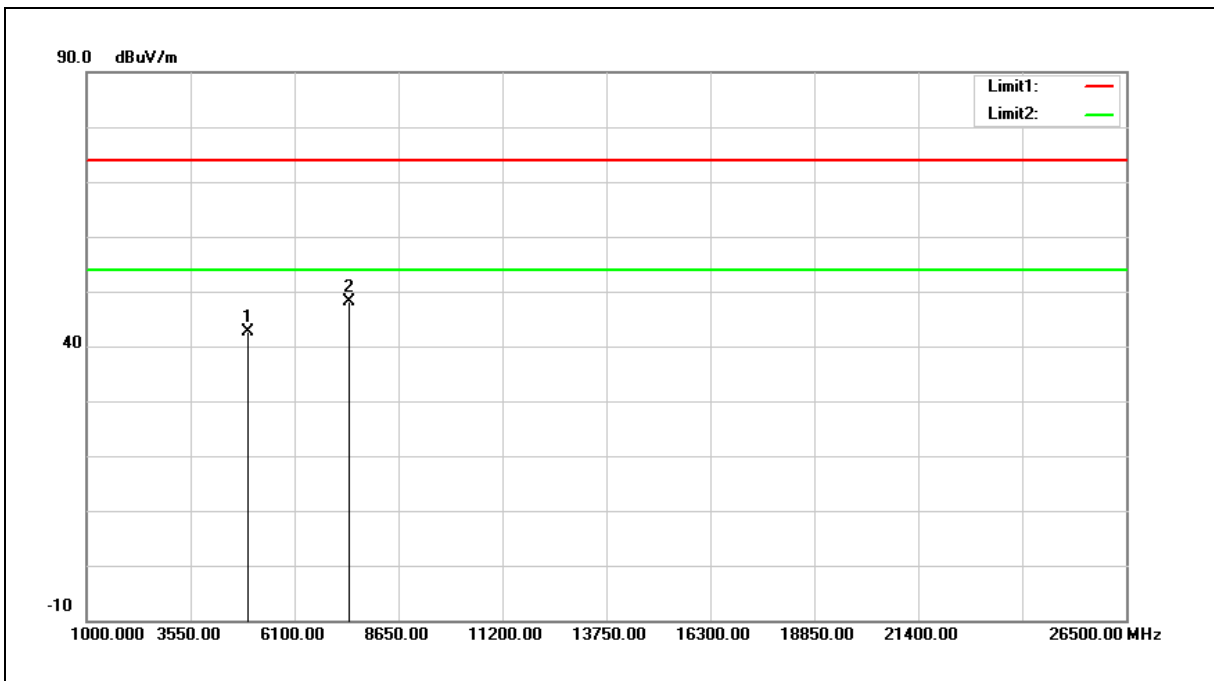

No.	Frequency (MHz)	Reading (dBuV)	Correct Factor (dB/m)	Result (dBuV/m)	Limit (dBuV/m)	Margin (dB)	Remark
1	4960.000	38.42	4.29	42.71	74.00	-31.29	peak
2	7440.000	37.63	10.59	48.22	74.00	-25.78	peak

- Note: 1. Result (dBuV/m) = Correct Factor (dB/m) + Reading(dBuV).  
 2. Correction factor (dB/m) = Antenna Factor (dB/m) + Cable loss (dB) – Pre-Amplifier gain (dB).  
 3. When the peak results are less than average limit, so not need to evaluate the average.

Standard:	FCC Part 15.247	Test Distance:	3 m
Test item:	Harmonic		
Frequency:	2402 MHz		
Mode:	Mode 3		
Ant.Polar.:	Horizontal		

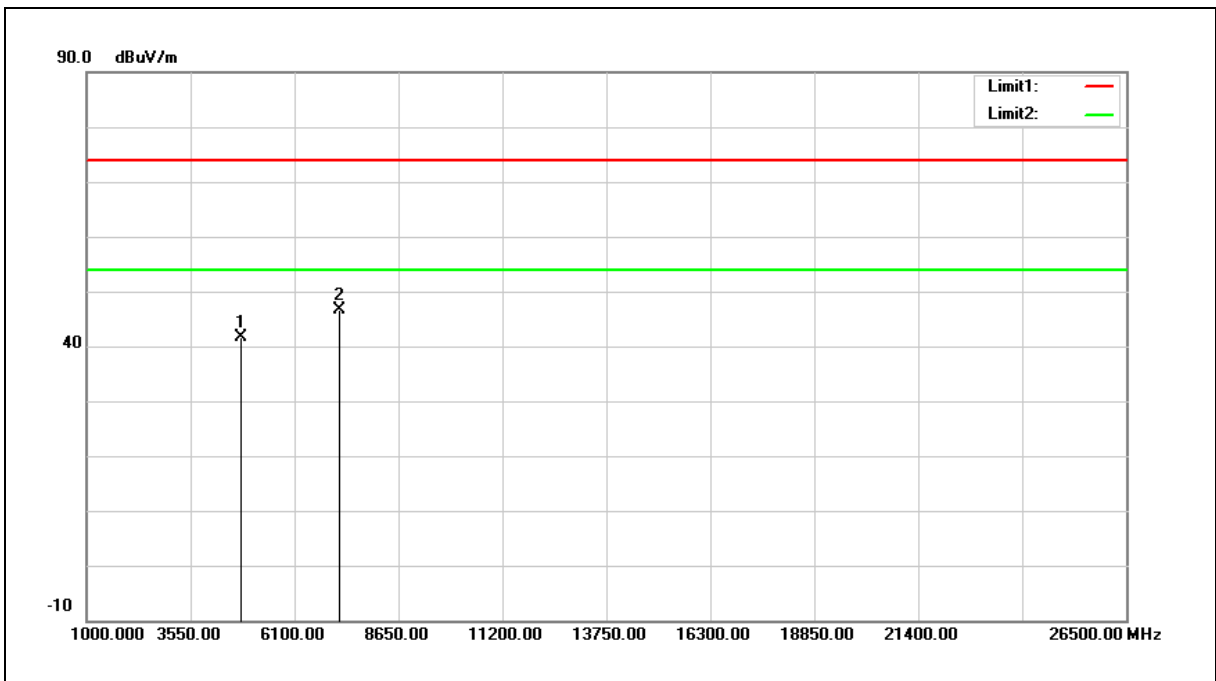

No.	Frequency (MHz)	Reading (dBuV)	Correct Factor (dB/m)	Result (dBuV/m)	Limit (dBuV/m)	Margin (dB)	Remark
1	4804.000	37.81	3.79	41.60	74.00	-32.40	peak
2	7206.000	36.96	9.76	46.72	74.00	-27.28	peak

- Note: 1. Result (dBuV/m) = Correct Factor (dB/m) + Reading(dBuV).  
 2. Correction factor (dB/m) = Antenna Factor (dB/m) + Cable loss (dB) – Pre-Amplifier gain (dB).  
 3. When the peak results are less than average limit, so not need to evaluate the average.



Standard:	FCC Part 15.247	Test Distance:	3 m
Test item:	Harmonic		
Frequency:	2402 MHz		
Mode:	Mode 3		
Ant.Polar.:	Vertical		

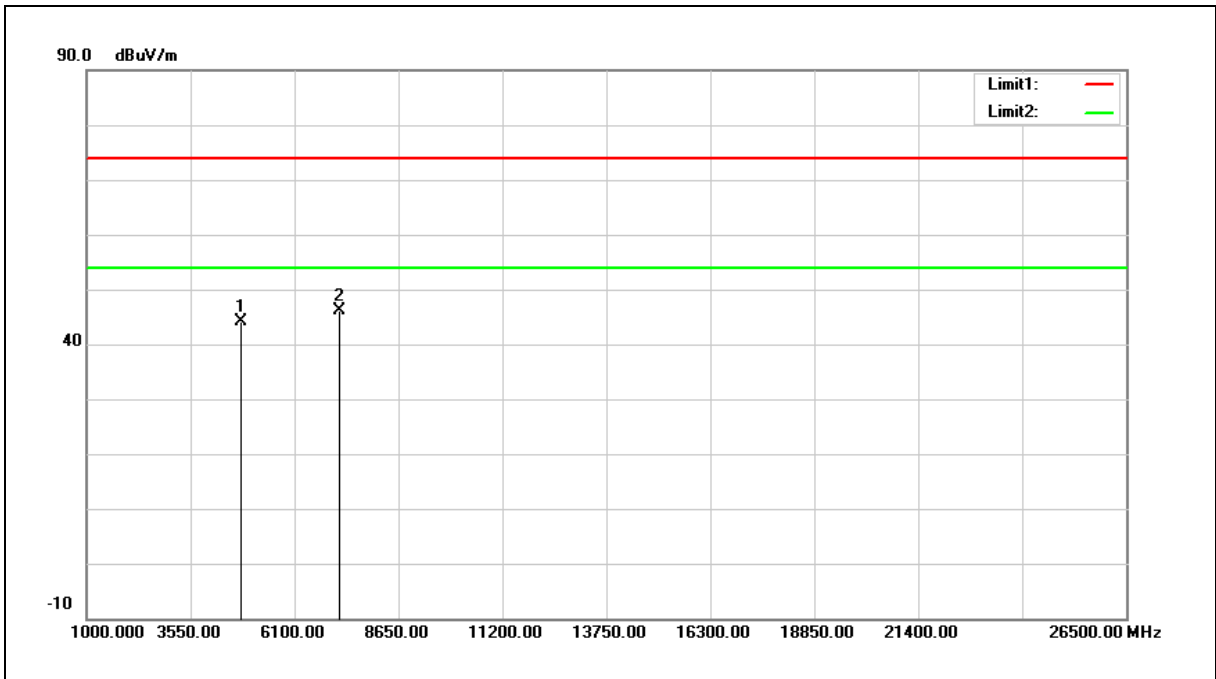

No.	Frequency (MHz)	Reading (dBuV)	Correct Factor (dB/m)	Result (dBuV/m)	Limit (dBuV/m)	Margin (dB)	Remark
1	4804.000	40.23	3.79	44.02	74.00	-29.98	peak
2	7206.000	36.37	9.76	46.13	74.00	-27.87	peak

- Note: 1. Result (dBuV/m) = Correct Factor (dB/m) + Reading(dBuV).  
 2. Correction factor (dB/m) = Antenna Factor (dB/m) + Cable loss (dB) – Pre-Amplifier gain (dB).  
 3. When the peak results are less than average limit, so not need to evaluate the average.



Standard:	FCC Part 15.247	Test Distance:	3 m
Test item:	Harmonic		
Frequency:	2440 MHz		
Mode:	Mode 3		
Ant.Polar.:	Horizontal		

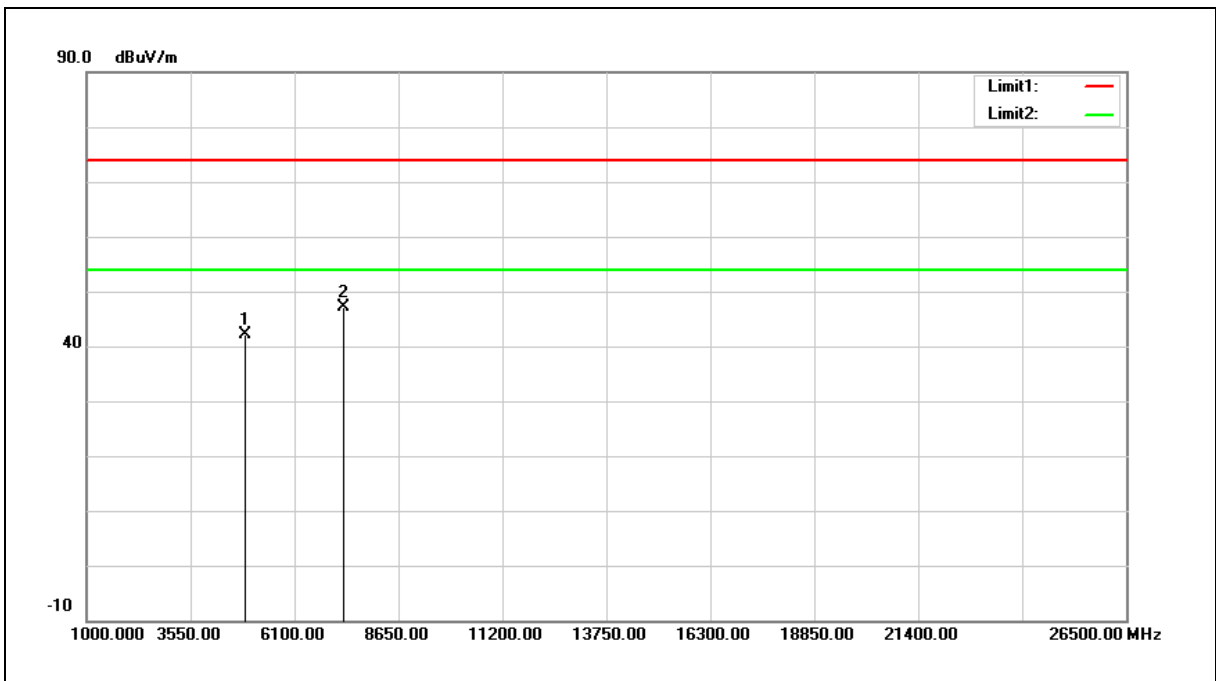

No.	Frequency (MHz)	Reading (dBuV)	Correct Factor (dB/m)	Result (dBuV/m)	Limit (dBuV/m)	Margin (dB)	Remark
1	4880.000	38.02	4.03	42.05	74.00	-31.95	peak
2	7320.000	36.95	10.16	47.11	74.00	-26.89	peak

- Note: 1.Result (dBuV/m) = Correct Factor (dB/m) + Reading(dBuV).  
 2.Correction factor (dB/m) = Antenna Factor (dB/m) + Cable loss (dB) – Pre-Amplifier gain (dB).  
 3.When the peak results are less than average limit, so not need to evaluate the average.



Standard:	FCC Part 15.247	Test Distance:	3 m
Test item:	Harmonic		
Frequency:	2440 MHz		
Mode:	Mode 3		
Ant.Polar.:	Vertical		

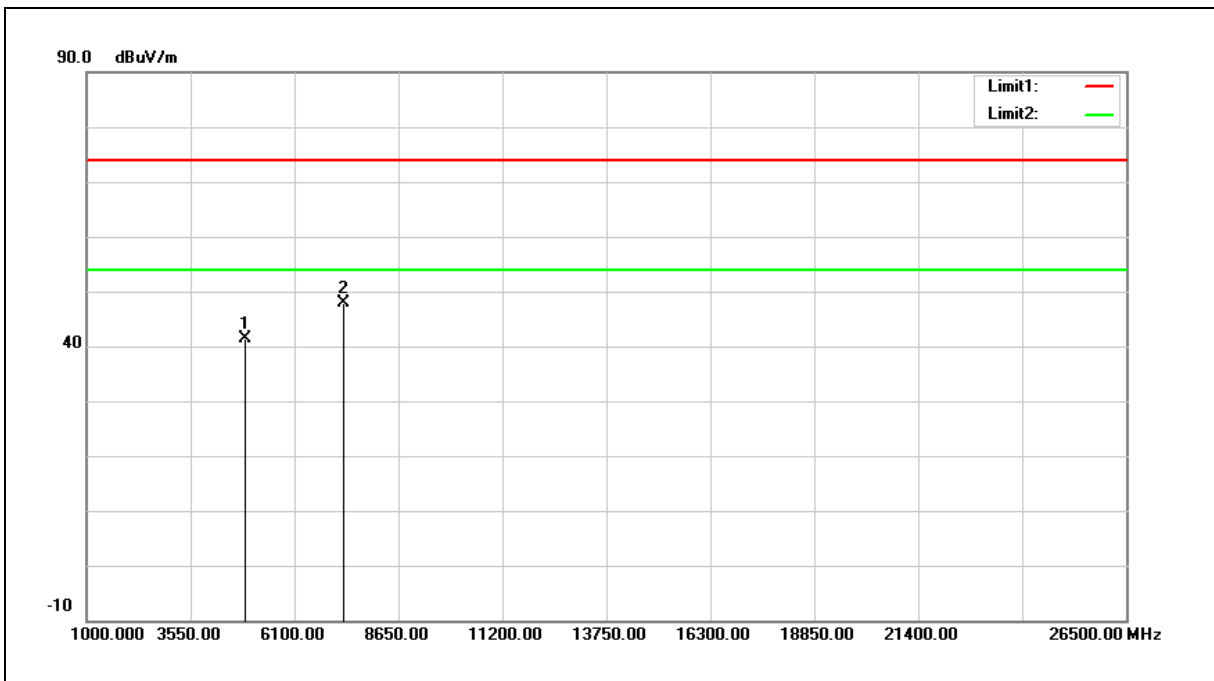

No.	Frequency (MHz)	Reading (dBuV)	Correct Factor (dB/m)	Result (dBuV/m)	Limit (dBuV/m)	Margin (dB)	Remark
1	4880.000	37.34	4.03	41.37	74.00	-32.63	peak
2	7320.000	37.66	10.16	47.82	74.00	-26.18	peak

- Note: 1. Result (dBuV/m) = Correct Factor (dB/m) + Reading(dBuV).  
 2. Correction factor (dB/m) = Antenna Factor (dB/m) + Cable loss (dB) – Pre-Amplifier gain (dB).  
 3. When the peak results are less than average limit, so not need to evaluate the average.





Standard:	FCC Part 15.247	Test Distance:	3 m
Test item:	Harmonic		
Frequency:	2480 MHz		
Mode:	Mode 3		
Ant.Polar.:	Horizontal		

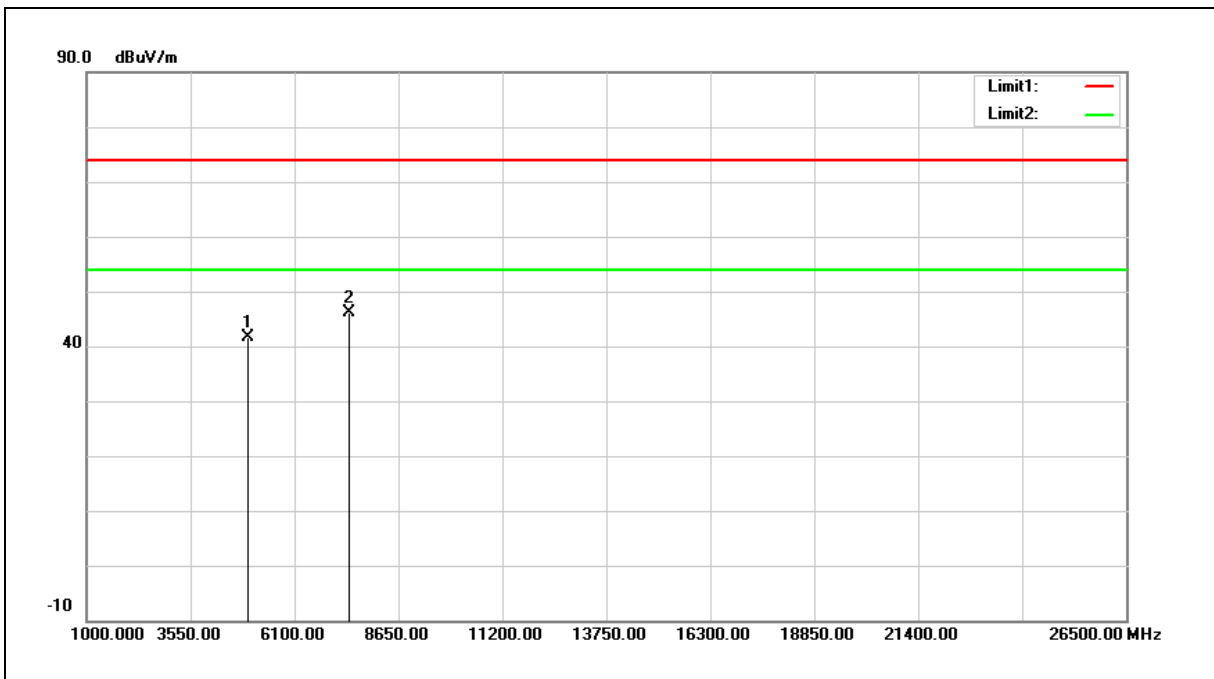

No.	Frequency (MHz)	Reading (dBuV)	Correct Factor (dB/m)	Result (dBuV/m)	Limit (dBuV/m)	Margin (dB)	Remark
1	4960.000	37.28	4.29	41.57	74.00	-32.43	peak
2	7440.000	35.61	10.59	46.20	74.00	-27.80	peak

- Note: 1. Result (dBuV/m) = Correct Factor (dB/m) + Reading(dBuV).  
 2. Correction factor (dB/m) = Antenna Factor (dB/m) + Cable loss (dB) – Pre-Amplifier gain (dB).  
 3. When the peak results are less than average limit, so not need to evaluate the average.



Standard:	FCC Part 15.247	Test Distance:	3 m
Test item:	Harmonic		
Frequency:	2480 MHz		
Mode:	Mode 3		
Ant.Polar.:	Vertical		

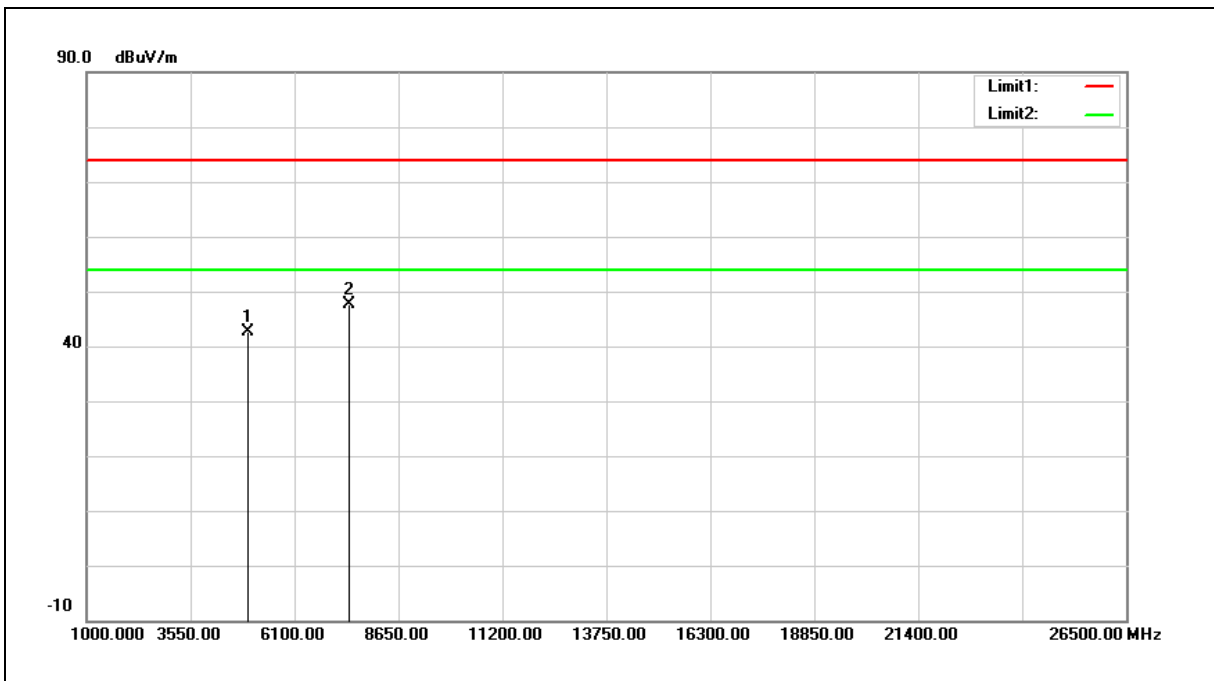

No.	Frequency (MHz)	Reading (dBuV)	Correct Factor (dB/m)	Result (dBuV/m)	Limit (dBuV/m)	Margin (dB)	Remark
1	4960.000	38.33	4.29	42.62	74.00	-31.38	peak
2	7440.000	37.03	10.59	47.62	74.00	-26.38	peak

- Note: 1. Result (dBuV/m) = Correct Factor (dB/m) + Reading(dBuV).  
 2. Correction factor (dB/m) = Antenna Factor (dB/m) + Cable loss (dB) – Pre-Amplifier gain (dB).  
 3. When the peak results are less than average limit, so not need to evaluate the average.



**Band Edge**

**Peak**

Standard:	FCC Part 15.247	Test Distance:	3 m
Test item:	Band edge		
Frequency:	2402 MHz		
Mode:	Mode 2		
Ant.Polar.:	Horizontal		

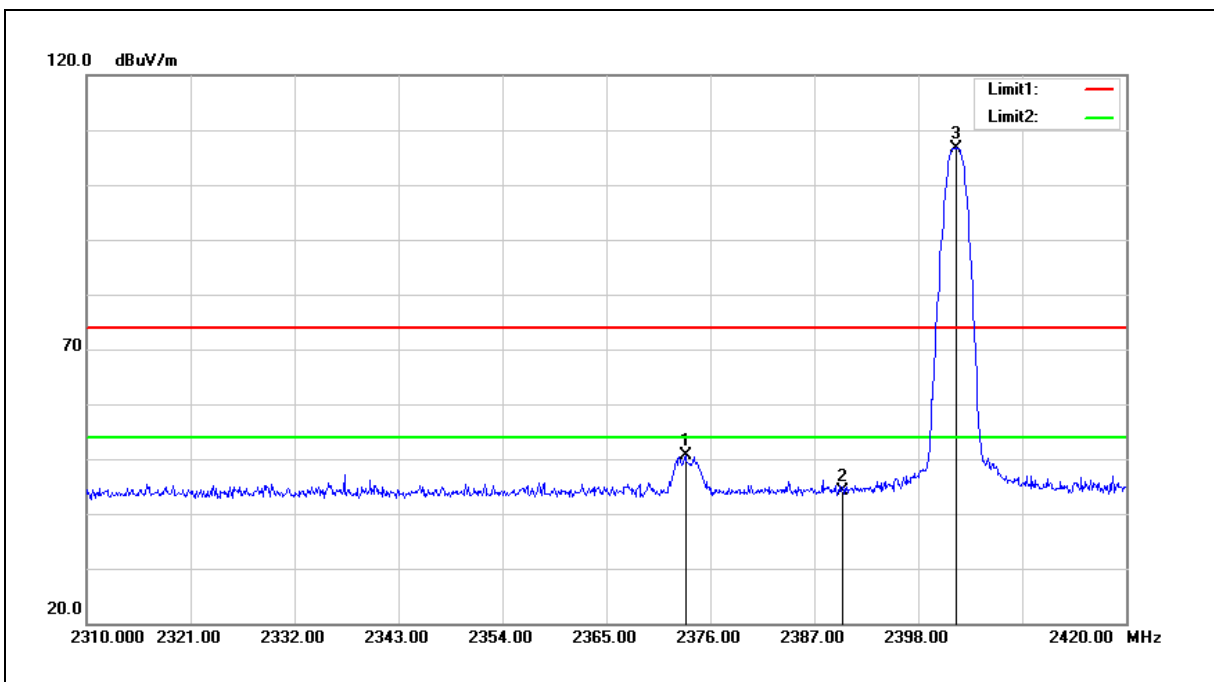

No.	Frequency (MHz)	Reading (dBuV)	Correct Factor (dB/m)	Result (dBuV/m)	Limit (dBuV/m)	Margin (dB)	Remark
1	2373.360	52.95	-2.34	50.61	74.00	-23.39	peak
2	2390.000	46.35	-2.28	44.07	74.00	-29.93	peak
3	2402.070	108.98	-2.23	106.75	--	--	peak

Note:1.Result (dBuV/m) = Correct Factor (dB/m) + Reading(dBuV).

2.Correction factor (dB/m) = Antenna Factor (dB/m) + Cable loss (dB) – Pre-Amplifier gain (dB).

3.When the peak results are less than average limit, so not need to evaluate the average.

Standard:	FCC Part 15.247	Test Distance:	3 m
Test item:	Band edge		
Frequency:	2402 MHz		
Mode:	Mode 2		
Ant.Polar.:	Vertical		

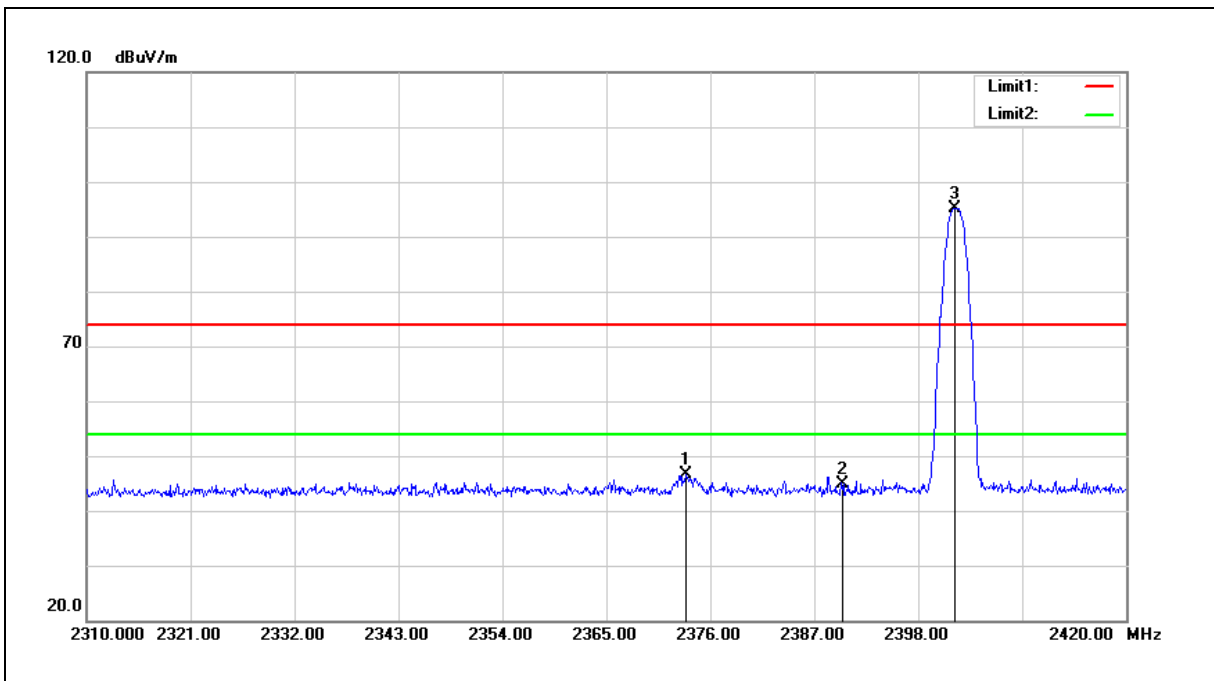

No.	Frequency (MHz)	Reading (dBuV)	Correct Factor (dB/m)	Result (dBuV/m)	Limit (dBuV/m)	Margin (dB)	Remark
1	2373.360	48.91	-2.34	46.57	74.00	-27.43	peak
2	2390.000	47.12	-2.28	44.84	74.00	-29.16	peak
3	2401.850	97.41	-2.23	95.18	--	--	peak

Note:1.Result (dBuV/m) = Correct Factor (dB/m) + Reading(dBuV).

2.Correction factor (dB/m) = Antenna Factor (dB/m) + Cable loss (dB) – Pre-Amplifier gain (dB).

3.When the peak results are less than average limit, so not need to evaluate the average.

Standard:	FCC Part 15.247	Test Distance:	3 m
Test item:	Band edge		
Frequency:	2480 MHz		
Mode:	Mode 2		
Ant.Polar.:	Horizontal		

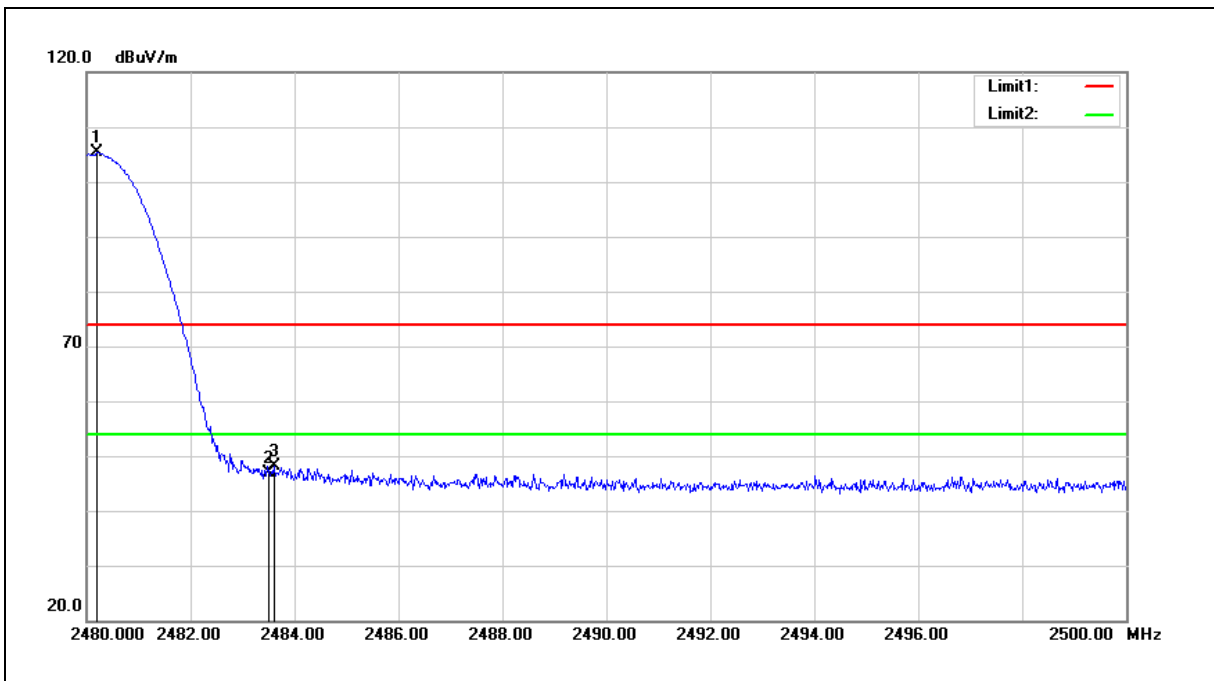

No.	Frequency (MHz)	Reading (dBuV)	Correct Factor (dB/m)	Result (dBuV/m)	Limit (dBuV/m)	Margin (dB)	Remark
1	2480.200	107.28	-1.95	105.33	--	--	peak
2	2483.500	48.90	-1.94	46.96	74.00	-27.04	peak
3	2483.600	50.16	-1.94	48.22	74.00	-25.78	peak

Note:1.Result (dBuV/m) = Correct Factor (dB/m) + Reading(dBuV).

2.Correction factor (dB/m) = Antenna Factor (dB/m) + Cable loss (dB) – Pre-Amplifier gain (dB).

3.When the peak results are less than average limit, so not need to evaluate the average.

Standard:	FCC Part 15.247	Test Distance:	3 m
Test item:	Band edge		
Frequency:	2480 MHz		
Mode:	Mode 2		
Ant.Polar.:	Vertical		

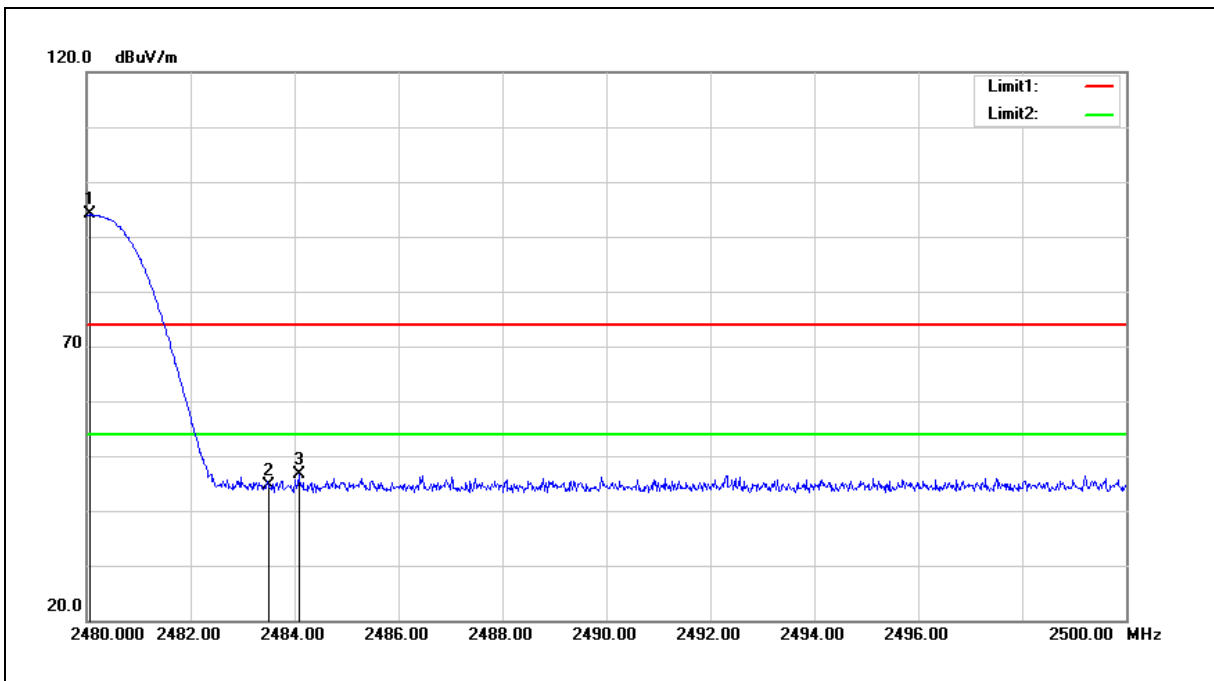

No.	Frequency (MHz)	Reading (dBuV)	Correct Factor (dB/m)	Result (dBuV/m)	Limit (dBuV/m)	Margin (dB)	Remark
1	2480.060	96.01	-1.95	94.06	--	--	peak
2	2483.500	46.63	-1.94	44.69	74.00	-29.31	peak
3	2484.080	48.56	-1.92	46.64	74.00	-27.36	peak

Note:1.Result (dBuV/m) = Correct Factor (dB/m) + Reading(dBuV).

2.Correction factor (dB/m) = Antenna Factor (dB/m) + Cable loss (dB) – Pre-Amplifier gain (dB).

3.When the peak results are less than average limit, so not need to evaluate the average.



Standard:	FCC Part 15.247	Test Distance:	3 m
Test item:	Band edge		
Frequency:	2402 MHz		
Mode:	Mode 3		
Ant.Polar.:	Horizontal		

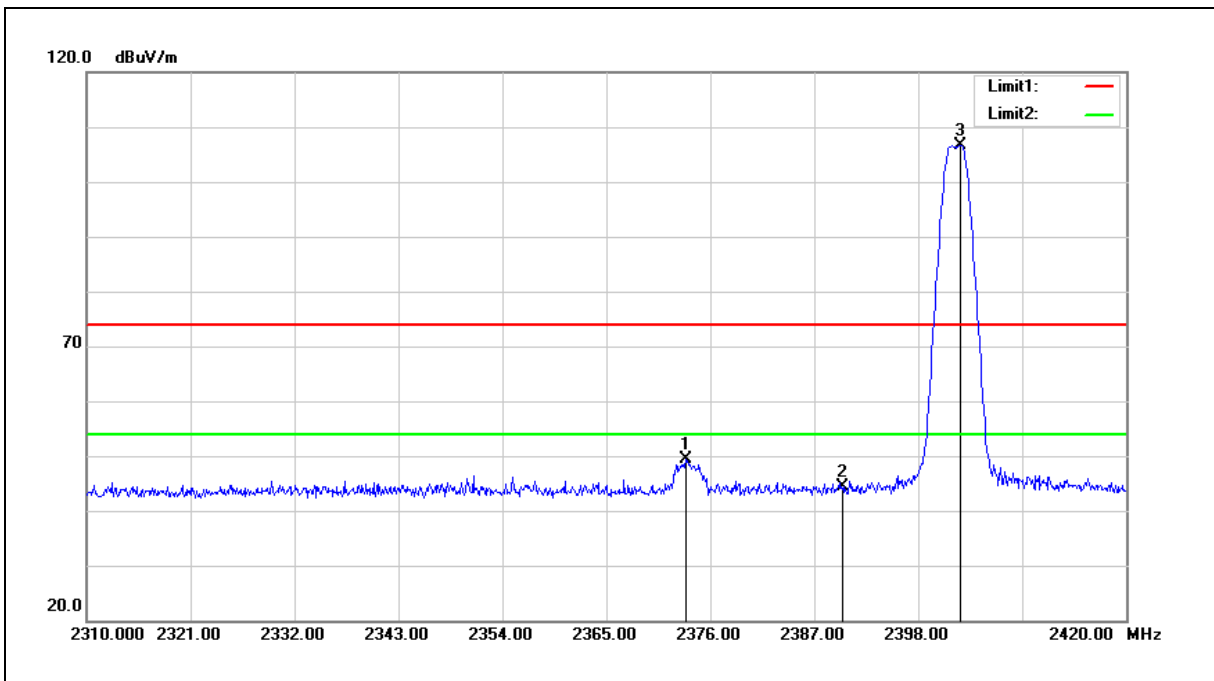

No.	Frequency (MHz)	Reading (dBuV)	Correct Factor (dB/m)	Result (dBuV/m)	Limit (dBuV/m)	Margin (dB)	Remark
1	2373.360	51.64	-2.34	49.30	74.00	-24.70	peak
2	2390.000	46.66	-2.28	44.38	74.00	-29.62	peak
3	2402.510	108.97	-2.23	106.74	--	--	peak

Note:1.Result (dBuV/m) = Correct Factor (dB/m) + Reading(dBuV).

2.Correction factor (dB/m) = Antenna Factor (dB/m) + Cable loss (dB) – Pre-Amplifier gain (dB).

3.When the peak results are less than average limit, so not need to evaluate the average.



Standard:	FCC Part 15.247	Test Distance:	3 m
Test item:	Band edge		
Frequency:	2402 MHz		
Mode:	Mode 3		
Ant.Polar.:	Vertical		

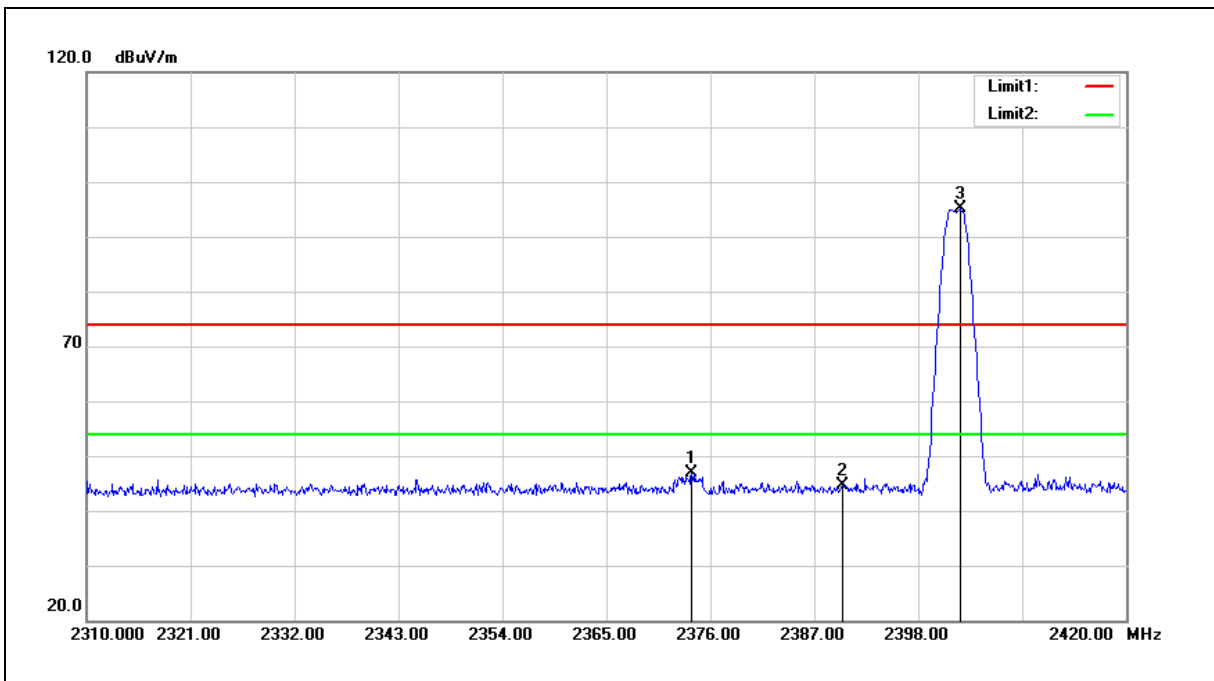

No.	Frequency (MHz)	Reading (dBuV)	Correct Factor (dB/m)	Result (dBuV/m)	Limit (dBuV/m)	Margin (dB)	Remark
1	2374.020	49.24	-2.34	46.90	74.00	-27.10	peak
2	2390.000	46.96	-2.28	44.68	74.00	-29.32	peak
3	2402.510	97.41	-2.23	95.18	--	--	peak

Note:1.Result (dBuV/m) = Correct Factor (dB/m) + Reading(dBuV).

2.Correction factor (dB/m) = Antenna Factor (dB/m) + Cable loss (dB) – Pre-Amplifier gain (dB).

3.When the peak results are less than average limit, so not need to evaluate the average.





Standard:	FCC Part 15.247	Test Distance:	3 m
Test item:	Band edge		
Frequency:	2480 MHz		
Mode:	Mode 3		
Ant.Polar.:	Horizontal		

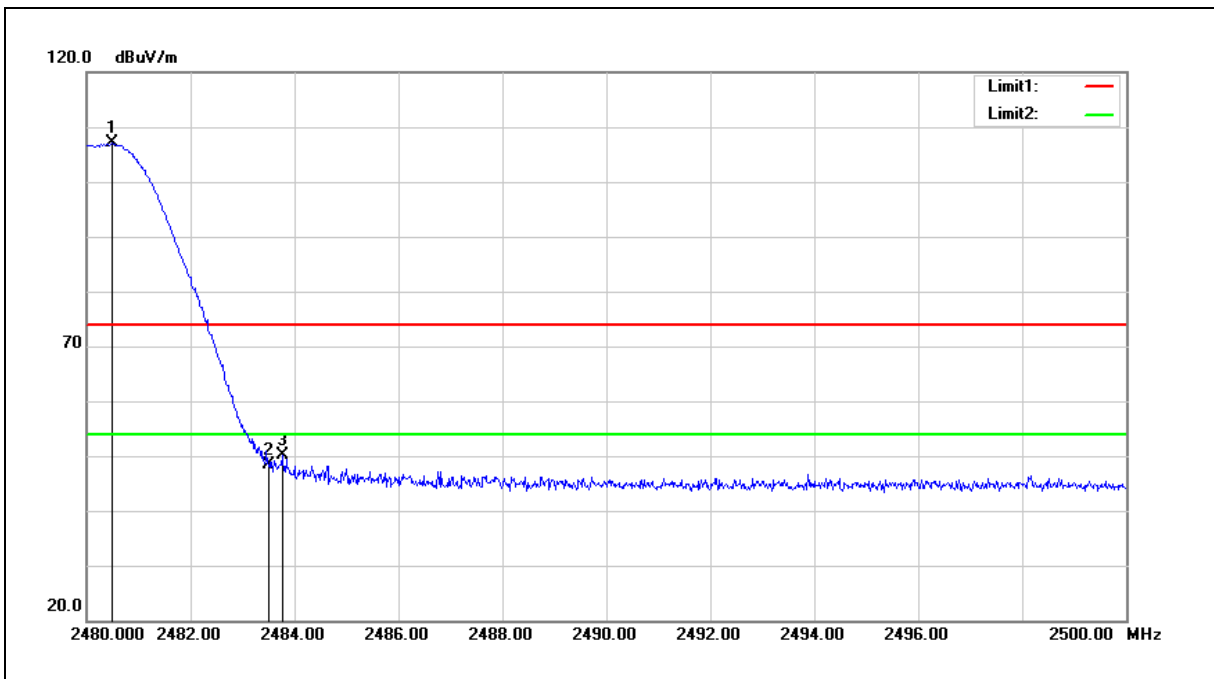

No.	Frequency (MHz)	Reading (dBuV)	Correct Factor (dB/m)	Result (dBuV/m)	Limit (dBuV/m)	Margin (dB)	Remark
1	2480.500	108.95	-1.94	107.01	--	--	peak
2	2483.500	50.28	-1.94	48.34	74.00	-25.66	peak
3	2483.760	52.06	-1.94	50.12	74.00	-23.88	peak

Note:1.Result (dBuV/m) = Correct Factor (dB/m) + Reading(dBuV).

2.Correction factor (dB/m) = Antenna Factor (dB/m) + Cable loss (dB) – Pre-Amplifier gain (dB).

3.When the peak results are less than average limit, so not need to evaluate the average.



Standard:	FCC Part 15.247	Test Distance:	3 m
Test item:	Band edge		
Frequency:	2480 MHz		
Mode:	Mode 3		
Ant.Polar.:	Vertical		

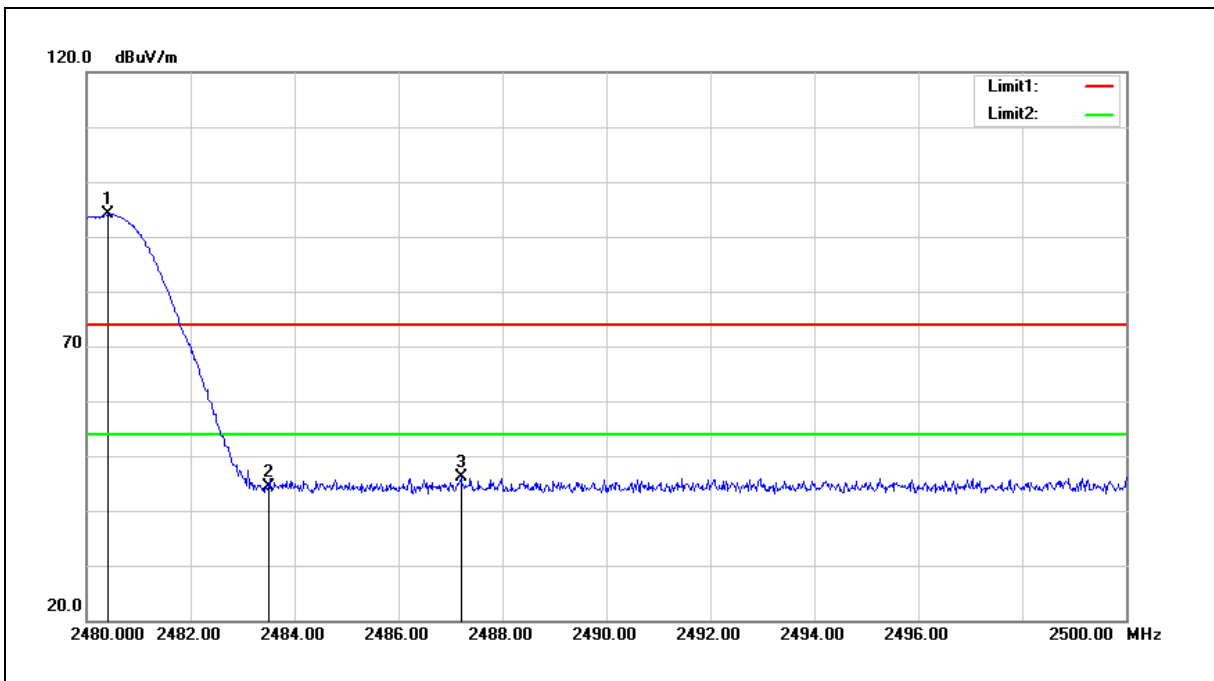

No.	Frequency (MHz)	Reading (dBuV)	Correct Factor (dB/m)	Result (dBuV/m)	Limit (dBuV/m)	Margin (dB)	Remark
1	2480.400	96.04	-1.94	94.10	--	--	peak
2	2483.500	46.39	-1.94	44.45	74.00	-29.55	peak
3	2487.200	47.97	-1.92	46.05	74.00	-27.95	peak

Note:1.Result (dBuV/m) = Correct Factor (dB/m) + Reading(dBuV).

2.Correction factor (dB/m) = Antenna Factor (dB/m) + Cable loss (dB) – Pre-Amplifier gain (dB).

3.When the peak results are less than average limit, so not need to evaluate the average.



**Average**

Standard:	FCC Part 15.247	Test Distance:	3 m
Test item:	Band edge		
Frequency:	2402 MHz		
Mode:	Mode 2		
Ant.Polar.:	Horizontal		

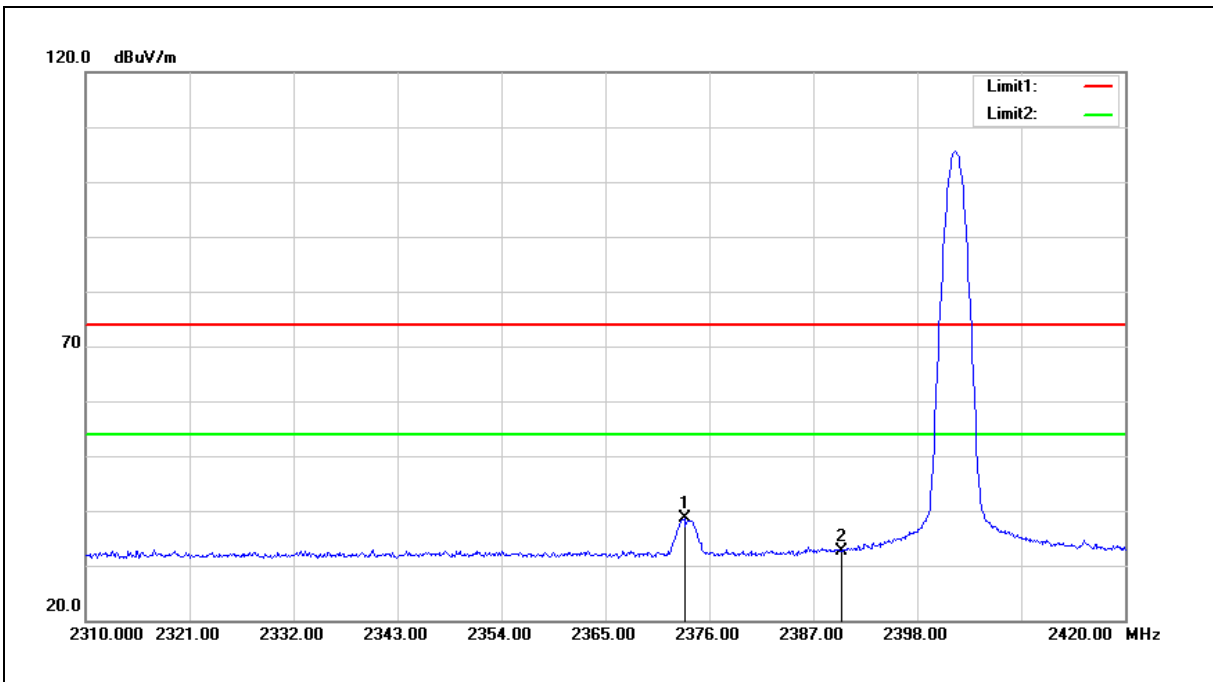

No.	Frequency (MHz)	Reading (dBuV)	Correct Factor (dB/m)	Result (dBuV/m)	Limit (dBuV/m)	Margin (dB)	Remark
1	2373.360	40.85	-2.34	38.51	54.00	-15.49	AVG
2	2390.000	35.01	-2.28	32.73	54.00	-21.27	AVG

Note:1.Result (dBuV/m) = Correct Factor (dB/m) + Reading(dBuV).

2.Correction factor (dB/m) = Antenna Factor (dB/m) + Cable loss (dB) – Pre-Amplifier gain (dB).

3.When the peak results are less than average limit, so not need to evaluate the average.



Standard:	FCC Part 15.247	Test Distance:	3 m
Test item:	Band edge		
Frequency:	2402 MHz		
Mode:	Mode 2		
Ant.Polar.:	Vertical		

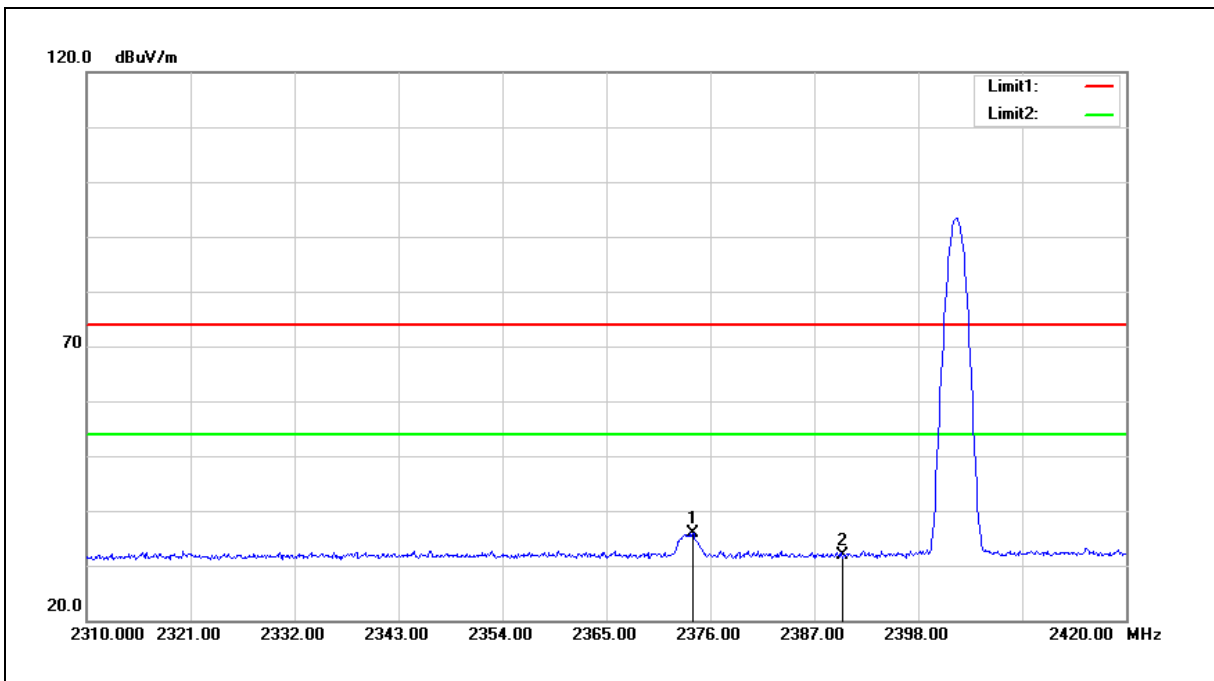

No.	Frequency (MHz)	Reading (dBuV)	Correct Factor (dB/m)	Result (dBuV/m)	Limit (dBuV/m)	Margin (dB)	Remark
1	2374.130	38.14	-2.34	35.80	54.00	-18.20	AVG
2	2390.000	34.13	-2.28	31.85	54.00	-22.15	AVG

- Note: 1. Result (dBuV/m) = Correct Factor (dB/m) + Reading(dBuV).  
 2. Correction factor (dB/m) = Antenna Factor (dB/m) + Cable loss (dB) – Pre-Amplifier gain (dB).  
 3. When the peak results are less than average limit, so not need to evaluate the average.



Standard:	FCC Part 15.247	Test Distance:	3 m
Test item:	Band edge		
Frequency:	2480 MHz		
Mode:	Mode 2		
Ant.Polar.:	Horizontal		

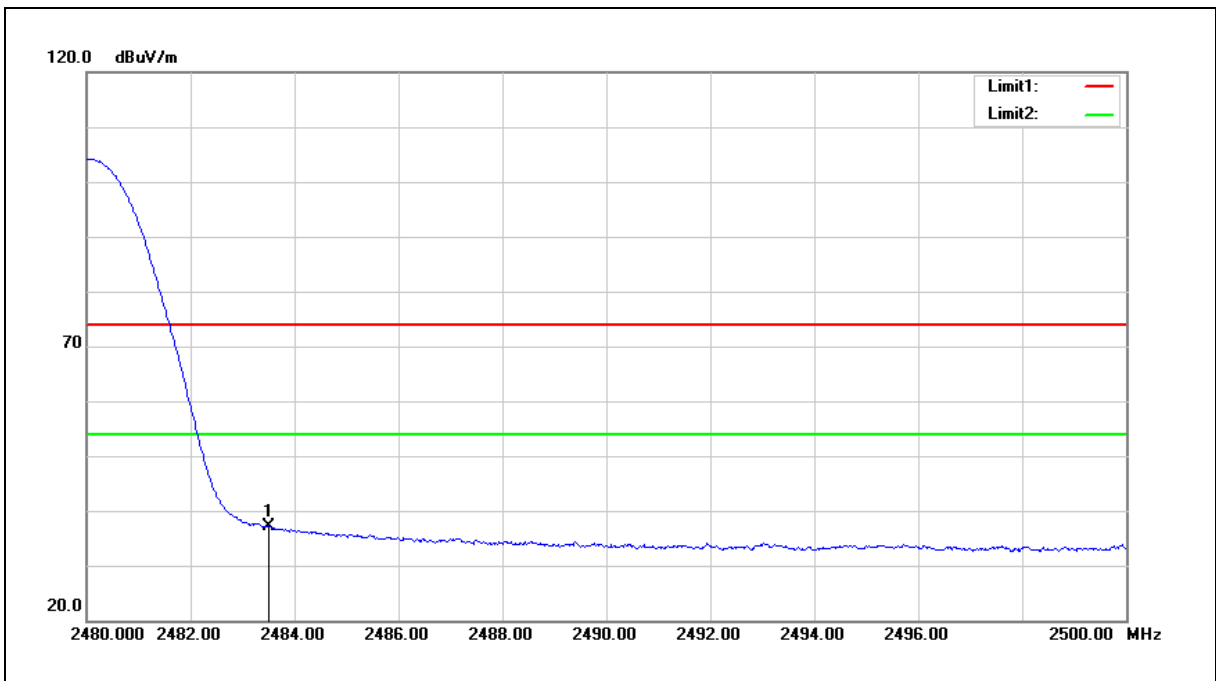

No.	Frequency (MHz)	Reading (dBuV)	Correct Factor (dB/m)	Result (dBuV/m)	Limit (dBuV/m)	Margin (dB)	Remark
1	2483.500	39.13	-1.94	37.19	54.00	-16.81	AVG

Note: 1. Result (dBuV/m) = Correct Factor (dB/m) + Reading (dBuV).

2. Correction factor (dB/m) = Antenna Factor (dB/m) + Cable loss (dB) – Pre-Amplifier gain (dB).

3. When the peak results are less than average limit, so not need to evaluate the average.

Standard:	FCC Part 15.247	Test Distance:	3 m
Test item:	Band edge		
Frequency:	2480 MHz		
Mode:	Mode 2		
Ant.Polar.:	Vertical		

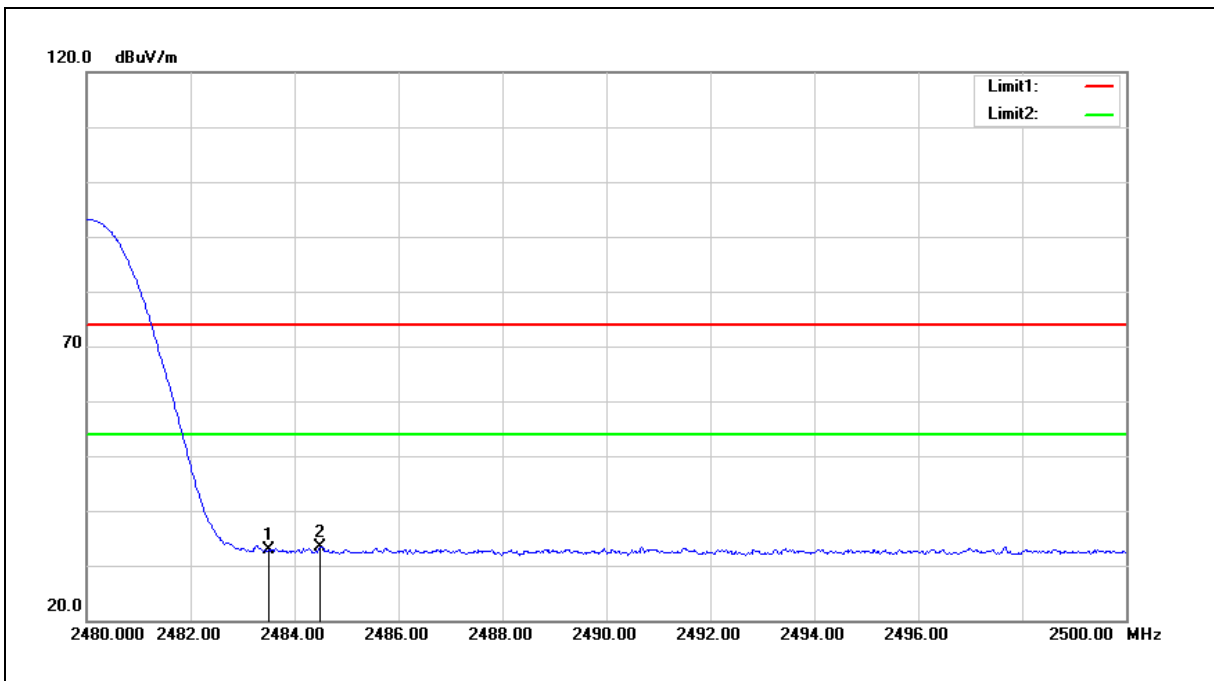

No.	Frequency (MHz)	Reading (dBuV)	Correct Factor (dB/m)	Result (dBuV/m)	Limit (dBuV/m)	Margin (dB)	Remark
1	2483.500	34.86	-1.94	32.92	54.00	-21.08	AVG
2	2484.500	35.36	-1.92	33.44	54.00	-20.56	AVG

Note: 1. Result (dBuV/m) = Correct Factor (dB/m) + Reading (dBuV).

2. Correction factor (dB/m) = Antenna Factor (dB/m) + Cable loss (dB) – Pre-Amplifier gain (dB).

3. When the peak results are less than average limit, so not need to evaluate the average.



Standard:	FCC Part 15.247	Test Distance:	3 m
Test item:	Band edge		
Frequency:	2402 MHz		
Mode:	Mode 3		
Ant.Polar.:	Horizontal		

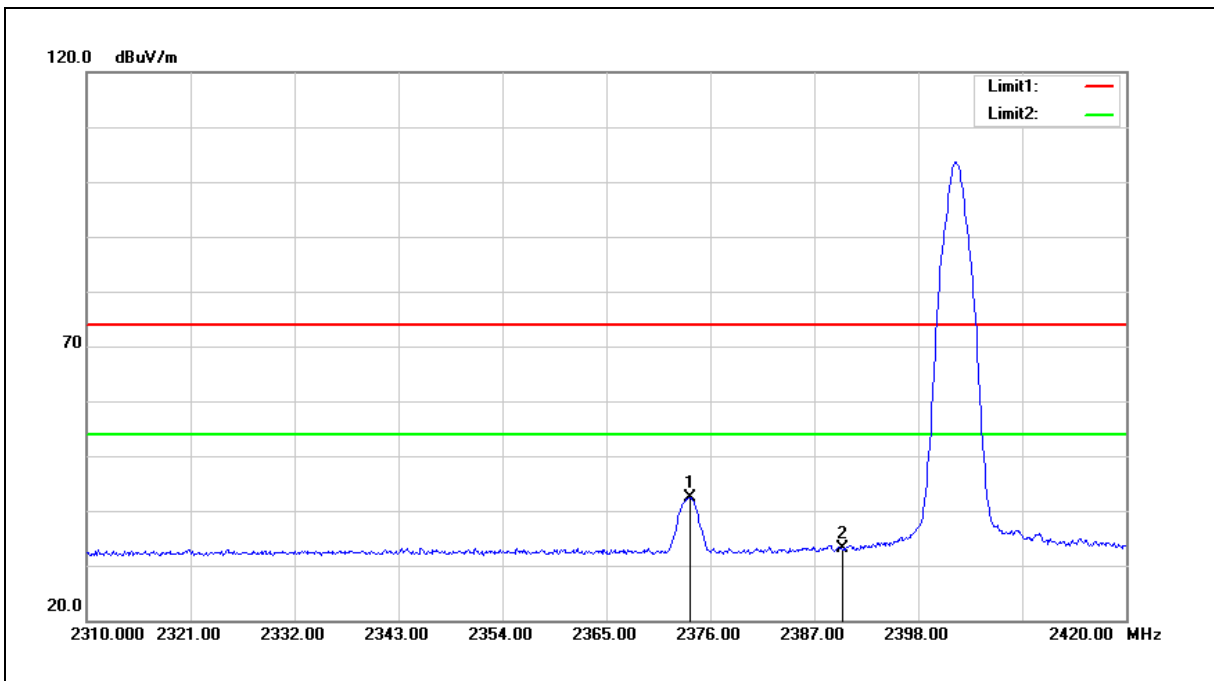

No.	Frequency (MHz)	Reading (dBuV)	Correct Factor (dB/m)	Result (dBuV/m)	Limit (dBuV/m)	Margin (dB)	Remark
1	2373.800	44.81	-2.34	42.47	54.00	-11.53	AVG
2	2390.000	35.41	-2.28	33.13	54.00	-20.87	AVG

Note: 1. Result (dBuV/m) = Correct Factor (dB/m) + Reading(dBuV).

2. Correction factor (dB/m) = Antenna Factor (dB/m) + Cable loss (dB) – Pre-Amplifier gain (dB).

3. When the peak results are less than average limit, so not need to evaluate the average.



Standard:	FCC Part 15.247	Test Distance:	3 m
Test item:	Band edge		
Frequency:	2402 MHz		
Mode:	Mode 3		
Ant.Polar.:	Vertical		

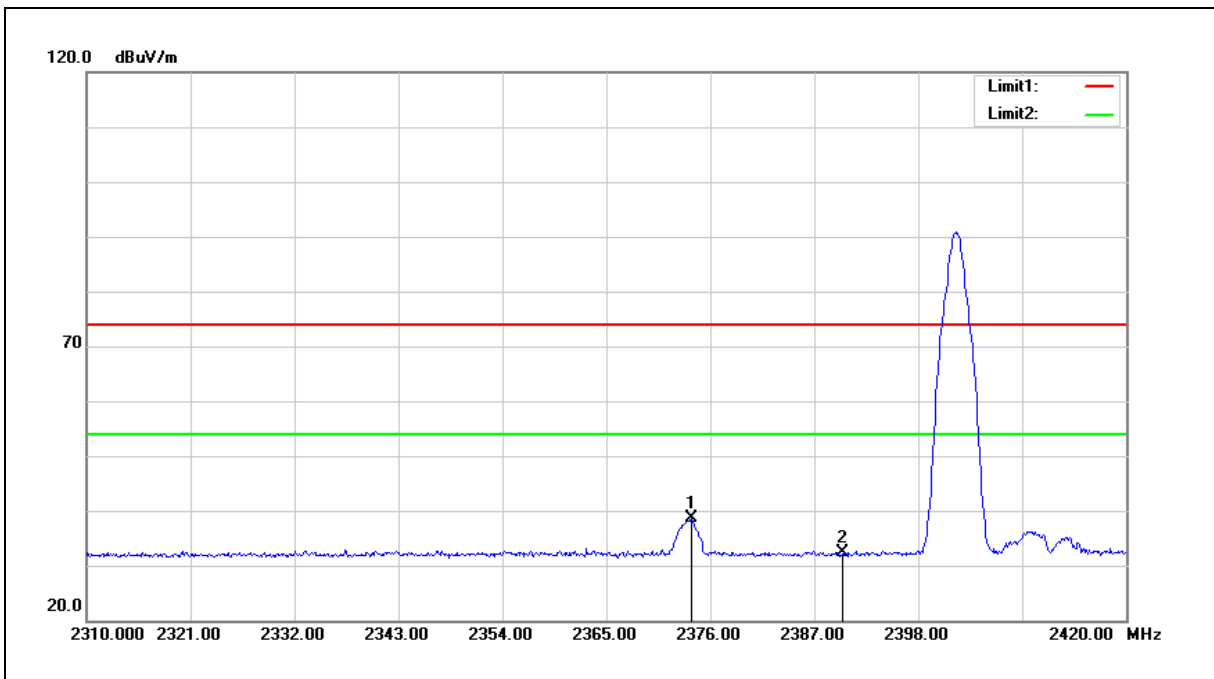

No.	Frequency (MHz)	Reading (dBuV)	Correct Factor (dB/m)	Result (dBuV/m)	Limit (dBuV/m)	Margin (dB)	Remark
1	2374.020	40.94	-2.34	38.60	54.00	-15.40	AVG
2	2390.000	34.65	-2.28	32.37	54.00	-21.63	AVG

Note: 1. Result (dBuV/m) = Correct Factor (dB/m) + Reading(dBuV).

2. Correction factor (dB/m) = Antenna Factor (dB/m) + Cable loss (dB) – Pre-Amplifier gain (dB).

3. When the peak results are less than average limit, so not need to evaluate the average.





Standard:	FCC Part 15.247	Test Distance:	3 m
Test item:	Band edge		
Frequency:	2480 MHz		
Mode:	Mode 3		
Ant.Polar.:	Horizontal		

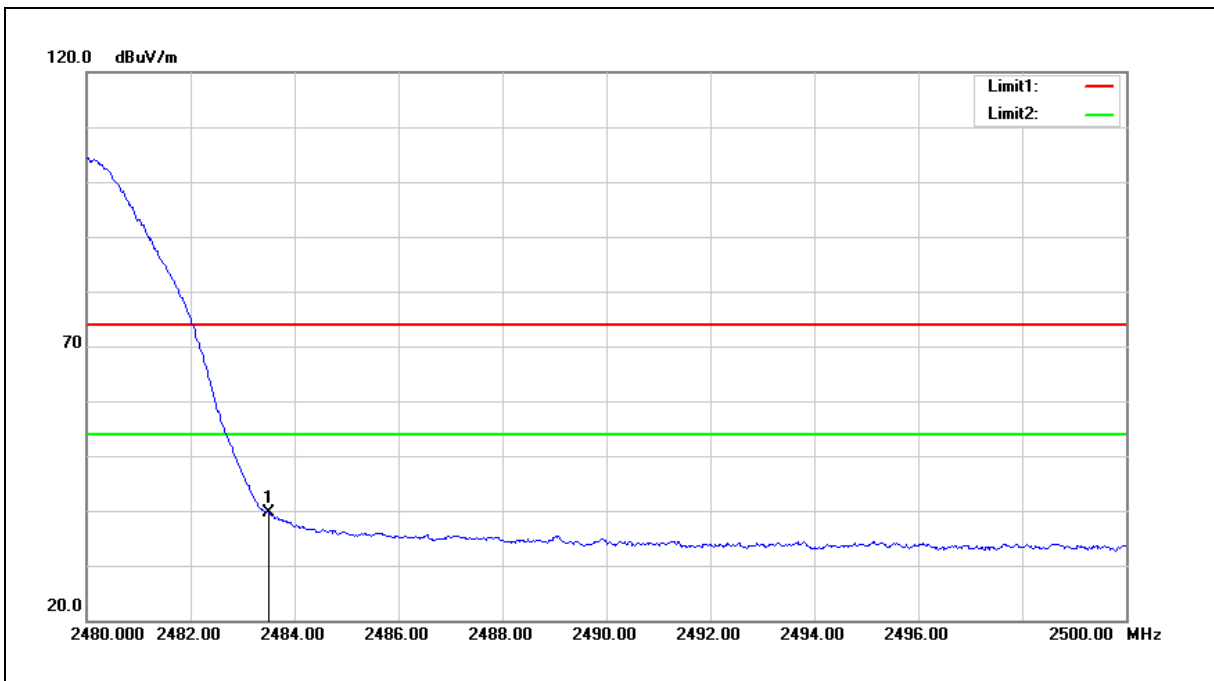

No.	Frequency (MHz)	Reading (dBuV)	Correct Factor (dB/m)	Result (dBuV/m)	Limit (dBuV/m)	Margin (dB)	Remark
1	2483.500	41.61	-1.94	39.67	54.00	-14.33	AVG

- Note: 1. Result (dBuV/m) = Correct Factor (dB/m) + Reading(dBuV).
2. Correction factor (dB/m) = Antenna Factor (dB/m) + Cable loss (dB) – Pre-Amplifier gain (dB).
3. When the peak results are less than average limit, so not need to evaluate the average.



Standard:	FCC Part 15.247	Test Distance:	3 m
Test item:	Band edge		
Frequency:	2480 MHz		
Mode:	Mode 3		
Ant.Polar.:	Vertical		

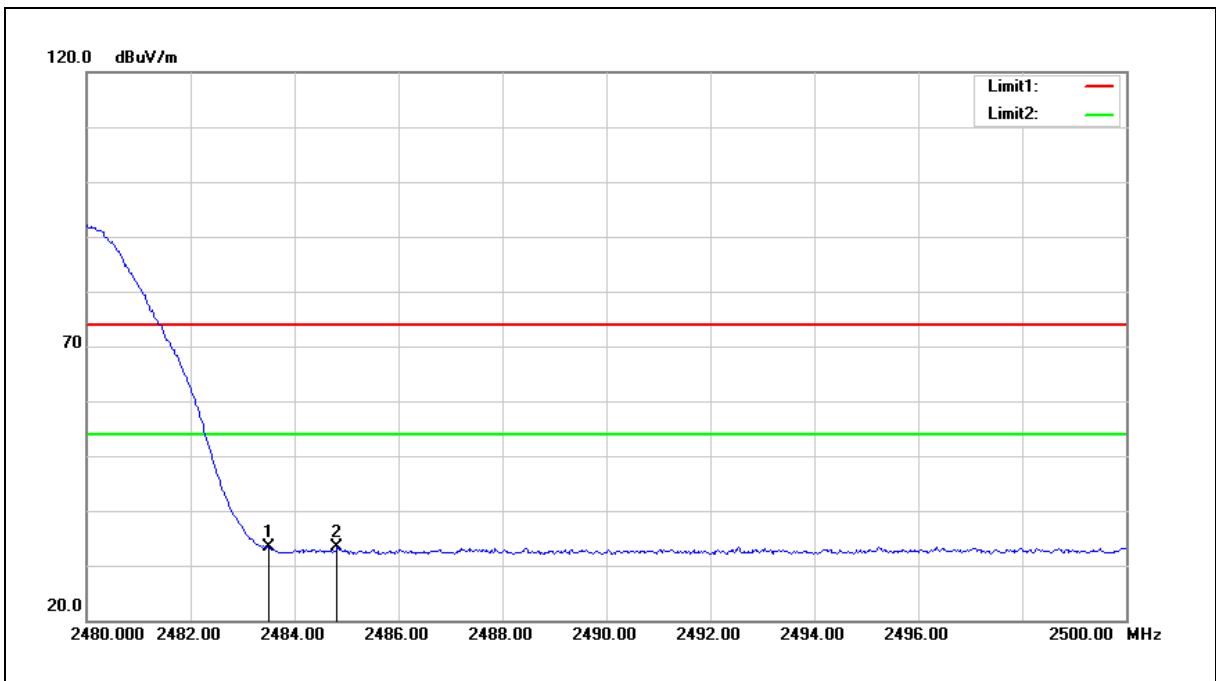

No.	Frequency (MHz)	Reading (dBuV)	Correct Factor (dB/m)	Result (dBuV/m)	Limit (dBuV/m)	Margin (dB)	Remark
1	2483.500	35.33	-1.94	33.39	54.00	-20.61	AVG
2	2484.820	35.30	-1.92	33.38	54.00	-20.62	AVG

Note:1.Result (dBuV/m) = Correct Factor (dB/m) + Reading(dBuV).

2.Correction factor (dB/m) = Antenna Factor (dB/m) + Cable loss (dB) – Pre-Amplifier gain (dB).

3.When the peak results are less than average limit, so not need to evaluate the average.



## 6 EUT Photos

Please refer to the document number: 21-1180\_FCC\_External Photos and 21-1180\_FCC\_Internal Photos.

---END---