

RF Test Report

Applicant : Askey Computer Corp

Product Type : Wi-Fi and Bluetooth functionalities module

Trade Name : ASKEY

Model Number : STI625X

Applicable Standard : FCC 47 CFR PART 15 SUBPART E
ANSI C63.10:2013

Received Date : Aug. 17, 2021

Test Period : Aug. 25 ~ Sep. 10, 2021

Issued Date : Sep. 24, 2021

Issued by

A Test Lab Techno Corp.
No. 140-1, Changan Street, Bade District,
Taoyuan City 33465, Taiwan (R.O.C.)
Tel : +886-3-2710188 / Fax : +886-3-2710190



Taiwan Accreditation Foundation accreditation number: 1330
Frequency Range : 9 kHz to 40 GHz
Test Firm MRA designation number: TW0010

Note:

- 1.The test results are valid only for samples provided by customers and under the test conditions described in this report.
- 2.This report shall not be reproduced except in full, without the written approval of A Test Lab Technology Corporation.
- 3.The relevant information is provided by customers in this test report. According to the correctness, appropriateness or completeness of the information provided by the customer, if there is any doubt or error in the information which affects the validity of the test results, the laboratory does not take the responsibility.



Revision History

| Rev. | Issued Date | Revisions | Revised By |
|------|---------------|---------------|------------|
| 00 | Sep. 24, 2021 | Initial Issue | Snow Wang |
| | | | |
| | | | |
| | | | |

Verification of Compliance

Applicant : Askey Computer Corp

Product Type : Wi-Fi and Bluetooth functionalities module

Trade Name : ASKEY

Model Number : STI625X

FCC ID : H8N-STI625X

EUT Rated Voltage : VBAT DC 3.3 V & VDDIO DC 1.8 V

Test Voltage : 120 Vac / 60 Hz

Applicable Standard : FCC 47 CFR PART 15 SUBPART E
ANSI C63.10:2013

Test Result : Complied

Performing Lab. : A Test Lab Techno Corp.

No. 140-1, Changan Street, Bade District,
Taoyuan City 33465, Taiwan (R.O.C.)
Tel : +886-3-2710188 / Fax : +886-3-2710190



Taiwan Accreditation Foundation accreditation number: 1330
<http://www.atl-lab.com.tw/e-index.htm>

A Test Lab Techno Corp. tested the above equipment in accordance with the requirements set forth in the above standards. All indications of Pass/Fail in this report are opinions expressed by A Test Lab Techno Corp. based on interpretations and/or observations of test results. The test results show that the equipment tested is capable of demonstrating compliance with the requirements as documented in this report.

Approved By :

(Kai Yu Yang)



TABLE OF CONTENTS

| | | |
|----------|--|------------|
| 1 | General Information | 5 |
| 1.1. | Summary of Test Result | 5 |
| 1.2. | Measurement Uncertainty | 6 |
| 2 | EUT Description | 7 |
| 3 | Test Methodology | 11 |
| 3.1. | Mode of Operation..... | 11 |
| 3.2. | EUT Test Step..... | 16 |
| 3.3. | Configuration of Test System Details..... | 17 |
| 3.4. | Test Instruments | 19 |
| 3.5. | Test Site Environment | 20 |
| 4 | Measurement Procedure | 21 |
| 4.1. | AC Power Conducted Emission Measurement | 21 |
| 4.2. | Transmitter Radiated Emissions Measurement..... | 23 |
| 4.3. | Maximum Conducted Output Power Measurement | 28 |
| 4.4. | 26 dB RF Bandwidth Measurement | 29 |
| 4.5. | 6 dB RF Bandwidth Measurement | 30 |
| 4.6. | Maximum Power Spectral Density Measurement..... | 31 |
| 4.7. | Automatically discontinue transmission..... | 33 |
| 4.8. | Antenna Requirement | 33 |
| 5 | Test Results..... | 35 |
| | Annex A. Conducted Emission..... | 35 |
| | Annex B. Radiated Emission Measurement..... | 37 |
| | Annex C. Conducted Test Results..... | 288 |
| 6 | EUT Photos..... | 415 |



1 General Information

1.1. Summary of Test Result

| Standard | Item | Result | Remark |
|------------------------------|--|-----------|--------|
| 15.407(b)(9) 15.207 | AC Power Conducted Emission | PASS | --- |
| 15.407(b) 15.205 / 15.209 | Transmitter Radiated Emissions | PASS | --- |
| 15.407(a) | Maximum Conducted Output Power | PASS | --- |
| 15.407(a) | 26 dB RF Bandwidth | Reference | --- |
| 15.407(e) | 6 dB RF Bandwidth | PASS | --- |
| 15.407(a) | Maximum Power Spectral Density | PASS | --- |
| 15.407(c) | Automatically discontinue transmission | PASS | --- |
| 15.407(a) 15.203 | Antenna Requirement | PASS | --- |

Decision Rule

- Uncertainty is not included.
- Uncertainty is included.

| Standard | Description |
|---------------------------|--|
| CFR47, Part 15, Subpart C | Intentional Radiators |
| CFR47, Part 15, Subpart E | Unlicensed National Information Infrastructure Devices |
| ANSI C63. 10: 2013 | American National Standard of Procedures for Compliance Testing of Unlicensed Wireless Devices |
| KDB789033: D02 | Guidelines for Compliance Testing of Unlicensed National Information Infrastructure (U-NII) Devices Part 15, Subpart E |
| KDB 662911 D01 v02r01 | Emissions Testing of Transmitters with Multiple Outputs in the Same Band (e.g., MIMO, Smart Antenna, etc) |



1.2. Measurement Uncertainty

| sTest Item | Frequency Range | Uncertainty |
|------------------------|-----------------------|----------------------|
| Conducted Emission | 150 kHz ~ 30 MHz | 2.7 dB |
| Radiated Emission | 9 kHz ~ 30 MHz | 2.2 dB |
| | 30 MHz ~ 1000 MHz | 5.1 dB |
| | 1000 MHz ~ 18000 MHz | 5.1 dB |
| | 18000 MHz ~ 26500 MHz | 4.4 dB |
| | 26500 MHz ~ 40000 MHz | 4.6 dB |
| Conducted Output Power | | 1.1 dB |
| RF Bandwidth | | 4.7 % |
| Power Spectral Density | | 1.1 dB |
| Frequency Stability | | 1.3×10^{-7} |
| Duty Cycle | | 1.1 % |
| Time Occupancy | | 1.5 % |



2 EUT Description

| Applicant | Askey Computer Corp 10F, No. 119, JIANKANG RD. ZHONGHE DIST, NEW TAIPEI CITY, Taiwan | | | |
|-------------------|---|-----------------|-----------------------|--------------------|
| Manufacturer | Askey Computer Corp 10F, No. 119, JIANKANG RD. ZHONGHE DIST, NEW TAIPEI CITY, Taiwan | | | |
| Product Type | Wi-Fi and Bluetooth functionalities module | | | |
| Trade Name | ASKEY | | | |
| Model No. | STI625X | | | |
| FCC ID | H8N-STI625X | | | |
| Operate Frequency | Frequency Band | | Frequency Range (MHz) | Number of Channels |
| | IEEE 802.11a | U-NII Band I | 5180 – 5240 | 4 |
| | | U-NII Band II-A | 5260 – 5320 | 4 |
| | | U-NII Band II-C | 5500 – 5700 | 8 |
| | | Straddle band | 5720 | 1 |
| | | U-NII Band III | 5745 – 5825 | 5 |
| | IEEE 802.11n 5 GHz 20 MHz IEEE 802.11ac 20 MHz IEEE 802.11ax 20 MHz | U-NII Band I | 5180 – 5240 | 4 |
| | | U-NII Band II-A | 5260 – 5320 | 4 |
| | | U-NII Band II-C | 5500 – 5700 | 8 |
| | | Straddle band | 5720 | 1 |
| | | U-NII Band III | 5745 – 5825 | 5 |
| | IEEE 802.11n 5 GHz 40 MHz IEEE 802.11ac 40 MHz IEEE 802.11ax 40 MHz | U-NII Band I | 5190 – 5230 | 2 |
| | | U-NII Band II-A | 5270 – 5310 | 2 |
| | | U-NII Band II-C | 5510 – 5670 | 3 |
| | | Straddle band | 5710 | 1 |
| | | U-NII Band III | 5755 – 5795 | 2 |
| | IEEE 802.11ac 80 MHz IEEE 802.11ax 80 MHz | U-NII Band I | 5210 | 1 |
| U-NII Band II-A | | 5290 | 1 | |
| U-NII Band II-C | | 5530 | 1 | |
| Straddle band | | 5690 | 1 | |
| U-NII Band III | | 5775 | 1 | |
| Modulation Type | OFDM/OFDMA | | | |



| Antenna information | ANT | Model Number | Type | Max. Gain (dBi) | |
|---------------------|-----------------------|--------------|----------------|-----------------|-------------|
| | Antenna information | ANT-0 | STI6250-D315 | Dipole Antenna | 5150 - 5250 |
| 5250 - 5350 | | | | | 4.61 |
| 5470 - 5725 | | | | | 3.74 |
| 5725 - 5850 | | | | | 3.96 |
| ANT-1 | | STI6250-D315 | Dipole Antenna | 5150 - 5250 | 3.58 |
| | | | | 5250 - 5350 | 3.33 |
| | | | | 5470 - 5725 | 4.38 |
| | | | | 5725 - 5850 | 5.21 |
| Antenna Delivery | Reference section 3.1 | | | | |
| Operate Temp. Range | 0 ~ 40 °C | | | | |



| Frequency Band | | RF Output Power (W) |
|---------------------------|-----------------|---------------------|
| IEEE 802.11a | U-NII Band I | 0.060 |
| | U-NII Band II-A | 0.064 |
| | U-NII Band II-C | 0.110 |
| | U-NII Band III | 0.110 |
| IEEE 802.11n 5 GHz 20 MHz | U-NII Band I | 0.066 |
| | U-NII Band II-A | 0.067 |
| | U-NII Band II-C | 0.073 |
| | U-NII Band III | 0.108 |
| IEEE 802.11ac 20 MHz | U-NII Band I | 0.045 |
| | U-NII Band II-A | 0.048 |
| | U-NII Band II-C | 0.056 |
| | U-NII Band III | 0.060 |
| IEEE 802.11ax 20 MHz | U-NII Band I | 0.067 |
| | U-NII Band II-A | 0.068 |
| | U-NII Band II-C | 0.088 |
| | U-NII Band III | 0.111 |
| IEEE 802.11n 5 GHz 40 MHz | U-NII Band I | 0.046 |
| | U-NII Band II-A | 0.050 |
| | U-NII Band II-C | 0.088 |
| | U-NII Band III | 0.061 |
| IEEE 802.11ac 40 MHz | U-NII Band I | 0.015 |
| | U-NII Band II-A | 0.016 |
| | U-NII Band II-C | 0.028 |
| | U-NII Band III | 0.033 |
| IEEE 802.11ax 40 MHz | U-NII Band I | 0.068 |
| | U-NII Band II-A | 0.069 |
| | U-NII Band II-C | 0.092 |
| | U-NII Band III | 0.111 |
| IEEE 802.11ac 80 MHz | U-NII Band I | 0.047 |
| | U-NII Band II-A | 0.050 |
| | U-NII Band II-C | 0.091 |
| | U-NII Band III | 0.062 |
| IEEE 802.11ax 80 MHz | U-NII Band I | 0.015 |
| | U-NII Band II-A | 0.016 |
| | U-NII Band II-C | 0.030 |
| | U-NII Band III | 0.033 |



| Equipment Type | | |
|------------------------------------|---------------------|-----|
| Outdoor access point | point-to-point | --- |
| | point-to-multipoint | --- |
| Indoor access point | | --- |
| Fixed point-to-point access points | | --- |
| Client devices | | V |

3 Test Methodology

3.1. Mode of Operation

Decision of Test ATL has verified the construction and function in typical operation. All the test modes were carried out with the EUT in normal operation, which was shown in this test report and defined as:

| Pre-Test Mode |
|--|
| Mode 1: Transmit mode |
| Mode 2: IEEE 802.11a Continuous TX Mode |
| Mode 3: IEEE 802.11n 5 GHz 20 MHz Continuous TX Mode |
| Mode 4: IEEE 802.11n 5 GHz 40 MHz Continuous TX Mode |
| Mode 5: IEEE 802.11ac 20 MHz Continuous TX Mode |
| Mode 6: IEEE 802.11ac 40 MHz Continuous TX Mode |
| Mode 7: IEEE 802.11ac 80 MHz Continuous TX Mode |
| Mode 8: IEEE 802.11ax 20 MHz Continuous TX Mode |
| Mode 9: IEEE 802.11ax 40 MHz Continuous TX Mode |
| Mode 10: IEEE 802.11ax 80 MHz Continuous TX Mode |

| Final-Test Mode |
|--|
| Mode 1: Transmit mode |
| Mode 2: IEEE 802.11a Continuous TX mode |
| Mode 8: IEEE 802.11ax 20 MHz Continuous TX Mode |
| Mode 9: IEEE 802.11ax 40 MHz Continuous TX Mode |
| Mode 10: IEEE 802.11ax 80 MHz Continuous TX Mode |

Software used to control the EUT for staying in continuous transmitting mode was programmed.

After verification, all tests were carried out with the worst case test modes.

| Test Mode | ANT-0 | ANT-1 | ANT-0+1 |
|-----------|-------|-------|---------|
| Mode 2 | V | V | V |
| Mode 3 | V | V | V |
| Mode 4 | V | V | V |
| Mode 5 | V | V | V |
| Mode 6 | V | V | V |
| Mode 7 | V | V | V |
| Mode 8 | V | V | V |
| Mode 9 | V | V | V |
| Mode 10 | V | V | V |



| Test Mode | Antenna Delivery | Data Rate (Mbps) | Band | Test Channel |
|-----------|------------------|------------------|-----------------|--------------------|
| Mode 2 | 2TX (CDD) | 6 | U-NII Band I | 36, 40, 48 |
| | | | U-NII Band II-A | 52, 56, 64 |
| | | | U-NII Band II-C | 100, 112, 140, 144 |
| | | | U-NII Band III | 144, 149, 157, 165 |
| Mode 3 | 2TX (CDD) | 13 | U-NII Band I | 36, 40, 48 |
| | | | U-NII Band II-A | 52, 56, 64 |
| | | | U-NII Band II-C | 100, 112, 140, 144 |
| | | | U-NII Band III | 144, 149, 157, 165 |
| Mode 4 | 2TX (CDD) | 27 | U-NII Band I | 38, 46 |
| | | | U-NII Band II-A | 54, 62 |
| | | | U-NII Band II-C | 102, 110, 134, 142 |
| | | | U-NII Band III | 142, 151, 159 |
| Mode 5 | 2TX (CDD) | 13 | U-NII Band I | 36, 40, 48 |
| | | | U-NII Band II-A | 52, 56, 64 |
| | | | U-NII Band II-C | 100, 112, 140, 144 |
| | | | U-NII Band III | 144, 149, 157, 165 |
| Mode 6 | 2TX (CDD) | 27 | U-NII Band I | 38, 46 |
| | | | U-NII Band II-A | 54, 62 |
| | | | U-NII Band II-C | 102, 110, 134, 142 |
| | | | U-NII Band III | 142, 151, 159 |
| Mode 7 | 2TX (CDD) | 58.6 | U-NII Band I | 42 |
| | | | U-NII Band II-A | 58 |
| | | | U-NII Band II-C | 106, 138 |
| | | | U-NII Band III | 138, 155 |
| Mode 8 | 2TX (CDD) | MCS 0 | U-NII Band I | 36, 40, 48 |
| | | | U-NII Band II-A | 52, 56, 64 |
| | | | U-NII Band II-C | 100, 112, 140, 144 |
| | | | U-NII Band III | 144, 149, 157, 165 |
| Mode 9 | 2TX (CDD) | MCS 0 | U-NII Band I | 38, 46 |
| | | | U-NII Band II-A | 54, 62 |
| | | | U-NII Band II-C | 102, 110, 134, 142 |
| | | | U-NII Band III | 142, 151, 159 |
| Mode 10 | 2TX (CDD) | MCS 0 | U-NII Band I | 42 |
| | | | U-NII Band II-A | 58 |
| | | | U-NII Band II-C | 106, 138 |
| | | | U-NII Band III | 138, 155 |



Duty cycle

| Test Mode | Frequency (MHz) | on time (ms) | on+off time (ms) | Duty cycle | Duty Factor (dB) | 1/T Minimum VBW (kHz) |
|-----------|-----------------|--------------|------------------|------------|------------------|-----------------------|
| Mode 2 | 5180 | 2.080 | 2.085 | 0.998 | 0.010 | 0.010 |
| Mode 8 | 5180 | 1.500 | 1.505 | 0.997 | 0.014 | 0.010 |
| Mode 9 | 5190 | 1.257 | 1.260 | 0.998 | 0.010 | 0.010 |
| Mode 10 | 5210 | 1.861 | 1.868 | 0.996 | 0.016 | 0.010 |

Duty Cycle Graphs

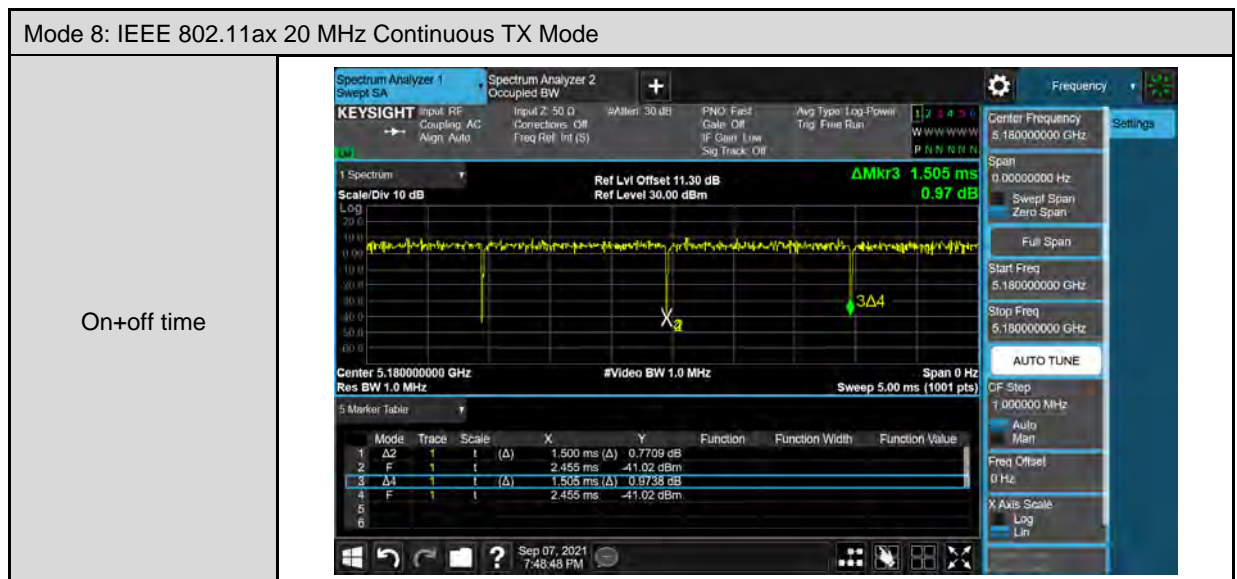
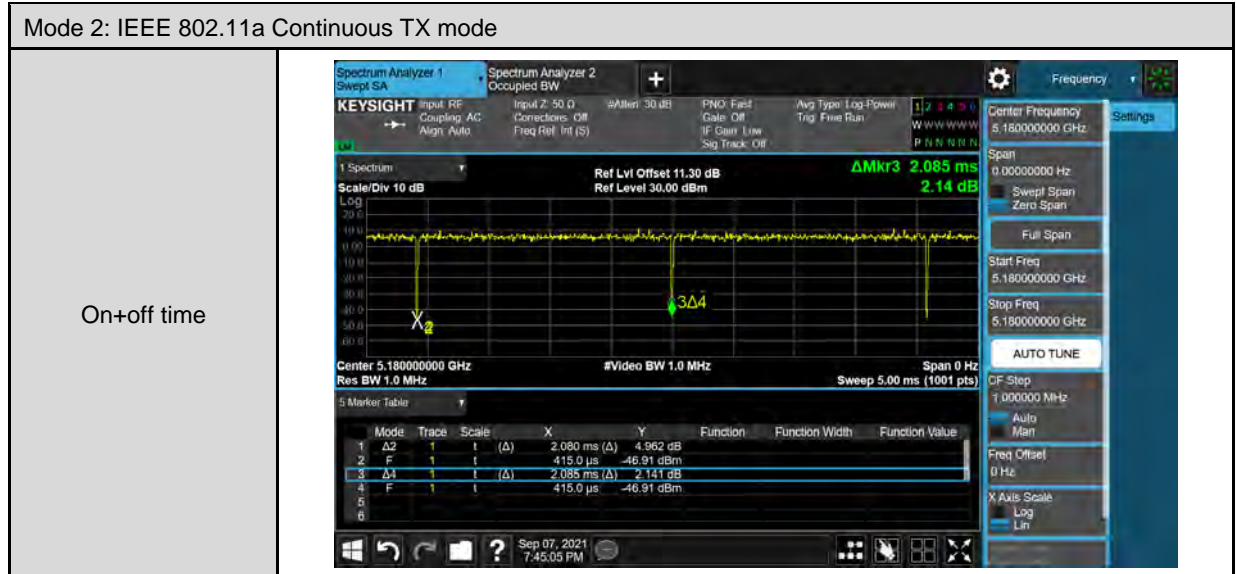

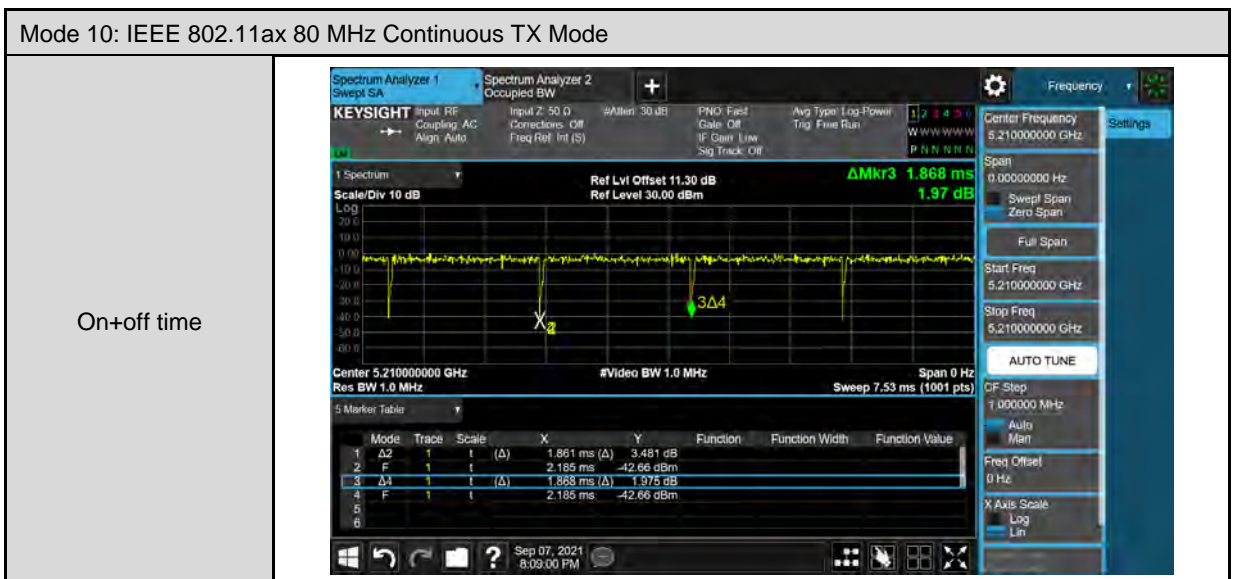
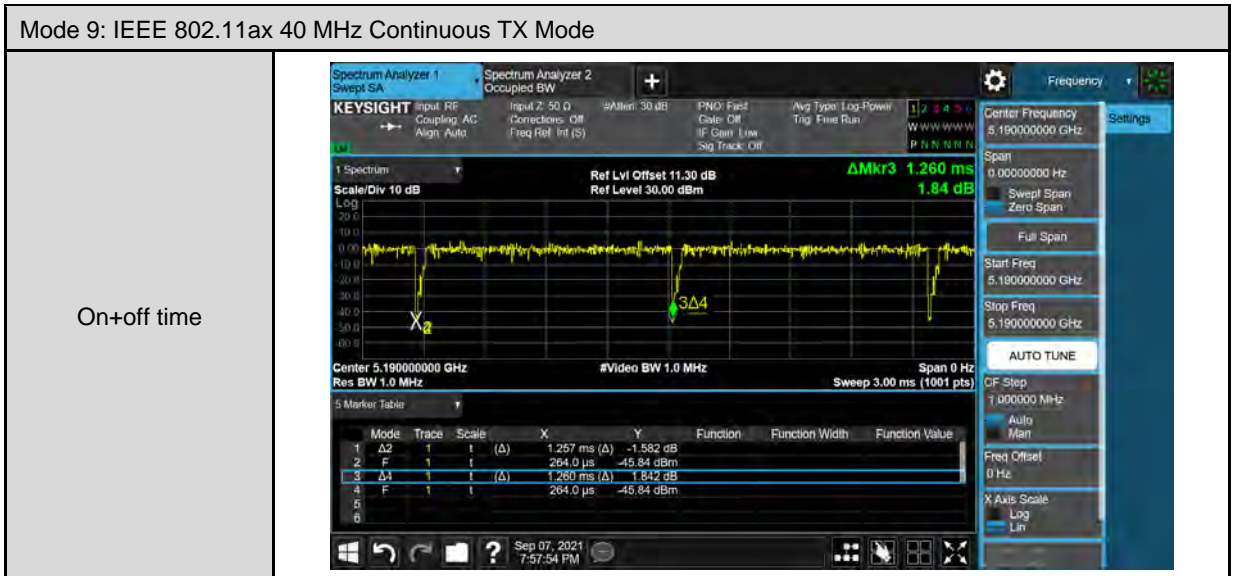



3.2. EUT Test Step

The EUT is operated in the engineering mode to fix the TX frequency for the purposes of measurement. According to its specifications, the EUT must comply with the requirements of Section 15.407 under the FCC Rules Part 15 Subpart E.

| | |
|----|--|
| 1. | Setup the EUT shown on "Configuration of Test System Details". |
| 2. | Turn on the power of all equipment. |
| 3. | Turn on TX function. |
| 4. | EUT run test program. |

| Measurement Software | | | |
|----------------------|--------------------|----------|---------|
| No. | Description | Software | Version |
| 1 | Conducted Emission | EZ EMC | 1.1.4.3 |
| 2 | Radiated Emission | EZ EMC | 1.1.4.4 |

3.3. Configuration of Test System Details

Conducted Emission

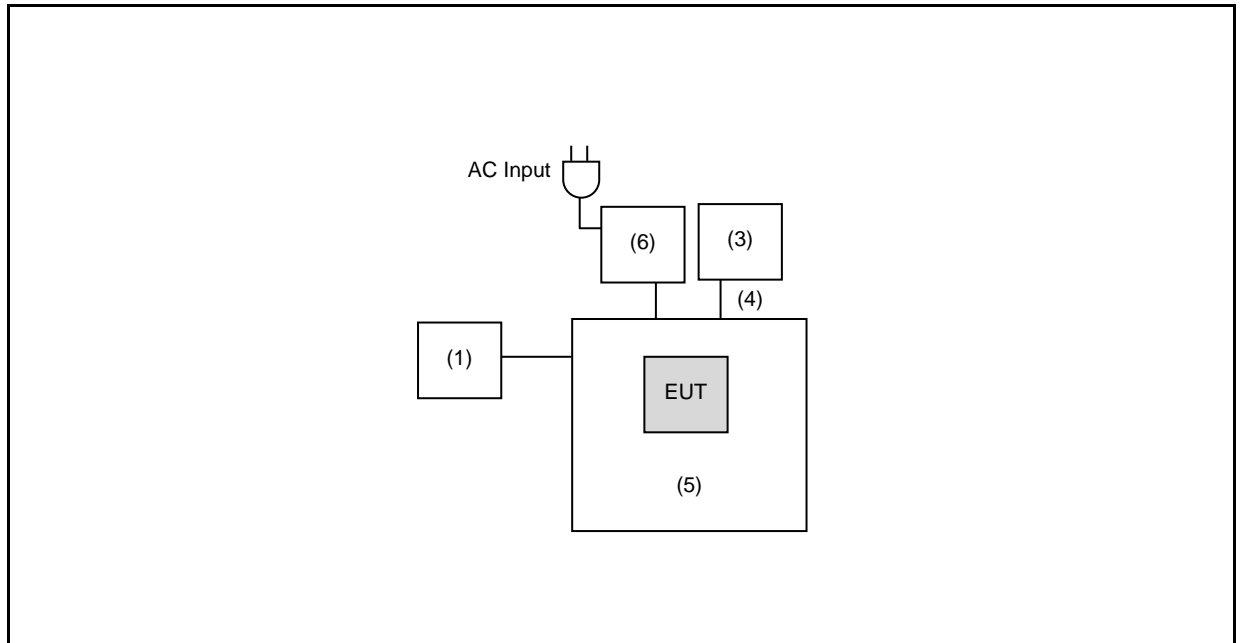

Radiated Emission

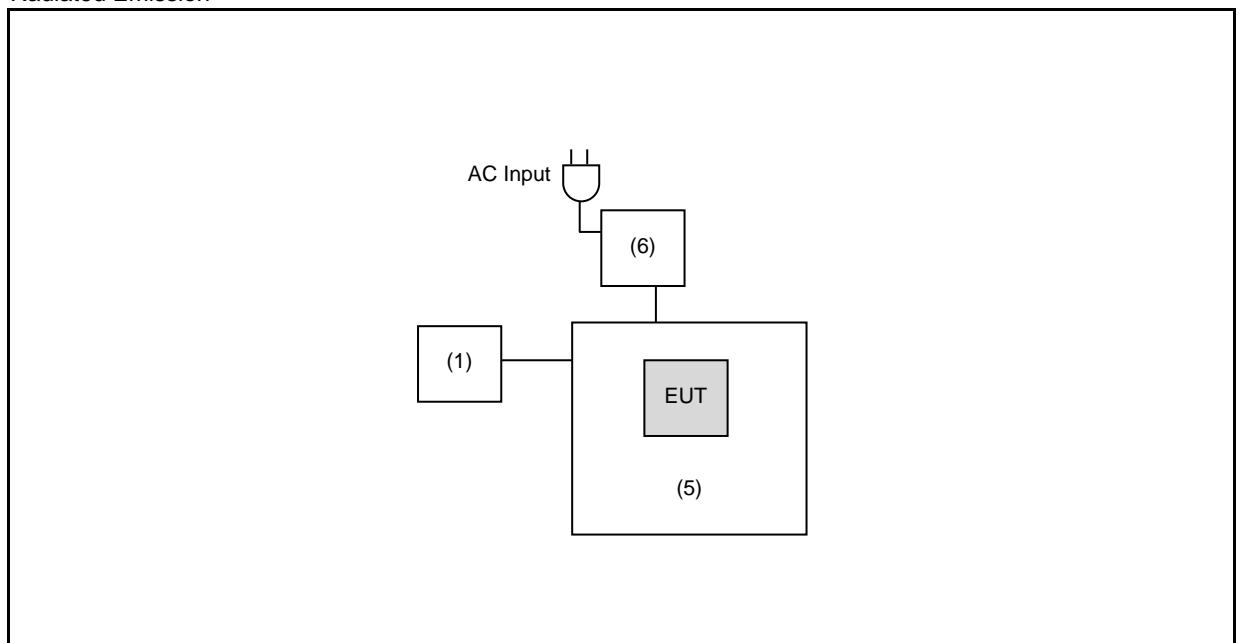



| Devices Description | | | | | |
|---------------------|-------------|--------------|--------------|------------------------|------------|
| | Product | Manufacturer | Model Number | Serial Number | Power Cord |
| (1) | Notebook | acer | N19C1 | NXEG8TA008109033BD3400 | --- |
| (2) | AC Adapter | chiicony | A18-045N2A | --- | --- |
| (3) | LCD Monitor | ViewSonic | VS16861 | UZJ195120842 | --- |
| (4) | HDMI Cable | Avier | K48GHS | --- | --- |
| (5) | Fixture | Askey | STI625x | --- | --- |
| (6) | AC Adapter | Delta | ADP-90WH KBA | --- | --- |



3.4. Test Instruments

For Conducted Emission

Test Period: Sep. 09, 2021

Testing Engineer: Andy Lu

| Equipment | Manufacturer | Model Number | Serial Number | Cal. Date | Cal. Period |
|---------------|--------------|----------------|---------------|------------|-------------|
| Test Receiver | R&S | ESCI | 100367 | 05/21/2021 | 1 year |
| LISN | R&S | ENV216 | 101040 | 03/29/2021 | 1 year |
| LISN | R&S | ENV216 | 101041 | 04/08/2021 | 1 year |
| RF Cable | Woken | 00100D1380194M | TE-02-03 | 05/28/2021 | 1 year |

For Radiated Emissions

Test Period: Aug. 25 ~ Sep. 07, 2021

Testing Engineer: Hung Chou, Eva.Lee, Pink Li, Ida Chuang, Marc.Yeh, Nat Wu, Js Liao

| Equipment | Manufacturer | Model Number | Serial Number | Cal. Date | Cal. Period |
|------------------------------------|--------------------------------|-----------------------|---------------|------------|-------------|
| Spectrum Analyzer (2 Hz~50 GHz) | Keysight | N9030B | MY57143537 | 04/19/2021 | 1 year |
| Pre Amplifier (100 kHz~1.3 GHz) | Agilent | 8447D | 2944A11119 | 01/15/2021 | 1 year |
| Pre Amplifier (1~26.5 GHz) | Agilent | 8449B | 3008A02237 | 10/21/2020 | 1 year |
| Pre Amplifier (26.5~40 GHz) | EMCI | EMC2654045 | 980028 | 08/19/2021 | 1 year |
| Broadband Antenna | Schwarzbeck | VULB9168 | 01146 | 07/19/2021 | 1 year |
| Horn Antenna (1~18 GHz) | SCHWARZBECK MESS-ELEKTRONIK | BBHA9120D | 02207 | 07/09/2021 | 1 year |
| Horn Antenna (18~40 GHz) | ETS | 3116 | 00086467 | 12/03/2020 | 1 year |
| Coaxial Cable | Titan | T0710AT327A10A 100 | J11005 | 08/06/2021 | 1 year |
| Coaxial Cable | Titan | T0710AT327A10A 900 | J11004 | 08/06/2021 | 1 year |
| Coaxial Cable | Titan | T0712AT340A12A 900 | J11002 | 08/06/2021 | 1 year |

Note: N.C.R. = No Calibration Request.



For Conducted

Test Period: Sep. 07, ~ Sep. 10, 2021

Testing Engineer: Brian Lin, Andy Lu

| Equipment | Manufacturer | Model Number | Serial Number | Cal. Date | Cal. Period |
|-------------------|--------------|--------------|---------------|------------|-------------|
| Power Sensor | Anritsu | MA2411B | 1126022 | 09/03/2021 | 1 year |
| Power Meter | Anritsu | ML2495A | 1135009 | 09/03/2021 | 1 year |
| Spectrum Analyzer | Keysight | N9010B | MY59071418 | 03/17/2021 | 1 year |

Note: N.C.R. = No Calibration Request.

3.5. Test Site Environment

| Items | Required (IEC 60068-1) | Actual |
|------------------|------------------------|--------|
| Temperature (°C) | 15-35 | 20-30 |
| Humidity (%RH) | 25-75 | 45-75 |

4 Measurement Procedure

4.1. AC Power Conducted Emission Measurement

■ Limit

| Frequency (MHz) | Quasi-peak | Average |
|-----------------|------------|----------|
| 0.15 - 0.5 | 66 to 56 | 56 to 46 |
| 0.50 - 5.0 | 56 | 46 |
| 5.0 - 30.0 | 60 | 50 |

■ Test Setup

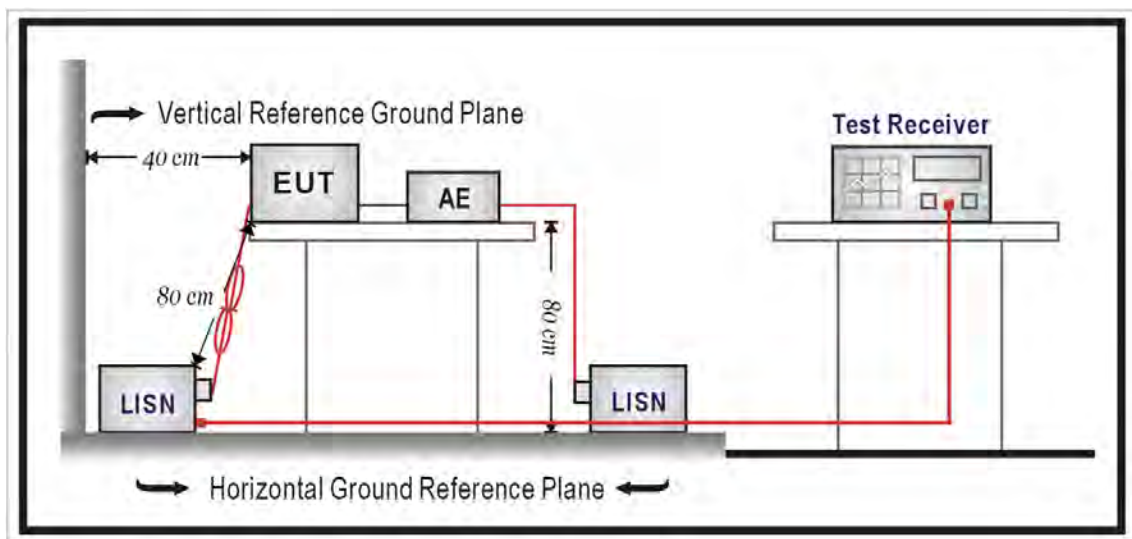

■ Test Procedure

The EUT and simulators are connected to the main power through a line impedance stabilization network (L.I.S.N.). This provides a $50 \Omega // 50 \mu\text{H}$ coupling impedance for the measuring equipment. The peripheral devices are also connected to the main power through a LISN that provides a $50 \Omega // 50 \mu\text{H}$ coupling impedance with 50 ohm termination.

Tabletop device shall be placed on a non-conducting platform, of nominal size 1 m by 1.5 m, raised 80 cm above the reference ground plane. The wall of screened room shall be located 40 cm to the rear of the EUT. Other surfaces of tabletop or floor standing EUT shall be at least 80 cm from any other ground conducting surface including one or more LISNs. For floor-standing device shall be placed under the EUT with a 12 mm insulating material.

Conducted emissions were investigated over the frequency range from 0.15 MHz to 30 MHz using a resolution bandwidth of 9 kHz. The equipment under test (EUT) shall be meet the limits in section 4.1, as applicable, including the average limit and the quasi-peak limit when using respectively, an average detector and quasi-peak detector measured in accordance with the methods described of related standard. When all of peak value were complied with quasi-peak and average limit from 150 kHz to 30 MHz then quasi-peak and average measurement was unnecessary.

The AMN shall be placed 0.8 m from the boundary of the unit under test and bonded to a ground reference plane for AMNs mounted on top of the ground reference plane. This distance is between the closest points of the AMN and the EUT. All other units of the EUT and associated equipment shall be at least 0.8 m from the AMN. If the mains power cable is longer than 1 m then the cable shall be folded back and forth at the centre of the lead to form a bundle no longer than 0.4 m. All of interconnecting cables that hang closer than 40 cm to the ground plane shall be folded back and forth in the center forming a bundle 30 cm to 40 cm long. All of EUT and AE shall be separate place more than 0.1 m. All 50Ω ports of the LISN shall be resistively terminated into 50Ω loads when not connected to the measuring instrument.

If the reading of the measuring receiver shows fluctuations close to the limit, the reading shall be observed for at least 15 s at each measurement frequency; the higher reading shall be recorded with the exception of any brief isolated high reading which shall be ignored

4.2. Transmitter Radiated Emissions Measurement

■ Limit

(1)Undesirable emission limits. Except as shown in paragraph (b)(9) of this section, the maximum emissions outside of the frequency bands of operation shall be attenuated in accordance with the following limits:

(a)For transmitters operating in the 5.15-5.25 GHz band: All emissions outside of the 5.15-5.35 GHz band shall not exceed an e.i.r.p. of -27 dBm/MHz.

(b)For transmitters operating in the 5.25-5.35 GHz band: All emissions outside of the 5.15-5.35 GHz band shall not exceed an e.i.r.p. of -27 dBm/MHz.

(c)For transmitters operating in the 5.47-5.725 GHz band: All emissions outside of the 5.47-5.725 GHz band shall not exceed an e.i.r.p. of -27 dBm/MHz.

(d)For transmitters operating in the 5.725-5.85 GHz band:

(i)All emissions shall be limited to a level of -27 dBm/MHz at 75 MHz or more above or below the band edge increasing linearly to 10 dBm/MHz at 25 MHz above or below the band edge, and from 25 MHz above or below the band edge increasing linearly to a level of 15.6 dBm/MHz at 5 MHz above or below the band edge, and from 5 MHz above or below the band edge increasing linearly to a level of 27 dBm/MHz at the band edge.

| EIRP (dBm) | Field Strength at 3 m(dBuV/m) |
|------------|-------------------------------|
| -27 | 68.3 |

(2)Limits of Radiated Emission Measurement

Emissions radiated outside of the specified bands, shall be according to the general radiated limits in 15.209 as following:

| Frequency Range (MHz) | Field Strength (microvolts/meter) | Measurement Distance (meters) |
|-----------------------|-----------------------------------|-------------------------------|
| 0.009 ~ 0.490 | 2400/F(kHz) | 300 |
| 0.490 ~ 1.705 | 24000/F(kHz) | 30 |
| 1.705 ~ 30.0 | 30 | 30 |
| 30 ~ 88 | 10 | 3 |
| 88 ~ 216 | 150 | 3 |
| 216 ~ 960 | 200 | 3 |
| Above 960 | 500 | 3 |

Note: 1. The lower limit shall apply at the transition frequencies.

2. Emission level (dBuV/m) = 20 log Emission level (uV/m).

3. As shown in 15.35(b), for frequencies above 1000 MHz, the field strength limits are based on average detector, however, the peak field strength of any emission shall not exceed the maximum permitted average limits, specified above by more than 20 dB under any condition of modulation.

■ Setup

9 kHz ~ 30 MHz

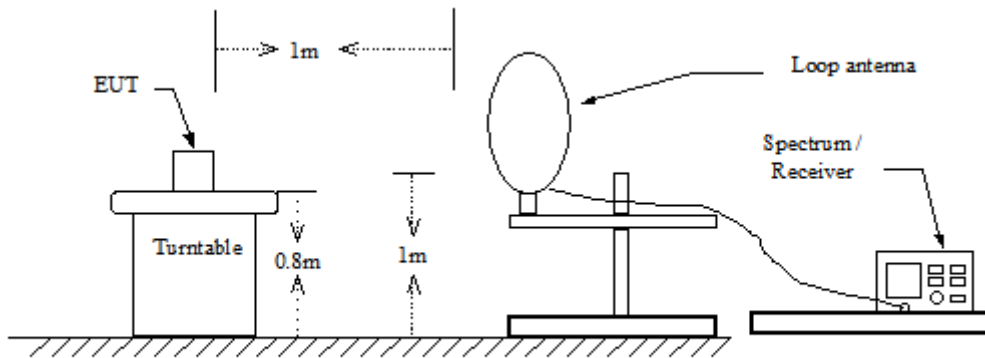

30 MHz ~ 1 GHz

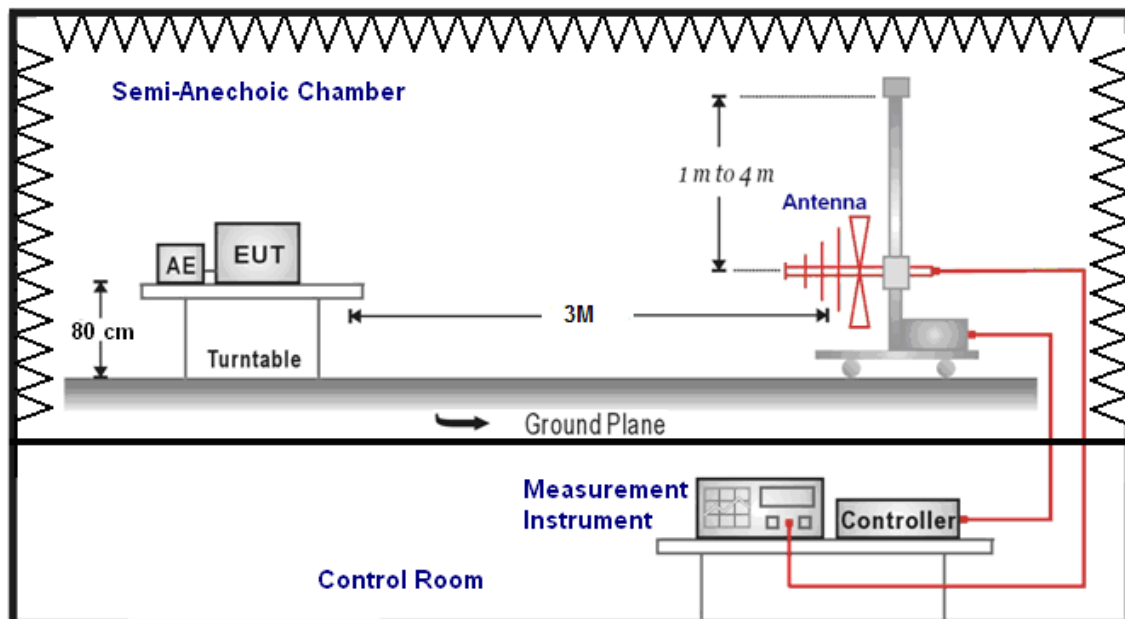

Above 1 GHz

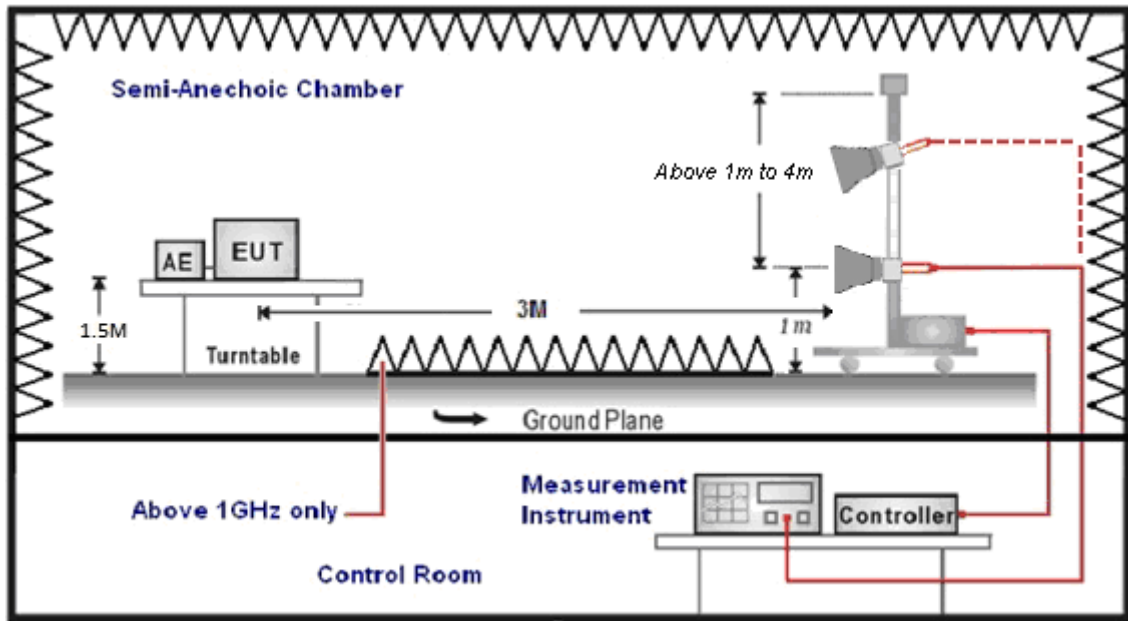

■ Test Procedure

Final radiation measurements were made on a three-meter, Semi Anechoic Chamber. The EUT system was placed on a nonconductive turntable which is 0.8 or 1.5 meters height (below 1 GHz use 0.8 m turntable / above 1 GHz use 1.5 m turntable), top surface 1.0 x 1.5 meter. The spectrum was examined from 250 MHz to 2.5 GHz in order to cover the whole spectrum below 10th harmonic which could generate from the EUT. During the test, EUT was set to transmit continuously & Measurements spectrum range from 9 kHz to 40 GHz is investigated.

For measurements below 1 GHz the resolution bandwidth is set to 100 kHz for peak detection measurements or 120 kHz for quasi-peak detection measurements. Peak detection is used unless otherwise noted as quasi-peak.

For restricted measurements above 1 GHz the resolution bandwidth is set to 1 MHz, and then the video bandwidth is set to 3 MHz for peak measurements and 10 Hz for average measurements when Duty cycle > 0.98 / 1/T for average measurements when Duty cycle < 0.98.

For out of band measurements above 1 GHz the resolution bandwidth is set to 1 MHz, and then the video bandwidth is set to 3 MHz for peak measurements.

A nonconductive material surrounded the EUT to supporting the EUT for standing on three orthogonal planes. At each condition, the EUT was rotated 360 degrees, and the antenna was raised and lowered from one to four meters to find the maximum emission levels. Measurements were taken using both horizontal and vertical antenna polarization.

SCHWARZBECK MESS-ELEKTRONIK Trilog-Broadband Antenna at 3 Meter and the ETS-Lindgren Double-Ridged Waveguide Horn antenna Schwarzbeck Mess-Elektronik Broadband Horn Antenna was used in frequencies 1 – 40 GHz at a distance of 3 meter. The antenna at an angle toward the source of the emission. All test results were extrapolated to equivalent signal at 3 meters utilizing an inverse linear distance extrapolation Factor (20 dB/decade).

For testing above 1 GHz, the emission level of the EUT in peak mode was 20 dB lower than average limit (that means the emission level in peak mode also complies with the limit in average mode), then testing will be stopped and peak values of EUT will be reported, otherwise, the emissions will be measured in average mode again and reported.

Appropriate preamplifiers were used for improving sensitivity and precautions were taken to avoid overloading or desensitizing the spectrum analyzer. No post – detector video filters were used in the test.

The spectrum analyzer's 6 dB bandwidth was set to 1 MHz, and the analyzer was operated in the peak detection mode, for frequencies both below and up 1 GHz. The average levels were obtained by subtracting the duty cycle correction factor from the peak readings.

The following procedures were used to convert the emission levels measured in decibels referenced to 1 microvolt (dBuV) into field intensity in micro volts per meter (uV/m).

The actual field intensity in decibels referenced to 1 microvolt in to field intensity in micro volts per meter (dBuV/m).

Data of measurement within this frequency range without mark in the table above means the reading of emissions are attenuated more than 20 dB below the permissible limits or the field strength is too small to be measured.



The actual field is intensity in referenced to 1 microvolt per meter (dBuV/m) is determined by algebraically adding the measured reading in dBuV, the antenna factor (dB), and cable loss (dB) and Subtracting the gain of preamplifier (dB) is auto calculate in spectrum analyzer.

(1) $\text{Amplitude (dBuV/m)} = \text{FI (dBuV)} + \text{AF (dBuV)} + \text{CL (dBuV)} - \text{Gain (dB)}$

FI= Reading of the field intensity.

AF= Antenna factor.

CL= Cable loss.

P.S Amplitude is auto calculate in spectrum analyzer.

(2) $\text{Actual Amplitude (dBuV/m)} = \text{Amplitude (dBuV)} - \text{Dis(dB)}$

The FCC specified emission limits were calculated according the EUT operating frequency and by following linear interpolation equations:

(a) For fundamental frequency : Transmitter Output < +30 dBm

(b) For spurious frequency : Spurious emission limits = fundamental emission limit /10

Measuring Instruments and setting

The following table is the setting of spectrum analyzer and receiver.

| Spectrum Parameter | Setting |
|--|---|
| Attenuation | Auto |
| Start Frequency | 1000 MHz |
| Stop Frequency | 40 GHz |
| RBW/VBW(Emission in restricted band) | 1 MHz / 3 MHz for Peak 1 MHz / (1/T) for Average |
| RBW/VBW(Emission in non-restricted band) | 1 MHz / 3 MHz for Peak |

4.3. Maximum Conducted Output Power Measurement

■ **Limit**

| Frequency Range (MHz) | FCC Maximum Conducted Output Power Limit |
|-----------------------|--|
| | Client |
| 5.150 ~ 5.250 GHz | The lesser of 250 mW (24 dBm) |
| 5.250 ~ 5.350 GHz | The lesser of 250 mW (24 dBm) or 11 dBm + 10 log (B) |
| 5.470 ~ 5.725 GHz | The lesser of 250 mW (24 dBm) or 11 dBm + 10 log (B) |
| 5.725 ~ 5.850 GHz | The lesser of 1 W (30 dBm) |

According FCC KDB 662911 D01 v02r01 – for power measurements on IEEE802.11 devices,

5.470 ~ 5.725 GHz limit :

IEEE 802.11n 5 GHz 20 MHz

* 250 mW (24 dBm) or 11 dBm + 10 log (B) , B=26dB BW=11+10*Log(17.58)= 23.45 dBm

IEEE 802.11ax 20 MHz

* 250 mW (24 dBm) or 11 dBm + 10 log (B) , B=26dB BW=11+10*Log(17.17)= 23.35 dBm

■ **Test Setup**

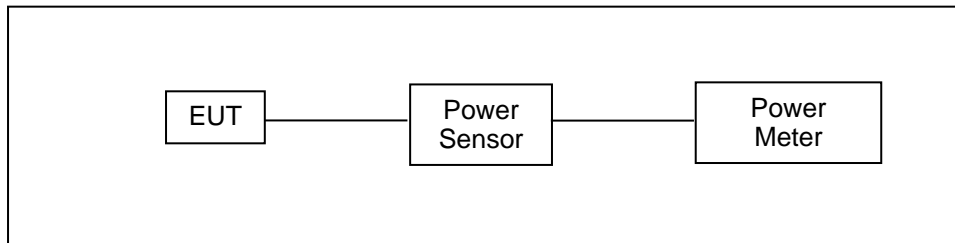

■ **Test Procedure**

The test is performed in accordance with ANSI C63.10:2013 section 12.3.3.2, Guidelines for Compliance Testing of Unlicensed National Information Infrastructure (U-NII) Devices

Section (E) Maximum Conducted Output Power

3. Measurement using a Power Meter (PM)

b) Method PM-G (Measurement using a gated RF average power meter)

4.4. 26 dB RF Bandwidth Measurement

■ **Limit**

N/A

■ **Test Setup**

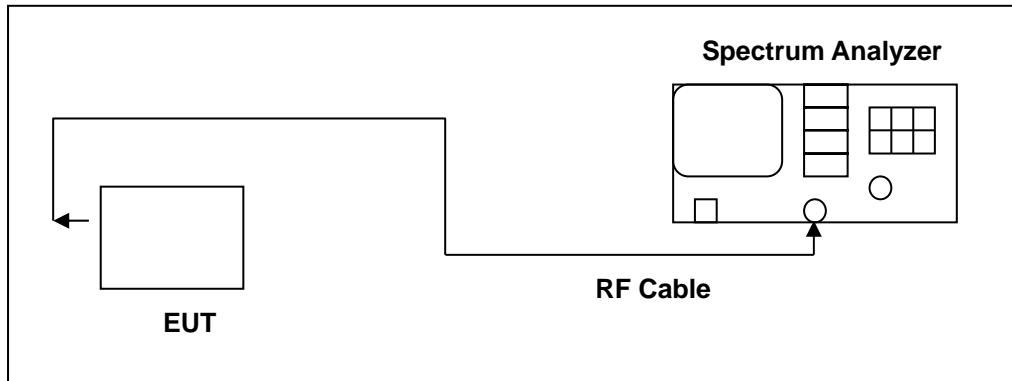

■ **Test Procedure**

The test is performed in accordance with ANSI C63.10:2013 section 12.4.1 Guidelines for Compliance Testing of Unlicensed National Information Infrastructure (U-NII) Devices - Part 15, Subpart E.

| Spectrum Parameter | Setting |
|--------------------|---|
| Attenuation | Auto |
| Span Frequency | >26 dB Bandwidth |
| RBW | Approximately 1 % of the emission bandwidth |
| VBW | VBW > RBW |
| Detector | Peak |
| Trace | Max Hold |
| Sweep Time | Auto |

4.5. 6 dB RF Bandwidth Measurement

- **Limit**

- **6 dB RF Bandwidth**

Systems using digital modulation techniques may operate in the 5725~5850 MHz bands. The minimum 6 dB band-width shall be at least 500 kHz.

- **Test Setup**

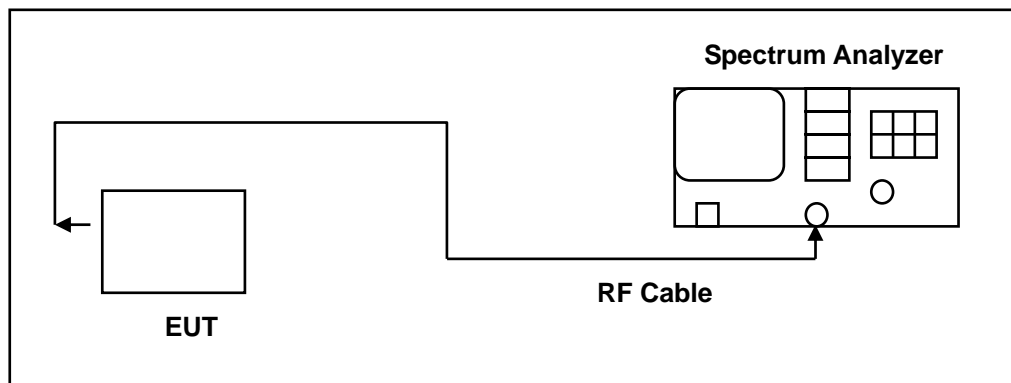

- **Test Procedure**

- **6 dB RF Bandwidth**

The EUT tested to UNII test procedure of ANSI C63.10:2013 section 6.9.2 for compliance to FCC 47CFR 15.407 requirements.

The antenna port of the EUT was connected to the input of a spectrum analyzer. Analyzer RES BW was set to 100 kHz. For each RF output channel investigated, the spectrum analyzer center frequency was set to the channel carrier. A peak output reading was taken, a DISPLAY line was drawn 6 dB lower than peak level. The 6 dB bandwidth was determined from where the channel output spectrum intersected the display line.

The test was performed at 3 channels.

4.6. Maximum Power Spectral Density Measurement

■ Limit

Conducted power spectral density

| Frequency Range (MHz) | FCC Limit |
|-----------------------|----------------|
| | Client |
| 5.150 ~ 5.250 GHz | 11 dBm/MHz |
| 5.250 ~ 5.350 GHz | 11 dBm/MHz |
| 5.470 ~ 5.725 GHz | 11 dBm/MHz |
| 5.725 ~ 5.850 GHz | 30 dBm/500 kHz |

According FCC KDB 662911 D01 v02r01 – for power measurements on IEEE802.11 devices,

CDD mode:

5.150 ~ 5.250 GHz

Directional Gain = $10 \cdot \log\{[10^{(G1/20)} + 10^{(G2/20)} + \dots + 10^{(Gn/20)}]^2 / NANT\} = 7.17 \text{ dBi} > 6 \text{ dBi}$

* power spectral density limit shall be reduced = $11 - 1.17 = 9.83 \text{ dBm/MHz}$

5.250 ~ 5.350 GHz

Directional Gain = $10 \cdot \log\{[10^{(G1/20)} + 10^{(G2/20)} + \dots + 10^{(Gn/20)}]^2 / NANT\} = 7 \text{ dBi} > 6 \text{ dBi}$

* power spectral density limit shall be reduced = $11 - 1 = 10.00 \text{ dBm/MHz}$

5.470 ~ 5.725 GHz

Directional Gain = $10 \cdot \log\{[10^{(G1/20)} + 10^{(G2/20)} + \dots + 10^{(Gn/20)}]^2 / NANT\} = 7.08 \text{ dBi} > 6 \text{ dBi}$

* power spectral density limit shall be reduced = $11 - 1.08 = 9.92 \text{ dBm/MHz}$

5.725 ~ 5.850 GHz

Directional Gain = $10 \cdot \log\{[10^{(G1/20)} + 10^{(G2/20)} + \dots + 10^{(Gn/20)}]^2 / NANT\} = 7.62 \text{ dBi} > 6 \text{ dBi}$

* power spectral density limit shall be reduced = $30 - 1.62 = 28.38 \text{ dBm/500 kHz}$

■ **Test Setup**

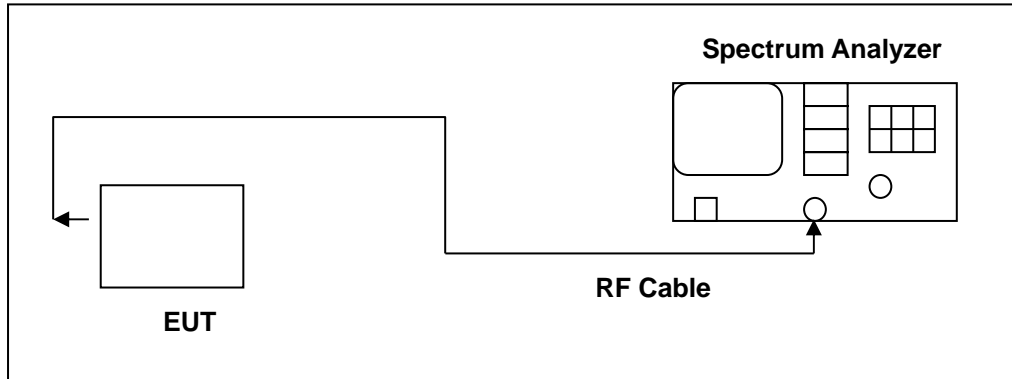

■ **Test Procedure**

The test is performed in accordance with ANSI C63.10:2013 section 12.5, Guidelines for Compliance Testing of Unlicensed National Information Infrastructure (U-NII) Devices - Part 15, Subpart E.

| Spectrum Parameter | Setting |
|---|--|
| Attenuation | Auto |
| Span Frequency | Encompass the entire emissions bandwidth (EBW) of the signal |
| RBW | 1 MHz (5725 ~ 5850 MHz use 100 kHz) |
| VBW | 3 MHz (5725 ~ 5850 MHz use 300 kHz) |
| Detector | RMS |
| Trace | AVERAGE |
| Sweep Time | Auto |
| Trace Average | 100 times |
| Note: If measurement bandwidth of Maximum PSD is specified in 500 kHz, add $10 \log(500 \text{ kHz}/100 \text{ kHz})$ to the measured result. | |



4.7. Automatically discontinue transmission

The device shall automatically discontinue transmission in case of either absence of information to transmit or operational failure. These provisions are not intended to preclude the transmission of control or signalling information or the use of repetitive codes used by certain digital technologies to complete frame or burst intervals. Applicants shall include in their application for equipment authorization a description of how this requirement is met.

- **Declare**

While the EUT is not transmitting any information, the EUT can automatically discontinue transmission and become standby mode for power saving.

The EUT can detect the controlling signal of ACK message transmitting from remote device and verify whether it shall resend or discontinue transmission.

4.8. Antenna Requirement

- **Limit**

For intentional device, according to 15.203, an intentional radiator shall be designed to ensure that no antenna other than that furnished by the responsible party shall be used with the device.

And According to 15.407 (a), if transmitting antennas of directional gain greater than 6 dBi are used, the power shall be reduced by the amount in dB that the directional gain of the antenna exceeds 6 dBi.

- **Antenna Connector Construction**

See section 2 – antenna information.



■ **Directional Gain Calculated**

For Maximum Conducted Output Power

$$\text{Directional Gain} = 10 \cdot \log\{[10^{G1/10} + 10^{G2/10} + \dots + 10^{Gn/10}] / NANT\}$$

| Operate Freq. Band | | Directional Gain (dBi) |
|---|-----------------|------------------------|
| IEEE 802.11a | U-NII Band I | 4.18 |
| | U-NII Band II-A | 4.02 |
| | U-NII Band II-C | 4.07 |
| | U-NII Band III | 4.63 |
| IEEE 802.11n 5 GHz 20 MHz IEEE 802.11ac 20 MHz IEEE 802.11ax 20 MHz | U-NII Band I | 4.18 |
| | U-NII Band II-A | 4.02 |
| | U-NII Band II-C | 4.07 |
| | U-NII Band III | 4.63 |
| IEEE 802.11n 5 GHz 40 MHz IEEE 802.11ac 40 MHz IEEE 802.11ax 40 MHz | U-NII Band I | 4.18 |
| | U-NII Band II-A | 4.02 |
| | U-NII Band II-C | 4.07 |
| | U-NII Band III | 4.63 |
| IEEE 802.11ac 80 MHz IEEE 802.11ax 80 MHz | U-NII Band I | 4.18 |
| | U-NII Band II-A | 4.02 |
| | U-NII Band II-C | 4.07 |
| | U-NII Band III | 4.63 |

For Maximum Power Density

$$10 \cdot \log\{[10^{G1/20} + 10^{G2/20} + \dots + 10^{Gn/20}]^2 / NANT\}$$

| Operate Freq. Band | | Directional Gain (dBi) |
|---|-----------------|------------------------|
| IEEE 802.11a | U-NII Band I | 7.17 |
| | U-NII Band II-A | 7.00 |
| | U-NII Band II-C | 7.08 |
| | U-NII Band III | 7.62 |
| IEEE 802.11n 5 GHz 20 MHz IEEE 802.11ac 20 MHz IEEE 802.11ax 20 MHz | U-NII Band I | 7.17 |
| | U-NII Band II-A | 7.00 |
| | U-NII Band II-C | 7.08 |
| | U-NII Band III | 7.62 |
| IEEE 802.11n 5 GHz 40 MHz IEEE 802.11ac 40 MHz IEEE 802.11ax 40 MHz | U-NII Band I | 7.17 |
| | U-NII Band II-A | 7.00 |
| | U-NII Band II-C | 7.08 |
| | U-NII Band III | 7.62 |
| IEEE 802.11ac 80 MHz IEEE 802.11ax 80 MHz | U-NII Band I | 7.17 |
| | U-NII Band II-A | 7.00 |
| | U-NII Band II-C | 7.08 |
| | U-NII Band III | 7.62 |

5 Test Results

Annex A. Conducted Emission

| | | | |
|--------------|--------------------|--------|----------------|
| Standard: | FCC Part 15.407 | Line: | L1 |
| Test item: | Conducted Emission | Power: | AC 120 V/60 Hz |
| Mode: | Mode 1 | | |
| Description: | | | |

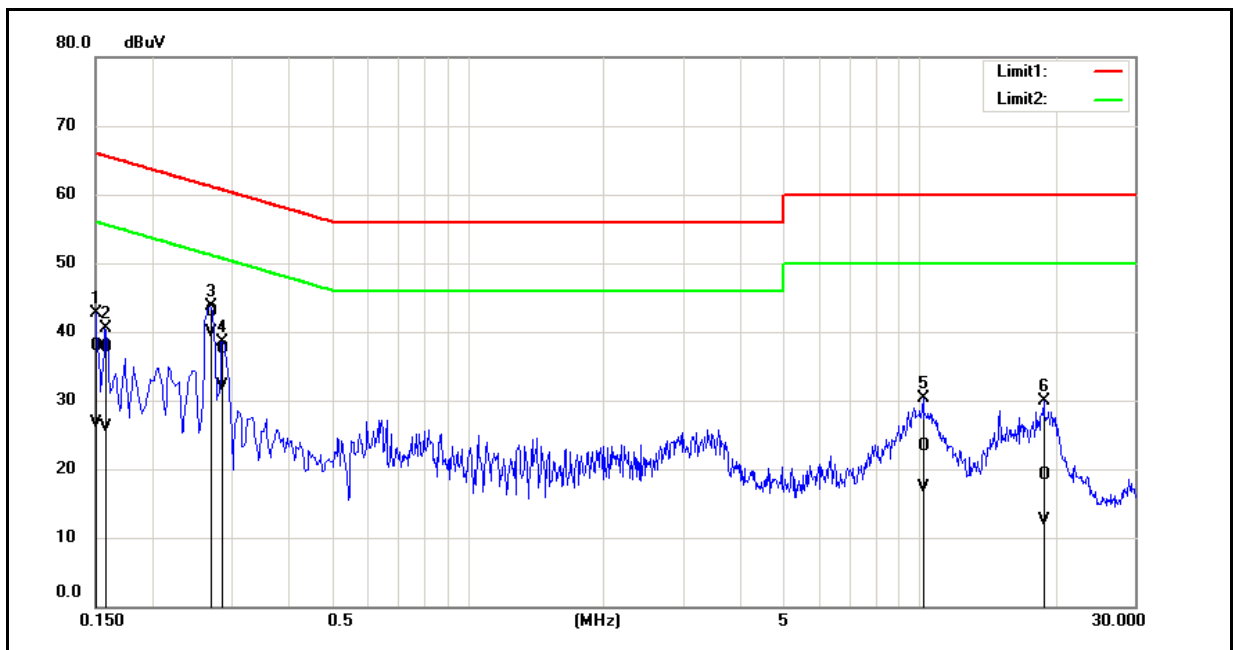

| No. | Frequency (MHz) | QP reading (dBuV) | AVG reading (dBuV) | Correction factor (dB) | QP result (dBuV) | AVG result (dBuV) | QP limit (dBuV) | AVG limit (dBuV) | QP margin (dB) | AVG margin (dB) | Remark |
|-----|-----------------|-------------------|--------------------|------------------------|------------------|-------------------|-----------------|------------------|----------------|-----------------|--------|
| 1 | 0.1500 | 28.15 | 17.01 | 9.74 | 37.89 | 26.75 | 66.00 | 56.00 | -28.11 | -29.25 | Pass |
| 2 | 0.1580 | 27.88 | 16.44 | 9.74 | 37.62 | 26.18 | 65.57 | 55.57 | -27.95 | -29.39 | Pass |
| 3 | 0.2700 | 33.19 | 30.18 | 9.74 | 42.93 | 39.92 | 61.12 | 51.12 | -18.19 | -11.20 | Pass |
| 4 | 0.2860 | 27.82 | 22.32 | 9.74 | 37.56 | 32.06 | 60.64 | 50.64 | -23.08 | -18.58 | Pass |
| 5 | 10.1940 | 13.28 | 7.34 | 9.97 | 23.25 | 17.31 | 60.00 | 50.00 | -36.75 | -32.69 | Pass |
| 6 | 18.9060 | 9.01 | 2.51 | 10.04 | 19.05 | 12.55 | 60.00 | 50.00 | -40.95 | -37.45 | Pass |

Note: 1. Result (dBuV) = Correction factor (dB) + Reading(dBuV).

2. Correction factor (dB) = Cable loss (dB) + L.I.S.N. factor (dB).



| | | | |
|--------------|--------------------|--------|----------------|
| Standard: | FCC Part 15.407 | Line: | N |
| Test item: | Conducted Emission | Power: | AC 120 V/60 Hz |
| Mode: | Mode 1 | | |
| Description: | | | |

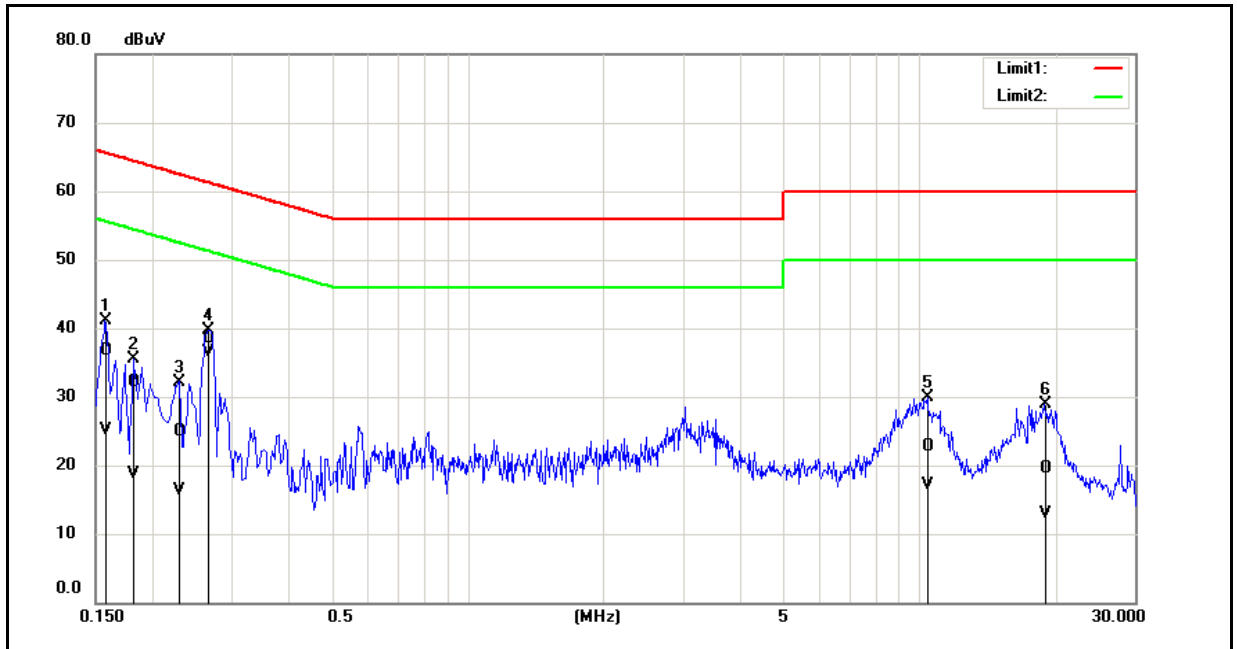

| No. | Frequency (MHz) | QP reading (dBuV) | AVG reading (dBuV) | Correction factor (dB) | QP result (dBuV) | AVG result (dBuV) | QP limit (dBuV) | AVG limit (dBuV) | QP margin (dB) | AVG margin (dB) | Remark |
|-----|-----------------|-------------------|--------------------|------------------------|------------------|-------------------|-----------------|------------------|----------------|-----------------|--------|
| 1 | 0.1580 | 27.05 | 15.36 | 9.74 | 36.79 | 25.10 | 65.57 | 55.57 | -28.78 | -30.47 | Pass |
| 2 | 0.1820 | 22.39 | 8.96 | 9.73 | 32.12 | 18.69 | 64.39 | 54.39 | -32.27 | -35.70 | Pass |
| 3 | 0.2300 | 15.13 | 6.52 | 9.73 | 24.86 | 16.25 | 62.45 | 52.45 | -37.59 | -36.20 | Pass |
| 4 | 0.2660 | 28.82 | 26.78 | 9.73 | 38.55 | 36.51 | 61.24 | 51.24 | -22.69 | -14.73 | Pass |
| 5 | 10.4220 | 12.65 | 7.03 | 10.00 | 22.65 | 17.03 | 60.00 | 50.00 | -37.35 | -32.97 | Pass |
| 6 | 18.9460 | 9.30 | 2.83 | 10.17 | 19.47 | 13.00 | 60.00 | 50.00 | -40.53 | -37.00 | Pass |

Note: 1. Result (dBuV) = Correction factor (dB) + Reading(dBuV).
2. Correction factor (dB) = Cable loss (dB) + L.I.S.N. factor (dB).



Annex B. Radiated Emission Measurement

Below 1 GHz

| | | | |
|-------------|-------------------|----------------|-----|
| Standard: | FCC Part 15.407 | Test Distance: | 3 m |
| Test item: | Radiated Emission | | |
| Frequency: | 5825 MHz | | |
| Mode: | Mode 2 | | |
| Ant.Polar.: | Horizontal | | |

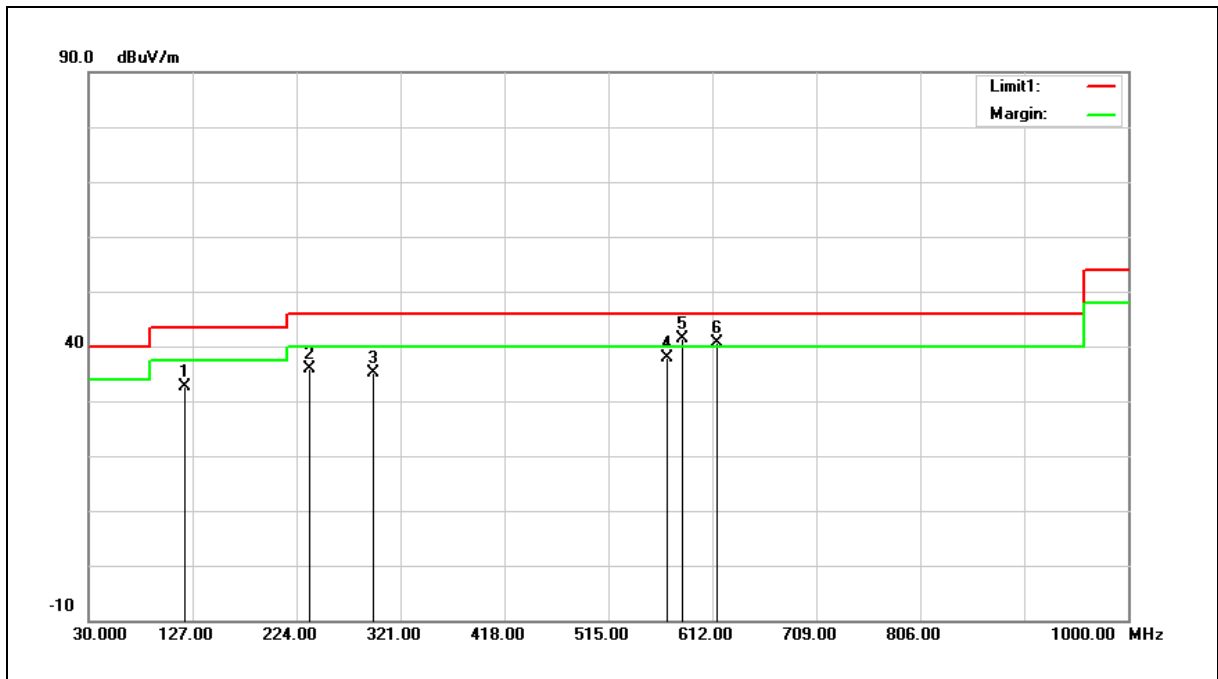

| No. | Frequency (MHz) | Reading (dBuV) | Correct Factor (dB/m) | Result (dBuV/m) | Limit (dBuV/m) | Margin (dB) | Remark |
|-----|-----------------|----------------|-----------------------|-----------------|----------------|-------------|--------|
| 1 | 120.2100 | 41.94 | -9.39 | 32.55 | 43.50 | -10.95 | QP |
| 2 | 235.6400 | 43.46 | -7.58 | 35.88 | 46.00 | -10.12 | QP |
| 3 | 295.7800 | 40.65 | -5.51 | 35.14 | 46.00 | -10.86 | QP |
| 4 | 569.3200 | 38.12 | -0.33 | 37.79 | 46.00 | -8.21 | QP |
| 5 | 583.8700 | 41.18 | 0.08 | 41.26 | 46.00 | -4.74 | QP |
| 6 | 616.8500 | 39.99 | 0.74 | 40.73 | 46.00 | -5.27 | QP |

Note:1.Result (dBuV/m) = Correct Factor (dB/m) + Reading(dBuV).

Example: 32.55= -9.39+41.94.

2.Correction factor (dB/m) = Antenna Factor (dB/m) + Cable loss (dB) – Pre-Amplifier gain (dB).

3.When the peak results are less than average limit, so not need to evaluate the average.



| | | | |
|-------------|-------------------|----------------|-----|
| Standard: | FCC Part 15.407 | Test Distance: | 3 m |
| Test item: | Radiated Emission | | |
| Frequency: | 5825 MHz | | |
| Mode: | Mode 2 | | |
| Ant.Polar.: | Vertical | | |

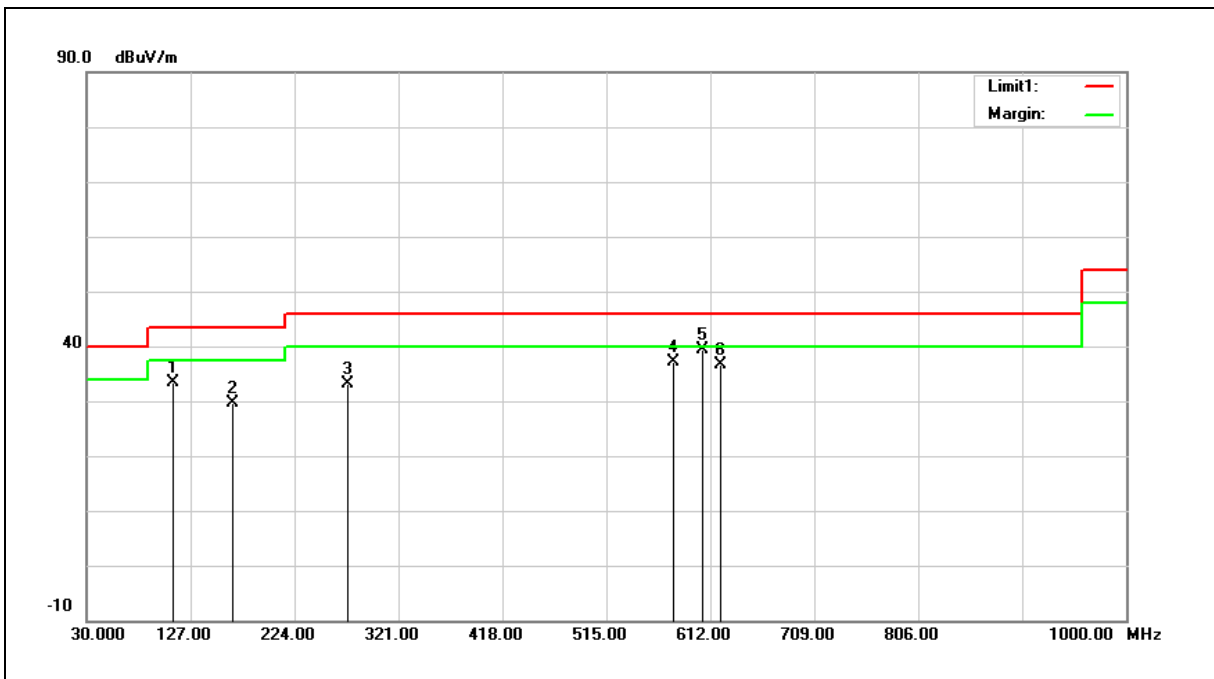

| No. | Frequency (MHz) | Reading (dBuV) | Correct Factor (dB/m) | Result (dBuV/m) | Limit (dBuV/m) | Margin (dB) | Remark |
|-----|-----------------|----------------|-----------------------|-----------------|----------------|-------------|--------|
| 1 | 110.5100 | 43.68 | -10.33 | 33.35 | 43.50 | -10.15 | QP |
| 2 | 165.8000 | 36.22 | -6.60 | 29.62 | 43.50 | -13.88 | QP |
| 3 | 273.4700 | 39.37 | -6.20 | 33.17 | 46.00 | -12.83 | QP |
| 4 | 578.0500 | 37.23 | -0.08 | 37.15 | 46.00 | -8.85 | QP |
| 5 | 604.2400 | 38.68 | 0.60 | 39.28 | 46.00 | -6.72 | QP |
| 6 | 621.7000 | 35.88 | 0.79 | 36.67 | 46.00 | -9.33 | QP |

Note:1.Result (dBuV/m) = Correct Factor (dB/m) + Reading(dBuV).

Example: 33.35= -10.33+43.68.

2.Correction factor (dB/m) = Antenna Factor (dB/m) + Cable loss (dB) – Pre-Amplifier gain (dB).

3.When the peak results are less than average limit, so not need to evaluate the average.



Harmonic

Above 1 GHz

| | | | |
|-------------|-----------------|----------------|-----|
| Standard: | FCC Part 15.407 | Test Distance: | 3 m |
| Test item: | Harmonic | | |
| Frequency: | 5180 MHz | | |
| Mode: | Mode 2 | | |
| Ant.Polar.: | Horizontal | | |

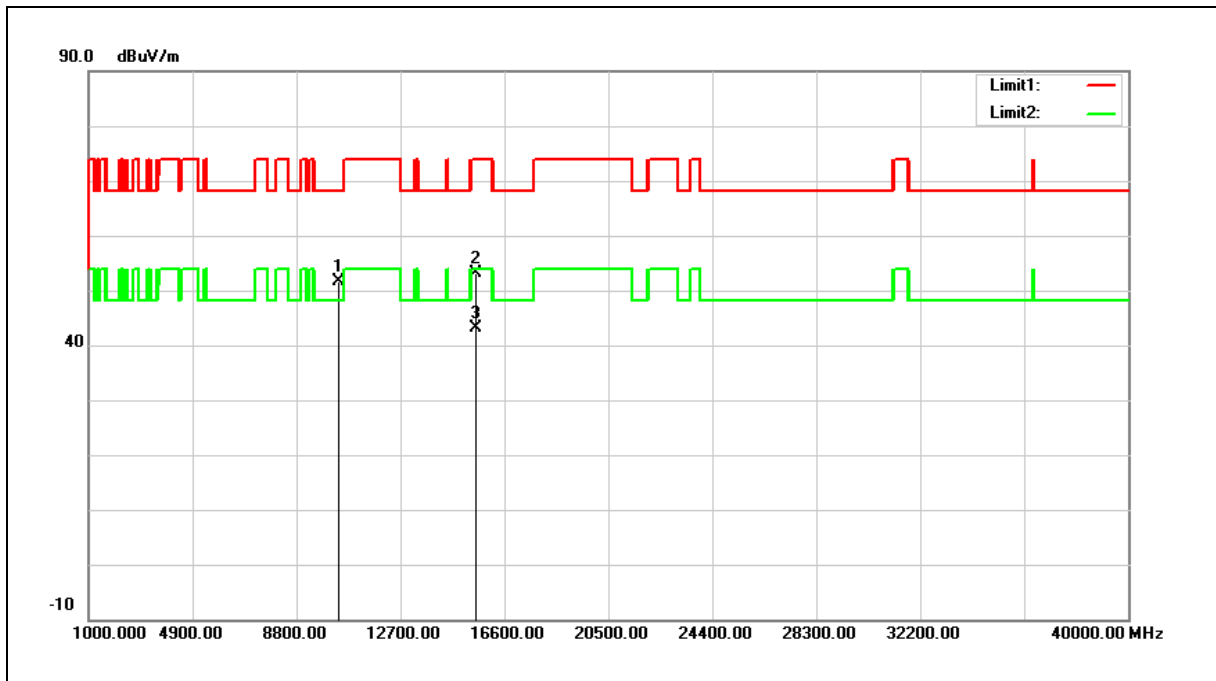

| No. | Frequency (MHz) | Reading (dBuV) | Correct Factor (dB/m) | Result (dBuV/m) | Limit (dBuV/m) | Margin (dB) | Remark |
|-----|-----------------|----------------|-----------------------|-----------------|----------------|-------------|--------|
| 1 | 10360.000 | 34.91 | 16.60 | 51.51 | 68.20 | -16.69 | peak |
| 2 | 15540.000 | 34.28 | 18.94 | 53.22 | 74.00 | -20.78 | peak |
| 3 | 15540.000 | 24.11 | 18.94 | 43.05 | 54.00 | -10.95 | AVG |

Note:1.Result (dBuV/m) = Correct Factor (dB/m) + Reading(dBuV).

Example: 51.51= 16.60+34.91.

2.Correction factor (dB/m) = Antenna Factor (dB/m) + Cable loss (dB) – Pre-Amplifier gain (dB).

3.When the peak results are less than average limit, so not need to evaluate the average.



| | | | |
|-------------|-----------------|----------------|-----|
| Standard: | FCC Part 15.407 | Test Distance: | 3 m |
| Test item: | Harmonic | | |
| Frequency: | 5180 MHz | | |
| Mode: | Mode 2 | | |
| Ant.Polar.: | Vertical | | |

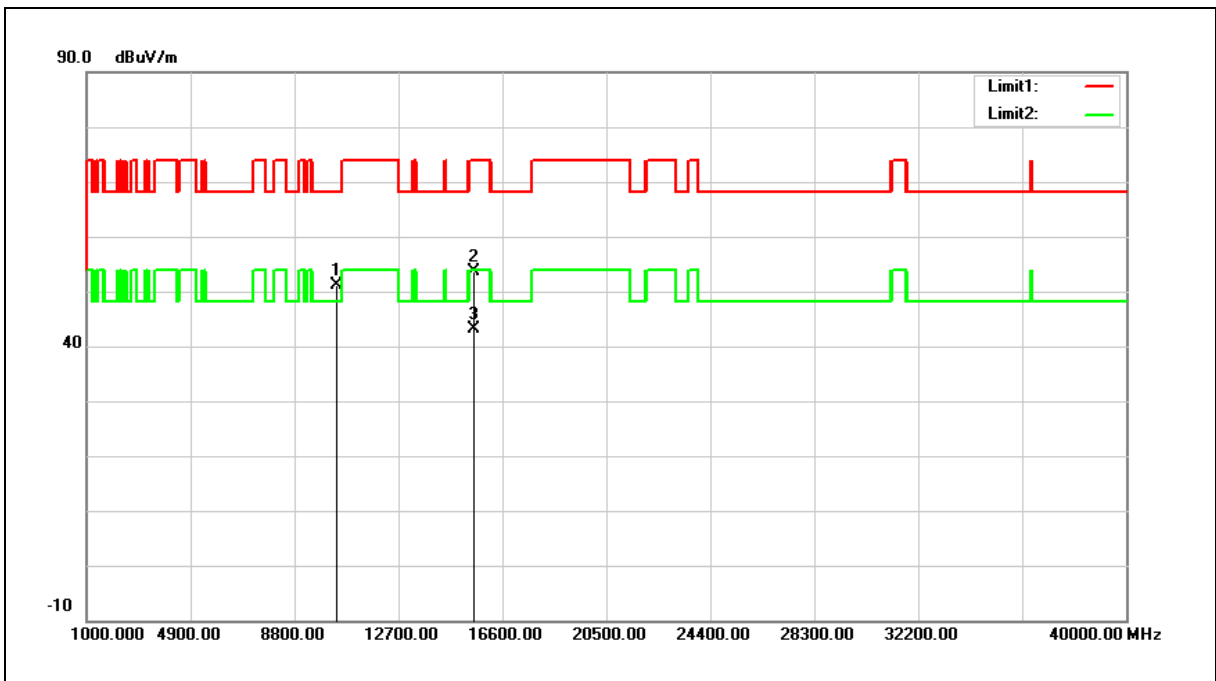

| No. | Frequency (MHz) | Reading (dBuV) | Correct Factor (dB/m) | Result (dBuV/m) | Limit (dBuV/m) | Margin (dB) | Remark |
|-----|-----------------|----------------|-----------------------|-----------------|----------------|-------------|--------|
| 1 | 10360.000 | 34.65 | 16.60 | 51.25 | 68.20 | -16.95 | peak |
| 2 | 15540.000 | 34.78 | 18.94 | 53.72 | 74.00 | -20.28 | peak |
| 3 | 15540.000 | 24.25 | 18.94 | 43.19 | 54.00 | -10.81 | AVG |

Note:1.Result (dBuV/m) = Correct Factor (dB/m) + Reading(dBuV).

Example: 51.25= 16.60+34.65.

2.Correction factor (dB/m) = Antenna Factor (dB/m) + Cable loss (dB) – Pre-Amplifier gain (dB).

3.When the peak results are less than average limit, so not need to evaluate the average.



| | | | |
|-------------|-----------------|----------------|-----|
| Standard: | FCC Part 15.407 | Test Distance: | 3 m |
| Test item: | Harmonic | | |
| Frequency: | 5200 MHz | | |
| Mode: | Mode 2 | | |
| Ant.Polar.: | Horizontal | | |

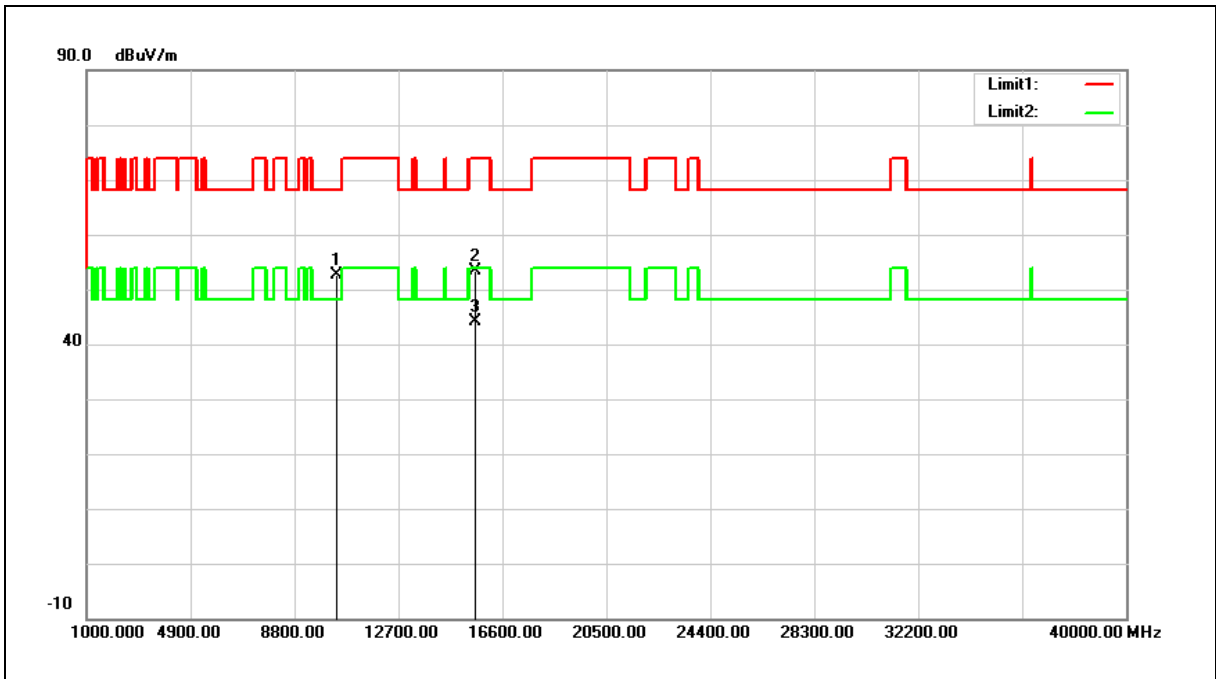

| No. | Frequency (MHz) | Reading (dBuV) | Correct Factor (dB/m) | Result (dBuV/m) | Limit (dBuV/m) | Margin (dB) | Remark |
|-----|-----------------|----------------|-----------------------|-----------------|----------------|-------------|--------|
| 1 | 10400.000 | 35.80 | 16.73 | 52.53 | 68.20 | -15.67 | peak |
| 2 | 15600.000 | 34.58 | 18.68 | 53.26 | 74.00 | -20.74 | peak |
| 3 | 15600.000 | 25.34 | 18.68 | 44.02 | 54.00 | -9.98 | AVG |

Note:1.Result (dBuV/m) = Correct Factor (dB/m) + Reading(dBuV).

2.Correction factor (dB/m) = Antenna Factor (dB/m) + Cable loss (dB) – Pre-Amplifier gain (dB).

3.When the peak results are less than average limit, so not need to evaluate the average.



| | | | |
|-------------|-----------------|----------------|-----|
| Standard: | FCC Part 15.407 | Test Distance: | 3 m |
| Test item: | Harmonic | | |
| Frequency: | 5200 MHz | | |
| Mode: | Mode 2 | | |
| Ant.Polar.: | Vertical | | |

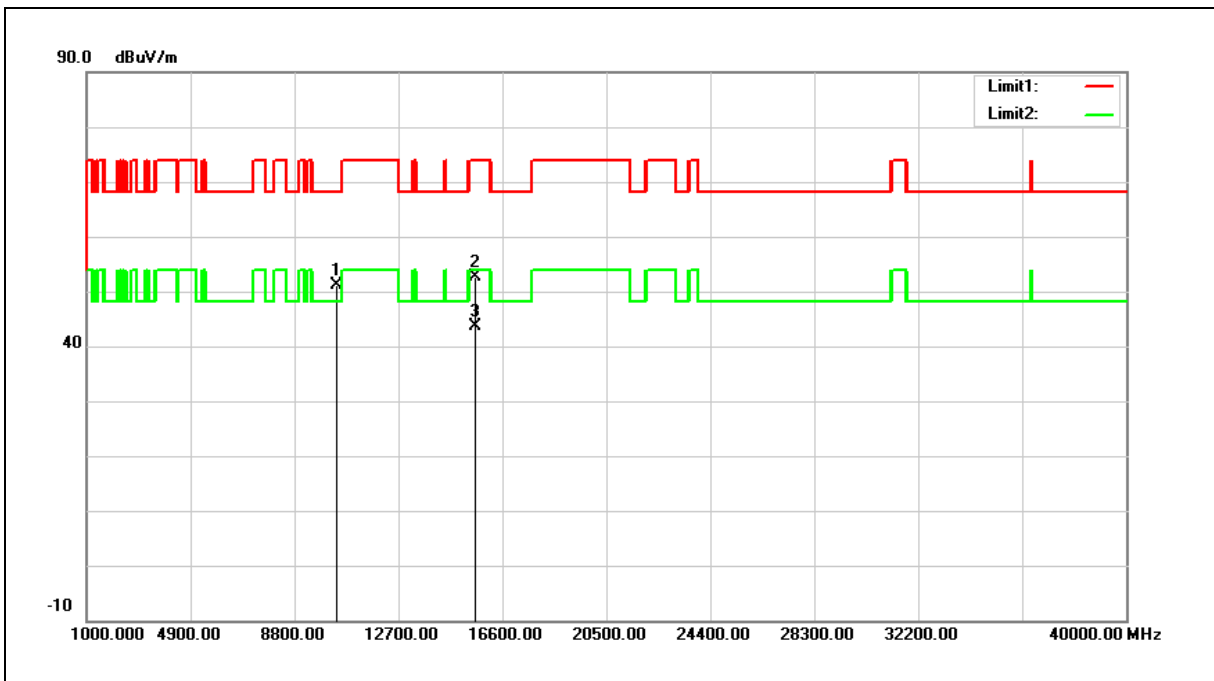

| No. | Frequency (MHz) | Reading (dBuV) | Correct Factor (dB/m) | Result (dBuV/m) | Limit (dBuV/m) | Margin (dB) | Remark |
|-----|-----------------|----------------|-----------------------|-----------------|----------------|-------------|--------|
| 1 | 10400.000 | 34.33 | 16.73 | 51.06 | 68.20 | -17.14 | peak |
| 2 | 15600.000 | 33.88 | 18.68 | 52.56 | 74.00 | -21.44 | peak |
| 3 | 15600.000 | 25.03 | 18.68 | 43.71 | 54.00 | -10.29 | AVG |

Note:1.Result (dBuV/m) = Correct Factor (dB/m) + Reading(dBuV).

2.Correction factor (dB/m) = Antenna Factor (dB/m) + Cable loss (dB) – Pre-Amplifier gain (dB).

3.When the peak results are less than average limit, so not need to evaluate the average.



| | | | |
|-------------|-----------------|----------------|-----|
| Standard: | FCC Part 15.407 | Test Distance: | 3 m |
| Test item: | Harmonic | | |
| Frequency: | 5240 MHz | | |
| Mode: | Mode 2 | | |
| Ant.Polar.: | Horizontal | | |

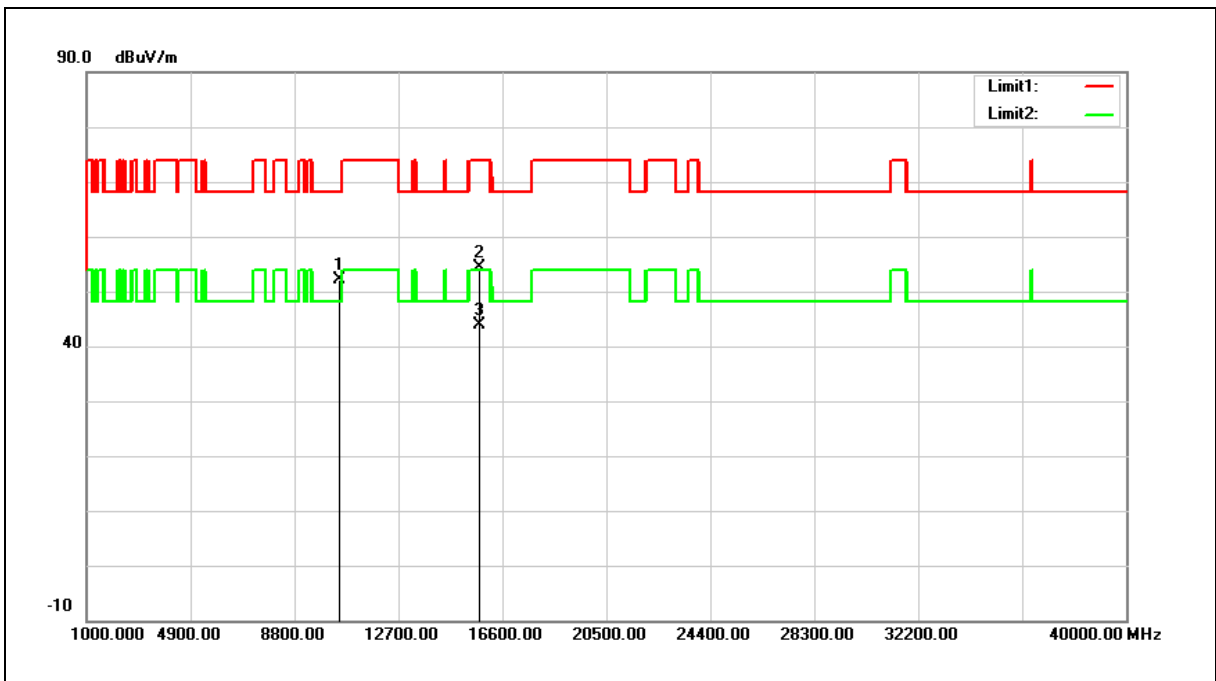

| No. | Frequency (MHz) | Reading (dBuV) | Correct Factor (dB/m) | Result (dBuV/m) | Limit (dBuV/m) | Margin (dB) | Remark |
|-----|-----------------|----------------|-----------------------|-----------------|----------------|-------------|--------|
| 1 | 10480.000 | 35.27 | 16.98 | 52.25 | 68.20 | -15.95 | peak |
| 2 | 15720.000 | 36.28 | 18.17 | 54.45 | 74.00 | -19.55 | peak |
| 3 | 15720.000 | 25.74 | 18.17 | 43.91 | 54.00 | -10.09 | AVG |

Note:1.Result (dBuV/m) = Correct Factor (dB/m) + Reading(dBuV).

2.Correction factor (dB/m) = Antenna Factor (dB/m) + Cable loss (dB) – Pre-Amplifier gain (dB).

3.When the peak results are less than average limit, so not need to evaluate the average.



| | | | |
|-------------|-----------------|----------------|-----|
| Standard: | FCC Part 15.407 | Test Distance: | 3 m |
| Test item: | Harmonic | | |
| Frequency: | 5240 MHz | | |
| Mode: | Mode 2 | | |
| Ant.Polar.: | Vertical | | |

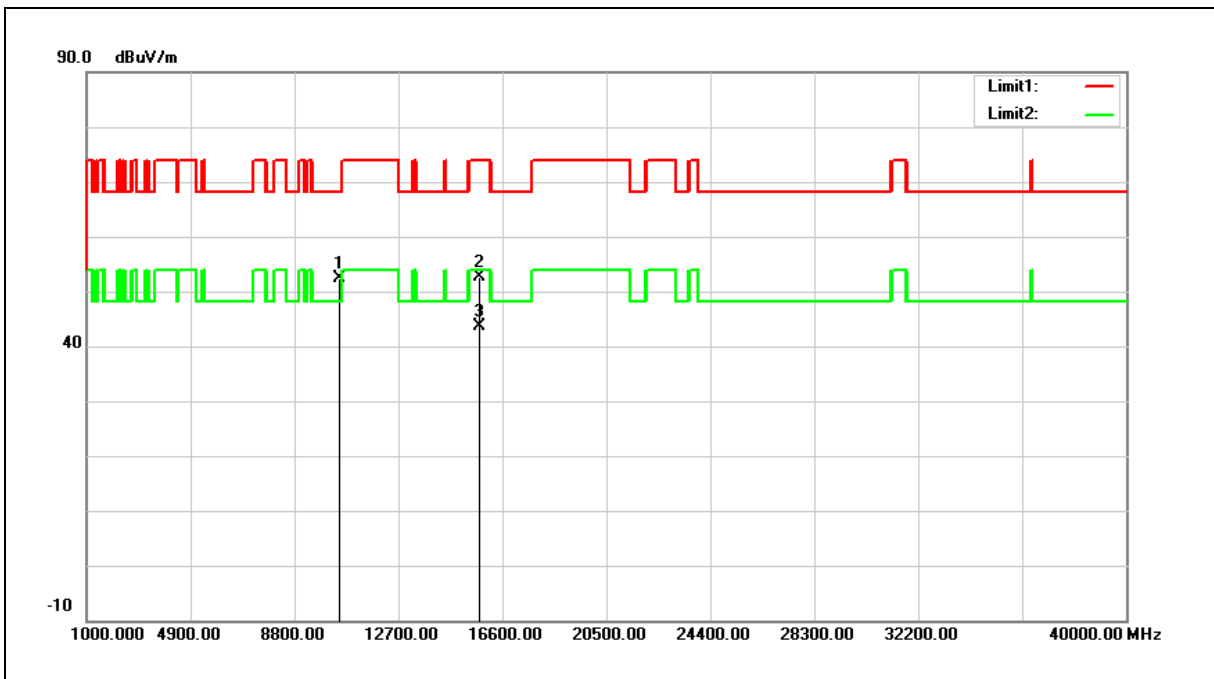

| No. | Frequency (MHz) | Reading (dBuV) | Correct Factor (dB/m) | Result (dBuV/m) | Limit (dBuV/m) | Margin (dB) | Remark |
|-----|-----------------|----------------|-----------------------|-----------------|----------------|-------------|--------|
| 1 | 10480.000 | 35.40 | 16.98 | 52.38 | 68.20 | -15.82 | peak |
| 2 | 15720.000 | 34.48 | 18.17 | 52.65 | 74.00 | -21.35 | peak |
| 3 | 15720.000 | 25.50 | 18.17 | 43.67 | 54.00 | -10.33 | AVG |

Note:1.Result (dBuV/m) = Correct Factor (dB/m) + Reading(dBuV).

2.Correction factor (dB/m) = Antenna Factor (dB/m) + Cable loss (dB) – Pre-Amplifier gain (dB).

3.When the peak results are less than average limit, so not need to evaluate the average.



| | | | |
|-------------|-----------------|----------------|-----|
| Standard: | FCC Part 15.407 | Test Distance: | 3 m |
| Test item: | Harmonic | | |
| Frequency: | 5260 MHz | | |
| Mode: | Mode 2 | | |
| Ant.Polar.: | Horizontal | | |

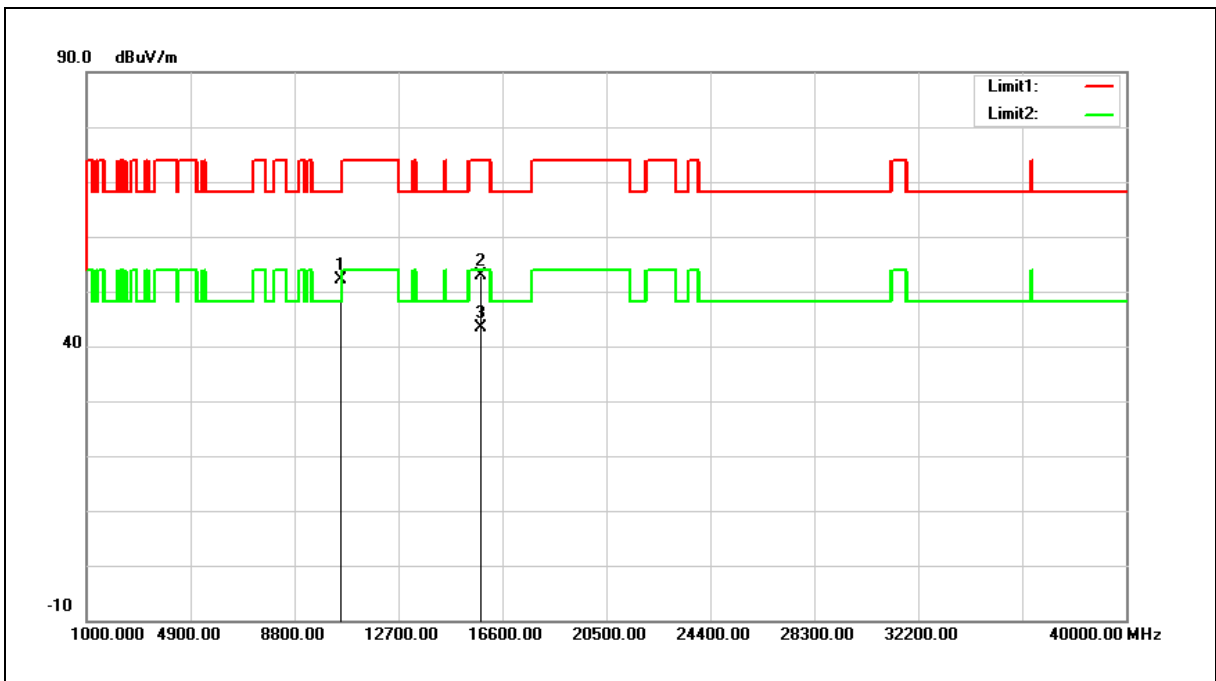

| No. | Frequency (MHz) | Reading (dBuV) | Correct Factor (dB/m) | Result (dBuV/m) | Limit (dBuV/m) | Margin (dB) | Remark |
|-----|-----------------|----------------|-----------------------|-----------------|----------------|-------------|--------|
| 1 | 10520.000 | 35.01 | 17.05 | 52.06 | 68.20 | -16.14 | peak |
| 2 | 15780.000 | 34.85 | 17.94 | 52.79 | 74.00 | -21.21 | peak |
| 3 | 15780.000 | 25.35 | 17.94 | 43.29 | 54.00 | -10.71 | AVG |

Note:1.Result (dBuV/m) = Correct Factor (dB/m) + Reading(dBuV).

2.Correction factor (dB/m) = Antenna Factor (dB/m) + Cable loss (dB) – Pre-Amplifier gain (dB).

3.When the peak results are less than average limit, so not need to evaluate the average.



| | | | |
|-------------|-----------------|----------------|-----|
| Standard: | FCC Part 15.407 | Test Distance: | 3 m |
| Test item: | Harmonic | | |
| Frequency: | 5260 MHz | | |
| Mode: | Mode 2 | | |
| Ant.Polar.: | Vertical | | |

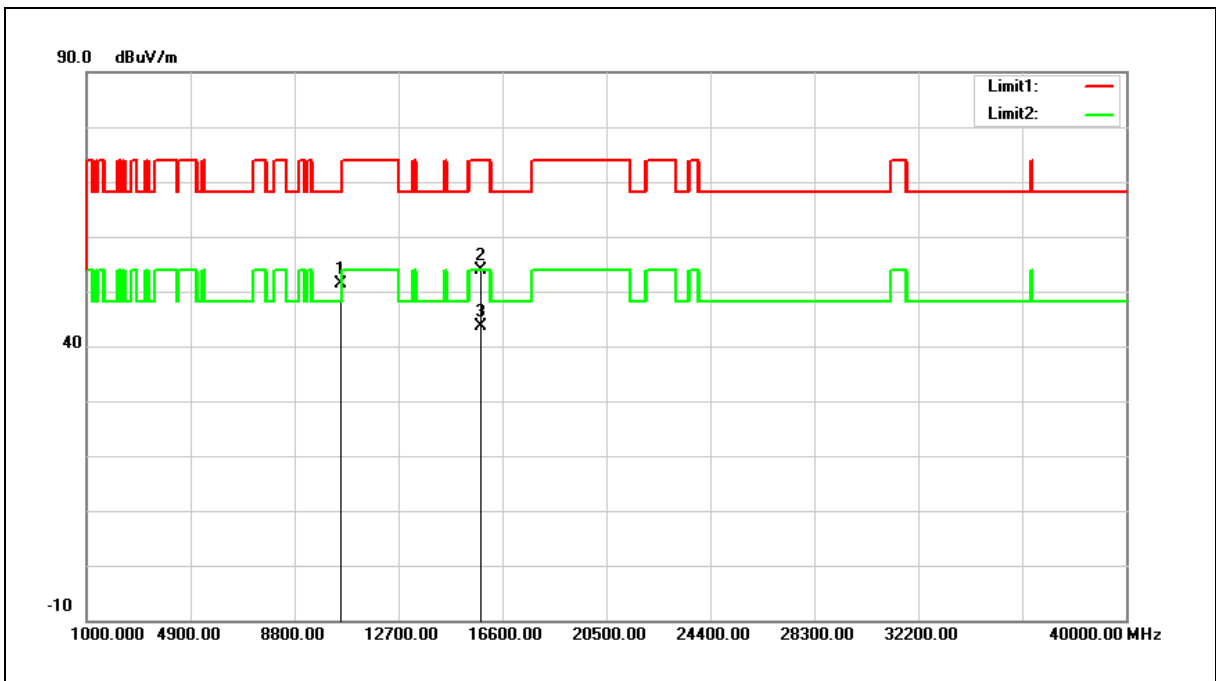

| No. | Frequency (MHz) | Reading (dBuV) | Correct Factor (dB/m) | Result (dBuV/m) | Limit (dBuV/m) | Margin (dB) | Remark |
|-----|-----------------|----------------|-----------------------|-----------------|----------------|-------------|--------|
| 1 | 10520.000 | 34.40 | 17.05 | 51.45 | 68.20 | -16.75 | peak |
| 2 | 15780.000 | 36.01 | 17.94 | 53.95 | 74.00 | -20.05 | peak |
| 3 | 15780.000 | 25.62 | 17.94 | 43.56 | 54.00 | -10.44 | AVG |

Note:1.Result (dBuV/m) = Correct Factor (dB/m) + Reading(dBuV).

2.Correction factor (dB/m) = Antenna Factor (dB/m) + Cable loss (dB) – Pre-Amplifier gain (dB).

3.When the peak results are less than average limit, so not need to evaluate the average.



| | | | |
|-------------|-----------------|----------------|-----|
| Standard: | FCC Part 15.407 | Test Distance: | 3 m |
| Test item: | Harmonic | | |
| Frequency: | 5280 MHz | | |
| Mode: | Mode 2 | | |
| Ant.Polar.: | Horizontal | | |

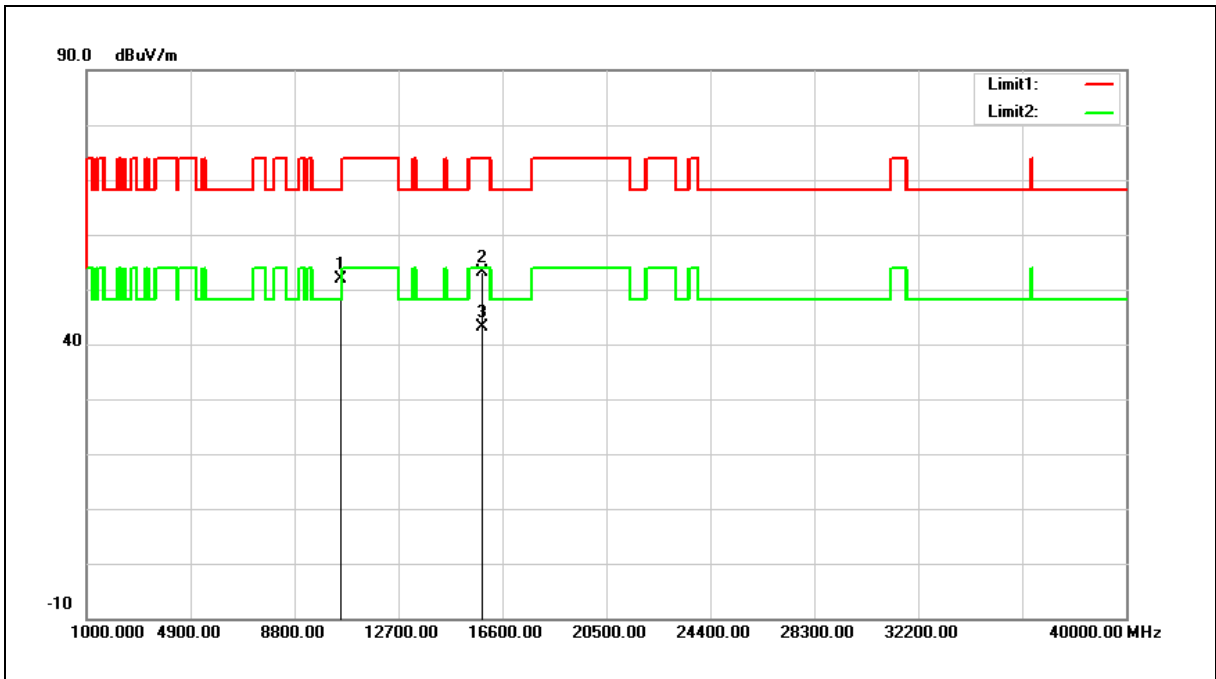

| No. | Frequency (MHz) | Reading (dBuV) | Correct Factor (dB/m) | Result (dBuV/m) | Limit (dBuV/m) | Margin (dB) | Remark |
|-----|-----------------|----------------|-----------------------|-----------------|----------------|-------------|--------|
| 1 | 10560.000 | 34.75 | 17.08 | 51.83 | 68.20 | -16.37 | peak |
| 2 | 15840.000 | 35.41 | 17.69 | 53.10 | 74.00 | -20.90 | peak |
| 3 | 15840.000 | 25.56 | 17.69 | 43.25 | 54.00 | -10.75 | AVG |

Note:1.Result (dBuV/m) = Correct Factor (dB/m) + Reading(dBuV).

2.Correction factor (dB/m) = Antenna Factor (dB/m) + Cable loss (dB) – Pre-Amplifier gain (dB).

3.When the peak results are less than average limit, so not need to evaluate the average.



| | | | |
|-------------|-----------------|----------------|-----|
| Standard: | FCC Part 15.407 | Test Distance: | 3 m |
| Test item: | Harmonic | | |
| Frequency: | 5280 MHz | | |
| Mode: | Mode 2 | | |
| Ant.Polar.: | Vertical | | |

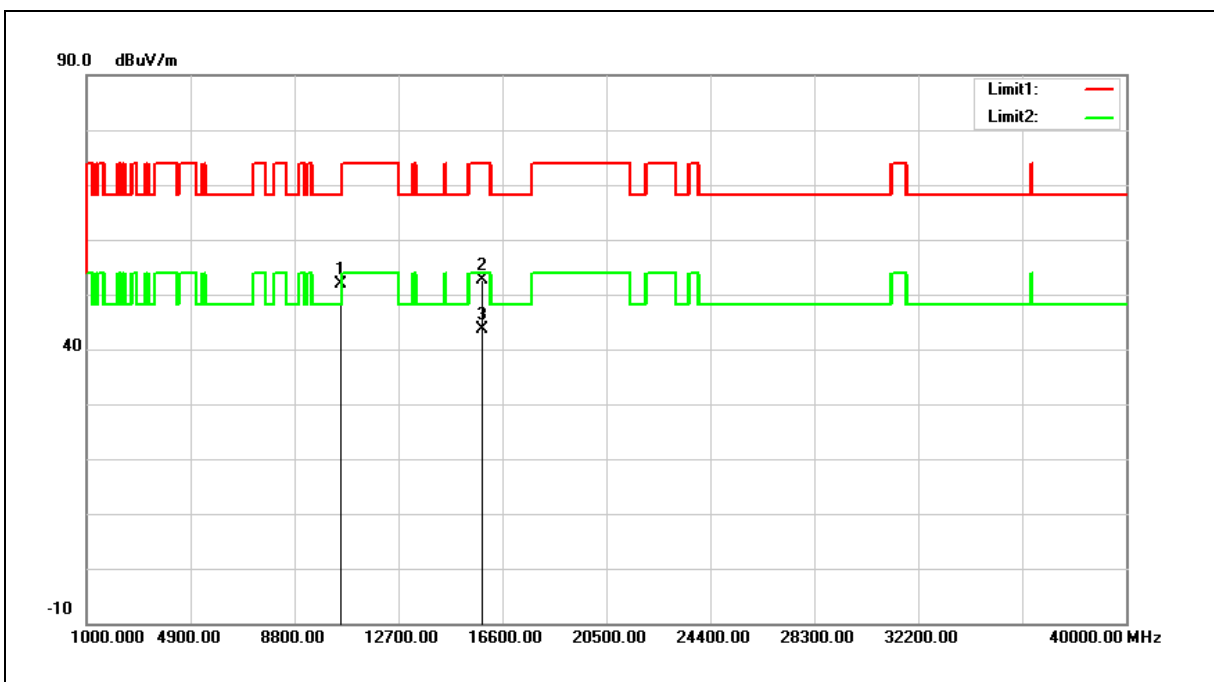

| No. | Frequency (MHz) | Reading (dBuV) | Correct Factor (dB/m) | Result (dBuV/m) | Limit (dBuV/m) | Margin (dB) | Remark |
|-----|-----------------|----------------|-----------------------|-----------------|----------------|-------------|--------|
| 1 | 10560.000 | 34.90 | 17.08 | 51.98 | 68.20 | -16.22 | peak |
| 2 | 15840.000 | 34.93 | 17.69 | 52.62 | 74.00 | -21.38 | peak |
| 3 | 15840.000 | 25.93 | 17.69 | 43.62 | 54.00 | -10.38 | AVG |

Note:1.Result (dBuV/m) = Correct Factor (dB/m) + Reading(dBuV).

2.Correction factor (dB/m) = Antenna Factor (dB/m) + Cable loss (dB) – Pre-Amplifier gain (dB).

3.When the peak results are less than average limit, so not need to evaluate the average.



| | | | |
|-------------|-----------------|----------------|-----|
| Standard: | FCC Part 15.407 | Test Distance: | 3 m |
| Test item: | Harmonic | | |
| Frequency: | 5320 MHz | | |
| Mode: | Mode 2 | | |
| Ant.Polar.: | Horizontal | | |

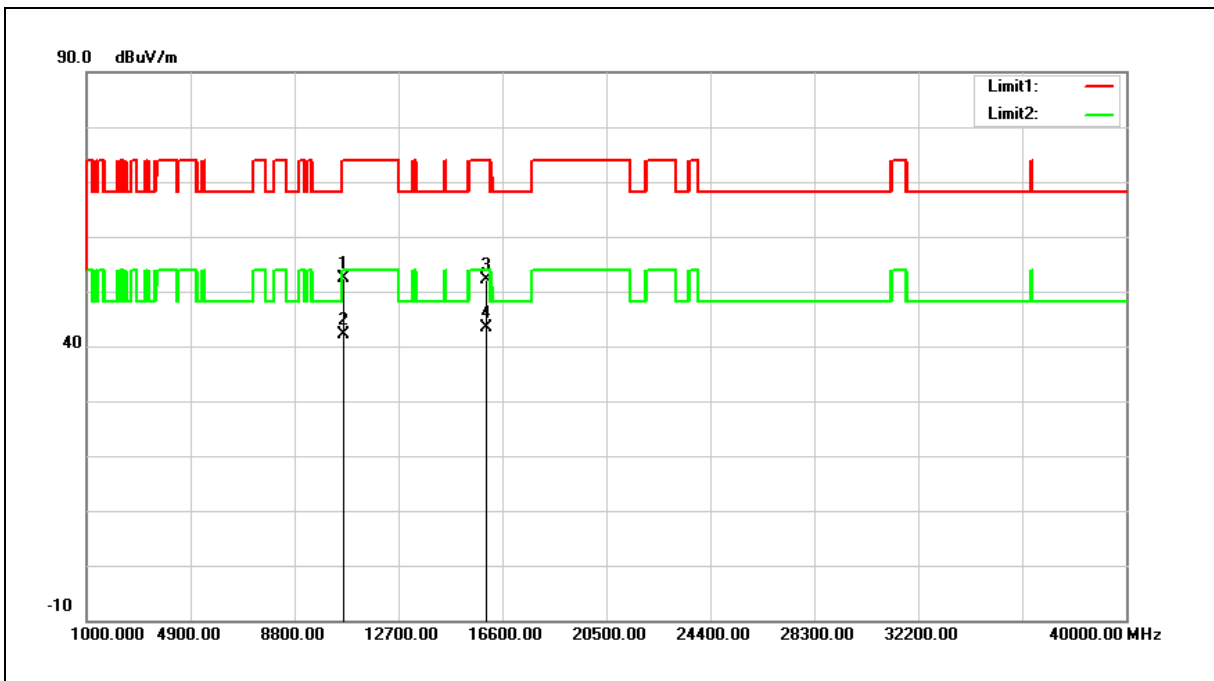

| No. | Frequency (MHz) | Reading (dBuV) | Correct Factor (dB/m) | Result (dBuV/m) | Limit (dBuV/m) | Margin (dB) | Remark |
|-----|-----------------|----------------|-----------------------|-----------------|----------------|-------------|--------|
| 1 | 10640.000 | 35.31 | 17.14 | 52.45 | 74.00 | -21.55 | peak |
| 2 | 10640.000 | 25.11 | 17.14 | 42.25 | 54.00 | -11.75 | AVG |
| 3 | 15960.000 | 34.90 | 17.18 | 52.08 | 74.00 | -21.92 | peak |
| 4 | 15960.000 | 26.27 | 17.18 | 43.45 | 54.00 | -10.55 | AVG |

Note:1.Result (dBuV/m) = Correct Factor (dB/m) + Reading(dBuV).

2.Correction factor (dB/m) = Antenna Factor (dB/m) + Cable loss (dB) – Pre-Amplifier gain (dB).

3.When the peak results are less than average limit, so not need to evaluate the average.



| | | | |
|-------------|-----------------|----------------|-----|
| Standard: | FCC Part 15.407 | Test Distance: | 3 m |
| Test item: | Harmonic | | |
| Frequency: | 5320 MHz | | |
| Mode: | Mode 2 | | |
| Ant.Polar.: | Vertical | | |

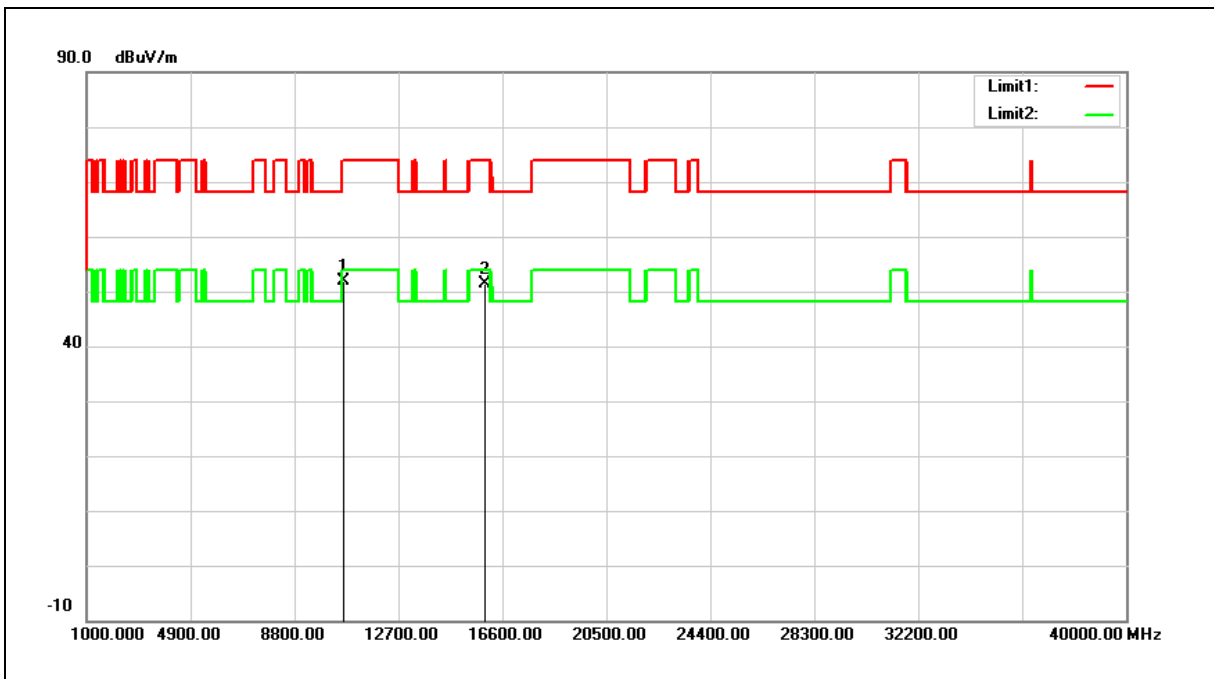

| No. | Frequency (MHz) | Reading (dBuV) | Correct Factor (dB/m) | Result (dBuV/m) | Limit (dBuV/m) | Margin (dB) | Remark |
|-----|-----------------|----------------|-----------------------|-----------------|----------------|-------------|--------|
| 1 | 10640.000 | 34.69 | 17.14 | 51.83 | 74.00 | -22.17 | peak |
| 2 | 15960.000 | 34.08 | 17.18 | 51.26 | 74.00 | -22.74 | peak |

Note:1.Result (dBuV/m) = Correct Factor (dB/m) + Reading(dBuV).

2.Correction factor (dB/m) = Antenna Factor (dB/m) + Cable loss (dB) – Pre-Amplifier gain (dB).

3.When the peak results are less than average limit, so not need to evaluate the average.



| | | | |
|-------------|-----------------|----------------|-----|
| Standard: | FCC Part 15.407 | Test Distance: | 3 m |
| Test item: | Harmonic | | |
| Frequency: | 5500 MHz | | |
| Mode: | Mode 2 | | |
| Ant.Polar.: | Horizontal | | |

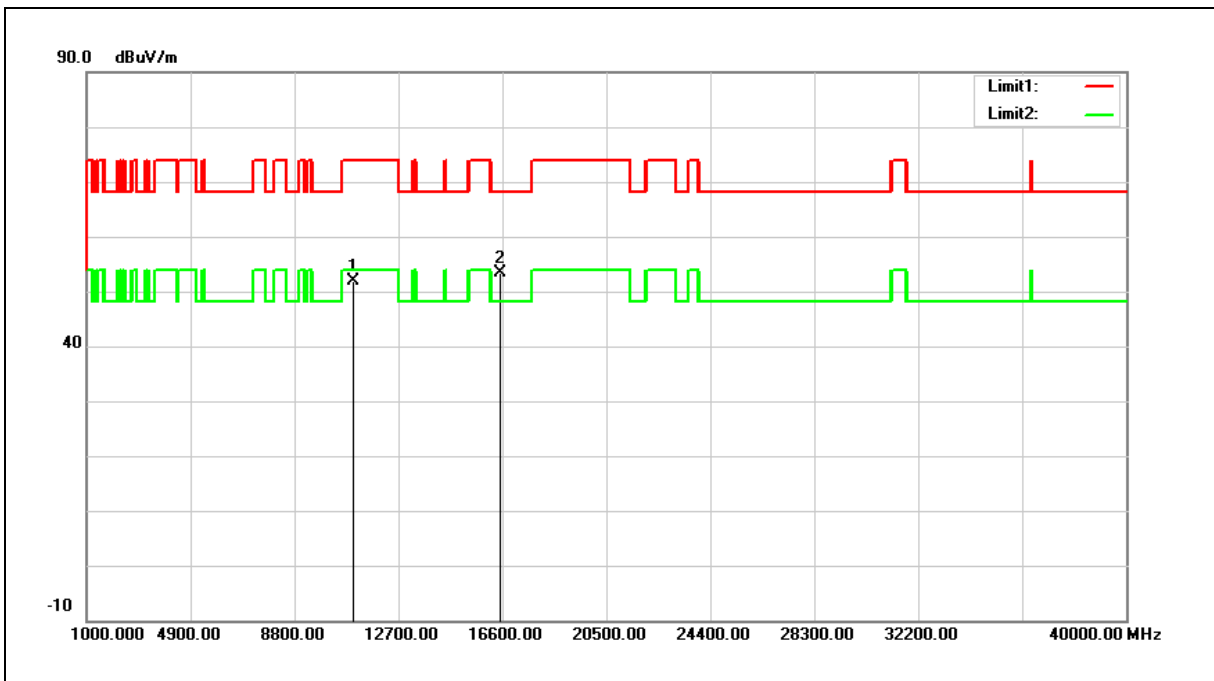

| No. | Frequency (MHz) | Reading (dBuV) | Correct Factor (dB/m) | Result (dBuV/m) | Limit (dBuV/m) | Margin (dB) | Remark |
|-----|-----------------|----------------|-----------------------|-----------------|----------------|-------------|--------|
| 1 | 11000.000 | 34.54 | 17.41 | 51.95 | 74.00 | -22.05 | peak |
| 2 | 16500.000 | 34.76 | 18.73 | 53.49 | 68.20 | -14.71 | peak |

Note:1.Result (dBuV/m) = Correct Factor (dB/m) + Reading(dBuV).

2.Correction factor (dB/m) = Antenna Factor (dB/m) + Cable loss (dB) – Pre-Amplifier gain (dB).

3.When the peak results are less than average limit, so not need to evaluate the average.



| | | | |
|-------------|-----------------|----------------|-----|
| Standard: | FCC Part 15.407 | Test Distance: | 3 m |
| Test item: | Harmonic | | |
| Frequency: | 5500 MHz | | |
| Mode: | Mode 2 | | |
| Ant.Polar.: | Vertical | | |

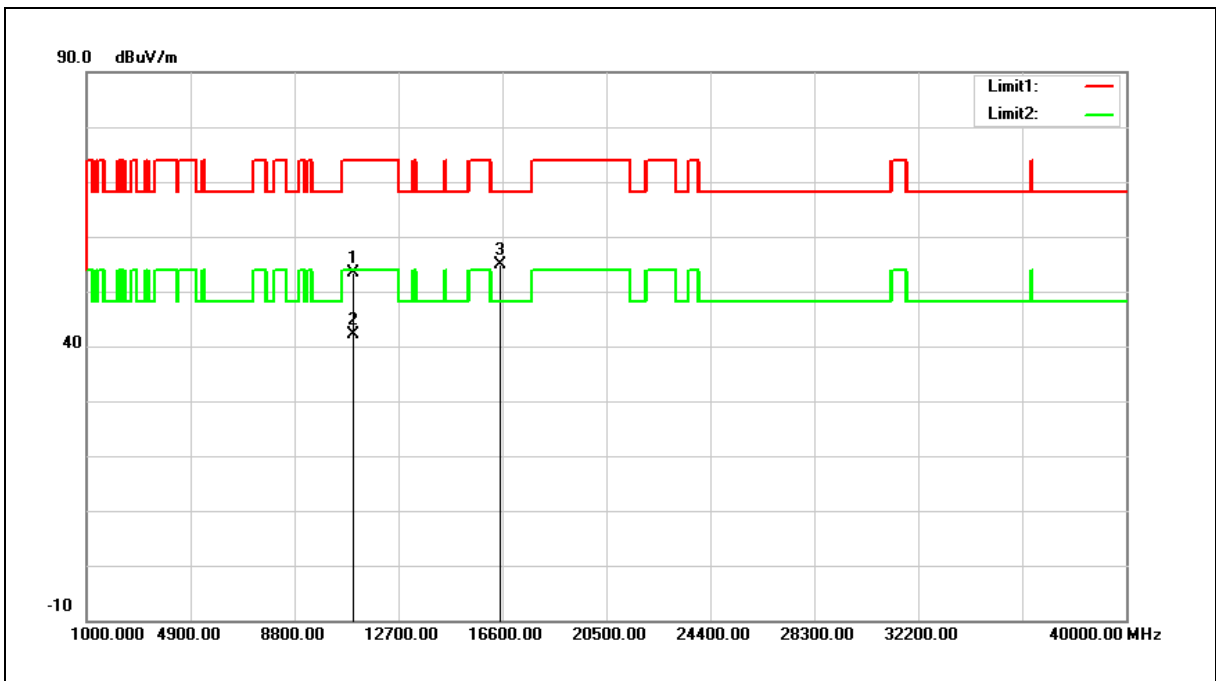

| No. | Frequency (MHz) | Reading (dBuV) | Correct Factor (dB/m) | Result (dBuV/m) | Limit (dBuV/m) | Margin (dB) | Remark |
|-----|-----------------|----------------|-----------------------|-----------------|----------------|-------------|--------|
| 1 | 11000.000 | 35.98 | 17.41 | 53.39 | 74.00 | -20.61 | peak |
| 2 | 11000.000 | 24.64 | 17.41 | 42.05 | 54.00 | -11.95 | AVG |
| 3 | 16500.000 | 36.22 | 18.73 | 54.95 | 68.20 | -13.25 | peak |

Note:1.Result (dBuV/m) = Correct Factor (dB/m) + Reading(dBuV).

2.Correction factor (dB/m) = Antenna Factor (dB/m) + Cable loss (dB) – Pre-Amplifier gain (dB).

3.When the peak results are less than average limit, so not need to evaluate the average.



| | | | |
|-------------|-----------------|----------------|-----|
| Standard: | FCC Part 15.407 | Test Distance: | 3 m |
| Test item: | Harmonic | | |
| Frequency: | 5560 MHz | | |
| Mode: | Mode 2 | | |
| Ant.Polar.: | Horizontal | | |

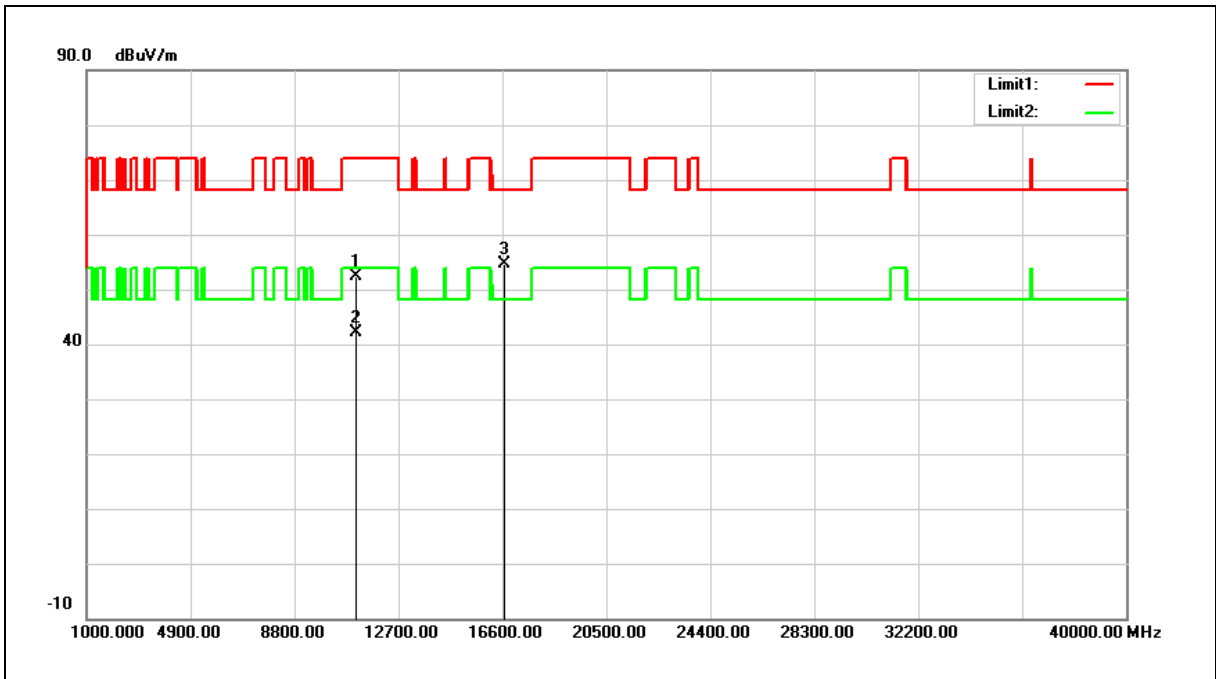

| No. | Frequency (MHz) | Reading (dBuV) | Correct Factor (dB/m) | Result (dBuV/m) | Limit (dBuV/m) | Margin (dB) | Remark |
|-----|-----------------|----------------|-----------------------|-----------------|----------------|-------------|--------|
| 1 | 11120.000 | 34.67 | 17.63 | 52.30 | 74.00 | -21.70 | peak |
| 2 | 11120.000 | 24.45 | 17.63 | 42.08 | 54.00 | -11.92 | AVG |
| 3 | 16680.000 | 34.52 | 20.19 | 54.71 | 68.20 | -13.49 | peak |

Note:1.Result (dBuV/m) = Correct Factor (dB/m) + Reading(dBuV).

2.Correction factor (dB/m) = Antenna Factor (dB/m) + Cable loss (dB) – Pre-Amplifier gain (dB).

3.When the peak results are less than average limit, so not need to evaluate the average.



| | | | |
|-------------|-----------------|----------------|-----|
| Standard: | FCC Part 15.407 | Test Distance: | 3 m |
| Test item: | Harmonic | | |
| Frequency: | 5560 MHz | | |
| Mode: | Mode 2 | | |
| Ant.Polar.: | Vertical | | |

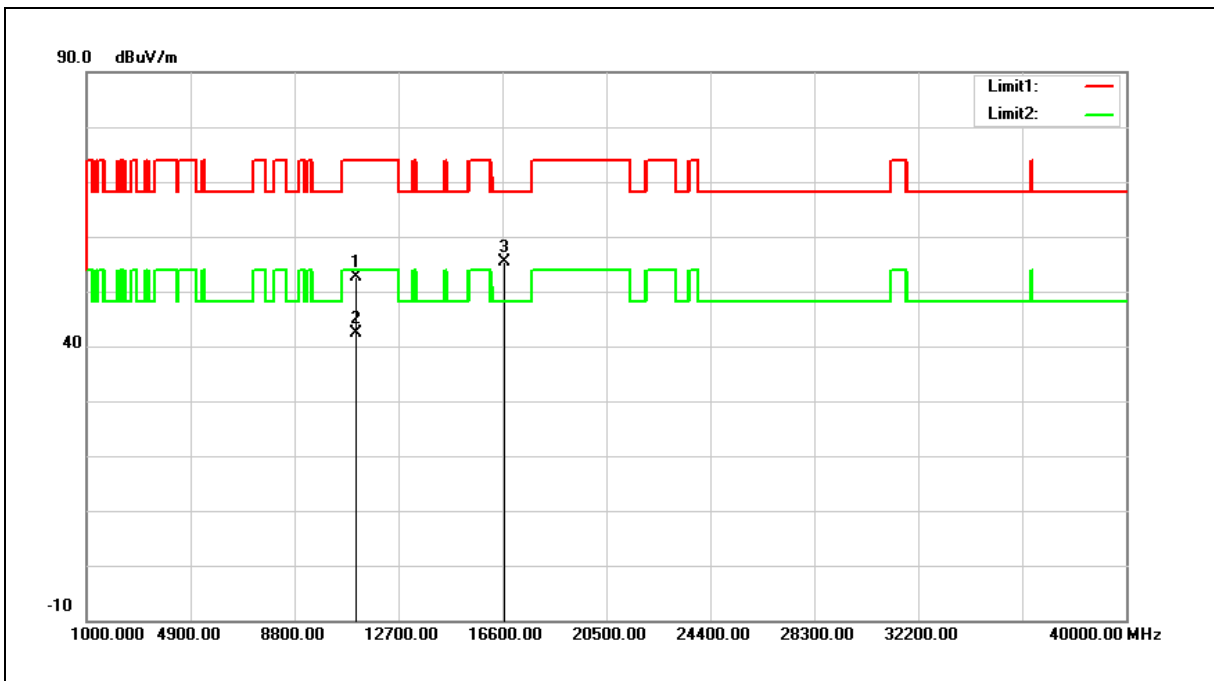

| No. | Frequency (MHz) | Reading (dBuV) | Correct Factor (dB/m) | Result (dBuV/m) | Limit (dBuV/m) | Margin (dB) | Remark |
|-----|-----------------|----------------|-----------------------|-----------------|----------------|-------------|--------|
| 1 | 11120.000 | 34.95 | 17.63 | 52.58 | 74.00 | -21.42 | peak |
| 2 | 11120.000 | 24.68 | 17.63 | 42.31 | 54.00 | -11.69 | AVG |
| 3 | 16680.000 | 35.10 | 20.19 | 55.29 | 68.20 | -12.91 | peak |

Note:1.Result (dBuV/m) = Correct Factor (dB/m) + Reading(dBuV).

2.Correction factor (dB/m) = Antenna Factor (dB/m) + Cable loss (dB) – Pre-Amplifier gain (dB).

3.When the peak results are less than average limit, so not need to evaluate the average.



| | | | |
|-------------|-----------------|----------------|-----|
| Standard: | FCC Part 15.407 | Test Distance: | 3 m |
| Test item: | Harmonic | | |
| Frequency: | 5700 MHz | | |
| Mode: | Mode 2 | | |
| Ant.Polar.: | Horizontal | | |

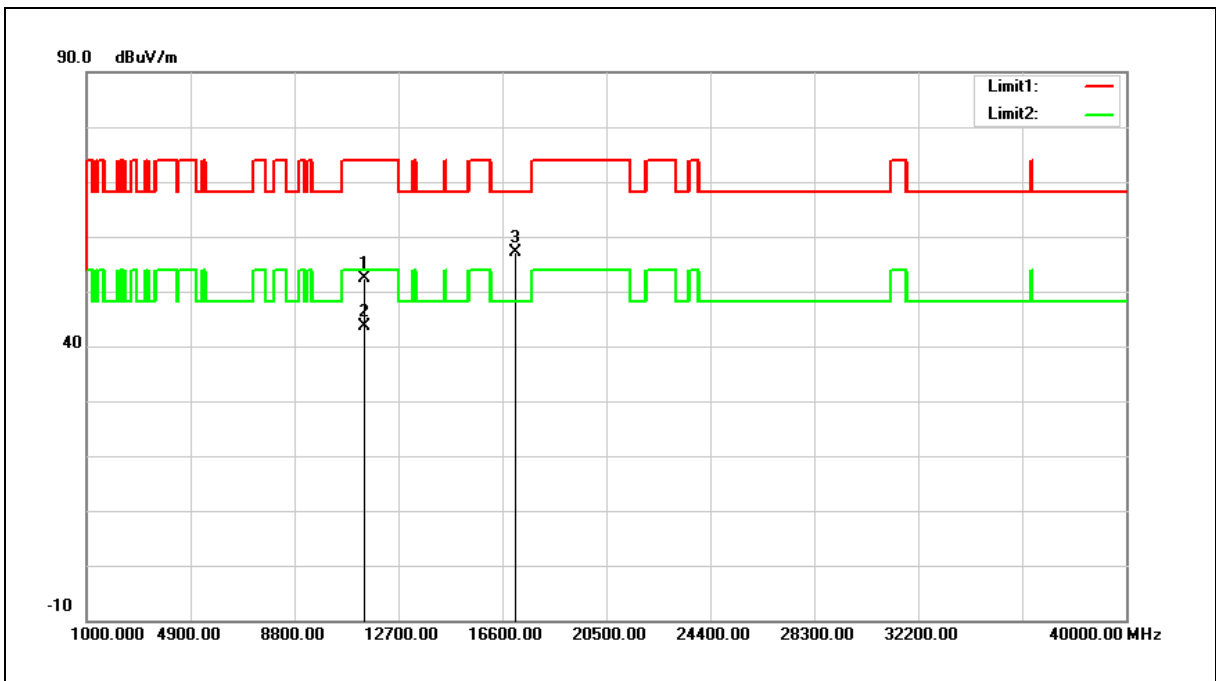

| No. | Frequency (MHz) | Reading (dBuV) | Correct Factor (dB/m) | Result (dBuV/m) | Limit (dBuV/m) | Margin (dB) | Remark |
|-----|-----------------|----------------|-----------------------|-----------------|----------------|-------------|--------|
| 1 | 11400.000 | 34.33 | 18.12 | 52.45 | 74.00 | -21.55 | peak |
| 2 | 11400.000 | 25.63 | 18.12 | 43.75 | 54.00 | -10.25 | AVG |
| 3 | 17100.000 | 33.91 | 23.26 | 57.17 | 68.20 | -11.03 | peak |

Note:1.Result (dBuV/m) = Correct Factor (dB/m) + Reading(dBuV).

2.Correction factor (dB/m) = Antenna Factor (dB/m) + Cable loss (dB) – Pre-Amplifier gain (dB).

3.When the peak results are less than average limit, so not need to evaluate the average.



| | | | |
|-------------|-----------------|----------------|-----|
| Standard: | FCC Part 15.407 | Test Distance: | 3 m |
| Test item: | Harmonic | | |
| Frequency: | 5700 MHz | | |
| Mode: | Mode 2 | | |
| Ant.Polar.: | Vertical | | |

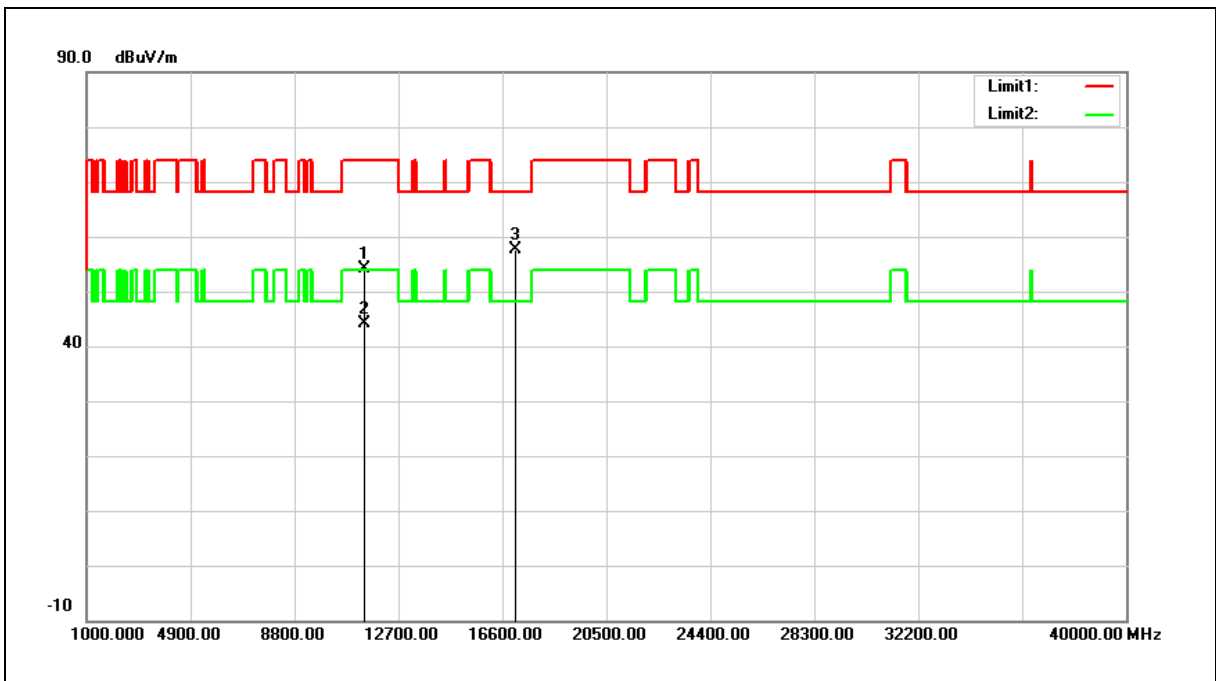

| No. | Frequency (MHz) | Reading (dBuV) | Correct Factor (dB/m) | Result (dBuV/m) | Limit (dBuV/m) | Margin (dB) | Remark |
|-----|-----------------|----------------|-----------------------|-----------------|----------------|-------------|--------|
| 1 | 11400.000 | 36.05 | 18.12 | 54.17 | 74.00 | -19.83 | peak |
| 2 | 11400.000 | 25.90 | 18.12 | 44.02 | 54.00 | -9.98 | AVG |
| 3 | 17100.000 | 34.31 | 23.26 | 57.57 | 68.20 | -10.63 | peak |

Note:1.Result (dBuV/m) = Correct Factor (dB/m) + Reading(dBuV).

2.Correction factor (dB/m) = Antenna Factor (dB/m) + Cable loss (dB) – Pre-Amplifier gain (dB).

3.When the peak results are less than average limit, so not need to evaluate the average.



| | | | |
|-------------|-----------------|----------------|-----|
| Standard: | FCC Part 15.407 | Test Distance: | 3 m |
| Test item: | Harmonic | | |
| Frequency: | 5720 MHz | | |
| Mode: | Mode 2 | | |
| Ant.Polar.: | Horizontal | | |

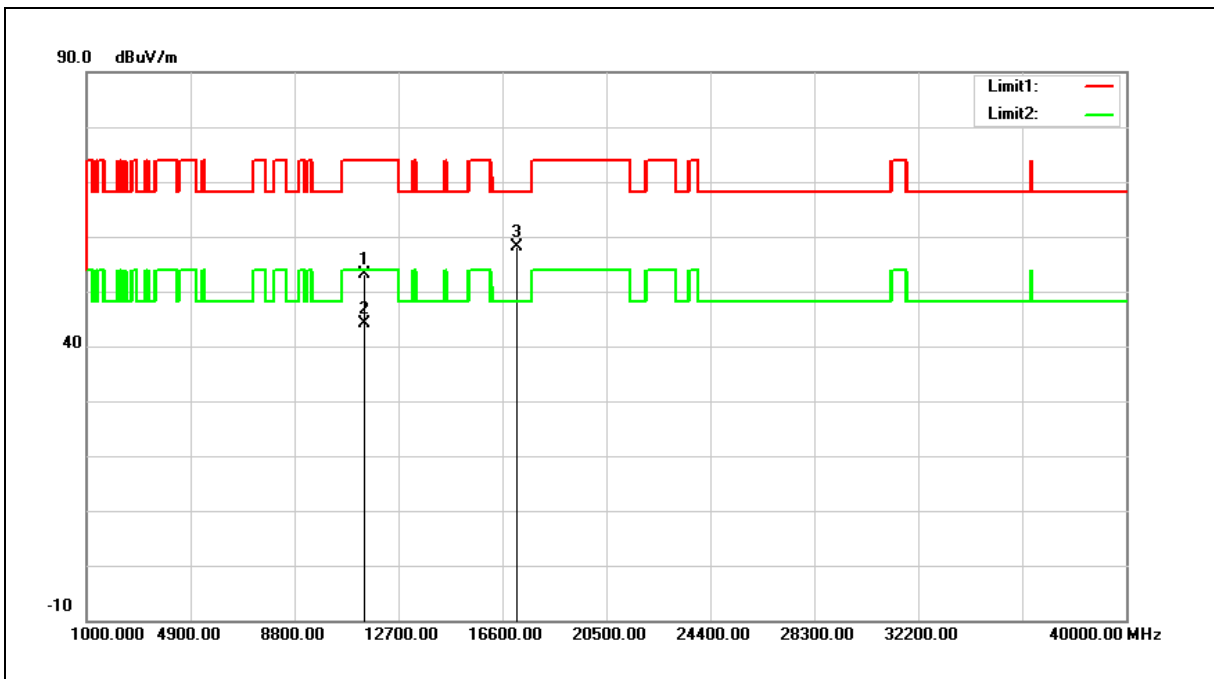

| No. | Frequency (MHz) | Reading (dBuV) | Correct Factor (dB/m) | Result (dBuV/m) | Limit (dBuV/m) | Margin (dB) | Remark |
|-----|-----------------|----------------|-----------------------|-----------------|----------------|-------------|--------|
| 1 | 11440.000 | 34.93 | 18.20 | 53.13 | 74.00 | -20.87 | peak |
| 2 | 11440.000 | 25.99 | 18.20 | 44.19 | 54.00 | -9.81 | AVG |
| 3 | 17160.000 | 34.65 | 23.54 | 58.19 | 68.20 | -10.01 | peak |

Note:1.Result (dBuV/m) = Correct Factor (dB/m) + Reading(dBuV).

2.Correction factor (dB/m) = Antenna Factor (dB/m) + Cable loss (dB) – Pre-Amplifier gain (dB).

3.When the peak results are less than average limit, so not need to evaluate the average.



| | | | |
|-------------|-----------------|----------------|-----|
| Standard: | FCC Part 15.407 | Test Distance: | 3 m |
| Test item: | Harmonic | | |
| Frequency: | 5720 MHz | | |
| Mode: | Mode 2 | | |
| Ant.Polar.: | Vertical | | |

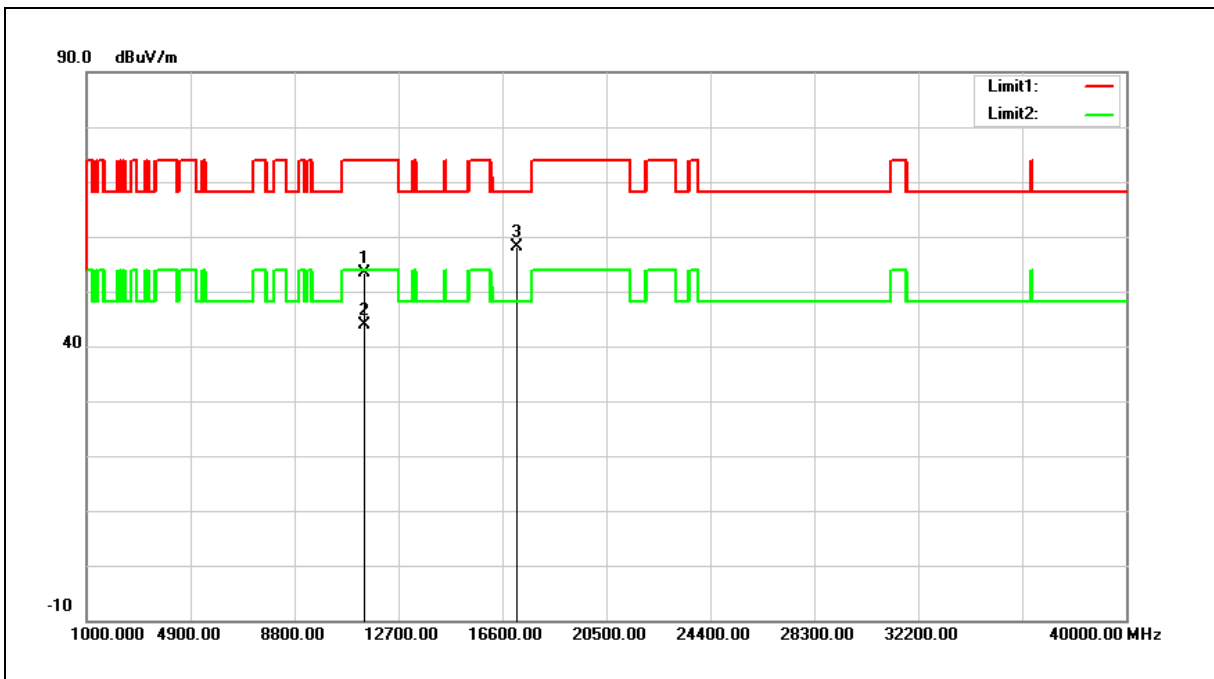

| No. | Frequency (MHz) | Reading (dBuV) | Correct Factor (dB/m) | Result (dBuV/m) | Limit (dBuV/m) | Margin (dB) | Remark |
|-----|-----------------|----------------|-----------------------|-----------------|----------------|-------------|--------|
| 1 | 11440.000 | 35.22 | 18.20 | 53.42 | 74.00 | -20.58 | peak |
| 2 | 11440.000 | 25.66 | 18.20 | 43.86 | 54.00 | -10.14 | AVG |
| 3 | 17160.000 | 34.59 | 23.54 | 58.13 | 68.20 | -10.07 | peak |

Note:1.Result (dBuV/m) = Correct Factor (dB/m) + Reading(dBuV).

2.Correction factor (dB/m) = Antenna Factor (dB/m) + Cable loss (dB) – Pre-Amplifier gain (dB).

3.When the peak results are less than average limit, so not need to evaluate the average.



| | | | |
|-------------|-----------------|----------------|-----|
| Standard: | FCC Part 15.407 | Test Distance: | 3 m |
| Test item: | Harmonic | | |
| Frequency: | 5745 MHz | | |
| Mode: | Mode 2 | | |
| Ant.Polar.: | Horizontal | | |

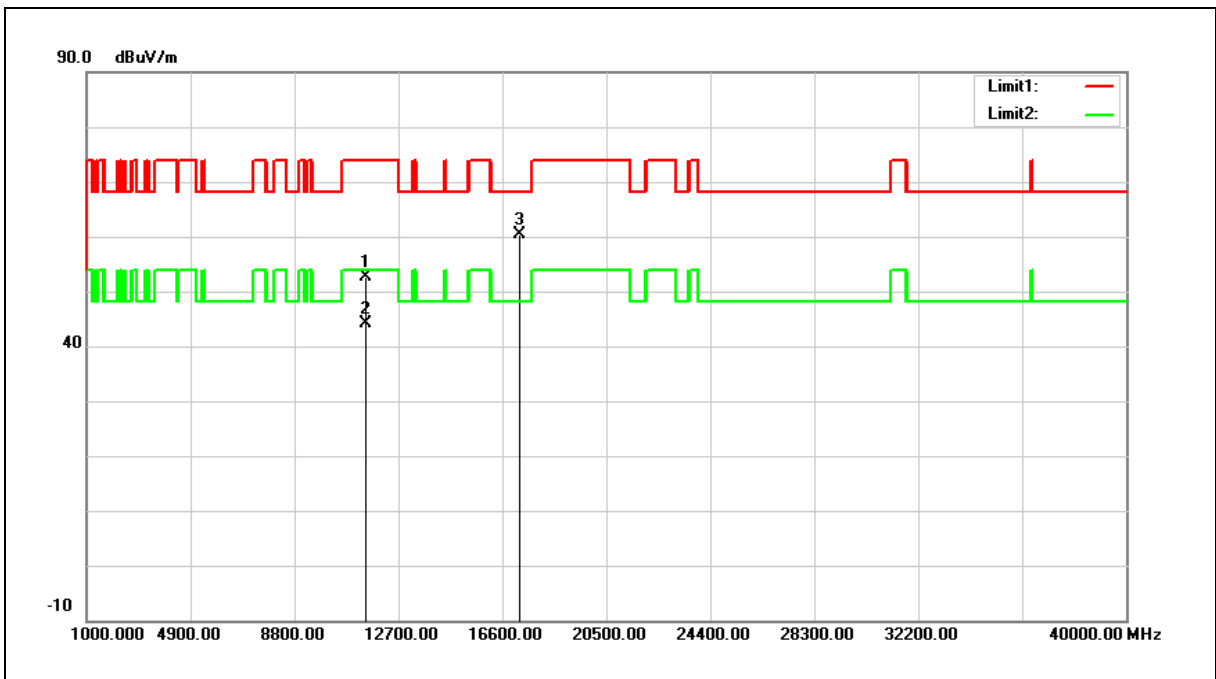

| No. | Frequency (MHz) | Reading (dBuV) | Correct Factor (dB/m) | Result (dBuV/m) | Limit (dBuV/m) | Margin (dB) | Remark |
|-----|-----------------|----------------|-----------------------|-----------------|----------------|-------------|--------|
| 1 | 11490.000 | 34.38 | 18.28 | 52.66 | 74.00 | -21.34 | peak |
| 2 | 11490.000 | 25.94 | 18.28 | 44.22 | 54.00 | -9.78 | AVG |
| 3 | 17235.000 | 36.36 | 23.90 | 60.26 | 68.20 | -7.94 | peak |

Note:1.Result (dBuV/m) = Correct Factor (dB/m) + Reading(dBuV).

2.Correction factor (dB/m) = Antenna Factor (dB/m) + Cable loss (dB) – Pre-Amplifier gain (dB).

3.When the peak results are less than average limit, so not need to evaluate the average.



| | | | |
|-------------|-----------------|----------------|-----|
| Standard: | FCC Part 15.407 | Test Distance: | 3 m |
| Test item: | Harmonic | | |
| Frequency: | 5745 MHz | | |
| Mode: | Mode 2 | | |
| Ant.Polar.: | Vertical | | |

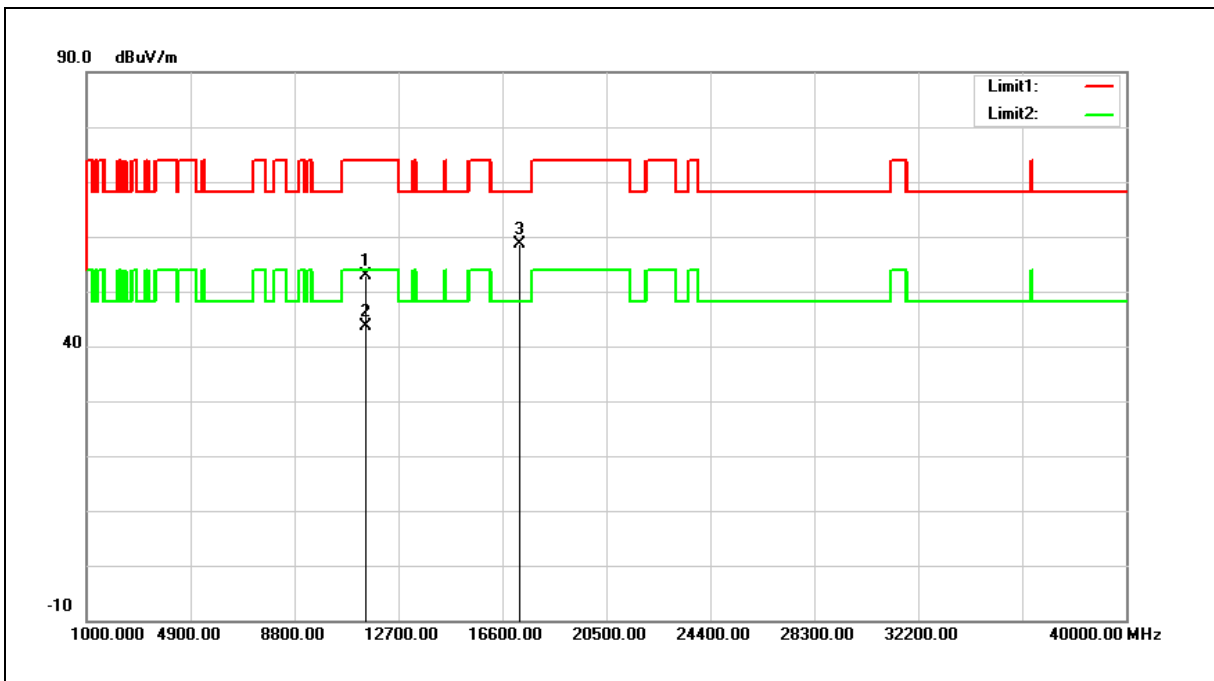

| No. | Frequency (MHz) | Reading (dBuV) | Correct Factor (dB/m) | Result (dBuV/m) | Limit (dBuV/m) | Margin (dB) | Remark |
|-----|-----------------|----------------|-----------------------|-----------------|----------------|-------------|--------|
| 1 | 11490.000 | 34.67 | 18.28 | 52.95 | 74.00 | -21.05 | peak |
| 2 | 11490.000 | 25.29 | 18.28 | 43.57 | 54.00 | -10.43 | AVG |
| 3 | 17235.000 | 34.64 | 23.90 | 58.54 | 68.20 | -9.66 | peak |

Note:1.Result (dBuV/m) = Correct Factor (dB/m) + Reading(dBuV).

2.Correction factor (dB/m) = Antenna Factor (dB/m) + Cable loss (dB) – Pre-Amplifier gain (dB).

3.When the peak results are less than average limit, so not need to evaluate the average.



| | | | |
|-------------|-----------------|----------------|-----|
| Standard: | FCC Part 15.407 | Test Distance: | 3 m |
| Test item: | Harmonic | | |
| Frequency: | 5785 MHz | | |
| Mode: | Mode 2 | | |
| Ant.Polar.: | Horizontal | | |

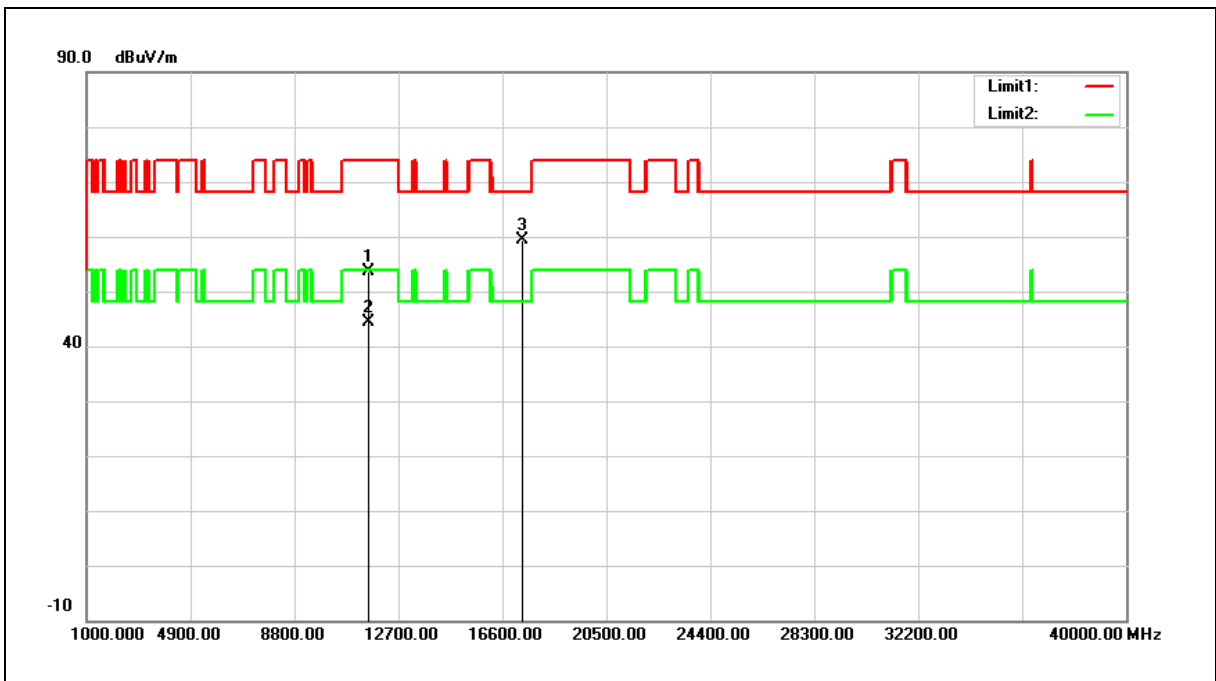

| No. | Frequency (MHz) | Reading (dBuV) | Correct Factor (dB/m) | Result (dBuV/m) | Limit (dBuV/m) | Margin (dB) | Remark |
|-----|-----------------|----------------|-----------------------|-----------------|----------------|-------------|--------|
| 1 | 11570.000 | 35.47 | 18.14 | 53.61 | 74.00 | -20.39 | peak |
| 2 | 11570.000 | 26.22 | 18.14 | 44.36 | 54.00 | -9.64 | AVG |
| 3 | 17355.000 | 34.93 | 24.46 | 59.39 | 68.20 | -8.81 | peak |

Note:1.Result (dBuV/m) = Correct Factor (dB/m) + Reading(dBuV).

2.Correction factor (dB/m) = Antenna Factor (dB/m) + Cable loss (dB) – Pre-Amplifier gain (dB).

3.When the peak results are less than average limit, so not need to evaluate the average.



| | | | |
|-------------|-----------------|----------------|-----|
| Standard: | FCC Part 15.407 | Test Distance: | 3 m |
| Test item: | Harmonic | | |
| Frequency: | 5785 MHz | | |
| Mode: | Mode 2 | | |
| Ant.Polar.: | Vertical | | |

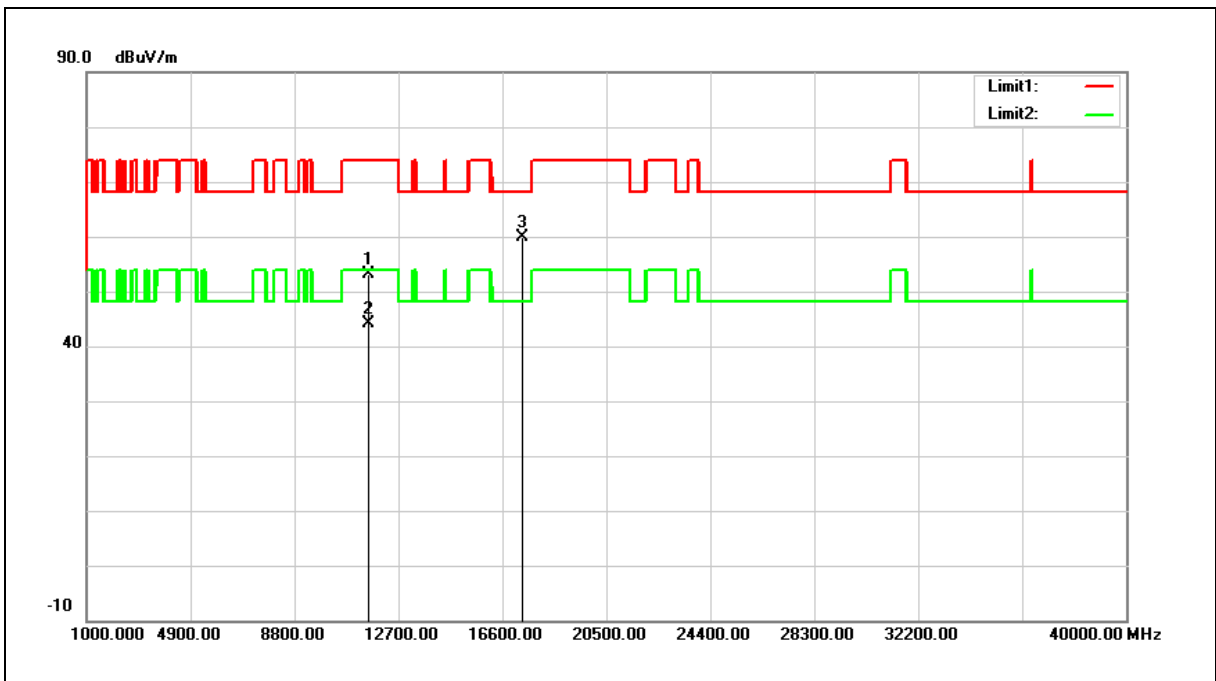

| No. | Frequency (MHz) | Reading (dBuV) | Correct Factor (dB/m) | Result (dBuV/m) | Limit (dBuV/m) | Margin (dB) | Remark |
|-----|-----------------|----------------|-----------------------|-----------------|----------------|-------------|--------|
| 1 | 11570.000 | 35.09 | 18.14 | 53.23 | 74.00 | -20.77 | peak |
| 2 | 11570.000 | 25.97 | 18.14 | 44.11 | 54.00 | -9.89 | AVG |
| 3 | 17355.000 | 35.46 | 24.46 | 59.92 | 68.20 | -8.28 | peak |

Note:1.Result (dBuV/m) = Correct Factor (dB/m) + Reading(dBuV).

2.Correction factor (dB/m) = Antenna Factor (dB/m) + Cable loss (dB) – Pre-Amplifier gain (dB).

3.When the peak results are less than average limit, so not need to evaluate the average.



| | | | |
|-------------|-----------------|----------------|-----|
| Standard: | FCC Part 15.407 | Test Distance: | 3 m |
| Test item: | Harmonic | | |
| Frequency: | 5825 MHz | | |
| Mode: | Mode 2 | | |
| Ant.Polar.: | Horizontal | | |

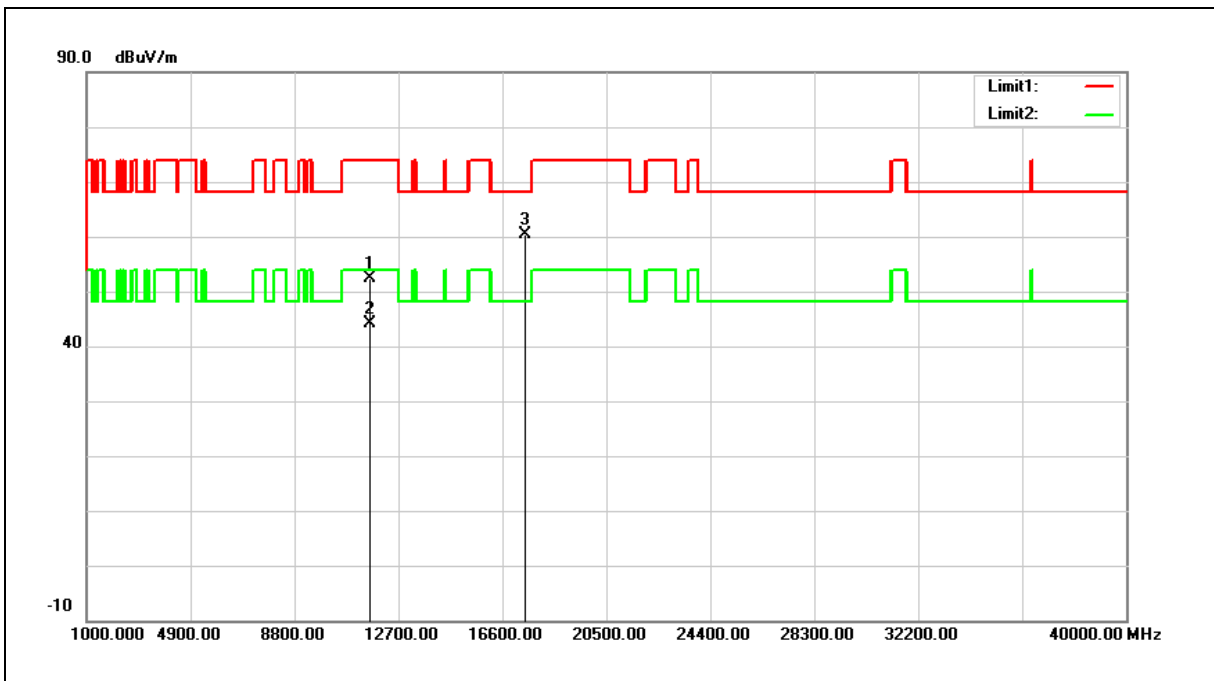

| No. | Frequency (MHz) | Reading (dBuV) | Correct Factor (dB/m) | Result (dBuV/m) | Limit (dBuV/m) | Margin (dB) | Remark |
|-----|-----------------|----------------|-----------------------|-----------------|----------------|-------------|--------|
| 1 | 11650.000 | 34.35 | 17.97 | 52.32 | 74.00 | -21.68 | peak |
| 2 | 11650.000 | 26.22 | 17.97 | 44.19 | 54.00 | -9.81 | AVG |
| 3 | 17475.000 | 35.26 | 25.01 | 60.27 | 68.20 | -7.93 | peak |

Note:1.Result (dBuV/m) = Correct Factor (dB/m) + Reading(dBuV).

2.Correction factor (dB/m) = Antenna Factor (dB/m) + Cable loss (dB) – Pre-Amplifier gain (dB).

3.When the peak results are less than average limit, so not need to evaluate the average.



| | | | |
|-------------|-----------------|----------------|-----|
| Standard: | FCC Part 15.407 | Test Distance: | 3 m |
| Test item: | Harmonic | | |
| Frequency: | 5825 MHz | | |
| Mode: | Mode 2 | | |
| Ant.Polar.: | Vertical | | |

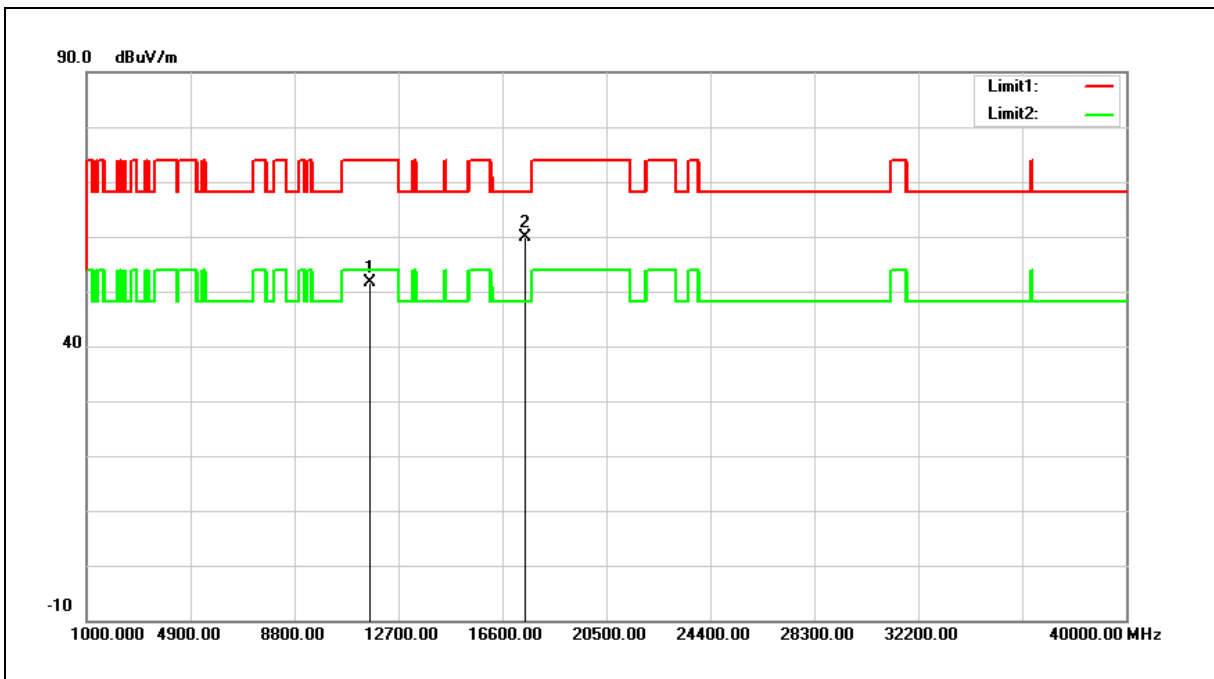

| No. | Frequency (MHz) | Reading (dBuV) | Correct Factor (dB/m) | Result (dBuV/m) | Limit (dBuV/m) | Margin (dB) | Remark |
|-----|-----------------|----------------|-----------------------|-----------------|----------------|-------------|--------|
| 1 | 11650.000 | 33.62 | 17.97 | 51.59 | 74.00 | -22.41 | peak |
| 2 | 17475.000 | 34.77 | 25.01 | 59.78 | 68.20 | -8.42 | peak |

Note:1.Result (dBuV/m) = Correct Factor (dB/m) + Reading(dBuV).

2.Correction factor (dB/m) = Antenna Factor (dB/m) + Cable loss (dB) – Pre-Amplifier gain (dB).

3.When the peak results are less than average limit, so not need to evaluate the average.



| | | | |
|-------------|-----------------|----------------|-----|
| Standard: | FCC Part 15.407 | Test Distance: | 3 m |
| Test item: | Harmonic | | |
| Frequency: | 5180 MHz | | |
| Mode: | Mode 8 | | |
| Ant.Polar.: | Horizontal | | |

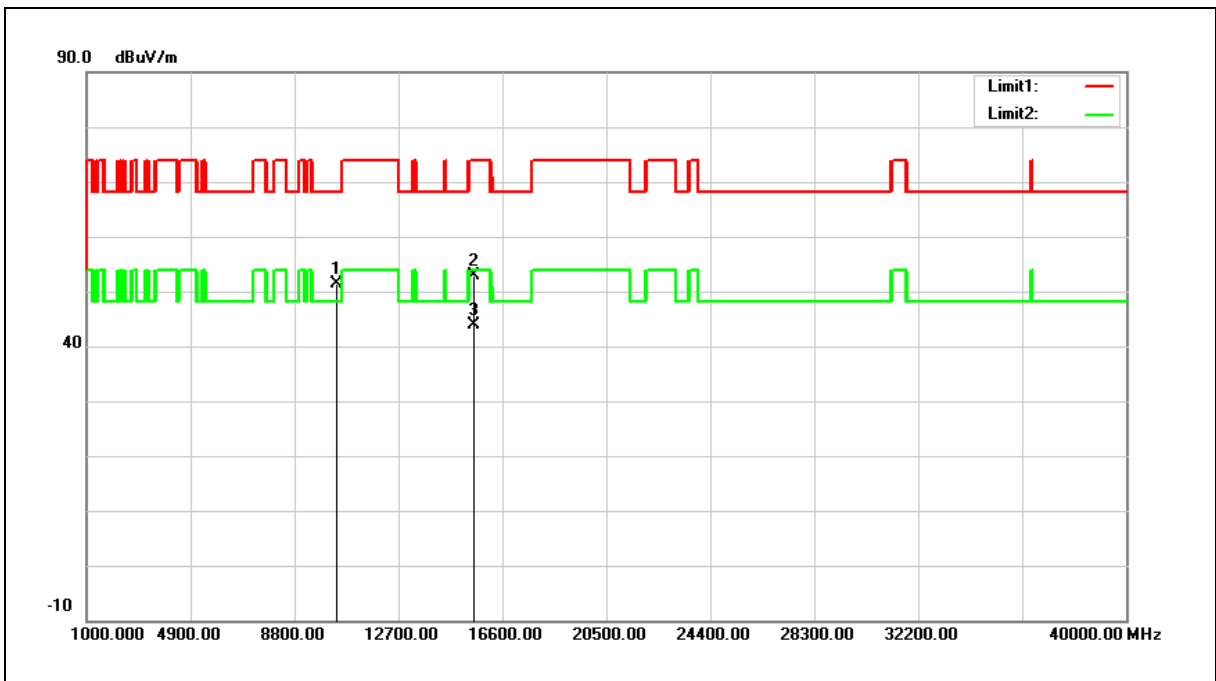

| No. | Frequency (MHz) | Reading (dBuV) | Correct Factor (dB/m) | Result (dBuV/m) | Limit (dBuV/m) | Margin (dB) | Remark |
|-----|-----------------|----------------|-----------------------|-----------------|----------------|-------------|--------|
| 1 | 10360.000 | 34.68 | 16.60 | 51.28 | 68.20 | -16.92 | peak |
| 2 | 15540.000 | 33.99 | 18.94 | 52.93 | 74.00 | -21.07 | peak |
| 3 | 15540.000 | 25.05 | 18.94 | 43.99 | 54.00 | -10.01 | AVG |

Note:1.Result (dBuV/m) = Correct Factor (dB/m) + Reading(dBuV).

2.Correction factor (dB/m) = Antenna Factor (dB/m) + Cable loss (dB) – Pre-Amplifier gain (dB).

3.When the peak results are less than average limit, so not need to evaluate the average.



| | | | |
|-------------|-----------------|----------------|-----|
| Standard: | FCC Part 15.407 | Test Distance: | 3 m |
| Test item: | Harmonic | | |
| Frequency: | 5180 MHz | | |
| Mode: | Mode 8 | | |
| Ant.Polar.: | Vertical | | |

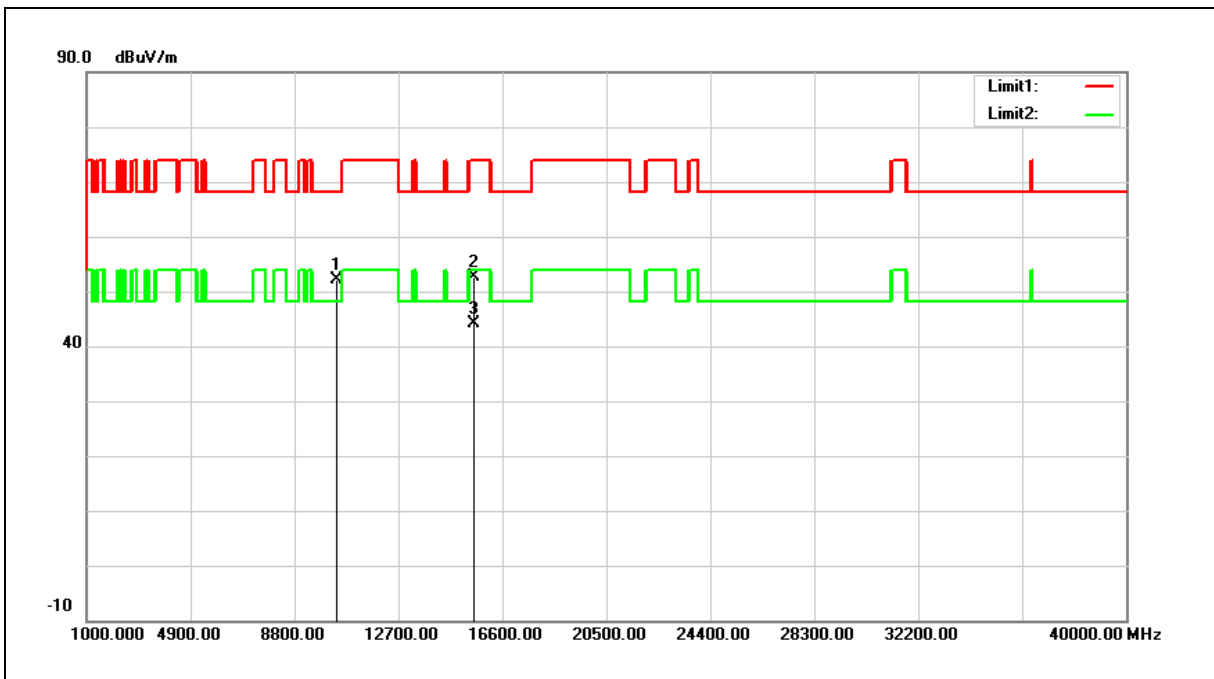

| No. | Frequency (MHz) | Reading (dBuV) | Correct Factor (dB/m) | Result (dBuV/m) | Limit (dBuV/m) | Margin (dB) | Remark |
|-----|-----------------|----------------|-----------------------|-----------------|----------------|-------------|--------|
| 1 | 10360.000 | 35.65 | 16.60 | 52.25 | 68.20 | -15.95 | peak |
| 2 | 15540.000 | 33.75 | 18.94 | 52.69 | 74.00 | -21.31 | peak |
| 3 | 15540.000 | 25.23 | 18.94 | 44.17 | 54.00 | -9.83 | AVG |

Note:1.Result (dBuV/m) = Correct Factor (dB/m) + Reading(dBuV).

2.Correction factor (dB/m) = Antenna Factor (dB/m) + Cable loss (dB) – Pre-Amplifier gain (dB).

3.When the peak results are less than average limit, so not need to evaluate the average.



| | | | |
|-------------|-----------------|----------------|-----|
| Standard: | FCC Part 15.407 | Test Distance: | 3 m |
| Test item: | Harmonic | | |
| Frequency: | 5200 MHz | | |
| Mode: | Mode 8 | | |
| Ant.Polar.: | Horizontal | | |

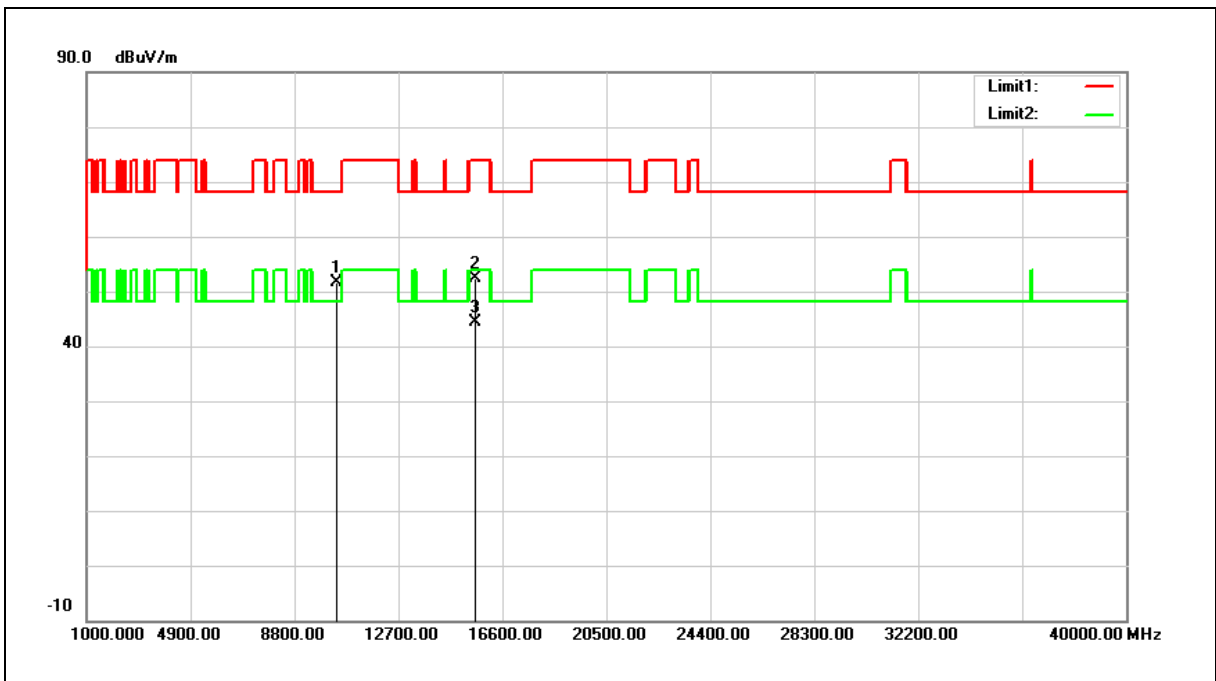

| No. | Frequency (MHz) | Reading (dBuV) | Correct Factor (dB/m) | Result (dBuV/m) | Limit (dBuV/m) | Margin (dB) | Remark |
|-----|-----------------|----------------|-----------------------|-----------------|----------------|-------------|--------|
| 1 | 10400.000 | 34.99 | 16.73 | 51.72 | 68.20 | -16.48 | peak |
| 2 | 15600.000 | 33.70 | 18.68 | 52.38 | 74.00 | -21.62 | peak |
| 3 | 15600.000 | 25.58 | 18.68 | 44.26 | 54.00 | -9.74 | AVG |

Note:1.Result (dBuV/m) = Correct Factor (dB/m) + Reading(dBuV).

2.Correction factor (dB/m) = Antenna Factor (dB/m) + Cable loss (dB) – Pre-Amplifier gain (dB).

3.When the peak results are less than average limit, so not need to evaluate the average.



| | | | |
|-------------|-----------------|----------------|-----|
| Standard: | FCC Part 15.407 | Test Distance: | 3 m |
| Test item: | Harmonic | | |
| Frequency: | 5200 MHz | | |
| Mode: | Mode 8 | | |
| Ant.Polar.: | Vertical | | |

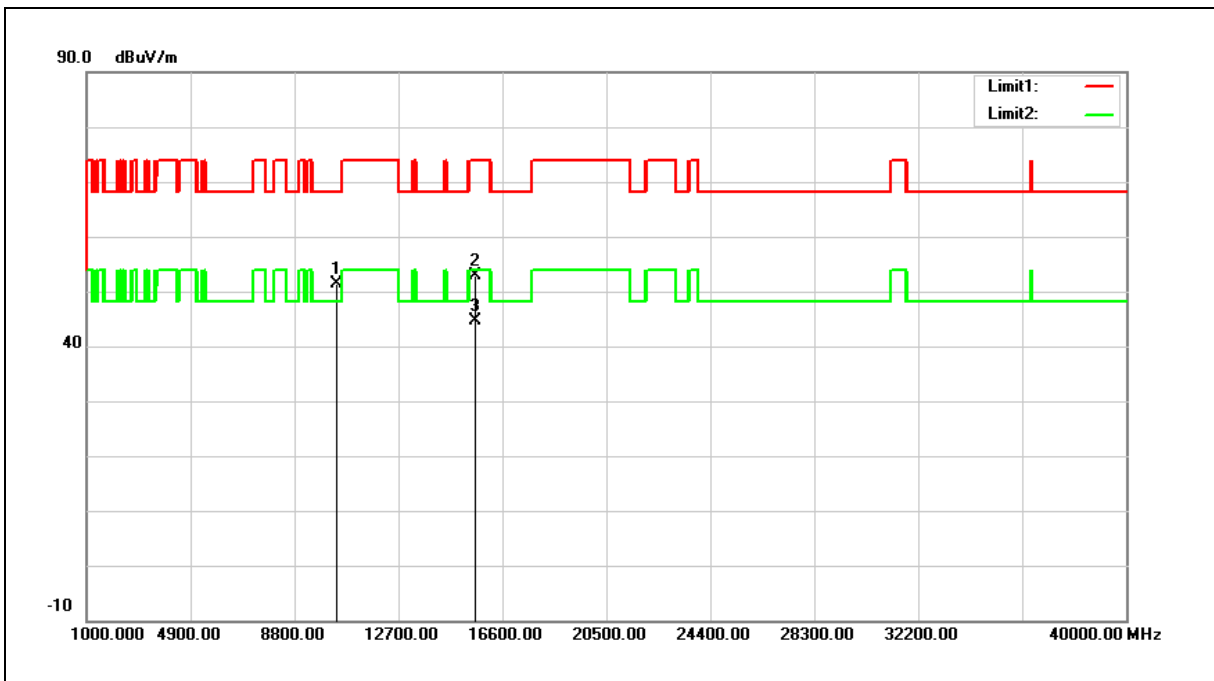

| No. | Frequency (MHz) | Reading (dBuV) | Correct Factor (dB/m) | Result (dBuV/m) | Limit (dBuV/m) | Margin (dB) | Remark |
|-----|-----------------|----------------|-----------------------|-----------------|----------------|-------------|--------|
| 1 | 10400.000 | 34.55 | 16.73 | 51.28 | 68.20 | -16.92 | peak |
| 2 | 15600.000 | 34.30 | 18.68 | 52.98 | 74.00 | -21.02 | peak |
| 3 | 15600.000 | 25.91 | 18.68 | 44.59 | 54.00 | -9.41 | AVG |

Note:1.Result (dBuV/m) = Correct Factor (dB/m) + Reading(dBuV).

2.Correction factor (dB/m) = Antenna Factor (dB/m) + Cable loss (dB) – Pre-Amplifier gain (dB).

3.When the peak results are less than average limit, so not need to evaluate the average.



| | | | |
|-------------|-----------------|----------------|-----|
| Standard: | FCC Part 15.407 | Test Distance: | 3 m |
| Test item: | Harmonic | | |
| Frequency: | 5240 MHz | | |
| Mode: | Mode 8 | | |
| Ant.Polar.: | Horizontal | | |

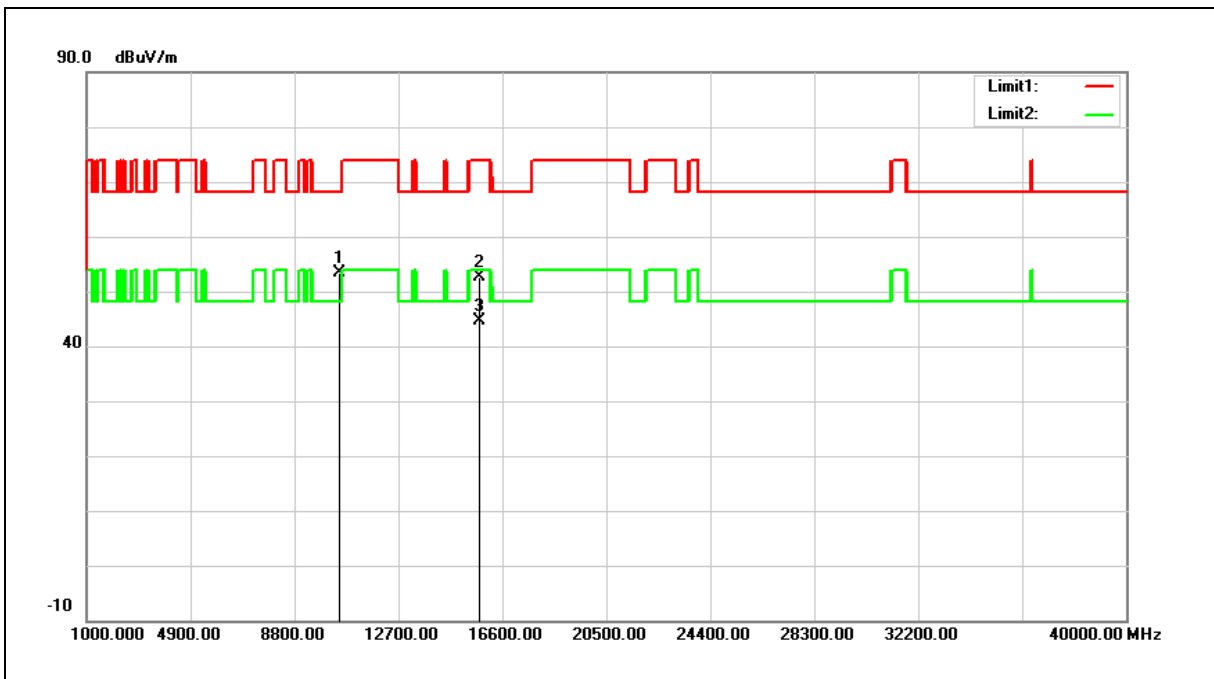

| No. | Frequency (MHz) | Reading (dBuV) | Correct Factor (dB/m) | Result (dBuV/m) | Limit (dBuV/m) | Margin (dB) | Remark |
|-----|-----------------|----------------|-----------------------|-----------------|----------------|-------------|--------|
| 1 | 10480.000 | 36.35 | 16.98 | 53.33 | 68.20 | -14.87 | peak |
| 2 | 15720.000 | 34.46 | 18.17 | 52.63 | 74.00 | -21.37 | peak |
| 3 | 15720.000 | 26.38 | 18.17 | 44.55 | 54.00 | -9.45 | AVG |

Note:1.Result (dBuV/m) = Correct Factor (dB/m) + Reading(dBuV).

2.Correction factor (dB/m) = Antenna Factor (dB/m) + Cable loss (dB) – Pre-Amplifier gain (dB).

3.When the peak results are less than average limit, so not need to evaluate the average.



| | | | |
|-------------|-----------------|----------------|-----|
| Standard: | FCC Part 15.407 | Test Distance: | 3 m |
| Test item: | Harmonic | | |
| Frequency: | 5240 MHz | | |
| Mode: | Mode 8 | | |
| Ant.Polar.: | Vertical | | |

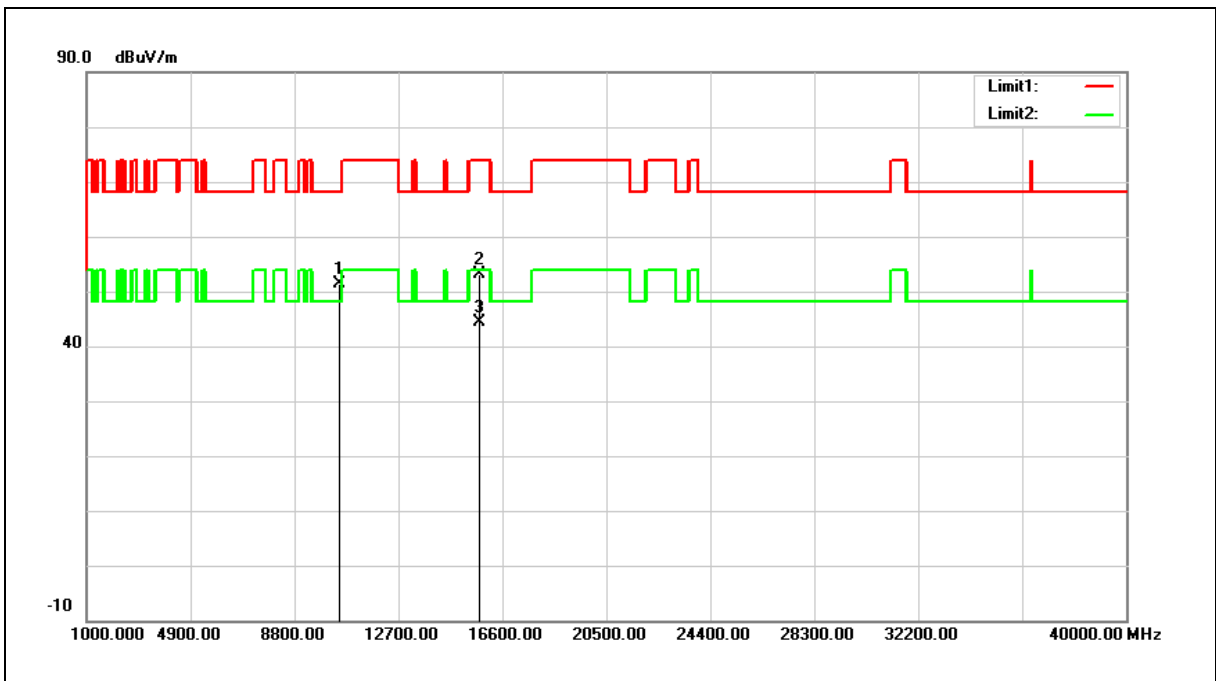

| No. | Frequency (MHz) | Reading (dBuV) | Correct Factor (dB/m) | Result (dBuV/m) | Limit (dBuV/m) | Margin (dB) | Remark |
|-----|-----------------|----------------|-----------------------|-----------------|----------------|-------------|--------|
| 1 | 10480.000 | 34.37 | 16.98 | 51.35 | 68.20 | -16.85 | peak |
| 2 | 15720.000 | 34.85 | 18.17 | 53.02 | 74.00 | -20.98 | peak |
| 3 | 15720.000 | 26.19 | 18.17 | 44.36 | 54.00 | -9.64 | AVG |

Note:1.Result (dBuV/m) = Correct Factor (dB/m) + Reading(dBuV).

2.Correction factor (dB/m) = Antenna Factor (dB/m) + Cable loss (dB) – Pre-Amplifier gain (dB).

3.When the peak results are less than average limit, so not need to evaluate the average.



| | | | |
|-------------|-----------------|----------------|-----|
| Standard: | FCC Part 15.407 | Test Distance: | 3 m |
| Test item: | Harmonic | | |
| Frequency: | 5260 MHz | | |
| Mode: | Mode 8 | | |
| Ant.Polar.: | Horizontal | | |

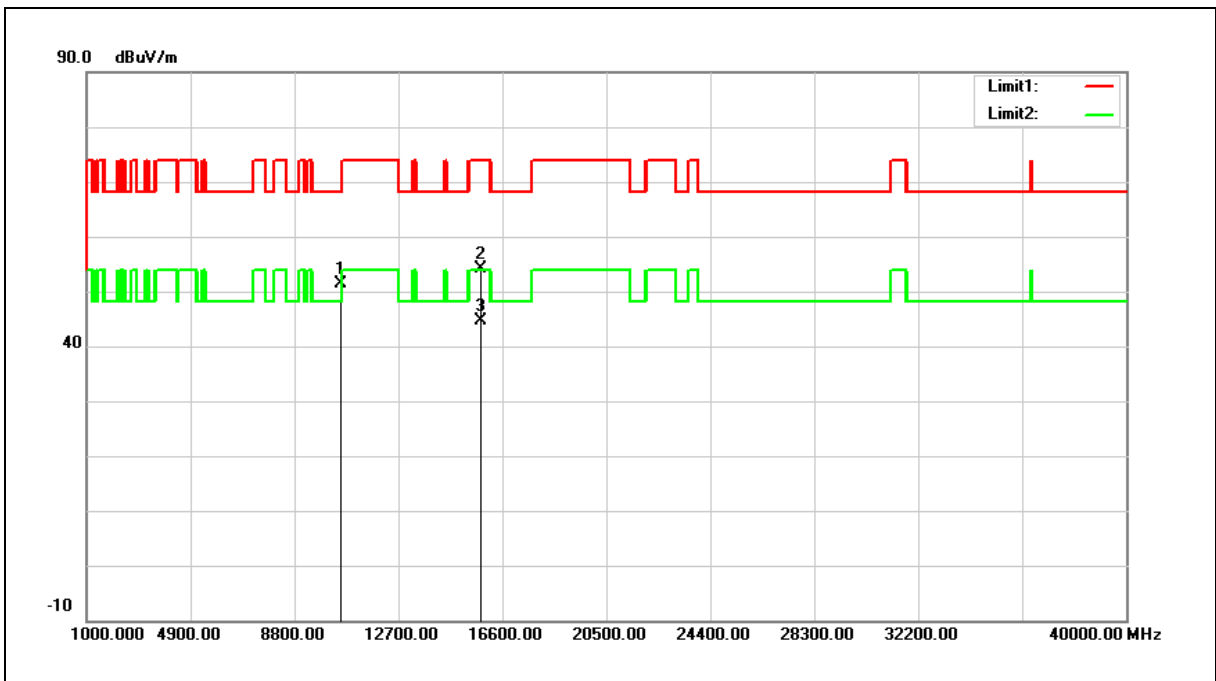

| No. | Frequency (MHz) | Reading (dBuV) | Correct Factor (dB/m) | Result (dBuV/m) | Limit (dBuV/m) | Margin (dB) | Remark |
|-----|-----------------|----------------|-----------------------|-----------------|----------------|-------------|--------|
| 1 | 10520.000 | 34.40 | 17.05 | 51.45 | 68.20 | -16.75 | peak |
| 2 | 15780.000 | 36.22 | 17.94 | 54.16 | 74.00 | -19.84 | peak |
| 3 | 15780.000 | 26.71 | 17.94 | 44.65 | 54.00 | -9.35 | AVG |

Note:1.Result (dBuV/m) = Correct Factor (dB/m) + Reading(dBuV).

2.Correction factor (dB/m) = Antenna Factor (dB/m) + Cable loss (dB) – Pre-Amplifier gain (dB).

3.When the peak results are less than average limit, so not need to evaluate the average.



| | | | |
|-------------|-----------------|----------------|-----|
| Standard: | FCC Part 15.407 | Test Distance: | 3 m |
| Test item: | Harmonic | | |
| Frequency: | 5260 MHz | | |
| Mode: | Mode 8 | | |
| Ant.Polar.: | Vertical | | |

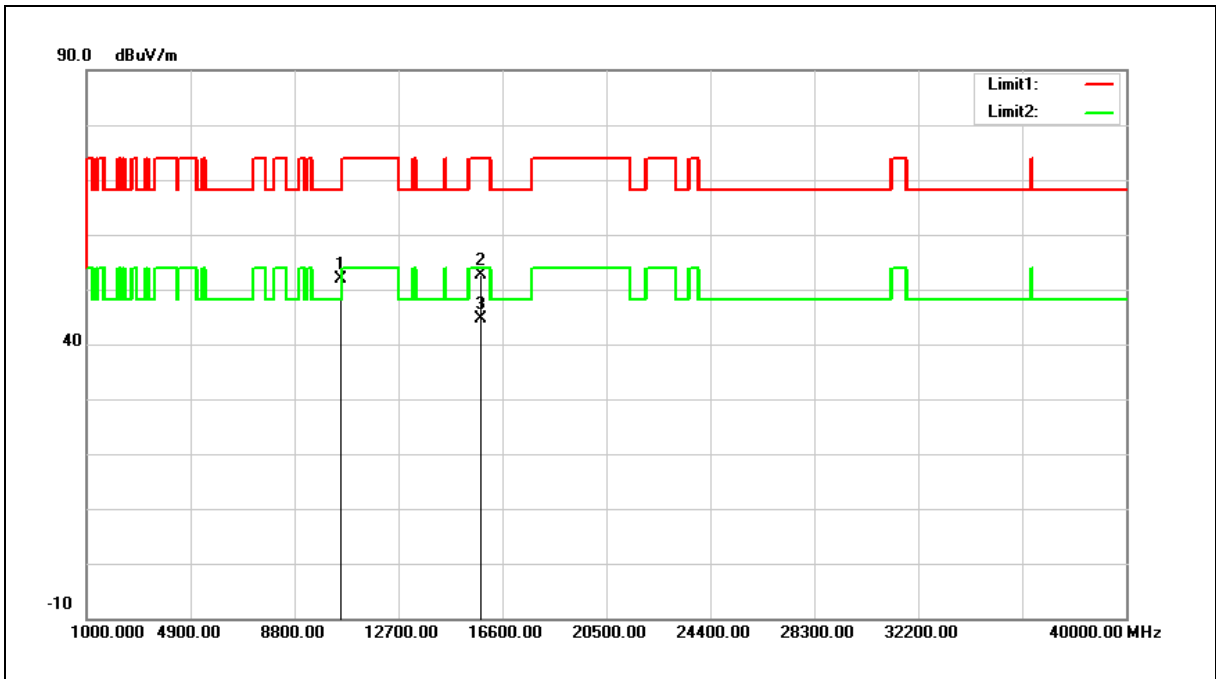

| No. | Frequency (MHz) | Reading (dBuV) | Correct Factor (dB/m) | Result (dBuV/m) | Limit (dBuV/m) | Margin (dB) | Remark |
|-----|-----------------|----------------|-----------------------|-----------------|----------------|-------------|--------|
| 1 | 10520.000 | 34.76 | 17.05 | 51.81 | 68.20 | -16.39 | peak |
| 2 | 15780.000 | 34.66 | 17.94 | 52.60 | 74.00 | -21.40 | peak |
| 3 | 15780.000 | 26.79 | 17.94 | 44.73 | 54.00 | -9.27 | AVG |

Note:1.Result (dBuV/m) = Correct Factor (dB/m) + Reading(dBuV).

2.Correction factor (dB/m) = Antenna Factor (dB/m) + Cable loss (dB) – Pre-Amplifier gain (dB).

3.When the peak results are less than average limit, so not need to evaluate the average.



| | | | |
|-------------|-----------------|----------------|-----|
| Standard: | FCC Part 15.407 | Test Distance: | 3 m |
| Test item: | Harmonic | | |
| Frequency: | 5280 MHz | | |
| Mode: | Mode 8 | | |
| Ant.Polar.: | Horizontal | | |

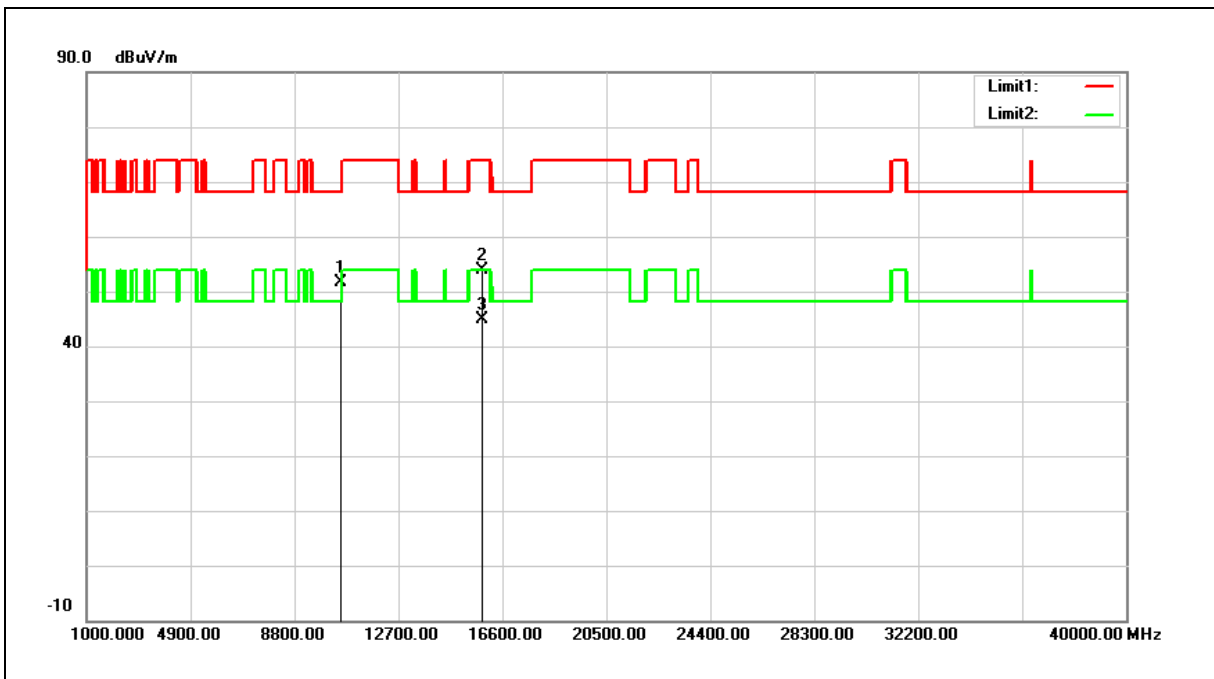

| No. | Frequency (MHz) | Reading (dBuV) | Correct Factor (dB/m) | Result (dBuV/m) | Limit (dBuV/m) | Margin (dB) | Remark |
|-----|-----------------|----------------|-----------------------|-----------------|----------------|-------------|--------|
| 1 | 10560.000 | 34.47 | 17.08 | 51.55 | 68.20 | -16.65 | peak |
| 2 | 15840.000 | 36.15 | 17.69 | 53.84 | 74.00 | -20.16 | peak |
| 3 | 15840.000 | 27.10 | 17.69 | 44.79 | 54.00 | -9.21 | AVG |

Note:1.Result (dBuV/m) = Correct Factor (dB/m) + Reading(dBuV).

2.Correction factor (dB/m) = Antenna Factor (dB/m) + Cable loss (dB) – Pre-Amplifier gain (dB).

3.When the peak results are less than average limit, so not need to evaluate the average.



| | | | |
|-------------|-----------------|----------------|-----|
| Standard: | FCC Part 15.407 | Test Distance: | 3 m |
| Test item: | Harmonic | | |
| Frequency: | 5280 MHz | | |
| Mode: | Mode 8 | | |
| Ant.Polar.: | Vertical | | |

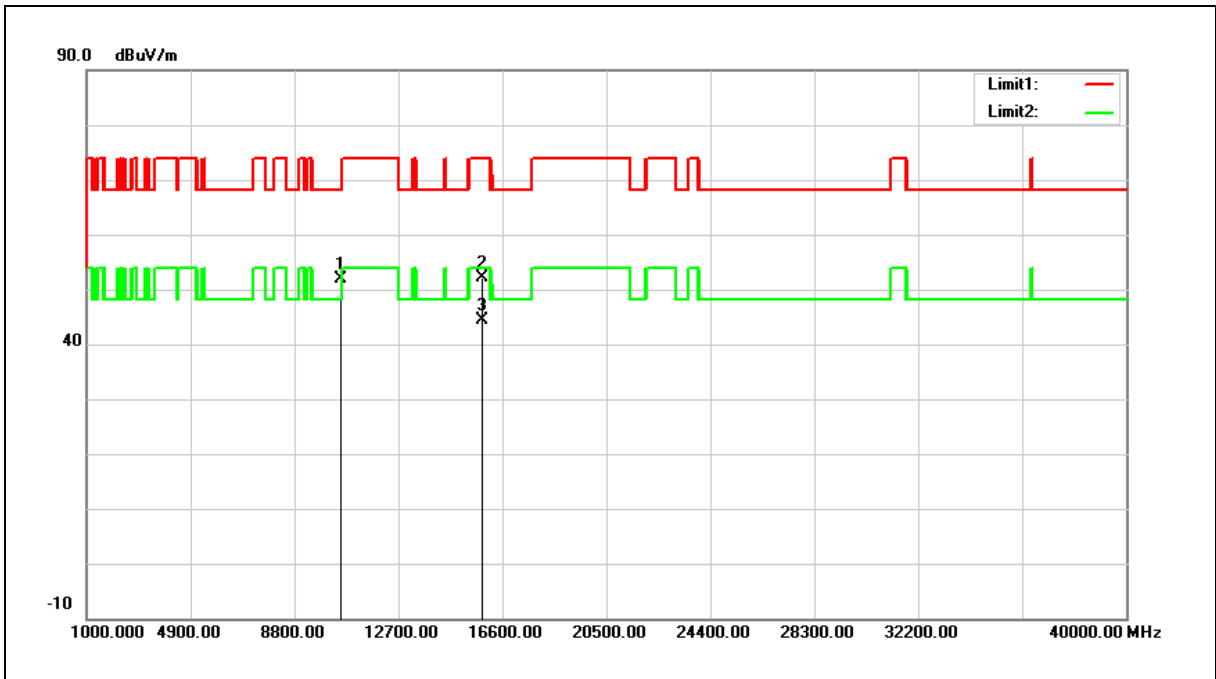

| No. | Frequency (MHz) | Reading (dBuV) | Correct Factor (dB/m) | Result (dBuV/m) | Limit (dBuV/m) | Margin (dB) | Remark |
|-----|-----------------|----------------|-----------------------|-----------------|----------------|-------------|--------|
| 1 | 10560.000 | 34.69 | 17.08 | 51.77 | 68.20 | -16.43 | peak |
| 2 | 15840.000 | 34.43 | 17.69 | 52.12 | 74.00 | -21.88 | peak |
| 3 | 15840.000 | 26.72 | 17.69 | 44.41 | 54.00 | -9.59 | AVG |

Note:1.Result (dBuV/m) = Correct Factor (dB/m) + Reading(dBuV).

2.Correction factor (dB/m) = Antenna Factor (dB/m) + Cable loss (dB) – Pre-Amplifier gain (dB).

3.When the peak results are less than average limit, so not need to evaluate the average.



| | | | |
|-------------|-----------------|----------------|-----|
| Standard: | FCC Part 15.407 | Test Distance: | 3 m |
| Test item: | Harmonic | | |
| Frequency: | 5320 MHz | | |
| Mode: | Mode 8 | | |
| Ant.Polar.: | Horizontal | | |

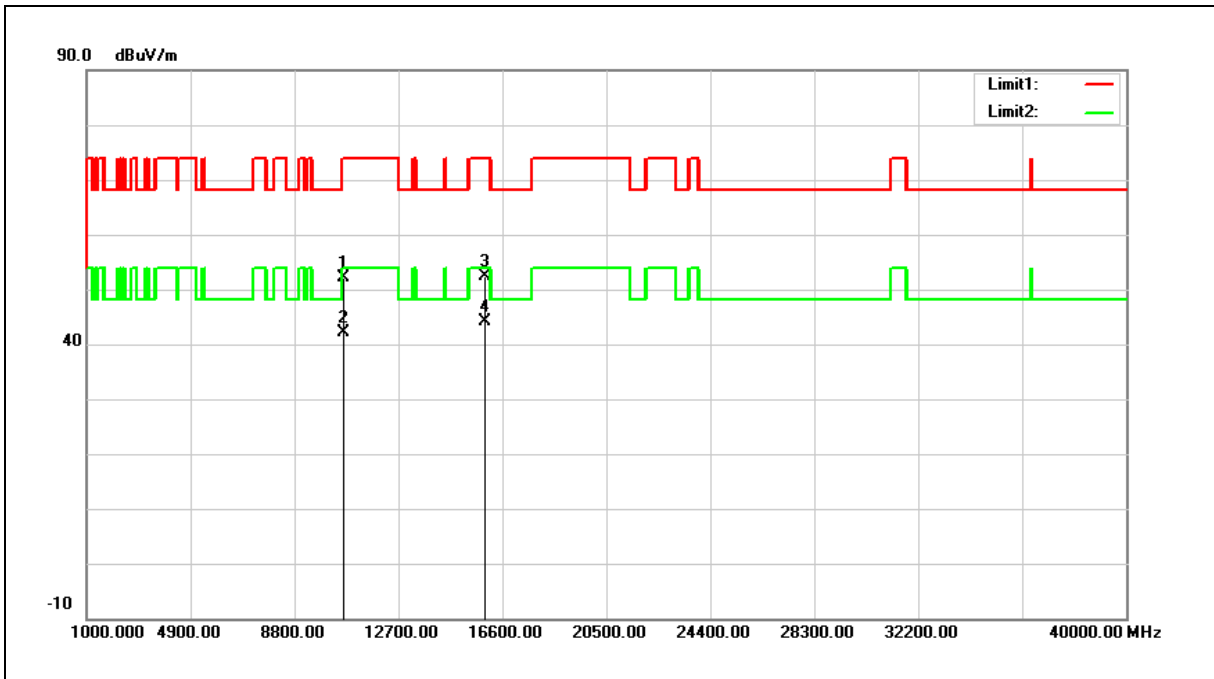

| No. | Frequency (MHz) | Reading (dBuV) | Correct Factor (dB/m) | Result (dBuV/m) | Limit (dBuV/m) | Margin (dB) | Remark |
|-----|-----------------|----------------|-----------------------|-----------------|----------------|-------------|--------|
| 1 | 10640.000 | 35.01 | 17.14 | 52.15 | 74.00 | -21.85 | peak |
| 2 | 10640.000 | 25.01 | 17.14 | 42.15 | 54.00 | -11.85 | AVG |
| 3 | 15960.000 | 35.26 | 17.18 | 52.44 | 74.00 | -21.56 | peak |
| 4 | 15960.000 | 27.02 | 17.18 | 44.20 | 54.00 | -9.80 | AVG |

Note:1.Result (dBuV/m) = Correct Factor (dB/m) + Reading(dBuV).

2.Correction factor (dB/m) = Antenna Factor (dB/m) + Cable loss (dB) – Pre-Amplifier gain (dB).

3.When the peak results are less than average limit, so not need to evaluate the average.



| | | | |
|-------------|-----------------|----------------|-----|
| Standard: | FCC Part 15.407 | Test Distance: | 3 m |
| Test item: | Harmonic | | |
| Frequency: | 5320 MHz | | |
| Mode: | Mode 8 | | |
| Ant.Polar.: | Vertical | | |

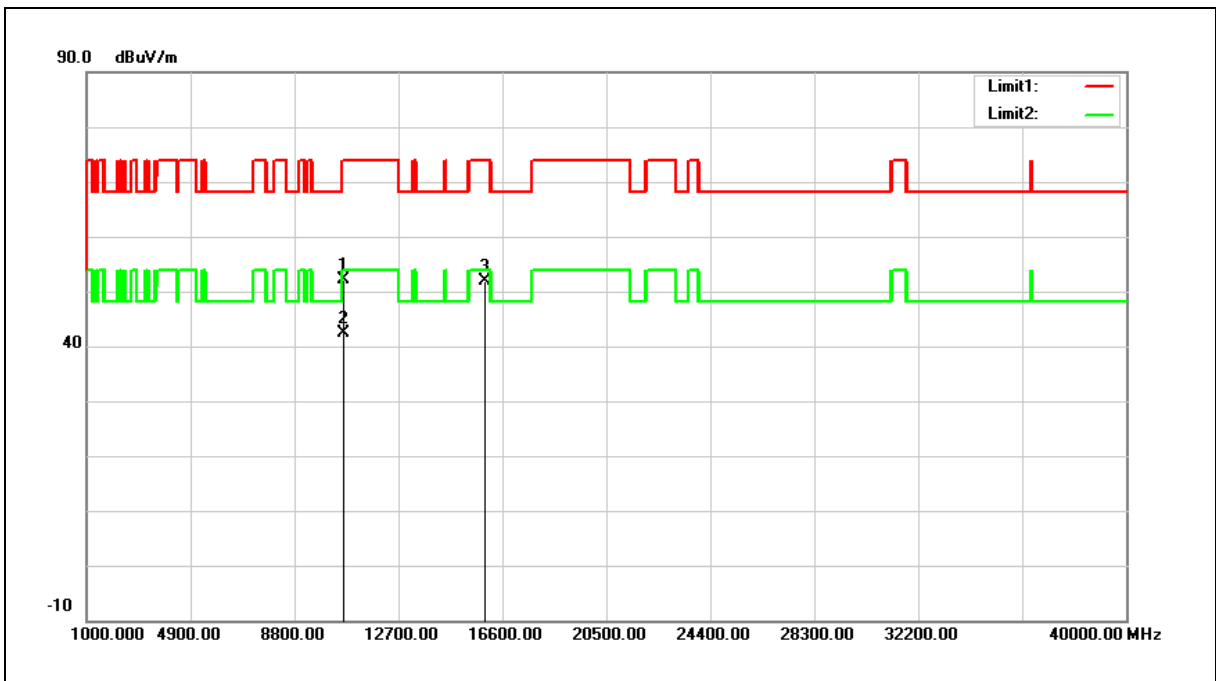

| No. | Frequency (MHz) | Reading (dBuV) | Correct Factor (dB/m) | Result (dBuV/m) | Limit (dBuV/m) | Margin (dB) | Remark |
|-----|-----------------|----------------|-----------------------|-----------------|----------------|-------------|--------|
| 1 | 10640.000 | 35.11 | 17.14 | 52.25 | 74.00 | -21.75 | peak |
| 2 | 10640.000 | 25.21 | 17.14 | 42.35 | 54.00 | -11.65 | AVG |
| 3 | 15960.000 | 34.74 | 17.18 | 51.92 | 74.00 | -22.08 | peak |

Note:1.Result (dBuV/m) = Correct Factor (dB/m) + Reading(dBuV).

2.Correction factor (dB/m) = Antenna Factor (dB/m) + Cable loss (dB) – Pre-Amplifier gain (dB).

3.When the peak results are less than average limit, so not need to evaluate the average.



| | | | |
|-------------|-----------------|----------------|-----|
| Standard: | FCC Part 15.407 | Test Distance: | 3 m |
| Test item: | Harmonic | | |
| Frequency: | 5500 MHz | | |
| Mode: | Mode 8 | | |
| Ant.Polar.: | Horizontal | | |

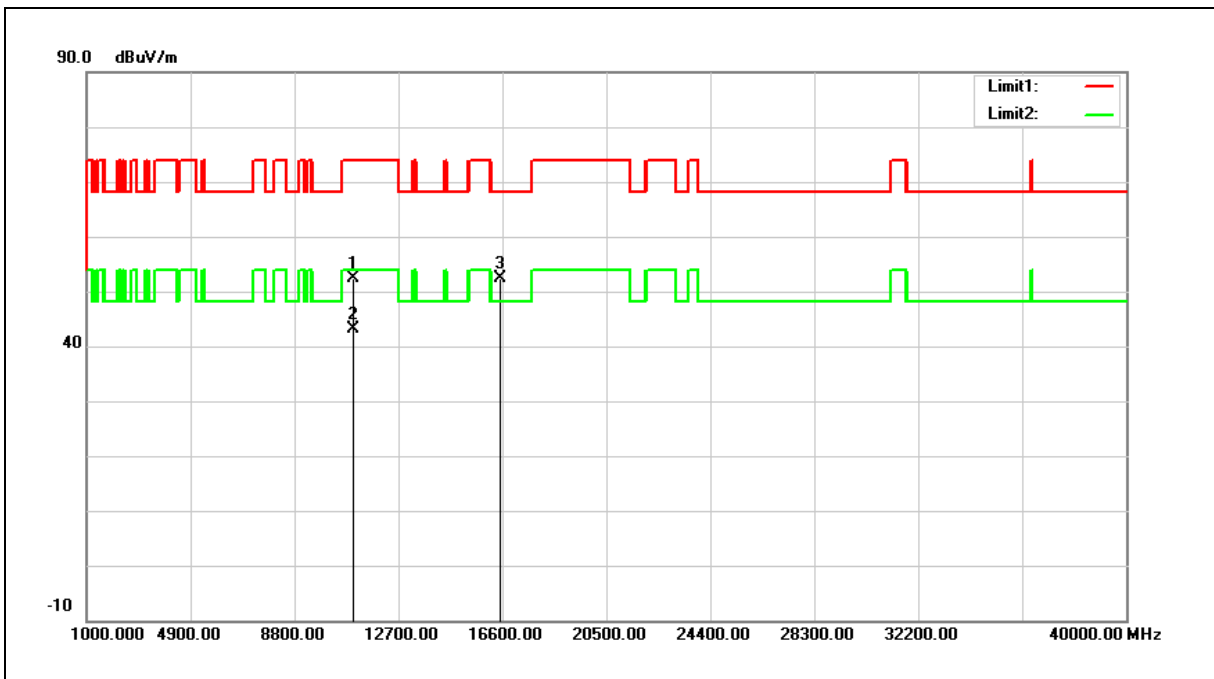

| No. | Frequency (MHz) | Reading (dBuV) | Correct Factor (dB/m) | Result (dBuV/m) | Limit (dBuV/m) | Margin (dB) | Remark |
|-----|-----------------|----------------|-----------------------|-----------------|----------------|-------------|--------|
| 1 | 11000.000 | 35.01 | 17.41 | 52.42 | 74.00 | -21.58 | peak |
| 2 | 11000.000 | 25.67 | 17.41 | 43.08 | 54.00 | -10.92 | AVG |
| 3 | 16500.000 | 33.75 | 18.73 | 52.48 | 68.20 | -15.72 | peak |

Note:1.Result (dBuV/m) = Correct Factor (dB/m) + Reading(dBuV).

2.Correction factor (dB/m) = Antenna Factor (dB/m) + Cable loss (dB) – Pre-Amplifier gain (dB).

3.When the peak results are less than average limit, so not need to evaluate the average.



| | | | |
|-------------|-----------------|----------------|-----|
| Standard: | FCC Part 15.407 | Test Distance: | 3 m |
| Test item: | Harmonic | | |
| Frequency: | 5500 MHz | | |
| Mode: | Mode 8 | | |
| Ant.Polar.: | Vertical | | |

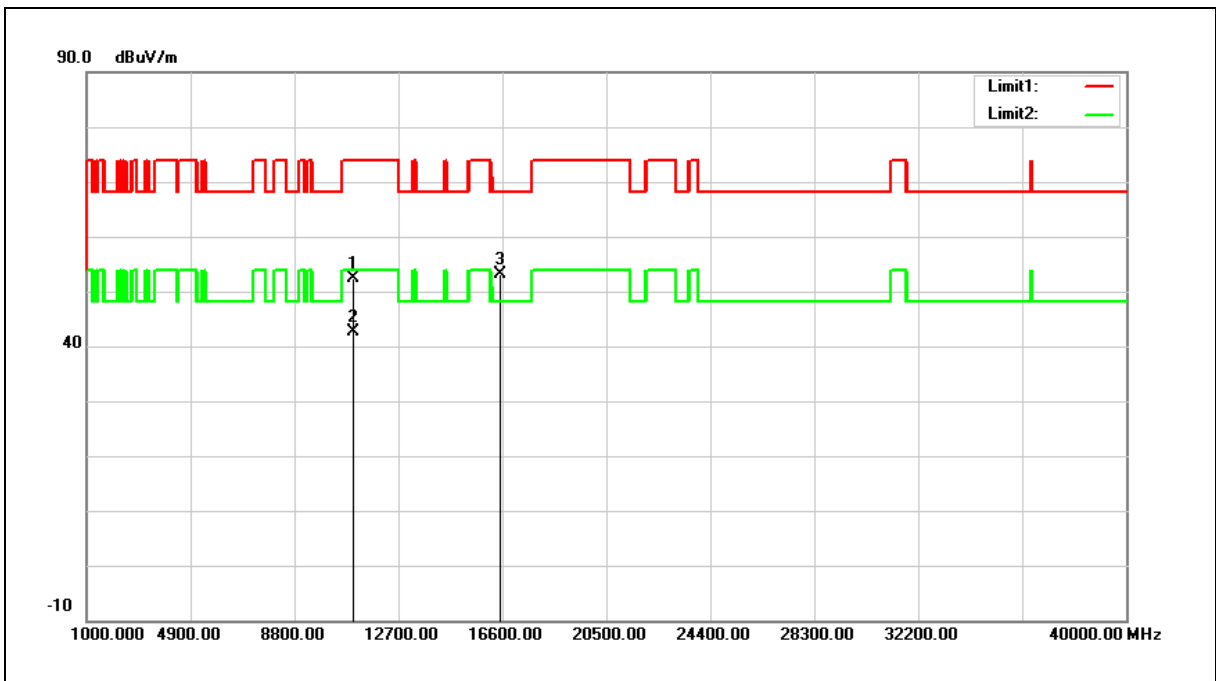

| No. | Frequency (MHz) | Reading (dBuV) | Correct Factor (dB/m) | Result (dBuV/m) | Limit (dBuV/m) | Margin (dB) | Remark |
|-----|-----------------|----------------|-----------------------|-----------------|----------------|-------------|--------|
| 1 | 11000.000 | 35.01 | 17.41 | 52.42 | 74.00 | -21.58 | peak |
| 2 | 11000.000 | 25.22 | 17.41 | 42.63 | 54.00 | -11.37 | AVG |
| 3 | 16500.000 | 34.31 | 18.73 | 53.04 | 68.20 | -15.16 | peak |

Note:1.Result (dBuV/m) = Correct Factor (dB/m) + Reading(dBuV).

2.Correction factor (dB/m) = Antenna Factor (dB/m) + Cable loss (dB) – Pre-Amplifier gain (dB).

3.When the peak results are less than average limit, so not need to evaluate the average.



| | | | |
|-------------|-----------------|----------------|-----|
| Standard: | FCC Part 15.407 | Test Distance: | 3 m |
| Test item: | Harmonic | | |
| Frequency: | 5560 MHz | | |
| Mode: | Mode 8 | | |
| Ant.Polar.: | Horizontal | | |

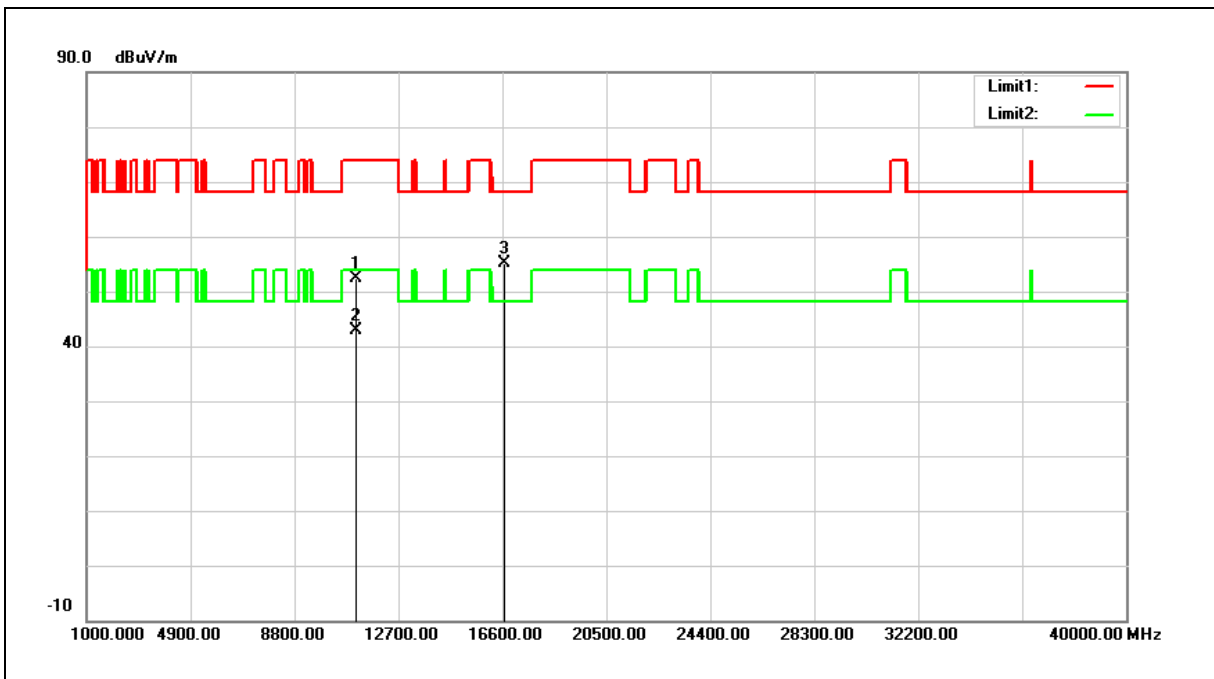

| No. | Frequency (MHz) | Reading (dBuV) | Correct Factor (dB/m) | Result (dBuV/m) | Limit (dBuV/m) | Margin (dB) | Remark |
|-----|-----------------|----------------|-----------------------|-----------------|----------------|-------------|--------|
| 1 | 11120.000 | 34.81 | 17.63 | 52.44 | 74.00 | -21.56 | peak |
| 2 | 11120.000 | 25.23 | 17.63 | 42.86 | 54.00 | -11.14 | AVG |
| 3 | 16680.000 | 34.87 | 20.19 | 55.06 | 68.20 | -13.14 | peak |

Note:1.Result (dBuV/m) = Correct Factor (dB/m) + Reading(dBuV).

2.Correction factor (dB/m) = Antenna Factor (dB/m) + Cable loss (dB) – Pre-Amplifier gain (dB).

3.When the peak results are less than average limit, so not need to evaluate the average.



| | | | |
|-------------|-----------------|----------------|-----|
| Standard: | FCC Part 15.407 | Test Distance: | 3 m |
| Test item: | Harmonic | | |
| Frequency: | 5560 MHz | | |
| Mode: | Mode 8 | | |
| Ant.Polar.: | Vertical | | |

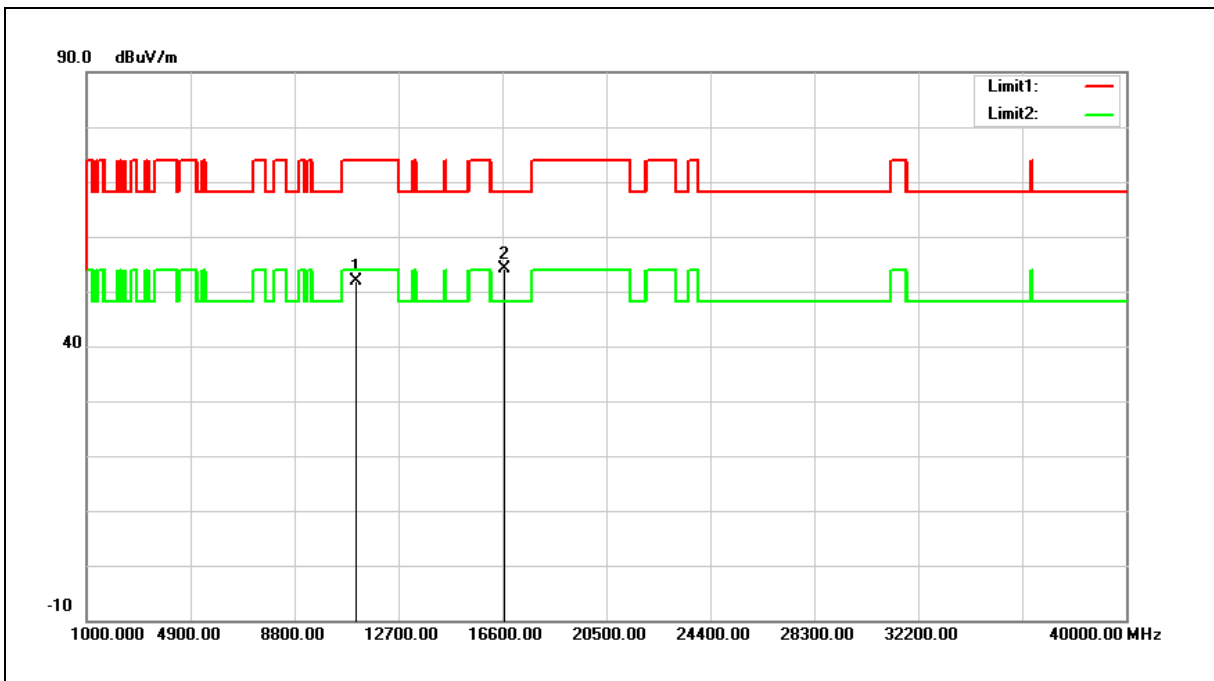

| No. | Frequency (MHz) | Reading (dBuV) | Correct Factor (dB/m) | Result (dBuV/m) | Limit (dBuV/m) | Margin (dB) | Remark |
|-----|-----------------|----------------|-----------------------|-----------------|----------------|-------------|--------|
| 1 | 11120.000 | 34.34 | 17.63 | 51.97 | 74.00 | -22.03 | peak |
| 2 | 16680.000 | 34.00 | 20.19 | 54.19 | 68.20 | -14.01 | peak |

Note:1.Result (dBuV/m) = Correct Factor (dB/m) + Reading(dBuV).

2.Correction factor (dB/m) = Antenna Factor (dB/m) + Cable loss (dB) – Pre-Amplifier gain (dB).

3.When the peak results are less than average limit, so not need to evaluate the average.



| | | | |
|-------------|-----------------|----------------|-----|
| Standard: | FCC Part 15.407 | Test Distance: | 3 m |
| Test item: | Harmonic | | |
| Frequency: | 5700 MHz | | |
| Mode: | Mode 8 | | |
| Ant.Polar.: | Horizontal | | |

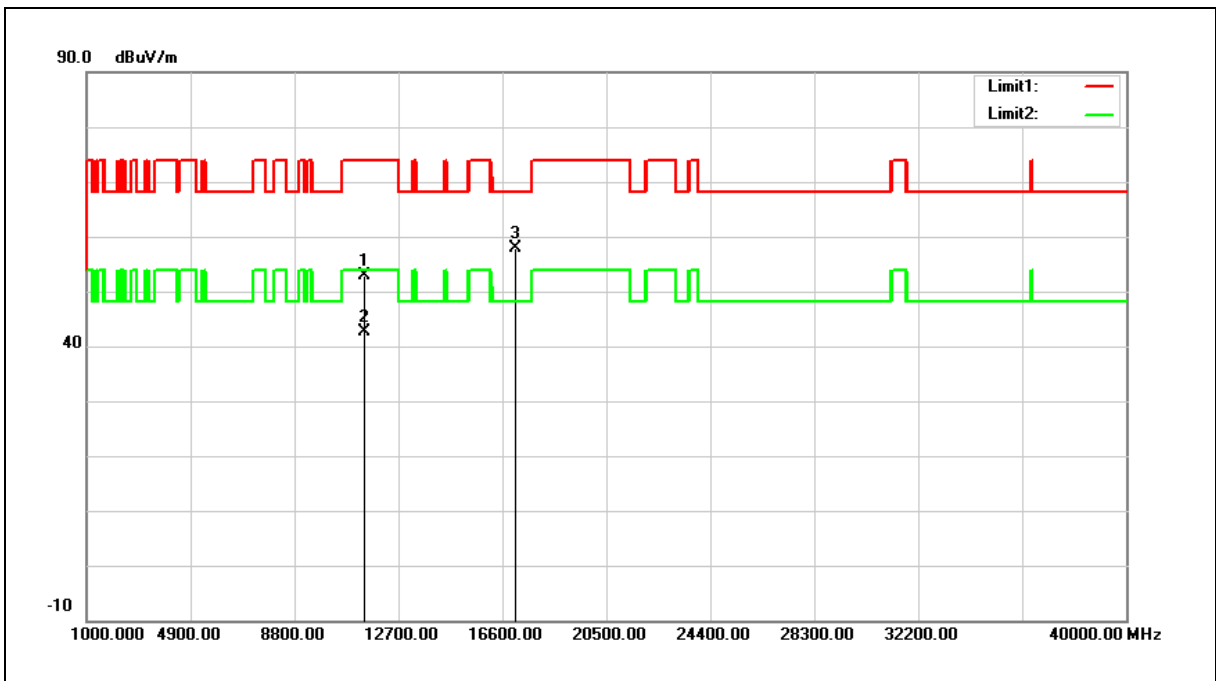

| No. | Frequency (MHz) | Reading (dBuV) | Correct Factor (dB/m) | Result (dBuV/m) | Limit (dBuV/m) | Margin (dB) | Remark |
|-----|-----------------|----------------|-----------------------|-----------------|----------------|-------------|--------|
| 1 | 11400.000 | 34.73 | 18.12 | 52.85 | 74.00 | -21.15 | peak |
| 2 | 11400.000 | 24.57 | 18.12 | 42.69 | 54.00 | -11.31 | AVG |
| 3 | 17100.000 | 34.66 | 23.26 | 57.92 | 68.20 | -10.28 | peak |

Note:1.Result (dBuV/m) = Correct Factor (dB/m) + Reading(dBuV).

2.Correction factor (dB/m) = Antenna Factor (dB/m) + Cable loss (dB) – Pre-Amplifier gain (dB).

3.When the peak results are less than average limit, so not need to evaluate the average.



| | | | |
|-------------|-----------------|----------------|-----|
| Standard: | FCC Part 15.407 | Test Distance: | 3 m |
| Test item: | Harmonic | | |
| Frequency: | 5700 MHz | | |
| Mode: | Mode 8 | | |
| Ant.Polar.: | Vertical | | |

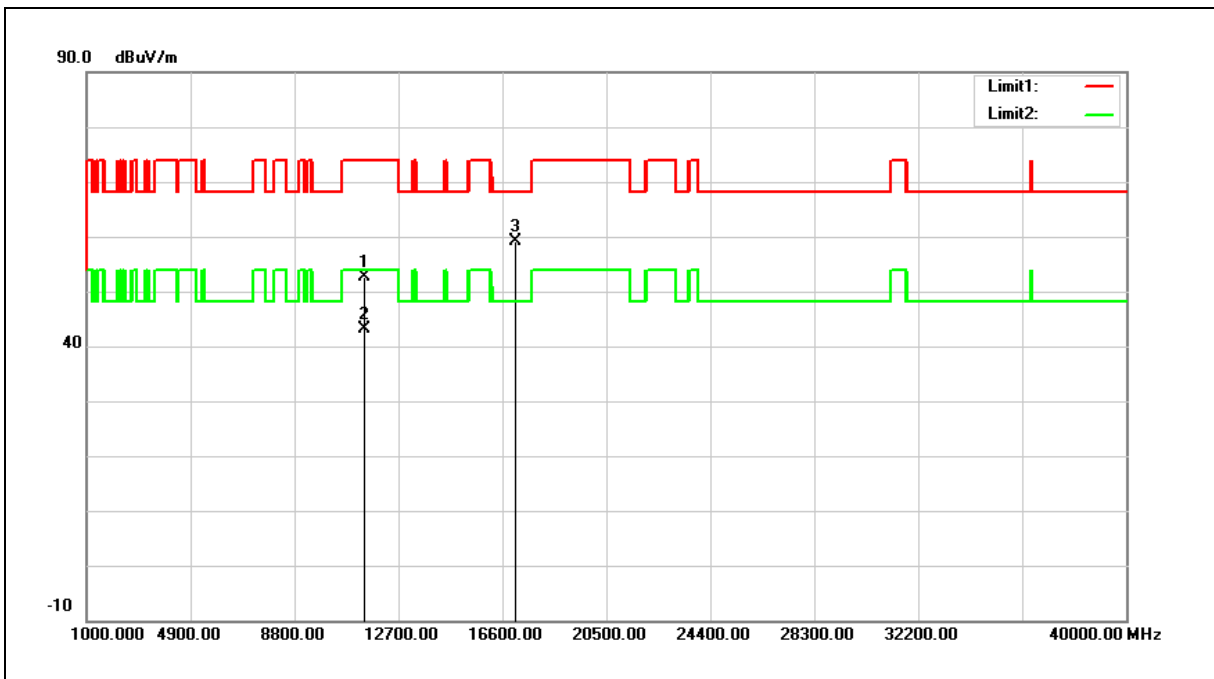

| No. | Frequency (MHz) | Reading (dBuV) | Correct Factor (dB/m) | Result (dBuV/m) | Limit (dBuV/m) | Margin (dB) | Remark |
|-----|-----------------|----------------|-----------------------|-----------------|----------------|-------------|--------|
| 1 | 11400.000 | 34.55 | 18.12 | 52.67 | 74.00 | -21.33 | peak |
| 2 | 11400.000 | 25.00 | 18.12 | 43.12 | 54.00 | -10.88 | AVG |
| 3 | 17100.000 | 35.91 | 23.26 | 59.17 | 68.20 | -9.03 | peak |

Note:1.Result (dBuV/m) = Correct Factor (dB/m) + Reading(dBuV).

2.Correction factor (dB/m) = Antenna Factor (dB/m) + Cable loss (dB) – Pre-Amplifier gain (dB).

3.When the peak results are less than average limit, so not need to evaluate the average.



| | | | |
|-------------|-----------------|----------------|-----|
| Standard: | FCC Part 15.407 | Test Distance: | 3 m |
| Test item: | Harmonic | | |
| Frequency: | 5720 MHz | | |
| Mode: | Mode 8 | | |
| Ant.Polar.: | Horizontal | | |

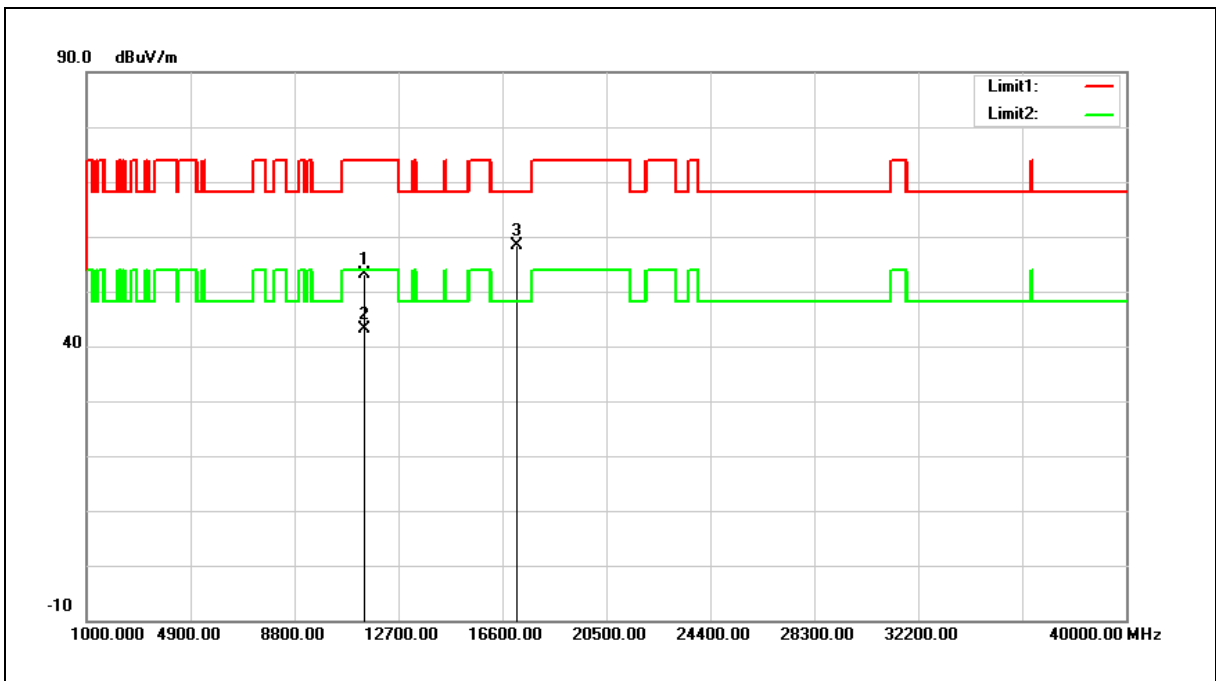

| No. | Frequency (MHz) | Reading (dBuV) | Correct Factor (dB/m) | Result (dBuV/m) | Limit (dBuV/m) | Margin (dB) | Remark |
|-----|-----------------|----------------|-----------------------|-----------------|----------------|-------------|--------|
| 1 | 11440.000 | 35.03 | 18.20 | 53.23 | 74.00 | -20.77 | peak |
| 2 | 11440.000 | 24.91 | 18.20 | 43.11 | 54.00 | -10.89 | AVG |
| 3 | 17160.000 | 34.83 | 23.54 | 58.37 | 68.20 | -9.83 | peak |

Note:1.Result (dBuV/m) = Correct Factor (dB/m) + Reading(dBuV).

2.Correction factor (dB/m) = Antenna Factor (dB/m) + Cable loss (dB) – Pre-Amplifier gain (dB).

3.When the peak results are less than average limit, so not need to evaluate the average.



| | | | |
|-------------|-----------------|----------------|-----|
| Standard: | FCC Part 15.407 | Test Distance: | 3 m |
| Test item: | Harmonic | | |
| Frequency: | 5720 MHz | | |
| Mode: | Mode 8 | | |
| Ant.Polar.: | Vertical | | |

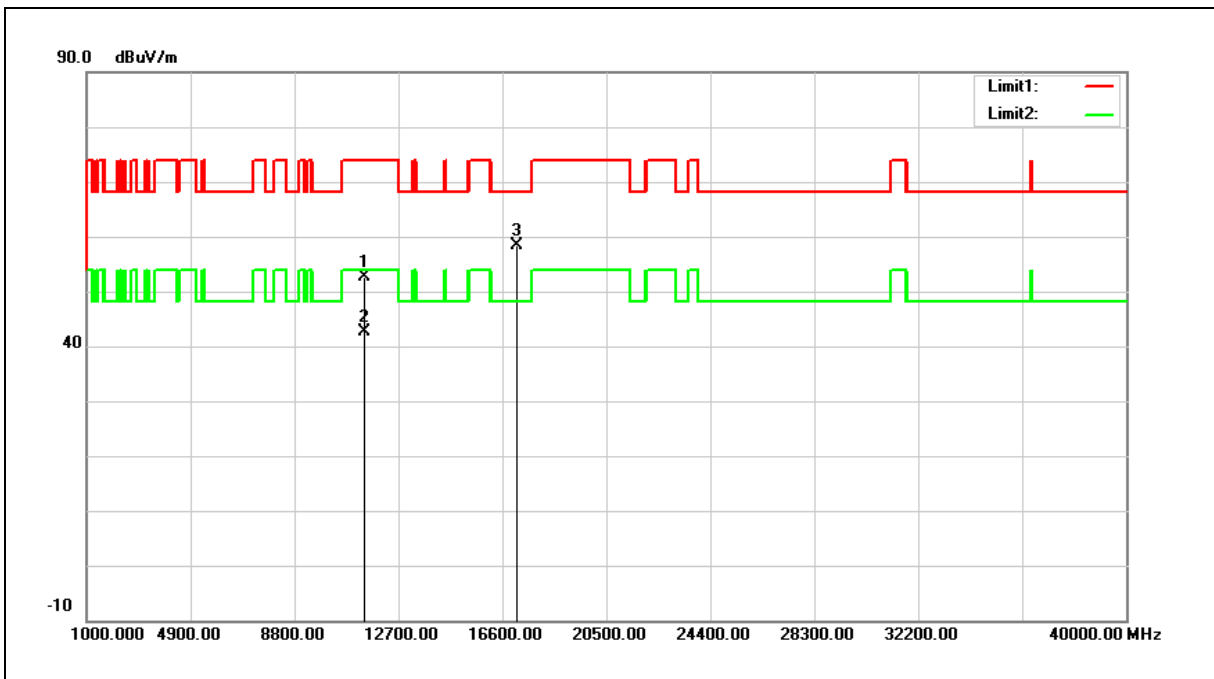

| No. | Frequency (MHz) | Reading (dBuV) | Correct Factor (dB/m) | Result (dBuV/m) | Limit (dBuV/m) | Margin (dB) | Remark |
|-----|-----------------|----------------|-----------------------|-----------------|----------------|-------------|--------|
| 1 | 11440.000 | 34.36 | 18.20 | 52.56 | 74.00 | -21.44 | peak |
| 2 | 11440.000 | 24.34 | 18.20 | 42.54 | 54.00 | -11.46 | AVG |
| 3 | 17160.000 | 34.80 | 23.54 | 58.34 | 68.20 | -9.86 | peak |

Note:1.Result (dBuV/m) = Correct Factor (dB/m) + Reading(dBuV).

2.Correction factor (dB/m) = Antenna Factor (dB/m) + Cable loss (dB) – Pre-Amplifier gain (dB).

3.When the peak results are less than average limit, so not need to evaluate the average.



| | | | |
|-------------|-----------------|----------------|-----|
| Standard: | FCC Part 15.407 | Test Distance: | 3 m |
| Test item: | Harmonic | | |
| Frequency: | 5745 MHz | | |
| Mode: | Mode 8 | | |
| Ant.Polar.: | Horizontal | | |

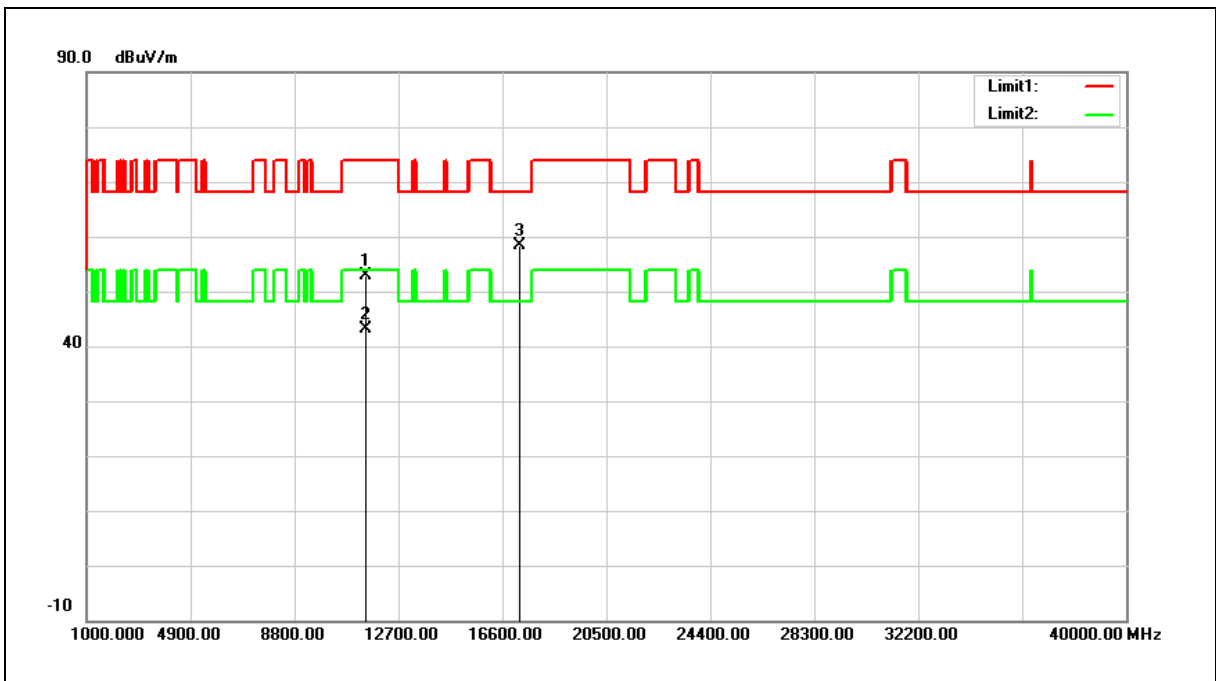

| No. | Frequency (MHz) | Reading (dBuV) | Correct Factor (dB/m) | Result (dBuV/m) | Limit (dBuV/m) | Margin (dB) | Remark |
|-----|-----------------|----------------|-----------------------|-----------------|----------------|-------------|--------|
| 1 | 11490.000 | 34.57 | 18.28 | 52.85 | 74.00 | -21.15 | peak |
| 2 | 11490.000 | 24.74 | 18.28 | 43.02 | 54.00 | -10.98 | AVG |
| 3 | 17235.000 | 34.57 | 23.90 | 58.47 | 68.20 | -9.73 | peak |

Note:1.Result (dBuV/m) = Correct Factor (dB/m) + Reading(dBuV).

2.Correction factor (dB/m) = Antenna Factor (dB/m) + Cable loss (dB) – Pre-Amplifier gain (dB).

3.When the peak results are less than average limit, so not need to evaluate the average.



| | | | |
|-------------|-----------------|----------------|-----|
| Standard: | FCC Part 15.407 | Test Distance: | 3 m |
| Test item: | Harmonic | | |
| Frequency: | 5745 MHz | | |
| Mode: | Mode 8 | | |
| Ant.Polar.: | Vertical | | |

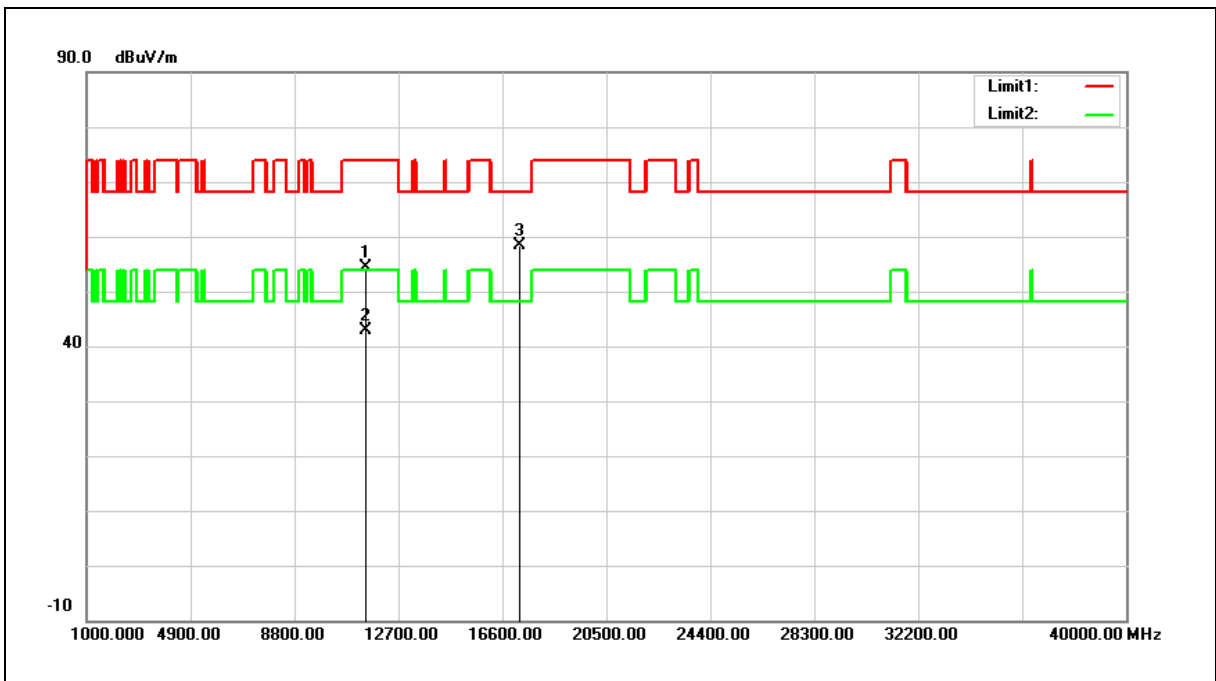

| No. | Frequency (MHz) | Reading (dBuV) | Correct Factor (dB/m) | Result (dBuV/m) | Limit (dBuV/m) | Margin (dB) | Remark |
|-----|-----------------|----------------|-----------------------|-----------------|----------------|-------------|--------|
| 1 | 11490.000 | 36.12 | 18.28 | 54.40 | 74.00 | -19.60 | peak |
| 2 | 11490.000 | 24.55 | 18.28 | 42.83 | 54.00 | -11.17 | AVG |
| 3 | 17235.000 | 34.54 | 23.90 | 58.44 | 68.20 | -9.76 | peak |

Note:1.Result (dBuV/m) = Correct Factor (dB/m) + Reading(dBuV).

2.Correction factor (dB/m) = Antenna Factor (dB/m) + Cable loss (dB) – Pre-Amplifier gain (dB).

3.When the peak results are less than average limit, so not need to evaluate the average.



| | | | |
|-------------|-----------------|----------------|-----|
| Standard: | FCC Part 15.407 | Test Distance: | 3 m |
| Test item: | Harmonic | | |
| Frequency: | 5785 MHz | | |
| Mode: | Mode 8 | | |
| Ant.Polar.: | Horizontal | | |

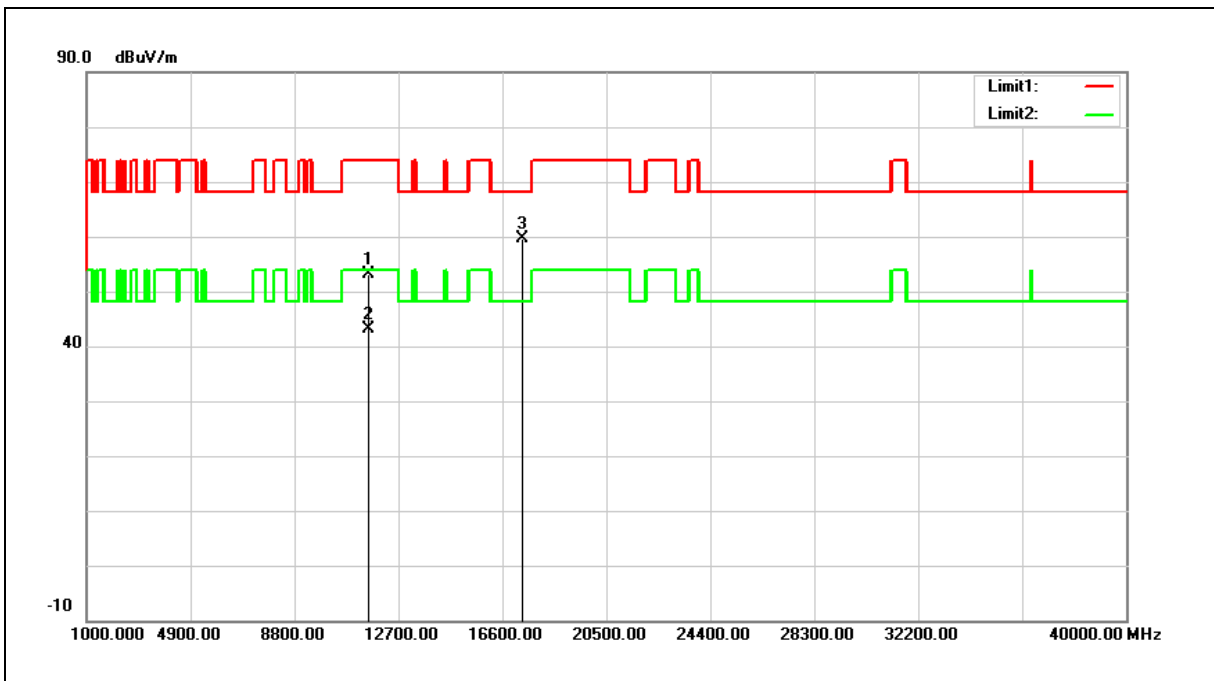

| No. | Frequency (MHz) | Reading (dBuV) | Correct Factor (dB/m) | Result (dBuV/m) | Limit (dBuV/m) | Margin (dB) | Remark |
|-----|-----------------|----------------|-----------------------|-----------------|----------------|-------------|--------|
| 1 | 11570.000 | 35.07 | 18.14 | 53.21 | 74.00 | -20.79 | peak |
| 2 | 11570.000 | 25.11 | 18.14 | 43.25 | 54.00 | -10.75 | AVG |
| 3 | 17355.000 | 35.26 | 24.46 | 59.72 | 68.20 | -8.48 | peak |

Note:1.Result (dBuV/m) = Correct Factor (dB/m) + Reading(dBuV).

2.Correction factor (dB/m) = Antenna Factor (dB/m) + Cable loss (dB) – Pre-Amplifier gain (dB).

3.When the peak results are less than average limit, so not need to evaluate the average.



| | | | |
|-------------|-----------------|----------------|-----|
| Standard: | FCC Part 15.407 | Test Distance: | 3 m |
| Test item: | Harmonic | | |
| Frequency: | 5785 MHz | | |
| Mode: | Mode 8 | | |
| Ant.Polar.: | Vertical | | |

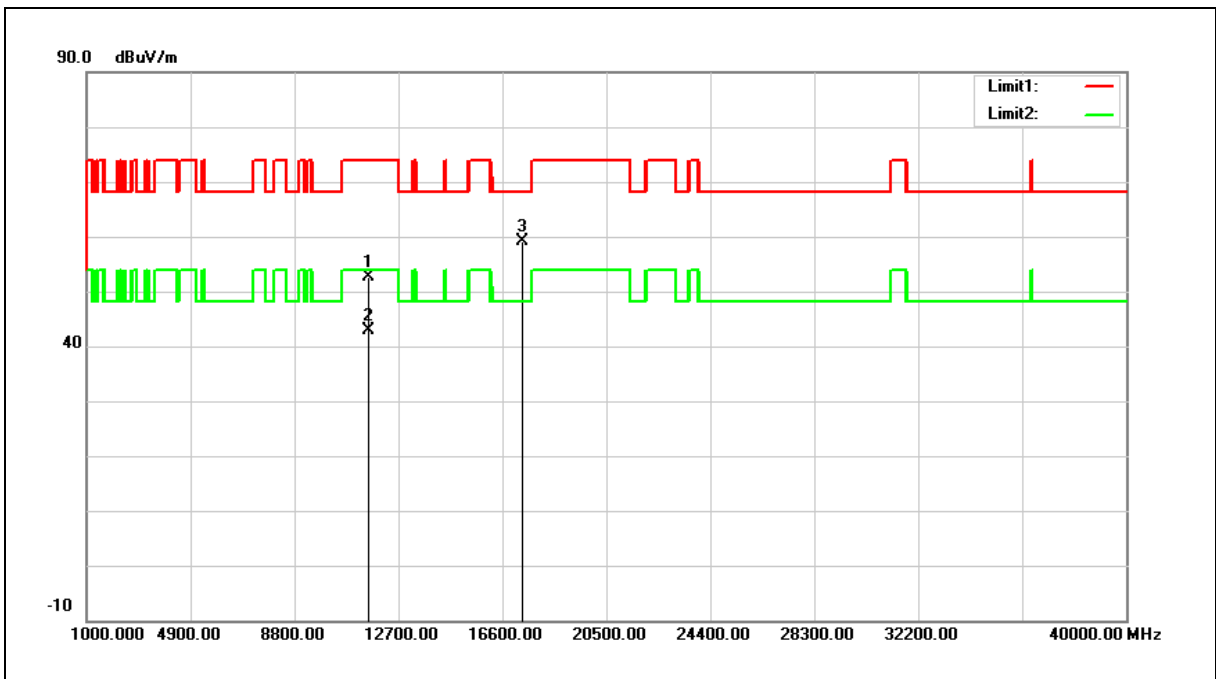

| No. | Frequency (MHz) | Reading (dBuV) | Correct Factor (dB/m) | Result (dBuV/m) | Limit (dBuV/m) | Margin (dB) | Remark |
|-----|-----------------|----------------|-----------------------|-----------------|----------------|-------------|--------|
| 1 | 11570.000 | 34.53 | 18.14 | 52.67 | 74.00 | -21.33 | peak |
| 2 | 11570.000 | 24.68 | 18.14 | 42.82 | 54.00 | -11.18 | AVG |
| 3 | 17355.000 | 34.73 | 24.46 | 59.19 | 68.20 | -9.01 | peak |

Note:1.Result (dBuV/m) = Correct Factor (dB/m) + Reading(dBuV).

2.Correction factor (dB/m) = Antenna Factor (dB/m) + Cable loss (dB) – Pre-Amplifier gain (dB).

3.When the peak results are less than average limit, so not need to evaluate the average.



| | | | |
|-------------|-----------------|----------------|-----|
| Standard: | FCC Part 15.407 | Test Distance: | 3 m |
| Test item: | Harmonic | | |
| Frequency: | 5825 MHz | | |
| Mode: | Mode 8 | | |
| Ant.Polar.: | Horizontal | | |

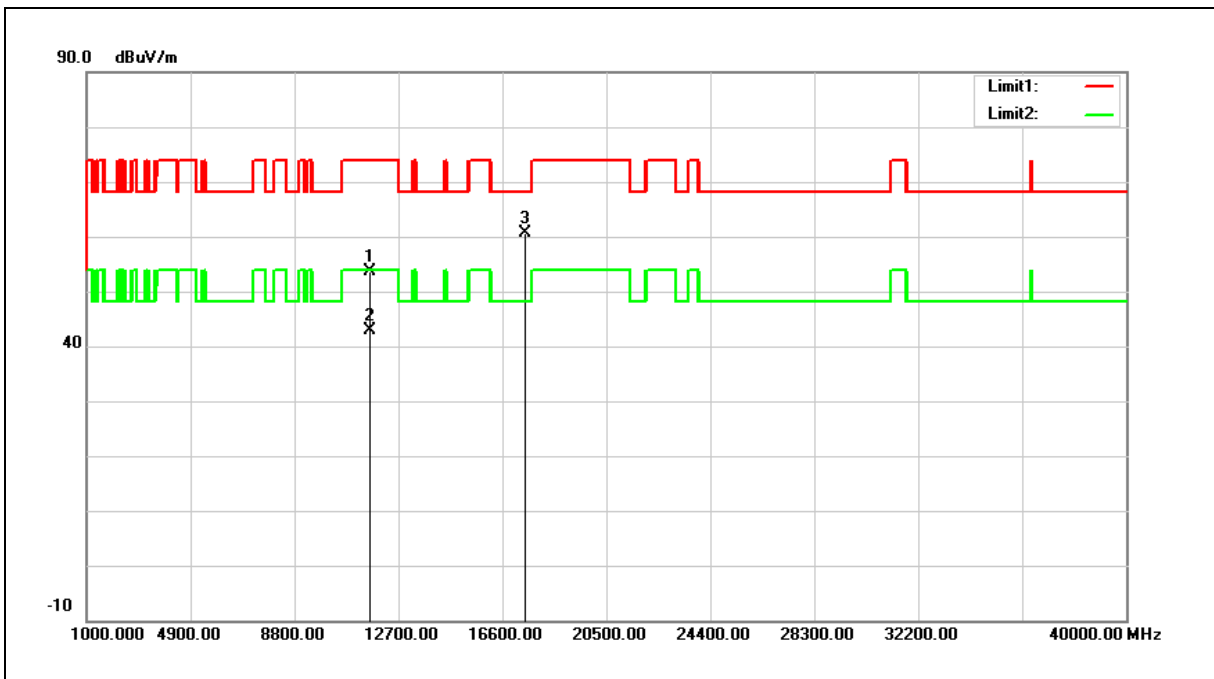

| No. | Frequency (MHz) | Reading (dBuV) | Correct Factor (dB/m) | Result (dBuV/m) | Limit (dBuV/m) | Margin (dB) | Remark |
|-----|-----------------|----------------|-----------------------|-----------------|----------------|-------------|--------|
| 1 | 11650.000 | 35.61 | 17.97 | 53.58 | 74.00 | -20.42 | peak |
| 2 | 11650.000 | 24.95 | 17.97 | 42.92 | 54.00 | -11.08 | AVG |
| 3 | 17475.000 | 35.71 | 25.01 | 60.72 | 68.20 | -7.48 | peak |

Note:1.Result (dBuV/m) = Correct Factor (dB/m) + Reading(dBuV).

2.Correction factor (dB/m) = Antenna Factor (dB/m) + Cable loss (dB) – Pre-Amplifier gain (dB).

3.When the peak results are less than average limit, so not need to evaluate the average.



| | | | |
|-------------|-----------------|----------------|-----|
| Standard: | FCC Part 15.407 | Test Distance: | 3 m |
| Test item: | Harmonic | | |
| Frequency: | 5825 MHz | | |
| Mode: | Mode 8 | | |
| Ant.Polar.: | Vertical | | |

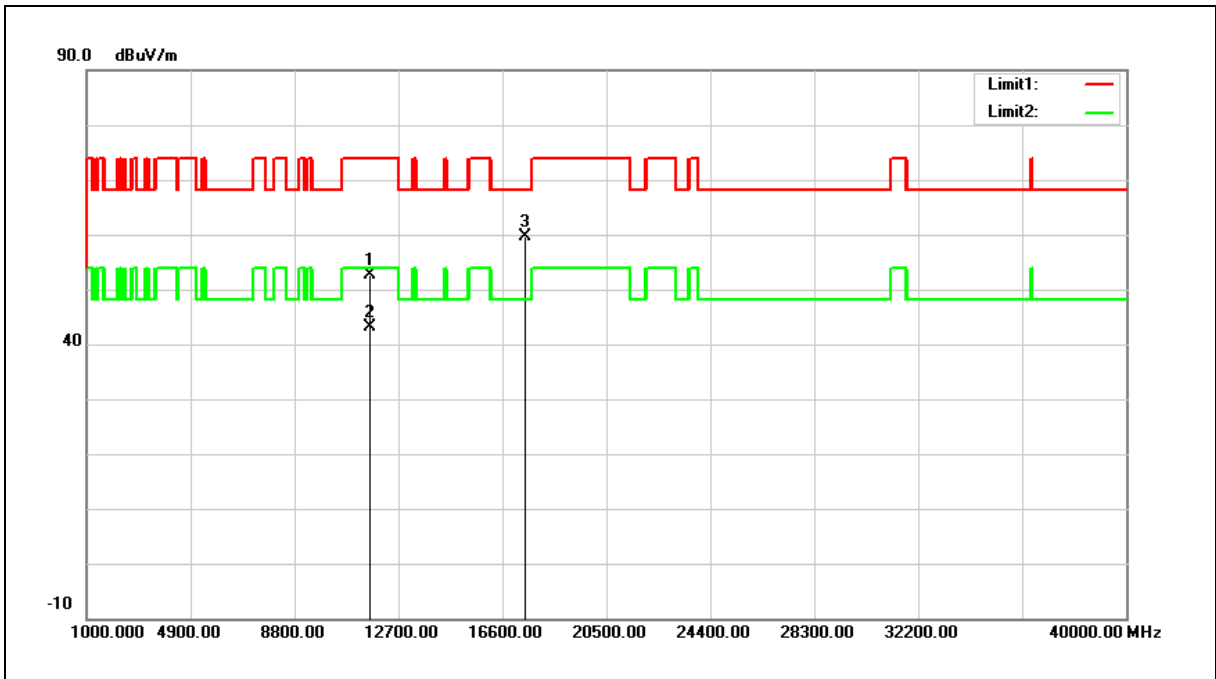

| No. | Frequency (MHz) | Reading (dBuV) | Correct Factor (dB/m) | Result (dBuV/m) | Limit (dBuV/m) | Margin (dB) | Remark |
|-----|-----------------|----------------|-----------------------|-----------------|----------------|-------------|--------|
| 1 | 11650.000 | 34.57 | 17.97 | 52.54 | 74.00 | -21.46 | peak |
| 2 | 11650.000 | 25.15 | 17.97 | 43.12 | 54.00 | -10.88 | AVG |
| 3 | 17475.000 | 34.70 | 25.01 | 59.71 | 68.20 | -8.49 | peak |

Note:1.Result (dBuV/m) = Correct Factor (dB/m) + Reading(dBuV).

2.Correction factor (dB/m) = Antenna Factor (dB/m) + Cable loss (dB) – Pre-Amplifier gain (dB).

3.When the peak results are less than average limit, so not need to evaluate the average.



| | | | |
|-------------|-----------------|----------------|-----|
| Standard: | FCC Part 15.407 | Test Distance: | 3 m |
| Test item: | Harmonic | | |
| Frequency: | 5190 MHz | | |
| Mode: | Mode 9 | | |
| Ant.Polar.: | Horizontal | | |

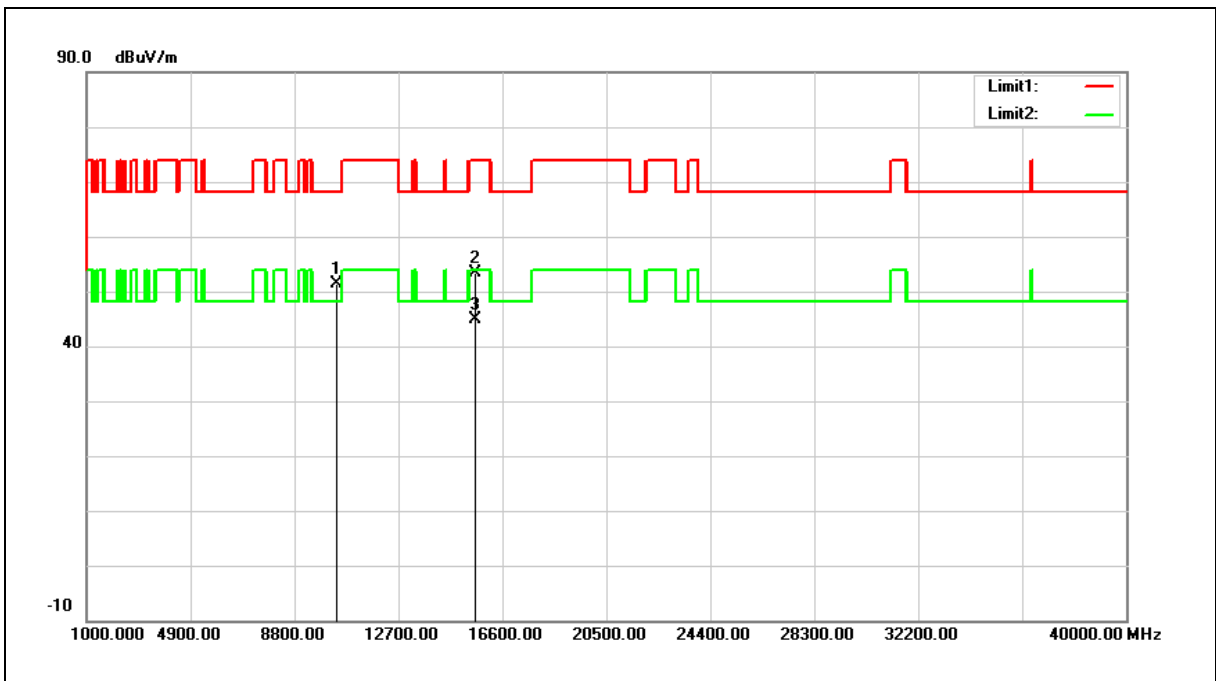

| No. | Frequency (MHz) | Reading (dBuV) | Correct Factor (dB/m) | Result (dBuV/m) | Limit (dBuV/m) | Margin (dB) | Remark |
|-----|-----------------|----------------|-----------------------|-----------------|----------------|-------------|--------|
| 1 | 10380.000 | 34.63 | 16.67 | 51.30 | 68.20 | -16.90 | peak |
| 2 | 15570.000 | 34.53 | 18.81 | 53.34 | 74.00 | -20.66 | peak |
| 3 | 15570.000 | 26.04 | 18.81 | 44.85 | 54.00 | -9.15 | AVG |

Note:1.Result (dBuV/m) = Correct Factor (dB/m) + Reading(dBuV).

2.Correction factor (dB/m) = Antenna Factor (dB/m) + Cable loss (dB) – Pre-Amplifier gain (dB).

3.When the peak results are less than average limit, so not need to evaluate the average.



| | | | |
|-------------|-----------------|----------------|-----|
| Standard: | FCC Part 15.407 | Test Distance: | 3 m |
| Test item: | Harmonic | | |
| Frequency: | 5190 MHz | | |
| Mode: | Mode 9 | | |
| Ant.Polar.: | Vertical | | |

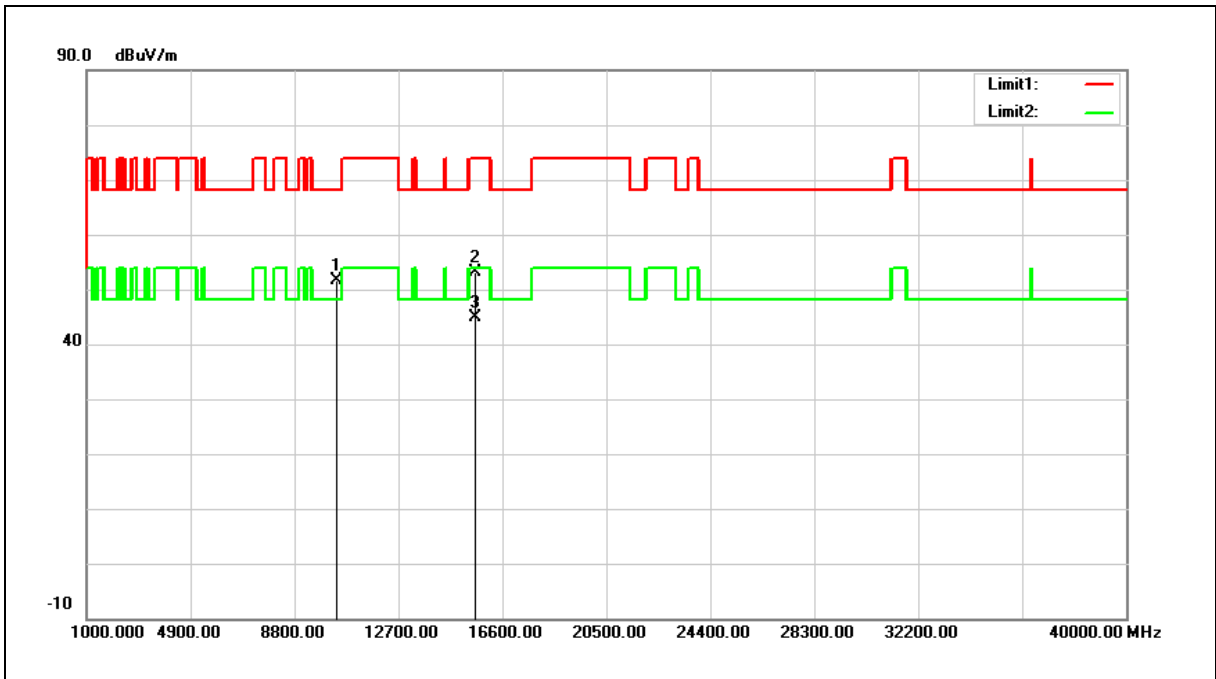

| No. | Frequency (MHz) | Reading (dBuV) | Correct Factor (dB/m) | Result (dBuV/m) | Limit (dBuV/m) | Margin (dB) | Remark |
|-----|-----------------|----------------|-----------------------|-----------------|----------------|-------------|--------|
| 1 | 10380.000 | 34.88 | 16.67 | 51.55 | 68.20 | -16.65 | peak |
| 2 | 15570.000 | 34.38 | 18.81 | 53.19 | 74.00 | -20.81 | peak |
| 3 | 15570.000 | 25.97 | 18.81 | 44.78 | 54.00 | -9.22 | AVG |

Note:1.Result (dBuV/m) = Correct Factor (dB/m) + Reading(dBuV).

2.Correction factor (dB/m) = Antenna Factor (dB/m) + Cable loss (dB) – Pre-Amplifier gain (dB).

3.When the peak results are less than average limit, so not need to evaluate the average.



| | | | |
|-------------|-----------------|----------------|-----|
| Standard: | FCC Part 15.407 | Test Distance: | 3 m |
| Test item: | Harmonic | | |
| Frequency: | 5230 MHz | | |
| Mode: | Mode 9 | | |
| Ant.Polar.: | Horizontal | | |

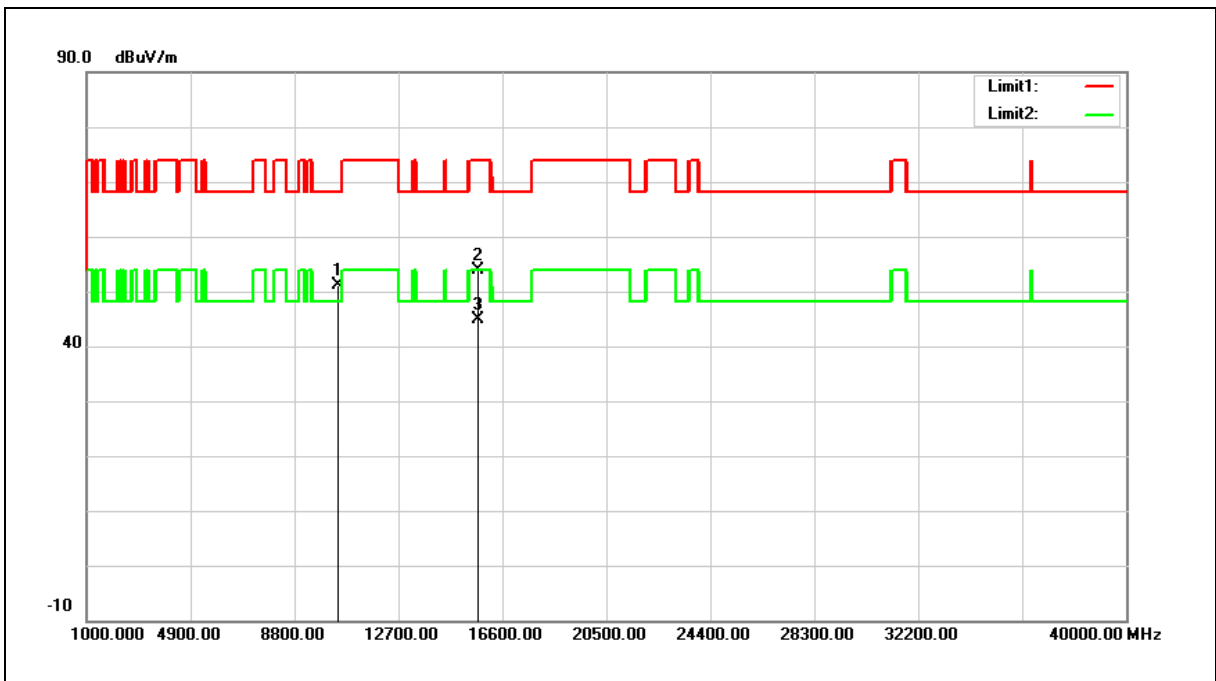

| No. | Frequency (MHz) | Reading (dBuV) | Correct Factor (dB/m) | Result (dBuV/m) | Limit (dBuV/m) | Margin (dB) | Remark |
|-----|-----------------|----------------|-----------------------|-----------------|----------------|-------------|--------|
| 1 | 10460.000 | 34.22 | 16.91 | 51.13 | 68.20 | -17.07 | peak |
| 2 | 15690.000 | 35.51 | 18.31 | 53.82 | 74.00 | -20.18 | peak |
| 3 | 15690.000 | 26.61 | 18.31 | 44.92 | 54.00 | -9.08 | AVG |

Note:1.Result (dBuV/m) = Correct Factor (dB/m) + Reading(dBuV).

2.Correction factor (dB/m) = Antenna Factor (dB/m) + Cable loss (dB) – Pre-Amplifier gain (dB).

3.When the peak results are less than average limit, so not need to evaluate the average.



| | | | |
|-------------|-----------------|----------------|-----|
| Standard: | FCC Part 15.407 | Test Distance: | 3 m |
| Test item: | Harmonic | | |
| Frequency: | 5230 MHz | | |
| Mode: | Mode 9 | | |
| Ant.Polar.: | Vertical | | |

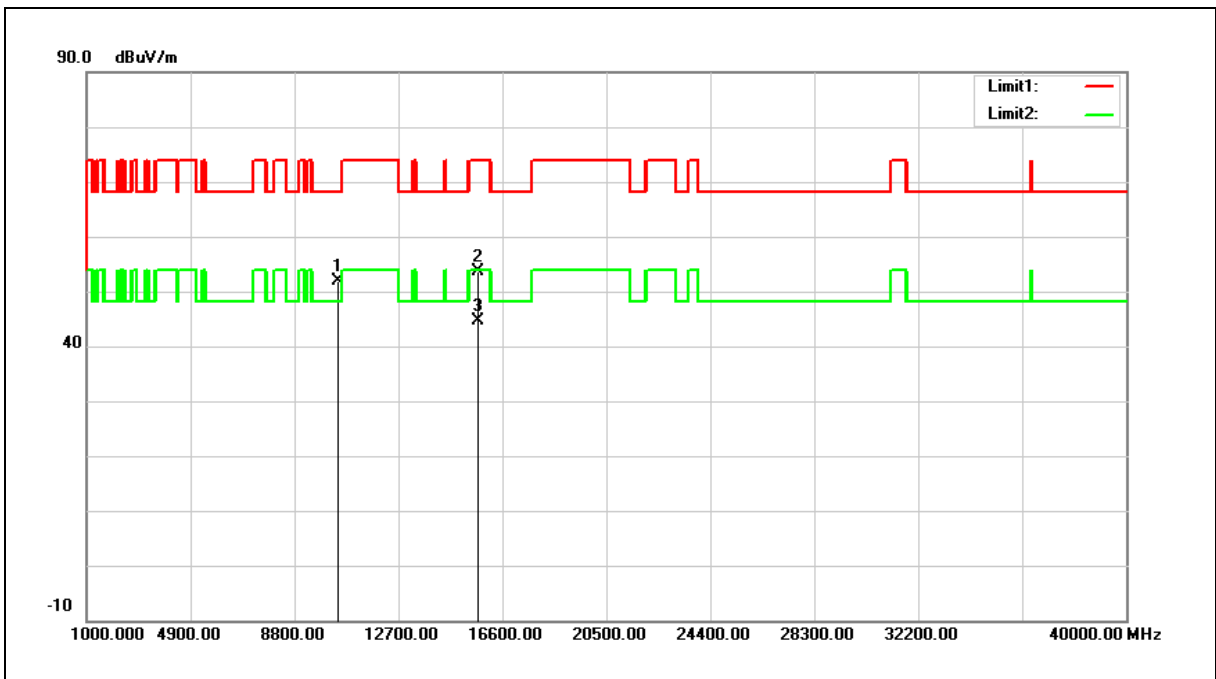

| No. | Frequency (MHz) | Reading (dBuV) | Correct Factor (dB/m) | Result (dBuV/m) | Limit (dBuV/m) | Margin (dB) | Remark |
|-----|-----------------|----------------|-----------------------|-----------------|----------------|-------------|--------|
| 1 | 10460.000 | 34.97 | 16.91 | 51.88 | 68.20 | -16.32 | peak |
| 2 | 15690.000 | 35.21 | 18.31 | 53.52 | 74.00 | -20.48 | peak |
| 3 | 15690.000 | 26.31 | 18.31 | 44.62 | 54.00 | -9.38 | AVG |

Note:1.Result (dBuV/m) = Correct Factor (dB/m) + Reading(dBuV).

2.Correction factor (dB/m) = Antenna Factor (dB/m) + Cable loss (dB) – Pre-Amplifier gain (dB).

3.When the peak results are less than average limit, so not need to evaluate the average.



| | | | |
|-------------|-----------------|----------------|-----|
| Standard: | FCC Part 15.407 | Test Distance: | 3 m |
| Test item: | Harmonic | | |
| Frequency: | 5270 MHz | | |
| Mode: | Mode 9 | | |
| Ant.Polar.: | Horizontal | | |

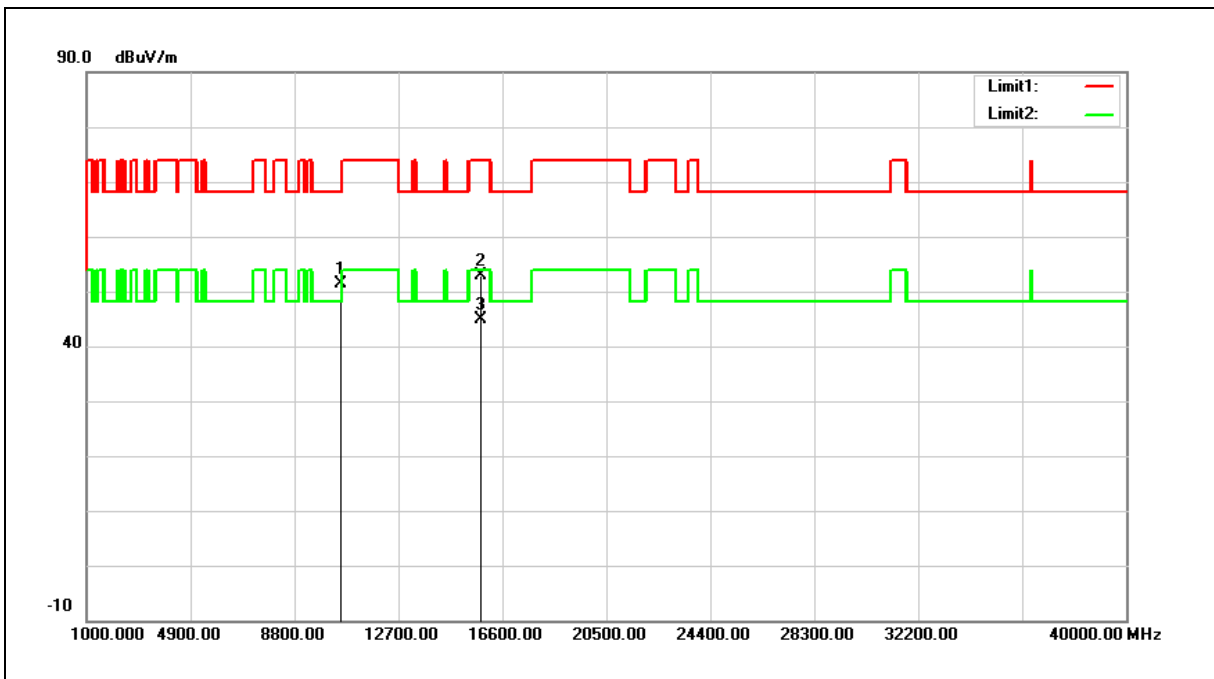

| No. | Frequency (MHz) | Reading (dBuV) | Correct Factor (dB/m) | Result (dBuV/m) | Limit (dBuV/m) | Margin (dB) | Remark |
|-----|-----------------|----------------|-----------------------|-----------------|----------------|-------------|--------|
| 1 | 10540.000 | 34.29 | 17.07 | 51.36 | 68.20 | -16.84 | peak |
| 2 | 15810.000 | 35.16 | 17.80 | 52.96 | 74.00 | -21.04 | peak |
| 3 | 15810.000 | 26.96 | 17.80 | 44.76 | 54.00 | -9.24 | AVG |

Note:1.Result (dBuV/m) = Correct Factor (dB/m) + Reading(dBuV).

2.Correction factor (dB/m) = Antenna Factor (dB/m) + Cable loss (dB) – Pre-Amplifier gain (dB).

3.When the peak results are less than average limit, so not need to evaluate the average.



| | | | |
|-------------|-----------------|----------------|-----|
| Standard: | FCC Part 15.407 | Test Distance: | 3 m |
| Test item: | Harmonic | | |
| Frequency: | 5270 MHz | | |
| Mode: | Mode 9 | | |
| Ant.Polar.: | Vertical | | |

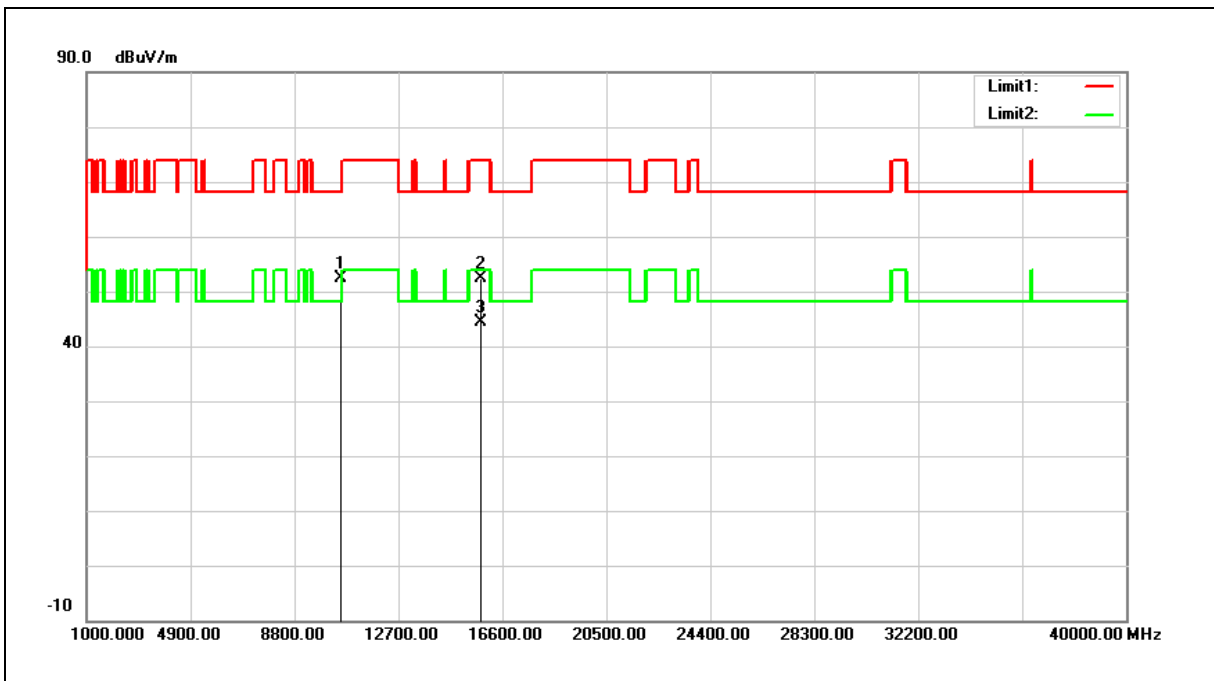

| No. | Frequency (MHz) | Reading (dBuV) | Correct Factor (dB/m) | Result (dBuV/m) | Limit (dBuV/m) | Margin (dB) | Remark |
|-----|-----------------|----------------|-----------------------|-----------------|----------------|-------------|--------|
| 1 | 10540.000 | 35.27 | 17.07 | 52.34 | 68.20 | -15.86 | peak |
| 2 | 15810.000 | 34.69 | 17.80 | 52.49 | 74.00 | -21.51 | peak |
| 3 | 15810.000 | 26.66 | 17.80 | 44.46 | 54.00 | -9.54 | AVG |

Note:1.Result (dBuV/m) = Correct Factor (dB/m) + Reading(dBuV).

2.Correction factor (dB/m) = Antenna Factor (dB/m) + Cable loss (dB) – Pre-Amplifier gain (dB).

3.When the peak results are less than average limit, so not need to evaluate the average.



| | | | |
|-------------|-----------------|----------------|-----|
| Standard: | FCC Part 15.407 | Test Distance: | 3 m |
| Test item: | Harmonic | | |
| Frequency: | 5310 MHz | | |
| Mode: | Mode 9 | | |
| Ant.Polar.: | Horizontal | | |

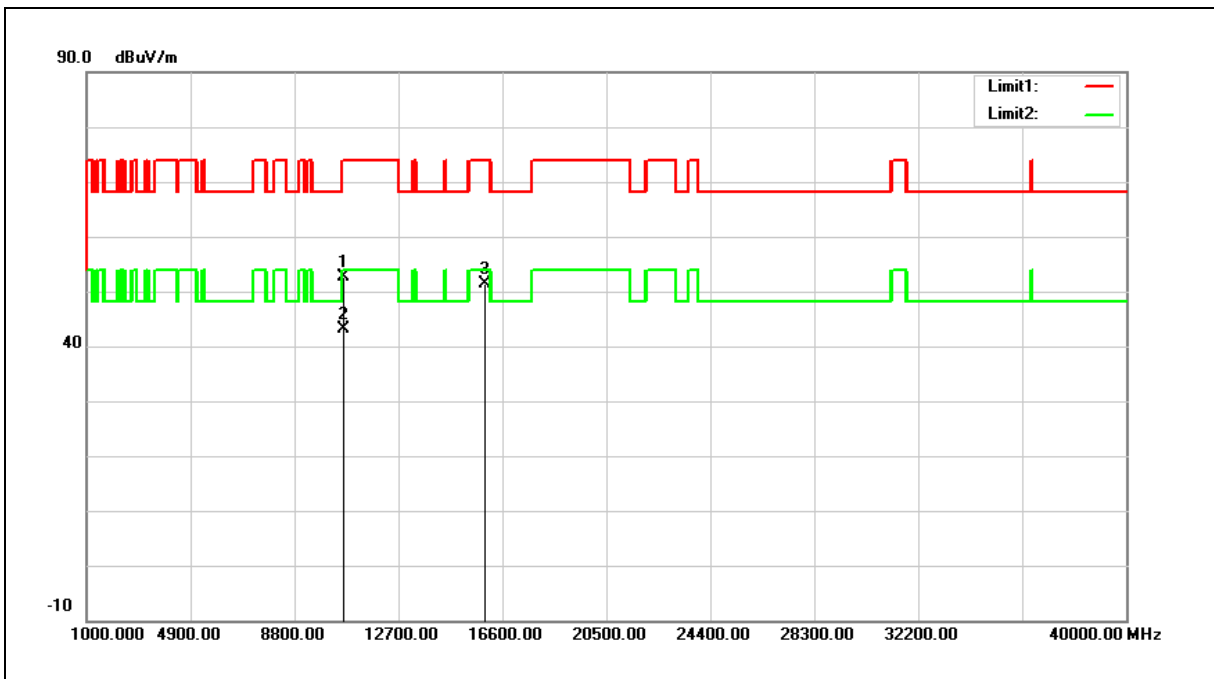

| No. | Frequency (MHz) | Reading (dBuV) | Correct Factor (dB/m) | Result (dBuV/m) | Limit (dBuV/m) | Margin (dB) | Remark |
|-----|-----------------|----------------|-----------------------|-----------------|----------------|-------------|--------|
| 1 | 10620.000 | 35.51 | 17.13 | 52.64 | 74.00 | -21.36 | peak |
| 2 | 10620.000 | 25.89 | 17.13 | 43.02 | 54.00 | -10.98 | AVG |
| 3 | 15930.000 | 34.18 | 17.30 | 51.48 | 74.00 | -22.52 | peak |

Note:1.Result (dBuV/m) = Correct Factor (dB/m) + Reading(dBuV).

2.Correction factor (dB/m) = Antenna Factor (dB/m) + Cable loss (dB) – Pre-Amplifier gain (dB).

3.When the peak results are less than average limit, so not need to evaluate the average.



| | | | |
|-------------|-----------------|----------------|-----|
| Standard: | FCC Part 15.407 | Test Distance: | 3 m |
| Test item: | Harmonic | | |
| Frequency: | 5310 MHz | | |
| Mode: | Mode 9 | | |
| Ant.Polar.: | Vertical | | |

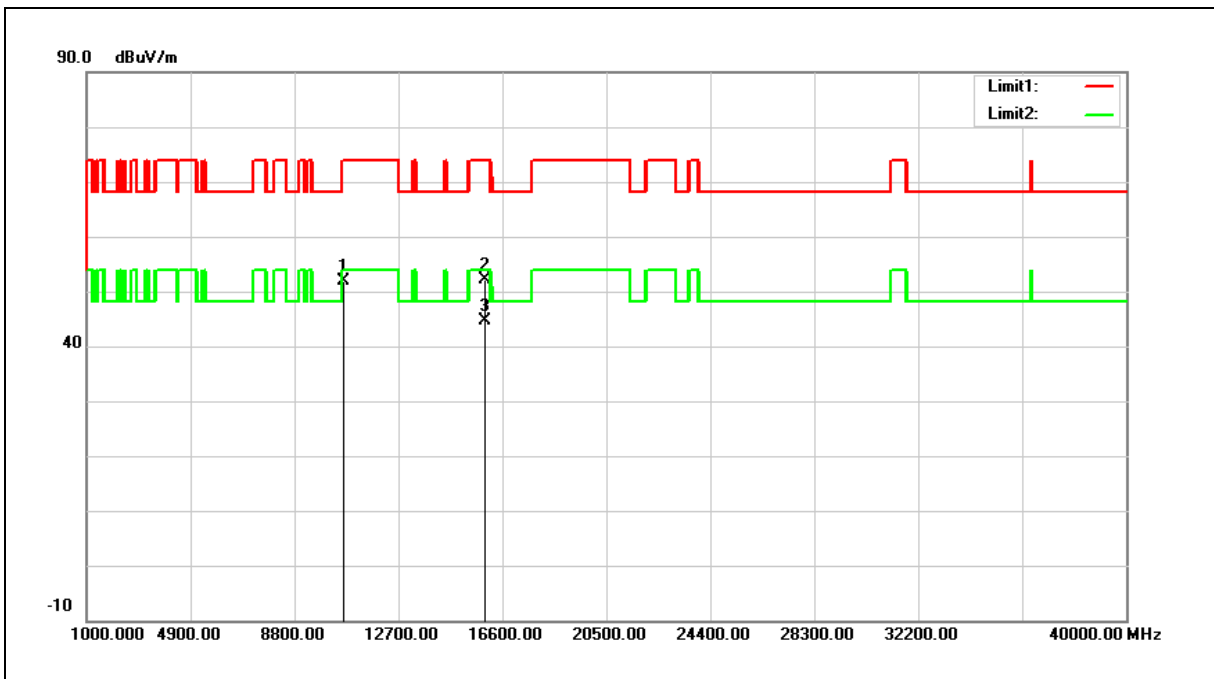

| No. | Frequency (MHz) | Reading (dBuV) | Correct Factor (dB/m) | Result (dBuV/m) | Limit (dBuV/m) | Margin (dB) | Remark |
|-----|-----------------|----------------|-----------------------|-----------------|----------------|-------------|--------|
| 1 | 10620.000 | 34.73 | 17.13 | 51.86 | 74.00 | -22.14 | peak |
| 2 | 15930.000 | 34.79 | 17.30 | 52.09 | 74.00 | -21.91 | peak |
| 3 | 15930.000 | 27.33 | 17.30 | 44.63 | 54.00 | -9.37 | AVG |

Note:1.Result (dBuV/m) = Correct Factor (dB/m) + Reading(dBuV).

2.Correction factor (dB/m) = Antenna Factor (dB/m) + Cable loss (dB) – Pre-Amplifier gain (dB).

3.When the peak results are less than average limit, so not need to evaluate the average.



| | | | |
|-------------|-----------------|----------------|-----|
| Standard: | FCC Part 15.407 | Test Distance: | 3 m |
| Test item: | Harmonic | | |
| Frequency: | 5510 MHz | | |
| Mode: | Mode 9 | | |
| Ant.Polar.: | Horizontal | | |

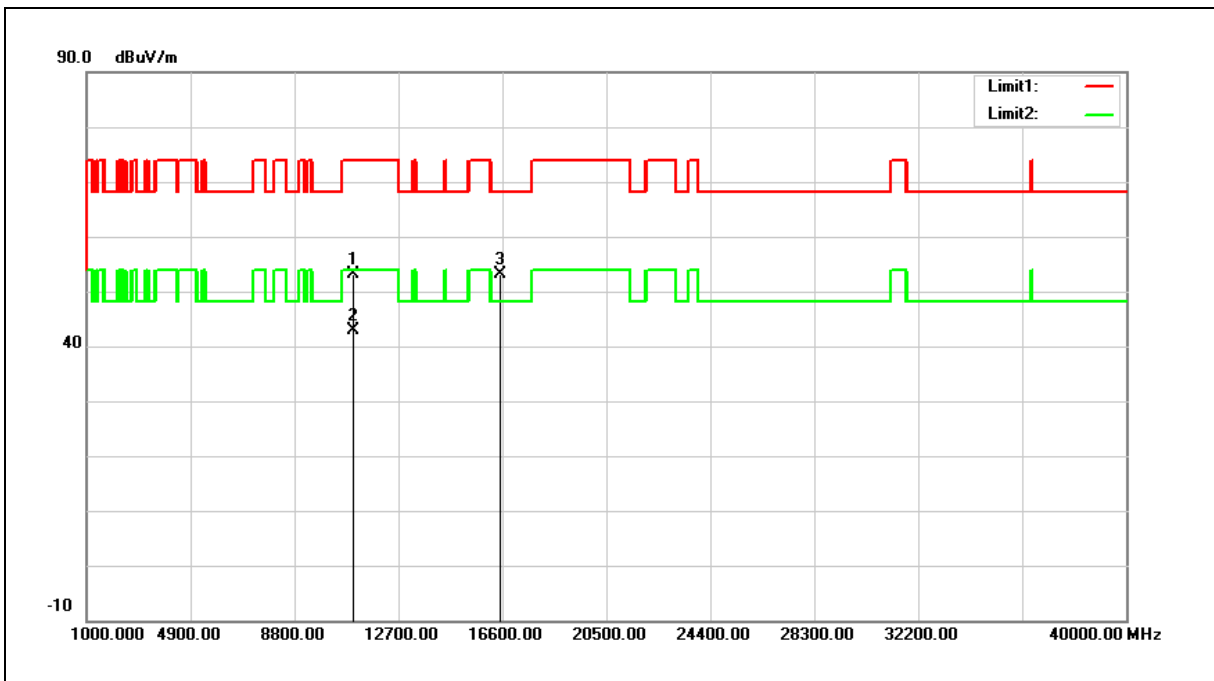

| No. | Frequency (MHz) | Reading (dBuV) | Correct Factor (dB/m) | Result (dBuV/m) | Limit (dBuV/m) | Margin (dB) | Remark |
|-----|-----------------|----------------|-----------------------|-----------------|----------------|-------------|--------|
| 1 | 11020.000 | 35.73 | 17.45 | 53.18 | 74.00 | -20.82 | peak |
| 2 | 11020.000 | 25.48 | 17.45 | 42.93 | 54.00 | -11.07 | AVG |
| 3 | 16530.000 | 34.25 | 18.97 | 53.22 | 68.20 | -14.98 | peak |

Note:1.Result (dBuV/m) = Correct Factor (dB/m) + Reading(dBuV).

2.Correction factor (dB/m) = Antenna Factor (dB/m) + Cable loss (dB) – Pre-Amplifier gain (dB).

3.When the peak results are less than average limit, so not need to evaluate the average.



| | | | |
|-------------|-----------------|----------------|-----|
| Standard: | FCC Part 15.407 | Test Distance: | 3 m |
| Test item: | Harmonic | | |
| Frequency: | 5510 MHz | | |
| Mode: | Mode 9 | | |
| Ant.Polar.: | Vertical | | |

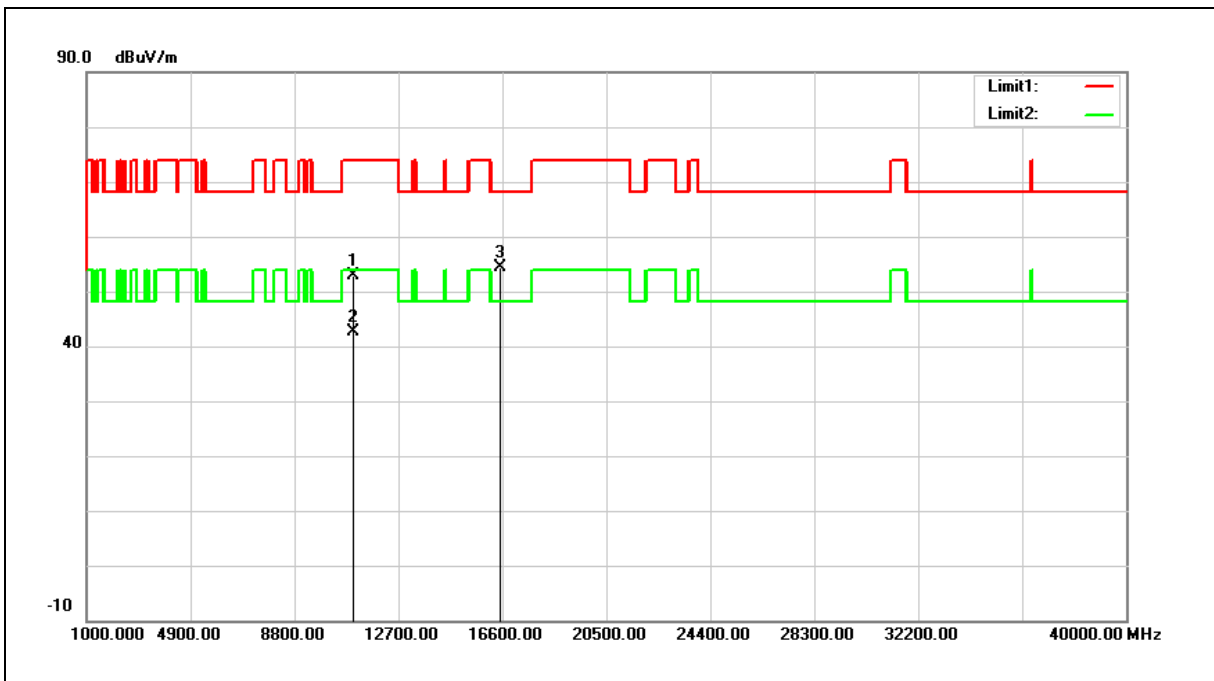

| No. | Frequency (MHz) | Reading (dBuV) | Correct Factor (dB/m) | Result (dBuV/m) | Limit (dBuV/m) | Margin (dB) | Remark |
|-----|-----------------|----------------|-----------------------|-----------------|----------------|-------------|--------|
| 1 | 11020.000 | 35.34 | 17.45 | 52.79 | 74.00 | -21.21 | peak |
| 2 | 11020.000 | 25.29 | 17.45 | 42.74 | 54.00 | -11.26 | AVG |
| 3 | 16530.000 | 35.39 | 18.97 | 54.36 | 68.20 | -13.84 | peak |

Note:1.Result (dBuV/m) = Correct Factor (dB/m) + Reading(dBuV).

2.Correction factor (dB/m) = Antenna Factor (dB/m) + Cable loss (dB) – Pre-Amplifier gain (dB).

3.When the peak results are less than average limit, so not need to evaluate the average.



| | | | |
|-------------|-----------------|----------------|-----|
| Standard: | FCC Part 15.407 | Test Distance: | 3 m |
| Test item: | Harmonic | | |
| Frequency: | 5550 MHz | | |
| Mode: | Mode 9 | | |
| Ant.Polar.: | Horizontal | | |

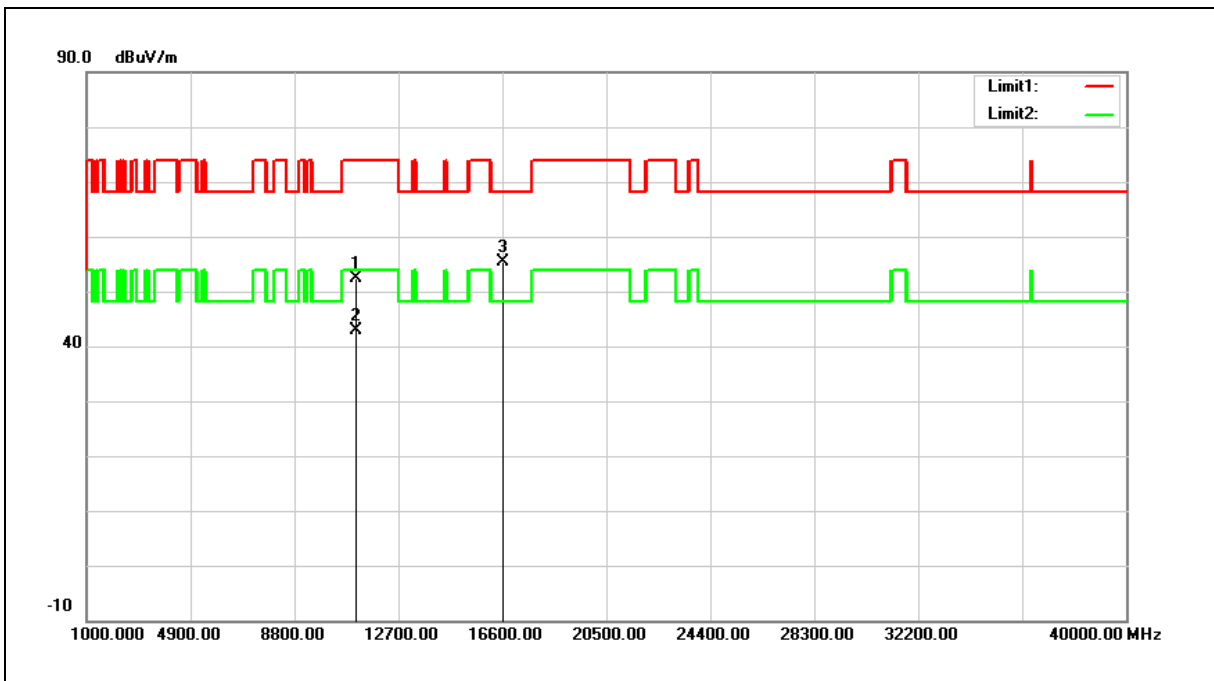

| No. | Frequency (MHz) | Reading (dBuV) | Correct Factor (dB/m) | Result (dBuV/m) | Limit (dBuV/m) | Margin (dB) | Remark |
|-----|-----------------|----------------|-----------------------|-----------------|----------------|-------------|--------|
| 1 | 11100.000 | 34.88 | 17.59 | 52.47 | 74.00 | -21.53 | peak |
| 2 | 11100.000 | 25.27 | 17.59 | 42.86 | 54.00 | -11.14 | AVG |
| 3 | 16650.000 | 35.52 | 19.95 | 55.47 | 68.20 | -12.73 | peak |

Note:1.Result (dBuV/m) = Correct Factor (dB/m) + Reading(dBuV).

2.Correction factor (dB/m) = Antenna Factor (dB/m) + Cable loss (dB) – Pre-Amplifier gain (dB).

3.When the peak results are less than average limit, so not need to evaluate the average.



| | | | |
|-------------|-----------------|----------------|-----|
| Standard: | FCC Part 15.407 | Test Distance: | 3 m |
| Test item: | Harmonic | | |
| Frequency: | 5550 MHz | | |
| Mode: | Mode 9 | | |
| Ant.Polar.: | Vertical | | |

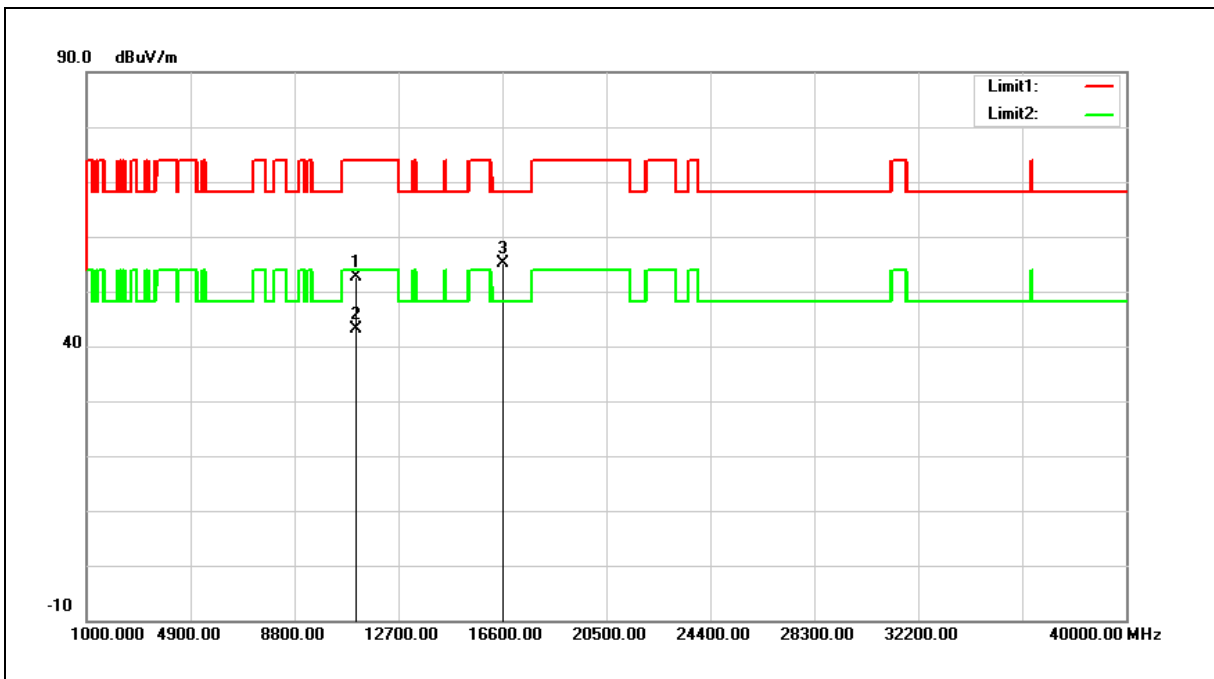

| No. | Frequency (MHz) | Reading (dBuV) | Correct Factor (dB/m) | Result (dBuV/m) | Limit (dBuV/m) | Margin (dB) | Remark |
|-----|-----------------|----------------|-----------------------|-----------------|----------------|-------------|--------|
| 1 | 11100.000 | 35.01 | 17.59 | 52.60 | 74.00 | -21.40 | peak |
| 2 | 11100.000 | 25.62 | 17.59 | 43.21 | 54.00 | -10.79 | AVG |
| 3 | 16650.000 | 35.16 | 19.95 | 55.11 | 68.20 | -13.09 | peak |

Note:1.Result (dBuV/m) = Correct Factor (dB/m) + Reading(dBuV).

2.Correction factor (dB/m) = Antenna Factor (dB/m) + Cable loss (dB) – Pre-Amplifier gain (dB).

3.When the peak results are less than average limit, so not need to evaluate the average.



| | | | |
|-------------|-----------------|----------------|-----|
| Standard: | FCC Part 15.407 | Test Distance: | 3 m |
| Test item: | Harmonic | | |
| Frequency: | 5670 MHz | | |
| Mode: | Mode 9 | | |
| Ant.Polar.: | Horizontal | | |

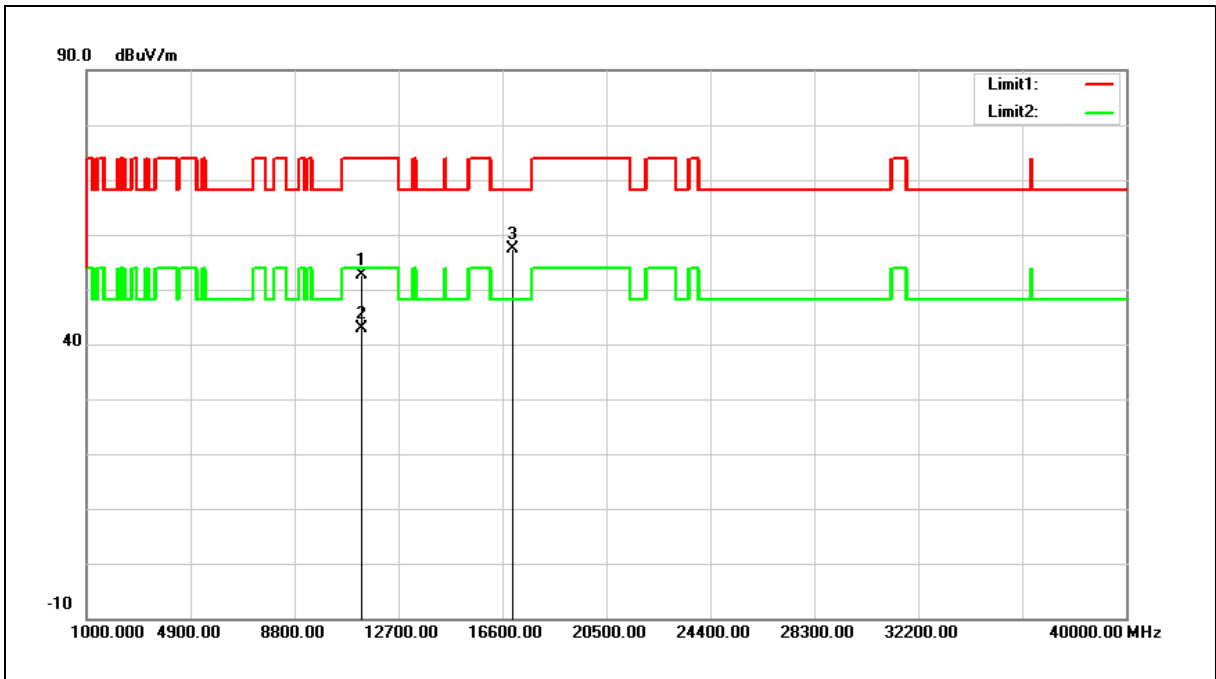

| No. | Frequency (MHz) | Reading (dBuV) | Correct Factor (dB/m) | Result (dBuV/m) | Limit (dBuV/m) | Margin (dB) | Remark |
|-----|-----------------|----------------|-----------------------|-----------------|----------------|-------------|--------|
| 1 | 11340.000 | 34.55 | 18.02 | 52.57 | 74.00 | -21.43 | peak |
| 2 | 11340.000 | 24.83 | 18.02 | 42.85 | 54.00 | -11.15 | AVG |
| 3 | 17010.000 | 34.51 | 22.85 | 57.36 | 68.20 | -10.84 | peak |

Note:1.Result (dBuV/m) = Correct Factor (dB/m) + Reading(dBuV).

2.Correction factor (dB/m) = Antenna Factor (dB/m) + Cable loss (dB) – Pre-Amplifier gain (dB).

3.When the peak results are less than average limit, so not need to evaluate the average.



| | | | |
|-------------|-----------------|----------------|-----|
| Standard: | FCC Part 15.407 | Test Distance: | 3 m |
| Test item: | Harmonic | | |
| Frequency: | 5670 MHz | | |
| Mode: | Mode 9 | | |
| Ant.Polar.: | Vertical | | |

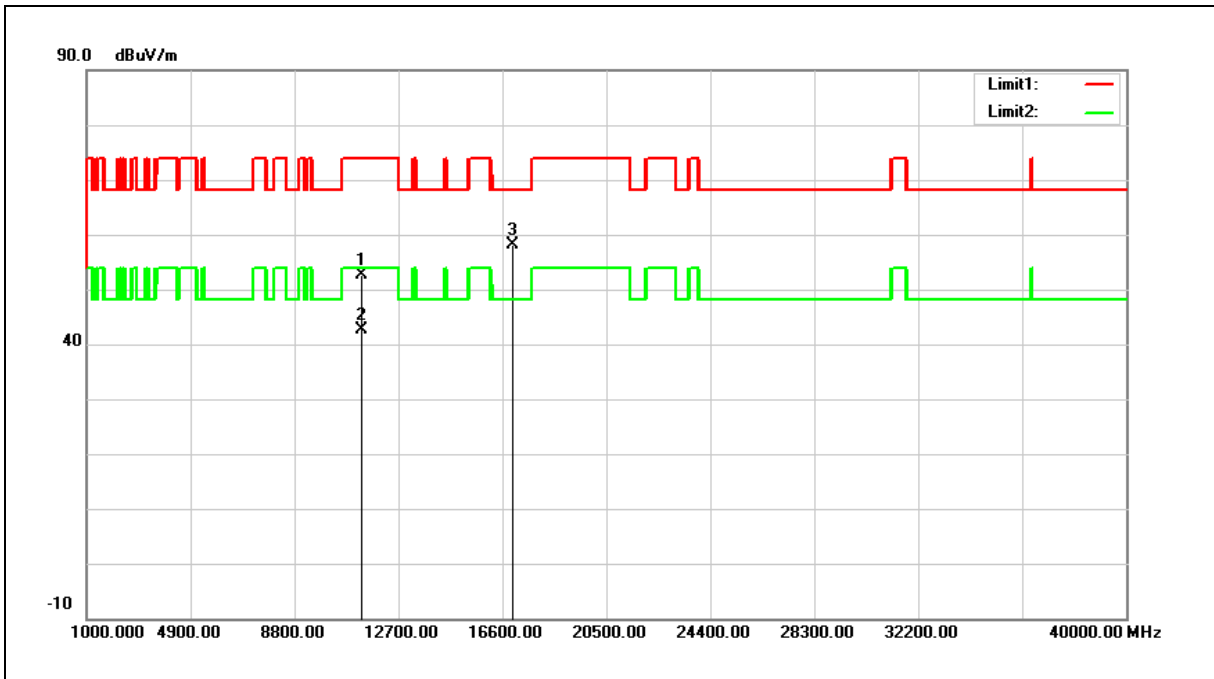

| No. | Frequency (MHz) | Reading (dBuV) | Correct Factor (dB/m) | Result (dBuV/m) | Limit (dBuV/m) | Margin (dB) | Remark |
|-----|-----------------|----------------|-----------------------|-----------------|----------------|-------------|--------|
| 1 | 11340.000 | 34.49 | 18.02 | 52.51 | 74.00 | -21.49 | peak |
| 2 | 11340.000 | 24.70 | 18.02 | 42.72 | 54.00 | -11.28 | AVG |
| 3 | 17010.000 | 35.34 | 22.85 | 58.19 | 68.20 | -10.01 | peak |

Note:1.Result (dBuV/m) = Correct Factor (dB/m) + Reading(dBuV).

2.Correction factor (dB/m) = Antenna Factor (dB/m) + Cable loss (dB) – Pre-Amplifier gain (dB).

3.When the peak results are less than average limit, so not need to evaluate the average.



| | | | |
|-------------|-----------------|----------------|-----|
| Standard: | FCC Part 15.407 | Test Distance: | 3 m |
| Test item: | Harmonic | | |
| Frequency: | 5710 MHz | | |
| Mode: | Mode 9 | | |
| Ant.Polar.: | Horizontal | | |

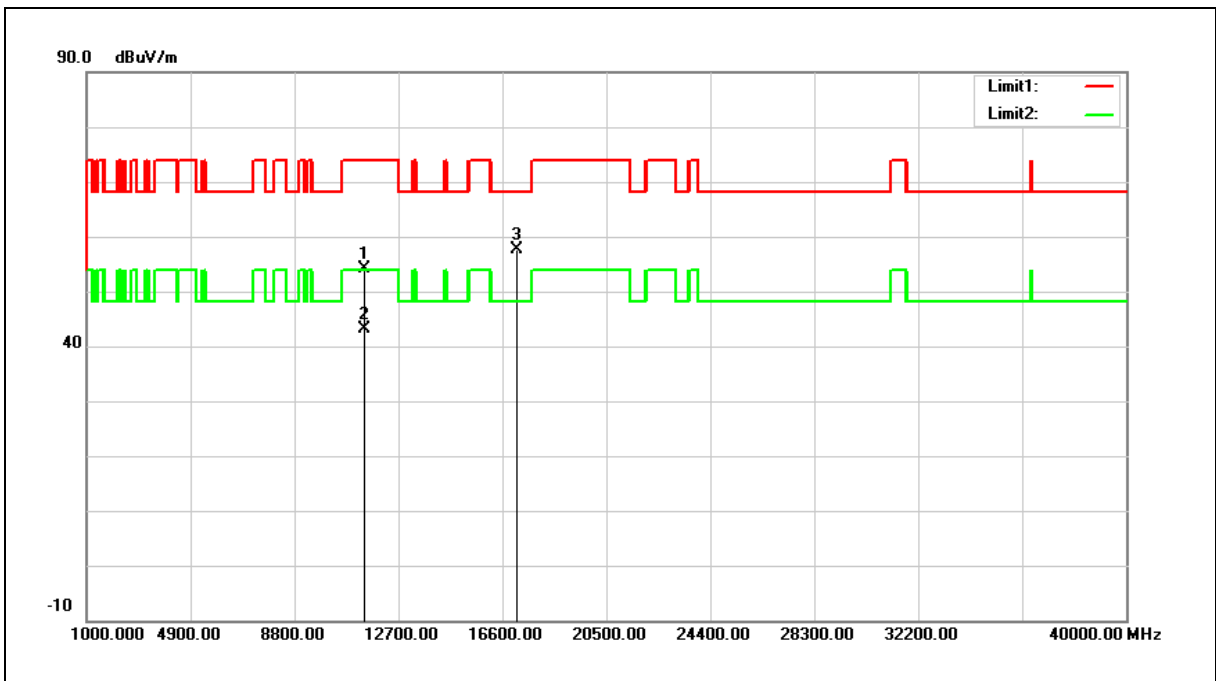

| No. | Frequency (MHz) | Reading (dBuV) | Correct Factor (dB/m) | Result (dBuV/m) | Limit (dBuV/m) | Margin (dB) | Remark |
|-----|-----------------|----------------|-----------------------|-----------------|----------------|-------------|--------|
| 1 | 11420.000 | 35.93 | 18.16 | 54.09 | 74.00 | -19.91 | peak |
| 2 | 11420.000 | 25.08 | 18.16 | 43.24 | 74.00 | -30.76 | peak |
| 3 | 17130.000 | 34.14 | 23.41 | 57.55 | 68.20 | -10.65 | peak |

Note:1.Result (dBuV/m) = Correct Factor (dB/m) + Reading(dBuV).

2.Correction factor (dB/m) = Antenna Factor (dB/m) + Cable loss (dB) – Pre-Amplifier gain (dB).

3.When the peak results are less than average limit, so not need to evaluate the average.



| | | | |
|-------------|-----------------|----------------|-----|
| Standard: | FCC Part 15.407 | Test Distance: | 3 m |
| Test item: | Harmonic | | |
| Frequency: | 5710 MHz | | |
| Mode: | Mode 9 | | |
| Ant.Polar.: | Vertical | | |

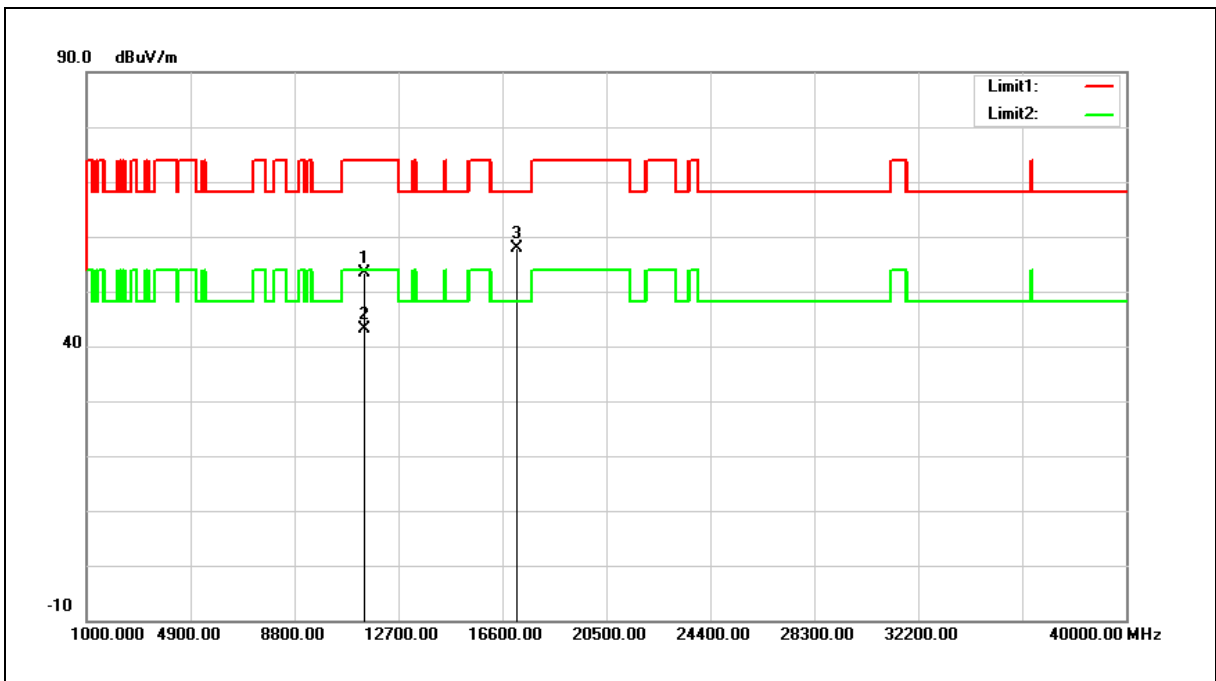

| No. | Frequency (MHz) | Reading (dBuV) | Correct Factor (dB/m) | Result (dBuV/m) | Limit (dBuV/m) | Margin (dB) | Remark |
|-----|-----------------|----------------|-----------------------|-----------------|----------------|-------------|--------|
| 1 | 11420.000 | 35.24 | 18.16 | 53.40 | 74.00 | -20.60 | peak |
| 2 | 11420.000 | 24.96 | 18.16 | 43.12 | 54.00 | -10.88 | AVG |
| 3 | 17130.000 | 34.40 | 23.41 | 57.81 | 68.20 | -10.39 | peak |

Note:1.Result (dBuV/m) = Correct Factor (dB/m) + Reading(dBuV).

2.Correction factor (dB/m) = Antenna Factor (dB/m) + Cable loss (dB) – Pre-Amplifier gain (dB).

3.When the peak results are less than average limit, so not need to evaluate the average.



| | | | |
|-------------|-----------------|----------------|-----|
| Standard: | FCC Part 15.407 | Test Distance: | 3 m |
| Test item: | Harmonic | | |
| Frequency: | 5755 MHz | | |
| Mode: | Mode 9 | | |
| Ant.Polar.: | Horizontal | | |

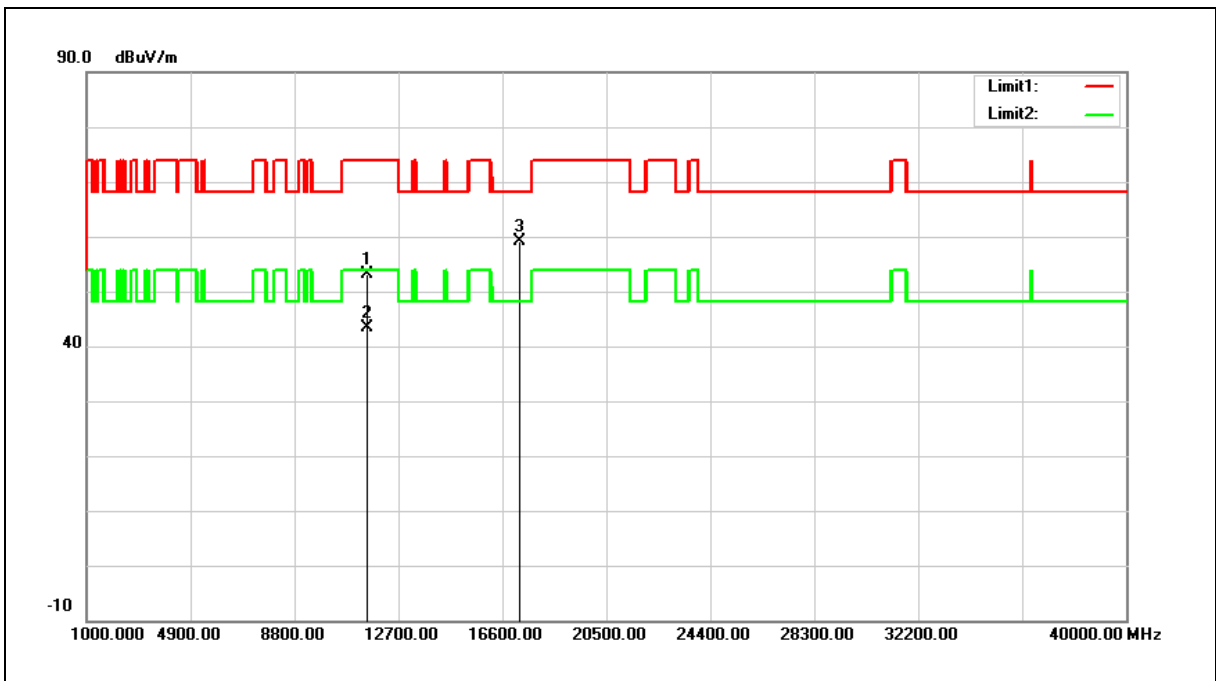

| No. | Frequency (MHz) | Reading (dBuV) | Correct Factor (dB/m) | Result (dBuV/m) | Limit (dBuV/m) | Margin (dB) | Remark |
|-----|-----------------|----------------|-----------------------|-----------------|----------------|-------------|--------|
| 1 | 11510.000 | 34.86 | 18.28 | 53.14 | 74.00 | -20.86 | peak |
| 2 | 11510.000 | 25.03 | 18.28 | 43.31 | 54.00 | -10.69 | AVG |
| 3 | 17265.000 | 35.13 | 24.03 | 59.16 | 68.20 | -9.04 | peak |

Note:1.Result (dBuV/m) = Correct Factor (dB/m) + Reading(dBuV).

2.Correction factor (dB/m) = Antenna Factor (dB/m) + Cable loss (dB) – Pre-Amplifier gain (dB).

3.When the peak results are less than average limit, so not need to evaluate the average.

| | | | |
|-------------|-----------------|----------------|-----|
| Standard: | FCC Part 15.407 | Test Distance: | 3 m |
| Test item: | Harmonic | | |
| Frequency: | 5755 MHz | | |
| Mode: | Mode 9 | | |
| Ant.Polar.: | Vertical | | |

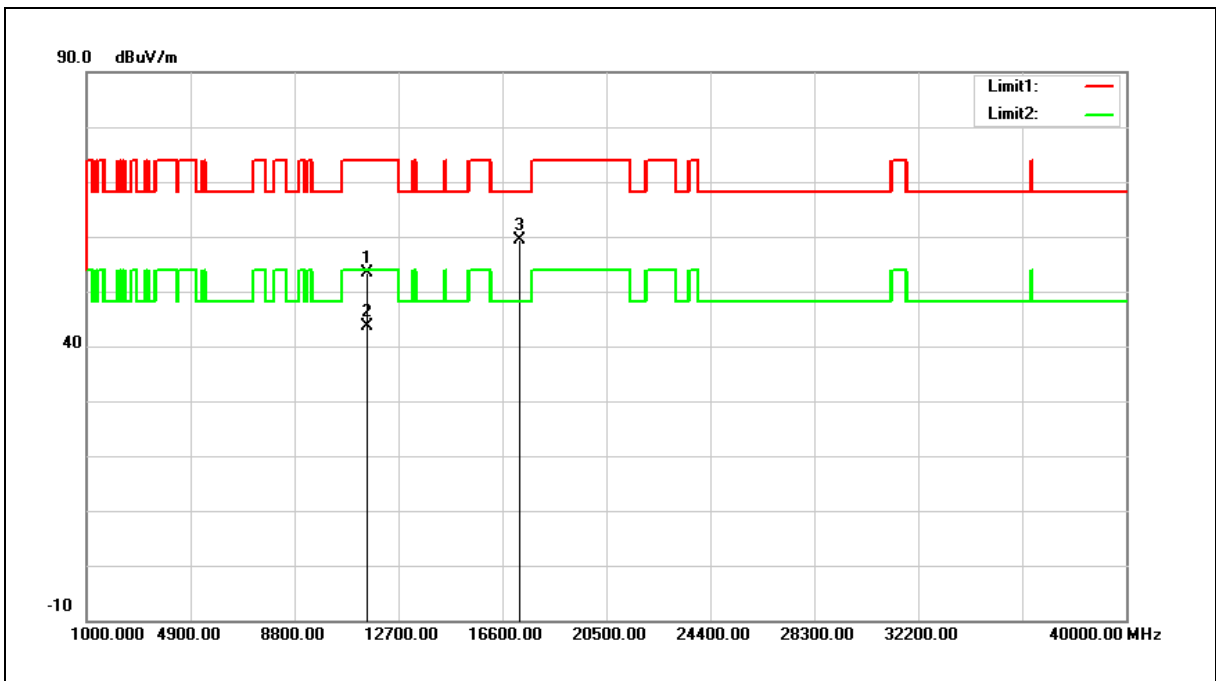

| No. | Frequency (MHz) | Reading (dBuV) | Correct Factor (dB/m) | Result (dBuV/m) | Limit (dBuV/m) | Margin (dB) | Remark |
|-----|-----------------|----------------|-----------------------|-----------------|----------------|-------------|--------|
| 1 | 11510.000 | 35.16 | 18.28 | 53.44 | 74.00 | -20.56 | peak |
| 2 | 11510.000 | 25.26 | 18.28 | 43.54 | 54.00 | -10.46 | AVG |
| 3 | 17265.000 | 35.36 | 24.03 | 59.39 | 68.20 | -8.81 | peak |

Note:1.Result (dBuV/m) = Correct Factor (dB/m) + Reading(dBuV).

2.Correction factor (dB/m) = Antenna Factor (dB/m) + Cable loss (dB) – Pre-Amplifier gain (dB).

3.When the peak results are less than average limit, so not need to evaluate the average.



| | | | |
|-------------|-----------------|----------------|-----|
| Standard: | FCC Part 15.407 | Test Distance: | 3 m |
| Test item: | Harmonic | | |
| Frequency: | 5795 MHz | | |
| Mode: | Mode 9 | | |
| Ant.Polar.: | Horizontal | | |

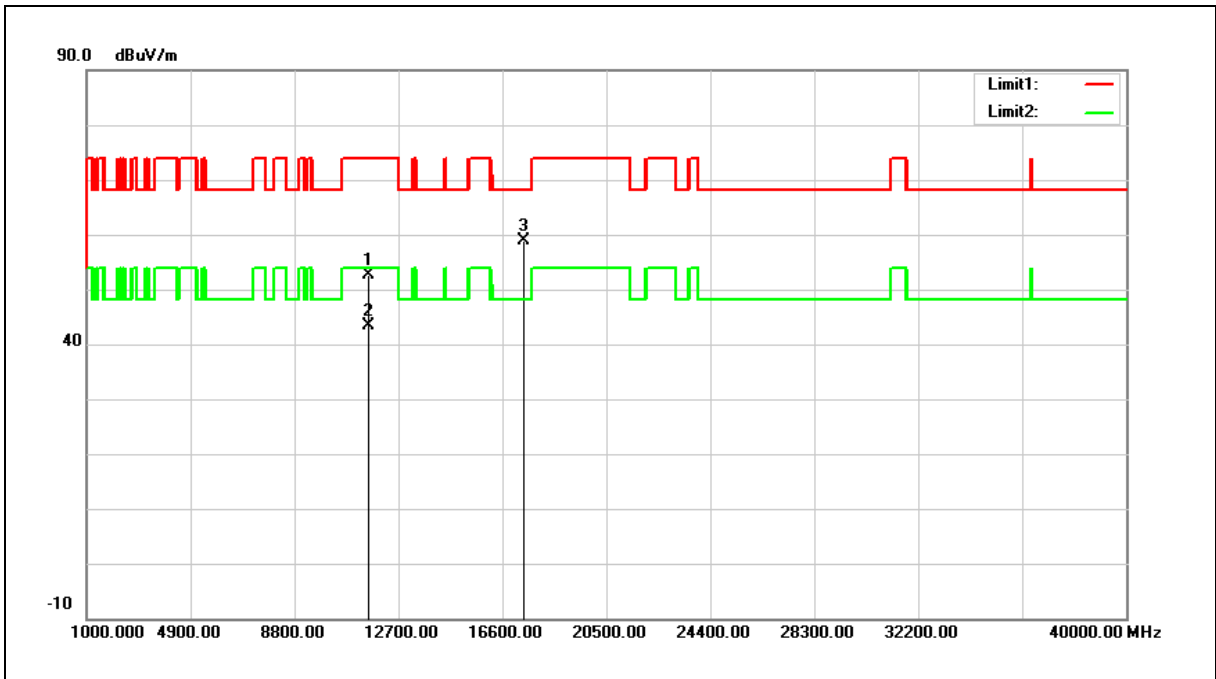

| No. | Frequency (MHz) | Reading (dBuV) | Correct Factor (dB/m) | Result (dBuV/m) | Limit (dBuV/m) | Margin (dB) | Remark |
|-----|-----------------|----------------|-----------------------|-----------------|----------------|-------------|--------|
| 1 | 11590.000 | 34.51 | 18.09 | 52.60 | 74.00 | -21.40 | peak |
| 2 | 11590.000 | 25.29 | 18.09 | 43.38 | 54.00 | -10.62 | AVG |
| 3 | 17385.000 | 34.40 | 24.59 | 58.99 | 68.20 | -9.21 | peak |

Note:1.Result (dBuV/m) = Correct Factor (dB/m) + Reading(dBuV).

2.Correction factor (dB/m) = Antenna Factor (dB/m) + Cable loss (dB) – Pre-Amplifier gain (dB).

3.When the peak results are less than average limit, so not need to evaluate the average.



| | | | |
|-------------|-----------------|----------------|-----|
| Standard: | FCC Part 15.407 | Test Distance: | 3 m |
| Test item: | Harmonic | | |
| Frequency: | 5795 MHz | | |
| Mode: | Mode 9 | | |
| Ant.Polar.: | Vertical | | |

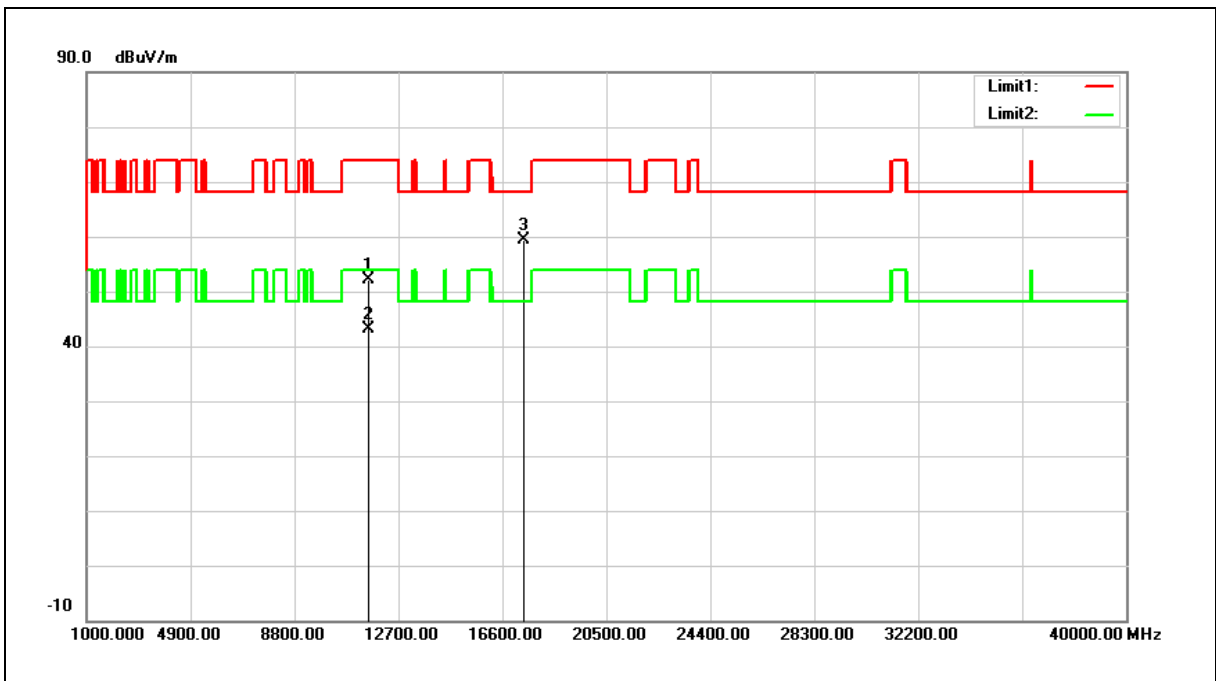

| No. | Frequency (MHz) | Reading (dBuV) | Correct Factor (dB/m) | Result (dBuV/m) | Limit (dBuV/m) | Margin (dB) | Remark |
|-----|-----------------|----------------|-----------------------|-----------------|----------------|-------------|--------|
| 1 | 11590.000 | 34.13 | 18.09 | 52.22 | 74.00 | -21.78 | peak |
| 2 | 11590.000 | 25.10 | 18.09 | 43.19 | 54.00 | -10.81 | AVG |
| 3 | 17385.000 | 34.83 | 24.59 | 59.42 | 68.20 | -8.78 | peak |

Note:1.Result (dBuV/m) = Correct Factor (dB/m) + Reading(dBuV).

2.Correction factor (dB/m) = Antenna Factor (dB/m) + Cable loss (dB) – Pre-Amplifier gain (dB).

3.When the peak results are less than average limit, so not need to evaluate the average.



| | | | |
|-------------|-----------------|----------------|-----|
| Standard: | FCC Part 15.407 | Test Distance: | 3 m |
| Test item: | Harmonic | | |
| Frequency: | 5210 MHz | | |
| Mode: | Mode 10 | | |
| Ant.Polar.: | Horizontal | | |

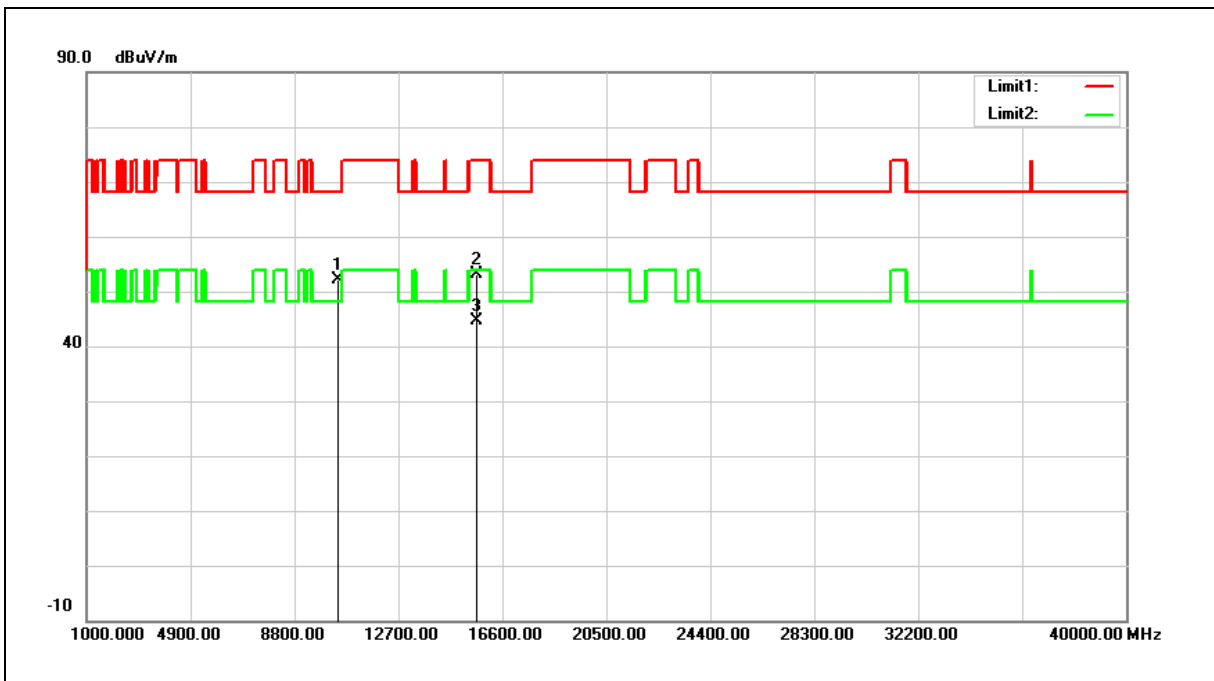

| No. | Frequency (MHz) | Reading (dBuV) | Correct Factor (dB/m) | Result (dBuV/m) | Limit (dBuV/m) | Margin (dB) | Remark |
|-----|-----------------|----------------|-----------------------|-----------------|----------------|-------------|--------|
| 1 | 10420.000 | 35.35 | 16.78 | 52.13 | 68.20 | -16.07 | peak |
| 2 | 15630.000 | 34.64 | 18.57 | 53.21 | 74.00 | -20.79 | peak |
| 3 | 15630.000 | 26.05 | 18.57 | 44.62 | 54.00 | -9.38 | AVG |

Note:1.Result (dBuV/m) = Correct Factor (dB/m) + Reading(dBuV).

2.Correction factor (dB/m) = Antenna Factor (dB/m) + Cable loss (dB) – Pre-Amplifier gain (dB).

3.When the peak results are less than average limit, so not need to evaluate the average.



| | | | |
|-------------|-----------------|----------------|-----|
| Standard: | FCC Part 15.407 | Test Distance: | 3 m |
| Test item: | Harmonic | | |
| Frequency: | 5210 MHz | | |
| Mode: | Mode 10 | | |
| Ant.Polar.: | Vertical | | |

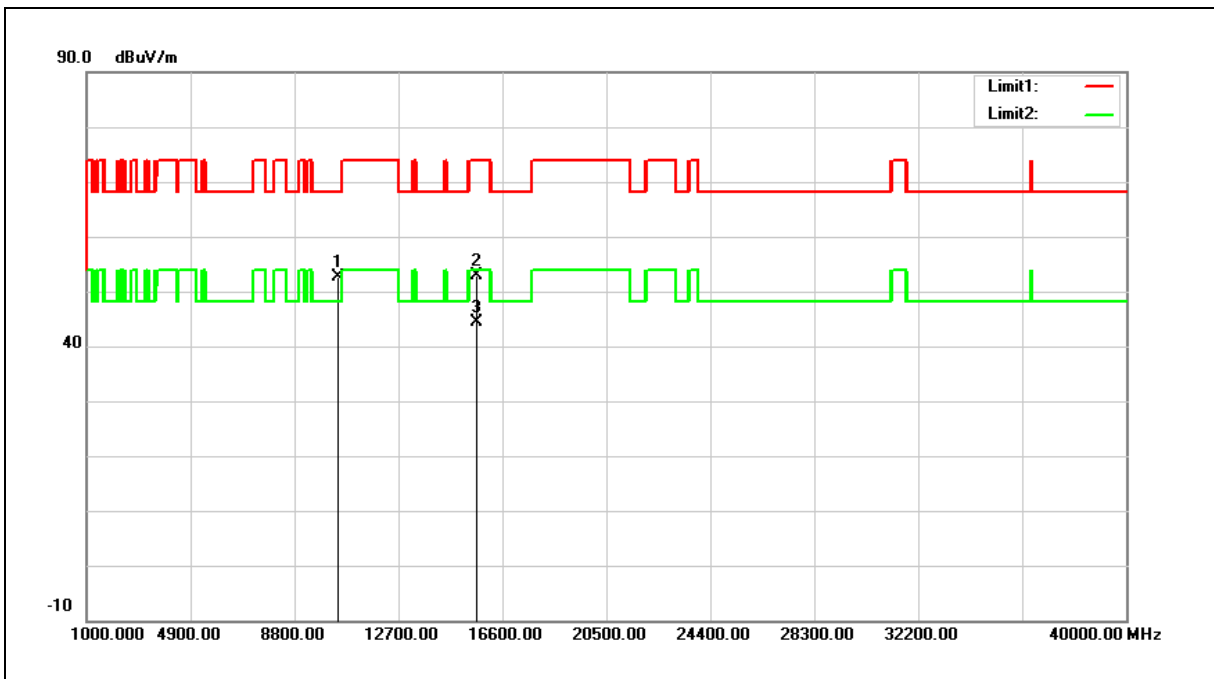

| No. | Frequency (MHz) | Reading (dBuV) | Correct Factor (dB/m) | Result (dBuV/m) | Limit (dBuV/m) | Margin (dB) | Remark |
|-----|-----------------|----------------|-----------------------|-----------------|----------------|-------------|--------|
| 1 | 10420.000 | 35.76 | 16.78 | 52.54 | 68.20 | -15.66 | peak |
| 2 | 15630.000 | 34.23 | 18.57 | 52.80 | 74.00 | -21.20 | peak |
| 3 | 15630.000 | 25.92 | 18.57 | 44.49 | 54.00 | -9.51 | AVG |

Note:1.Result (dBuV/m) = Correct Factor (dB/m) + Reading(dBuV).

2.Correction factor (dB/m) = Antenna Factor (dB/m) + Cable loss (dB) – Pre-Amplifier gain (dB).

3.When the peak results are less than average limit, so not need to evaluate the average.

| | | | |
|-------------|-----------------|----------------|-----|
| Standard: | FCC Part 15.407 | Test Distance: | 3 m |
| Test item: | Harmonic | | |
| Frequency: | 5290 MHz | | |
| Mode: | Mode 10 | | |
| Ant.Polar.: | Horizontal | | |

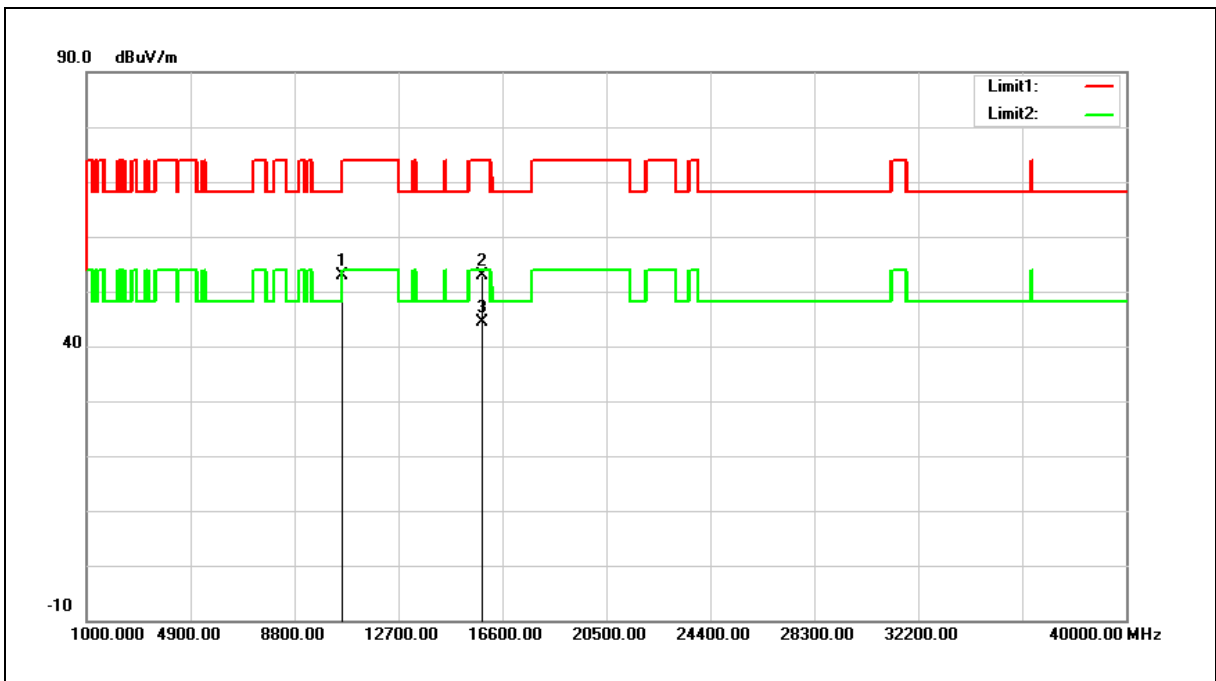

| No. | Frequency (MHz) | Reading (dBuV) | Correct Factor (dB/m) | Result (dBuV/m) | Limit (dBuV/m) | Margin (dB) | Remark |
|-----|-----------------|----------------|-----------------------|-----------------|----------------|-------------|--------|
| 1 | 10580.000 | 35.68 | 17.10 | 52.78 | 68.20 | -15.42 | peak |
| 2 | 15870.000 | 35.27 | 17.55 | 52.82 | 74.00 | -21.18 | peak |
| 3 | 15870.000 | 26.84 | 17.55 | 44.39 | 54.00 | -9.61 | AVG |

Note:1.Result (dBuV/m) = Correct Factor (dB/m) + Reading(dBuV).

2.Correction factor (dB/m) = Antenna Factor (dB/m) + Cable loss (dB) – Pre-Amplifier gain (dB).

3.When the peak results are less than average limit, so not need to evaluate the average.



| | | | |
|-------------|-----------------|----------------|-----|
| Standard: | FCC Part 15.407 | Test Distance: | 3 m |
| Test item: | Harmonic | | |
| Frequency: | 5290 MHz | | |
| Mode: | Mode 10 | | |
| Ant.Polar.: | Vertical | | |

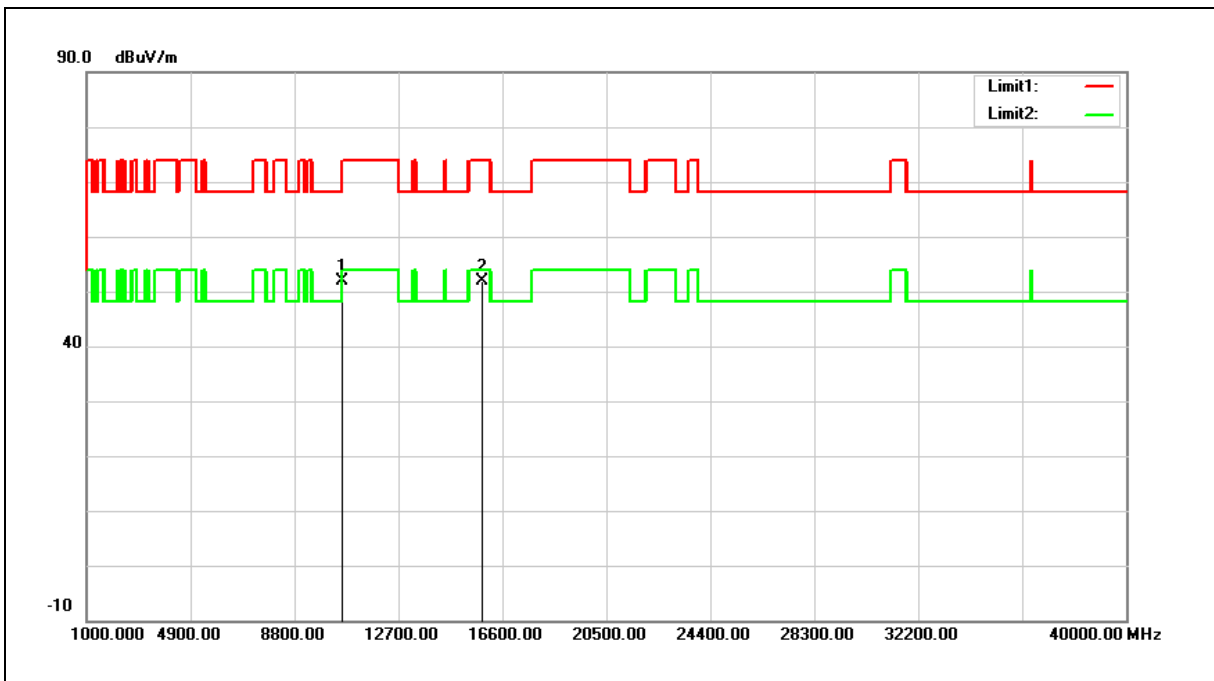

| No. | Frequency (MHz) | Reading (dBuV) | Correct Factor (dB/m) | Result (dBuV/m) | Limit (dBuV/m) | Margin (dB) | Remark |
|-----|-----------------|----------------|-----------------------|-----------------|----------------|-------------|--------|
| 1 | 10580.000 | 34.85 | 17.10 | 51.95 | 68.20 | -16.25 | peak |
| 2 | 15870.000 | 34.25 | 17.55 | 51.80 | 74.00 | -22.20 | peak |

Note:1.Result (dBuV/m) = Correct Factor (dB/m) + Reading(dBuV).

2.Correction factor (dB/m) = Antenna Factor (dB/m) + Cable loss (dB) – Pre-Amplifier gain (dB).

3.When the peak results are less than average limit, so not need to evaluate the average.



| | | | |
|-------------|-----------------|----------------|-----|
| Standard: | FCC Part 15.407 | Test Distance: | 3 m |
| Test item: | Harmonic | | |
| Frequency: | 5530 MHz | | |
| Mode: | Mode 10 | | |
| Ant.Polar.: | Horizontal | | |

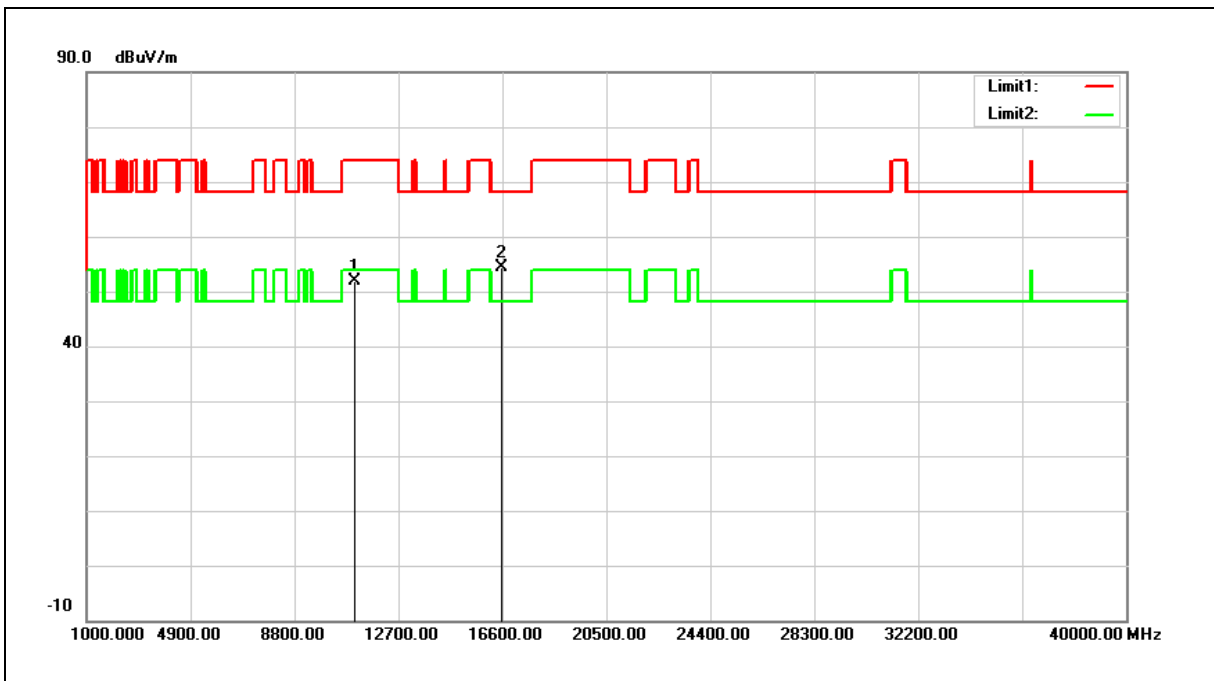

| No. | Frequency (MHz) | Reading (dBuV) | Correct Factor (dB/m) | Result (dBuV/m) | Limit (dBuV/m) | Margin (dB) | Remark |
|-----|-----------------|----------------|-----------------------|-----------------|----------------|-------------|--------|
| 1 | 11060.000 | 34.26 | 17.51 | 51.77 | 74.00 | -22.23 | peak |
| 2 | 16590.000 | 35.04 | 19.46 | 54.50 | 68.20 | -13.70 | peak |

Note:1.Result (dBuV/m) = Correct Factor (dB/m) + Reading(dBuV).

2.Correction factor (dB/m) = Antenna Factor (dB/m) + Cable loss (dB) – Pre-Amplifier gain (dB).

3.When the peak results are less than average limit, so not need to evaluate the average.



| | | | |
|-------------|-----------------|----------------|-----|
| Standard: | FCC Part 15.407 | Test Distance: | 3 m |
| Test item: | Harmonic | | |
| Frequency: | 5530 MHz | | |
| Mode: | Mode 10 | | |
| Ant.Polar.: | Vertical | | |

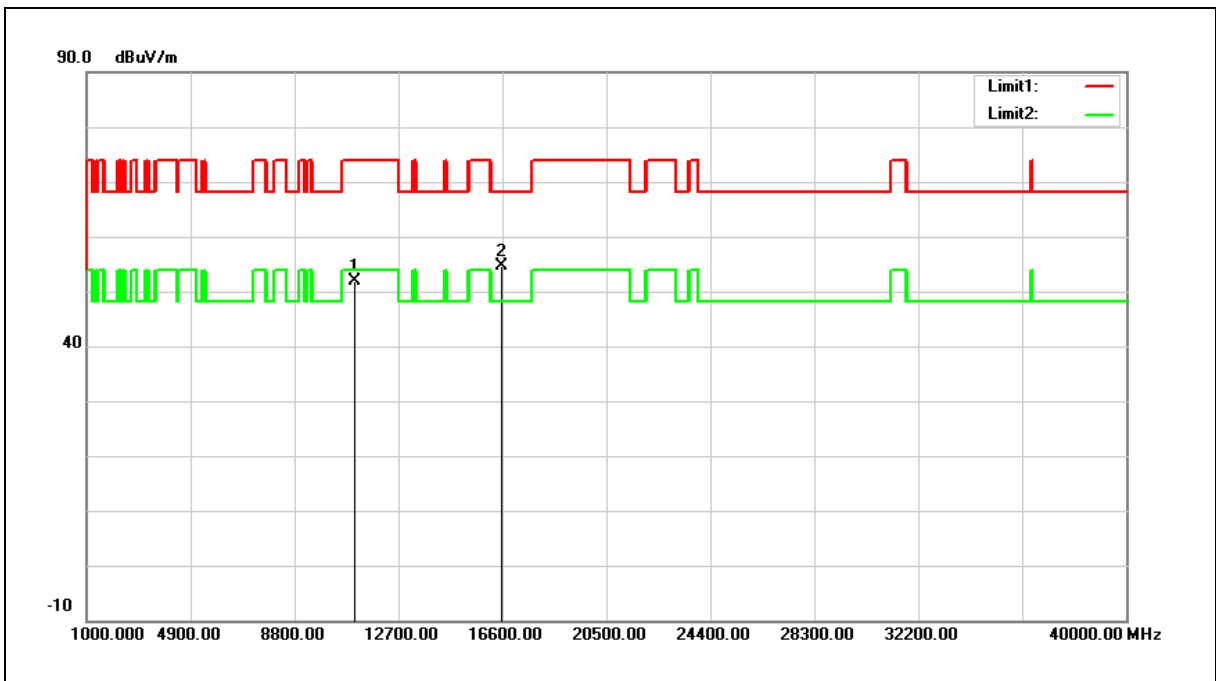

| No. | Frequency (MHz) | Reading (dBuV) | Correct Factor (dB/m) | Result (dBuV/m) | Limit (dBuV/m) | Margin (dB) | Remark |
|-----|-----------------|----------------|-----------------------|-----------------|----------------|-------------|--------|
| 1 | 11060.000 | 34.40 | 17.51 | 51.91 | 74.00 | -22.09 | peak |
| 2 | 16590.000 | 35.22 | 19.46 | 54.68 | 68.20 | -13.52 | peak |

Note:1.Result (dBuV/m) = Correct Factor (dB/m) + Reading(dBuV).

2.Correction factor (dB/m) = Antenna Factor (dB/m) + Cable loss (dB) – Pre-Amplifier gain (dB).

3.When the peak results are less than average limit, so not need to evaluate the average.



| | | | |
|-------------|-----------------|----------------|-----|
| Standard: | FCC Part 15.407 | Test Distance: | 3 m |
| Test item: | Harmonic | | |
| Frequency: | 5610 MHz | | |
| Mode: | Mode 10 | | |
| Ant.Polar.: | Horizontal | | |

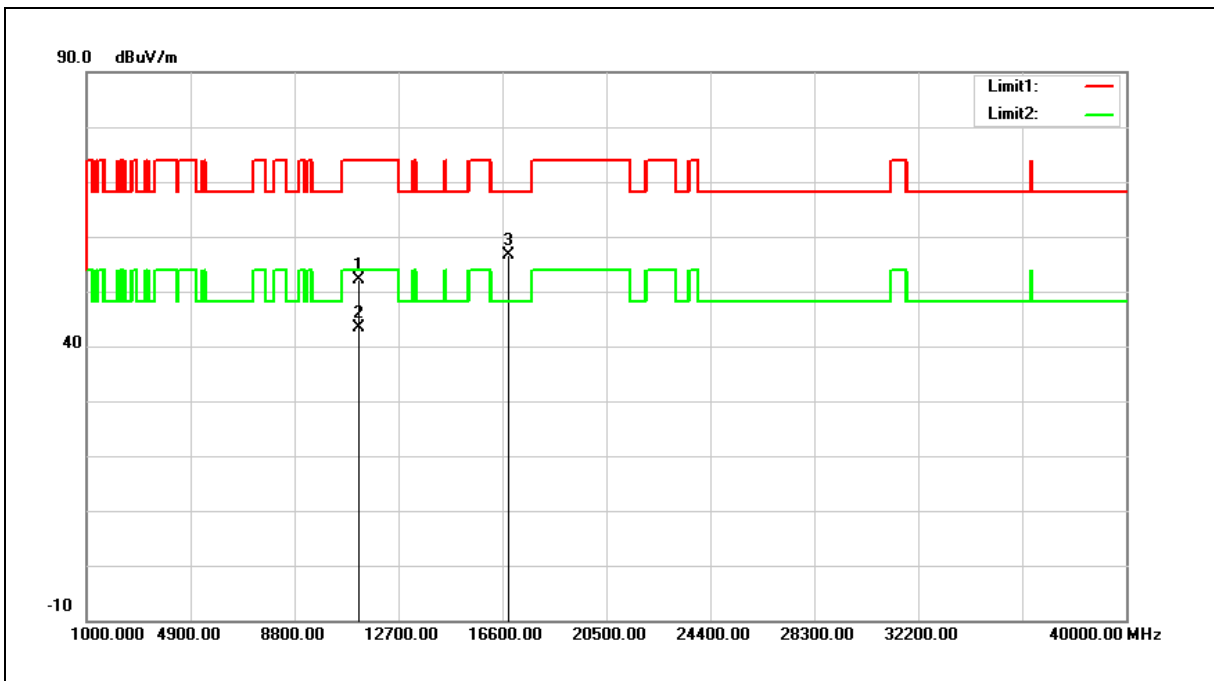

| No. | Frequency (MHz) | Reading (dBuV) | Correct Factor (dB/m) | Result (dBuV/m) | Limit (dBuV/m) | Margin (dB) | Remark |
|-----|-----------------|----------------|-----------------------|-----------------|----------------|-------------|--------|
| 1 | 11220.000 | 34.29 | 17.81 | 52.10 | 74.00 | -21.90 | peak |
| 2 | 11220.000 | 25.45 | 17.81 | 43.26 | 54.00 | -10.74 | AVG |
| 3 | 16830.000 | 35.18 | 21.42 | 56.60 | 68.20 | -11.60 | peak |

Note:1.Result (dBuV/m) = Correct Factor (dB/m) + Reading(dBuV).

2.Correction factor (dB/m) = Antenna Factor (dB/m) + Cable loss (dB) – Pre-Amplifier gain (dB).

3.When the peak results are less than average limit, so not need to evaluate the average.



| | | | |
|-------------|-----------------|----------------|-----|
| Standard: | FCC Part 15.407 | Test Distance: | 3 m |
| Test item: | Harmonic | | |
| Frequency: | 5610 MHz | | |
| Mode: | Mode 10 | | |
| Ant.Polar.: | Vertical | | |

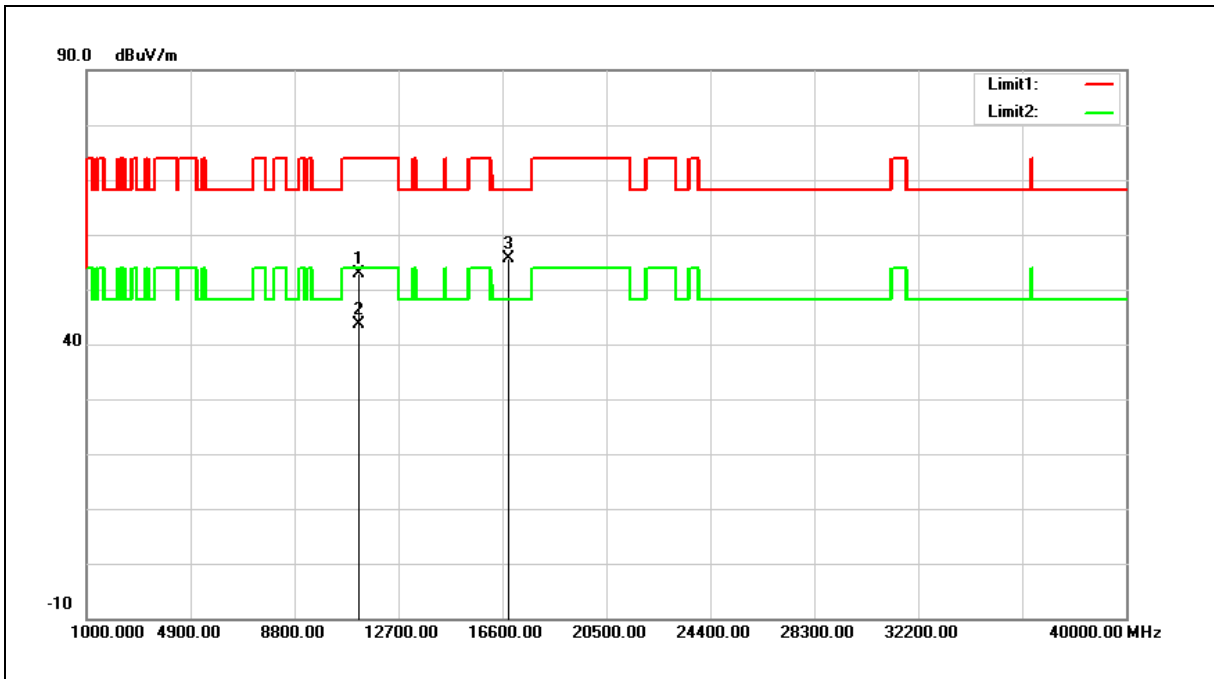

| No. | Frequency (MHz) | Reading (dBuV) | Correct Factor (dB/m) | Result (dBuV/m) | Limit (dBuV/m) | Margin (dB) | Remark |
|-----|-----------------|----------------|-----------------------|-----------------|----------------|-------------|--------|
| 1 | 11220.000 | 35.18 | 17.81 | 52.99 | 74.00 | -21.01 | peak |
| 2 | 11220.000 | 25.77 | 17.81 | 43.58 | 54.00 | -10.42 | AVG |
| 3 | 16830.000 | 34.24 | 21.42 | 55.66 | 68.20 | -12.54 | peak |

Note:1.Result (dBuV/m) = Correct Factor (dB/m) + Reading(dBuV).

2.Correction factor (dB/m) = Antenna Factor (dB/m) + Cable loss (dB) – Pre-Amplifier gain (dB).

3.When the peak results are less than average limit, so not need to evaluate the average.



| | | | |
|-------------|-----------------|----------------|-----|
| Standard: | FCC Part 15.407 | Test Distance: | 3 m |
| Test item: | Harmonic | | |
| Frequency: | 5690 MHz | | |
| Mode: | Mode 10 | | |
| Ant.Polar.: | Horizontal | | |

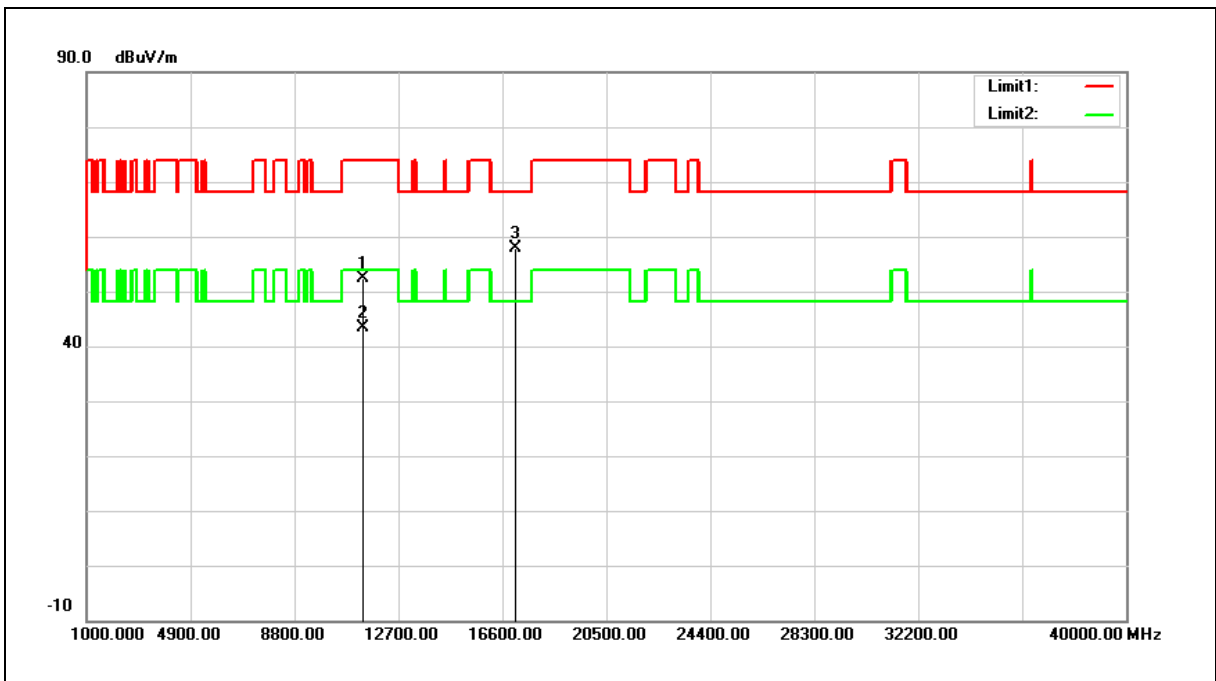

| No. | Frequency (MHz) | Reading (dBuV) | Correct Factor (dB/m) | Result (dBuV/m) | Limit (dBuV/m) | Margin (dB) | Remark |
|-----|-----------------|----------------|-----------------------|-----------------|----------------|-------------|--------|
| 1 | 11380.000 | 34.37 | 18.08 | 52.45 | 74.00 | -21.55 | peak |
| 2 | 11380.000 | 25.21 | 18.08 | 43.29 | 54.00 | -10.71 | AVG |
| 3 | 17070.000 | 34.85 | 23.13 | 57.98 | 68.20 | -10.22 | peak |

Note:1.Result (dBuV/m) = Correct Factor (dB/m) + Reading(dBuV).

2.Correction factor (dB/m) = Antenna Factor (dB/m) + Cable loss (dB) – Pre-Amplifier gain (dB).

3.When the peak results are less than average limit, so not need to evaluate the average.



| | | | |
|-------------|-----------------|----------------|-----|
| Standard: | FCC Part 15.407 | Test Distance: | 3 m |
| Test item: | Harmonic | | |
| Frequency: | 5690 MHz | | |
| Mode: | Mode 10 | | |
| Ant.Polar.: | Vertical | | |

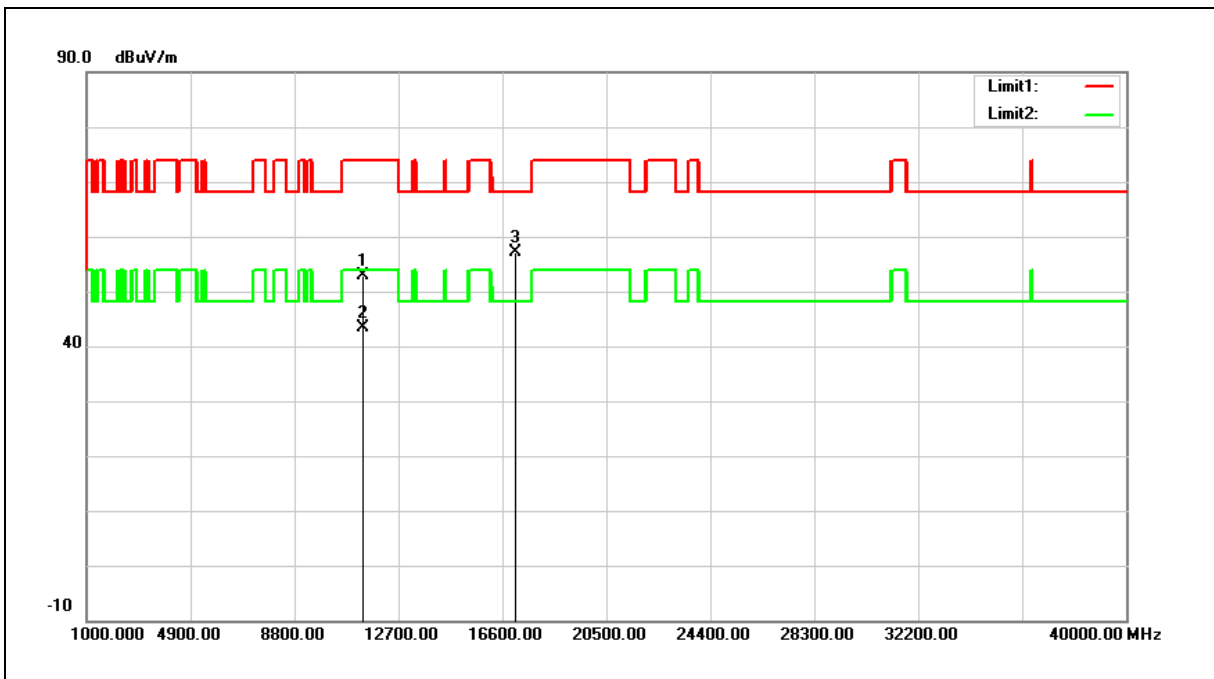

| No. | Frequency (MHz) | Reading (dBuV) | Correct Factor (dB/m) | Result (dBuV/m) | Limit (dBuV/m) | Margin (dB) | Remark |
|-----|-----------------|----------------|-----------------------|-----------------|----------------|-------------|--------|
| 1 | 11380.000 | 34.72 | 18.08 | 52.80 | 74.00 | -21.20 | peak |
| 2 | 11380.000 | 25.24 | 18.08 | 43.32 | 54.00 | -10.68 | AVG |
| 3 | 17070.000 | 34.11 | 23.13 | 57.24 | 68.20 | -10.96 | peak |

Note:1.Result (dBuV/m) = Correct Factor (dB/m) + Reading(dBuV).

2.Correction factor (dB/m) = Antenna Factor (dB/m) + Cable loss (dB) – Pre-Amplifier gain (dB).

3.When the peak results are less than average limit, so not need to evaluate the average.



| | | | |
|-------------|-----------------|----------------|-----|
| Standard: | FCC Part 15.407 | Test Distance: | 3 m |
| Test item: | Harmonic | | |
| Frequency: | 5775 MHz | | |
| Mode: | Mode 10 | | |
| Ant.Polar.: | Horizontal | | |

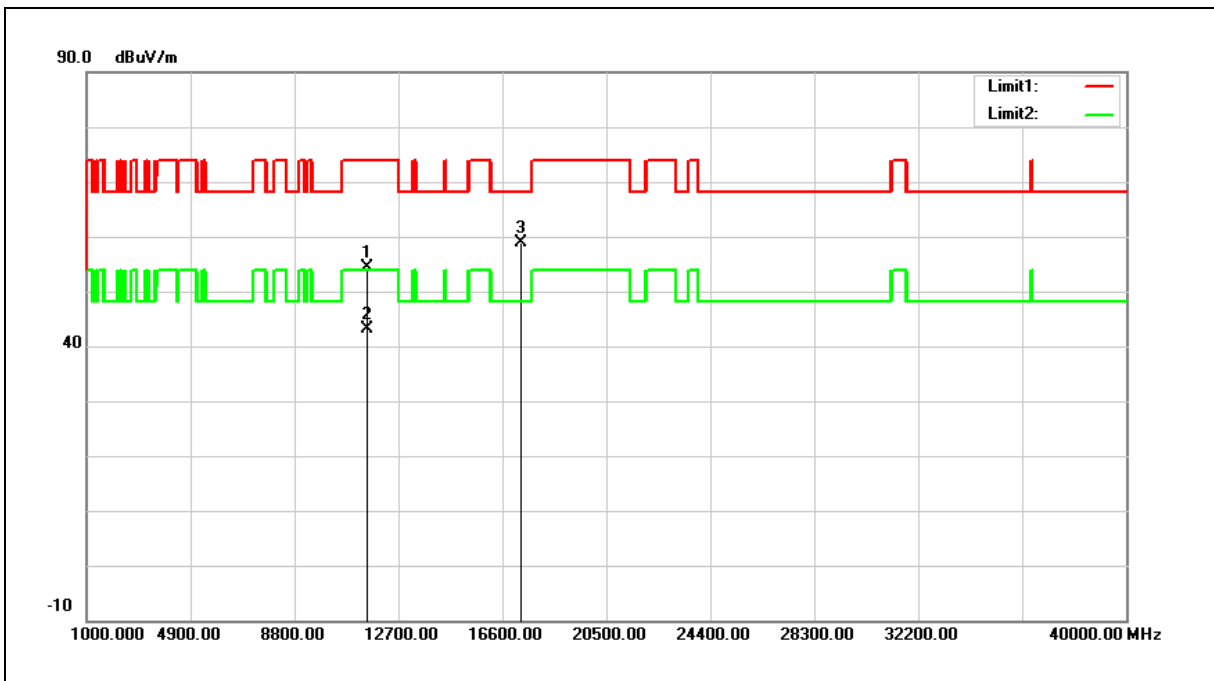

| No. | Frequency (MHz) | Reading (dBuV) | Correct Factor (dB/m) | Result (dBuV/m) | Limit (dBuV/m) | Margin (dB) | Remark |
|-----|-----------------|----------------|-----------------------|-----------------|----------------|-------------|--------|
| 1 | 11550.000 | 36.24 | 18.18 | 54.42 | 74.00 | -19.58 | peak |
| 2 | 11550.000 | 25.01 | 18.18 | 43.19 | 54.00 | -10.81 | AVG |
| 3 | 17325.000 | 34.62 | 24.31 | 58.93 | 68.20 | -9.27 | peak |

Note:1.Result (dBuV/m) = Correct Factor (dB/m) + Reading(dBuV).

2.Correction factor (dB/m) = Antenna Factor (dB/m) + Cable loss (dB) – Pre-Amplifier gain (dB).

3.When the peak results are less than average limit, so not need to evaluate the average.



| | | | |
|-------------|-----------------|----------------|-----|
| Standard: | FCC Part 15.407 | Test Distance: | 3 m |
| Test item: | Harmonic | | |
| Frequency: | 5775 MHz | | |
| Mode: | Mode 10 | | |
| Ant.Polar.: | Vertical | | |

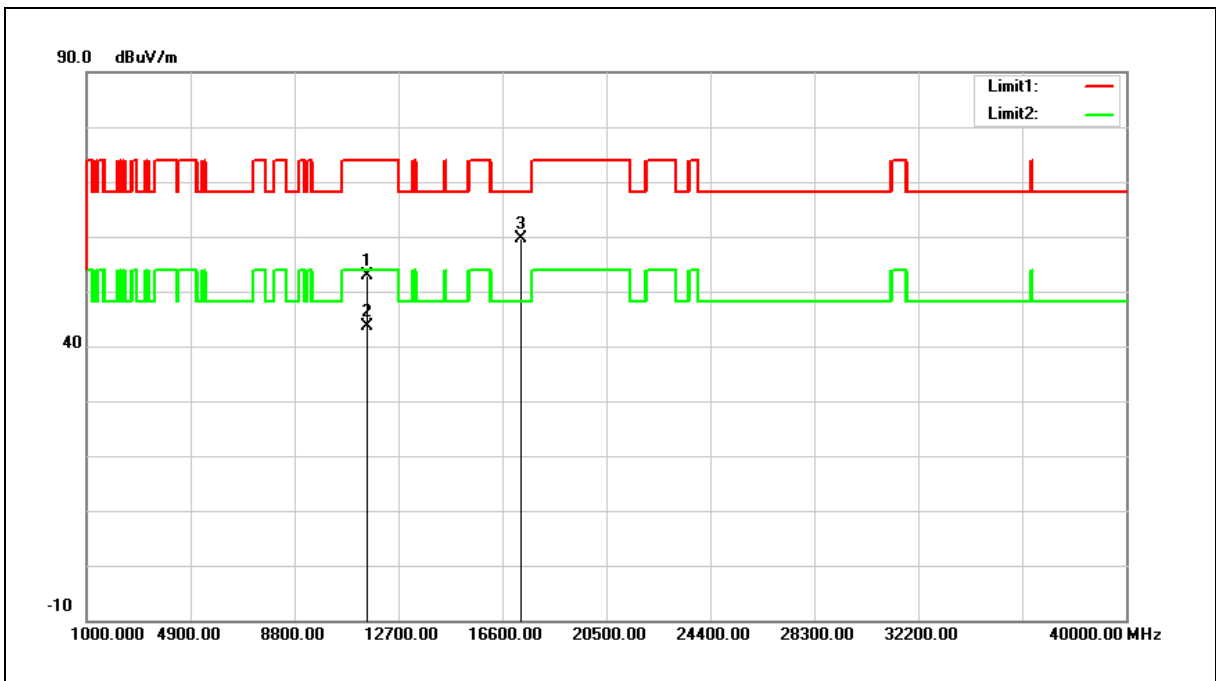

| No. | Frequency (MHz) | Reading (dBuV) | Correct Factor (dB/m) | Result (dBuV/m) | Limit (dBuV/m) | Margin (dB) | Remark |
|-----|-----------------|----------------|-----------------------|-----------------|----------------|-------------|--------|
| 1 | 11550.000 | 34.60 | 18.18 | 52.78 | 74.00 | -21.22 | peak |
| 2 | 11550.000 | 25.44 | 18.18 | 43.62 | 54.00 | -10.38 | AVG |
| 3 | 17325.000 | 35.24 | 24.31 | 59.55 | 68.20 | -8.65 | peak |

Note:1.Result (dBuV/m) = Correct Factor (dB/m) + Reading(dBuV).

2.Correction factor (dB/m) = Antenna Factor (dB/m) + Cable loss (dB) – Pre-Amplifier gain (dB).

3.When the peak results are less than average limit, so not need to evaluate the average.



Band Edge

Peak

| | | | |
|-------------|-----------------|----------------|-----|
| Standard: | FCC Part 15.407 | Test Distance: | 3 m |
| Test item: | Band edge | | |
| Frequency: | 5180 MHz | | |
| Mode: | Mode 2 | | |
| Ant.Polar.: | Horizontal | | |

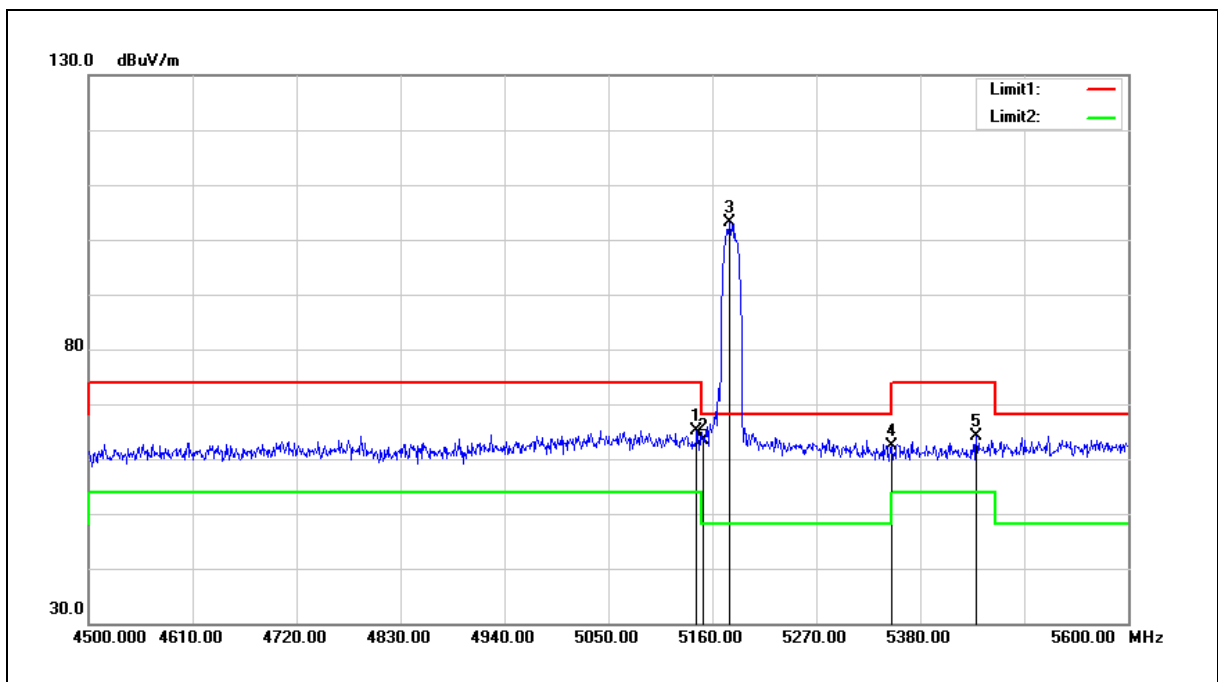

| No. | Frequency (MHz) | Reading (dBuV) | Correct Factor (dB/m) | Result (dBuV/m) | Limit (dBuV/m) | Margin (dB) | Remark |
|-----|-----------------|----------------|-----------------------|-----------------|----------------|-------------|--------|
| 1 | 5143.500 | 60.57 | 4.59 | 65.16 | 74.00 | -8.84 | peak |
| 2 | 5150.000 | 58.76 | 4.60 | 63.36 | 74.00 | -10.64 | peak |
| 3 | 5178.700 | 98.44 | 4.63 | 103.07 | -- | -- | peak |
| 4 | 5350.000 | 57.63 | 4.84 | 62.47 | 74.00 | -11.53 | peak |
| 5 | 5439.400 | 59.18 | 4.94 | 64.12 | 74.00 | -9.88 | peak |

Note:1.Result (dBuV/m) = Correct Factor (dB/m) + Reading(dBuV).

2.Correction factor (dB/m) = Antenna Factor (dB/m) + Cable loss (dB) – Pre-Amplifier gain (dB).

3.When the peak results are less than average limit, so not need to evaluate the average.



| | | | |
|-------------|-----------------|----------------|-----|
| Standard: | FCC Part 15.407 | Test Distance: | 3 m |
| Test item: | Band edge | | |
| Frequency: | 5180 MHz | | |
| Mode: | Mode 2 | | |
| Ant.Polar.: | Vertical | | |

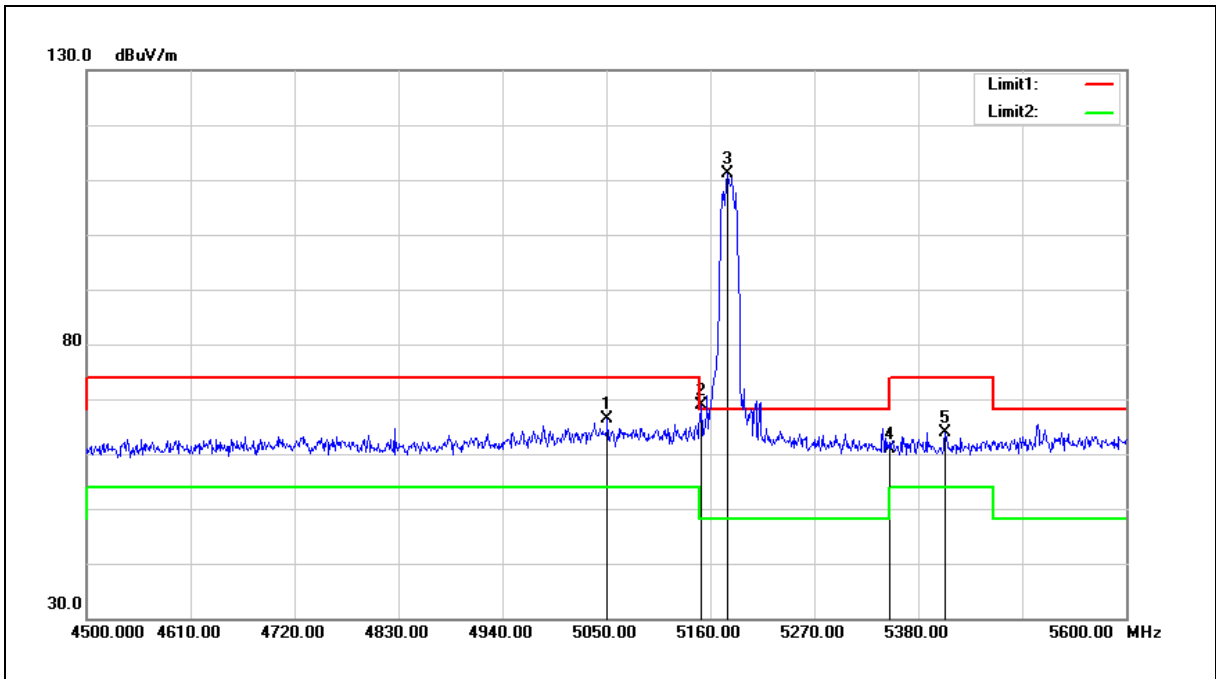

| No. | Frequency (MHz) | Reading (dBuV) | Correct Factor (dB/m) | Result (dBuV/m) | Limit (dBuV/m) | Margin (dB) | Remark |
|-----|-----------------|----------------|-----------------------|-----------------|----------------|-------------|--------|
| 1 | 5051.100 | 61.80 | 4.48 | 66.28 | 74.00 | -7.72 | peak |
| 2 | 5150.000 | 64.34 | 4.60 | 68.94 | 74.00 | -5.06 | peak |
| 3 | 5177.600 | 106.41 | 4.63 | 111.04 | -- | -- | peak |
| 4 | 5350.000 | 55.94 | 4.84 | 60.78 | 74.00 | -13.22 | peak |
| 5 | 5408.600 | 58.97 | 4.91 | 63.88 | 74.00 | -10.12 | peak |

Note:1.Result (dBuV/m) = Correct Factor (dB/m) + Reading(dBuV).

2.Correction factor (dB/m) = Antenna Factor (dB/m) + Cable loss (dB) – Pre-Amplifier gain (dB).

3.When the peak results are less than average limit, so not need to evaluate the average.



| | | | |
|-------------|-----------------|----------------|-----|
| Standard: | FCC Part 15.407 | Test Distance: | 3 m |
| Test item: | Band edge | | |
| Frequency: | 5200 MHz | | |
| Mode: | Mode 2 | | |
| Ant.Polar.: | Horizontal | | |

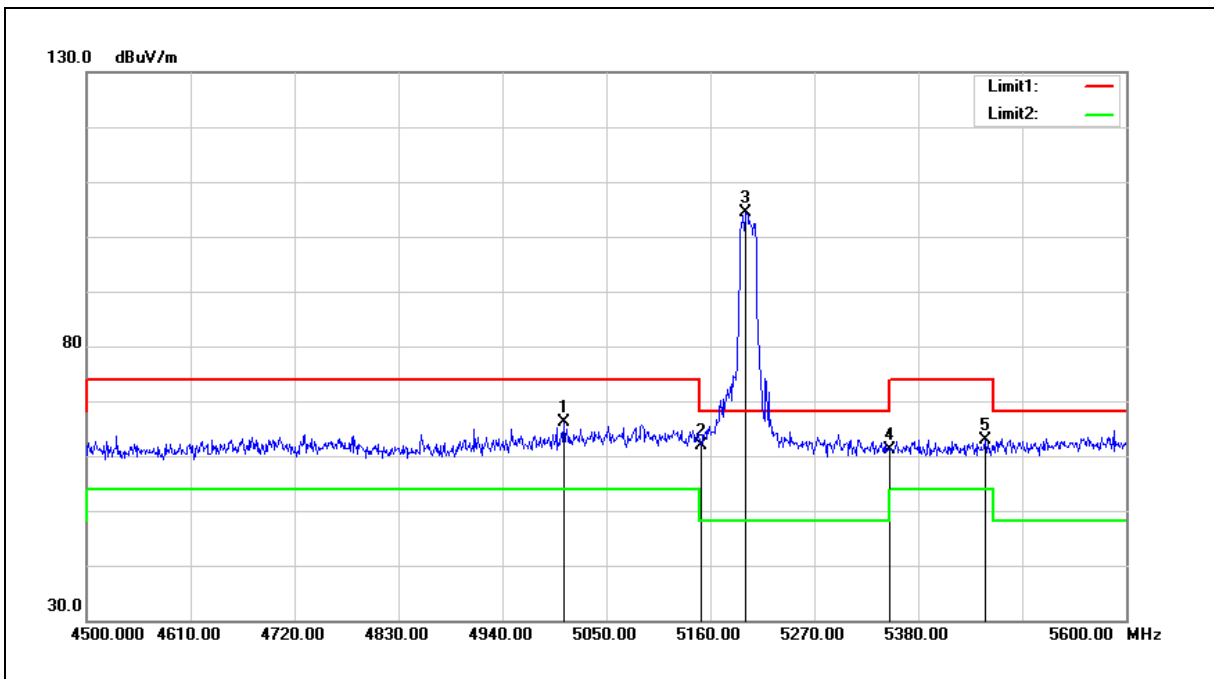

| No. | Frequency (MHz) | Reading (dBuV) | Correct Factor (dB/m) | Result (dBuV/m) | Limit (dBuV/m) | Margin (dB) | Remark |
|-----|-----------------|----------------|-----------------------|-----------------|----------------|-------------|--------|
| 1 | 5004.900 | 61.76 | 4.42 | 66.18 | 74.00 | -7.82 | peak |
| 2 | 5150.000 | 57.37 | 4.60 | 61.97 | 74.00 | -12.03 | peak |
| 3 | 5197.400 | 99.73 | 4.66 | 104.39 | -- | -- | peak |
| 4 | 5350.000 | 56.27 | 4.84 | 61.11 | 74.00 | -12.89 | peak |
| 5 | 5450.400 | 57.98 | 4.95 | 62.93 | 74.00 | -11.07 | peak |

Note:1.Result (dBuV/m) = Correct Factor (dB/m) + Reading(dBuV).

2.Correction factor (dB/m) = Antenna Factor (dB/m) + Cable loss (dB) – Pre-Amplifier gain (dB).

3.When the peak results are less than average limit, so not need to evaluate the average.



| | | | |
|-------------|-----------------|----------------|-----|
| Standard: | FCC Part 15.407 | Test Distance: | 3 m |
| Test item: | Band edge | | |
| Frequency: | 5200 MHz | | |
| Mode: | Mode 2 | | |
| Ant.Polar.: | Vertical | | |

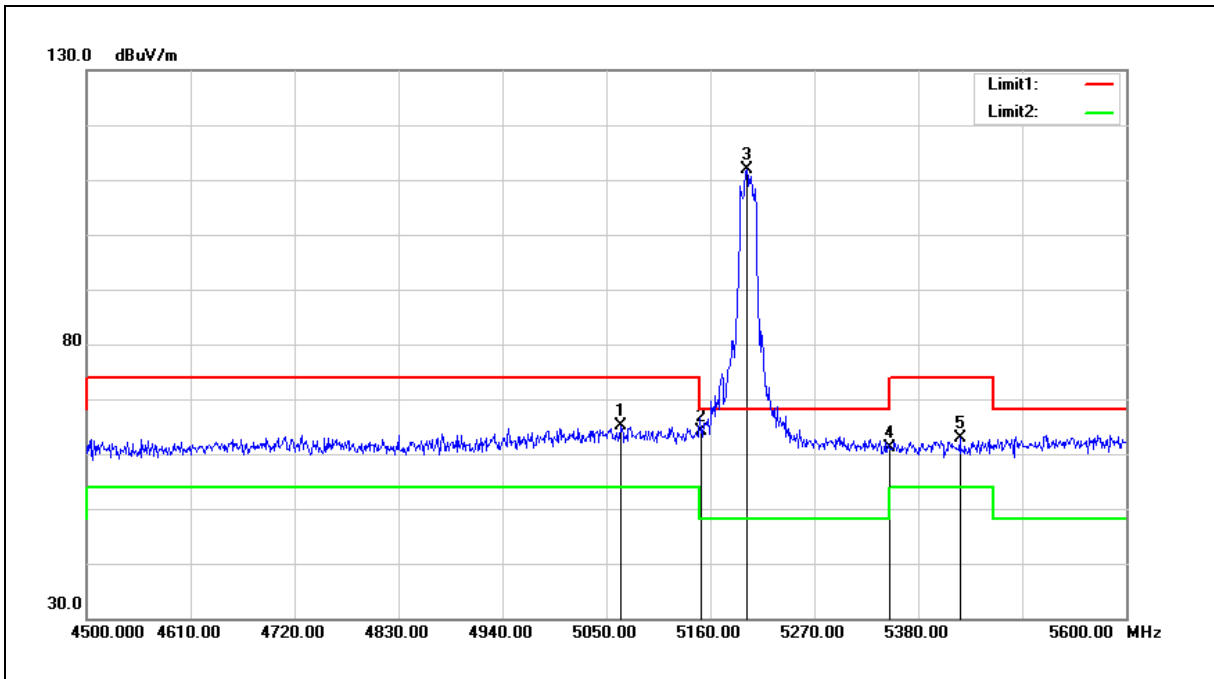

| No. | Frequency (MHz) | Reading (dBuV) | Correct Factor (dB/m) | Result (dBuV/m) | Limit (dBuV/m) | Margin (dB) | Remark |
|-----|-----------------|----------------|-----------------------|-----------------|----------------|-------------|--------|
| 1 | 5065.400 | 60.59 | 4.49 | 65.08 | 74.00 | -8.92 | peak |
| 2 | 5150.000 | 59.52 | 4.60 | 64.12 | 74.00 | -9.88 | peak |
| 3 | 5198.500 | 107.15 | 4.66 | 111.81 | -- | -- | peak |
| 4 | 5350.000 | 56.17 | 4.84 | 61.01 | 74.00 | -12.99 | peak |
| 5 | 5424.000 | 57.95 | 4.92 | 62.87 | 74.00 | -11.13 | peak |

Note:1.Result (dBuV/m) = Correct Factor (dB/m) + Reading(dBuV).

2.Correction factor (dB/m) = Antenna Factor (dB/m) + Cable loss (dB) – Pre-Amplifier gain (dB).

3.When the peak results are less than average limit, so not need to evaluate the average.



| | | | |
|-------------|-----------------|----------------|-----|
| Standard: | FCC Part 15.407 | Test Distance: | 3 m |
| Test item: | Band edge | | |
| Frequency: | 5240 MHz | | |
| Mode: | Mode 2 | | |
| Ant.Polar.: | Horizontal | | |

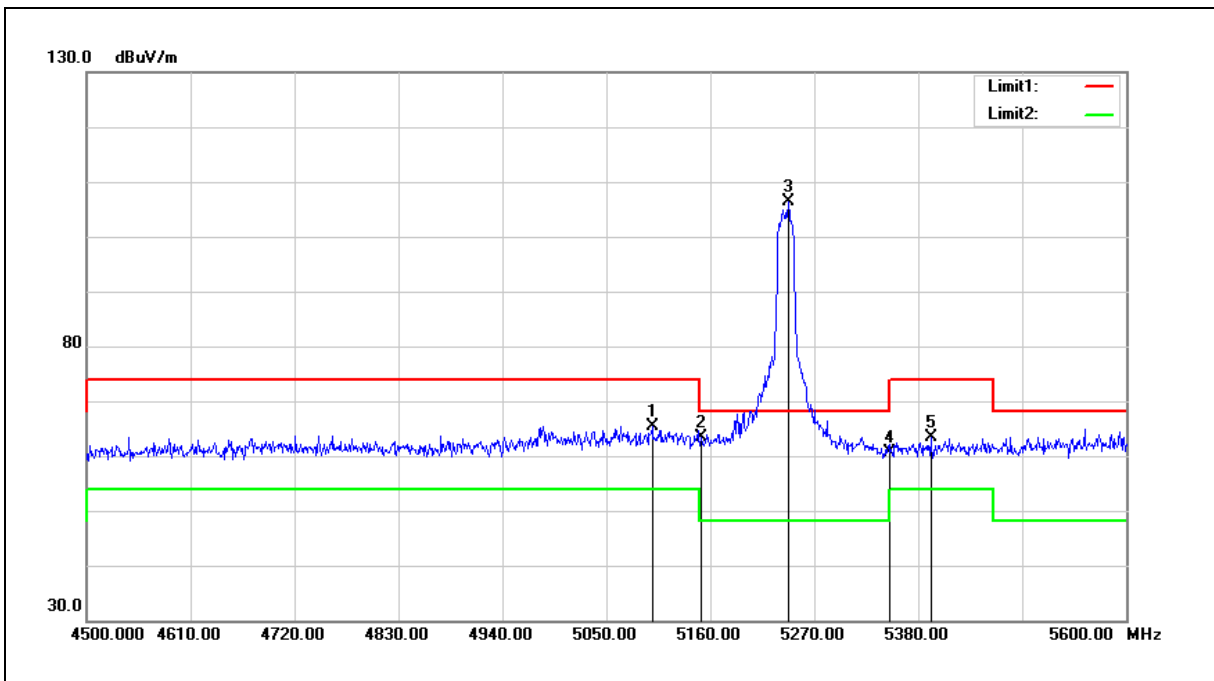

| No. | Frequency (MHz) | Reading (dBuV) | Correct Factor (dB/m) | Result (dBuV/m) | Limit (dBuV/m) | Margin (dB) | Remark |
|-----|-----------------|----------------|-----------------------|-----------------|----------------|-------------|--------|
| 1 | 5098.400 | 60.96 | 4.53 | 65.49 | 74.00 | -8.51 | peak |
| 2 | 5150.000 | 58.79 | 4.60 | 63.39 | 74.00 | -10.61 | peak |
| 3 | 5242.500 | 101.75 | 4.70 | 106.45 | -- | -- | peak |
| 4 | 5350.000 | 55.70 | 4.84 | 60.54 | 74.00 | -13.46 | peak |
| 5 | 5393.200 | 58.55 | 4.88 | 63.43 | 74.00 | -10.57 | peak |

Note:1.Result (dBuV/m) = Correct Factor (dB/m) + Reading(dBuV).

2.Correction factor (dB/m) = Antenna Factor (dB/m) + Cable loss (dB) – Pre-Amplifier gain (dB).

3.When the peak results are less than average limit, so not need to evaluate the average.



| | | | |
|-------------|-----------------|----------------|-----|
| Standard: | FCC Part 15.407 | Test Distance: | 3 m |
| Test item: | Band edge | | |
| Frequency: | 5240 MHz | | |
| Mode: | Mode 2 | | |
| Ant.Polar.: | Vertical | | |

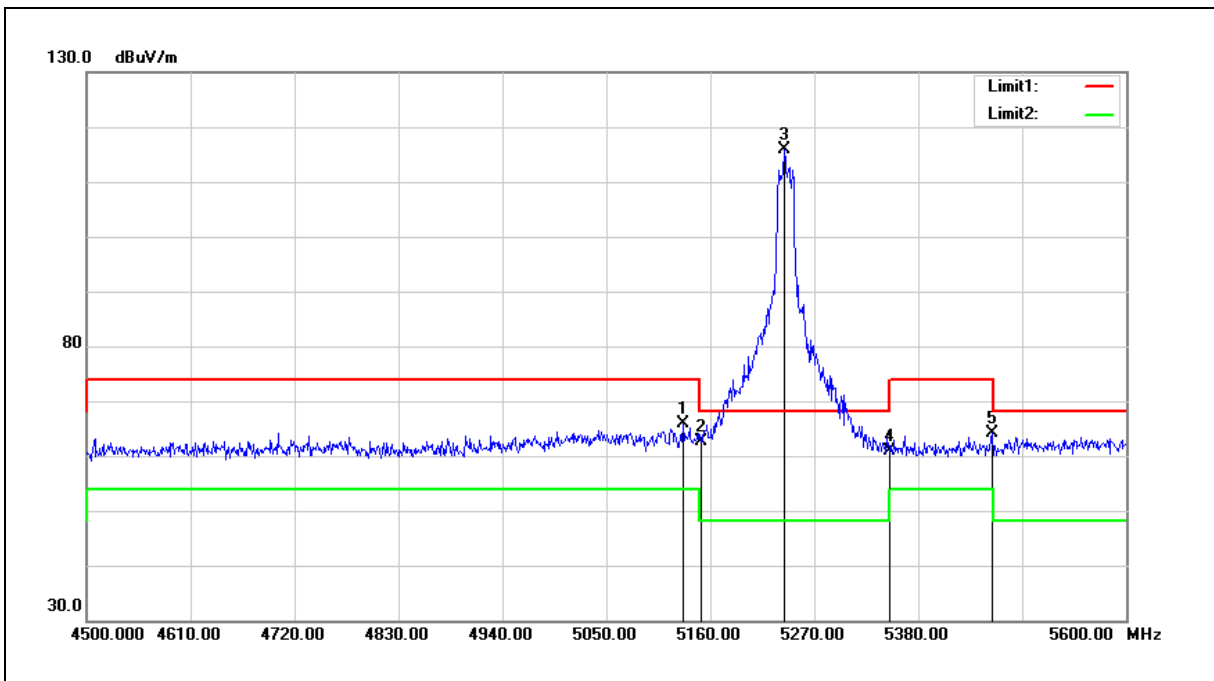

| No. | Frequency (MHz) | Reading (dBuV) | Correct Factor (dB/m) | Result (dBuV/m) | Limit (dBuV/m) | Margin (dB) | Remark |
|-----|-----------------|----------------|-----------------------|-----------------|----------------|-------------|--------|
| 1 | 5131.400 | 61.38 | 4.58 | 65.96 | 74.00 | -8.04 | peak |
| 2 | 5150.000 | 57.93 | 4.60 | 62.53 | 74.00 | -11.47 | peak |
| 3 | 5238.100 | 111.24 | 4.70 | 115.94 | -- | -- | peak |
| 4 | 5350.000 | 56.08 | 4.84 | 60.92 | 74.00 | -13.08 | peak |
| 5 | 5458.100 | 59.08 | 4.97 | 64.05 | 74.00 | -9.95 | peak |

Note:1.Result (dBuV/m) = Correct Factor (dB/m) + Reading(dBuV).

2.Correction factor (dB/m) = Antenna Factor (dB/m) + Cable loss (dB) – Pre-Amplifier gain (dB).

3.When the peak results are less than average limit, so not need to evaluate the average.



| | | | |
|-------------|-----------------|----------------|-----|
| Standard: | FCC Part 15.407 | Test Distance: | 3 m |
| Test item: | Band edge | | |
| Frequency: | 5260 MHz | | |
| Mode: | Mode 2 | | |
| Ant.Polar.: | Horizontal | | |

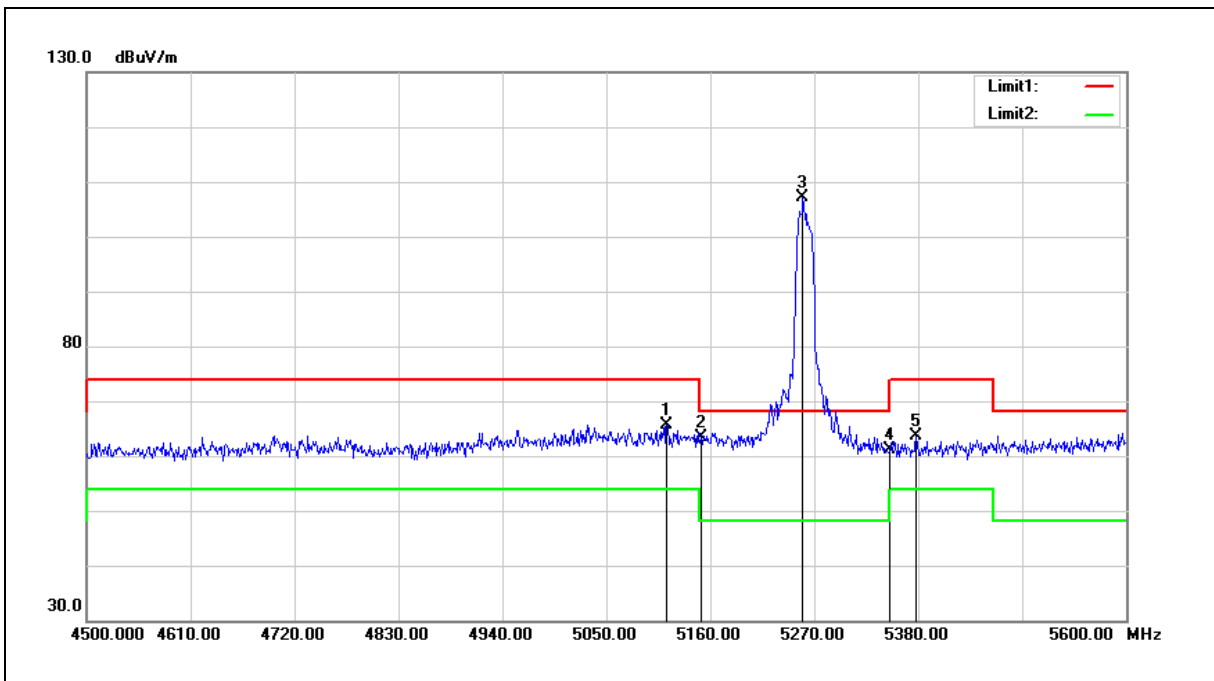

| No. | Frequency (MHz) | Reading (dBuV) | Correct Factor (dB/m) | Result (dBuV/m) | Limit (dBuV/m) | Margin (dB) | Remark |
|-----|-----------------|----------------|-----------------------|-----------------|----------------|-------------|--------|
| 1 | 5113.800 | 61.14 | 4.56 | 65.70 | 74.00 | -8.30 | peak |
| 2 | 5150.000 | 58.80 | 4.60 | 63.40 | 74.00 | -10.60 | peak |
| 3 | 5257.900 | 102.46 | 4.73 | 107.19 | -- | -- | peak |
| 4 | 5350.000 | 56.30 | 4.84 | 61.14 | 74.00 | -12.86 | peak |
| 5 | 5377.800 | 58.69 | 4.87 | 63.56 | 74.00 | -10.44 | peak |

Note:1.Result (dBuV/m) = Correct Factor (dB/m) + Reading(dBuV).

2.Correction factor (dB/m) = Antenna Factor (dB/m) + Cable loss (dB) – Pre-Amplifier gain (dB).

3.When the peak results are less than average limit, so not need to evaluate the average.



| | | | |
|-------------|-----------------|----------------|-----|
| Standard: | FCC Part 15.407 | Test Distance: | 3 m |
| Test item: | Band edge | | |
| Frequency: | 5260 MHz | | |
| Mode: | Mode 2 | | |
| Ant.Polar.: | Vertical | | |

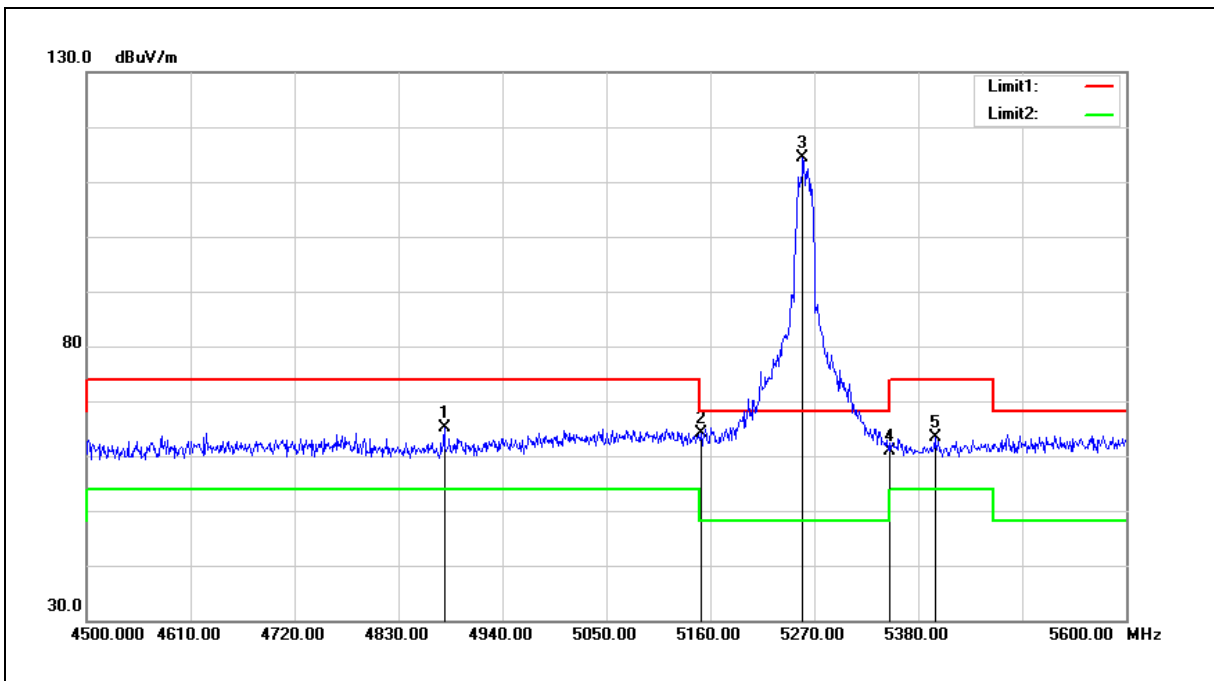

| No. | Frequency (MHz) | Reading (dBuV) | Correct Factor (dB/m) | Result (dBuV/m) | Limit (dBuV/m) | Margin (dB) | Remark |
|-----|-----------------|----------------|-----------------------|-----------------|----------------|-------------|--------|
| 1 | 4878.400 | 61.09 | 4.02 | 65.11 | 74.00 | -8.89 | peak |
| 2 | 5150.000 | 59.46 | 4.60 | 64.06 | 74.00 | -9.94 | peak |
| 3 | 5257.900 | 109.57 | 4.73 | 114.30 | -- | -- | peak |
| 4 | 5350.000 | 56.14 | 4.84 | 60.98 | 74.00 | -13.02 | peak |
| 5 | 5397.600 | 58.40 | 4.90 | 63.30 | 74.00 | -10.70 | peak |

Note:1.Result (dBuV/m) = Correct Factor (dB/m) + Reading(dBuV).

2.Correction factor (dB/m) = Antenna Factor (dB/m) + Cable loss (dB) – Pre-Amplifier gain (dB).

3.When the peak results are less than average limit, so not need to evaluate the average.



| | | | |
|-------------|-----------------|----------------|-----|
| Standard: | FCC Part 15.407 | Test Distance: | 3 m |
| Test item: | Band edge | | |
| Frequency: | 5280 MHz | | |
| Mode: | Mode 2 | | |
| Ant.Polar.: | Horizontal | | |

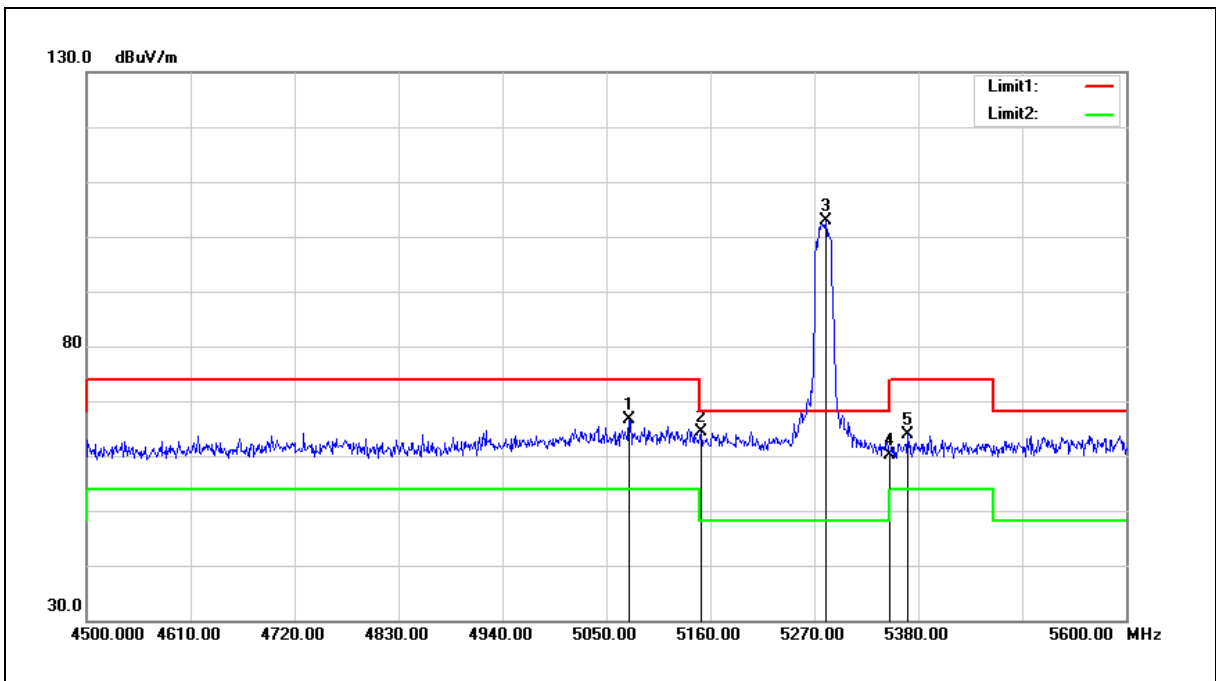

| No. | Frequency (MHz) | Reading (dBuV) | Correct Factor (dB/m) | Result (dBuV/m) | Limit (dBuV/m) | Margin (dB) | Remark |
|-----|-----------------|----------------|-----------------------|-----------------|----------------|-------------|--------|
| 1 | 5074.200 | 62.20 | 4.51 | 66.71 | 74.00 | -7.29 | peak |
| 2 | 5150.000 | 59.70 | 4.60 | 64.30 | 74.00 | -9.70 | peak |
| 3 | 5282.100 | 98.18 | 4.76 | 102.94 | -- | -- | peak |
| 4 | 5350.000 | 55.21 | 4.84 | 60.05 | 74.00 | -13.95 | peak |
| 5 | 5369.000 | 58.93 | 4.87 | 63.80 | 74.00 | -10.20 | peak |

Note:1.Result (dBuV/m) = Correct Factor (dB/m) + Reading(dBuV).

2.Correction factor (dB/m) = Antenna Factor (dB/m) + Cable loss (dB) – Pre-Amplifier gain (dB).

3.When the peak results are less than average limit, so not need to evaluate the average.



| | | | |
|-------------|-----------------|----------------|-----|
| Standard: | FCC Part 15.407 | Test Distance: | 3 m |
| Test item: | Band edge | | |
| Frequency: | 5280 MHz | | |
| Mode: | Mode 2 | | |
| Ant.Polar.: | Vertical | | |

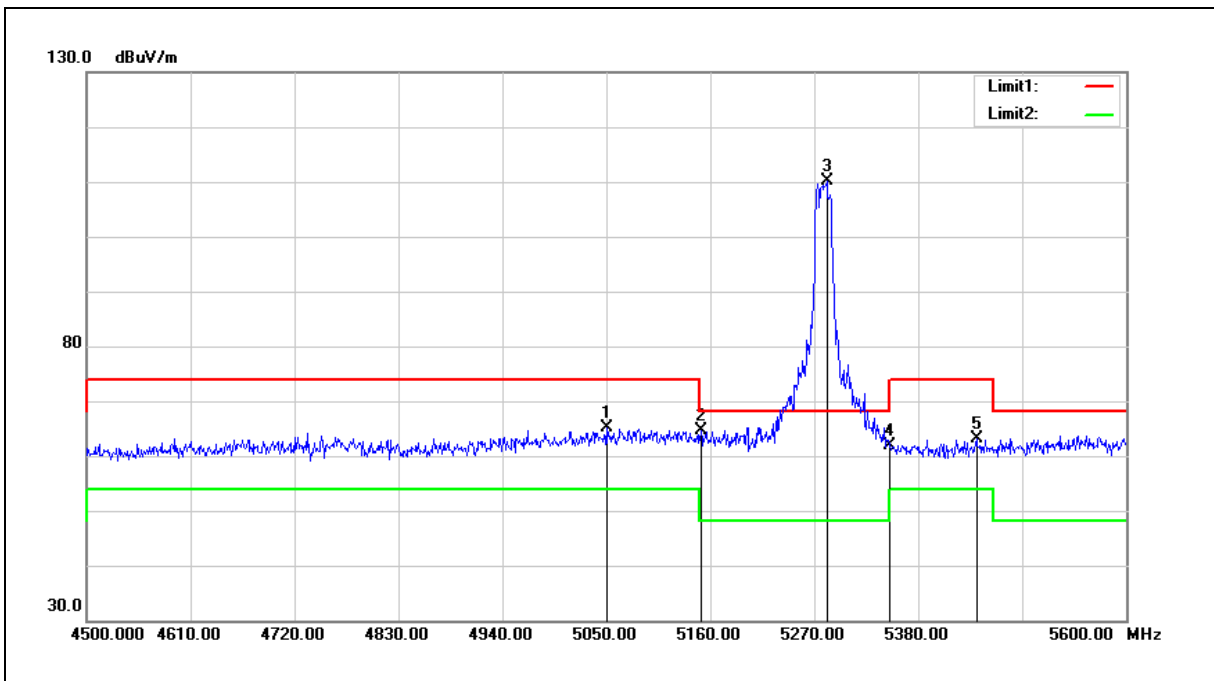

| No. | Frequency (MHz) | Reading (dBuV) | Correct Factor (dB/m) | Result (dBuV/m) | Limit (dBuV/m) | Margin (dB) | Remark |
|-----|-----------------|----------------|-----------------------|-----------------|----------------|-------------|--------|
| 1 | 5050.000 | 60.70 | 4.48 | 65.18 | 74.00 | -8.82 | peak |
| 2 | 5150.000 | 60.12 | 4.60 | 64.72 | 74.00 | -9.28 | peak |
| 3 | 5283.200 | 105.41 | 4.76 | 110.17 | -- | -- | peak |
| 4 | 5350.000 | 56.97 | 4.84 | 61.81 | 74.00 | -12.19 | peak |
| 5 | 5441.600 | 58.07 | 4.94 | 63.01 | 74.00 | -10.99 | peak |

Note:1.Result (dBuV/m) = Correct Factor (dB/m) + Reading(dBuV).

2.Correction factor (dB/m) = Antenna Factor (dB/m) + Cable loss (dB) – Pre-Amplifier gain (dB).

3.When the peak results are less than average limit, so not need to evaluate the average.



| | | | |
|-------------|-----------------|----------------|-----|
| Standard: | FCC Part 15.407 | Test Distance: | 3 m |
| Test item: | Band edge | | |
| Frequency: | 5320 MHz | | |
| Mode: | Mode 2 | | |
| Ant.Polar.: | Horizontal | | |

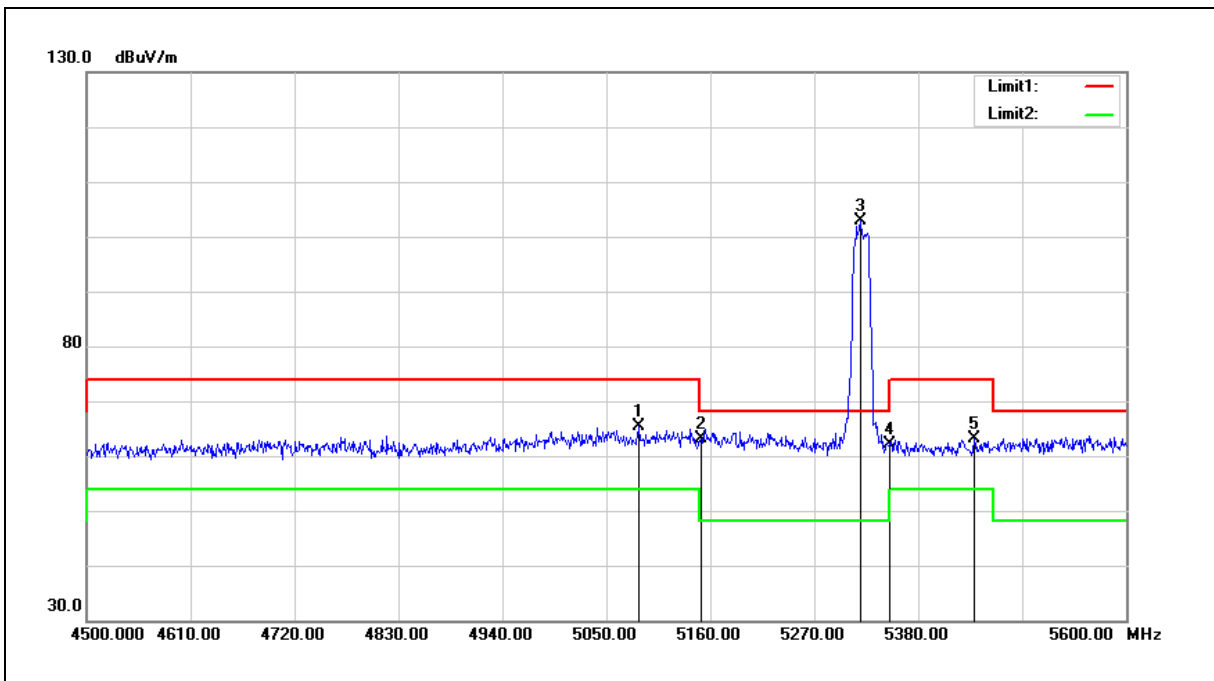

| No. | Frequency (MHz) | Reading (dBuV) | Correct Factor (dB/m) | Result (dBuV/m) | Limit (dBuV/m) | Margin (dB) | Remark |
|-----|-----------------|----------------|-----------------------|-----------------|----------------|-------------|--------|
| 1 | 5084.100 | 60.85 | 4.52 | 65.37 | 74.00 | -8.63 | peak |
| 2 | 5150.000 | 58.53 | 4.60 | 63.13 | 74.00 | -10.87 | peak |
| 3 | 5318.400 | 98.13 | 4.80 | 102.93 | -- | -- | peak |
| 4 | 5350.000 | 57.36 | 4.84 | 62.20 | 74.00 | -11.80 | peak |
| 5 | 5439.400 | 58.14 | 4.94 | 63.08 | 74.00 | -10.92 | peak |

Note:1.Result (dBuV/m) = Correct Factor (dB/m) + Reading(dBuV).

2.Correction factor (dB/m) = Antenna Factor (dB/m) + Cable loss (dB) – Pre-Amplifier gain (dB).

3.When the peak results are less than average limit, so not need to evaluate the average.



| | | | |
|-------------|-----------------|----------------|-----|
| Standard: | FCC Part 15.407 | Test Distance: | 3 m |
| Test item: | Band edge | | |
| Frequency: | 5320 MHz | | |
| Mode: | Mode 2 | | |
| Ant.Polar.: | Vertical | | |

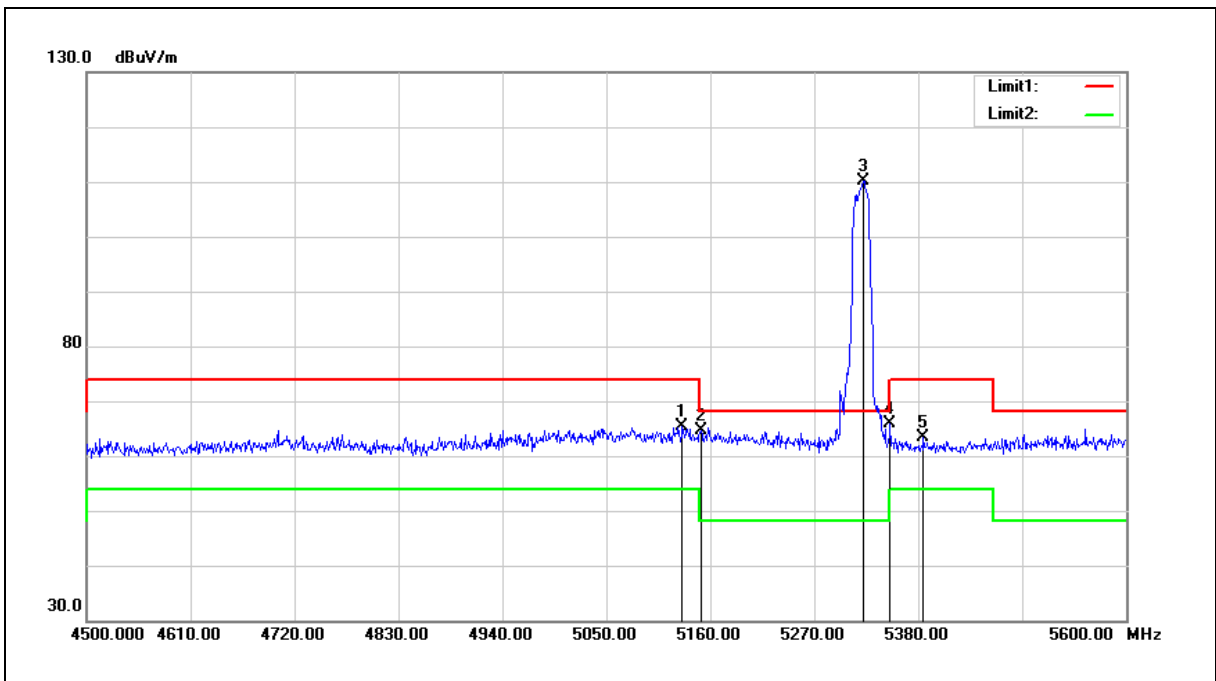

| No. | Frequency (MHz) | Reading (dBuV) | Correct Factor (dB/m) | Result (dBuV/m) | Limit (dBuV/m) | Margin (dB) | Remark |
|-----|-----------------|----------------|-----------------------|-----------------|----------------|-------------|--------|
| 1 | 5130.300 | 60.79 | 4.57 | 65.36 | 74.00 | -8.64 | peak |
| 2 | 5150.000 | 60.02 | 4.60 | 64.62 | 74.00 | -9.38 | peak |
| 3 | 5321.700 | 105.39 | 4.81 | 110.20 | -- | -- | peak |
| 4 | 5350.000 | 60.97 | 4.84 | 65.81 | 74.00 | -8.19 | peak |
| 5 | 5385.500 | 58.39 | 4.88 | 63.27 | 74.00 | -10.73 | peak |

Note:1.Result (dBuV/m) = Correct Factor (dB/m) + Reading(dBuV).

2.Correction factor (dB/m) = Antenna Factor (dB/m) + Cable loss (dB) – Pre-Amplifier gain (dB).

3.When the peak results are less than average limit, so not need to evaluate the average.



| | | | |
|-------------|-----------------|----------------|-----|
| Standard: | FCC Part 15.407 | Test Distance: | 3 m |
| Test item: | Band edge | | |
| Frequency: | 5500 MHz | | |
| Mode: | Mode 2 | | |
| Ant.Polar.: | Horizontal | | |

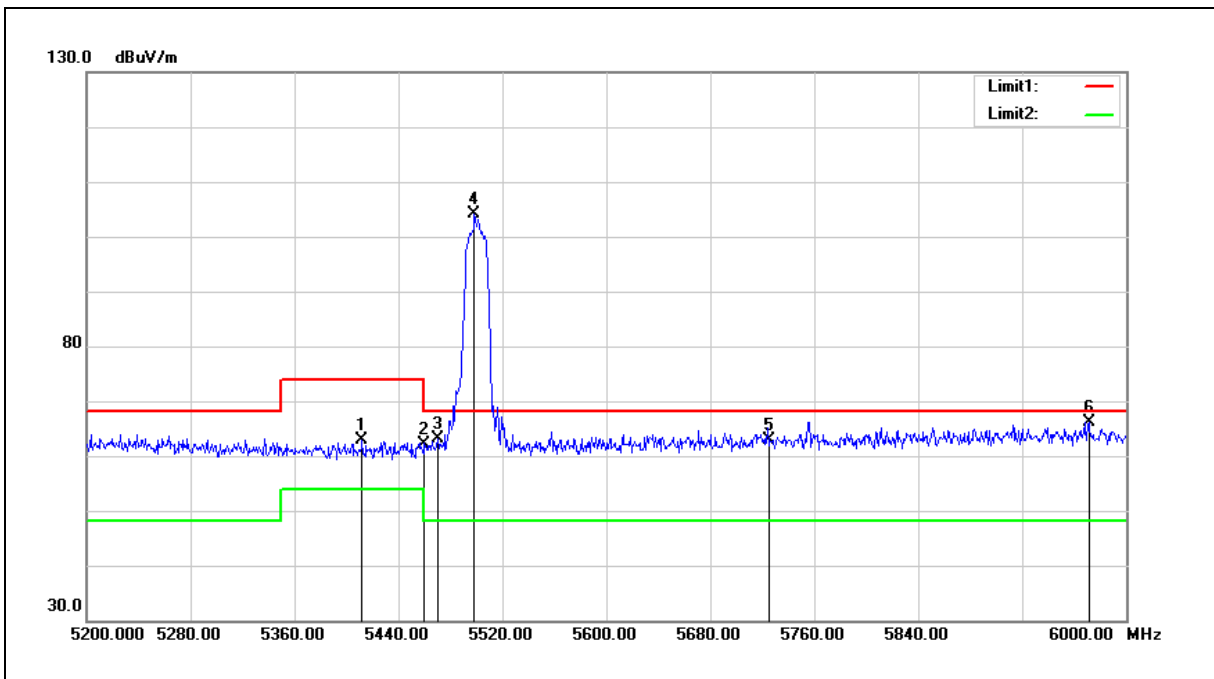

| No. | Frequency (MHz) | Reading (dBuV) | Correct Factor (dB/m) | Result (dBuV/m) | Limit (dBuV/m) | Margin (dB) | Remark |
|-----|-----------------|----------------|-----------------------|-----------------|----------------|-------------|--------|
| 1 | 5412.000 | 57.97 | 4.91 | 62.88 | 74.00 | -11.12 | peak |
| 2 | 5460.000 | 57.28 | 4.97 | 62.25 | 74.00 | -11.75 | peak |
| 3 | 5470.000 | 58.04 | 4.98 | 63.02 | 68.20 | -5.18 | peak |
| 4 | 5498.400 | 99.23 | 5.01 | 104.24 | -- | -- | peak |
| 5 | 5725.000 | 57.31 | 5.47 | 62.78 | 68.20 | -5.42 | peak |
| 6 | 5971.200 | 60.18 | 5.97 | 66.15 | 68.20 | -2.05 | peak |

Note:1.Result (dBuV/m) = Correct Factor (dB/m) + Reading(dBuV).

2.Correction factor (dB/m) = Antenna Factor (dB/m) + Cable loss (dB) – Pre-Amplifier gain (dB).

3.When the peak results are less than average limit, so not need to evaluate the average.



| | | | |
|-------------|-----------------|----------------|-----|
| Standard: | FCC Part 15.407 | Test Distance: | 3 m |
| Test item: | Band edge | | |
| Frequency: | 5500 MHz | | |
| Mode: | Mode 2 | | |
| Ant.Polar.: | Vertical | | |

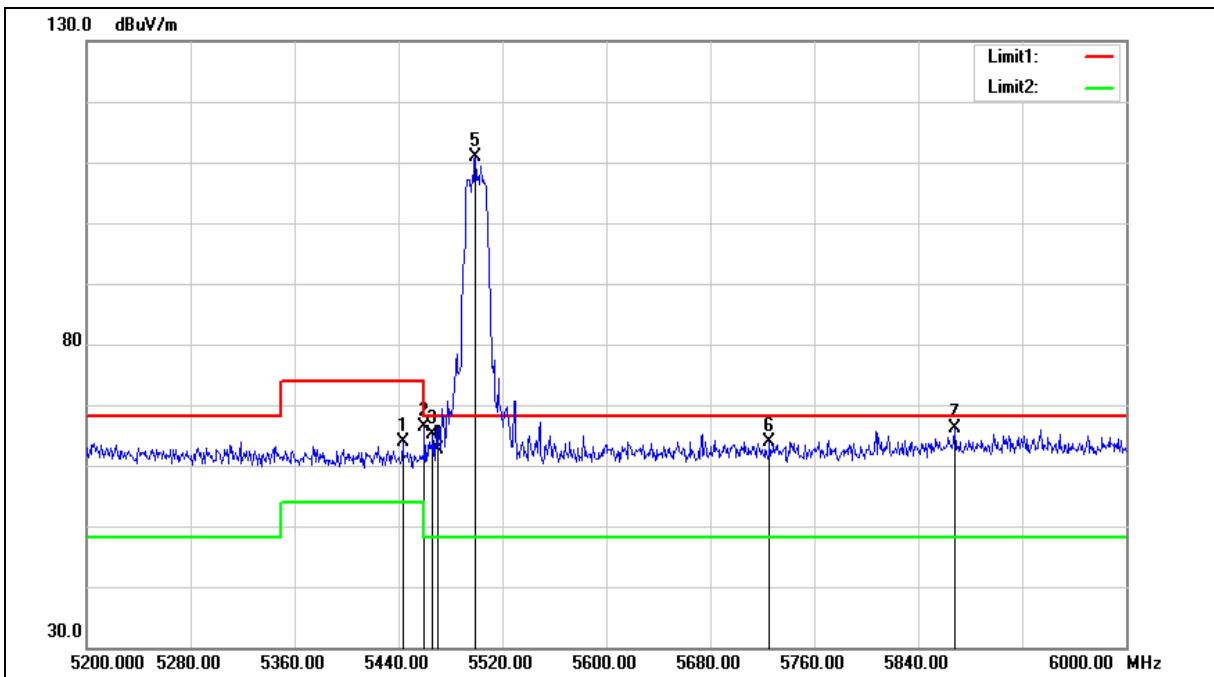



| | | | |
|-------------|-----------------|----------------|-----|
| Standard: | FCC Part 15.407 | Test Distance: | 3 m |
| Test item: | Band edge | | |
| Frequency: | 5500 MHz | | |
| Mode: | Mode 2 | | |
| Ant.Polar.: | Vertical | | |

| No. | Frequency (MHz) | Reading (dBuV) | Correct Factor (dB/m) | Result (dBuV/m) | Limit (dBuV/m) | Margin (dB) | Remark |
|-----|-----------------|----------------|-----------------------|-----------------|----------------|-------------|--------|
| 1 | 5443.200 | 58.98 | 4.94 | 63.92 | 74.00 | -10.08 | peak |
| 2 | 5460.000 | 61.29 | 4.97 | 66.26 | 74.00 | -7.74 | peak |
| 3 | 5466.400 | 60.19 | 4.97 | 65.16 | 68.20 | -3.04 | peak |
| 4 | 5470.000 | 57.70 | 4.98 | 62.68 | 68.20 | -5.52 | peak |
| 5 | 5499.200 | 105.96 | 5.01 | 110.97 | -- | -- | peak |
| 6 | 5725.000 | 58.40 | 5.47 | 63.87 | 68.20 | -4.33 | peak |
| 7 | 5868.000 | 60.31 | 5.75 | 66.06 | 68.20 | -2.14 | peak |

Note:1.Result (dBuV/m) = Correct Factor (dB/m) + Reading(dBuV).

2.Correction factor (dB/m) = Antenna Factor (dB/m) + Cable loss (dB) – Pre-Amplifier gain (dB).

3.When the peak results are less than average limit, so not need to evaluate the average.



| | | | |
|-------------|-----------------|----------------|-----|
| Standard: | FCC Part 15.407 | Test Distance: | 3 m |
| Test item: | Band edge | | |
| Frequency: | 5560 MHz | | |
| Mode: | Mode 2 | | |
| Ant.Polar.: | Horizontal | | |

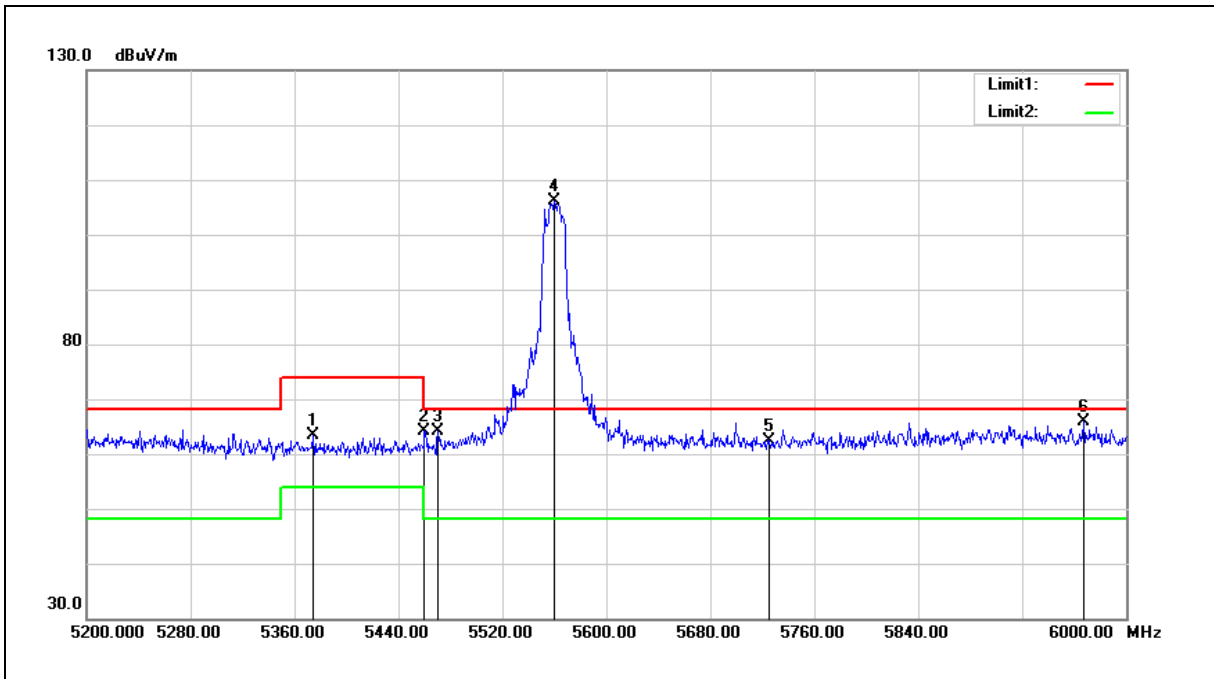

| No. | Frequency (MHz) | Reading (dBuV) | Correct Factor (dB/m) | Result (dBuV/m) | Limit (dBuV/m) | Margin (dB) | Remark |
|-----|-----------------|----------------|-----------------------|-----------------|----------------|-------------|--------|
| 1 | 5374.400 | 58.52 | 4.87 | 63.39 | 74.00 | -10.61 | peak |
| 2 | 5460.000 | 59.05 | 4.97 | 64.02 | 74.00 | -9.98 | peak |
| 3 | 5470.000 | 59.24 | 4.98 | 64.22 | 68.20 | -3.98 | peak |
| 4 | 5560.000 | 100.96 | 5.14 | 106.10 | -- | -- | peak |
| 5 | 5725.000 | 56.83 | 5.47 | 62.30 | 68.20 | -5.90 | peak |
| 6 | 5967.200 | 59.86 | 5.96 | 65.82 | 68.20 | -2.38 | peak |

Note:1.Result (dBuV/m) = Correct Factor (dB/m) + Reading(dBuV).

2.Correction factor (dB/m) = Antenna Factor (dB/m) + Cable loss (dB) – Pre-Amplifier gain (dB).

3.When the peak results are less than average limit, so not need to evaluate the average.



| | | | |
|-------------|-----------------|----------------|-----|
| Standard: | FCC Part 15.407 | Test Distance: | 3 m |
| Test item: | Band edge | | |
| Frequency: | 5560 MHz | | |
| Mode: | Mode 2 | | |
| Ant.Polar.: | Vertical | | |

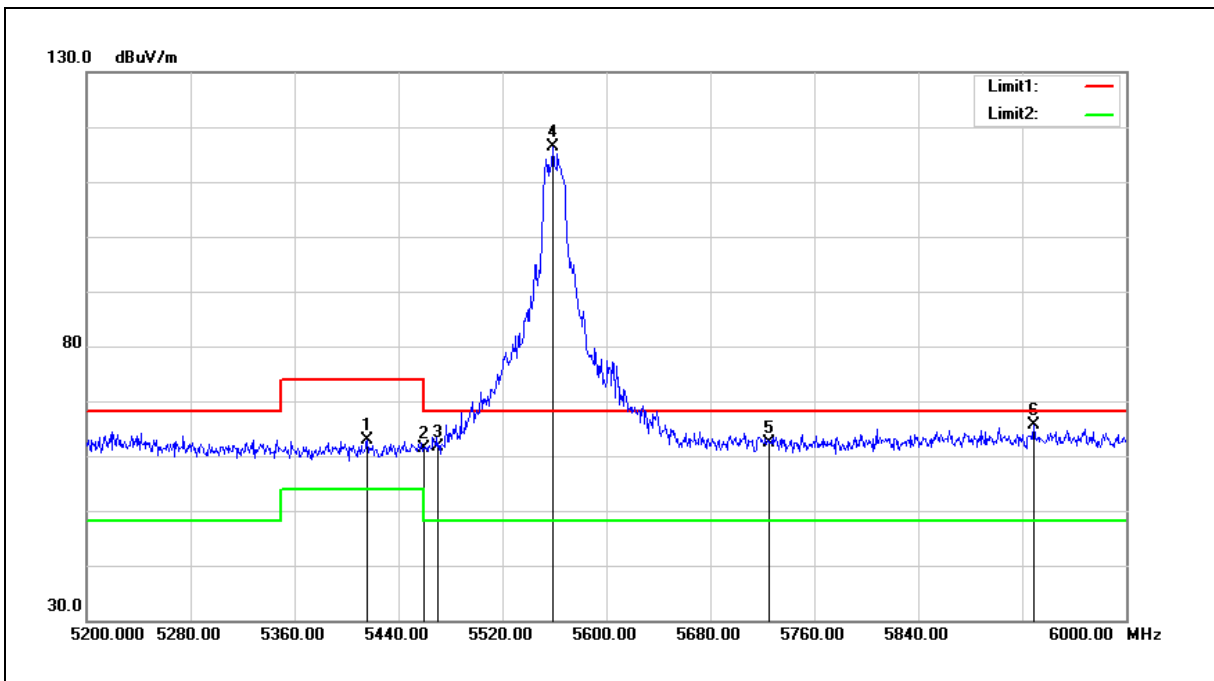

| No. | Frequency (MHz) | Reading (dBuV) | Correct Factor (dB/m) | Result (dBuV/m) | Limit (dBuV/m) | Margin (dB) | Remark |
|-----|-----------------|----------------|-----------------------|-----------------|----------------|-------------|--------|
| 1 | 5416.000 | 57.96 | 4.91 | 62.87 | 74.00 | -11.13 | peak |
| 2 | 5460.000 | 56.37 | 4.97 | 61.34 | 74.00 | -12.66 | peak |
| 3 | 5470.000 | 56.62 | 4.98 | 61.60 | 68.20 | -6.60 | peak |
| 4 | 5559.200 | 111.25 | 5.13 | 116.38 | -- | -- | peak |
| 5 | 5725.000 | 56.84 | 5.47 | 62.31 | 68.20 | -5.89 | peak |
| 6 | 5928.800 | 59.66 | 5.88 | 65.54 | 68.20 | -2.66 | peak |

Note:1.Result (dBuV/m) = Correct Factor (dB/m) + Reading(dBuV).

2.Correction factor (dB/m) = Antenna Factor (dB/m) + Cable loss (dB) – Pre-Amplifier gain (dB).

3.When the peak results are less than average limit, so not need to evaluate the average.



| | | | |
|-------------|-----------------|----------------|-----|
| Standard: | FCC Part 15.407 | Test Distance: | 3 m |
| Test item: | Band edge | | |
| Frequency: | 5700 MHz | | |
| Mode: | Mode 2 | | |
| Ant.Polar.: | Horizontal | | |

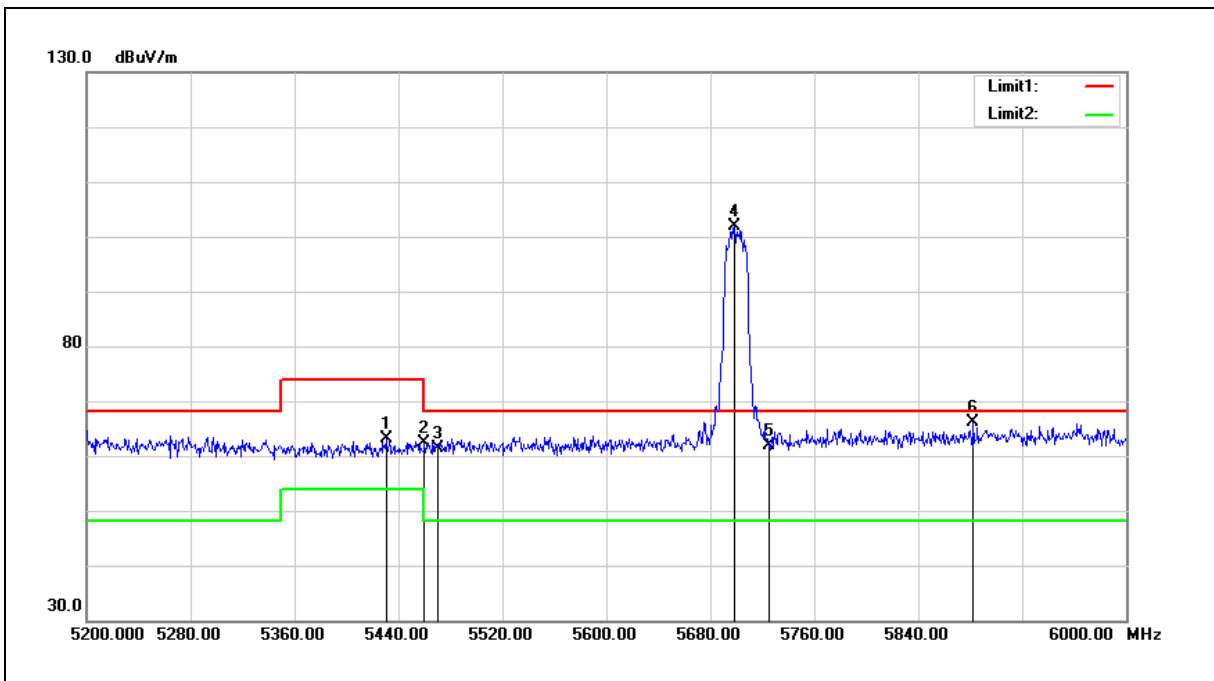

| No. | Frequency (MHz) | Reading (dBuV) | Correct Factor (dB/m) | Result (dBuV/m) | Limit (dBuV/m) | Margin (dB) | Remark |
|-----|-----------------|----------------|-----------------------|-----------------|----------------|-------------|--------|
| 1 | 5430.400 | 58.16 | 4.93 | 63.09 | 74.00 | -10.91 | peak |
| 2 | 5460.000 | 57.34 | 4.97 | 62.31 | 74.00 | -11.69 | peak |
| 3 | 5470.000 | 56.34 | 4.98 | 61.32 | 68.20 | -6.88 | peak |
| 4 | 5698.400 | 96.41 | 5.41 | 101.82 | -- | -- | peak |
| 5 | 5725.000 | 56.50 | 5.47 | 61.97 | 68.20 | -6.23 | peak |
| 6 | 5882.400 | 60.28 | 5.78 | 66.06 | 68.20 | -2.14 | peak |

Note:1.Result (dBuV/m) = Correct Factor (dB/m) + Reading(dBuV).

2.Correction factor (dB/m) = Antenna Factor (dB/m) + Cable loss (dB) – Pre-Amplifier gain (dB).

3.When the peak results are less than average limit, so not need to evaluate the average.



| | | | |
|-------------|-----------------|----------------|-----|
| Standard: | FCC Part 15.407 | Test Distance: | 3 m |
| Test item: | Band edge | | |
| Frequency: | 5700 MHz | | |
| Mode: | Mode 2 | | |
| Ant.Polar.: | Vertical | | |

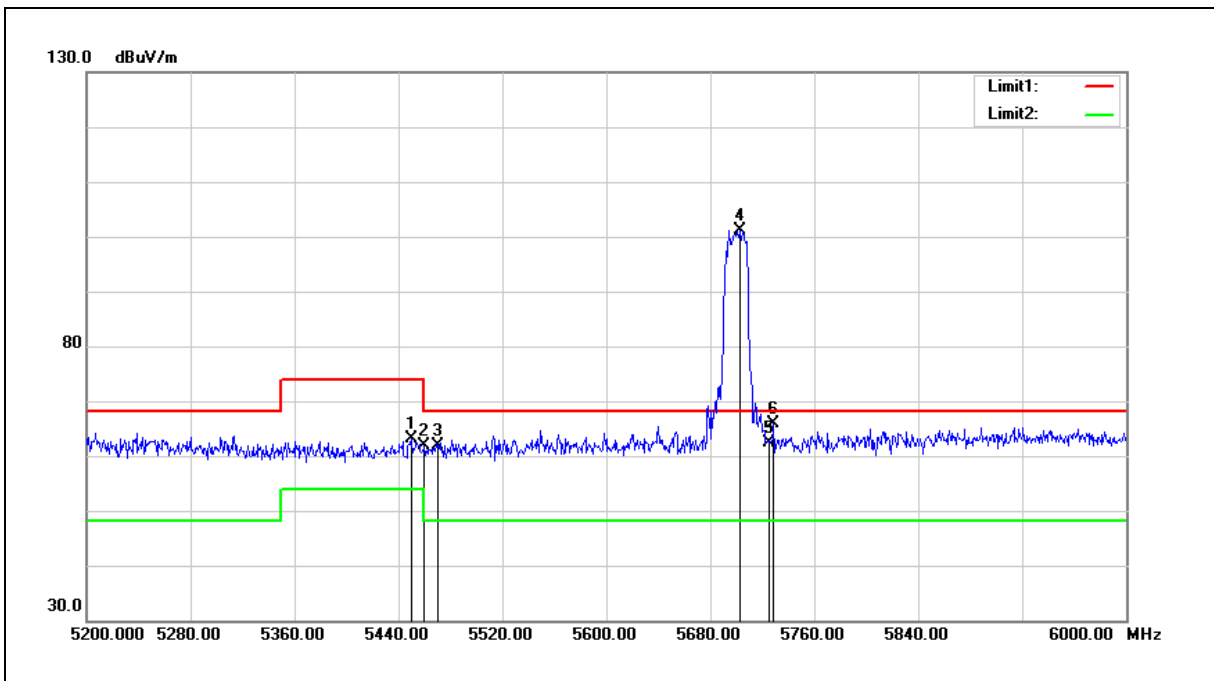

| No. | Frequency (MHz) | Reading (dBuV) | Correct Factor (dB/m) | Result (dBuV/m) | Limit (dBuV/m) | Margin (dB) | Remark |
|-----|-----------------|----------------|-----------------------|-----------------|----------------|-------------|--------|
| 1 | 5449.600 | 58.26 | 4.95 | 63.21 | 74.00 | -10.79 | peak |
| 2 | 5460.000 | 56.84 | 4.97 | 61.81 | 74.00 | -12.19 | peak |
| 3 | 5470.000 | 57.00 | 4.98 | 61.98 | 68.20 | -6.22 | peak |
| 4 | 5702.400 | 95.82 | 5.42 | 101.24 | -- | -- | peak |
| 5 | 5725.000 | 56.92 | 5.47 | 62.39 | 68.20 | -5.81 | peak |
| 6 | 5728.800 | 60.45 | 5.47 | 65.92 | 68.20 | -2.28 | peak |

Note:1.Result (dBuV/m) = Correct Factor (dB/m) + Reading(dBuV).

2.Correction factor (dB/m) = Antenna Factor (dB/m) + Cable loss (dB) – Pre-Amplifier gain (dB).

3.When the peak results are less than average limit, so not need to evaluate the average.



| | | | |
|-------------|-----------------|----------------|-----|
| Standard: | FCC Part 15.407 | Test Distance: | 3 m |
| Test item: | Band edge | | |
| Frequency: | 5720 MHz | | |
| Mode: | Mode 2 | | |
| Ant.Polar.: | Horizontal | | |

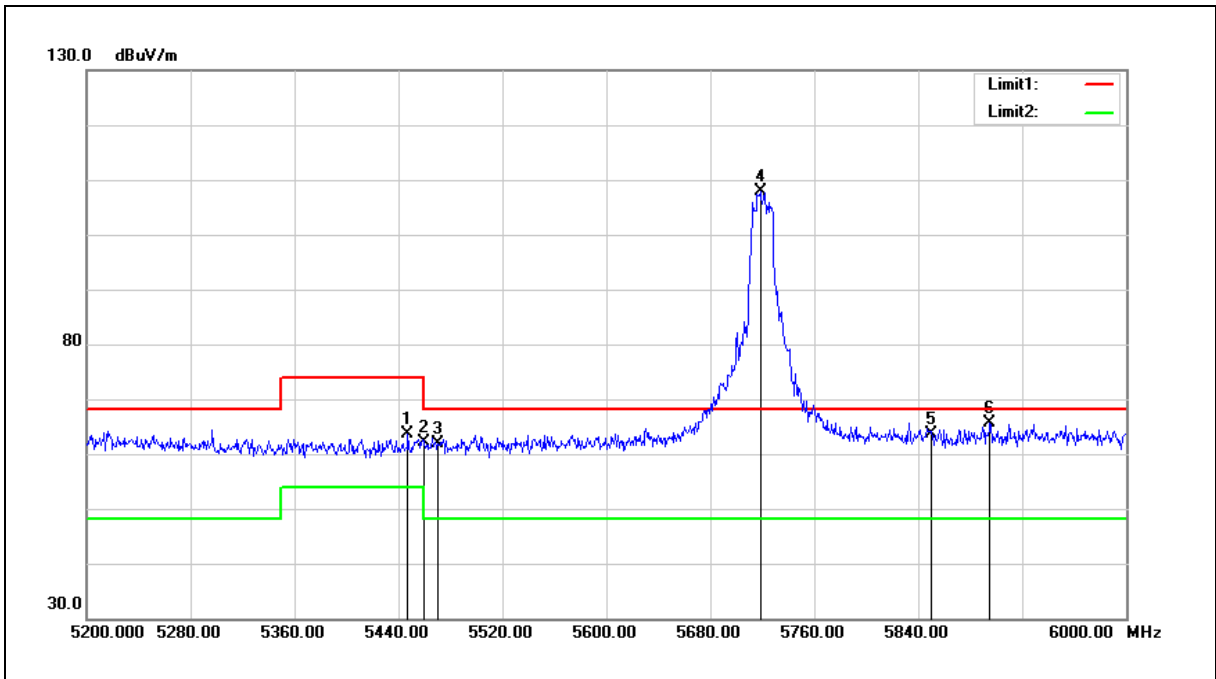

| No. | Frequency (MHz) | Reading (dBuV) | Correct Factor (dB/m) | Result (dBuV/m) | Limit (dBuV/m) | Margin (dB) | Remark |
|-----|-----------------|----------------|-----------------------|-----------------|----------------|-------------|--------|
| 1 | 5447.200 | 58.72 | 4.95 | 63.67 | 74.00 | -10.33 | peak |
| 2 | 5460.000 | 57.23 | 4.97 | 62.20 | 74.00 | -11.80 | peak |
| 3 | 5470.000 | 56.89 | 4.98 | 61.87 | 68.20 | -6.33 | peak |
| 4 | 5718.400 | 102.30 | 5.46 | 107.76 | -- | -- | peak |
| 5 | 5850.000 | 58.01 | 5.72 | 63.73 | 68.20 | -4.47 | peak |
| 6 | 5895.200 | 59.93 | 5.80 | 65.73 | 68.20 | -2.47 | peak |

Note:1.Result (dBuV/m) = Correct Factor (dB/m) + Reading(dBuV).

2.Correction factor (dB/m) = Antenna Factor (dB/m) + Cable loss (dB) – Pre-Amplifier gain (dB).

3.When the peak results are less than average limit, so not need to evaluate the average.



| | | | |
|-------------|-----------------|----------------|-----|
| Standard: | FCC Part 15.407 | Test Distance: | 3 m |
| Test item: | Band edge | | |
| Frequency: | 5720 MHz | | |
| Mode: | Mode 2 | | |
| Ant.Polar.: | Vertical | | |

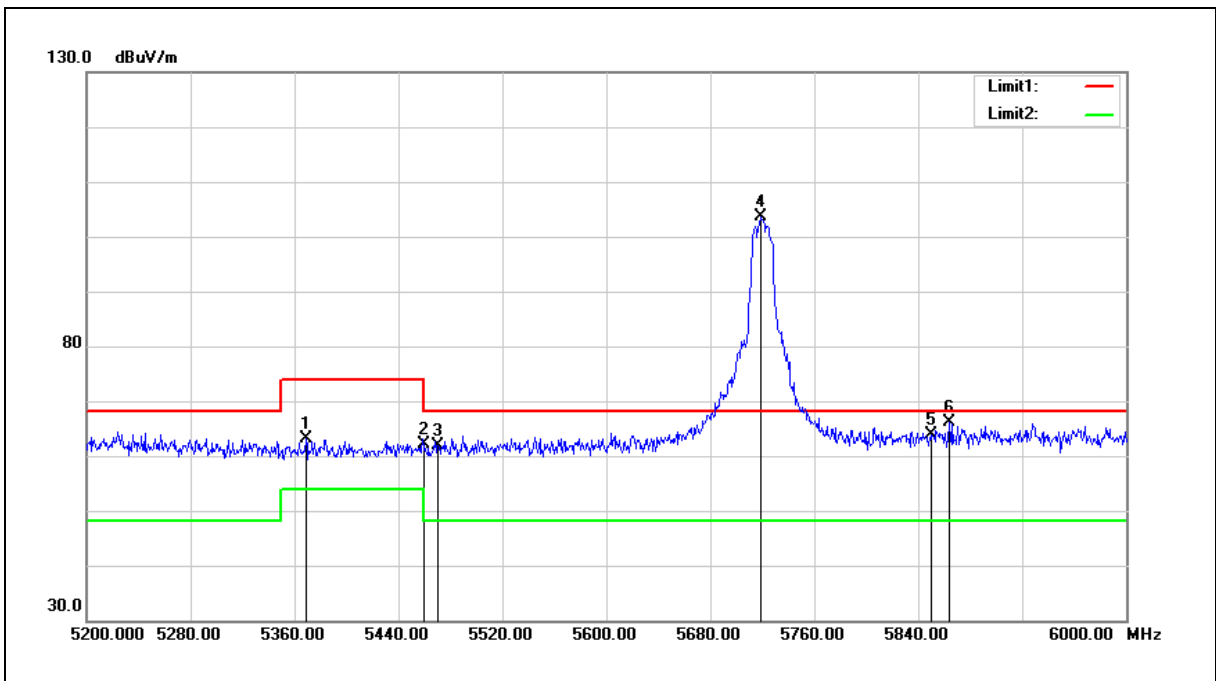

| No. | Frequency (MHz) | Reading (dBuV) | Correct Factor (dB/m) | Result (dBuV/m) | Limit (dBuV/m) | Margin (dB) | Remark |
|-----|-----------------|----------------|-----------------------|-----------------|----------------|-------------|--------|
| 1 | 5368.800 | 58.32 | 4.87 | 63.19 | 74.00 | -10.81 | peak |
| 2 | 5460.000 | 57.04 | 4.97 | 62.01 | 74.00 | -11.99 | peak |
| 3 | 5470.000 | 56.81 | 4.98 | 61.79 | 68.20 | -6.41 | peak |
| 4 | 5719.200 | 98.28 | 5.46 | 103.74 | -- | -- | peak |
| 5 | 5850.000 | 58.26 | 5.72 | 63.98 | 68.20 | -4.22 | peak |
| 6 | 5864.000 | 60.28 | 5.75 | 66.03 | 68.20 | -2.17 | peak |

Note:1.Result (dBuV/m) = Correct Factor (dB/m) + Reading(dBuV).

2.Correction factor (dB/m) = Antenna Factor (dB/m) + Cable loss (dB) – Pre-Amplifier gain (dB).

3.When the peak results are less than average limit, so not need to evaluate the average.



| | | | |
|-------------|-----------------|----------------|-----|
| Standard: | FCC Part 15.407 | Test Distance: | 3 m |
| Test item: | Band edge | | |
| Frequency: | 5745 MHz | | |
| Mode: | Mode 2 | | |
| Ant.Polar.: | Horizontal | | |

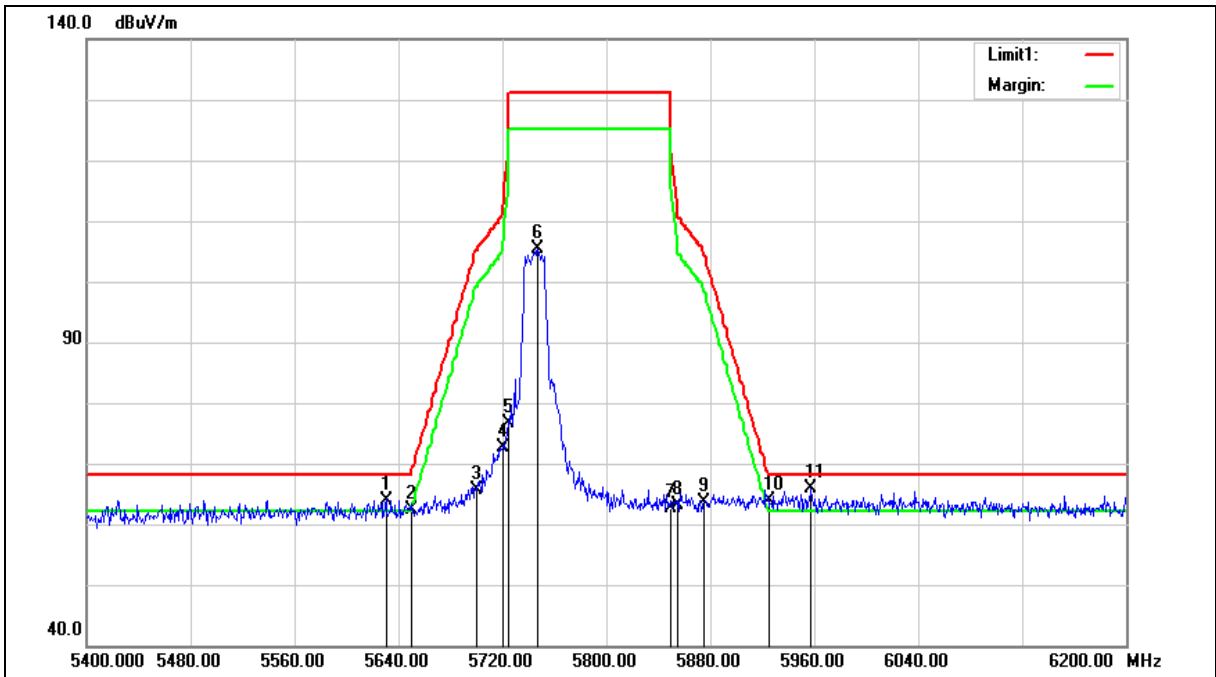



| | | | |
|-------------|-----------------|----------------|-----|
| Standard: | FCC Part 15.407 | Test Distance: | 3 m |
| Test item: | Band edge | | |
| Frequency: | 5745 MHz | | |
| Mode: | Mode 2 | | |
| Ant.Polar.: | Horizontal | | |

| No. | Frequency (MHz) | Reading (dBuV) | Correct Factor (dB/m) | Result (dBuV/m) | Limit (dBuV/m) | Margin (dB) | Remark |
|-----|-----------------|----------------|-----------------------|-----------------|----------------|-------------|--------|
| 1 | 5630.400 | 58.72 | 5.28 | 64.00 | 68.20 | -4.20 | peak |
| 2 | 5650.000 | 56.99 | 5.31 | 62.30 | 68.20 | -5.90 | peak |
| 3 | 5700.000 | 60.13 | 5.42 | 65.55 | 105.20 | -39.65 | peak |
| 4 | 5720.000 | 67.16 | 5.46 | 72.62 | 110.80 | -38.18 | peak |
| 5 | 5725.000 | 71.06 | 5.47 | 76.53 | 122.20 | -45.67 | peak |
| 6 | 5747.200 | 99.83 | 5.52 | 105.35 | -- | -- | peak |
| 7 | 5850.000 | 57.02 | 5.72 | 62.74 | 122.20 | -59.46 | peak |
| 8 | 5855.000 | 57.52 | 5.73 | 63.25 | 110.80 | -47.55 | peak |
| 9 | 5875.000 | 57.84 | 5.77 | 63.61 | 105.20 | -41.59 | peak |
| 10 | 5925.000 | 57.97 | 5.87 | 63.84 | 68.20 | -4.36 | peak |
| 11 | 5957.600 | 59.89 | 5.94 | 65.83 | 68.20 | -2.37 | peak |

Note:1.Result (dBuV/m) = Correct Factor (dB/m) + Reading(dBuV).

2.Correction factor (dB/m) = Antenna Factor (dB/m) + Cable loss (dB) – Pre-Amplifier gain (dB).

3.When the peak results are less than average limit, so not need to evaluate the average.



| | | | |
|-------------|-----------------|----------------|-----|
| Standard: | FCC Part 15.407 | Test Distance: | 3 m |
| Test item: | Band edge | | |
| Frequency: | 5745 MHz | | |
| Mode: | Mode 2 | | |
| Ant.Polar.: | Vertical | | |

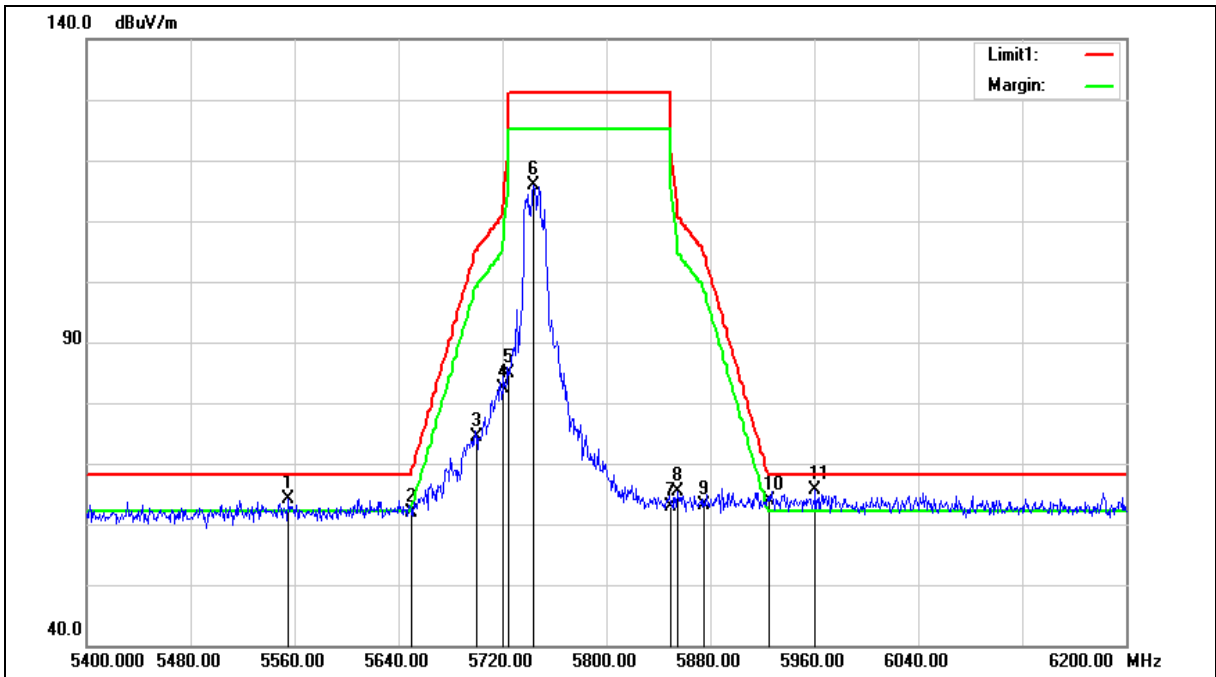



| | | | |
|-------------|-----------------|----------------|-----|
| Standard: | FCC Part 15.407 | Test Distance: | 3 m |
| Test item: | Band edge | | |
| Frequency: | 5745 MHz | | |
| Mode: | Mode 2 | | |
| Ant.Polar.: | Vertical | | |

| No. | Frequency (MHz) | Reading (dBuV) | Correct Factor (dB/m) | Result (dBuV/m) | Limit (dBuV/m) | Margin (dB) | Remark |
|-----|-----------------|----------------|-----------------------|-----------------|----------------|-------------|--------|
| 1 | 5555.200 | 58.94 | 5.13 | 64.07 | 68.20 | -4.13 | peak |
| 2 | 5650.000 | 56.58 | 5.31 | 61.89 | 68.20 | -6.31 | peak |
| 3 | 5700.000 | 68.92 | 5.42 | 74.34 | 105.20 | -30.86 | peak |
| 4 | 5720.000 | 76.80 | 5.46 | 82.26 | 110.80 | -28.54 | peak |
| 5 | 5725.000 | 79.45 | 5.47 | 84.92 | 122.20 | -37.28 | peak |
| 6 | 5744.000 | 110.26 | 5.51 | 115.77 | -- | -- | peak |
| 7 | 5850.000 | 57.14 | 5.72 | 62.86 | 122.20 | -59.34 | peak |
| 8 | 5855.000 | 59.64 | 5.73 | 65.37 | 110.80 | -45.43 | peak |
| 9 | 5875.000 | 57.34 | 5.77 | 63.11 | 105.20 | -42.09 | peak |
| 10 | 5925.000 | 58.09 | 5.87 | 63.96 | 68.20 | -4.24 | peak |
| 11 | 5960.800 | 59.61 | 5.94 | 65.55 | 68.20 | -2.65 | peak |

Note:1.Result (dBuV/m) = Correct Factor (dB/m) + Reading(dBuV).

2.Correction factor (dB/m) = Antenna Factor (dB/m) + Cable loss (dB) – Pre-Amplifier gain (dB).

3.When the peak results are less than average limit, so not need to evaluate the average.



| | | | |
|-------------|-----------------|----------------|-----|
| Standard: | FCC Part 15.407 | Test Distance: | 3 m |
| Test item: | Band edge | | |
| Frequency: | 5785 MHz | | |
| Mode: | Mode 2 | | |
| Ant.Polar.: | Horizontal | | |

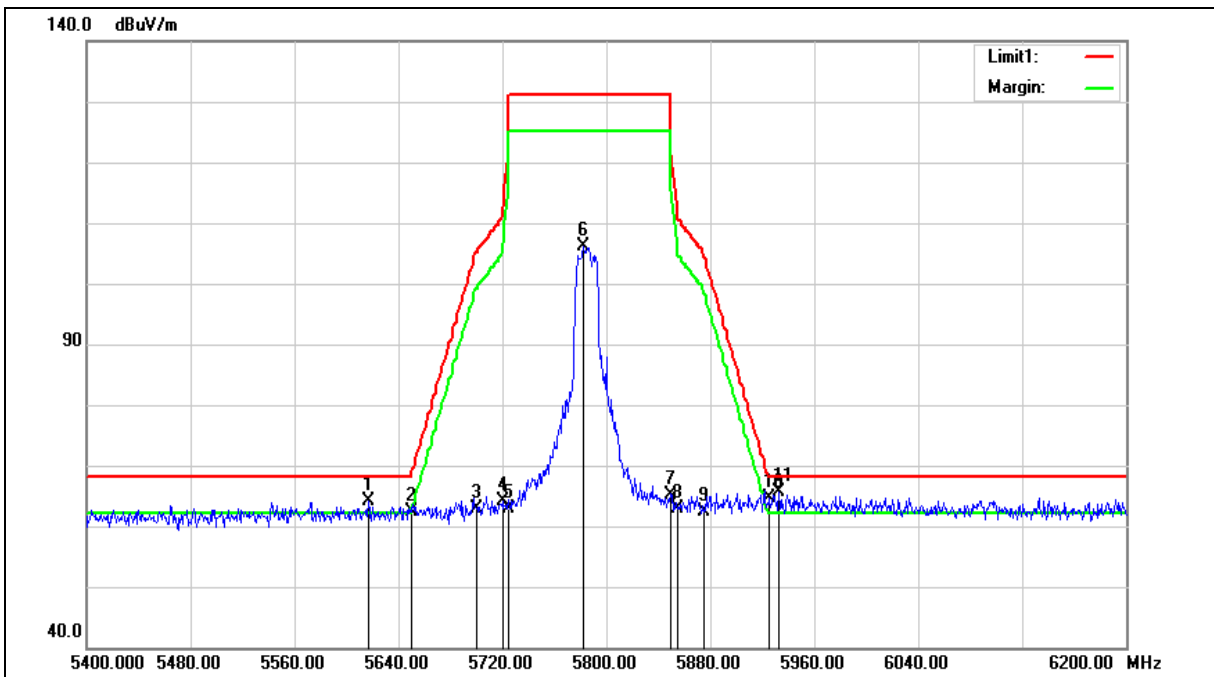



| | | | |
|-------------|-----------------|----------------|-----|
| Standard: | FCC Part 15.407 | Test Distance: | 3 m |
| Test item: | Band edge | | |
| Frequency: | 5785 MHz | | |
| Mode: | Mode 2 | | |
| Ant.Polar.: | Horizontal | | |

| No. | Frequency (MHz) | Reading (dBUV) | Correct Factor (dB/m) | Result (dBUV/m) | Limit (dBUV/m) | Margin (dB) | Remark |
|-----|-----------------|----------------|-----------------------|-----------------|----------------|-------------|--------|
| 1 | 5616.800 | 58.87 | 5.25 | 64.12 | 68.20 | -4.08 | peak |
| 2 | 5650.000 | 56.96 | 5.31 | 62.27 | 68.20 | -5.93 | peak |
| 3 | 5700.000 | 57.44 | 5.42 | 62.86 | 105.20 | -42.34 | peak |
| 4 | 5720.000 | 58.56 | 5.46 | 64.02 | 110.80 | -46.78 | peak |
| 5 | 5725.000 | 57.37 | 5.47 | 62.84 | 122.20 | -59.36 | peak |
| 6 | 5782.400 | 100.66 | 5.58 | 106.24 | -- | -- | peak |
| 7 | 5850.000 | 59.34 | 5.72 | 65.06 | 122.20 | -57.14 | peak |
| 8 | 5855.000 | 57.17 | 5.73 | 62.90 | 110.80 | -47.90 | peak |
| 9 | 5875.000 | 56.49 | 5.77 | 62.26 | 105.20 | -42.94 | peak |
| 10 | 5925.000 | 58.77 | 5.87 | 64.64 | 68.20 | -3.56 | peak |
| 11 | 5932.800 | 59.75 | 5.89 | 65.64 | 68.20 | -2.56 | peak |

Note:1.Result (dBUV/m) = Correct Factor (dB/m) + Reading(dBUV).

2.Correction factor (dB/m) = Antenna Factor (dB/m) + Cable loss (dB) – Pre-Amplifier gain (dB).

3.When the peak results are less than average limit, so not need to evaluate the average.



| | | | |
|-------------|-----------------|----------------|-----|
| Standard: | FCC Part 15.407 | Test Distance: | 3 m |
| Test item: | Band edge | | |
| Frequency: | 5785 MHz | | |
| Mode: | Mode 2 | | |
| Ant.Polar.: | Vertical | | |

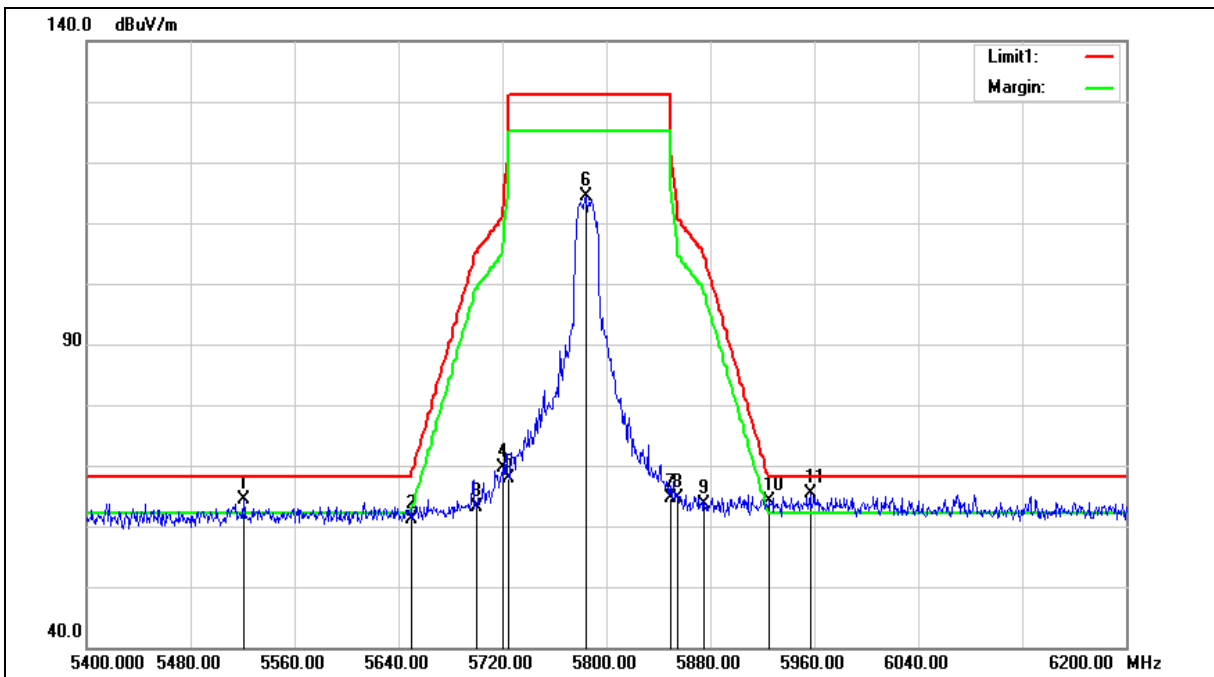



| | | | |
|-------------|-----------------|----------------|-----|
| Standard: | FCC Part 15.407 | Test Distance: | 3 m |
| Test item: | Band edge | | |
| Frequency: | 5785 MHz | | |
| Mode: | Mode 2 | | |
| Ant.Polar.: | Vertical | | |

| No. | Frequency (MHz) | Reading (dBuV) | Correct Factor (dB/m) | Result (dBuV/m) | Limit (dBuV/m) | Margin (dB) | Remark |
|-----|-----------------|----------------|-----------------------|-----------------|----------------|-------------|--------|
| 1 | 5520.800 | 59.22 | 5.06 | 64.28 | 68.20 | -3.92 | peak |
| 2 | 5650.000 | 55.71 | 5.31 | 61.02 | 68.20 | -7.18 | peak |
| 3 | 5700.000 | 57.69 | 5.42 | 63.11 | 105.20 | -42.09 | peak |
| 4 | 5720.000 | 64.07 | 5.46 | 69.53 | 110.80 | -41.27 | peak |
| 5 | 5725.000 | 62.47 | 5.47 | 67.94 | 122.20 | -54.26 | peak |
| 6 | 5784.800 | 108.80 | 5.59 | 114.39 | -- | -- | peak |
| 7 | 5850.000 | 58.98 | 5.72 | 64.70 | 122.20 | -57.50 | peak |
| 8 | 5855.000 | 58.86 | 5.73 | 64.59 | 110.80 | -46.21 | peak |
| 9 | 5875.000 | 57.78 | 5.77 | 63.55 | 105.20 | -41.65 | peak |
| 10 | 5925.000 | 58.23 | 5.87 | 64.10 | 68.20 | -4.10 | peak |
| 11 | 5956.800 | 59.47 | 5.94 | 65.41 | 68.20 | -2.79 | peak |

Note:1.Result (dBuV/m) = Correct Factor (dB/m) + Reading(dBuV).

2.Correction factor (dB/m) = Antenna Factor (dB/m) + Cable loss (dB) – Pre-Amplifier gain (dB).

3.When the peak results are less than average limit, so not need to evaluate the average.



| | | | |
|-------------|-----------------|----------------|-----|
| Standard: | FCC Part 15.407 | Test Distance: | 3 m |
| Test item: | Band edge | | |
| Frequency: | 5825 MHz | | |
| Mode: | Mode 2 | | |
| Ant.Polar.: | Horizontal | | |

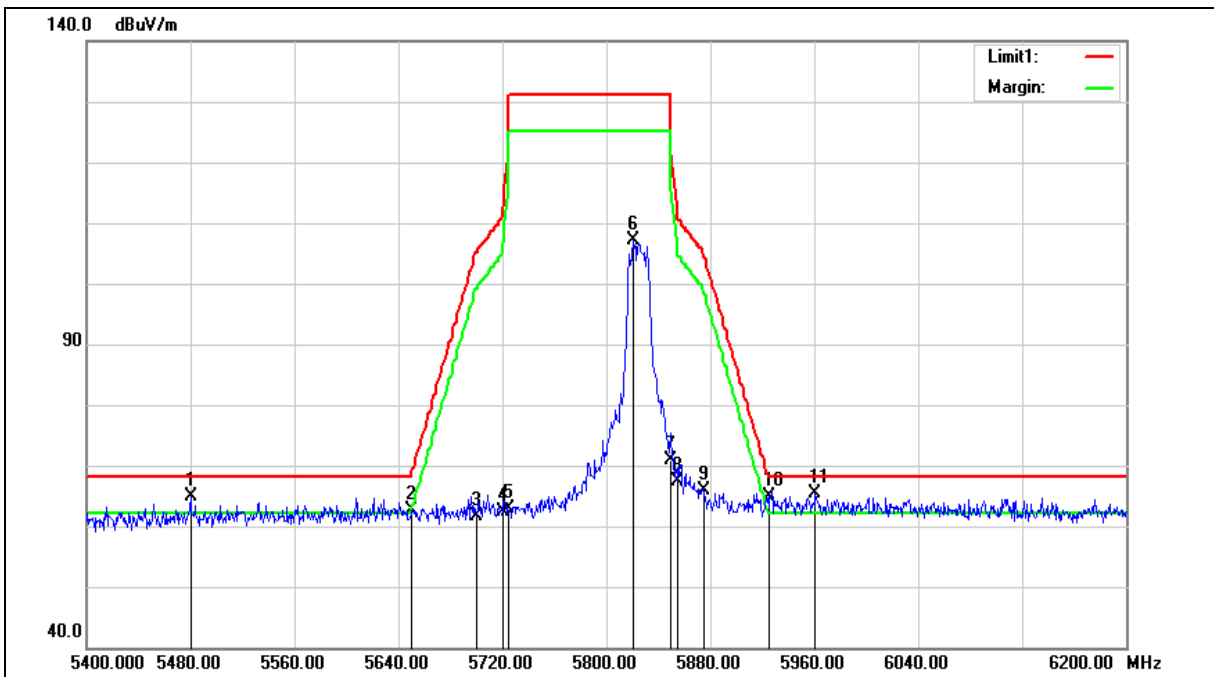



| | | | |
|-------------|-----------------|----------------|-----|
| Standard: | FCC Part 15.407 | Test Distance: | 3 m |
| Test item: | Band edge | | |
| Frequency: | 5825 MHz | | |
| Mode: | Mode 2 | | |
| Ant.Polar.: | Horizontal | | |

| No. | Frequency (MHz) | Reading (dBuV) | Correct Factor (dB/m) | Result (dBuV/m) | Limit (dBuV/m) | Margin (dB) | Remark |
|-----|-----------------|----------------|-----------------------|-----------------|----------------|-------------|--------|
| 1 | 5480.000 | 59.96 | 4.98 | 64.94 | 68.20 | -3.26 | peak |
| 2 | 5650.000 | 57.34 | 5.31 | 62.65 | 68.20 | -5.55 | peak |
| 3 | 5700.000 | 56.29 | 5.42 | 61.71 | 105.20 | -43.49 | peak |
| 4 | 5720.000 | 57.00 | 5.46 | 62.46 | 110.80 | -48.34 | peak |
| 5 | 5725.000 | 57.31 | 5.47 | 62.78 | 122.20 | -59.42 | peak |
| 6 | 5820.800 | 101.43 | 5.65 | 107.08 | -- | -- | peak |
| 7 | 5850.000 | 65.11 | 5.72 | 70.83 | 122.20 | -51.37 | peak |
| 8 | 5855.000 | 61.75 | 5.73 | 67.48 | 110.80 | -43.32 | peak |
| 9 | 5875.000 | 60.03 | 5.77 | 65.80 | 105.20 | -39.40 | peak |
| 10 | 5925.000 | 59.09 | 5.87 | 64.96 | 68.20 | -3.24 | peak |
| 11 | 5960.800 | 59.46 | 5.94 | 65.40 | 68.20 | -2.80 | peak |

Note:1.Result (dBuV/m) = Correct Factor (dB/m) + Reading(dBuV).

2.Correction factor (dB/m) = Antenna Factor (dB/m) + Cable loss (dB) – Pre-Amplifier gain (dB).

3.When the peak results are less than average limit, so not need to evaluate the average.



| | | | |
|-------------|-----------------|----------------|-----|
| Standard: | FCC Part 15.407 | Test Distance: | 3 m |
| Test item: | Band edge | | |
| Frequency: | 5825 MHz | | |
| Mode: | Mode 2 | | |
| Ant.Polar.: | Vertical | | |

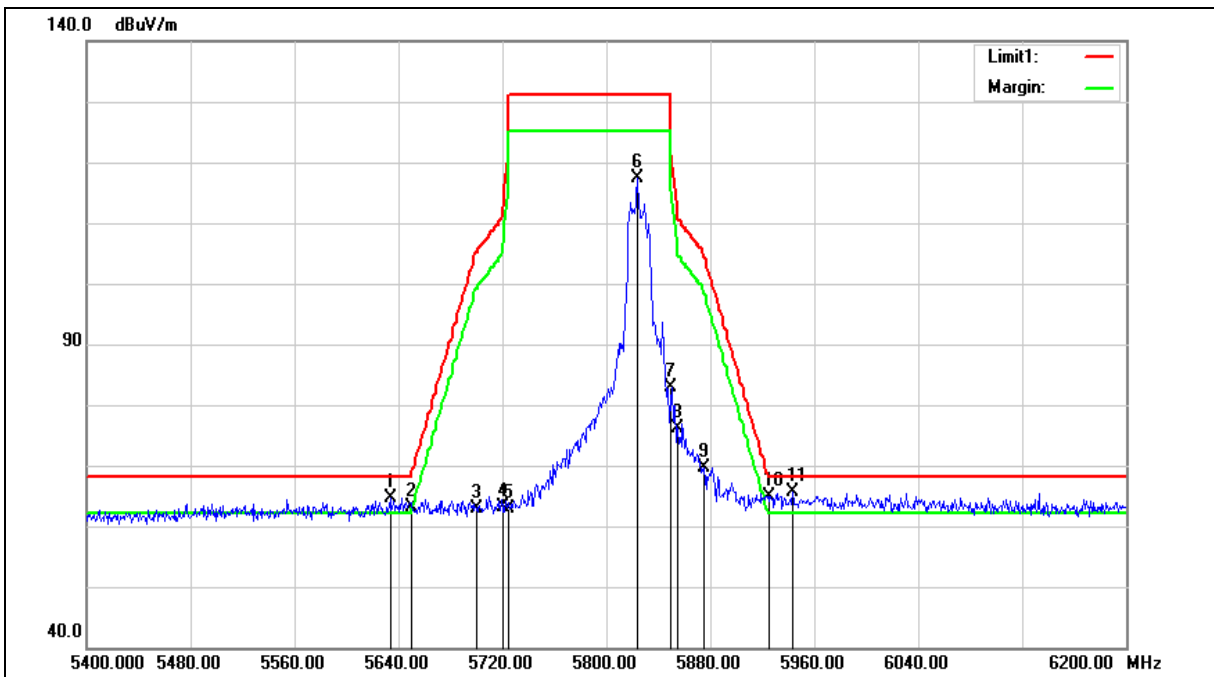



| | | | |
|-------------|-----------------|----------------|-----|
| Standard: | FCC Part 15.407 | Test Distance: | 3 m |
| Test item: | Band edge | | |
| Frequency: | 5825 MHz | | |
| Mode: | Mode 2 | | |
| Ant.Polar.: | Vertical | | |

| No. | Frequency (MHz) | Reading (dBuV) | Correct Factor (dB/m) | Result (dBuV/m) | Limit (dBuV/m) | Margin (dB) | Remark |
|-----|-----------------|----------------|-----------------------|-----------------|----------------|-------------|--------|
| 1 | 5633.600 | 59.41 | 5.28 | 64.69 | 68.20 | -3.51 | peak |
| 2 | 5650.000 | 57.89 | 5.31 | 63.20 | 68.20 | -5.00 | peak |
| 3 | 5700.000 | 57.41 | 5.42 | 62.83 | 105.20 | -42.37 | peak |
| 4 | 5720.000 | 57.68 | 5.46 | 63.14 | 110.80 | -47.66 | peak |
| 5 | 5725.000 | 57.38 | 5.47 | 62.85 | 122.20 | -59.35 | peak |
| 6 | 5824.000 | 111.76 | 5.67 | 117.43 | -- | -- | peak |
| 7 | 5850.000 | 77.09 | 5.72 | 82.81 | 122.20 | -39.39 | peak |
| 8 | 5855.000 | 70.32 | 5.73 | 76.05 | 110.80 | -34.75 | peak |
| 9 | 5875.000 | 63.75 | 5.77 | 69.52 | 105.20 | -35.68 | peak |
| 10 | 5925.000 | 58.98 | 5.87 | 64.85 | 68.20 | -3.35 | peak |
| 11 | 5943.200 | 59.65 | 5.91 | 65.56 | 68.20 | -2.64 | peak |

Note:1.Result (dBuV/m) = Correct Factor (dB/m) + Reading(dBuV).

2.Correction factor (dB/m) = Antenna Factor (dB/m) + Cable loss (dB) – Pre-Amplifier gain (dB).

3.When the peak results are less than average limit, so not need to evaluate the average.



| | | | |
|-------------|-----------------|----------------|-----|
| Standard: | FCC Part 15.407 | Test Distance: | 3 m |
| Test item: | Band edge | | |
| Frequency: | 5180 MHz | | |
| Mode: | Mode 8 | | |
| Ant.Polar.: | Horizontal | | |

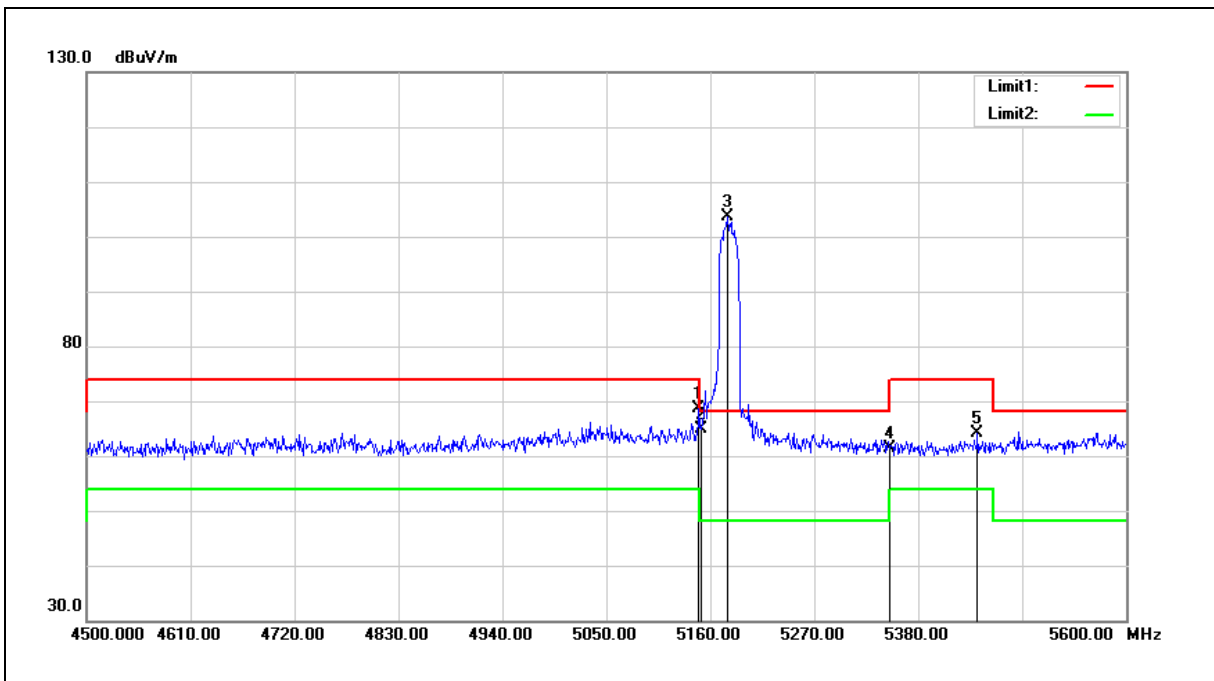

| No. | Frequency (MHz) | Reading (dBuV) | Correct Factor (dB/m) | Result (dBuV/m) | Limit (dBuV/m) | Margin (dB) | Remark |
|-----|-----------------|----------------|-----------------------|-----------------|----------------|-------------|--------|
| 1 | 5147.900 | 63.97 | 4.60 | 68.57 | 74.00 | -5.43 | peak |
| 2 | 5150.000 | 60.40 | 4.60 | 65.00 | 74.00 | -9.00 | peak |
| 3 | 5178.700 | 98.89 | 4.63 | 103.52 | -- | -- | peak |
| 4 | 5350.000 | 56.50 | 4.84 | 61.34 | 74.00 | -12.66 | peak |
| 5 | 5442.700 | 59.14 | 4.94 | 64.08 | 74.00 | -9.92 | peak |

Note:1.Result (dBuV/m) = Correct Factor (dB/m) + Reading(dBuV).

2.Correction factor (dB/m) = Antenna Factor (dB/m) + Cable loss (dB) – Pre-Amplifier gain (dB).

3.When the peak results are less than average limit, so not need to evaluate the average.



| | | | |
|-------------|-----------------|----------------|-----|
| Standard: | FCC Part 15.407 | Test Distance: | 3 m |
| Test item: | Band edge | | |
| Frequency: | 5180 MHz | | |
| Mode: | Mode 8 | | |
| Ant.Polar.: | Vertical | | |

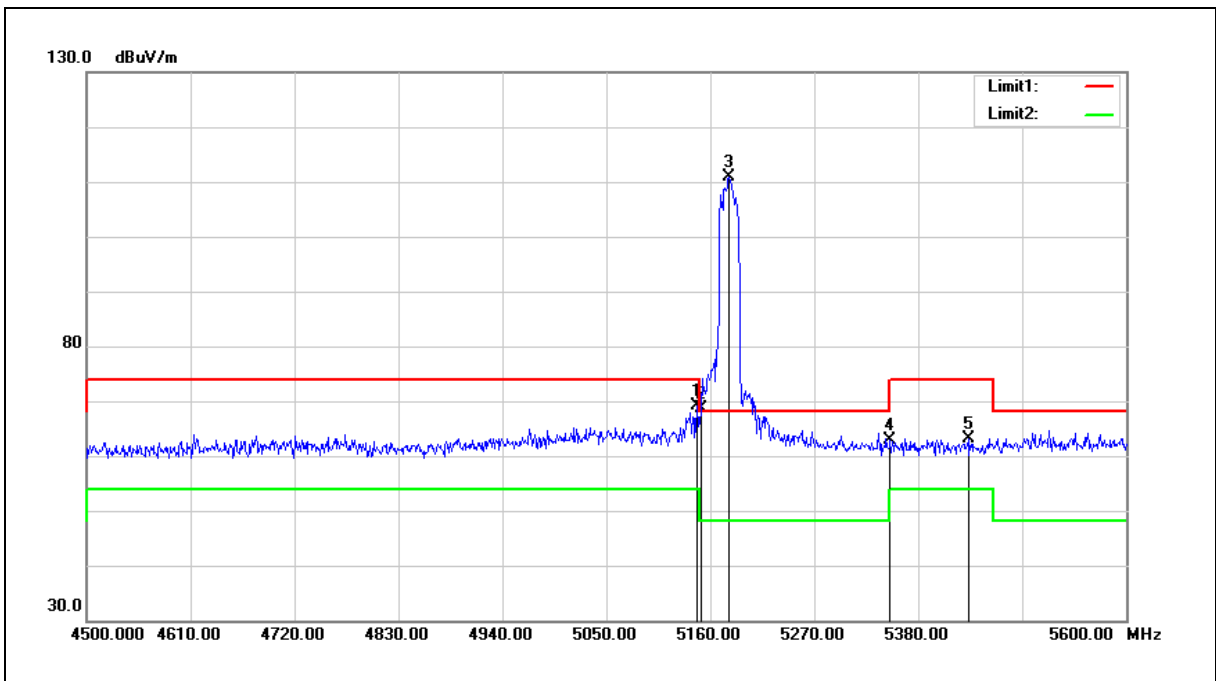

| No. | Frequency (MHz) | Reading (dBuV) | Correct Factor (dB/m) | Result (dBuV/m) | Limit (dBuV/m) | Margin (dB) | Remark |
|-----|-----------------|----------------|-----------------------|-----------------|----------------|-------------|--------|
| 1 | 5145.700 | 64.46 | 4.60 | 69.06 | 74.00 | -4.94 | peak |
| 2 | 5150.000 | 64.13 | 4.60 | 68.73 | 74.00 | -5.27 | peak |
| 3 | 5179.800 | 106.18 | 4.63 | 110.81 | -- | -- | peak |
| 4 | 5350.000 | 58.07 | 4.84 | 62.91 | 74.00 | -11.09 | peak |
| 5 | 5432.800 | 58.22 | 4.94 | 63.16 | 74.00 | -10.84 | peak |

Note:1.Result (dBuV/m) = Correct Factor (dB/m) + Reading(dBuV).

2.Correction factor (dB/m) = Antenna Factor (dB/m) + Cable loss (dB) – Pre-Amplifier gain (dB).

3.When the peak results are less than average limit, so not need to evaluate the average.



| | | | |
|-------------|-----------------|----------------|-----|
| Standard: | FCC Part 15.407 | Test Distance: | 3 m |
| Test item: | Band edge | | |
| Frequency: | 5200 MHz | | |
| Mode: | Mode 8 | | |
| Ant.Polar.: | Horizontal | | |

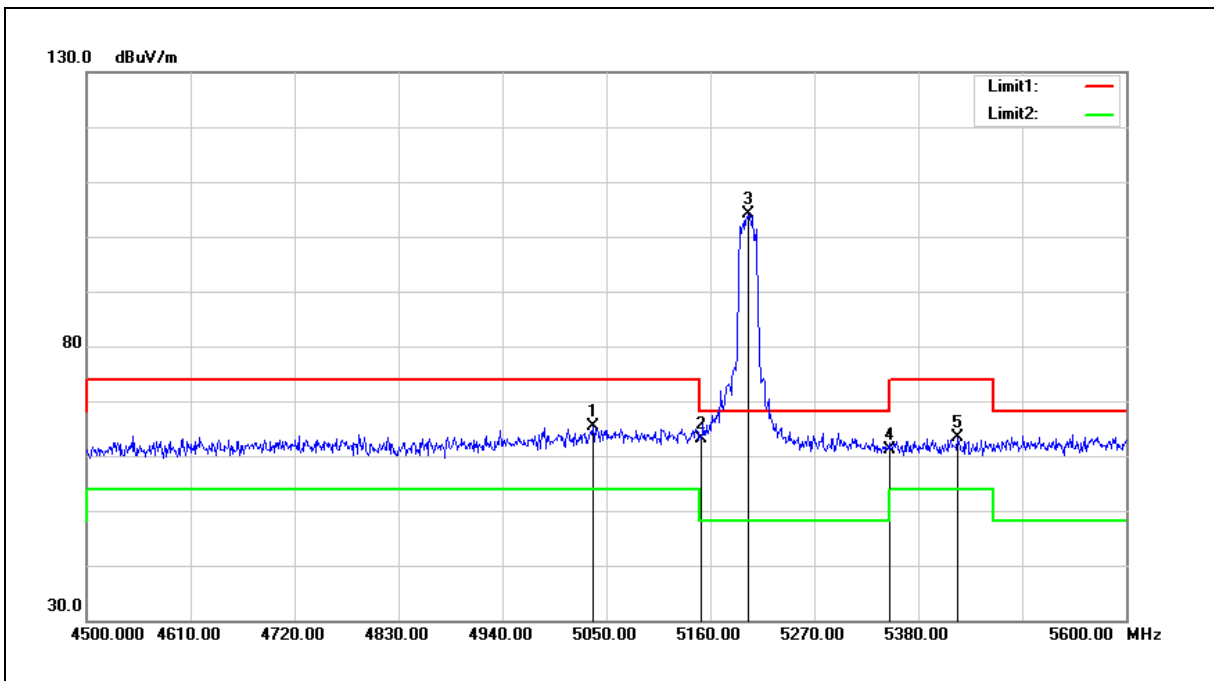

| No. | Frequency (MHz) | Reading (dBuV) | Correct Factor (dB/m) | Result (dBuV/m) | Limit (dBuV/m) | Margin (dB) | Remark |
|-----|-----------------|----------------|-----------------------|-----------------|----------------|-------------|--------|
| 1 | 5035.700 | 60.80 | 4.46 | 65.26 | 74.00 | -8.74 | peak |
| 2 | 5150.000 | 58.52 | 4.60 | 63.12 | 74.00 | -10.88 | peak |
| 3 | 5200.700 | 99.41 | 4.66 | 104.07 | -- | -- | peak |
| 4 | 5350.000 | 56.40 | 4.84 | 61.24 | 74.00 | -12.76 | peak |
| 5 | 5421.800 | 58.42 | 4.92 | 63.34 | 74.00 | -10.66 | peak |

Note:1.Result (dBuV/m) = Correct Factor (dB/m) + Reading(dBuV).

2.Correction factor (dB/m) = Antenna Factor (dB/m) + Cable loss (dB) – Pre-Amplifier gain (dB).

3.When the peak results are less than average limit, so not need to evaluate the average.

| | | | |
|-------------|-----------------|----------------|-----|
| Standard: | FCC Part 15.407 | Test Distance: | 3 m |
| Test item: | Band edge | | |
| Frequency: | 5200 MHz | | |
| Mode: | Mode 8 | | |
| Ant.Polar.: | Vertical | | |

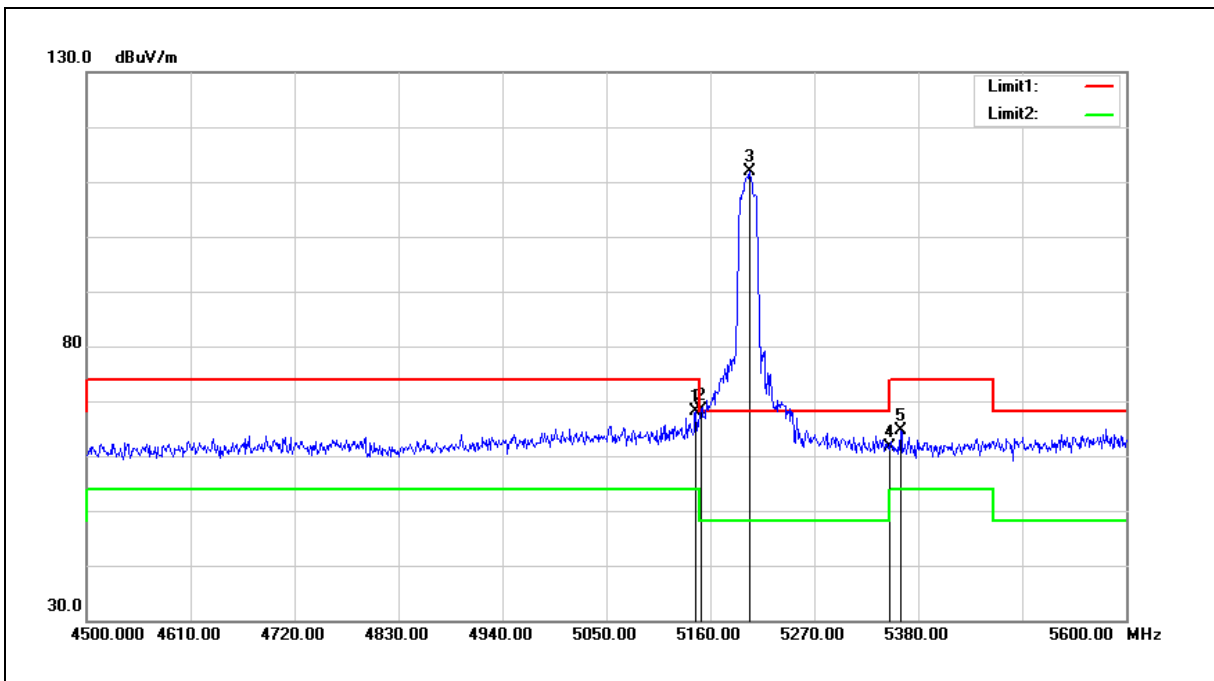

| No. | Frequency (MHz) | Reading (dBuV) | Correct Factor (dB/m) | Result (dBuV/m) | Limit (dBuV/m) | Margin (dB) | Remark |
|-----|-----------------|----------------|-----------------------|-----------------|----------------|-------------|--------|
| 1 | 5144.600 | 63.50 | 4.60 | 68.10 | 74.00 | -5.90 | peak |
| 2 | 5150.000 | 63.66 | 4.60 | 68.26 | 74.00 | -5.74 | peak |
| 3 | 5201.800 | 107.28 | 4.66 | 111.94 | -- | -- | peak |
| 4 | 5350.000 | 56.75 | 4.84 | 61.59 | 74.00 | -12.41 | peak |
| 5 | 5361.300 | 59.67 | 4.85 | 64.52 | 74.00 | -9.48 | peak |

Note:1.Result (dBuV/m) = Correct Factor (dB/m) + Reading(dBuV).

2.Correction factor (dB/m) = Antenna Factor (dB/m) + Cable loss (dB) – Pre-Amplifier gain (dB).

3.When the peak results are less than average limit, so not need to evaluate the average.



| | | | |
|-------------|-----------------|----------------|-----|
| Standard: | FCC Part 15.407 | Test Distance: | 3 m |
| Test item: | Band edge | | |
| Frequency: | 5240 MHz | | |
| Mode: | Mode 8 | | |
| Ant.Polar.: | Horizontal | | |

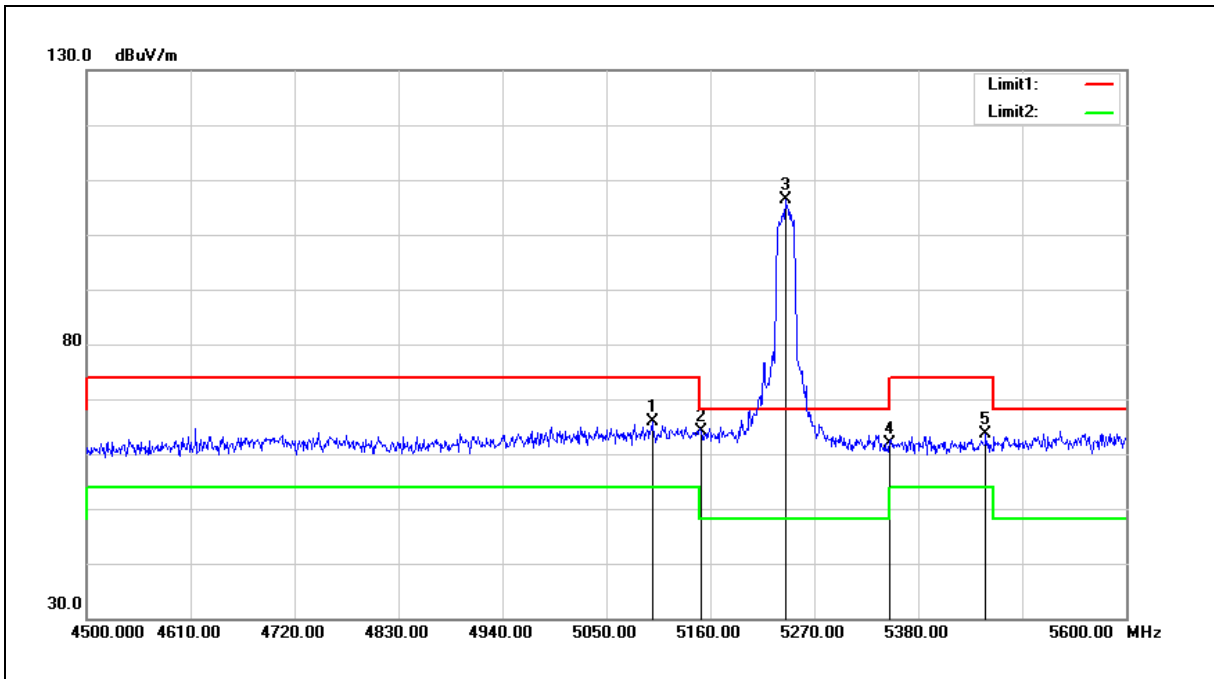

| No. | Frequency (MHz) | Reading (dBuV) | Correct Factor (dB/m) | Result (dBuV/m) | Limit (dBuV/m) | Margin (dB) | Remark |
|-----|-----------------|----------------|-----------------------|-----------------|----------------|-------------|--------|
| 1 | 5098.400 | 61.29 | 4.53 | 65.82 | 74.00 | -8.18 | peak |
| 2 | 5150.000 | 59.51 | 4.60 | 64.11 | 74.00 | -9.89 | peak |
| 3 | 5239.200 | 101.56 | 4.70 | 106.26 | -- | -- | peak |
| 4 | 5350.000 | 56.96 | 4.84 | 61.80 | 74.00 | -12.20 | peak |
| 5 | 5451.500 | 58.56 | 4.95 | 63.51 | 74.00 | -10.49 | peak |

Note:1.Result (dBuV/m) = Correct Factor (dB/m) + Reading(dBuV).

2.Correction factor (dB/m) = Antenna Factor (dB/m) + Cable loss (dB) – Pre-Amplifier gain (dB).

3.When the peak results are less than average limit, so not need to evaluate the average.



| | | | |
|-------------|-----------------|----------------|-----|
| Standard: | FCC Part 15.407 | Test Distance: | 3 m |
| Test item: | Band edge | | |
| Frequency: | 5240 MHz | | |
| Mode: | Mode 8 | | |
| Ant.Polar.: | Vertical | | |

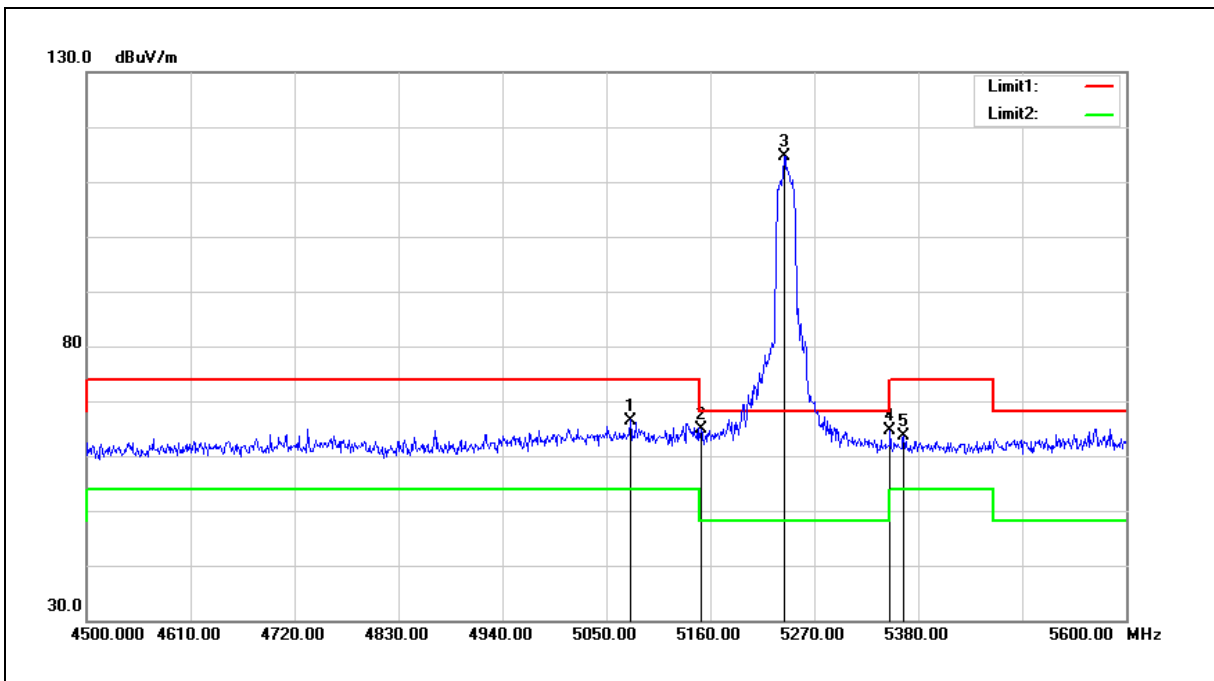

| No. | Frequency (MHz) | Reading (dBuV) | Correct Factor (dB/m) | Result (dBuV/m) | Limit (dBuV/m) | Margin (dB) | Remark |
|-----|-----------------|----------------|-----------------------|-----------------|----------------|-------------|--------|
| 1 | 5075.300 | 61.99 | 4.51 | 66.50 | 74.00 | -7.50 | peak |
| 2 | 5150.000 | 60.31 | 4.60 | 64.91 | 74.00 | -9.09 | peak |
| 3 | 5238.100 | 110.02 | 4.70 | 114.72 | -- | -- | peak |
| 4 | 5350.000 | 59.85 | 4.84 | 64.69 | 74.00 | -9.31 | peak |
| 5 | 5364.600 | 58.68 | 4.85 | 63.53 | 74.00 | -10.47 | peak |

Note:1.Result (dBuV/m) = Correct Factor (dB/m) + Reading(dBuV).

2.Correction factor (dB/m) = Antenna Factor (dB/m) + Cable loss (dB) – Pre-Amplifier gain (dB).

3.When the peak results are less than average limit, so not need to evaluate the average.



| | | | |
|-------------|-----------------|----------------|-----|
| Standard: | FCC Part 15.407 | Test Distance: | 3 m |
| Test item: | Band edge | | |
| Frequency: | 5260 MHz | | |
| Mode: | Mode 8 | | |
| Ant.Polar.: | Horizontal | | |

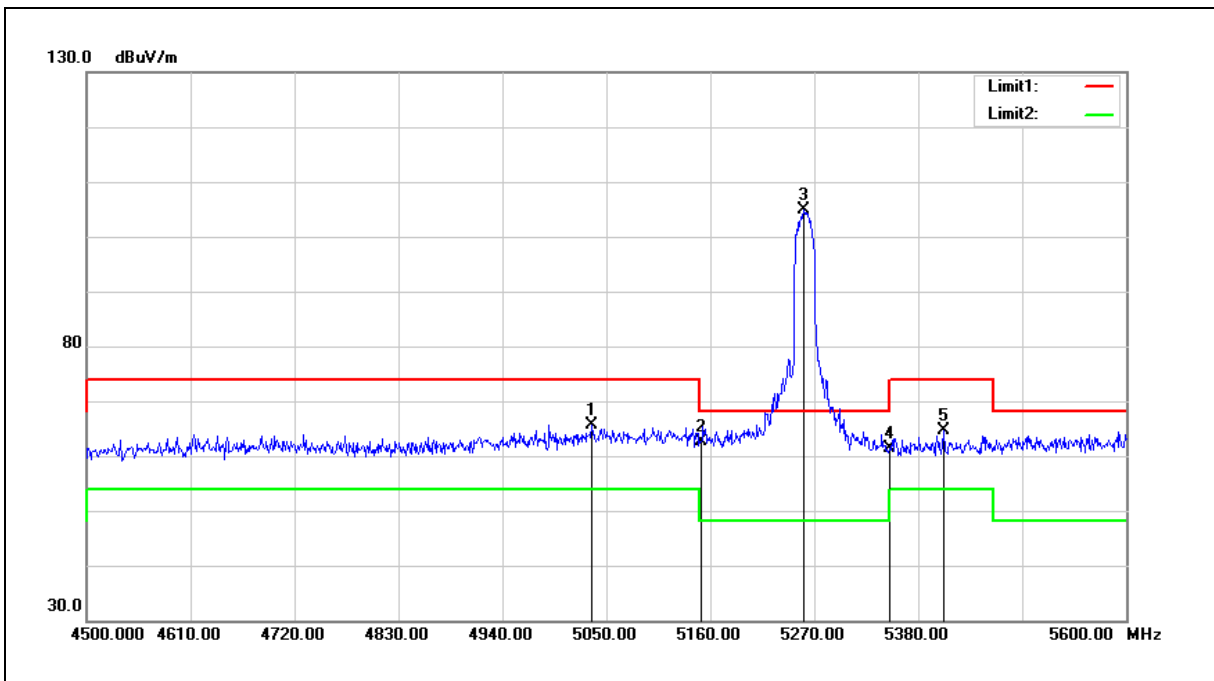

| No. | Frequency (MHz) | Reading (dBuV) | Correct Factor (dB/m) | Result (dBuV/m) | Limit (dBuV/m) | Margin (dB) | Remark |
|-----|-----------------|----------------|-----------------------|-----------------|----------------|-------------|--------|
| 1 | 5034.600 | 61.19 | 4.46 | 65.65 | 74.00 | -8.35 | peak |
| 2 | 5150.000 | 57.98 | 4.60 | 62.58 | 74.00 | -11.42 | peak |
| 3 | 5259.000 | 100.25 | 4.73 | 104.98 | -- | -- | peak |
| 4 | 5350.000 | 56.59 | 4.84 | 61.43 | 74.00 | -12.57 | peak |
| 5 | 5406.400 | 59.76 | 4.91 | 64.67 | 74.00 | -9.33 | peak |

Note:1.Result (dBuV/m) = Correct Factor (dB/m) + Reading(dBuV).

2.Correction factor (dB/m) = Antenna Factor (dB/m) + Cable loss (dB) – Pre-Amplifier gain (dB).

3.When the peak results are less than average limit, so not need to evaluate the average.



| | | | |
|-------------|-----------------|----------------|-----|
| Standard: | FCC Part 15.407 | Test Distance: | 3 m |
| Test item: | Band edge | | |
| Frequency: | 5260 MHz | | |
| Mode: | Mode 8 | | |
| Ant.Polar.: | Vertical | | |

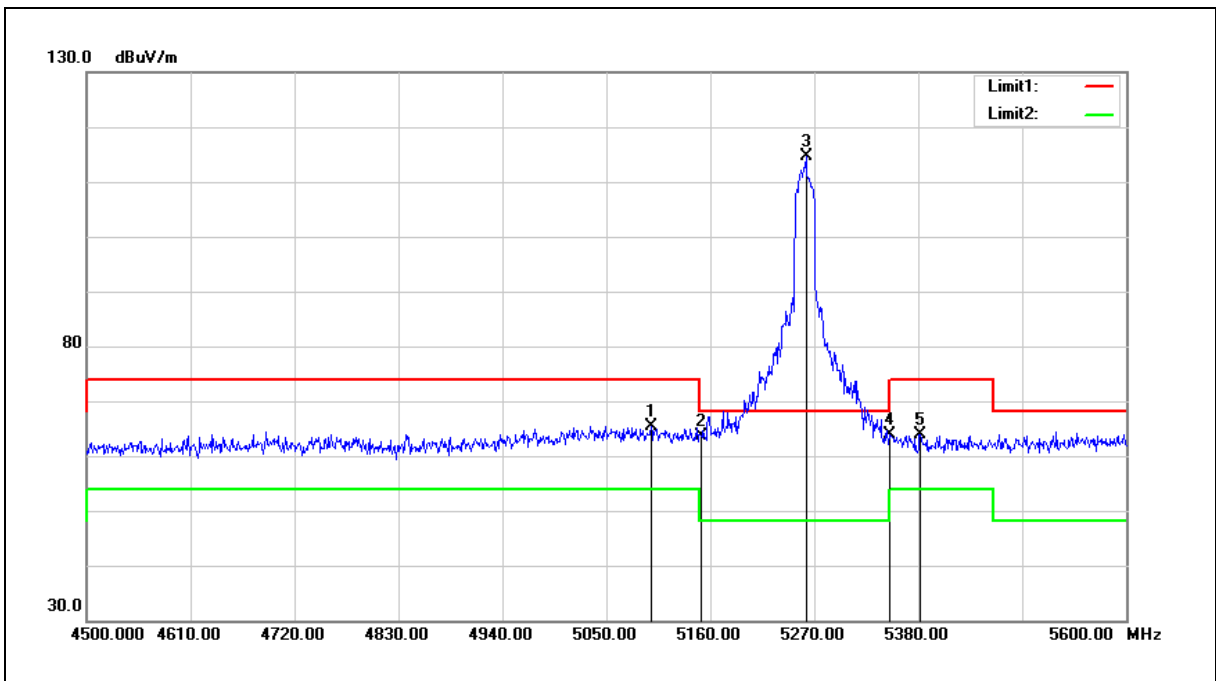

| No. | Frequency (MHz) | Reading (dBuV) | Correct Factor (dB/m) | Result (dBuV/m) | Limit (dBuV/m) | Margin (dB) | Remark |
|-----|-----------------|----------------|-----------------------|-----------------|----------------|-------------|--------|
| 1 | 5097.300 | 60.88 | 4.53 | 65.41 | 74.00 | -8.59 | peak |
| 2 | 5150.000 | 59.01 | 4.60 | 63.61 | 74.00 | -10.39 | peak |
| 3 | 5261.200 | 109.80 | 4.73 | 114.53 | -- | -- | peak |
| 4 | 5350.000 | 59.06 | 4.84 | 63.90 | 74.00 | -10.10 | peak |
| 5 | 5382.200 | 59.09 | 4.88 | 63.97 | 74.00 | -10.03 | peak |

Note:1.Result (dBuV/m) = Correct Factor (dB/m) + Reading(dBuV).

2.Correction factor (dB/m) = Antenna Factor (dB/m) + Cable loss (dB) – Pre-Amplifier gain (dB).

3.When the peak results are less than average limit, so not need to evaluate the average.



| | | | |
|-------------|-----------------|----------------|-----|
| Standard: | FCC Part 15.407 | Test Distance: | 3 m |
| Test item: | Band edge | | |
| Frequency: | 5280 MHz | | |
| Mode: | Mode 8 | | |
| Ant.Polar.: | Horizontal | | |

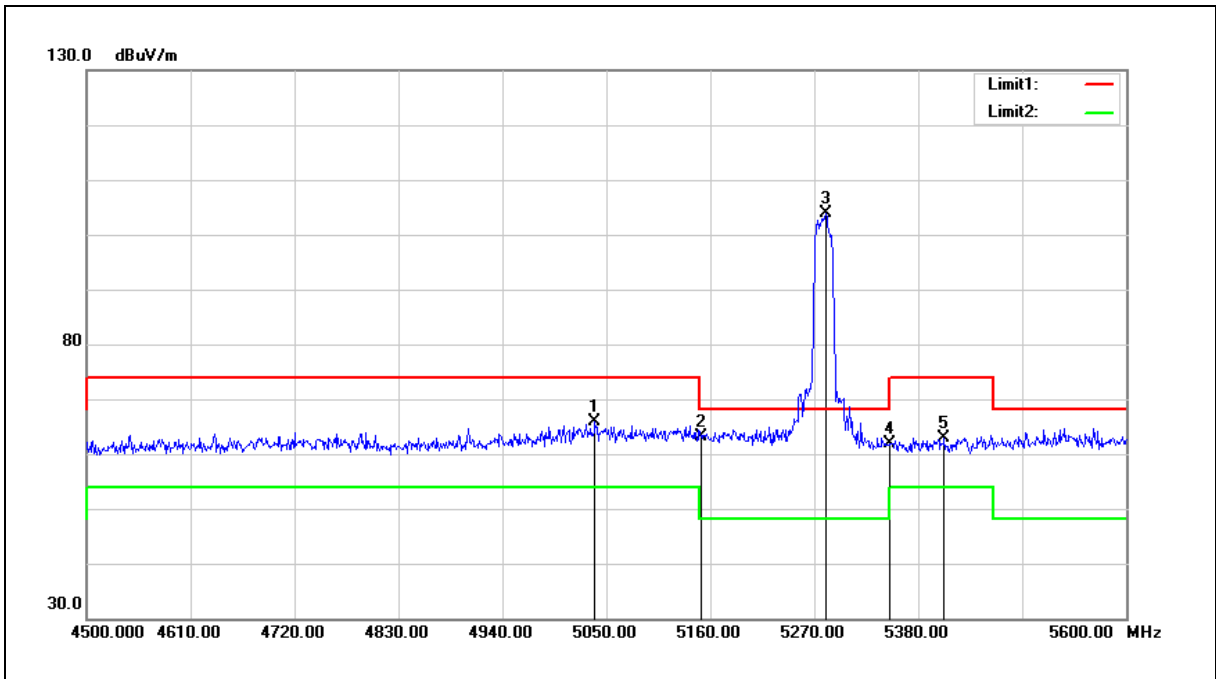

| No. | Frequency (MHz) | Reading (dBuV) | Correct Factor (dB/m) | Result (dBuV/m) | Limit (dBuV/m) | Margin (dB) | Remark |
|-----|-----------------|----------------|-----------------------|-----------------|----------------|-------------|--------|
| 1 | 5037.900 | 61.48 | 4.46 | 65.94 | 74.00 | -8.06 | peak |
| 2 | 5150.000 | 58.42 | 4.60 | 63.02 | 74.00 | -10.98 | peak |
| 3 | 5282.100 | 99.13 | 4.76 | 103.89 | -- | -- | peak |
| 4 | 5350.000 | 56.98 | 4.84 | 61.82 | 74.00 | -12.18 | peak |
| 5 | 5407.500 | 58.07 | 4.91 | 62.98 | 74.00 | -11.02 | peak |

Note:1.Result (dBuV/m) = Correct Factor (dB/m) + Reading(dBuV).

2.Correction factor (dB/m) = Antenna Factor (dB/m) + Cable loss (dB) – Pre-Amplifier gain (dB).

3.When the peak results are less than average limit, so not need to evaluate the average.



| | | | |
|-------------|-----------------|----------------|-----|
| Standard: | FCC Part 15.407 | Test Distance: | 3 m |
| Test item: | Band edge | | |
| Frequency: | 5280 MHz | | |
| Mode: | Mode 8 | | |
| Ant.Polar.: | Vertical | | |

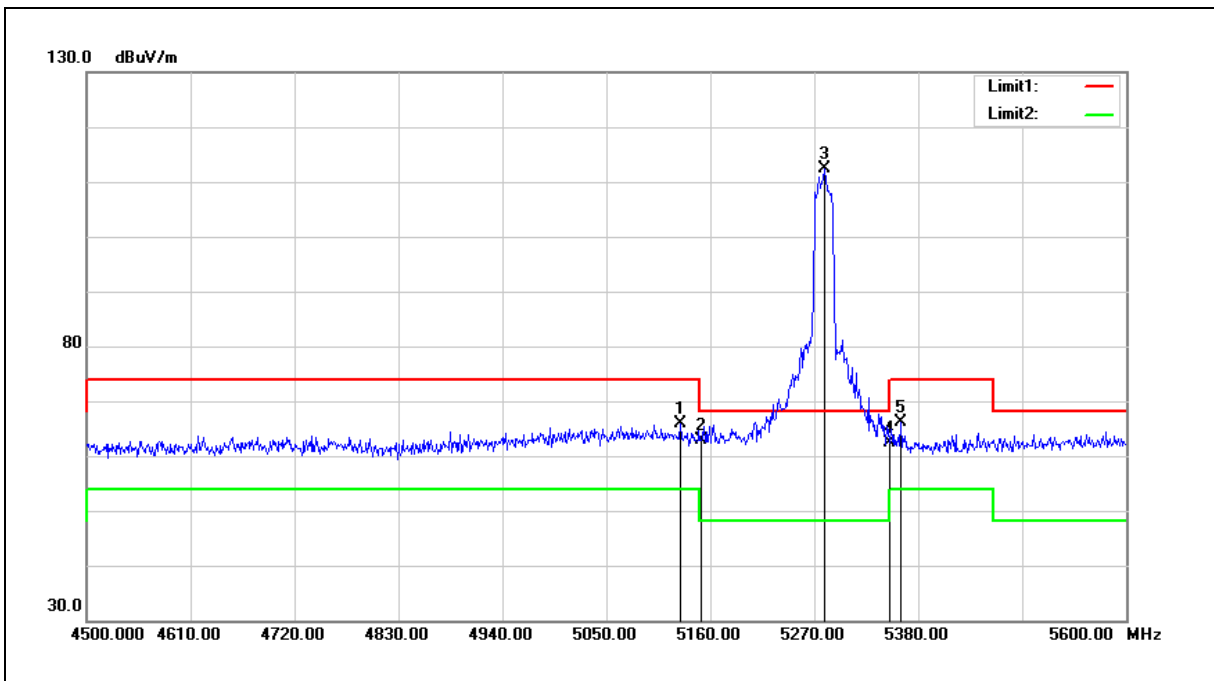

| No. | Frequency (MHz) | Reading (dBuV) | Correct Factor (dB/m) | Result (dBuV/m) | Limit (dBuV/m) | Margin (dB) | Remark |
|-----|-----------------|----------------|-----------------------|-----------------|----------------|-------------|--------|
| 1 | 5128.100 | 61.39 | 4.57 | 65.96 | 74.00 | -8.04 | peak |
| 2 | 5150.000 | 58.37 | 4.60 | 62.97 | 74.00 | -11.03 | peak |
| 3 | 5281.000 | 107.53 | 4.75 | 112.28 | -- | -- | peak |
| 4 | 5350.000 | 57.51 | 4.84 | 62.35 | 74.00 | -11.65 | peak |
| 5 | 5361.300 | 61.34 | 4.85 | 66.19 | 74.00 | -7.81 | peak |

Note:1.Result (dBuV/m) = Correct Factor (dB/m) + Reading(dBuV).

2.Correction factor (dB/m) = Antenna Factor (dB/m) + Cable loss (dB) – Pre-Amplifier gain (dB).

3.When the peak results are less than average limit, so not need to evaluate the average.



| | | | |
|-------------|-----------------|----------------|-----|
| Standard: | FCC Part 15.407 | Test Distance: | 3 m |
| Test item: | Band edge | | |
| Frequency: | 5320 MHz | | |
| Mode: | Mode 8 | | |
| Ant.Polar.: | Horizontal | | |

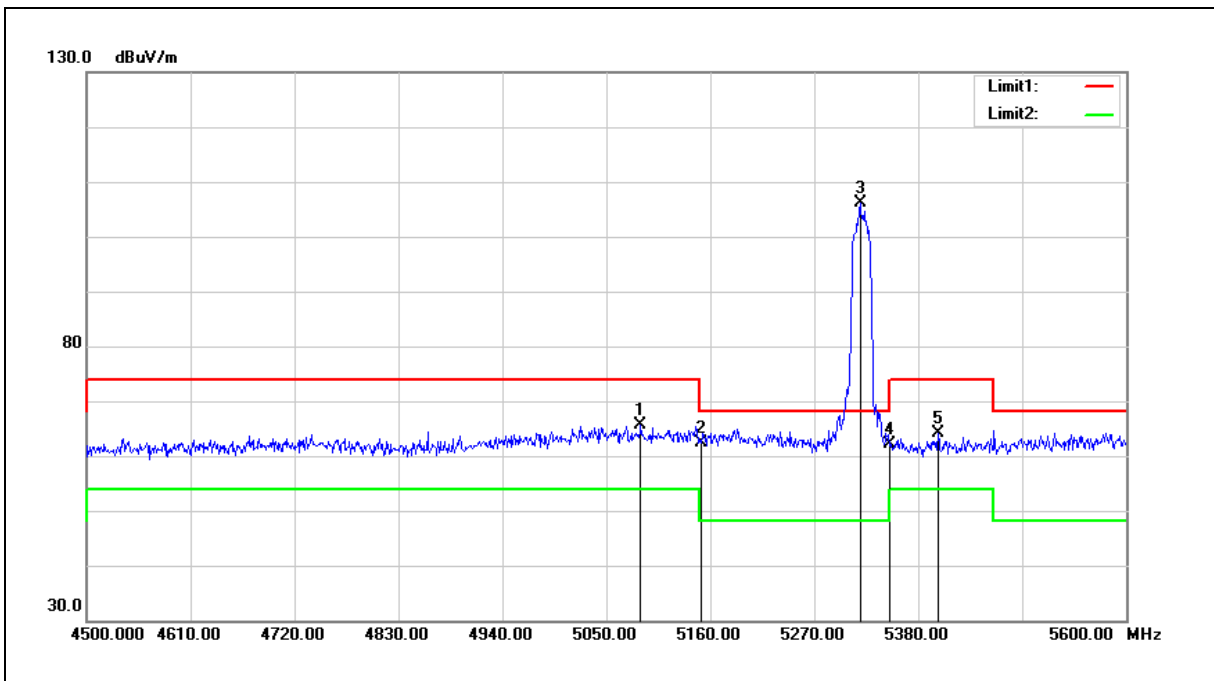

| No. | Frequency (MHz) | Reading (dBuV) | Correct Factor (dB/m) | Result (dBuV/m) | Limit (dBuV/m) | Margin (dB) | Remark |
|-----|-----------------|----------------|-----------------------|-----------------|----------------|-------------|--------|
| 1 | 5086.300 | 61.07 | 4.52 | 65.59 | 74.00 | -8.41 | peak |
| 2 | 5150.000 | 57.86 | 4.60 | 62.46 | 74.00 | -11.54 | peak |
| 3 | 5318.400 | 101.27 | 4.80 | 106.07 | -- | -- | peak |
| 4 | 5350.000 | 57.37 | 4.84 | 62.21 | 74.00 | -11.79 | peak |
| 5 | 5400.900 | 59.27 | 4.90 | 64.17 | 74.00 | -9.83 | peak |

Note:1.Result (dBuV/m) = Correct Factor (dB/m) + Reading(dBuV).

2.Correction factor (dB/m) = Antenna Factor (dB/m) + Cable loss (dB) – Pre-Amplifier gain (dB).

3.When the peak results are less than average limit, so not need to evaluate the average.



| | | | |
|-------------|-----------------|----------------|-----|
| Standard: | FCC Part 15.407 | Test Distance: | 3 m |
| Test item: | Band edge | | |
| Frequency: | 5320 MHz | | |
| Mode: | Mode 8 | | |
| Ant.Polar.: | Vertical | | |

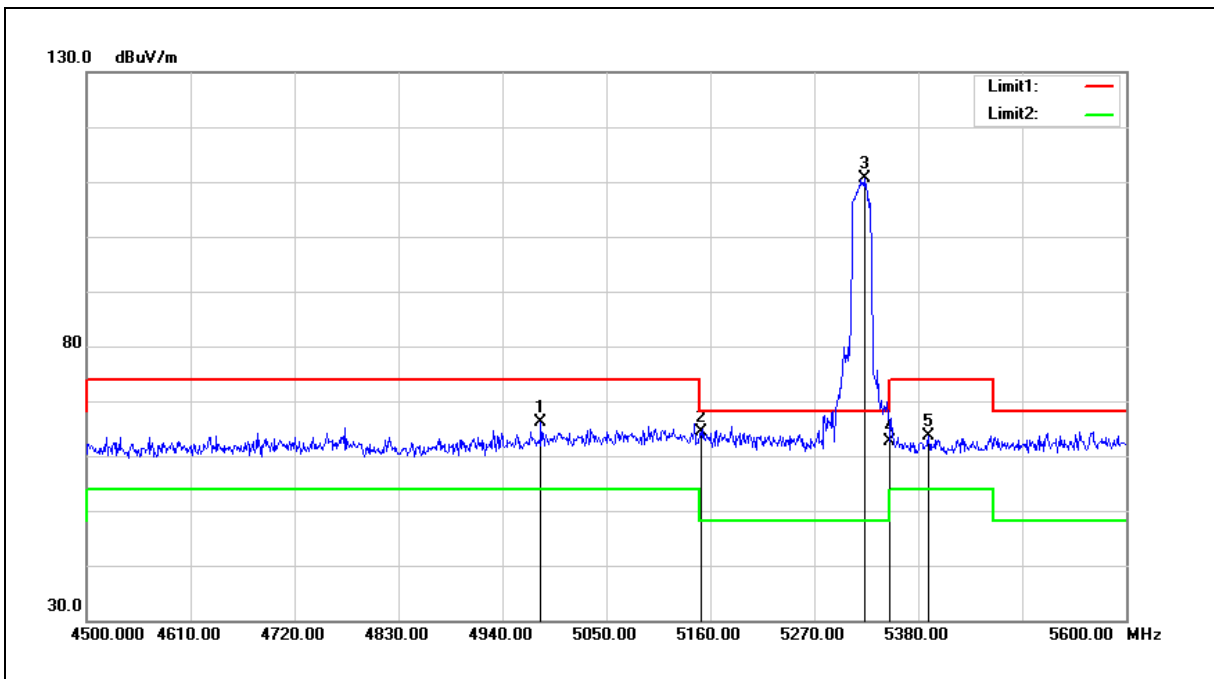

| No. | Frequency (MHz) | Reading (dBuV) | Correct Factor (dB/m) | Result (dBuV/m) | Limit (dBuV/m) | Margin (dB) | Remark |
|-----|-----------------|----------------|-----------------------|-----------------|----------------|-------------|--------|
| 1 | 4980.700 | 61.70 | 4.37 | 66.07 | 74.00 | -7.93 | peak |
| 2 | 5150.000 | 59.76 | 4.60 | 64.36 | 74.00 | -9.64 | peak |
| 3 | 5322.800 | 105.90 | 4.81 | 110.71 | -- | -- | peak |
| 4 | 5350.000 | 57.77 | 4.84 | 62.61 | 74.00 | -11.39 | peak |
| 5 | 5391.000 | 58.68 | 4.88 | 63.56 | 74.00 | -10.44 | peak |

Note:1.Result (dBuV/m) = Correct Factor (dB/m) + Reading(dBuV).

2.Correction factor (dB/m) = Antenna Factor (dB/m) + Cable loss (dB) – Pre-Amplifier gain (dB).

3.When the peak results are less than average limit, so not need to evaluate the average.



| | | | |
|-------------|-----------------|----------------|-----|
| Standard: | FCC Part 15.407 | Test Distance: | 3 m |
| Test item: | Band edge | | |
| Frequency: | 5500 MHz | | |
| Mode: | Mode 8 | | |
| Ant.Polar.: | Horizontal | | |

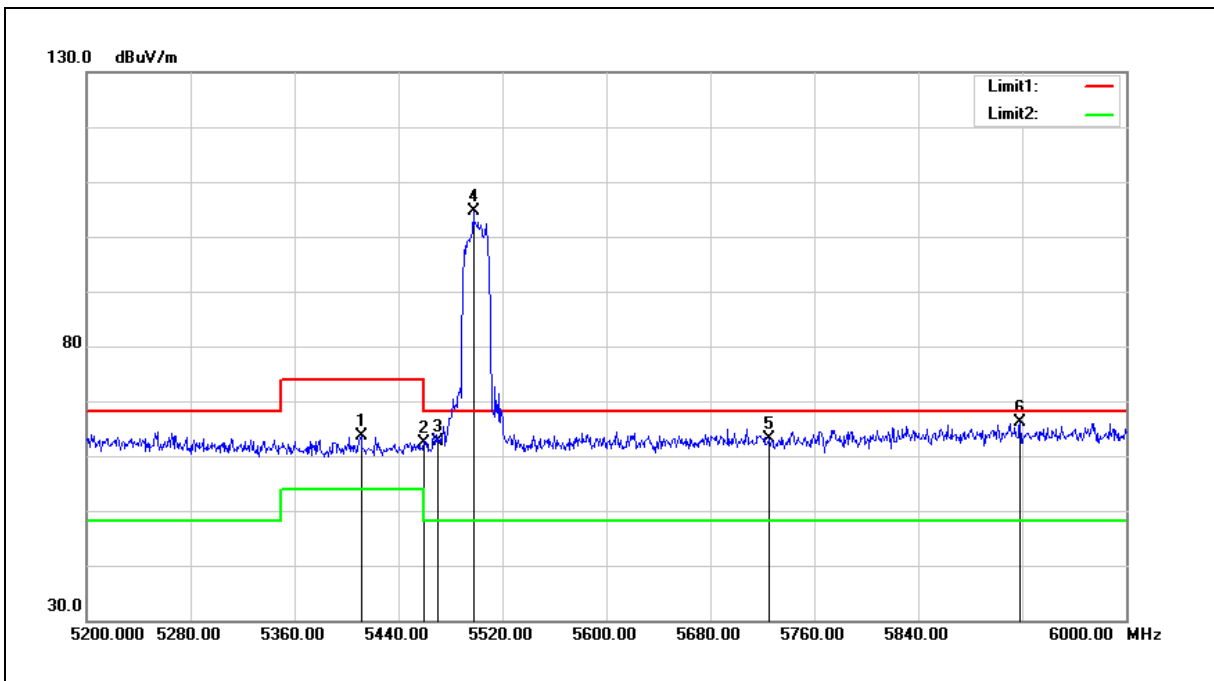

| No. | Frequency (MHz) | Reading (dBuV) | Correct Factor (dB/m) | Result (dBuV/m) | Limit (dBuV/m) | Margin (dB) | Remark |
|-----|-----------------|----------------|-----------------------|-----------------|----------------|-------------|--------|
| 1 | 5411.200 | 58.70 | 4.91 | 63.61 | 74.00 | -10.39 | peak |
| 2 | 5460.000 | 57.41 | 4.97 | 62.38 | 74.00 | -11.62 | peak |
| 3 | 5470.000 | 57.59 | 4.98 | 62.57 | 68.20 | -5.63 | peak |
| 4 | 5497.600 | 99.52 | 5.01 | 104.53 | -- | -- | peak |
| 5 | 5725.000 | 57.54 | 5.47 | 63.01 | 68.20 | -5.19 | peak |
| 6 | 5918.400 | 60.34 | 5.86 | 66.20 | 68.20 | -2.00 | peak |

Note:1.Result (dBuV/m) = Correct Factor (dB/m) + Reading(dBuV).

2.Correction factor (dB/m) = Antenna Factor (dB/m) + Cable loss (dB) – Pre-Amplifier gain (dB).

3.When the peak results are less than average limit, so not need to evaluate the average.



| | | | |
|-------------|-----------------|----------------|-----|
| Standard: | FCC Part 15.407 | Test Distance: | 3 m |
| Test item: | Band edge | | |
| Frequency: | 5500 MHz | | |
| Mode: | Mode 8 | | |
| Ant.Polar.: | Vertical | | |

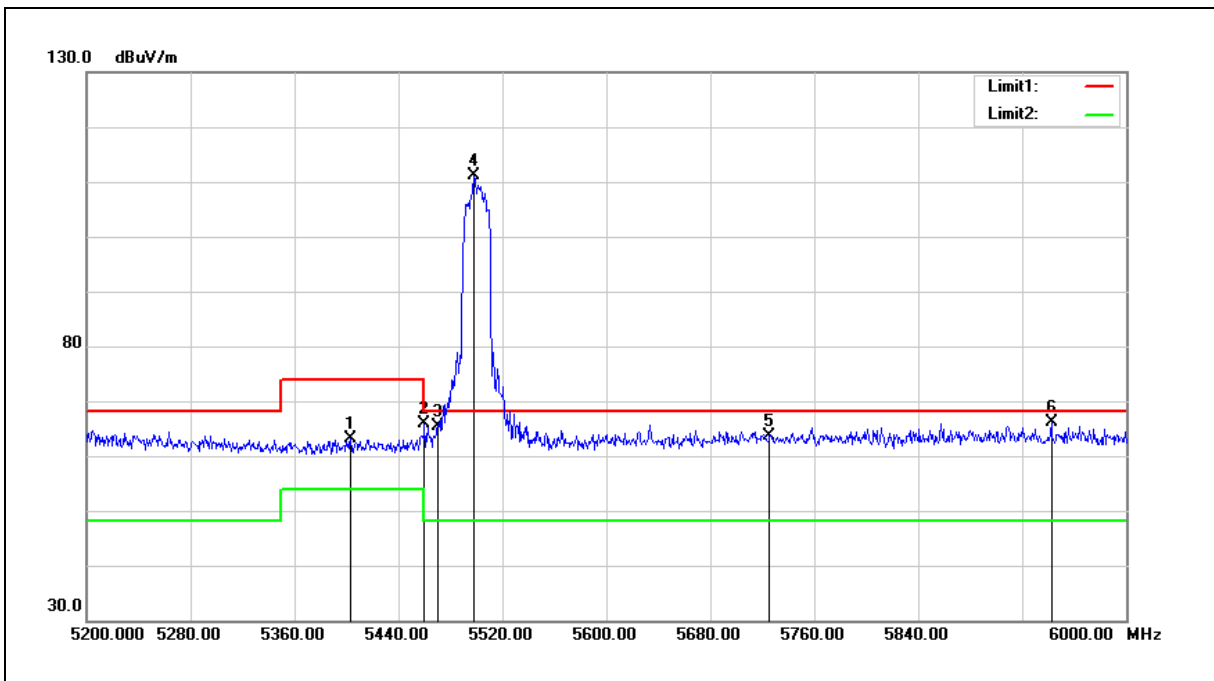

| No. | Frequency (MHz) | Reading (dBuV) | Correct Factor (dB/m) | Result (dBuV/m) | Limit (dBuV/m) | Margin (dB) | Remark |
|-----|-----------------|----------------|-----------------------|-----------------|----------------|-------------|--------|
| 1 | 5403.200 | 58.14 | 4.90 | 63.04 | 74.00 | -10.96 | peak |
| 2 | 5460.000 | 60.92 | 4.97 | 65.89 | 74.00 | -8.11 | peak |
| 3 | 5470.000 | 60.31 | 4.98 | 65.29 | 68.20 | -2.91 | peak |
| 4 | 5498.400 | 106.08 | 5.01 | 111.09 | -- | -- | peak |
| 5 | 5725.000 | 58.11 | 5.47 | 63.58 | 68.20 | -4.62 | peak |
| 6 | 5942.400 | 60.18 | 5.91 | 66.09 | 68.20 | -2.11 | peak |

Note:1.Result (dBuV/m) = Correct Factor (dB/m) + Reading(dBuV).

2.Correction factor (dB/m) = Antenna Factor (dB/m) + Cable loss (dB) – Pre-Amplifier gain (dB).

3.When the peak results are less than average limit, so not need to evaluate the average.



| | | | |
|-------------|-----------------|----------------|-----|
| Standard: | FCC Part 15.407 | Test Distance: | 3 m |
| Test item: | Band edge | | |
| Frequency: | 5560 MHz | | |
| Mode: | Mode 8 | | |
| Ant.Polar.: | Horizontal | | |

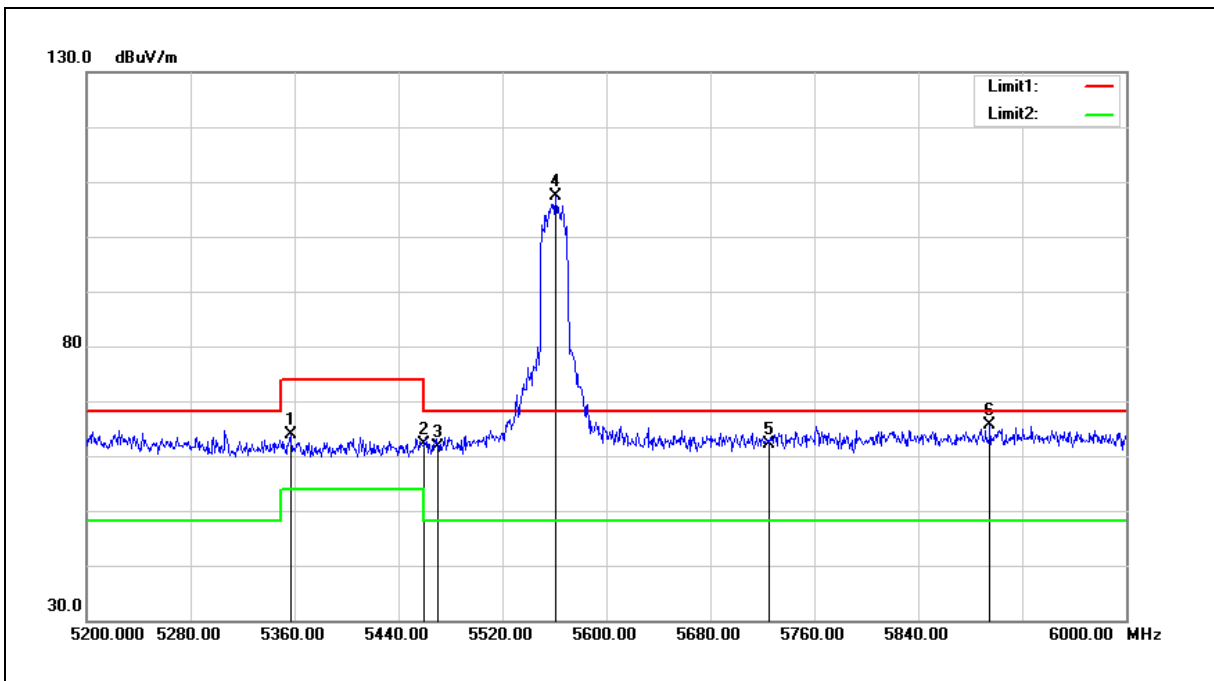

| No. | Frequency (MHz) | Reading (dBuV) | Correct Factor (dB/m) | Result (dBuV/m) | Limit (dBuV/m) | Margin (dB) | Remark |
|-----|-----------------|----------------|-----------------------|-----------------|----------------|-------------|--------|
| 1 | 5356.800 | 58.93 | 4.85 | 63.78 | 74.00 | -10.22 | peak |
| 2 | 5460.000 | 57.13 | 4.97 | 62.10 | 74.00 | -11.90 | peak |
| 3 | 5470.000 | 56.67 | 4.98 | 61.65 | 68.20 | -6.55 | peak |
| 4 | 5560.800 | 102.27 | 5.14 | 107.41 | -- | -- | peak |
| 5 | 5725.000 | 56.77 | 5.47 | 62.24 | 68.20 | -5.96 | peak |
| 6 | 5895.200 | 59.93 | 5.80 | 65.73 | 68.20 | -2.47 | peak |

Note:1.Result (dBuV/m) = Correct Factor (dB/m) + Reading(dBuV).

2.Correction factor (dB/m) = Antenna Factor (dB/m) + Cable loss (dB) – Pre-Amplifier gain (dB).

3.When the peak results are less than average limit, so not need to evaluate the average.



| | | | |
|-------------|-----------------|----------------|-----|
| Standard: | FCC Part 15.407 | Test Distance: | 3 m |
| Test item: | Band edge | | |
| Frequency: | 5560 MHz | | |
| Mode: | Mode 8 | | |
| Ant.Polar.: | Vertical | | |

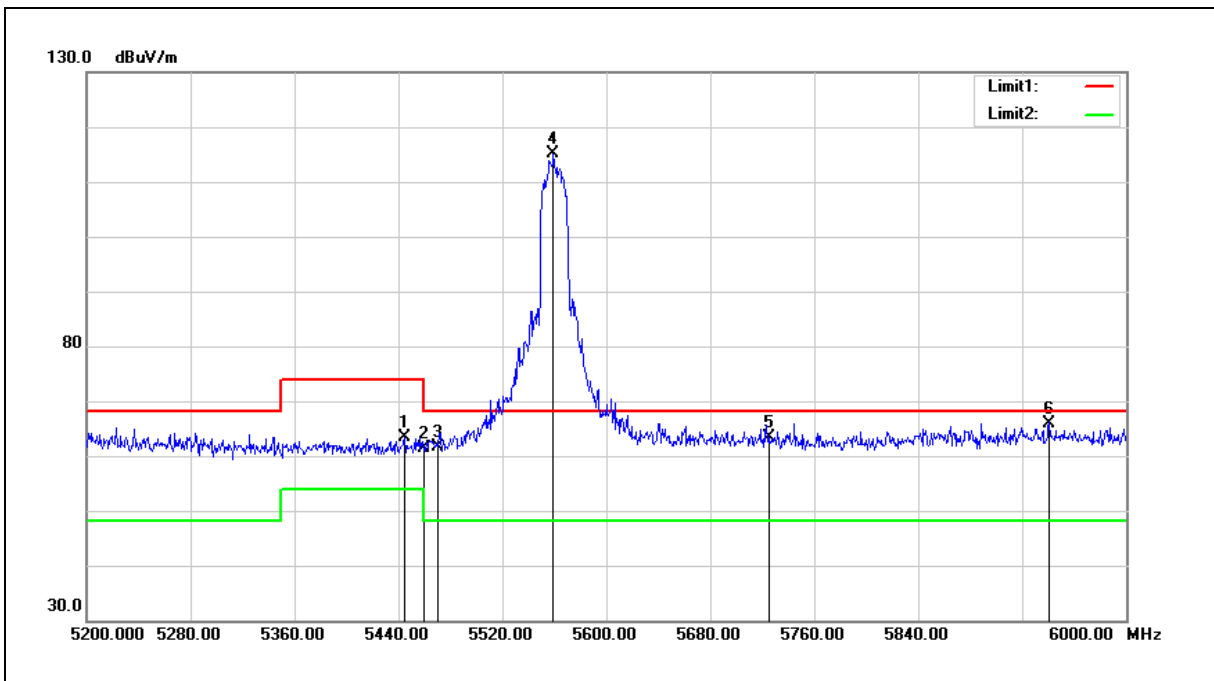

| No. | Frequency (MHz) | Reading (dBuV) | Correct Factor (dB/m) | Result (dBuV/m) | Limit (dBuV/m) | Margin (dB) | Remark |
|-----|-----------------|----------------|-----------------------|-----------------|----------------|-------------|--------|
| 1 | 5444.800 | 58.43 | 4.95 | 63.38 | 74.00 | -10.62 | peak |
| 2 | 5460.000 | 56.45 | 4.97 | 61.42 | 74.00 | -12.58 | peak |
| 3 | 5470.000 | 56.75 | 4.98 | 61.73 | 68.20 | -6.47 | peak |
| 4 | 5559.200 | 110.01 | 5.13 | 115.14 | -- | -- | peak |
| 5 | 5725.000 | 57.81 | 5.47 | 63.28 | 68.20 | -4.92 | peak |
| 6 | 5940.800 | 60.09 | 5.91 | 66.00 | 68.20 | -2.20 | peak |

Note:1.Result (dBuV/m) = Correct Factor (dB/m) + Reading(dBuV).

2.Correction factor (dB/m) = Antenna Factor (dB/m) + Cable loss (dB) – Pre-Amplifier gain (dB).

3.When the peak results are less than average limit, so not need to evaluate the average.



| | | | |
|-------------|-----------------|----------------|-----|
| Standard: | FCC Part 15.407 | Test Distance: | 3 m |
| Test item: | Band edge | | |
| Frequency: | 5700 MHz | | |
| Mode: | Mode 8 | | |
| Ant.Polar.: | Horizontal | | |

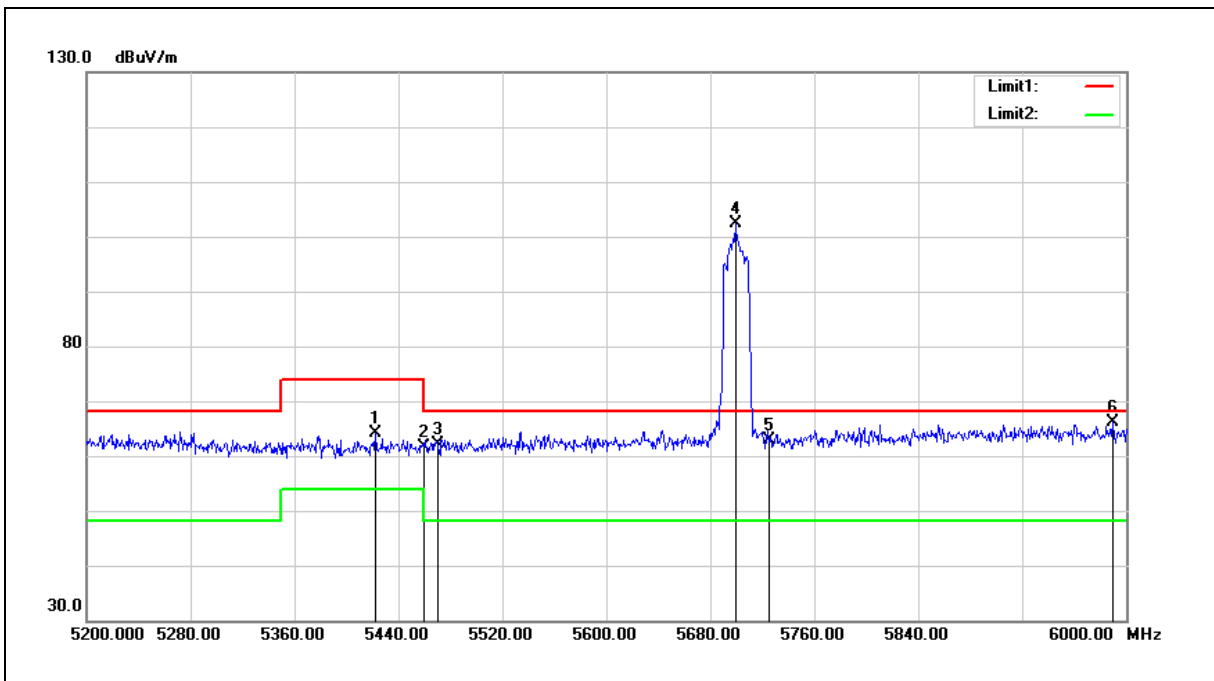

| No. | Frequency (MHz) | Reading (dBuV) | Correct Factor (dB/m) | Result (dBuV/m) | Limit (dBuV/m) | Margin (dB) | Remark |
|-----|-----------------|----------------|-----------------------|-----------------|----------------|-------------|--------|
| 1 | 5422.400 | 59.14 | 4.92 | 64.06 | 74.00 | -9.94 | peak |
| 2 | 5460.000 | 56.73 | 4.97 | 61.70 | 74.00 | -12.30 | peak |
| 3 | 5470.000 | 57.13 | 4.98 | 62.11 | 68.20 | -6.09 | peak |
| 4 | 5699.200 | 96.92 | 5.41 | 102.33 | -- | -- | peak |
| 5 | 5725.000 | 57.29 | 5.47 | 62.76 | 68.20 | -5.44 | peak |
| 6 | 5989.600 | 60.07 | 6.00 | 66.07 | 68.20 | -2.13 | peak |

Note:1.Result (dBuV/m) = Correct Factor (dB/m) + Reading(dBuV).

2.Correction factor (dB/m) = Antenna Factor (dB/m) + Cable loss (dB) – Pre-Amplifier gain (dB).

3.When the peak results are less than average limit, so not need to evaluate the average.



| | | | |
|-------------|-----------------|----------------|-----|
| Standard: | FCC Part 15.407 | Test Distance: | 3 m |
| Test item: | Band edge | | |
| Frequency: | 5700 MHz | | |
| Mode: | Mode 8 | | |
| Ant.Polar.: | Vertical | | |

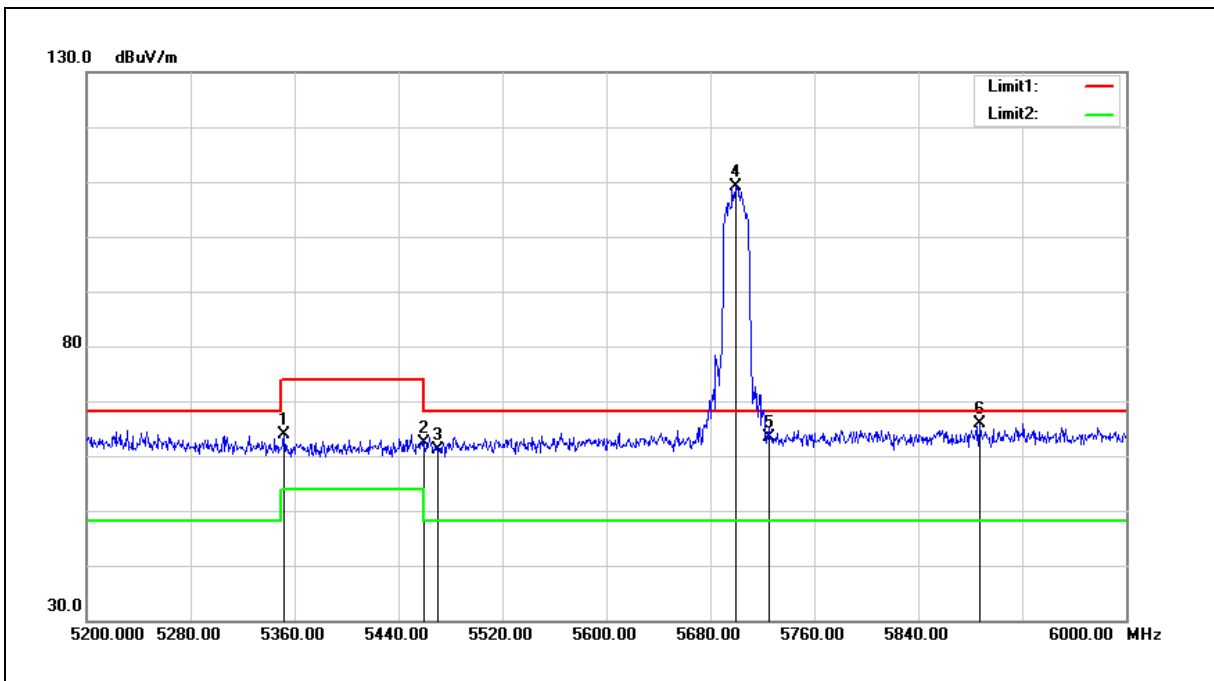

| No. | Frequency (MHz) | Reading (dBuV) | Correct Factor (dB/m) | Result (dBuV/m) | Limit (dBuV/m) | Margin (dB) | Remark |
|-----|-----------------|----------------|-----------------------|-----------------|----------------|-------------|--------|
| 1 | 5352.000 | 59.00 | 4.84 | 63.84 | 74.00 | -10.16 | peak |
| 2 | 5460.000 | 57.30 | 4.97 | 62.27 | 74.00 | -11.73 | peak |
| 3 | 5470.000 | 56.22 | 4.98 | 61.20 | 68.20 | -7.00 | peak |
| 4 | 5700.000 | 103.82 | 5.42 | 109.24 | -- | -- | peak |
| 5 | 5725.000 | 57.89 | 5.47 | 63.36 | 68.20 | -4.84 | peak |
| 6 | 5887.200 | 60.10 | 5.78 | 65.88 | 68.20 | -2.32 | peak |

Note:1.Result (dBuV/m) = Correct Factor (dB/m) + Reading(dBuV).

2.Correction factor (dB/m) = Antenna Factor (dB/m) + Cable loss (dB) – Pre-Amplifier gain (dB).

3.When the peak results are less than average limit, so not need to evaluate the average.



| | | | |
|-------------|-----------------|----------------|-----|
| Standard: | FCC Part 15.407 | Test Distance: | 3 m |
| Test item: | Band edge | | |
| Frequency: | 5720 MHz | | |
| Mode: | Mode 8 | | |
| Ant.Polar.: | Horizontal | | |

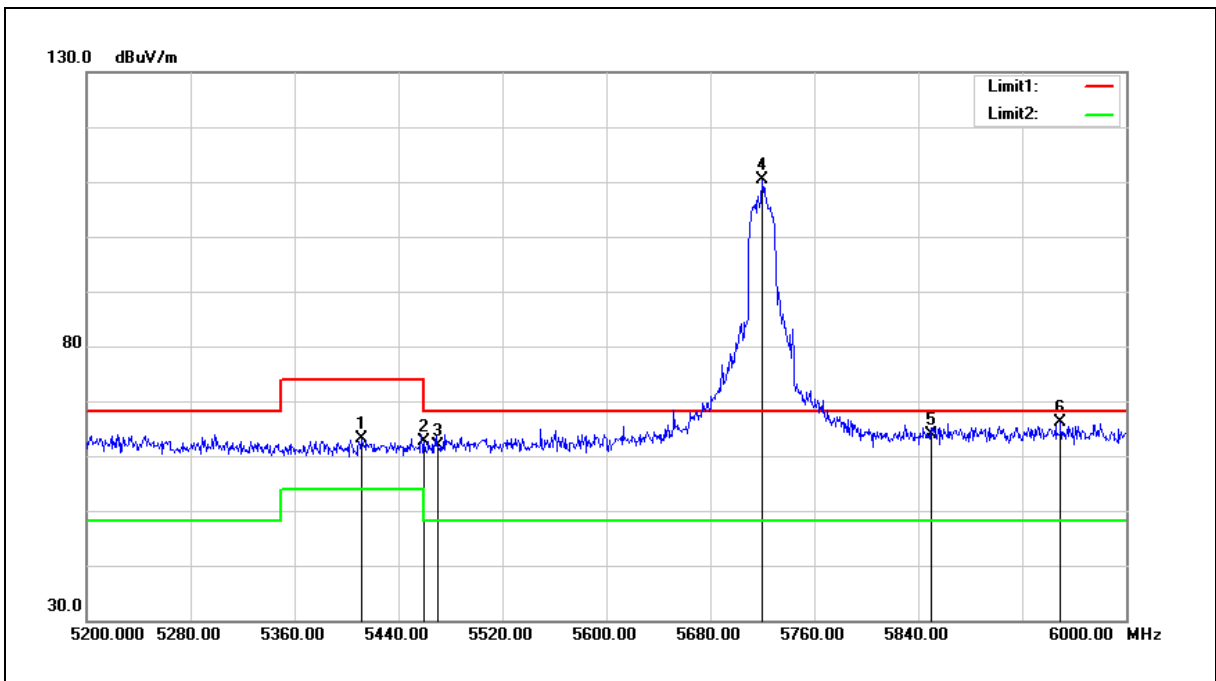

| No. | Frequency (MHz) | Reading (dBuV) | Correct Factor (dB/m) | Result (dBuV/m) | Limit (dBuV/m) | Margin (dB) | Remark |
|-----|-----------------|----------------|-----------------------|-----------------|----------------|-------------|--------|
| 1 | 5412.000 | 58.31 | 4.91 | 63.22 | 74.00 | -10.78 | peak |
| 2 | 5460.000 | 57.68 | 4.97 | 62.65 | 74.00 | -11.35 | peak |
| 3 | 5470.000 | 56.97 | 4.98 | 61.95 | 68.20 | -6.25 | peak |
| 4 | 5720.000 | 105.03 | 5.46 | 110.49 | -- | -- | peak |
| 5 | 5850.000 | 58.18 | 5.72 | 63.90 | 68.20 | -4.30 | peak |
| 6 | 5949.600 | 60.11 | 5.92 | 66.03 | 68.20 | -2.17 | peak |

Note:1.Result (dBuV/m) = Correct Factor (dB/m) + Reading(dBuV).

2.Correction factor (dB/m) = Antenna Factor (dB/m) + Cable loss (dB) – Pre-Amplifier gain (dB).

3.When the peak results are less than average limit, so not need to evaluate the average.



| | | | |
|-------------|-----------------|----------------|-----|
| Standard: | FCC Part 15.407 | Test Distance: | 3 m |
| Test item: | Band edge | | |
| Frequency: | 5720 MHz | | |
| Mode: | Mode 8 | | |
| Ant.Polar.: | Vertical | | |

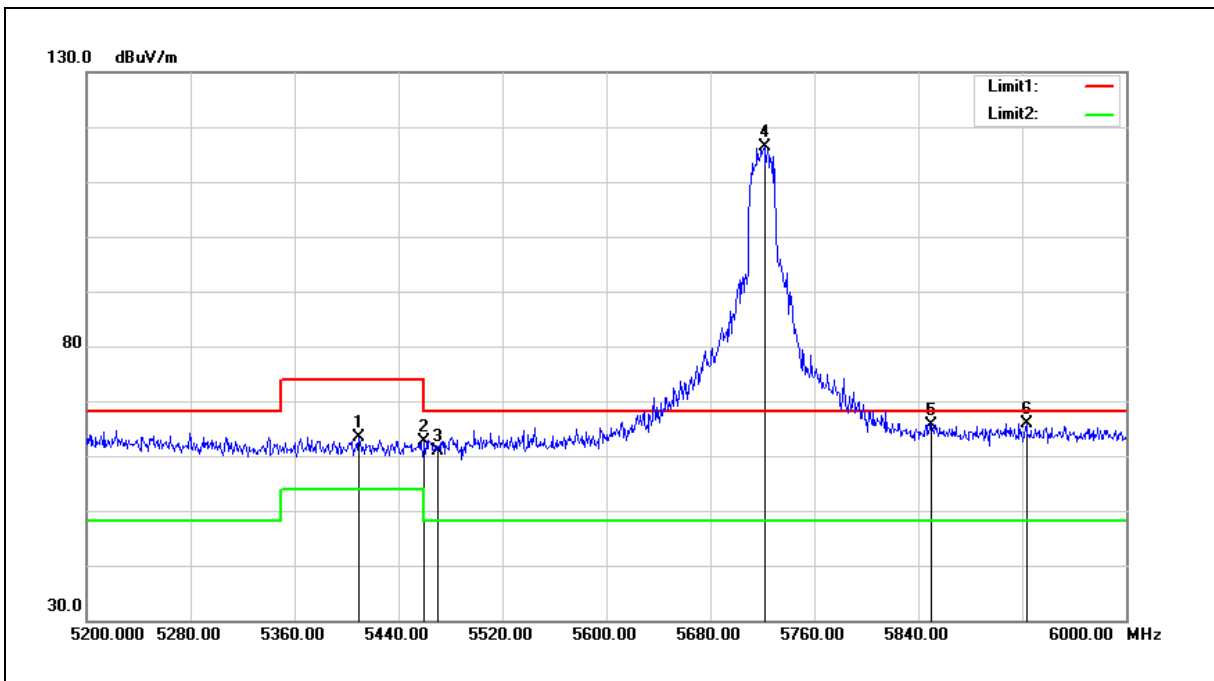

| No. | Frequency (MHz) | Reading (dBuV) | Correct Factor (dB/m) | Result (dBuV/m) | Limit (dBuV/m) | Margin (dB) | Remark |
|-----|-----------------|----------------|-----------------------|-----------------|----------------|-------------|--------|
| 1 | 5409.600 | 58.58 | 4.91 | 63.49 | 74.00 | -10.51 | peak |
| 2 | 5460.000 | 57.61 | 4.97 | 62.58 | 74.00 | -11.42 | peak |
| 3 | 5470.000 | 55.99 | 4.98 | 60.97 | 68.20 | -7.23 | peak |
| 4 | 5721.600 | 111.01 | 5.47 | 116.48 | -- | -- | peak |
| 5 | 5850.000 | 59.80 | 5.72 | 65.52 | 68.20 | -2.68 | peak |
| 6 | 5923.200 | 59.94 | 5.87 | 65.81 | 68.20 | -2.39 | peak |

Note:1.Result (dBuV/m) = Correct Factor (dB/m) + Reading(dBuV).

2.Correction factor (dB/m) = Antenna Factor (dB/m) + Cable loss (dB) – Pre-Amplifier gain (dB).

3.When the peak results are less than average limit, so not need to evaluate the average.



| | | | |
|-------------|-----------------|----------------|-----|
| Standard: | FCC Part 15.407 | Test Distance: | 3 m |
| Test item: | Band edge | | |
| Frequency: | 5745 MHz | | |
| Mode: | Mode 8 | | |
| Ant.Polar.: | Horizontal | | |

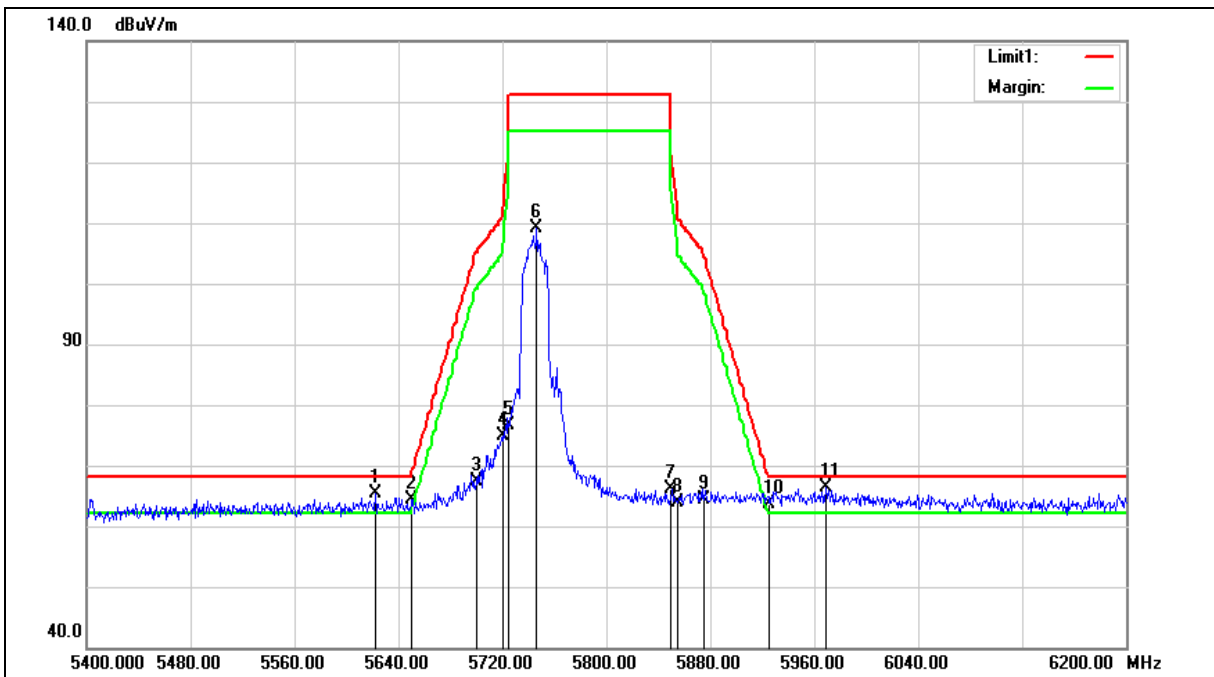



| | | | |
|-------------|-----------------|----------------|-----|
| Standard: | FCC Part 15.407 | Test Distance: | 3 m |
| Test item: | Band edge | | |
| Frequency: | 5745 MHz | | |
| Mode: | Mode 8 | | |
| Ant.Polar.: | Horizontal | | |

| No. | Frequency (MHz) | Reading (dBuV) | Correct Factor (dB/m) | Result (dBuV/m) | Limit (dBuV/m) | Margin (dB) | Remark |
|-----|-----------------|----------------|-----------------------|-----------------|----------------|-------------|--------|
| 1 | 5622.400 | 60.00 | 5.26 | 65.26 | 68.20 | -2.94 | peak |
| 2 | 5650.000 | 59.08 | 5.31 | 64.39 | 68.20 | -3.81 | peak |
| 3 | 5700.000 | 62.02 | 5.42 | 67.44 | 105.20 | -37.76 | peak |
| 4 | 5720.000 | 69.39 | 5.46 | 74.85 | 110.80 | -35.95 | peak |
| 5 | 5725.000 | 71.10 | 5.47 | 76.57 | 122.20 | -45.63 | peak |
| 6 | 5746.400 | 103.66 | 5.52 | 109.18 | -- | -- | peak |
| 7 | 5850.000 | 60.53 | 5.72 | 66.25 | 122.20 | -55.95 | peak |
| 8 | 5855.000 | 58.16 | 5.73 | 63.89 | 110.80 | -46.91 | peak |
| 9 | 5875.000 | 58.70 | 5.77 | 64.47 | 105.20 | -40.73 | peak |
| 10 | 5925.000 | 57.88 | 5.87 | 63.75 | 68.20 | -4.45 | peak |
| 11 | 5968.800 | 60.53 | 5.96 | 66.49 | 68.20 | -1.71 | peak |

Note:1.Result (dBuV/m) = Correct Factor (dB/m) + Reading(dBuV).

2.Correction factor (dB/m) = Antenna Factor (dB/m) + Cable loss (dB) – Pre-Amplifier gain (dB).

3.When the peak results are less than average limit, so not need to evaluate the average.



| | | | |
|-------------|-----------------|----------------|-----|
| Standard: | FCC Part 15.407 | Test Distance: | 3 m |
| Test item: | Band edge | | |
| Frequency: | 5745 MHz | | |
| Mode: | Mode 8 | | |
| Ant.Polar.: | Vertical | | |

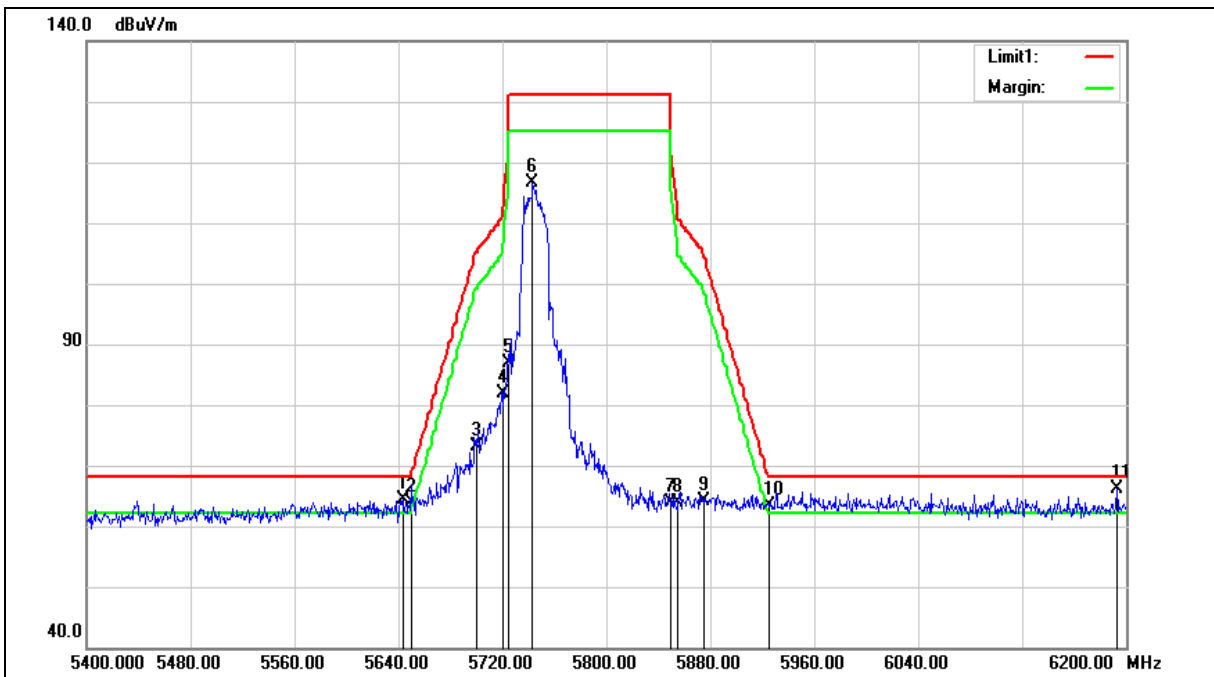



| | | | |
|-------------|-----------------|----------------|-----|
| Standard: | FCC Part 15.407 | Test Distance: | 3 m |
| Test item: | Band edge | | |
| Frequency: | 5745 MHz | | |
| Mode: | Mode 8 | | |
| Ant.Polar.: | Vertical | | |

| No. | Frequency (MHz) | Reading (dBuV) | Correct Factor (dB/m) | Result (dBuV/m) | Limit (dBuV/m) | Margin (dB) | Remark |
|-----|-----------------|----------------|-----------------------|-----------------|----------------|-------------|--------|
| 1 | 5644.000 | 59.16 | 5.30 | 64.46 | 68.20 | -3.74 | peak |
| 2 | 5650.000 | 58.68 | 5.31 | 63.99 | 68.20 | -4.21 | peak |
| 3 | 5700.000 | 67.74 | 5.42 | 73.16 | 105.20 | -32.04 | peak |
| 4 | 5720.000 | 76.46 | 5.46 | 81.92 | 110.80 | -28.88 | peak |
| 5 | 5725.000 | 81.36 | 5.47 | 86.83 | 122.20 | -35.37 | peak |
| 6 | 5743.200 | 111.11 | 5.50 | 116.61 | -- | -- | peak |
| 7 | 5850.000 | 58.15 | 5.72 | 63.87 | 122.20 | -58.33 | peak |
| 8 | 5855.000 | 58.13 | 5.73 | 63.86 | 110.80 | -46.94 | peak |
| 9 | 5875.000 | 58.45 | 5.77 | 64.22 | 105.20 | -40.98 | peak |
| 10 | 5925.000 | 57.49 | 5.87 | 63.36 | 68.20 | -4.84 | peak |
| 11 | 6192.800 | 59.34 | 6.70 | 66.04 | 68.20 | -2.16 | peak |

Note:1.Result (dBuV/m) = Correct Factor (dB/m) + Reading(dBuV).

2.Correction factor (dB/m) = Antenna Factor (dB/m) + Cable loss (dB) – Pre-Amplifier gain (dB).

3.When the peak results are less than average limit, so not need to evaluate the average.



| | | | |
|-------------|-----------------|----------------|-----|
| Standard: | FCC Part 15.407 | Test Distance: | 3 m |
| Test item: | Band edge | | |
| Frequency: | 5785 MHz | | |
| Mode: | Mode 8 | | |
| Ant.Polar.: | Horizontal | | |

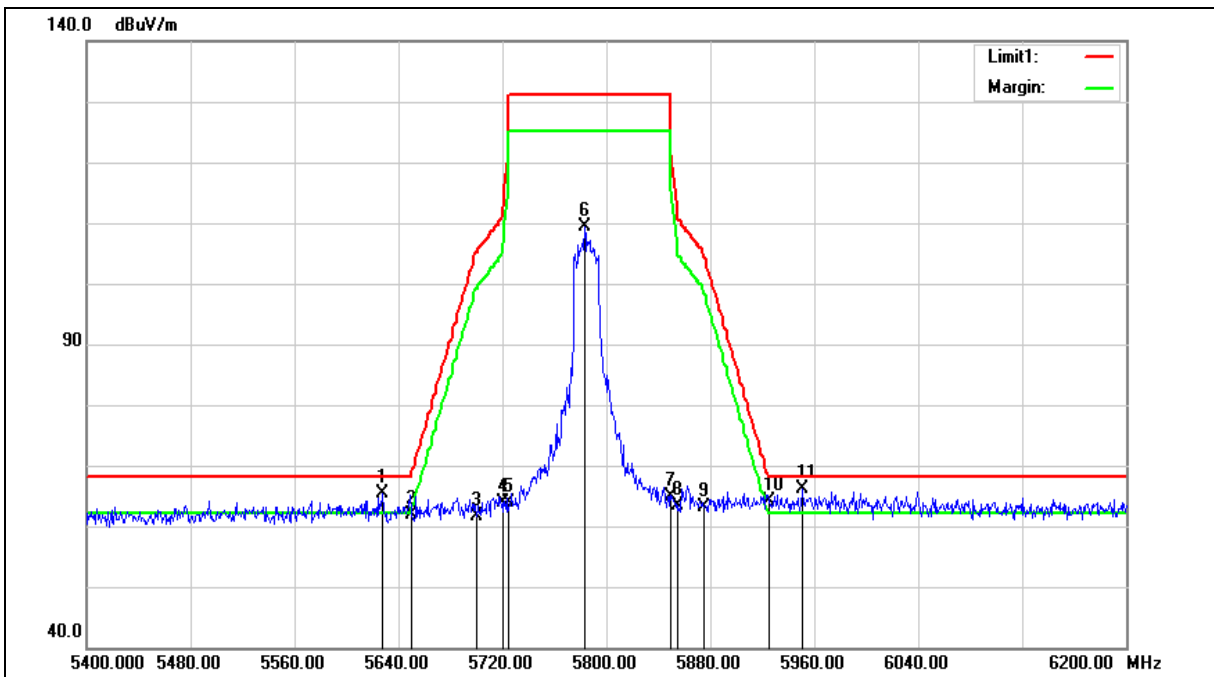



| | | | |
|-------------|-----------------|----------------|-----|
| Standard: | FCC Part 15.407 | Test Distance: | 3 m |
| Test item: | Band edge | | |
| Frequency: | 5785 MHz | | |
| Mode: | Mode 8 | | |
| Ant.Polar.: | Horizontal | | |

| No. | Frequency (MHz) | Reading (dBuV) | Correct Factor (dB/m) | Result (dBuV/m) | Limit (dBuV/m) | Margin (dB) | Remark |
|-----|-----------------|----------------|-----------------------|-----------------|----------------|-------------|--------|
| 1 | 5628.000 | 60.14 | 5.27 | 65.41 | 68.20 | -2.79 | peak |
| 2 | 5650.000 | 56.51 | 5.31 | 61.82 | 68.20 | -6.38 | peak |
| 3 | 5700.000 | 56.20 | 5.42 | 61.62 | 105.20 | -43.58 | peak |
| 4 | 5720.000 | 58.31 | 5.46 | 63.77 | 110.80 | -47.03 | peak |
| 5 | 5725.000 | 58.30 | 5.47 | 63.77 | 122.20 | -58.43 | peak |
| 6 | 5783.200 | 103.75 | 5.59 | 109.34 | -- | -- | peak |
| 7 | 5850.000 | 59.06 | 5.72 | 64.78 | 122.20 | -57.42 | peak |
| 8 | 5855.000 | 57.71 | 5.73 | 63.44 | 110.80 | -47.36 | peak |
| 9 | 5875.000 | 57.39 | 5.77 | 63.16 | 105.20 | -42.04 | peak |
| 10 | 5925.000 | 58.22 | 5.87 | 64.09 | 68.20 | -4.11 | peak |
| 11 | 5951.200 | 60.19 | 5.92 | 66.11 | 68.20 | -2.09 | peak |

Note:1.Result (dBuV/m) = Correct Factor (dB/m) + Reading(dBuV).

2.Correction factor (dB/m) = Antenna Factor (dB/m) + Cable loss (dB) – Pre-Amplifier gain (dB).

3.When the peak results are less than average limit, so not need to evaluate the average.



| | | | |
|-------------|-----------------|----------------|-----|
| Standard: | FCC Part 15.407 | Test Distance: | 3 m |
| Test item: | Band edge | | |
| Frequency: | 5785 MHz | | |
| Mode: | Mode 8 | | |
| Ant.Polar.: | Vertical | | |

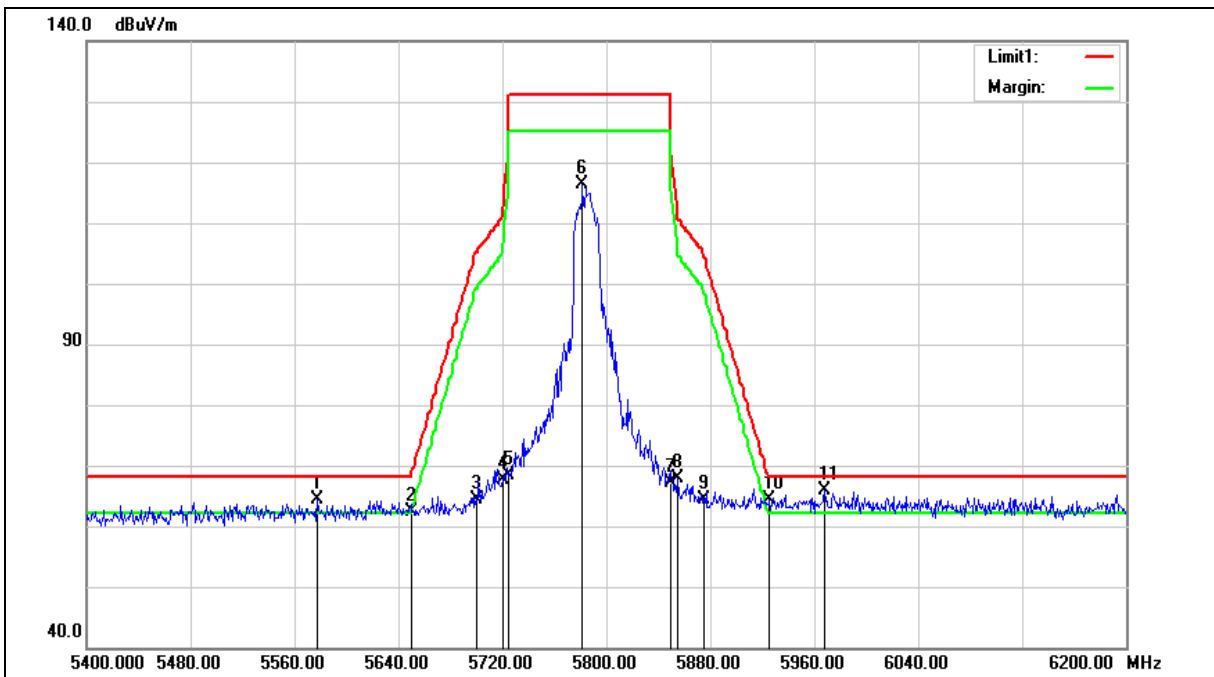



| | | | |
|-------------|-----------------|----------------|-----|
| Standard: | FCC Part 15.407 | Test Distance: | 3 m |
| Test item: | Band edge | | |
| Frequency: | 5785 MHz | | |
| Mode: | Mode 8 | | |
| Ant.Polar.: | Vertical | | |

| No. | Frequency (MHz) | Reading (dBuV) | Correct Factor (dB/m) | Result (dBuV/m) | Limit (dBuV/m) | Margin (dB) | Remark |
|-----|-----------------|----------------|-----------------------|-----------------|----------------|-------------|--------|
| 1 | 5577.600 | 59.18 | 5.17 | 64.35 | 68.20 | -3.85 | peak |
| 2 | 5650.000 | 56.95 | 5.31 | 62.26 | 68.20 | -5.94 | peak |
| 3 | 5700.000 | 58.91 | 5.42 | 64.33 | 105.20 | -40.87 | peak |
| 4 | 5720.000 | 62.17 | 5.46 | 67.63 | 110.80 | -43.17 | peak |
| 5 | 5725.000 | 62.89 | 5.47 | 68.36 | 122.20 | -53.84 | peak |
| 6 | 5781.600 | 110.69 | 5.58 | 116.27 | -- | -- | peak |
| 7 | 5850.000 | 61.30 | 5.72 | 67.02 | 122.20 | -55.18 | peak |
| 8 | 5855.000 | 62.12 | 5.73 | 67.85 | 110.80 | -42.95 | peak |
| 9 | 5875.000 | 58.60 | 5.77 | 64.37 | 105.20 | -40.83 | peak |
| 10 | 5925.000 | 58.58 | 5.87 | 64.45 | 68.20 | -3.75 | peak |
| 11 | 5968.000 | 59.81 | 5.96 | 65.77 | 68.20 | -2.43 | peak |

Note:1.Result (dBuV/m) = Correct Factor (dB/m) + Reading(dBuV).

2.Correction factor (dB/m) = Antenna Factor (dB/m) + Cable loss (dB) – Pre-Amplifier gain (dB).

3.When the peak results are less than average limit, so not need to evaluate the average.



| | | | |
|-------------|-----------------|----------------|-----|
| Standard: | FCC Part 15.407 | Test Distance: | 3 m |
| Test item: | Band edge | | |
| Frequency: | 5825 MHz | | |
| Mode: | Mode 8 | | |
| Ant.Polar.: | Horizontal | | |

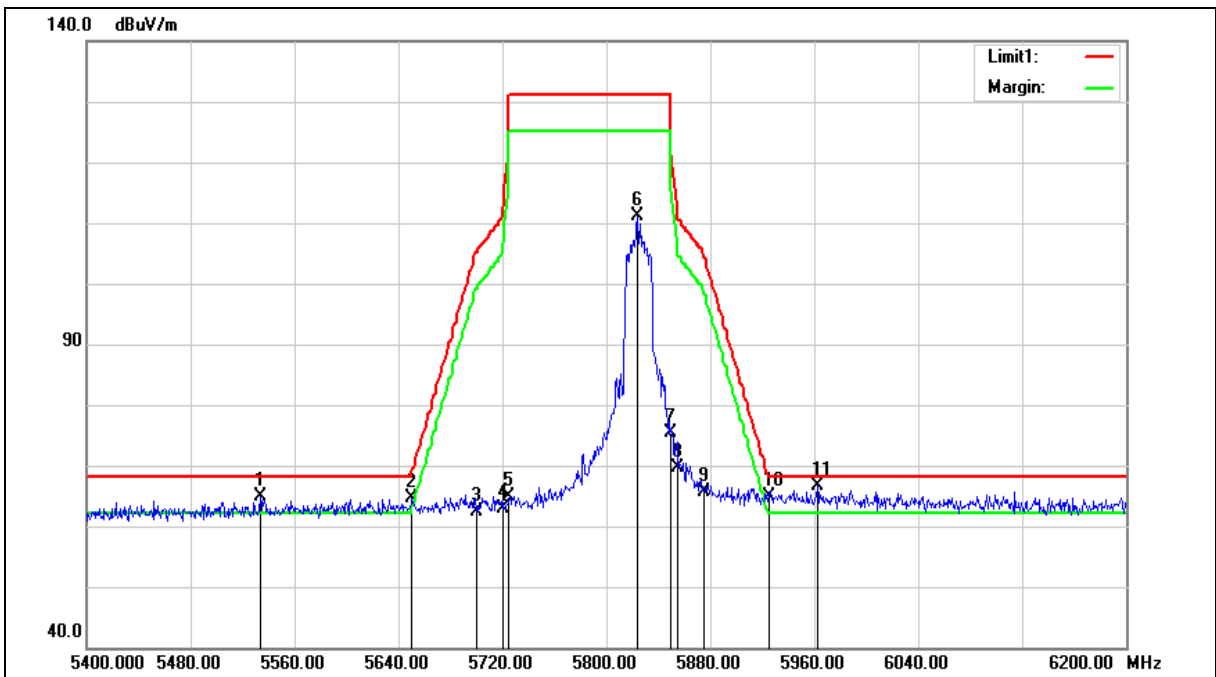



| | | | |
|-------------|-----------------|----------------|-----|
| Standard: | FCC Part 15.407 | Test Distance: | 3 m |
| Test item: | Band edge | | |
| Frequency: | 5825 MHz | | |
| Mode: | Mode 8 | | |
| Ant.Polar.: | Horizontal | | |

| No. | Frequency (MHz) | Reading (dBuV) | Correct Factor (dB/m) | Result (dBuV/m) | Limit (dBuV/m) | Margin (dB) | Remark |
|-----|-----------------|----------------|-----------------------|-----------------|----------------|-------------|--------|
| 1 | 5533.600 | 59.81 | 5.09 | 64.90 | 68.20 | -3.30 | peak |
| 2 | 5650.000 | 59.21 | 5.31 | 64.52 | 68.20 | -3.68 | peak |
| 3 | 5700.000 | 57.07 | 5.42 | 62.49 | 105.20 | -42.71 | peak |
| 4 | 5720.000 | 57.52 | 5.46 | 62.98 | 110.80 | -47.82 | peak |
| 5 | 5725.000 | 59.42 | 5.47 | 64.89 | 122.20 | -57.31 | peak |
| 6 | 5824.000 | 105.34 | 5.67 | 111.01 | -- | -- | peak |
| 7 | 5850.000 | 69.66 | 5.72 | 75.38 | 122.20 | -46.82 | peak |
| 8 | 5855.000 | 63.79 | 5.73 | 69.52 | 110.80 | -41.28 | peak |
| 9 | 5875.000 | 59.78 | 5.77 | 65.55 | 105.20 | -39.65 | peak |
| 10 | 5925.000 | 59.03 | 5.87 | 64.90 | 68.20 | -3.30 | peak |
| 11 | 5962.400 | 60.57 | 5.94 | 66.51 | 68.20 | -1.69 | peak |

Note:1.Result (dBuV/m) = Correct Factor (dB/m) + Reading(dBuV).

2.Correction factor (dB/m) = Antenna Factor (dB/m) + Cable loss (dB) – Pre-Amplifier gain (dB).

3.When the peak results are less than average limit, so not need to evaluate the average.



| | | | |
|-------------|-----------------|----------------|-----|
| Standard: | FCC Part 15.407 | Test Distance: | 3 m |
| Test item: | Band edge | | |
| Frequency: | 5825 MHz | | |
| Mode: | Mode 8 | | |
| Ant.Polar.: | Vertical | | |

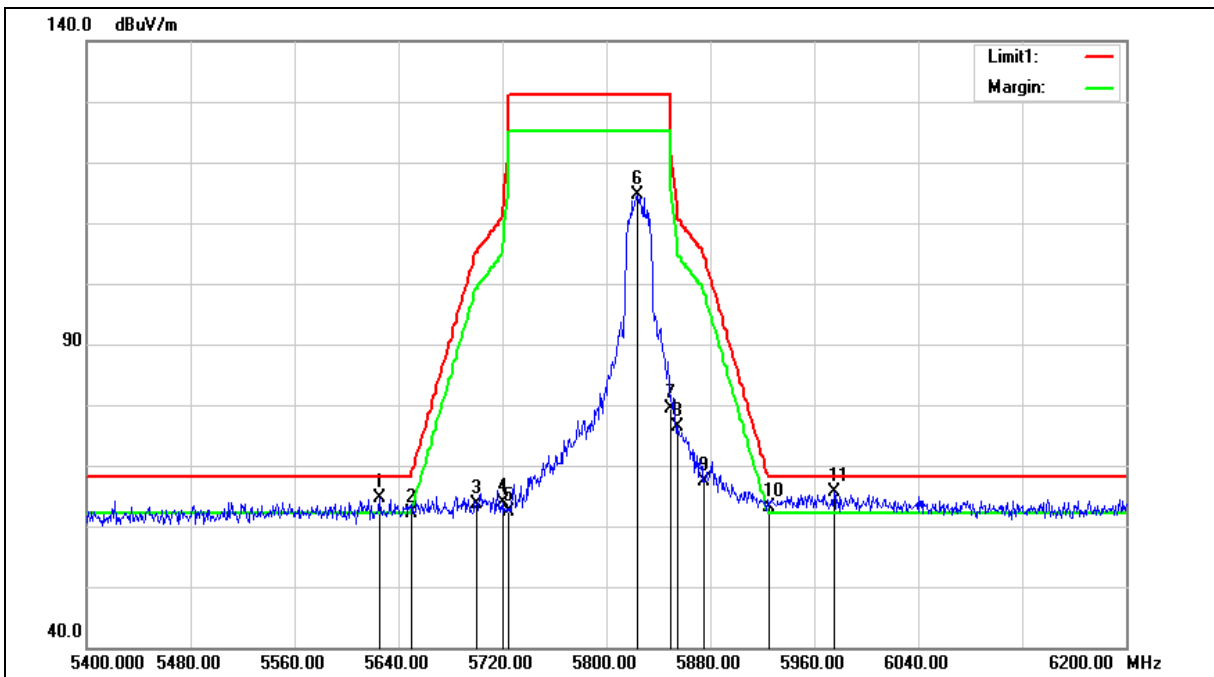



| | | | |
|-------------|-----------------|----------------|-----|
| Standard: | FCC Part 15.407 | Test Distance: | 3 m |
| Test item: | Band edge | | |
| Frequency: | 5825 MHz | | |
| Mode: | Mode 8 | | |
| Ant.Polar.: | Vertical | | |

| No. | Frequency (MHz) | Reading (dBUV) | Correct Factor (dB/m) | Result (dBUV/m) | Limit (dBUV/m) | Margin (dB) | Remark |
|-----|-----------------|----------------|-----------------------|-----------------|----------------|-------------|--------|
| 1 | 5625.600 | 59.32 | 5.27 | 64.59 | 68.20 | -3.61 | peak |
| 2 | 5650.000 | 56.79 | 5.31 | 62.10 | 68.20 | -6.10 | peak |
| 3 | 5700.000 | 58.10 | 5.42 | 63.52 | 105.20 | -41.68 | peak |
| 4 | 5720.000 | 58.36 | 5.46 | 63.82 | 110.80 | -46.98 | peak |
| 5 | 5725.000 | 56.93 | 5.47 | 62.40 | 122.20 | -59.80 | peak |
| 6 | 5824.000 | 109.07 | 5.67 | 114.74 | -- | -- | peak |
| 7 | 5850.000 | 73.69 | 5.72 | 79.41 | 122.20 | -42.79 | peak |
| 8 | 5855.000 | 70.70 | 5.73 | 76.43 | 110.80 | -34.37 | peak |
| 9 | 5875.000 | 61.73 | 5.77 | 67.50 | 105.20 | -37.70 | peak |
| 10 | 5925.000 | 57.38 | 5.87 | 63.25 | 68.20 | -4.95 | peak |
| 11 | 5975.200 | 59.60 | 5.97 | 65.57 | 68.20 | -2.63 | peak |

Note:1.Result (dBUV/m) = Correct Factor (dB/m) + Reading(dBUV).

2.Correction factor (dB/m) = Antenna Factor (dB/m) + Cable loss (dB) – Pre-Amplifier gain (dB).

3.When the peak results are less than average limit, so not need to evaluate the average.



| | | | |
|-------------|-----------------|----------------|-----|
| Standard: | FCC Part 15.407 | Test Distance: | 3 m |
| Test item: | Band edge | | |
| Frequency: | 5190 MHz | | |
| Mode: | Mode 9 | | |
| Ant.Polar.: | Horizontal | | |

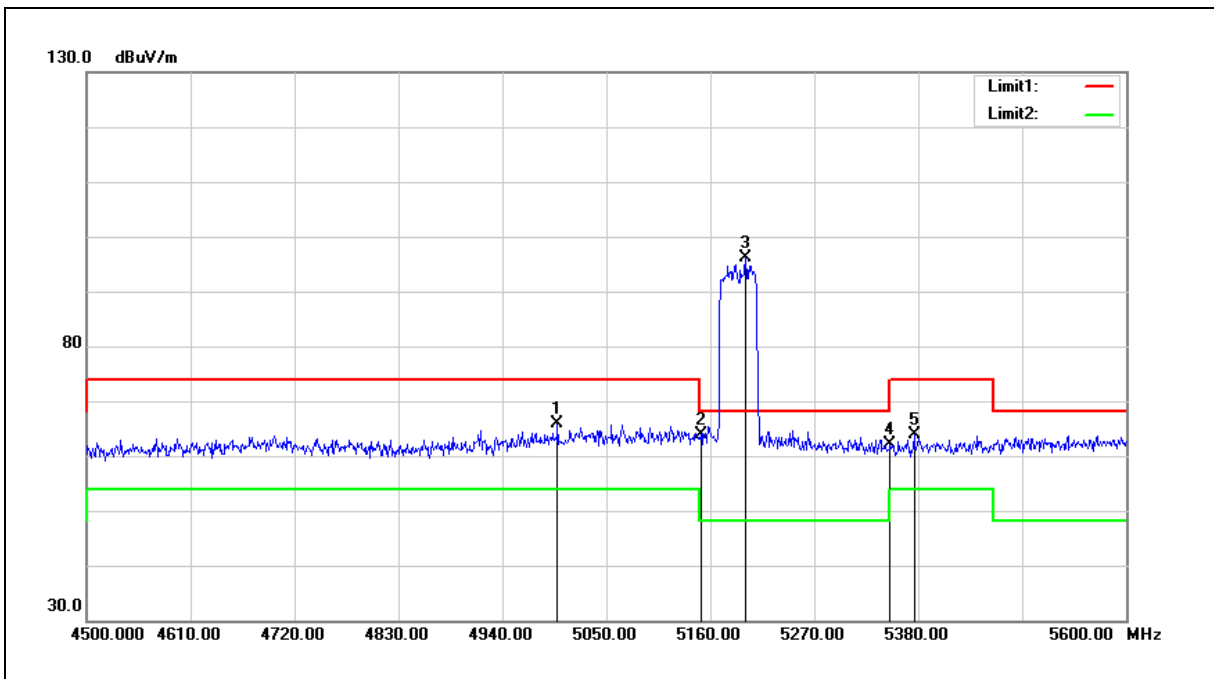

| No. | Frequency (MHz) | Reading (dBuV) | Correct Factor (dB/m) | Result (dBuV/m) | Limit (dBuV/m) | Margin (dB) | Remark |
|-----|-----------------|----------------|-----------------------|-----------------|----------------|-------------|--------|
| 1 | 4998.300 | 61.37 | 4.42 | 65.79 | 74.00 | -8.21 | peak |
| 2 | 5150.000 | 59.22 | 4.60 | 63.82 | 74.00 | -10.18 | peak |
| 3 | 5197.400 | 91.55 | 4.66 | 96.21 | -- | -- | peak |
| 4 | 5350.000 | 57.20 | 4.84 | 62.04 | 74.00 | -11.96 | peak |
| 5 | 5375.600 | 58.94 | 4.87 | 63.81 | 74.00 | -10.19 | peak |

Note:1.Result (dBuV/m) = Correct Factor (dB/m) + Reading(dBuV).

2.Correction factor (dB/m) = Antenna Factor (dB/m) + Cable loss (dB) – Pre-Amplifier gain (dB).

3.When the peak results are less than average limit, so not need to evaluate the average.



| | | | |
|-------------|-----------------|----------------|-----|
| Standard: | FCC Part 15.407 | Test Distance: | 3 m |
| Test item: | Band edge | | |
| Frequency: | 5190 MHz | | |
| Mode: | Mode 9 | | |
| Ant.Polar.: | Vertical | | |

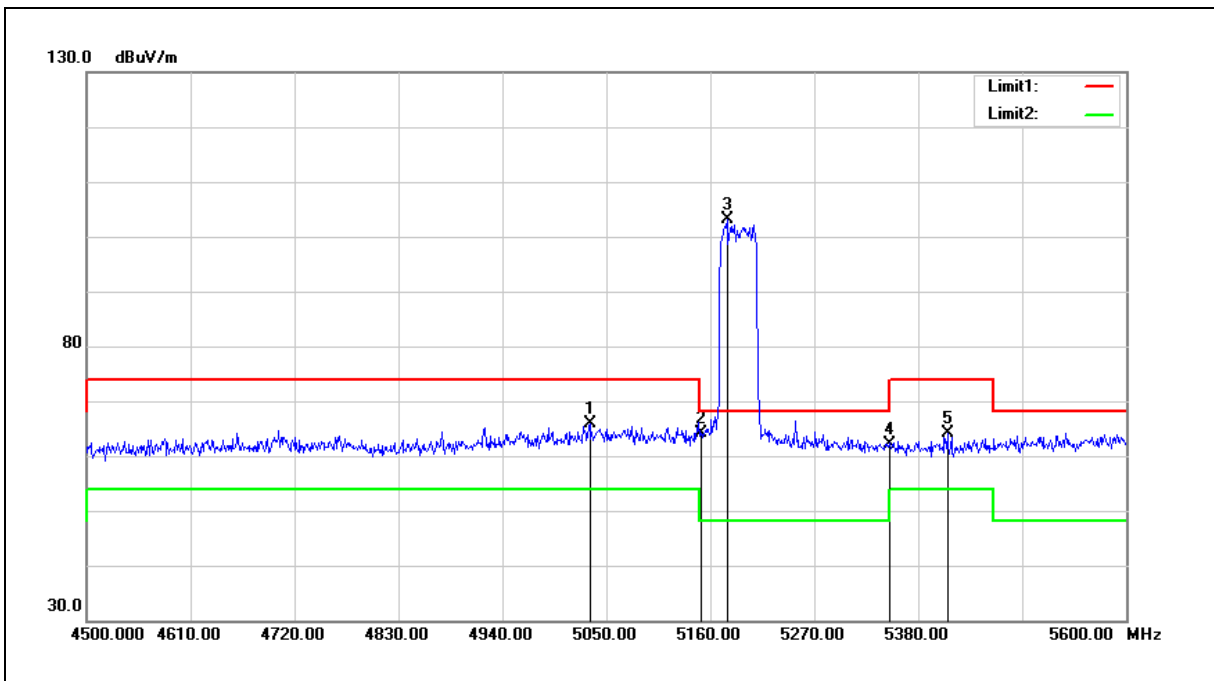

| No. | Frequency (MHz) | Reading (dBuV) | Correct Factor (dB/m) | Result (dBuV/m) | Limit (dBuV/m) | Margin (dB) | Remark |
|-----|-----------------|----------------|-----------------------|-----------------|----------------|-------------|--------|
| 1 | 5032.400 | 61.40 | 4.46 | 65.86 | 74.00 | -8.14 | peak |
| 2 | 5150.000 | 59.55 | 4.60 | 64.15 | 74.00 | -9.85 | peak |
| 3 | 5177.600 | 98.38 | 4.63 | 103.01 | -- | -- | peak |
| 4 | 5350.000 | 57.36 | 4.84 | 62.20 | 74.00 | -11.80 | peak |
| 5 | 5410.800 | 59.10 | 4.91 | 64.01 | 74.00 | -9.99 | peak |

Note:1.Result (dBuV/m) = Correct Factor (dB/m) + Reading(dBuV).

2.Correction factor (dB/m) = Antenna Factor (dB/m) + Cable loss (dB) – Pre-Amplifier gain (dB).

3.When the peak results are less than average limit, so not need to evaluate the average.



| | | | |
|-------------|-----------------|----------------|-----|
| Standard: | FCC Part 15.407 | Test Distance: | 3 m |
| Test item: | Band edge | | |
| Frequency: | 5230 MHz | | |
| Mode: | Mode 9 | | |
| Ant.Polar.: | Horizontal | | |

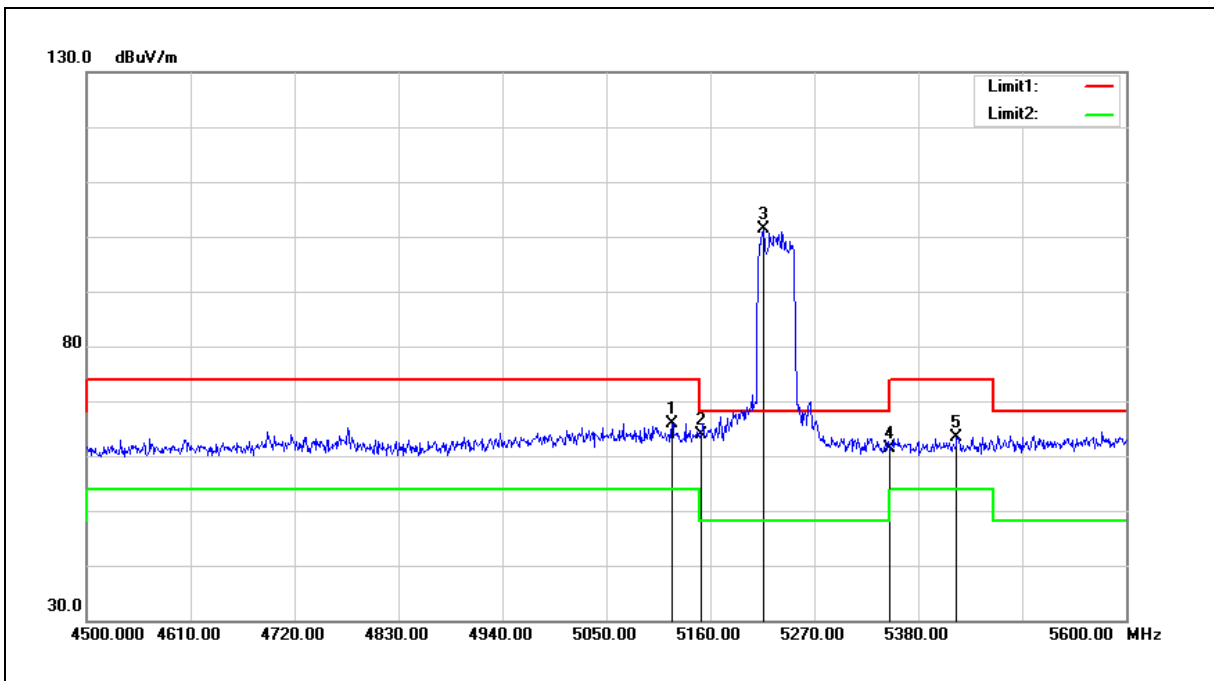

| No. | Frequency (MHz) | Reading (dBuV) | Correct Factor (dB/m) | Result (dBuV/m) | Limit (dBuV/m) | Margin (dB) | Remark |
|-----|-----------------|----------------|-----------------------|-----------------|----------------|-------------|--------|
| 1 | 5119.300 | 61.32 | 4.57 | 65.89 | 74.00 | -8.11 | peak |
| 2 | 5150.000 | 59.23 | 4.60 | 63.83 | 74.00 | -10.17 | peak |
| 3 | 5216.100 | 96.62 | 4.67 | 101.29 | -- | -- | peak |
| 4 | 5350.000 | 56.59 | 4.84 | 61.43 | 74.00 | -12.57 | peak |
| 5 | 5420.700 | 58.57 | 4.92 | 63.49 | 74.00 | -10.51 | peak |

Note:1.Result (dBuV/m) = Correct Factor (dB/m) + Reading(dBuV).

2.Correction factor (dB/m) = Antenna Factor (dB/m) + Cable loss (dB) – Pre-Amplifier gain (dB).

3.When the peak results are less than average limit, so not need to evaluate the average.



| | | | |
|-------------|-----------------|----------------|-----|
| Standard: | FCC Part 15.407 | Test Distance: | 3 m |
| Test item: | Band edge | | |
| Frequency: | 5230 MHz | | |
| Mode: | Mode 9 | | |
| Ant.Polar.: | Vertical | | |

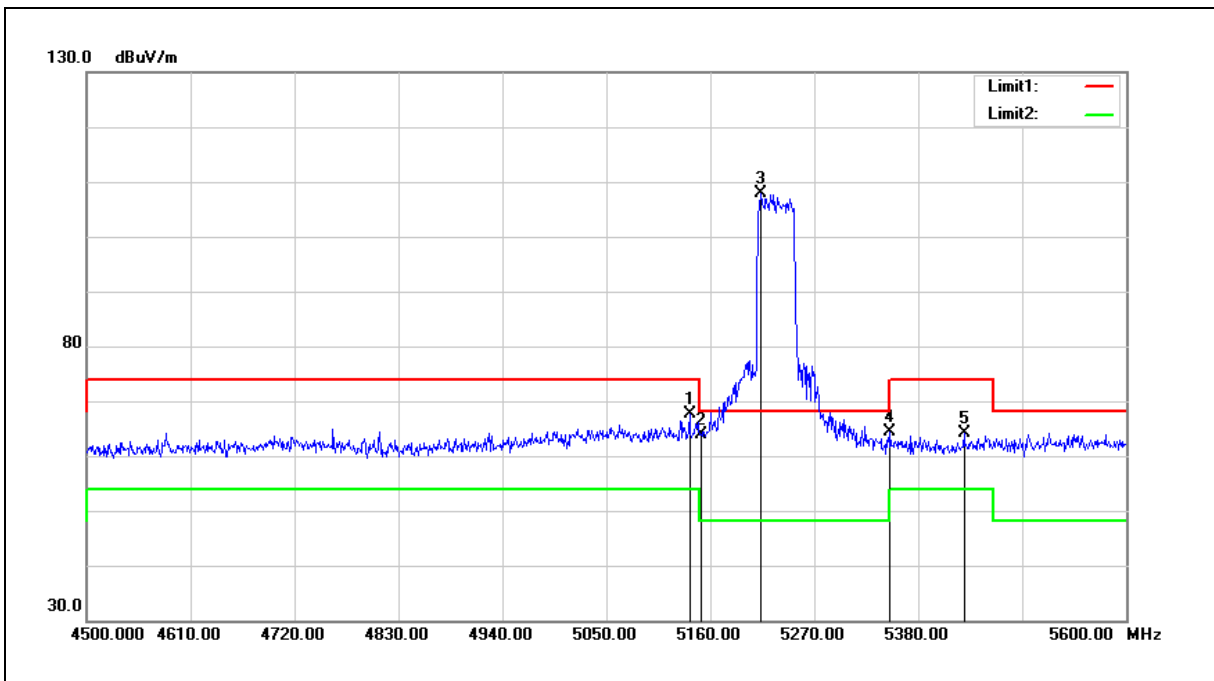

| No. | Frequency (MHz) | Reading (dBuV) | Correct Factor (dB/m) | Result (dBuV/m) | Limit (dBuV/m) | Margin (dB) | Remark |
|-----|-----------------|----------------|-----------------------|-----------------|----------------|-------------|--------|
| 1 | 5138.000 | 63.04 | 4.59 | 67.63 | 74.00 | -6.37 | peak |
| 2 | 5150.000 | 59.31 | 4.60 | 63.91 | 74.00 | -10.09 | peak |
| 3 | 5213.900 | 103.15 | 4.67 | 107.82 | -- | -- | peak |
| 4 | 5350.000 | 59.55 | 4.84 | 64.39 | 74.00 | -9.61 | peak |
| 5 | 5428.400 | 59.24 | 4.93 | 64.17 | 74.00 | -9.83 | peak |

Note:1.Result (dBuV/m) = Correct Factor (dB/m) + Reading(dBuV).

2.Correction factor (dB/m) = Antenna Factor (dB/m) + Cable loss (dB) – Pre-Amplifier gain (dB).

3.When the peak results are less than average limit, so not need to evaluate the average.



| | | | |
|-------------|-----------------|----------------|-----|
| Standard: | FCC Part 15.407 | Test Distance: | 3 m |
| Test item: | Band edge | | |
| Frequency: | 5270 MHz | | |
| Mode: | Mode 9 | | |
| Ant.Polar.: | Horizontal | | |

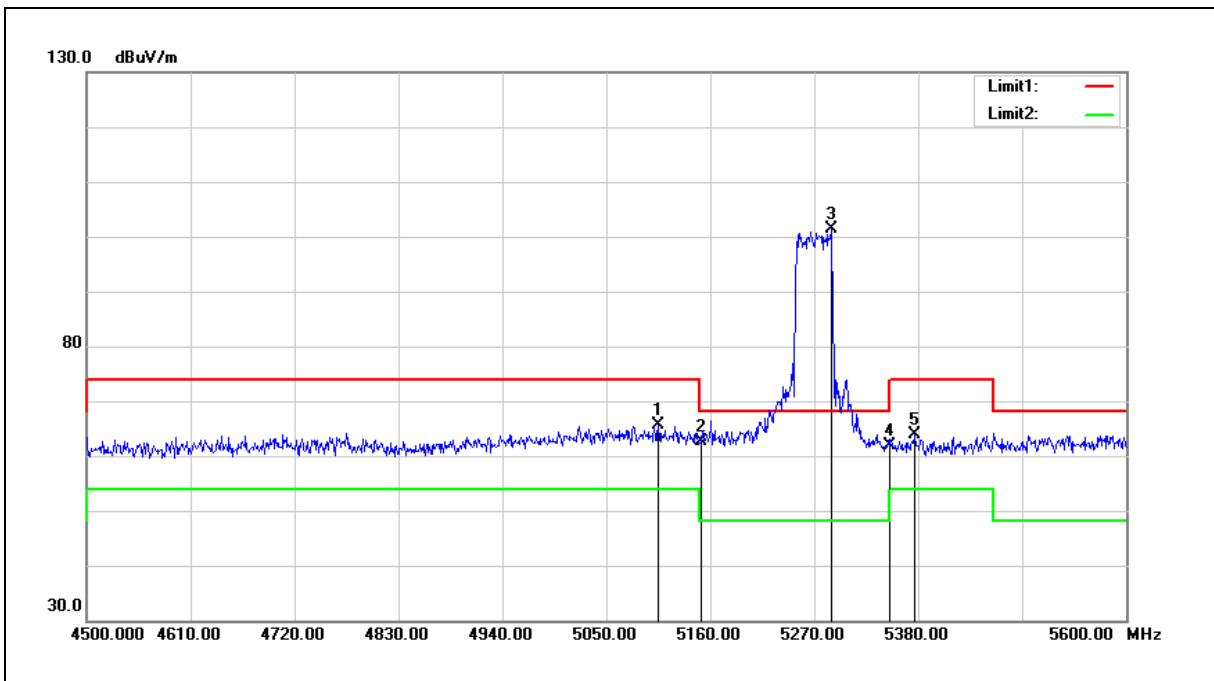

| No. | Frequency (MHz) | Reading (dBuV) | Correct Factor (dB/m) | Result (dBuV/m) | Limit (dBuV/m) | Margin (dB) | Remark |
|-----|-----------------|----------------|-----------------------|-----------------|----------------|-------------|--------|
| 1 | 5105.000 | 61.18 | 4.55 | 65.73 | 74.00 | -8.27 | peak |
| 2 | 5150.000 | 58.10 | 4.60 | 62.70 | 74.00 | -11.30 | peak |
| 3 | 5287.600 | 96.55 | 4.76 | 101.31 | -- | -- | peak |
| 4 | 5350.000 | 56.99 | 4.84 | 61.83 | 74.00 | -12.17 | peak |
| 5 | 5376.700 | 58.93 | 4.87 | 63.80 | 74.00 | -10.20 | peak |

Note:1.Result (dBuV/m) = Correct Factor (dB/m) + Reading(dBuV).

2.Correction factor (dB/m) = Antenna Factor (dB/m) + Cable loss (dB) – Pre-Amplifier gain (dB).

3.When the peak results are less than average limit, so not need to evaluate the average.

| | | | |
|-------------|-----------------|----------------|-----|
| Standard: | FCC Part 15.407 | Test Distance: | 3 m |
| Test item: | Band edge | | |
| Frequency: | 5270 MHz | | |
| Mode: | Mode 9 | | |
| Ant.Polar.: | Vertical | | |

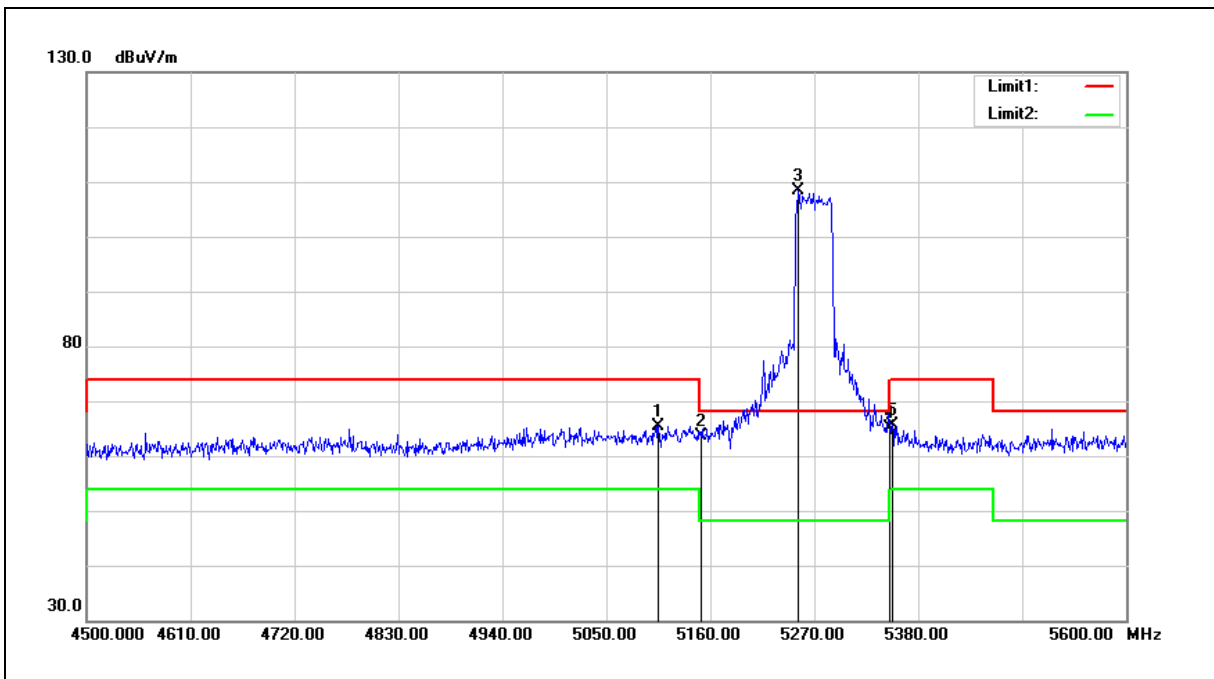

| No. | Frequency (MHz) | Reading (dBuV) | Correct Factor (dB/m) | Result (dBuV/m) | Limit (dBuV/m) | Margin (dB) | Remark |
|-----|-----------------|----------------|-----------------------|-----------------|----------------|-------------|--------|
| 1 | 5105.000 | 60.93 | 4.55 | 65.48 | 74.00 | -8.52 | peak |
| 2 | 5150.000 | 58.92 | 4.60 | 63.52 | 74.00 | -10.48 | peak |
| 3 | 5253.500 | 103.65 | 4.72 | 108.37 | -- | -- | peak |
| 4 | 5350.000 | 60.39 | 4.84 | 65.23 | 74.00 | -8.77 | peak |
| 5 | 5352.500 | 60.83 | 4.84 | 65.67 | 74.00 | -8.33 | peak |

Note:1.Result (dBuV/m) = Correct Factor (dB/m) + Reading(dBuV).

2.Correction factor (dB/m) = Antenna Factor (dB/m) + Cable loss (dB) – Pre-Amplifier gain (dB).

3.When the peak results are less than average limit, so not need to evaluate the average.



| | | | |
|-------------|-----------------|----------------|-----|
| Standard: | FCC Part 15.407 | Test Distance: | 3 m |
| Test item: | Band edge | | |
| Frequency: | 5310 MHz | | |
| Mode: | Mode 9 | | |
| Ant.Polar.: | Horizontal | | |

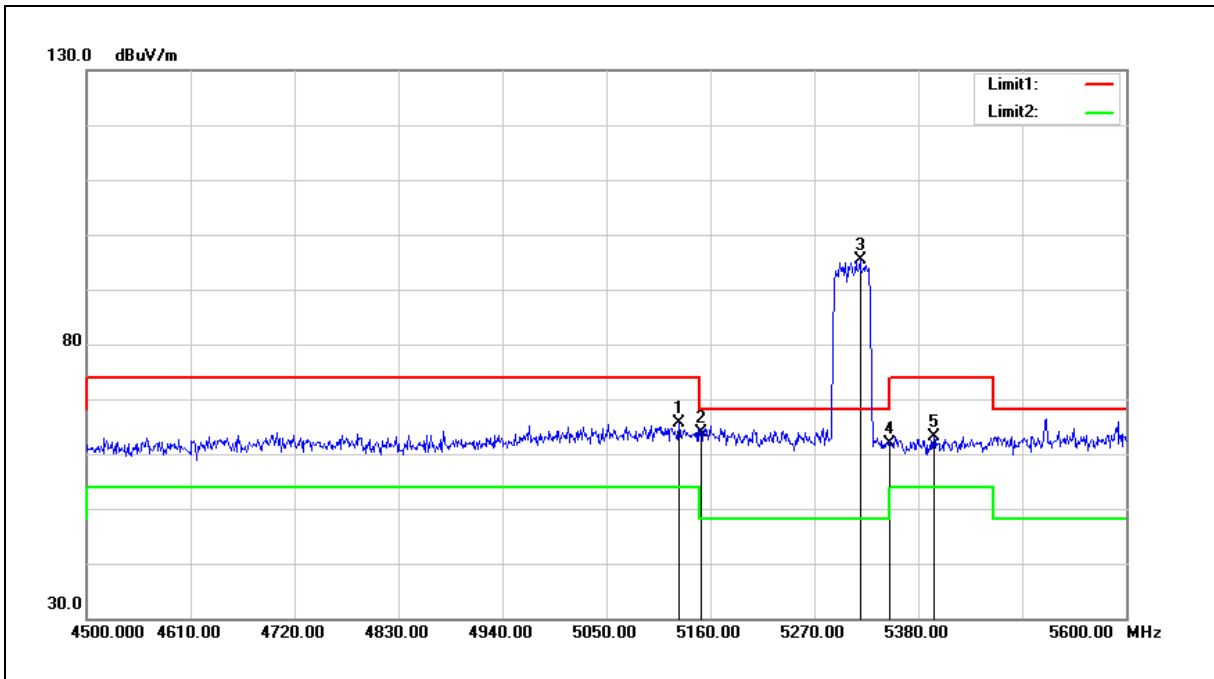

| No. | Frequency (MHz) | Reading (dBuV) | Correct Factor (dB/m) | Result (dBuV/m) | Limit (dBuV/m) | Margin (dB) | Remark |
|-----|-----------------|----------------|-----------------------|-----------------|----------------|-------------|--------|
| 1 | 5127.000 | 61.10 | 4.57 | 65.67 | 74.00 | -8.33 | peak |
| 2 | 5150.000 | 59.22 | 4.60 | 63.82 | 74.00 | -10.18 | peak |
| 3 | 5318.400 | 90.52 | 4.80 | 95.32 | -- | -- | peak |
| 4 | 5350.000 | 56.98 | 4.84 | 61.82 | 74.00 | -12.18 | peak |
| 5 | 5396.500 | 58.34 | 4.89 | 63.23 | 74.00 | -10.77 | peak |

Note:1.Result (dBuV/m) = Correct Factor (dB/m) + Reading(dBuV).

2.Correction factor (dB/m) = Antenna Factor (dB/m) + Cable loss (dB) – Pre-Amplifier gain (dB).

3.When the peak results are less than average limit, so not need to evaluate the average.



| | | | |
|-------------|-----------------|----------------|-----|
| Standard: | FCC Part 15.407 | Test Distance: | 3 m |
| Test item: | Band edge | | |
| Frequency: | 5310 MHz | | |
| Mode: | Mode 9 | | |
| Ant.Polar.: | Vertical | | |

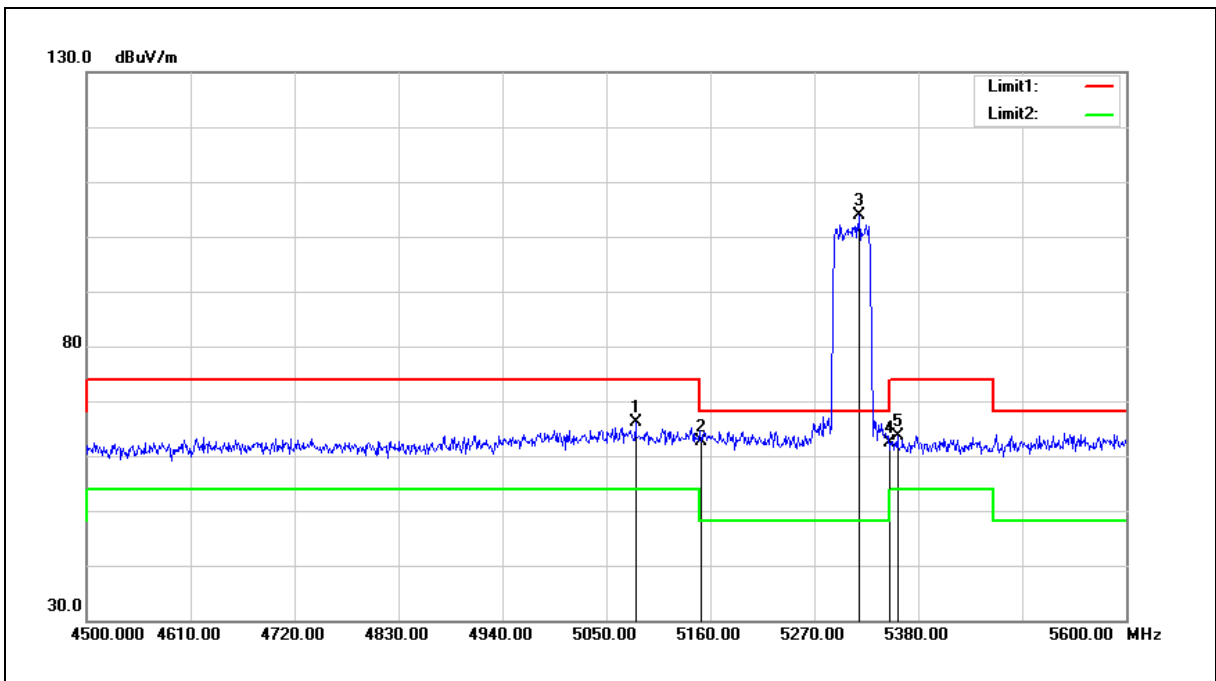

| No. | Frequency (MHz) | Reading (dBuV) | Correct Factor (dB/m) | Result (dBuV/m) | Limit (dBuV/m) | Margin (dB) | Remark |
|-----|-----------------|----------------|-----------------------|-----------------|----------------|-------------|--------|
| 1 | 5080.800 | 61.57 | 4.51 | 66.08 | 74.00 | -7.92 | peak |
| 2 | 5150.000 | 58.03 | 4.60 | 62.63 | 74.00 | -11.37 | peak |
| 3 | 5317.300 | 98.98 | 4.80 | 103.78 | -- | -- | peak |
| 4 | 5350.000 | 57.57 | 4.84 | 62.41 | 74.00 | -11.59 | peak |
| 5 | 5358.000 | 58.83 | 4.85 | 63.68 | 74.00 | -10.32 | peak |

Note:1.Result (dBuV/m) = Correct Factor (dB/m) + Reading(dBuV).

2.Correction factor (dB/m) = Antenna Factor (dB/m) + Cable loss (dB) – Pre-Amplifier gain (dB).

3.When the peak results are less than average limit, so not need to evaluate the average.



| | | | |
|-------------|-----------------|----------------|-----|
| Standard: | FCC Part 15.407 | Test Distance: | 3 m |
| Test item: | Band edge | | |
| Frequency: | 5510 MHz | | |
| Mode: | Mode 9 | | |
| Ant.Polar.: | Horizontal | | |

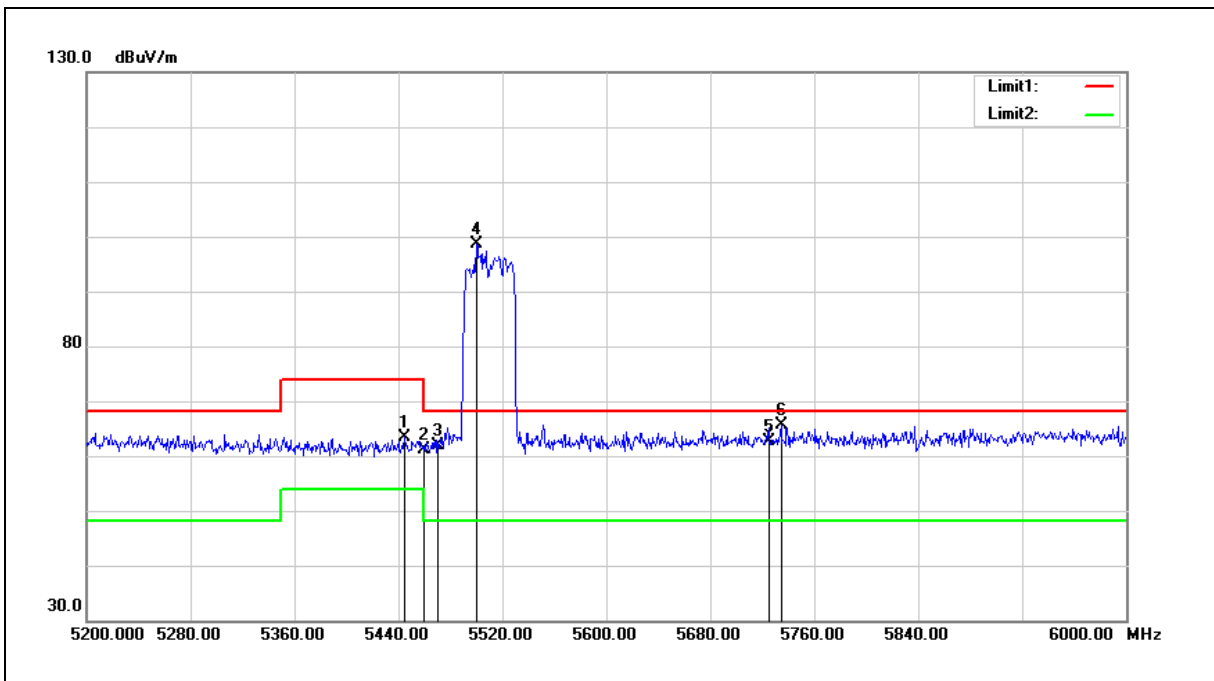

| No. | Frequency (MHz) | Reading (dBuV) | Correct Factor (dB/m) | Result (dBuV/m) | Limit (dBuV/m) | Margin (dB) | Remark |
|-----|-----------------|----------------|-----------------------|-----------------|----------------|-------------|--------|
| 1 | 5444.800 | 58.42 | 4.95 | 63.37 | 74.00 | -10.63 | peak |
| 2 | 5460.000 | 56.11 | 4.97 | 61.08 | 74.00 | -12.92 | peak |
| 3 | 5470.000 | 56.97 | 4.98 | 61.95 | 68.20 | -6.25 | peak |
| 4 | 5500.000 | 93.72 | 5.02 | 98.74 | -- | -- | peak |
| 5 | 5725.000 | 57.20 | 5.47 | 62.67 | 68.20 | -5.53 | peak |
| 6 | 5734.400 | 60.04 | 5.49 | 65.53 | 68.20 | -2.67 | peak |

Note:1.Result (dBuV/m) = Correct Factor (dB/m) + Reading(dBuV).

2.Correction factor (dB/m) = Antenna Factor (dB/m) + Cable loss (dB) – Pre-Amplifier gain (dB).

3.When the peak results are less than average limit, so not need to evaluate the average.



| | | | |
|-------------|-----------------|----------------|-----|
| Standard: | FCC Part 15.407 | Test Distance: | 3 m |
| Test item: | Band edge | | |
| Frequency: | 5510 MHz | | |
| Mode: | Mode 9 | | |
| Ant.Polar.: | Vertical | | |

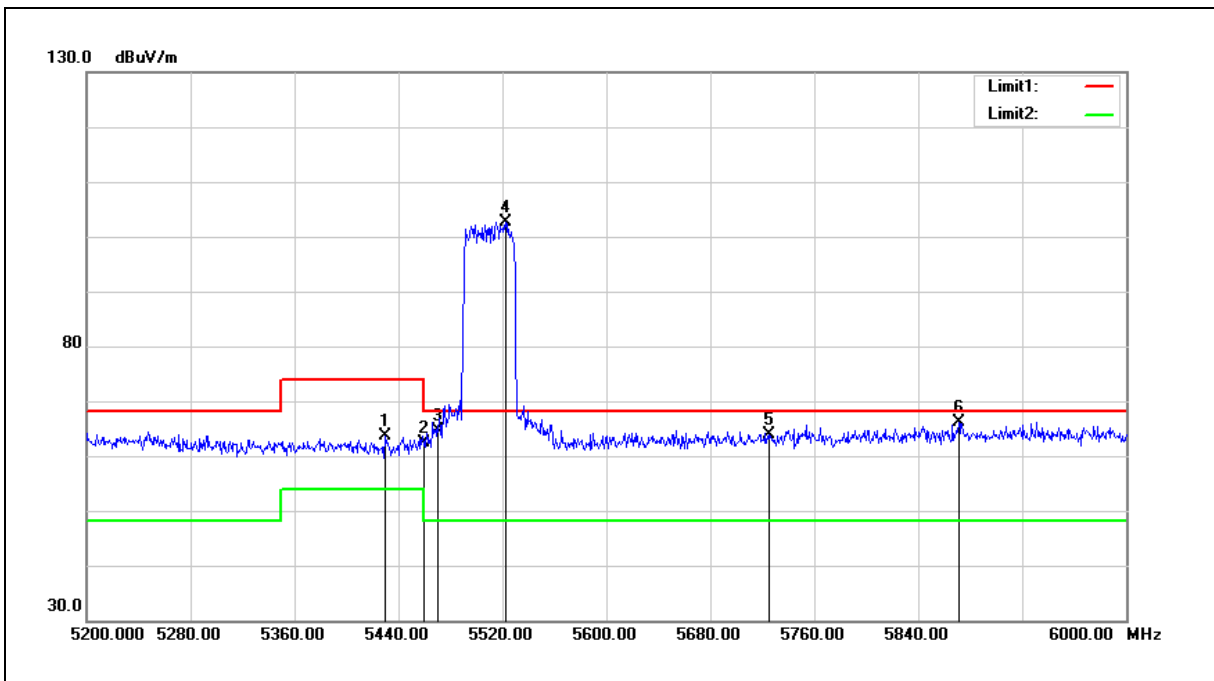

| No. | Frequency (MHz) | Reading (dBuV) | Correct Factor (dB/m) | Result (dBuV/m) | Limit (dBuV/m) | Margin (dB) | Remark |
|-----|-----------------|----------------|-----------------------|-----------------|----------------|-------------|--------|
| 1 | 5429.600 | 58.60 | 4.93 | 63.53 | 74.00 | -10.47 | peak |
| 2 | 5460.000 | 57.38 | 4.97 | 62.35 | 74.00 | -11.65 | peak |
| 3 | 5470.000 | 59.53 | 4.98 | 64.51 | 68.20 | -3.69 | peak |
| 4 | 5522.400 | 97.60 | 5.07 | 102.67 | -- | -- | peak |
| 5 | 5725.000 | 58.32 | 5.47 | 63.79 | 68.20 | -4.41 | peak |
| 6 | 5871.200 | 60.31 | 5.76 | 66.07 | 68.20 | -2.13 | peak |

Note:1.Result (dBuV/m) = Correct Factor (dB/m) + Reading(dBuV).

2.Correction factor (dB/m) = Antenna Factor (dB/m) + Cable loss (dB) – Pre-Amplifier gain (dB).

3.When the peak results are less than average limit, so not need to evaluate the average.



| | | | |
|-------------|-----------------|----------------|-----|
| Standard: | FCC Part 15.407 | Test Distance: | 3 m |
| Test item: | Band edge | | |
| Frequency: | 5550 MHz | | |
| Mode: | Mode 9 | | |
| Ant.Polar.: | Horizontal | | |

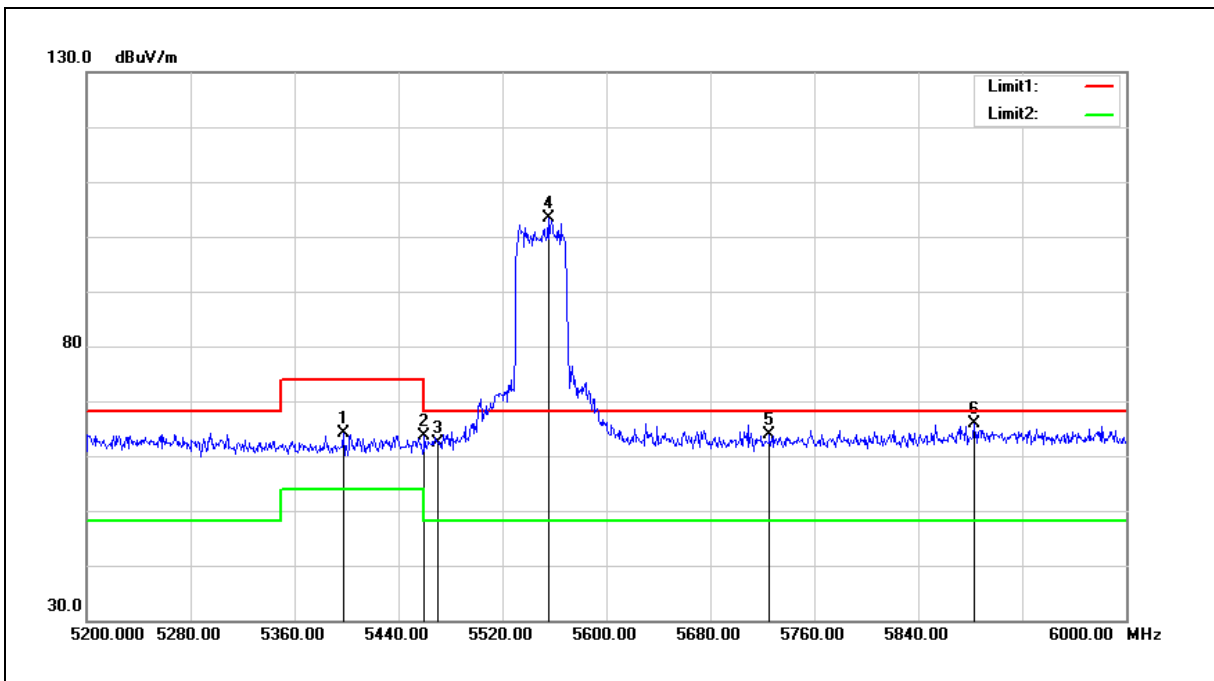

| No. | Frequency (MHz) | Reading (dBuV) | Correct Factor (dB/m) | Result (dBuV/m) | Limit (dBuV/m) | Margin (dB) | Remark |
|-----|-----------------|----------------|-----------------------|-----------------|----------------|-------------|--------|
| 1 | 5397.600 | 59.34 | 4.90 | 64.24 | 74.00 | -9.76 | peak |
| 2 | 5460.000 | 58.63 | 4.97 | 63.60 | 74.00 | -10.40 | peak |
| 3 | 5470.000 | 57.33 | 4.98 | 62.31 | 68.20 | -5.89 | peak |
| 4 | 5555.200 | 98.17 | 5.13 | 103.30 | -- | -- | peak |
| 5 | 5725.000 | 58.31 | 5.47 | 63.78 | 68.20 | -4.42 | peak |
| 6 | 5883.200 | 60.21 | 5.78 | 65.99 | 68.20 | -2.21 | peak |

Note:1.Result (dBuV/m) = Correct Factor (dB/m) + Reading(dBuV).

2.Correction factor (dB/m) = Antenna Factor (dB/m) + Cable loss (dB) – Pre-Amplifier gain (dB).

3.When the peak results are less than average limit, so not need to evaluate the average.



| | | | |
|-------------|-----------------|----------------|-----|
| Standard: | FCC Part 15.407 | Test Distance: | 3 m |
| Test item: | Band edge | | |
| Frequency: | 5550 MHz | | |
| Mode: | Mode 9 | | |
| Ant.Polar.: | Vertical | | |

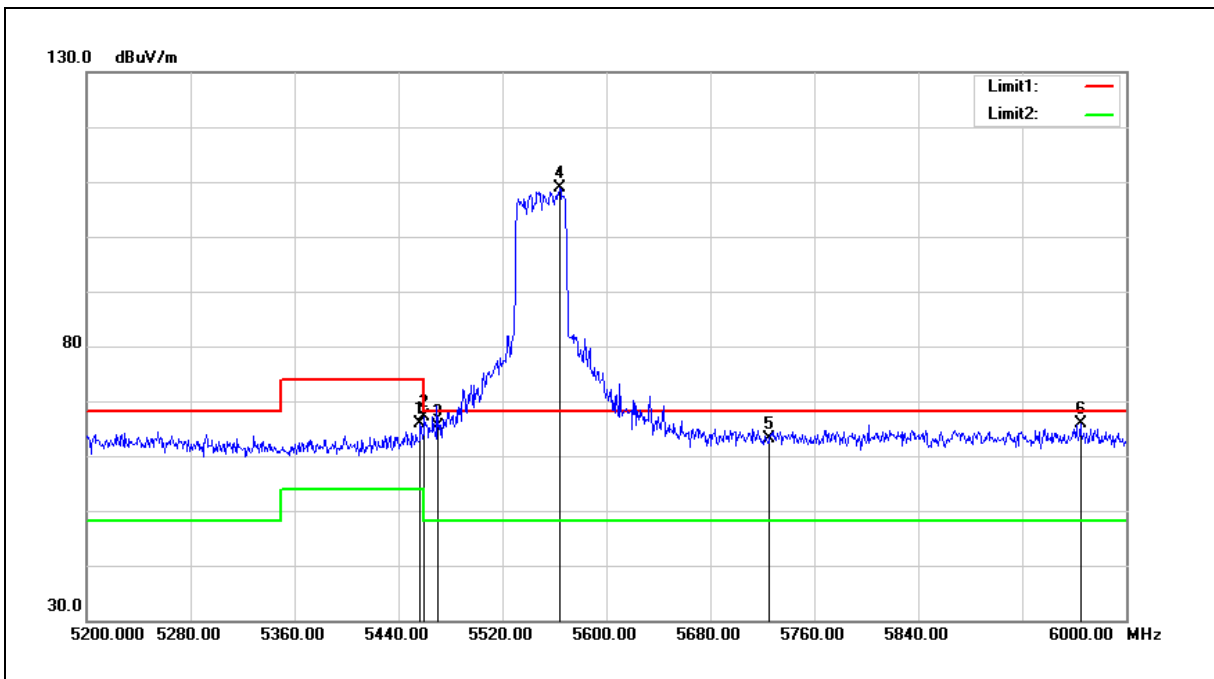

| No. | Frequency (MHz) | Reading (dBuV) | Correct Factor (dB/m) | Result (dBuV/m) | Limit (dBuV/m) | Margin (dB) | Remark |
|-----|-----------------|----------------|-----------------------|-----------------|----------------|-------------|--------|
| 1 | 5456.800 | 60.93 | 4.97 | 65.90 | 74.00 | -8.10 | peak |
| 2 | 5460.000 | 62.15 | 4.97 | 67.12 | 74.00 | -6.88 | peak |
| 3 | 5470.000 | 60.48 | 4.98 | 65.46 | 68.20 | -2.74 | peak |
| 4 | 5564.000 | 103.64 | 5.15 | 108.79 | -- | -- | peak |
| 5 | 5725.000 | 57.67 | 5.47 | 63.14 | 68.20 | -5.06 | peak |
| 6 | 5964.800 | 59.81 | 5.95 | 65.76 | 68.20 | -2.44 | peak |

Note:1.Result (dBuV/m) = Correct Factor (dB/m) + Reading(dBuV).

2.Correction factor (dB/m) = Antenna Factor (dB/m) + Cable loss (dB) – Pre-Amplifier gain (dB).

3.When the peak results are less than average limit, so not need to evaluate the average.



| | | | |
|-------------|-----------------|----------------|-----|
| Standard: | FCC Part 15.407 | Test Distance: | 3 m |
| Test item: | Band edge | | |
| Frequency: | 5670 MHz | | |
| Mode: | Mode 9 | | |
| Ant.Polar.: | Horizontal | | |

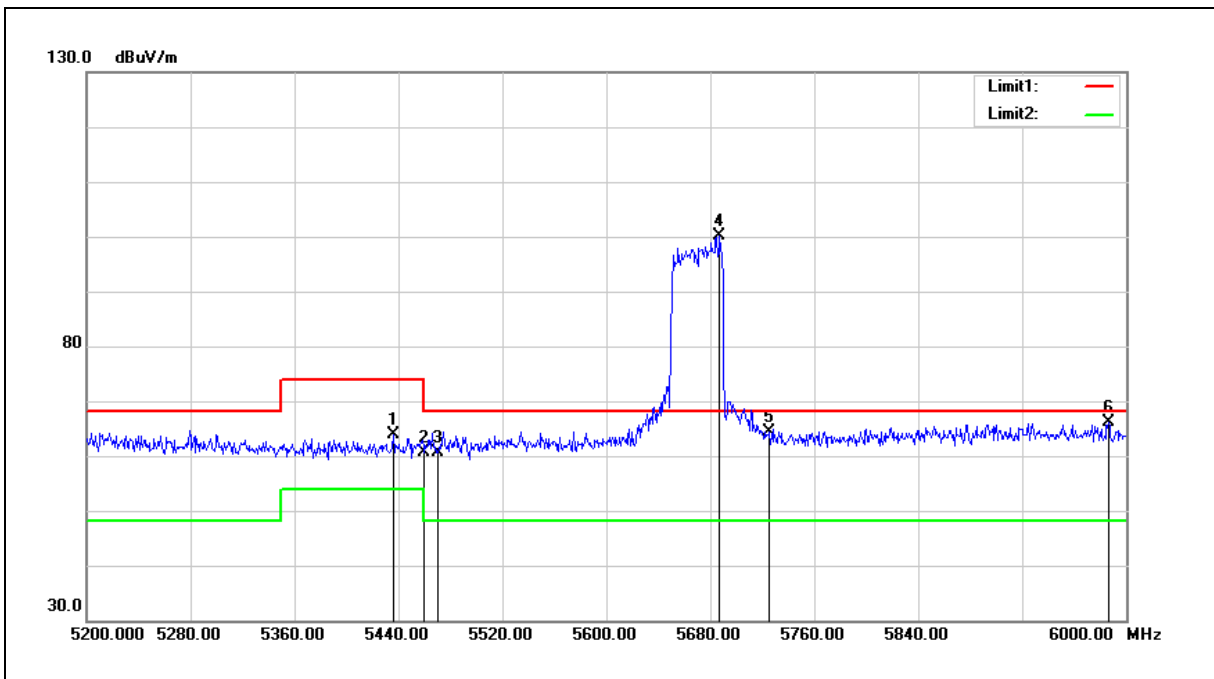

| No. | Frequency (MHz) | Reading (dBuV) | Correct Factor (dB/m) | Result (dBuV/m) | Limit (dBuV/m) | Margin (dB) | Remark |
|-----|-----------------|----------------|-----------------------|-----------------|----------------|-------------|--------|
| 1 | 5436.000 | 58.86 | 4.94 | 63.80 | 74.00 | -10.20 | peak |
| 2 | 5460.000 | 55.61 | 4.97 | 60.58 | 74.00 | -13.42 | peak |
| 3 | 5470.000 | 55.65 | 4.98 | 60.63 | 68.20 | -7.57 | peak |
| 4 | 5687.200 | 94.79 | 5.38 | 100.17 | -- | -- | peak |
| 5 | 5725.000 | 59.00 | 5.47 | 64.47 | 68.20 | -3.73 | peak |
| 6 | 5986.400 | 60.03 | 5.99 | 66.02 | 68.20 | -2.18 | peak |

Note:1.Result (dBuV/m) = Correct Factor (dB/m) + Reading(dBuV).

2.Correction factor (dB/m) = Antenna Factor (dB/m) + Cable loss (dB) – Pre-Amplifier gain (dB).

3.When the peak results are less than average limit, so not need to evaluate the average.



| | | | |
|-------------|-----------------|----------------|-----|
| Standard: | FCC Part 15.407 | Test Distance: | 3 m |
| Test item: | Band edge | | |
| Frequency: | 5670 MHz | | |
| Mode: | Mode 9 | | |
| Ant.Polar.: | Vertical | | |

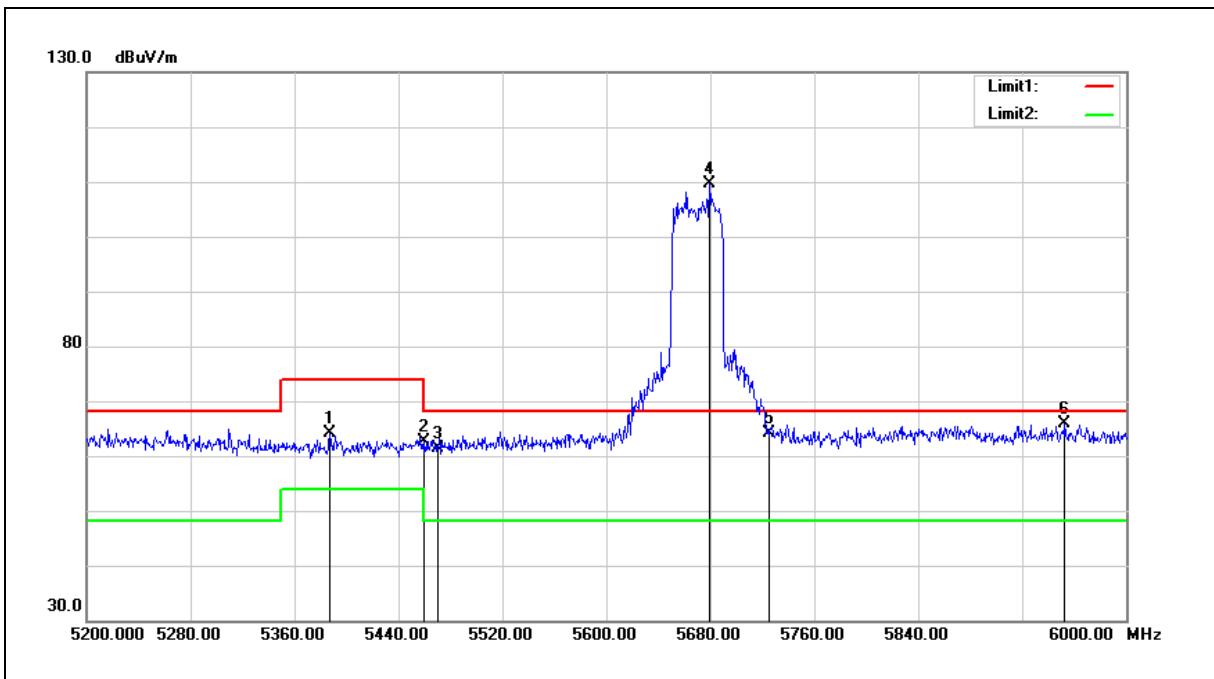

| No. | Frequency (MHz) | Reading (dBuV) | Correct Factor (dB/m) | Result (dBuV/m) | Limit (dBuV/m) | Margin (dB) | Remark |
|-----|-----------------|----------------|-----------------------|-----------------|----------------|-------------|--------|
| 1 | 5387.200 | 59.13 | 4.88 | 64.01 | 74.00 | -9.99 | peak |
| 2 | 5460.000 | 57.63 | 4.97 | 62.60 | 74.00 | -11.40 | peak |
| 3 | 5470.000 | 56.38 | 4.98 | 61.36 | 68.20 | -6.84 | peak |
| 4 | 5679.200 | 104.13 | 5.38 | 109.51 | -- | -- | peak |
| 5 | 5725.000 | 58.78 | 5.47 | 64.25 | 68.20 | -3.95 | peak |
| 6 | 5952.800 | 60.05 | 5.92 | 65.97 | 68.20 | -2.23 | peak |

Note:1.Result (dBuV/m) = Correct Factor (dB/m) + Reading(dBuV).

2.Correction factor (dB/m) = Antenna Factor (dB/m) + Cable loss (dB) – Pre-Amplifier gain (dB).

3.When the peak results are less than average limit, so not need to evaluate the average.



| | | | |
|-------------|-----------------|----------------|-----|
| Standard: | FCC Part 15.407 | Test Distance: | 3 m |
| Test item: | Band edge | | |
| Frequency: | 5710 MHz | | |
| Mode: | Mode 9 | | |
| Ant.Polar.: | Horizontal | | |

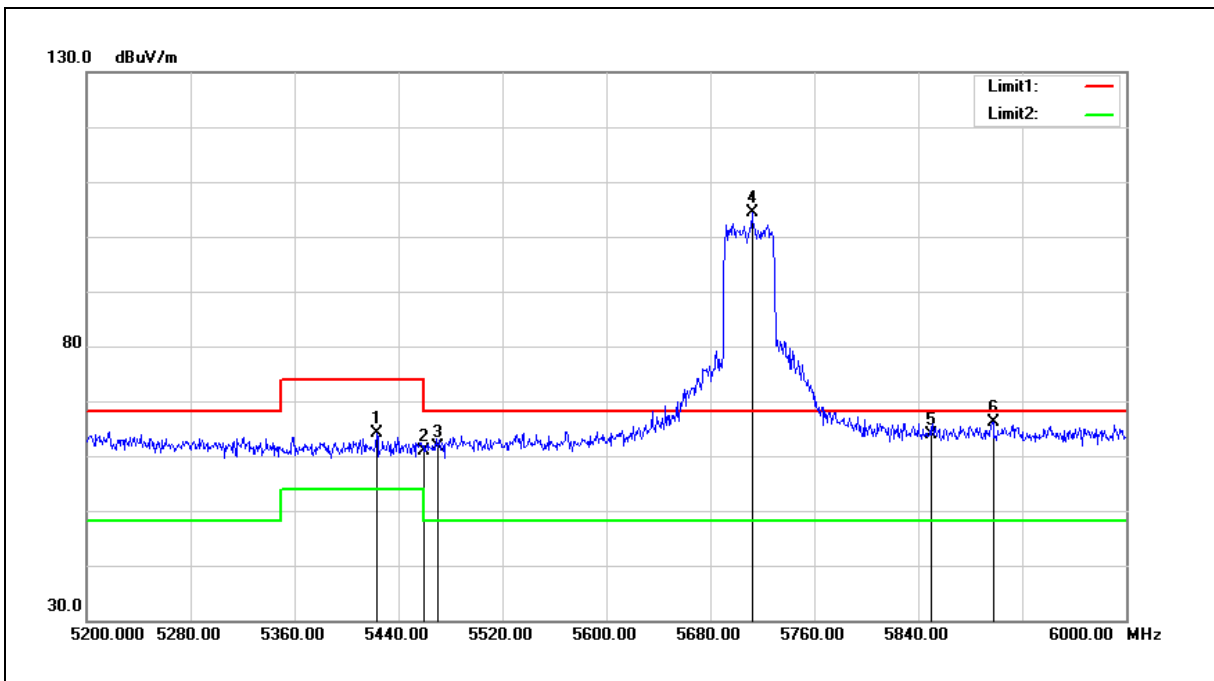

| No. | Frequency (MHz) | Reading (dBuV) | Correct Factor (dB/m) | Result (dBuV/m) | Limit (dBuV/m) | Margin (dB) | Remark |
|-----|-----------------|----------------|-----------------------|-----------------|----------------|-------------|--------|
| 1 | 5423.200 | 59.21 | 4.92 | 64.13 | 74.00 | -9.87 | peak |
| 2 | 5460.000 | 55.91 | 4.97 | 60.88 | 74.00 | -13.12 | peak |
| 3 | 5470.000 | 56.72 | 4.98 | 61.70 | 68.20 | -6.50 | peak |
| 4 | 5712.000 | 98.82 | 5.44 | 104.26 | -- | -- | peak |
| 5 | 5850.000 | 58.14 | 5.72 | 63.86 | 68.20 | -4.34 | peak |
| 6 | 5897.600 | 60.24 | 5.81 | 66.05 | 68.20 | -2.15 | peak |

Note:1.Result (dBuV/m) = Correct Factor (dB/m) + Reading(dBuV).

2.Correction factor (dB/m) = Antenna Factor (dB/m) + Cable loss (dB) – Pre-Amplifier gain (dB).

3.When the peak results are less than average limit, so not need to evaluate the average.



| | | | |
|-------------|-----------------|----------------|-----|
| Standard: | FCC Part 15.407 | Test Distance: | 3 m |
| Test item: | Band edge | | |
| Frequency: | 5710 MHz | | |
| Mode: | Mode 9 | | |
| Ant.Polar.: | Vertical | | |

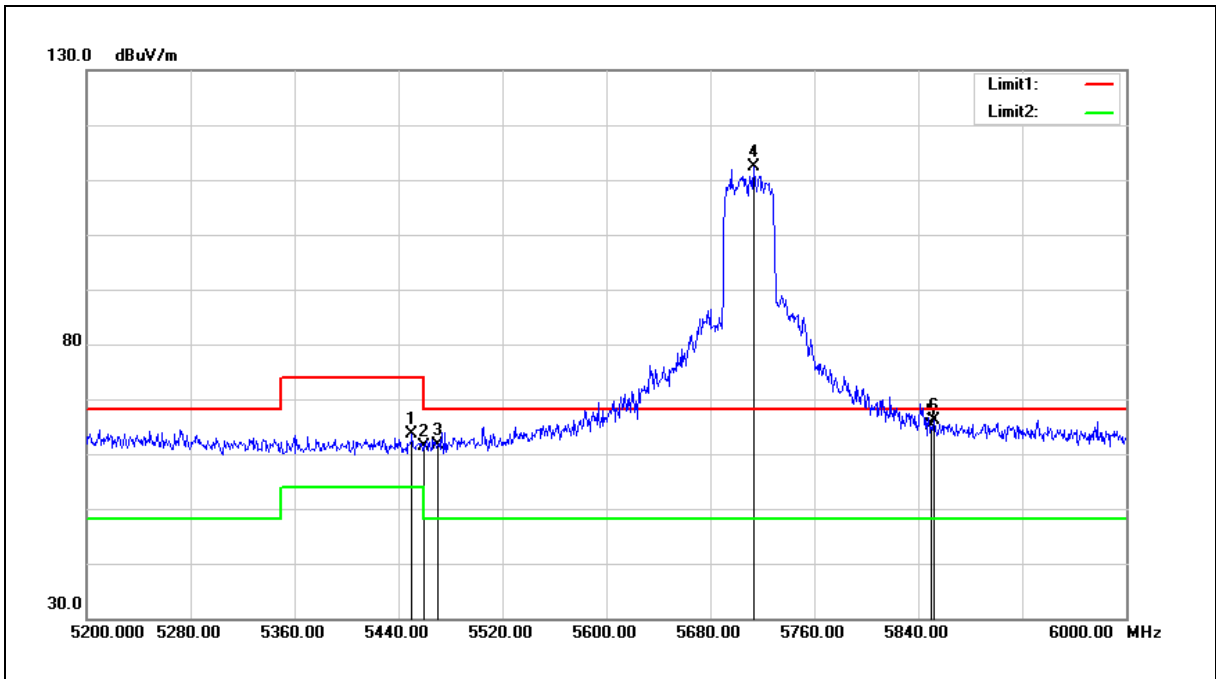

| No. | Frequency (MHz) | Reading (dBuV) | Correct Factor (dB/m) | Result (dBuV/m) | Limit (dBuV/m) | Margin (dB) | Remark |
|-----|-----------------|----------------|-----------------------|-----------------|----------------|-------------|--------|
| 1 | 5450.400 | 58.62 | 4.95 | 63.57 | 74.00 | -10.43 | peak |
| 2 | 5460.000 | 56.38 | 4.97 | 61.35 | 74.00 | -12.65 | peak |
| 3 | 5470.000 | 56.61 | 4.98 | 61.59 | 68.20 | -6.61 | peak |
| 4 | 5713.600 | 106.87 | 5.45 | 112.32 | -- | -- | peak |
| 5 | 5850.000 | 59.32 | 5.72 | 65.04 | 68.20 | -3.16 | peak |
| 6 | 5852.000 | 60.49 | 5.72 | 66.21 | 68.20 | -1.99 | peak |

Note:1.Result (dBuV/m) = Correct Factor (dB/m) + Reading(dBuV).

2.Correction factor (dB/m) = Antenna Factor (dB/m) + Cable loss (dB) – Pre-Amplifier gain (dB).

3.When the peak results are less than average limit, so not need to evaluate the average.



| | | | |
|-------------|-----------------|----------------|-----|
| Standard: | FCC Part 15.407 | Test Distance: | 3 m |
| Test item: | Band edge | | |
| Frequency: | 5755 MHz | | |
| Mode: | Mode 9 | | |
| Ant.Polar.: | Horizontal | | |

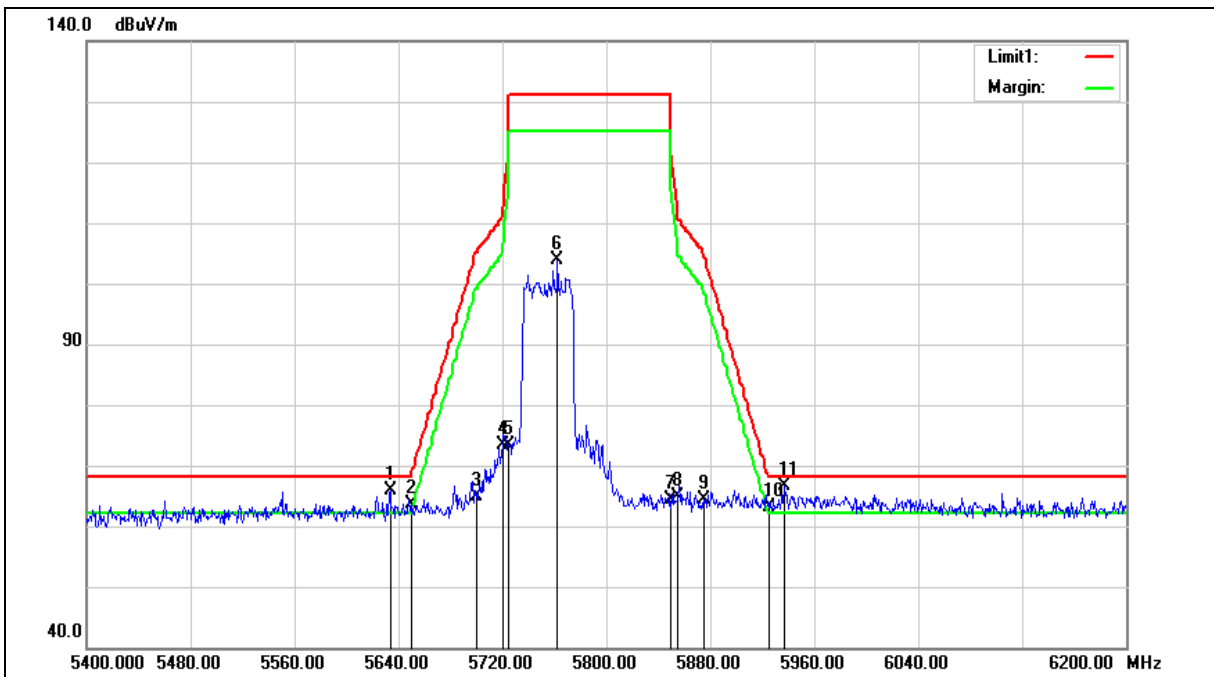



| | | | |
|-------------|-----------------|----------------|-----|
| Standard: | FCC Part 15.407 | Test Distance: | 3 m |
| Test item: | Band edge | | |
| Frequency: | 5755 MHz | | |
| Mode: | Mode 9 | | |
| Ant.Polar.: | Horizontal | | |

| No. | Frequency (MHz) | Reading (dBuV) | Correct Factor (dB/m) | Result (dBuV/m) | Limit (dBuV/m) | Margin (dB) | Remark |
|-----|-----------------|----------------|-----------------------|-----------------|----------------|-------------|--------|
| 1 | 5633.600 | 60.50 | 5.28 | 65.78 | 68.20 | -2.42 | peak |
| 2 | 5650.000 | 58.23 | 5.31 | 63.54 | 68.20 | -4.66 | peak |
| 3 | 5700.000 | 59.34 | 5.42 | 64.76 | 105.20 | -40.44 | peak |
| 4 | 5720.000 | 67.82 | 5.46 | 73.28 | 110.80 | -37.52 | peak |
| 5 | 5725.000 | 68.00 | 5.47 | 73.47 | 122.20 | -48.73 | peak |
| 6 | 5762.400 | 98.37 | 5.54 | 103.91 | -- | -- | peak |
| 7 | 5850.000 | 58.74 | 5.72 | 64.46 | 122.20 | -57.74 | peak |
| 8 | 5855.000 | 59.26 | 5.73 | 64.99 | 110.80 | -45.81 | peak |
| 9 | 5875.000 | 58.52 | 5.77 | 64.29 | 105.20 | -40.91 | peak |
| 10 | 5925.000 | 57.15 | 5.87 | 63.02 | 68.20 | -5.18 | peak |
| 11 | 5936.800 | 60.74 | 5.89 | 66.63 | 68.20 | -1.57 | peak |

Note:1.Result (dBuV/m) = Correct Factor (dB/m) + Reading(dBuV).

2.Correction factor (dB/m) = Antenna Factor (dB/m) + Cable loss (dB) – Pre-Amplifier gain (dB).

3.When the peak results are less than average limit, so not need to evaluate the average.



| | | | |
|-------------|-----------------|----------------|-----|
| Standard: | FCC Part 15.407 | Test Distance: | 3 m |
| Test item: | Band edge | | |
| Frequency: | 5755 MHz | | |
| Mode: | Mode 9 | | |
| Ant.Polar.: | Vertical | | |

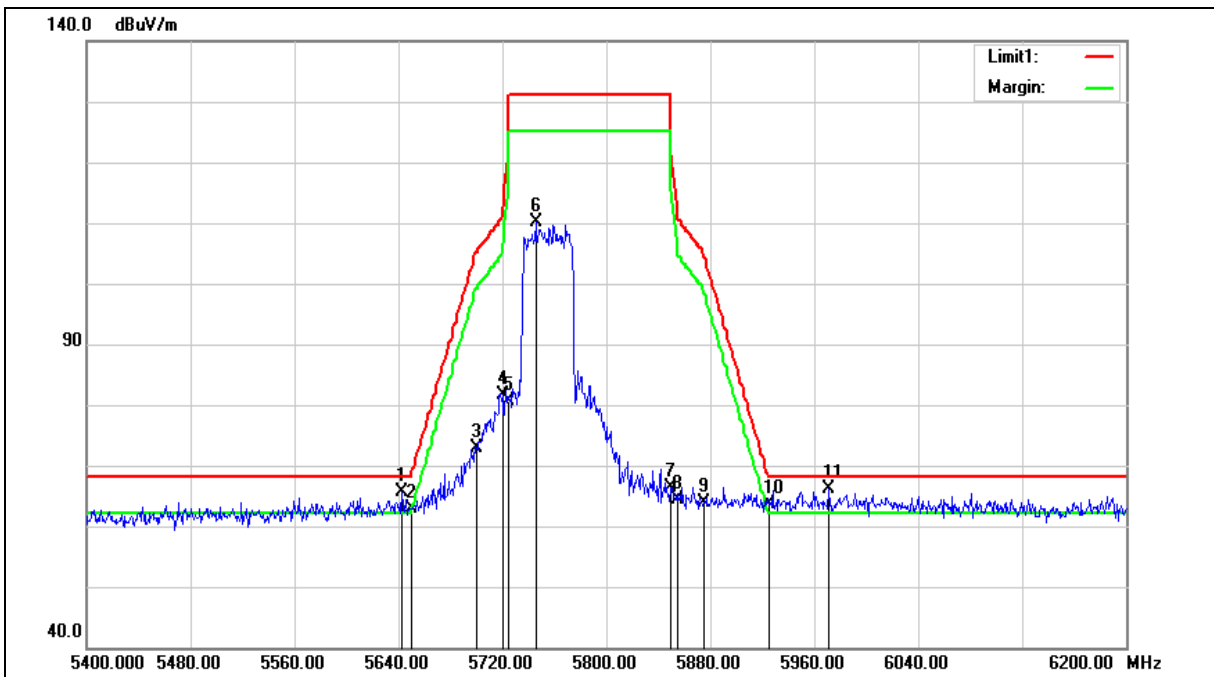



| | | | |
|-------------|-----------------|----------------|-----|
| Standard: | FCC Part 15.407 | Test Distance: | 3 m |
| Test item: | Band edge | | |
| Frequency: | 5755 MHz | | |
| Mode: | Mode 9 | | |
| Ant.Polar.: | Vertical | | |

| No. | Frequency (MHz) | Reading (dBuV) | Correct Factor (dB/m) | Result (dBuV/m) | Limit (dBuV/m) | Margin (dB) | Remark |
|-----|-----------------|----------------|-----------------------|-----------------|----------------|-------------|--------|
| 1 | 5642.400 | 60.33 | 5.30 | 65.63 | 68.20 | -2.57 | peak |
| 2 | 5650.000 | 57.51 | 5.31 | 62.82 | 68.20 | -5.38 | peak |
| 3 | 5700.000 | 67.54 | 5.42 | 72.96 | 105.20 | -32.24 | peak |
| 4 | 5720.000 | 76.29 | 5.46 | 81.75 | 110.80 | -29.05 | peak |
| 5 | 5725.000 | 75.26 | 5.47 | 80.73 | 122.20 | -41.47 | peak |
| 6 | 5745.600 | 104.70 | 5.51 | 110.21 | -- | -- | peak |
| 7 | 5850.000 | 60.64 | 5.72 | 66.36 | 122.20 | -55.84 | peak |
| 8 | 5855.000 | 58.74 | 5.73 | 64.47 | 110.80 | -46.33 | peak |
| 9 | 5875.000 | 58.18 | 5.77 | 63.95 | 105.20 | -41.25 | peak |
| 10 | 5925.000 | 57.73 | 5.87 | 63.60 | 68.20 | -4.60 | peak |
| 11 | 5971.200 | 60.14 | 5.97 | 66.11 | 68.20 | -2.09 | peak |

Note:1.Result (dBuV/m) = Correct Factor (dB/m) + Reading(dBuV).

2.Correction factor (dB/m) = Antenna Factor (dB/m) + Cable loss (dB) – Pre-Amplifier gain (dB).

3.When the peak results are less than average limit, so not need to evaluate the average.



| | | | |
|-------------|-----------------|----------------|-----|
| Standard: | FCC Part 15.407 | Test Distance: | 3 m |
| Test item: | Band edge | | |
| Frequency: | 5795 MHz | | |
| Mode: | Mode 9 | | |
| Ant.Polar.: | Horizontal | | |

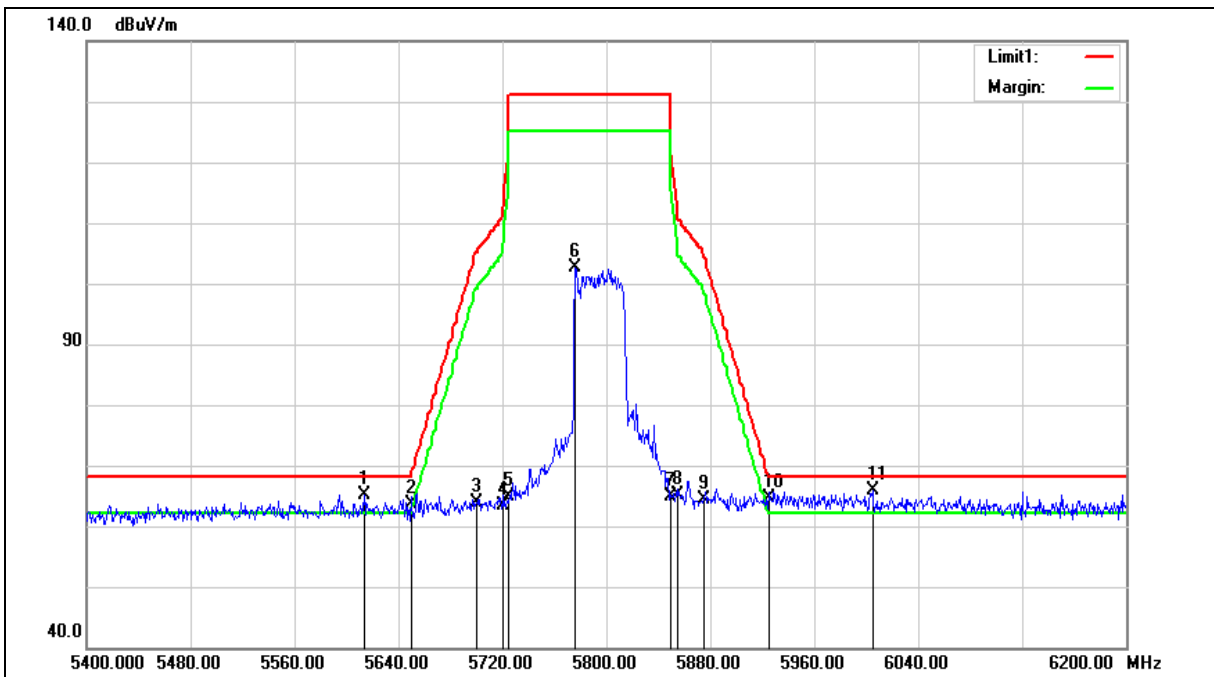



| | | | |
|-------------|-----------------|----------------|-----|
| Standard: | FCC Part 15.407 | Test Distance: | 3 m |
| Test item: | Band edge | | |
| Frequency: | 5795 MHz | | |
| Mode: | Mode 9 | | |
| Ant.Polar.: | Horizontal | | |

| No. | Frequency (MHz) | Reading (dBuV) | Correct Factor (dB/m) | Result (dBuV/m) | Limit (dBuV/m) | Margin (dB) | Remark |
|-----|-----------------|----------------|-----------------------|-----------------|----------------|-------------|--------|
| 1 | 5613.600 | 59.94 | 5.25 | 65.19 | 68.20 | -3.01 | peak |
| 2 | 5650.000 | 58.43 | 5.31 | 63.74 | 68.20 | -4.46 | peak |
| 3 | 5700.000 | 58.46 | 5.42 | 63.88 | 105.20 | -41.32 | peak |
| 4 | 5720.000 | 58.04 | 5.46 | 63.50 | 110.80 | -47.30 | peak |
| 5 | 5725.000 | 59.53 | 5.47 | 65.00 | 122.20 | -57.20 | peak |
| 6 | 5776.000 | 96.97 | 5.57 | 102.54 | -- | -- | peak |
| 7 | 5850.000 | 59.25 | 5.72 | 64.97 | 122.20 | -57.23 | peak |
| 8 | 5855.000 | 59.48 | 5.73 | 65.21 | 110.80 | -45.59 | peak |
| 9 | 5875.000 | 58.54 | 5.77 | 64.31 | 105.20 | -40.89 | peak |
| 10 | 5925.000 | 58.74 | 5.87 | 64.61 | 68.20 | -3.59 | peak |
| 11 | 6004.800 | 59.74 | 6.03 | 65.77 | 68.20 | -2.43 | peak |

Note:1.Result (dBuV/m) = Correct Factor (dB/m) + Reading(dBuV).

2.Correction factor (dB/m) = Antenna Factor (dB/m) + Cable loss (dB) – Pre-Amplifier gain (dB).

3.When the peak results are less than average limit, so not need to evaluate the average.



| | | | |
|-------------|-----------------|----------------|-----|
| Standard: | FCC Part 15.407 | Test Distance: | 3 m |
| Test item: | Band edge | | |
| Frequency: | 5795 MHz | | |
| Mode: | Mode 9 | | |
| Ant.Polar.: | Vertical | | |

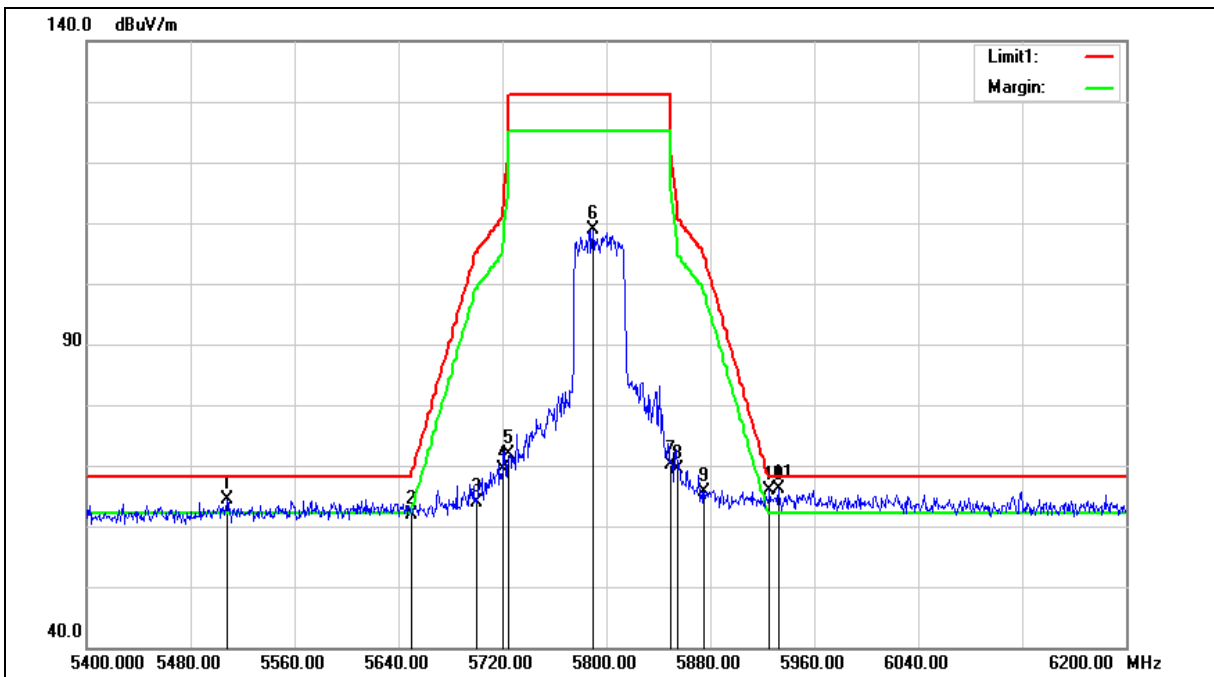



| | | | |
|-------------|-----------------|----------------|-----|
| Standard: | FCC Part 15.407 | Test Distance: | 3 m |
| Test item: | Band edge | | |
| Frequency: | 5795 MHz | | |
| Mode: | Mode 9 | | |
| Ant.Polar.: | Vertical | | |

| No. | Frequency (MHz) | Reading (dBuV) | Correct Factor (dB/m) | Result (dBuV/m) | Limit (dBuV/m) | Margin (dB) | Remark |
|-----|-----------------|----------------|-----------------------|-----------------|----------------|-------------|--------|
| 1 | 5508.000 | 59.35 | 5.04 | 64.39 | 68.20 | -3.81 | peak |
| 2 | 5650.000 | 56.59 | 5.31 | 61.90 | 68.20 | -6.30 | peak |
| 3 | 5700.000 | 58.50 | 5.42 | 63.92 | 105.20 | -41.28 | peak |
| 4 | 5720.000 | 63.88 | 5.46 | 69.34 | 110.80 | -41.46 | peak |
| 5 | 5725.000 | 66.41 | 5.47 | 71.88 | 122.20 | -50.32 | peak |
| 6 | 5789.600 | 103.26 | 5.60 | 108.86 | -- | -- | peak |
| 7 | 5850.000 | 64.38 | 5.72 | 70.10 | 122.20 | -52.10 | peak |
| 8 | 5855.000 | 63.74 | 5.73 | 69.47 | 110.80 | -41.33 | peak |
| 9 | 5875.000 | 59.91 | 5.77 | 65.68 | 105.20 | -39.52 | peak |
| 10 | 5925.000 | 60.13 | 5.87 | 66.00 | 68.20 | -2.20 | peak |
| 11 | 5932.800 | 60.17 | 5.89 | 66.06 | 68.20 | -2.14 | peak |

Note:1.Result (dBuV/m) = Correct Factor (dB/m) + Reading(dBuV).

2.Correction factor (dB/m) = Antenna Factor (dB/m) + Cable loss (dB) – Pre-Amplifier gain (dB).

3.When the peak results are less than average limit, so not need to evaluate the average.



| | | | |
|-------------|-----------------|----------------|-----|
| Standard: | FCC Part 15.407 | Test Distance: | 3 m |
| Test item: | Band edge | | |
| Frequency: | 5210 MHz | | |
| Mode: | Mode 10 | | |
| Ant.Polar.: | Horizontal | | |

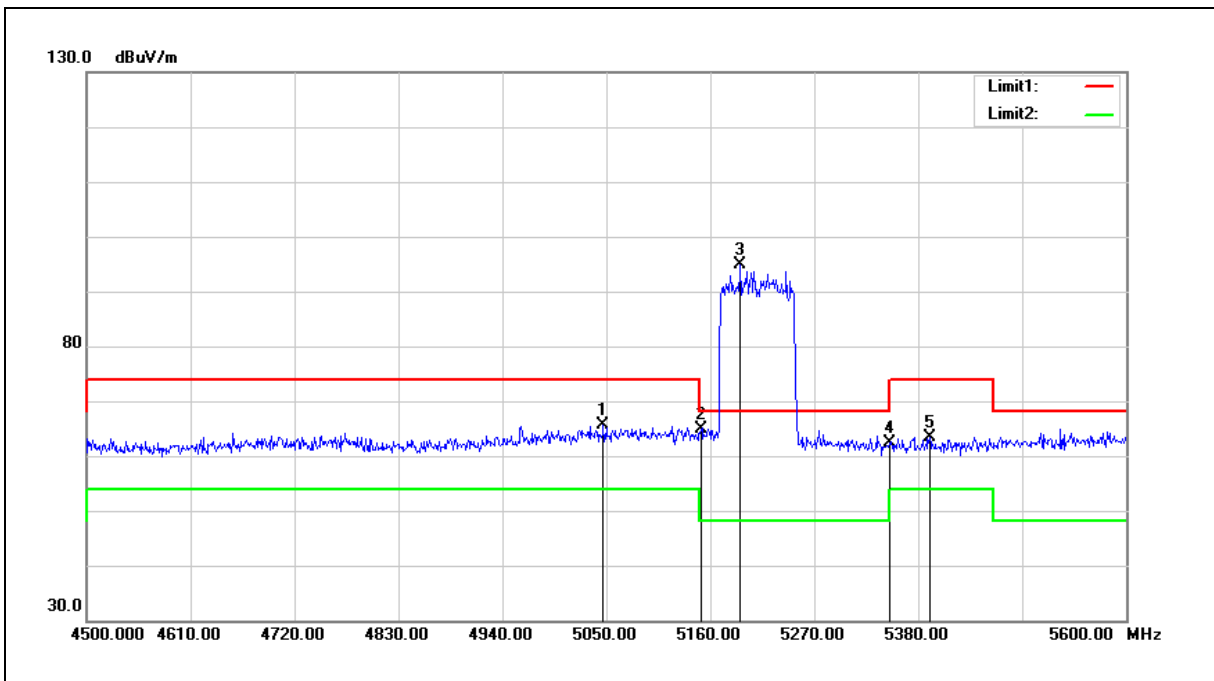

| No. | Frequency (MHz) | Reading (dBuV) | Correct Factor (dB/m) | Result (dBuV/m) | Limit (dBuV/m) | Margin (dB) | Remark |
|-----|-----------------|----------------|-----------------------|-----------------|----------------|-------------|--------|
| 1 | 5046.700 | 61.03 | 4.48 | 65.51 | 74.00 | -8.49 | peak |
| 2 | 5150.000 | 60.36 | 4.60 | 64.96 | 74.00 | -9.04 | peak |
| 3 | 5191.900 | 90.15 | 4.65 | 94.80 | -- | -- | peak |
| 4 | 5350.000 | 57.45 | 4.84 | 62.29 | 74.00 | -11.71 | peak |
| 5 | 5392.100 | 58.50 | 4.88 | 63.38 | 74.00 | -10.62 | peak |

Note:1.Result (dBuV/m) = Correct Factor (dB/m) + Reading(dBuV).

2.Correction factor (dB/m) = Antenna Factor (dB/m) + Cable loss (dB) – Pre-Amplifier gain (dB).

3.When the peak results are less than average limit, so not need to evaluate the average.



| | | | |
|-------------|-----------------|----------------|-----|
| Standard: | FCC Part 15.407 | Test Distance: | 3 m |
| Test item: | Band edge | | |
| Frequency: | 5210 MHz | | |
| Mode: | Mode 10 | | |
| Ant.Polar.: | Vertical | | |

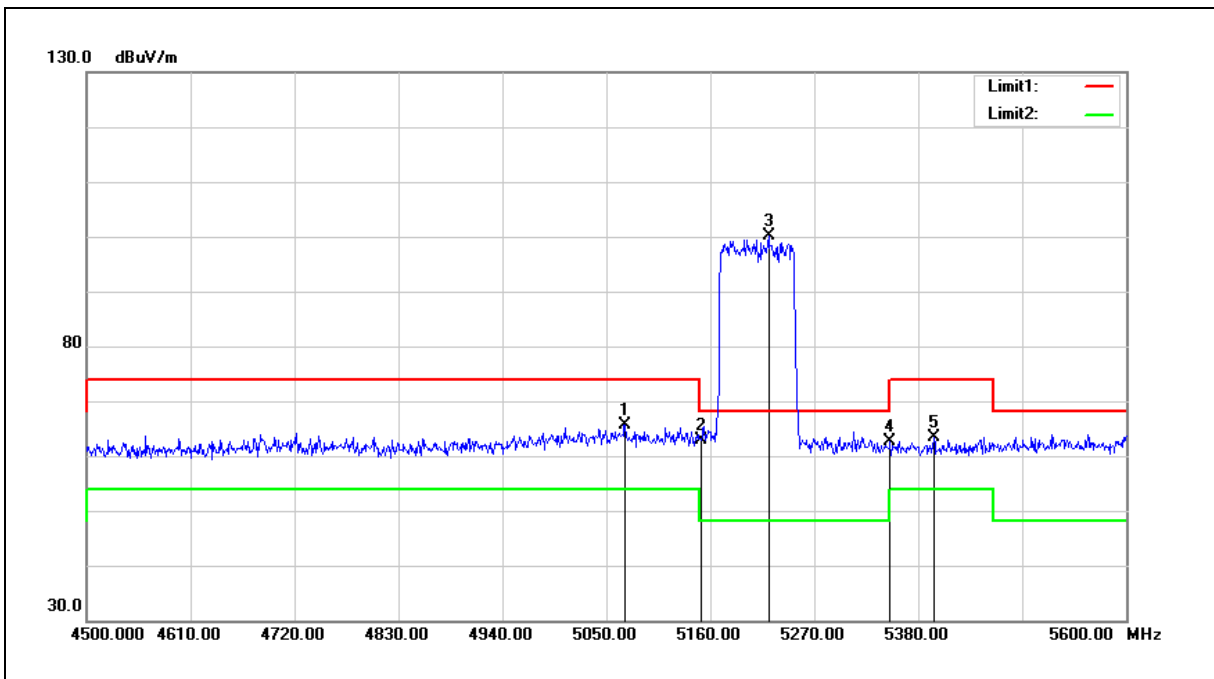

| No. | Frequency (MHz) | Reading (dBuV) | Correct Factor (dB/m) | Result (dBuV/m) | Limit (dBuV/m) | Margin (dB) | Remark |
|-----|-----------------|----------------|-----------------------|-----------------|----------------|-------------|--------|
| 1 | 5069.800 | 61.15 | 4.50 | 65.65 | 74.00 | -8.35 | peak |
| 2 | 5150.000 | 58.39 | 4.60 | 62.99 | 74.00 | -11.01 | peak |
| 3 | 5221.600 | 95.34 | 4.69 | 100.03 | -- | -- | peak |
| 4 | 5350.000 | 57.82 | 4.84 | 62.66 | 74.00 | -11.34 | peak |
| 5 | 5396.500 | 58.59 | 4.89 | 63.48 | 74.00 | -10.52 | peak |

Note:1.Result (dBuV/m) = Correct Factor (dB/m) + Reading(dBuV).

2.Correction factor (dB/m) = Antenna Factor (dB/m) + Cable loss (dB) – Pre-Amplifier gain (dB).

3.When the peak results are less than average limit, so not need to evaluate the average.



| | | | |
|-------------|-----------------|----------------|-----|
| Standard: | FCC Part 15.407 | Test Distance: | 3 m |
| Test item: | Band edge | | |
| Frequency: | 5290 MHz | | |
| Mode: | Mode 10 | | |
| Ant.Polar.: | Horizontal | | |

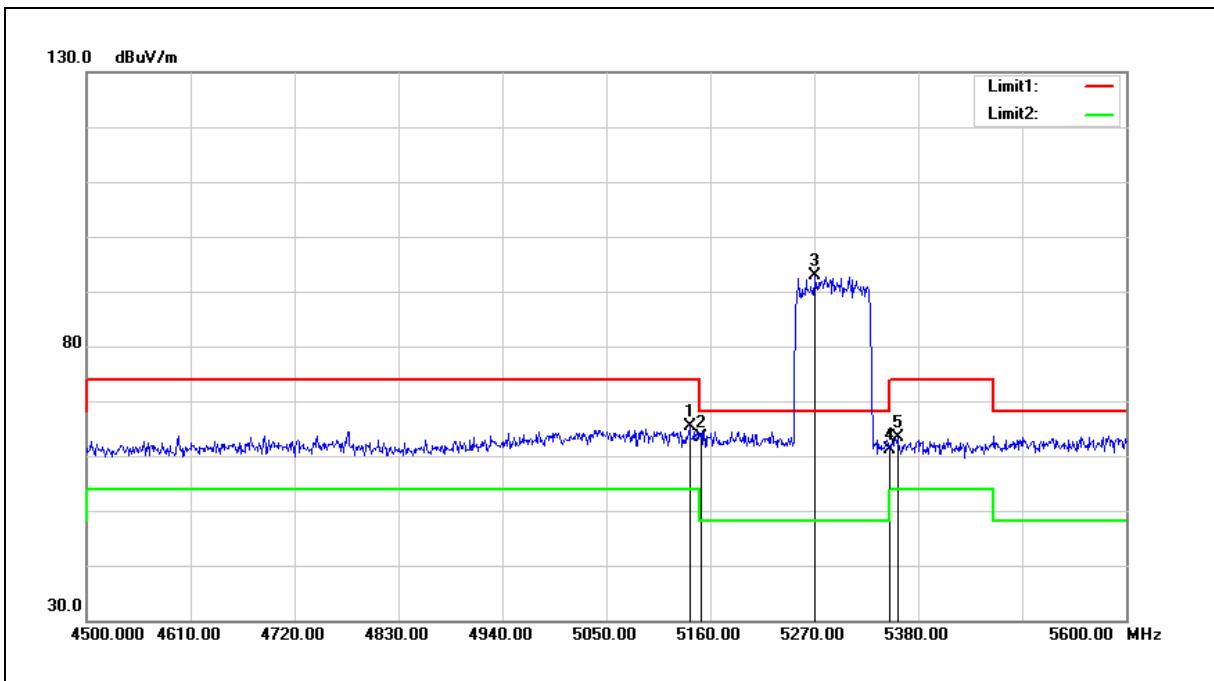

| No. | Frequency (MHz) | Reading (dBuV) | Correct Factor (dB/m) | Result (dBuV/m) | Limit (dBuV/m) | Margin (dB) | Remark |
|-----|-----------------|----------------|-----------------------|-----------------|----------------|-------------|--------|
| 1 | 5138.000 | 60.72 | 4.59 | 65.31 | 74.00 | -8.69 | peak |
| 2 | 5150.000 | 58.80 | 4.60 | 63.40 | 74.00 | -10.60 | peak |
| 3 | 5271.100 | 88.15 | 4.74 | 92.89 | -- | -- | peak |
| 4 | 5350.000 | 56.38 | 4.84 | 61.22 | 74.00 | -12.78 | peak |
| 5 | 5358.000 | 58.57 | 4.85 | 63.42 | 74.00 | -10.58 | peak |

Note:1.Result (dBuV/m) = Correct Factor (dB/m) + Reading(dBuV).

2.Correction factor (dB/m) = Antenna Factor (dB/m) + Cable loss (dB) – Pre-Amplifier gain (dB).

3.When the peak results are less than average limit, so not need to evaluate the average.



| | | | |
|-------------|-----------------|----------------|-----|
| Standard: | FCC Part 15.407 | Test Distance: | 3 m |
| Test item: | Band edge | | |
| Frequency: | 5290 MHz | | |
| Mode: | Mode 10 | | |
| Ant.Polar.: | Vertical | | |

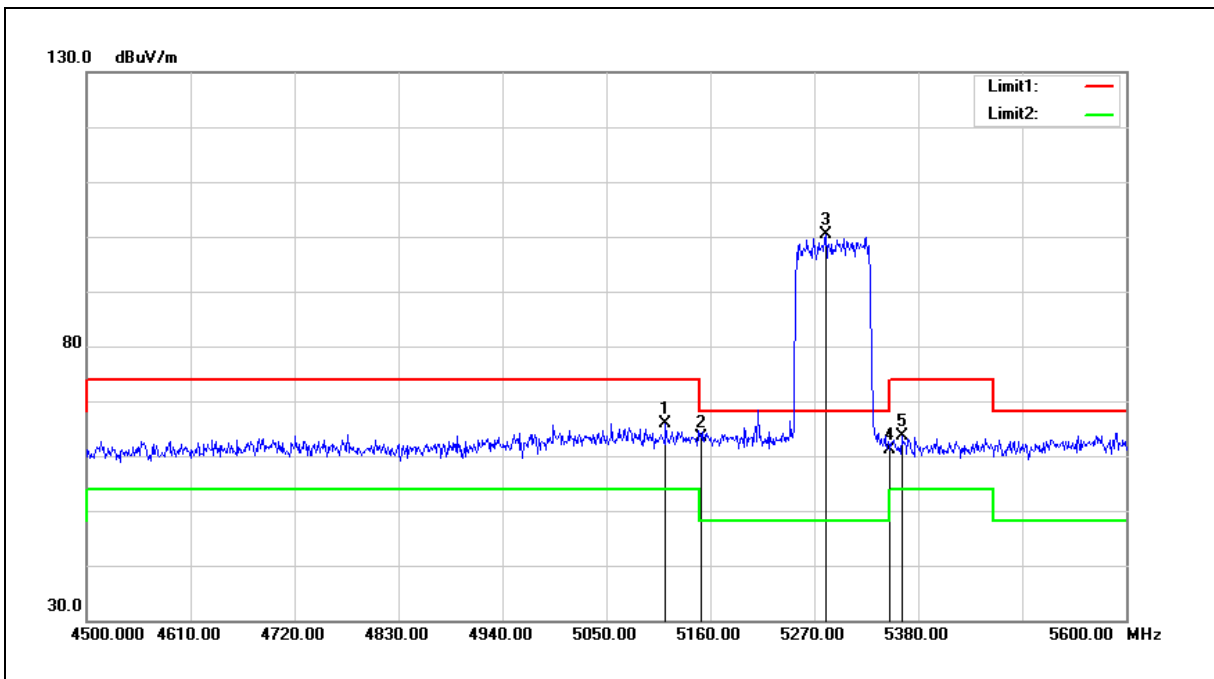

| No. | Frequency (MHz) | Reading (dBuV) | Correct Factor (dB/m) | Result (dBuV/m) | Limit (dBuV/m) | Margin (dB) | Remark |
|-----|-----------------|----------------|-----------------------|-----------------|----------------|-------------|--------|
| 1 | 5112.700 | 61.42 | 4.56 | 65.98 | 74.00 | -8.02 | peak |
| 2 | 5150.000 | 58.71 | 4.60 | 63.31 | 74.00 | -10.69 | peak |
| 3 | 5282.100 | 95.54 | 4.76 | 100.30 | -- | -- | peak |
| 4 | 5350.000 | 56.21 | 4.84 | 61.05 | 74.00 | -12.95 | peak |
| 5 | 5362.400 | 58.90 | 4.85 | 63.75 | 74.00 | -10.25 | peak |

Note:1.Result (dBuV/m) = Correct Factor (dB/m) + Reading(dBuV).

2.Correction factor (dB/m) = Antenna Factor (dB/m) + Cable loss (dB) – Pre-Amplifier gain (dB).

3.When the peak results are less than average limit, so not need to evaluate the average.



| | | | |
|-------------|-----------------|----------------|-----|
| Standard: | FCC Part 15.407 | Test Distance: | 3 m |
| Test item: | Band edge | | |
| Frequency: | 5530 MHz | | |
| Mode: | Mode 10 | | |
| Ant.Polar.: | Horizontal | | |

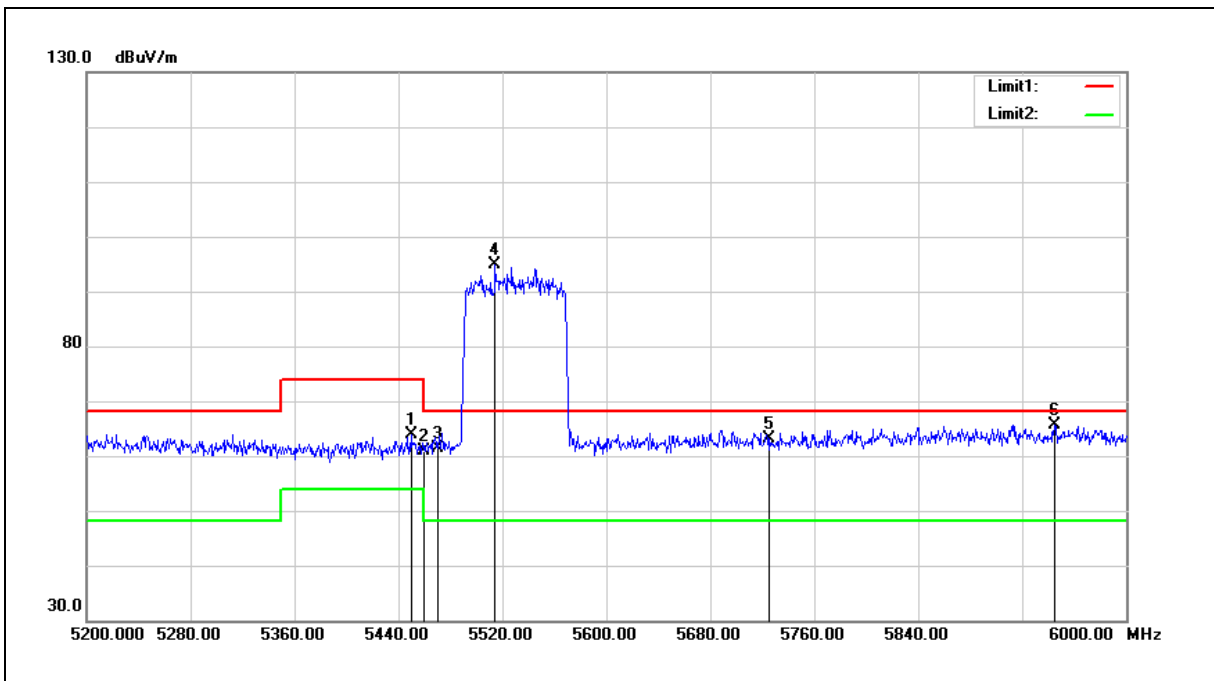

| No. | Frequency (MHz) | Reading (dBuV) | Correct Factor (dB/m) | Result (dBuV/m) | Limit (dBuV/m) | Margin (dB) | Remark |
|-----|-----------------|----------------|-----------------------|-----------------|----------------|-------------|--------|
| 1 | 5449.600 | 58.84 | 4.95 | 63.79 | 74.00 | -10.21 | peak |
| 2 | 5460.000 | 56.03 | 4.97 | 61.00 | 74.00 | -13.00 | peak |
| 3 | 5470.000 | 56.37 | 4.98 | 61.35 | 68.20 | -6.85 | peak |
| 4 | 5514.400 | 89.74 | 5.05 | 94.79 | -- | -- | peak |
| 5 | 5725.000 | 57.64 | 5.47 | 63.11 | 68.20 | -5.09 | peak |
| 6 | 5944.800 | 59.68 | 5.91 | 65.59 | 68.20 | -2.61 | peak |

Note:1.Result (dBuV/m) = Correct Factor (dB/m) + Reading(dBuV).

2.Correction factor (dB/m) = Antenna Factor (dB/m) + Cable loss (dB) – Pre-Amplifier gain (dB).

3.When the peak results are less than average limit, so not need to evaluate the average.



| | | | |
|-------------|-----------------|----------------|-----|
| Standard: | FCC Part 15.407 | Test Distance: | 3 m |
| Test item: | Band edge | | |
| Frequency: | 5530 MHz | | |
| Mode: | Mode 10 | | |
| Ant.Polar.: | Vertical | | |

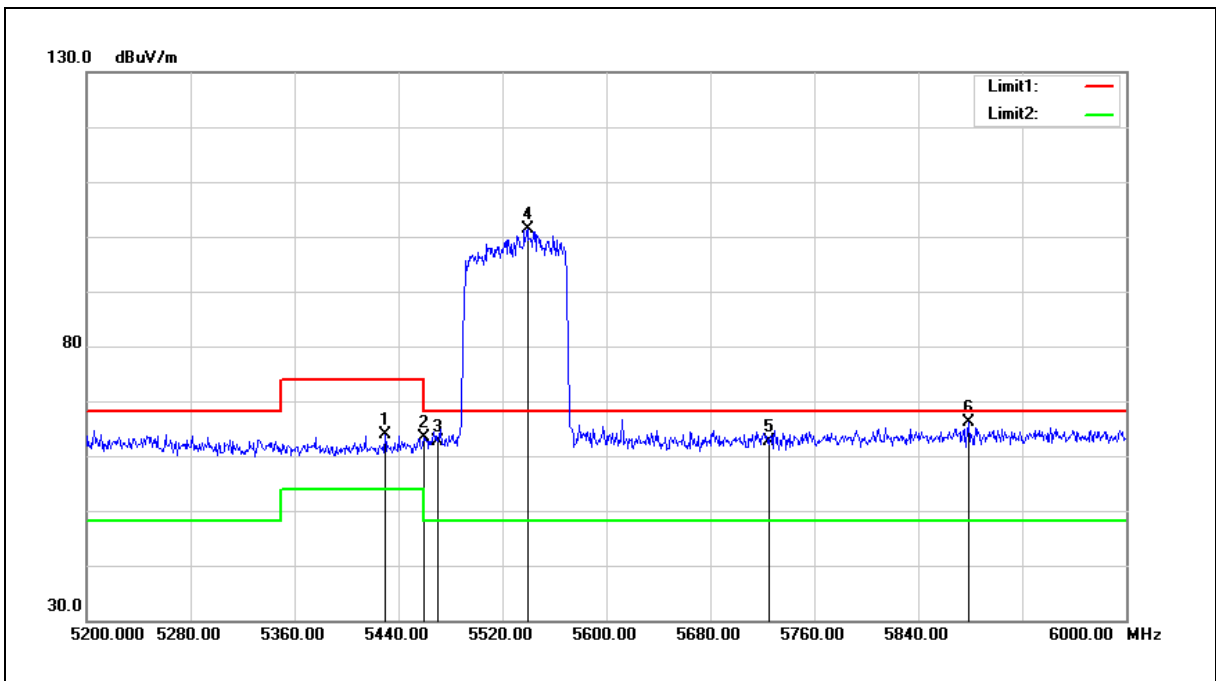

| No. | Frequency (MHz) | Reading (dBuV) | Correct Factor (dB/m) | Result (dBuV/m) | Limit (dBuV/m) | Margin (dB) | Remark |
|-----|-----------------|----------------|-----------------------|-----------------|----------------|-------------|--------|
| 1 | 5429.600 | 58.86 | 4.93 | 63.79 | 74.00 | -10.21 | peak |
| 2 | 5460.000 | 58.45 | 4.97 | 63.42 | 74.00 | -10.58 | peak |
| 3 | 5470.000 | 57.75 | 4.98 | 62.73 | 68.20 | -5.47 | peak |
| 4 | 5539.200 | 96.26 | 5.10 | 101.36 | -- | -- | peak |
| 5 | 5725.000 | 57.09 | 5.47 | 62.56 | 68.20 | -5.64 | peak |
| 6 | 5879.200 | 60.42 | 5.78 | 66.20 | 68.20 | -2.00 | peak |

Note:1.Result (dBuV/m) = Correct Factor (dB/m) + Reading(dBuV).

2.Correction factor (dB/m) = Antenna Factor (dB/m) + Cable loss (dB) – Pre-Amplifier gain (dB).

3.When the peak results are less than average limit, so not need to evaluate the average.



| | | | |
|-------------|-----------------|----------------|-----|
| Standard: | FCC Part 15.407 | Test Distance: | 3 m |
| Test item: | Band edge | | |
| Frequency: | 5690 MHz | | |
| Mode: | Mode 10 | | |
| Ant.Polar.: | Horizontal | | |

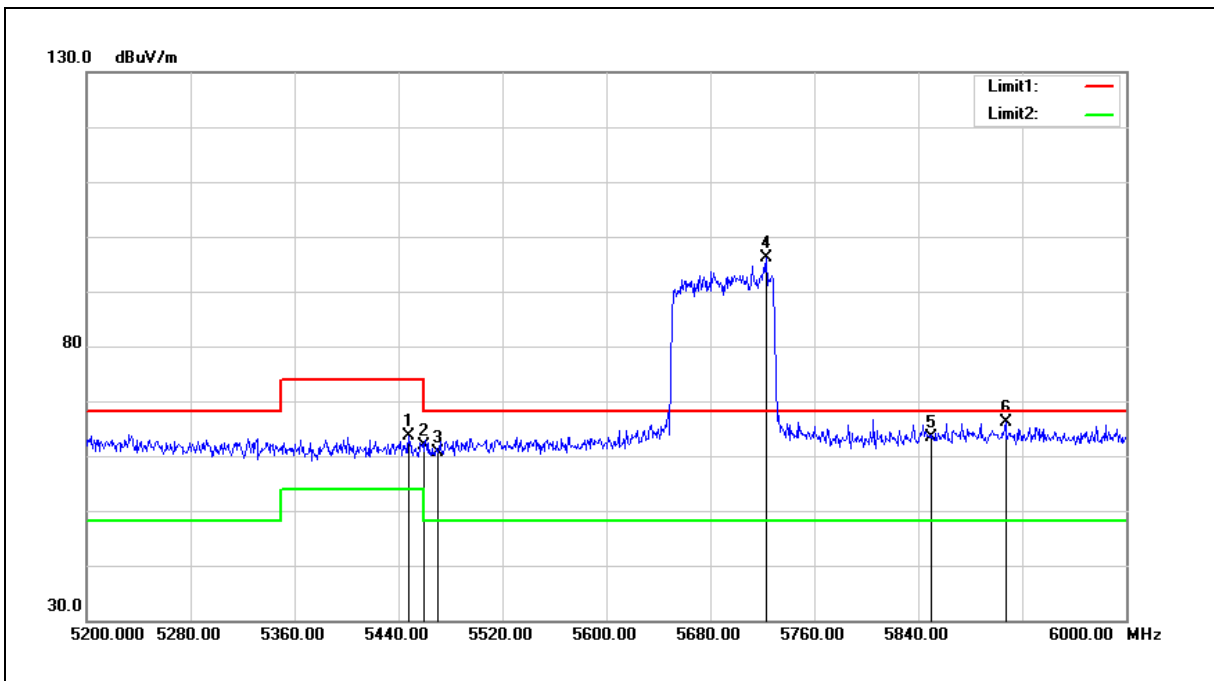

| No. | Frequency (MHz) | Reading (dBuV) | Correct Factor (dB/m) | Result (dBuV/m) | Limit (dBuV/m) | Margin (dB) | Remark |
|-----|-----------------|----------------|-----------------------|-----------------|----------------|-------------|--------|
| 1 | 5448.000 | 58.63 | 4.95 | 63.58 | 74.00 | -10.42 | peak |
| 2 | 5460.000 | 56.91 | 4.97 | 61.88 | 74.00 | -12.12 | peak |
| 3 | 5470.000 | 55.55 | 4.98 | 60.53 | 68.20 | -7.67 | peak |
| 4 | 5723.200 | 90.59 | 5.47 | 96.06 | -- | -- | peak |
| 5 | 5850.000 | 57.72 | 5.72 | 63.44 | 68.20 | -4.76 | peak |
| 6 | 5907.200 | 60.32 | 5.84 | 66.16 | 68.20 | -2.04 | peak |

Note:1.Result (dBuV/m) = Correct Factor (dB/m) + Reading(dBuV).

2.Correction factor (dB/m) = Antenna Factor (dB/m) + Cable loss (dB) – Pre-Amplifier gain (dB).

3.When the peak results are less than average limit, so not need to evaluate the average.



| | | | |
|-------------|-----------------|----------------|-----|
| Standard: | FCC Part 15.407 | Test Distance: | 3 m |
| Test item: | Band edge | | |
| Frequency: | 5690 MHz | | |
| Mode: | Mode 10 | | |
| Ant.Polar.: | Vertical | | |

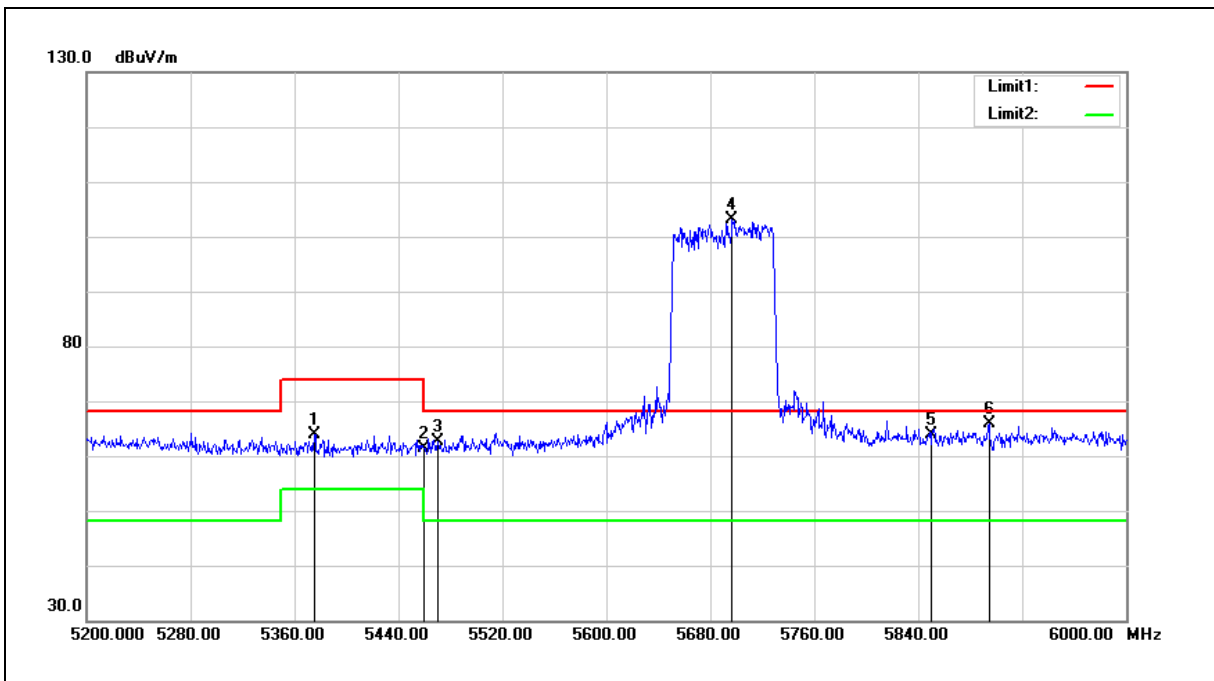

| No. | Frequency (MHz) | Reading (dBuV) | Correct Factor (dB/m) | Result (dBuV/m) | Limit (dBuV/m) | Margin (dB) | Remark |
|-----|-----------------|----------------|-----------------------|-----------------|----------------|-------------|--------|
| 1 | 5375.200 | 59.03 | 4.87 | 63.90 | 74.00 | -10.10 | peak |
| 2 | 5460.000 | 56.43 | 4.97 | 61.40 | 74.00 | -12.60 | peak |
| 3 | 5470.000 | 57.60 | 4.98 | 62.58 | 68.20 | -5.62 | peak |
| 4 | 5696.800 | 97.69 | 5.41 | 103.10 | -- | -- | peak |
| 5 | 5850.000 | 58.04 | 5.72 | 63.76 | 68.20 | -4.44 | peak |
| 6 | 5894.400 | 60.17 | 5.80 | 65.97 | 68.20 | -2.23 | peak |

Note:1.Result (dBuV/m) = Correct Factor (dB/m) + Reading(dBuV).

2.Correction factor (dB/m) = Antenna Factor (dB/m) + Cable loss (dB) – Pre-Amplifier gain (dB).

3.When the peak results are less than average limit, so not need to evaluate the average.



| | | | |
|-------------|-----------------|----------------|-----|
| Standard: | FCC Part 15.407 | Test Distance: | 3 m |
| Test item: | Band edge | | |
| Frequency: | 5775 MHz | | |
| Mode: | Mode 10 | | |
| Ant.Polar.: | Horizontal | | |

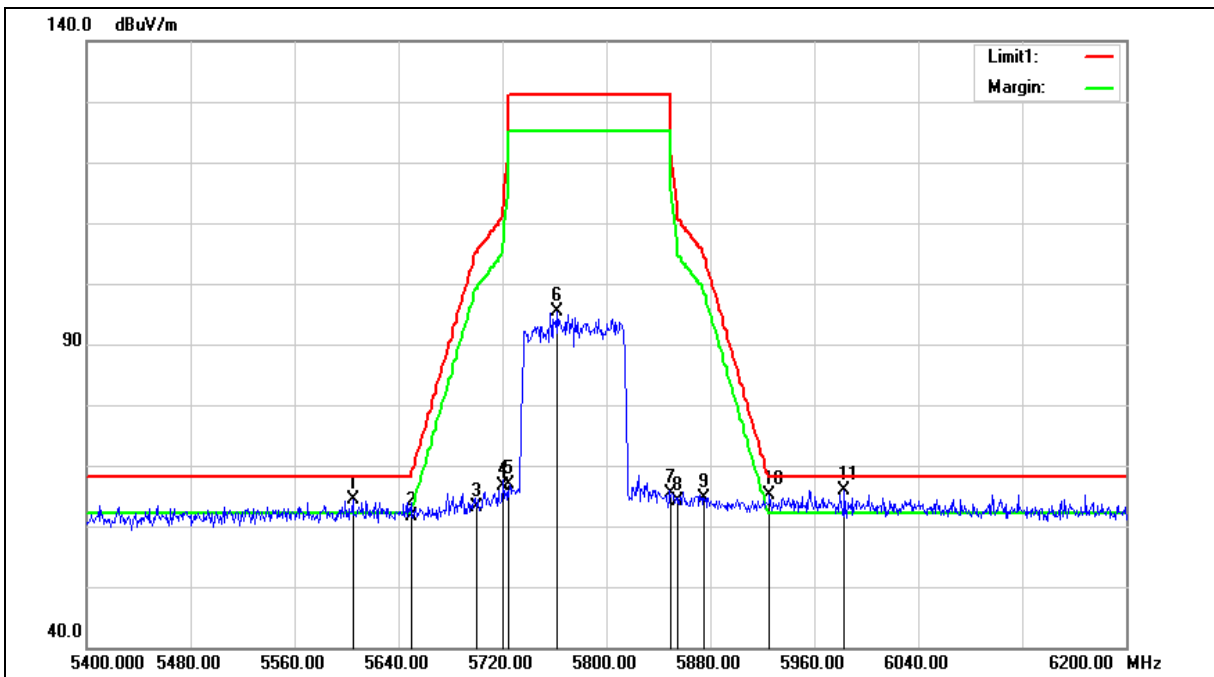



| | | | |
|-------------|-----------------|----------------|-----|
| Standard: | FCC Part 15.407 | Test Distance: | 3 m |
| Test item: | Band edge | | |
| Frequency: | 5775 MHz | | |
| Mode: | Mode 10 | | |
| Ant.Polar.: | Horizontal | | |

| No. | Frequency (MHz) | Reading (dBuV) | Correct Factor (dB/m) | Result (dBuV/m) | Limit (dBuV/m) | Margin (dB) | Remark |
|-----|-----------------|----------------|-----------------------|-----------------|----------------|-------------|--------|
| 1 | 5604.800 | 59.14 | 5.23 | 64.37 | 68.20 | -3.83 | peak |
| 2 | 5650.000 | 56.33 | 5.31 | 61.64 | 68.20 | -6.56 | peak |
| 3 | 5700.000 | 57.60 | 5.42 | 63.02 | 105.20 | -42.18 | peak |
| 4 | 5720.000 | 61.13 | 5.46 | 66.59 | 110.80 | -44.21 | peak |
| 5 | 5725.000 | 61.46 | 5.47 | 66.93 | 122.20 | -55.27 | peak |
| 6 | 5762.400 | 89.76 | 5.54 | 95.30 | -- | -- | peak |
| 7 | 5850.000 | 59.72 | 5.72 | 65.44 | 122.20 | -56.76 | peak |
| 8 | 5855.000 | 58.31 | 5.73 | 64.04 | 110.80 | -46.76 | peak |
| 9 | 5875.000 | 58.82 | 5.77 | 64.59 | 105.20 | -40.61 | peak |
| 10 | 5925.000 | 59.19 | 5.87 | 65.06 | 68.20 | -3.14 | peak |
| 11 | 5983.200 | 59.78 | 5.99 | 65.77 | 68.20 | -2.43 | peak |

Note:1.Result (dBuV/m) = Correct Factor (dB/m) + Reading(dBuV).

2.Correction factor (dB/m) = Antenna Factor (dB/m) + Cable loss (dB) – Pre-Amplifier gain (dB).

3.When the peak results are less than average limit, so not need to evaluate the average.



| | | | |
|-------------|-----------------|----------------|-----|
| Standard: | FCC Part 15.407 | Test Distance: | 3 m |
| Test item: | Band edge | | |
| Frequency: | 5775 MHz | | |
| Mode: | Mode 10 | | |
| Ant.Polar.: | Vertical | | |

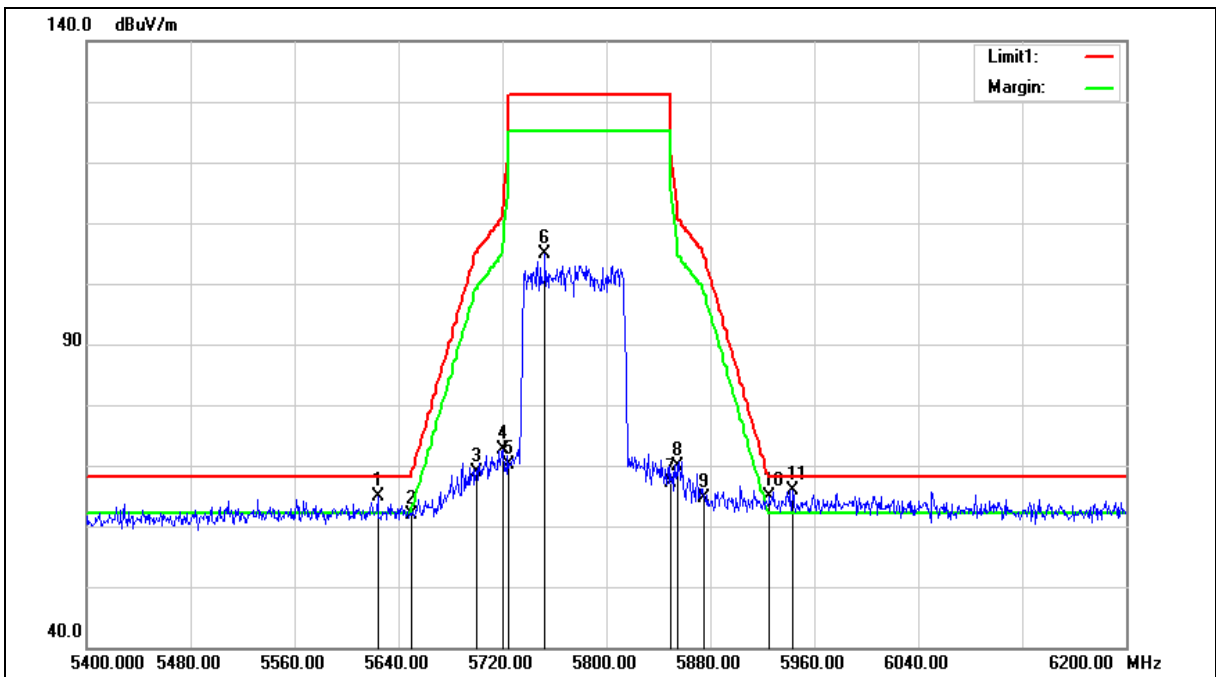



| | | | |
|-------------|-----------------|----------------|-----|
| Standard: | FCC Part 15.407 | Test Distance: | 3 m |
| Test item: | Band edge | | |
| Frequency: | 5775 MHz | | |
| Mode: | Mode 10 | | |
| Ant.Polar.: | Vertical | | |

| No. | Frequency (MHz) | Reading (dBuV) | Correct Factor (dB/m) | Result (dBuV/m) | Limit (dBuV/m) | Margin (dB) | Remark |
|-----|-----------------|----------------|-----------------------|-----------------|----------------|-------------|--------|
| 1 | 5624.000 | 59.71 | 5.26 | 64.97 | 68.20 | -3.23 | peak |
| 2 | 5650.000 | 56.52 | 5.31 | 61.83 | 68.20 | -6.37 | peak |
| 3 | 5700.000 | 63.45 | 5.42 | 68.87 | 105.20 | -36.33 | peak |
| 4 | 5720.000 | 67.11 | 5.46 | 72.57 | 110.80 | -38.23 | peak |
| 5 | 5725.000 | 64.57 | 5.47 | 70.04 | 122.20 | -52.16 | peak |
| 6 | 5752.800 | 99.29 | 5.52 | 104.81 | -- | -- | peak |
| 7 | 5850.000 | 61.42 | 5.72 | 67.14 | 122.20 | -55.06 | peak |
| 8 | 5855.000 | 64.14 | 5.73 | 69.87 | 110.80 | -40.93 | peak |
| 9 | 5875.000 | 58.74 | 5.77 | 64.51 | 105.20 | -40.69 | peak |
| 10 | 5925.000 | 58.99 | 5.87 | 64.86 | 68.20 | -3.34 | peak |
| 11 | 5943.200 | 59.96 | 5.91 | 65.87 | 68.20 | -2.33 | peak |

Note:1.Result (dBuV/m) = Correct Factor (dB/m) + Reading(dBuV).

2.Correction factor (dB/m) = Antenna Factor (dB/m) + Cable loss (dB) – Pre-Amplifier gain (dB).

3.When the peak results are less than average limit, so not need to evaluate the average.

AVG

| | | | |
|-------------|-----------------|----------------|-----|
| Standard: | FCC Part 15.407 | Test Distance: | 3 m |
| Test item: | Band edge | | |
| Frequency: | 5180 MHz | | |
| Mode: | Mode 2 | | |
| Ant.Polar.: | Horizontal | | |

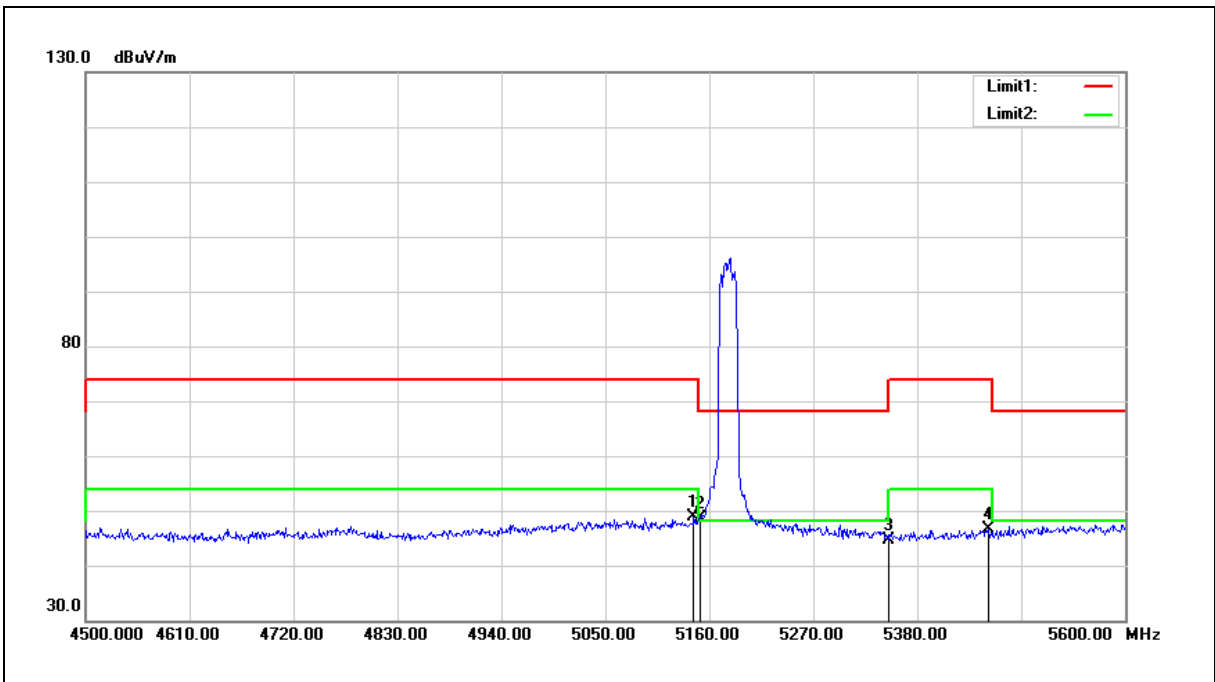

| No. | Frequency (MHz) | Reading (dBuV) | Correct Factor (dB/m) | Result (dBuV/m) | Limit (dBuV/m) | Margin (dB) | Remark |
|-----|-----------------|----------------|-----------------------|-----------------|----------------|-------------|--------|
| 1 | 5143.500 | 44.39 | 4.59 | 48.98 | 54.00 | -5.02 | AVG |
| 2 | 5150.000 | 44.09 | 4.60 | 48.69 | 54.00 | -5.31 | AVG |
| 3 | 5350.000 | 39.81 | 4.84 | 44.65 | 54.00 | -9.35 | AVG |
| 4 | 5455.900 | 41.64 | 4.96 | 46.60 | 54.00 | -7.40 | AVG |

Note:1.Result (dBuV/m) = Correct Factor (dB/m) + Reading(dBuV).

2.Correction factor (dB/m) = Antenna Factor (dB/m) + Cable loss (dB) – Pre-Amplifier gain (dB).

3.When the peak results are less than average limit, so not need to evaluate the average.



| | | | |
|-------------|-----------------|----------------|-----|
| Standard: | FCC Part 15.407 | Test Distance: | 3 m |
| Test item: | Band edge | | |
| Frequency: | 5180 MHz | | |
| Mode: | Mode 2 | | |
| Ant.Polar.: | Vertical | | |

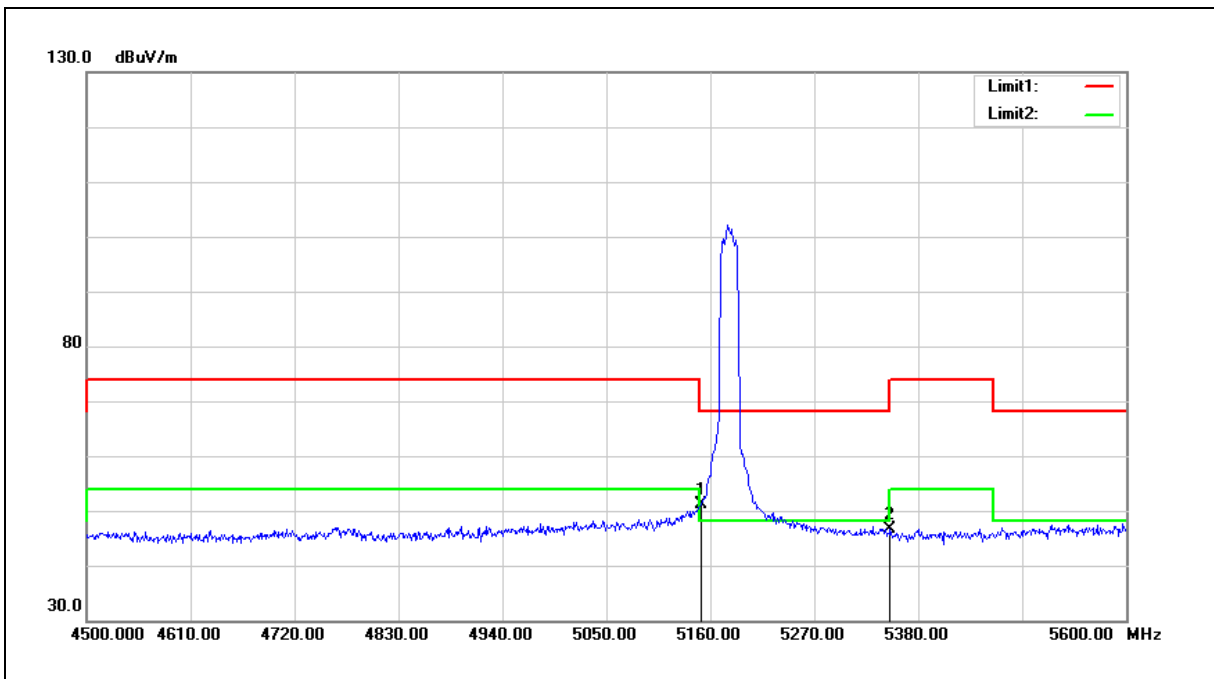

| No. | Frequency (MHz) | Reading (dBuV) | Correct Factor (dB/m) | Result (dBuV/m) | Limit (dBuV/m) | Margin (dB) | Remark |
|-----|-----------------|----------------|-----------------------|-----------------|----------------|-------------|--------|
| 1 | 5150.000 | 46.61 | 4.60 | 51.21 | 54.00 | -2.79 | AVG |
| 2 | 5350.000 | 41.89 | 4.84 | 46.73 | 54.00 | -7.27 | AVG |

Note:1.Result (dBuV/m) = Correct Factor (dB/m) + Reading(dBuV).

2.Correction factor (dB/m) = Antenna Factor (dB/m) + Cable loss (dB) – Pre-Amplifier gain (dB).

3.When the peak results are less than average limit, so not need to evaluate the average.



| | | | |
|-------------|-----------------|----------------|-----|
| Standard: | FCC Part 15.407 | Test Distance: | 3 m |
| Test item: | Band edge | | |
| Frequency: | 5200 MHz | | |
| Mode: | Mode 2 | | |
| Ant.Polar.: | Horizontal | | |

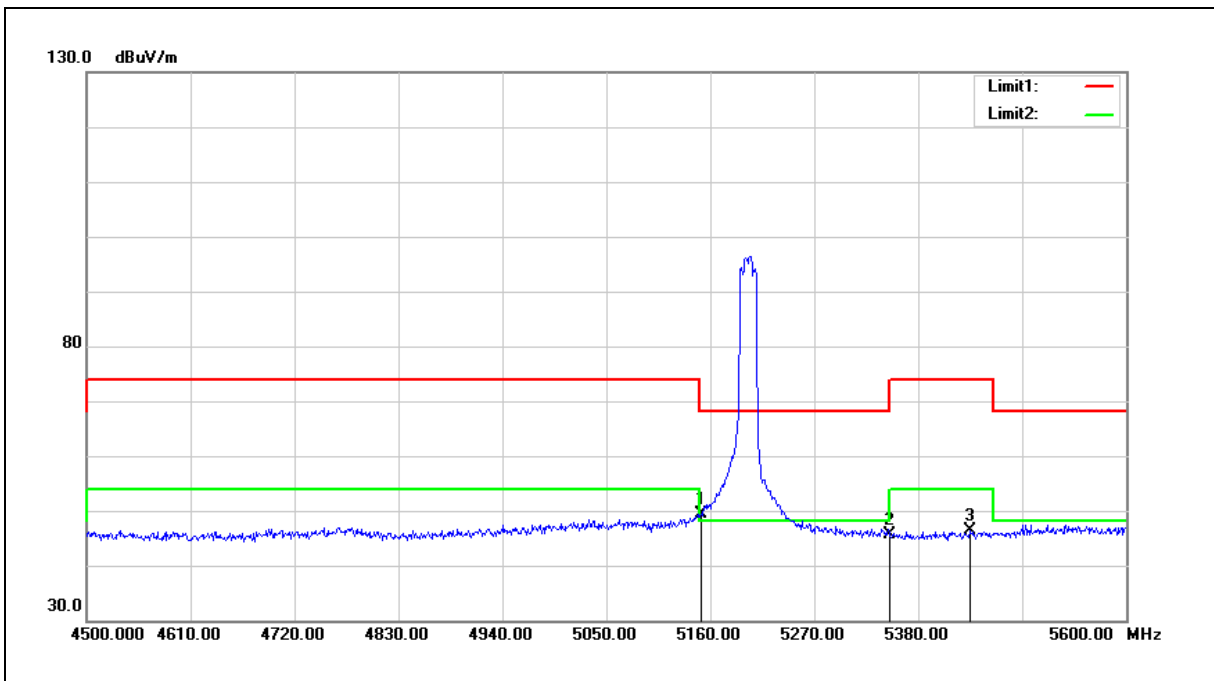

| No. | Frequency (MHz) | Reading (dBuV) | Correct Factor (dB/m) | Result (dBuV/m) | Limit (dBuV/m) | Margin (dB) | Remark |
|-----|-----------------|----------------|-----------------------|-----------------|----------------|-------------|--------|
| 1 | 5150.000 | 44.75 | 4.60 | 49.35 | 54.00 | -4.65 | AVG |
| 2 | 5350.000 | 40.72 | 4.84 | 45.56 | 54.00 | -8.44 | AVG |
| 3 | 5435.000 | 41.32 | 4.94 | 46.26 | 54.00 | -7.74 | AVG |

Note:1.Result (dBuV/m) = Correct Factor (dB/m) + Reading(dBuV).

2.Correction factor (dB/m) = Antenna Factor (dB/m) + Cable loss (dB) – Pre-Amplifier gain (dB).

3.When the peak results are less than average limit, so not need to evaluate the average.



| | | | |
|-------------|-----------------|----------------|-----|
| Standard: | FCC Part 15.407 | Test Distance: | 3 m |
| Test item: | Band edge | | |
| Frequency: | 5200 MHz | | |
| Mode: | Mode 2 | | |
| Ant.Polar.: | Vertical | | |

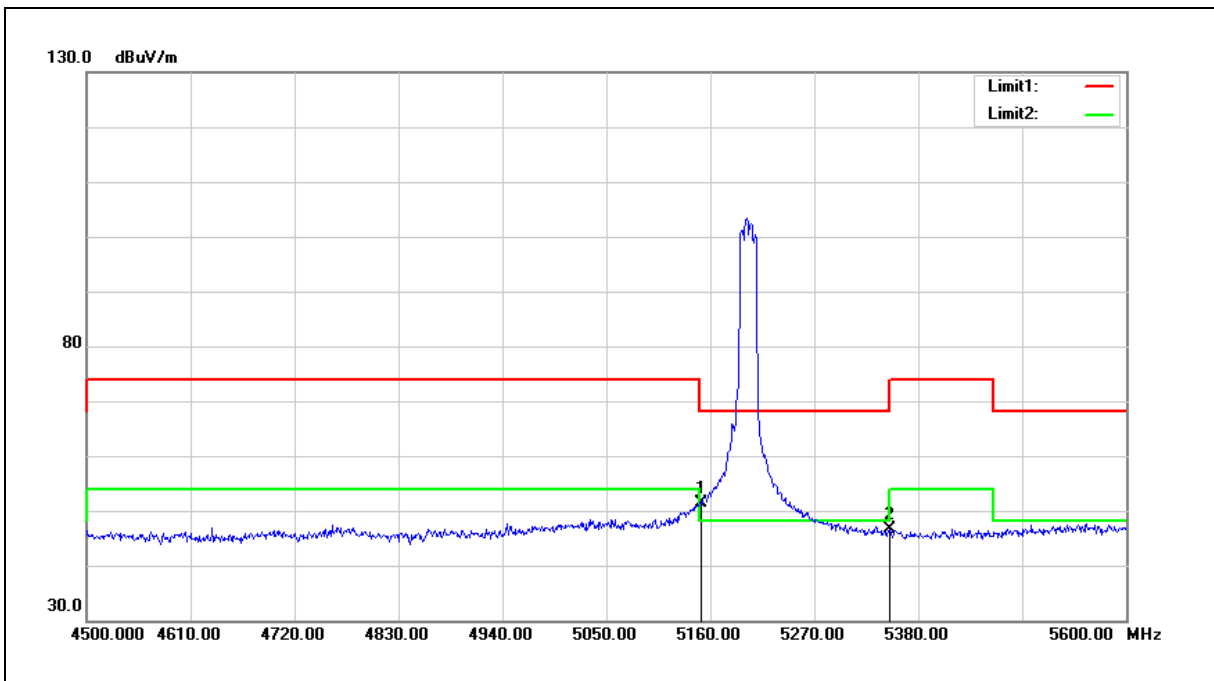

| No. | Frequency (MHz) | Reading (dBuV) | Correct Factor (dB/m) | Result (dBuV/m) | Limit (dBuV/m) | Margin (dB) | Remark |
|-----|-----------------|----------------|-----------------------|-----------------|----------------|-------------|--------|
| 1 | 5150.000 | 46.87 | 4.60 | 51.47 | 54.00 | -2.53 | AVG |
| 2 | 5350.000 | 41.81 | 4.84 | 46.65 | 54.00 | -7.35 | AVG |

Note:1.Result (dBuV/m) = Correct Factor (dB/m) + Reading(dBuV).

2.Correction factor (dB/m) = Antenna Factor (dB/m) + Cable loss (dB) – Pre-Amplifier gain (dB).

3.When the peak results are less than average limit, so not need to evaluate the average.



| | | | |
|-------------|-----------------|----------------|-----|
| Standard: | FCC Part 15.407 | Test Distance: | 3 m |
| Test item: | Band edge | | |
| Frequency: | 5240 MHz | | |
| Mode: | Mode 2 | | |
| Ant.Polar.: | Horizontal | | |

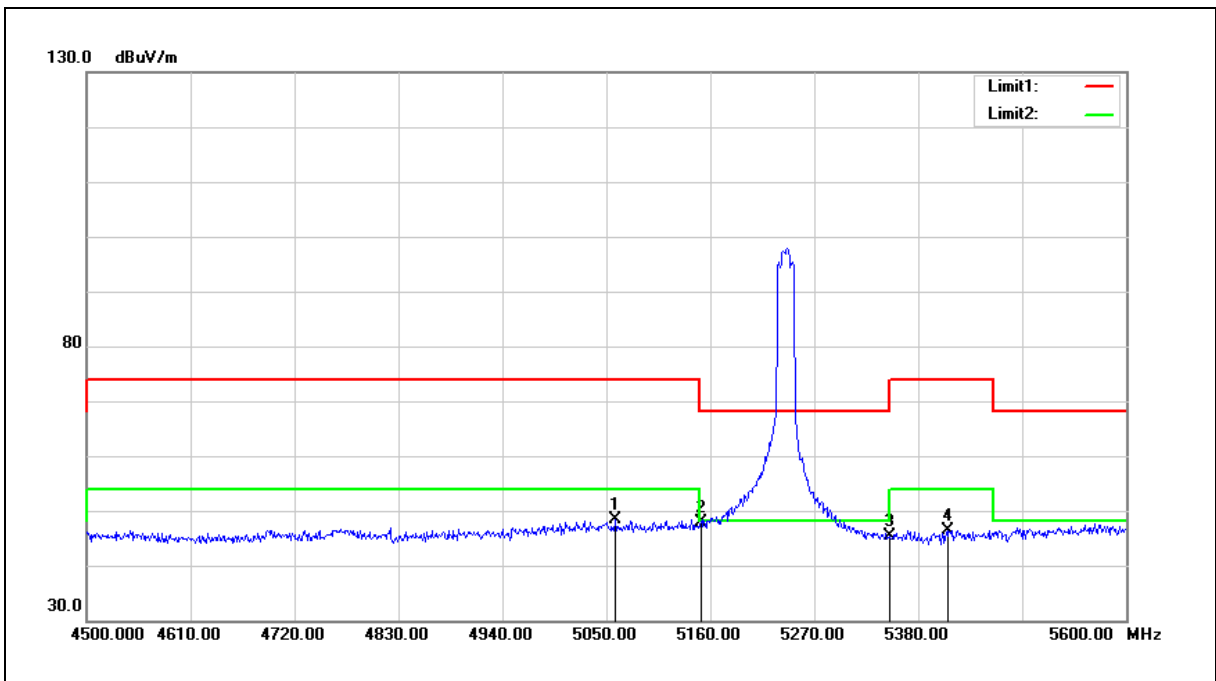

| No. | Frequency (MHz) | Reading (dBuV) | Correct Factor (dB/m) | Result (dBuV/m) | Limit (dBuV/m) | Margin (dB) | Remark |
|-----|-----------------|----------------|-----------------------|-----------------|----------------|-------------|--------|
| 1 | 5059.900 | 43.94 | 4.49 | 48.43 | 54.00 | -5.57 | AVG |
| 2 | 5150.000 | 43.40 | 4.60 | 48.00 | 54.00 | -6.00 | AVG |
| 3 | 5350.000 | 40.64 | 4.84 | 45.48 | 54.00 | -8.52 | AVG |
| 4 | 5411.900 | 41.59 | 4.91 | 46.50 | 54.00 | -7.50 | AVG |

Note:1.Result (dBuV/m) = Correct Factor (dB/m) + Reading(dBuV).

2.Correction factor (dB/m) = Antenna Factor (dB/m) + Cable loss (dB) – Pre-Amplifier gain (dB).

3.When the peak results are less than average limit, so not need to evaluate the average.



| | | | |
|-------------|-----------------|----------------|-----|
| Standard: | FCC Part 15.407 | Test Distance: | 3 m |
| Test item: | Band edge | | |
| Frequency: | 5240 MHz | | |
| Mode: | Mode 2 | | |
| Ant.Polar.: | Vertical | | |

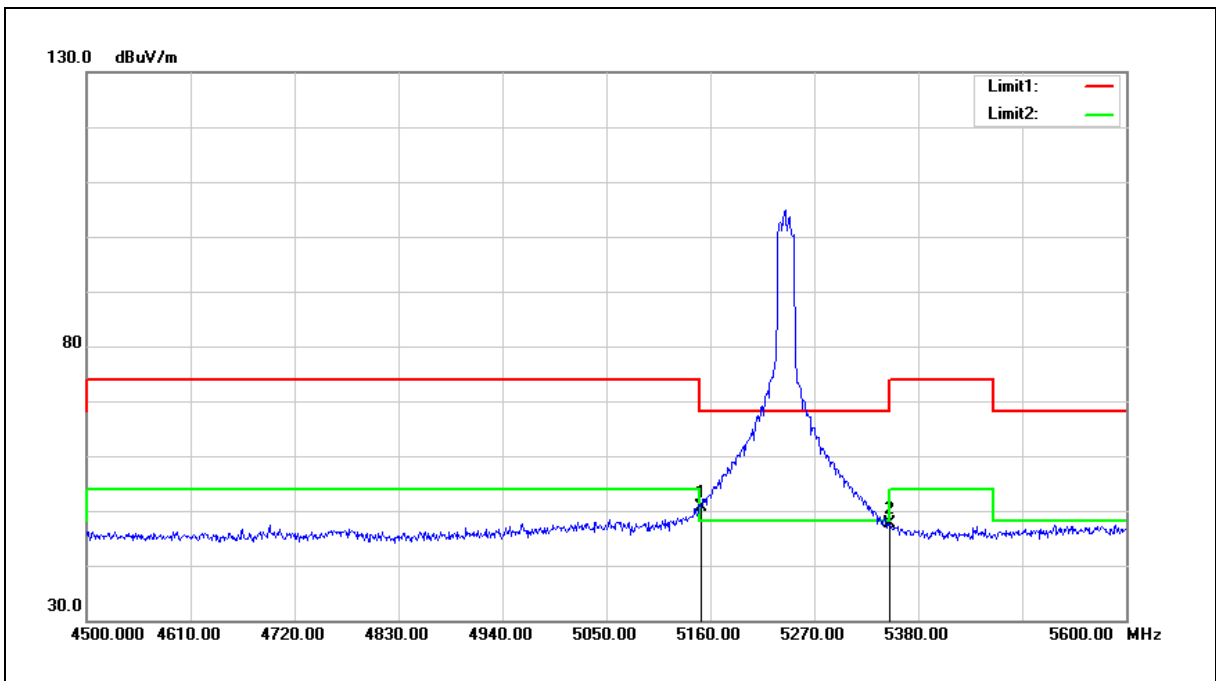

| No. | Frequency (MHz) | Reading (dBuV) | Correct Factor (dB/m) | Result (dBuV/m) | Limit (dBuV/m) | Margin (dB) | Remark |
|-----|-----------------|----------------|-----------------------|-----------------|----------------|-------------|--------|
| 1 | 5150.000 | 46.00 | 4.60 | 50.60 | 54.00 | -3.40 | AVG |
| 2 | 5350.000 | 42.91 | 4.84 | 47.75 | 54.00 | -6.25 | AVG |

Note:1.Result (dBuV/m) = Correct Factor (dB/m) + Reading(dBuV).

2.Correction factor (dB/m) = Antenna Factor (dB/m) + Cable loss (dB) – Pre-Amplifier gain (dB).

3.When the peak results are less than average limit, so not need to evaluate the average.



| | | | |
|-------------|-----------------|----------------|-----|
| Standard: | FCC Part 15.407 | Test Distance: | 3 m |
| Test item: | Band edge | | |
| Frequency: | 5260 MHz | | |
| Mode: | Mode 2 | | |
| Ant.Polar.: | Horizontal | | |

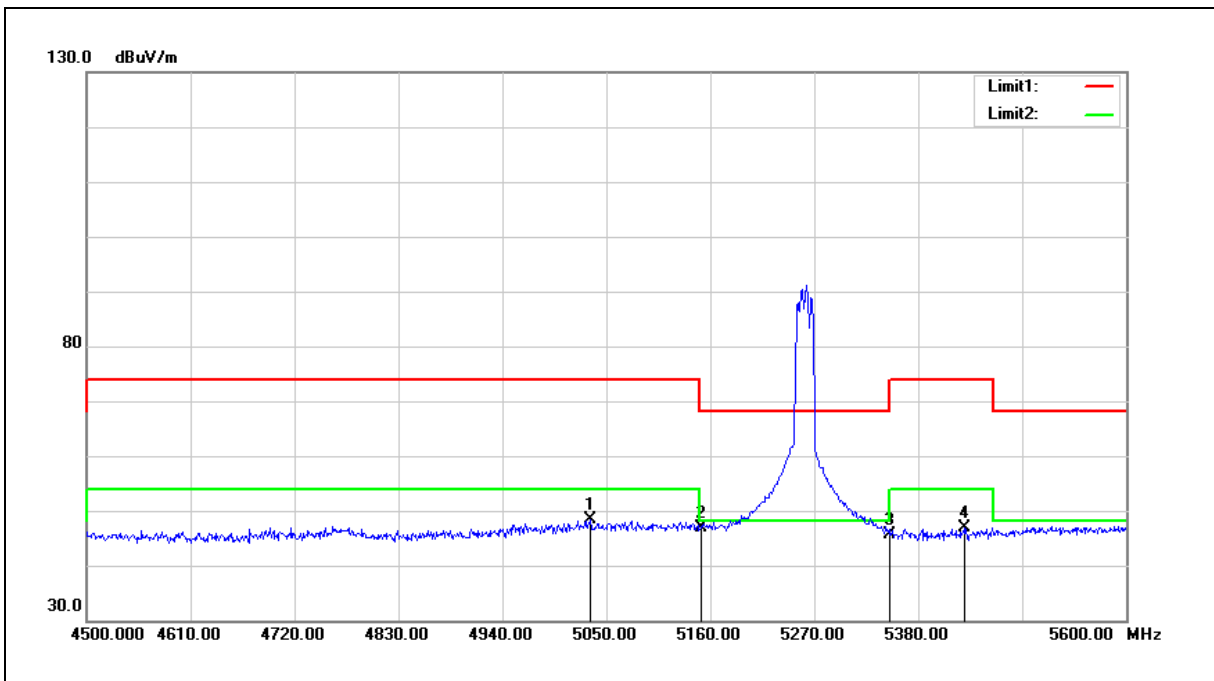

| No. | Frequency (MHz) | Reading (dBuV) | Correct Factor (dB/m) | Result (dBuV/m) | Limit (dBuV/m) | Margin (dB) | Remark |
|-----|-----------------|----------------|-----------------------|-----------------|----------------|-------------|--------|
| 1 | 5033.500 | 43.96 | 4.46 | 48.42 | 54.00 | -5.58 | AVG |
| 2 | 5150.000 | 42.34 | 4.60 | 46.94 | 54.00 | -7.06 | AVG |
| 3 | 5350.000 | 40.74 | 4.84 | 45.58 | 54.00 | -8.42 | AVG |
| 4 | 5429.500 | 41.95 | 4.93 | 46.88 | 54.00 | -7.12 | AVG |

Note:1.Result (dBuV/m) = Correct Factor (dB/m) + Reading(dBuV).

2.Correction factor (dB/m) = Antenna Factor (dB/m) + Cable loss (dB) – Pre-Amplifier gain (dB).

3.When the peak results are less than average limit, so not need to evaluate the average.



| | | | |
|-------------|-----------------|----------------|-----|
| Standard: | FCC Part 15.407 | Test Distance: | 3 m |
| Test item: | Band edge | | |
| Frequency: | 5260 MHz | | |
| Mode: | Mode 2 | | |
| Ant.Polar.: | Vertical | | |

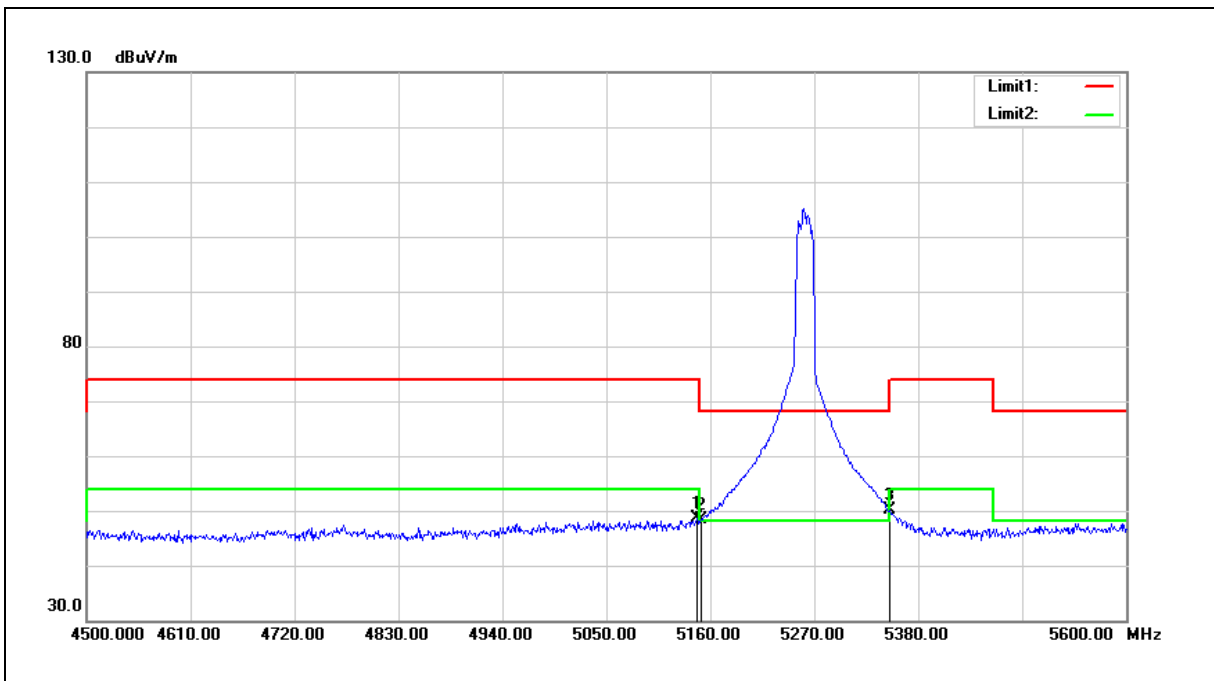

| No. | Frequency (MHz) | Reading (dBuV) | Correct Factor (dB/m) | Result (dBuV/m) | Limit (dBuV/m) | Margin (dB) | Remark |
|-----|-----------------|----------------|-----------------------|-----------------|----------------|-------------|--------|
| 1 | 5145.700 | 43.94 | 4.60 | 48.54 | 54.00 | -5.46 | AVG |
| 2 | 5150.000 | 43.68 | 4.60 | 48.28 | 54.00 | -5.72 | AVG |
| 3 | 5350.000 | 45.19 | 4.84 | 50.03 | 54.00 | -3.97 | AVG |

Note:1.Result (dBuV/m) = Correct Factor (dB/m) + Reading(dBuV).

2.Correction factor (dB/m) = Antenna Factor (dB/m) + Cable loss (dB) – Pre-Amplifier gain (dB).

3.When the peak results are less than average limit, so not need to evaluate the average.



| | | | |
|-------------|-----------------|----------------|-----|
| Standard: | FCC Part 15.407 | Test Distance: | 3 m |
| Test item: | Band edge | | |
| Frequency: | 5280 MHz | | |
| Mode: | Mode 2 | | |
| Ant.Polar.: | Horizontal | | |

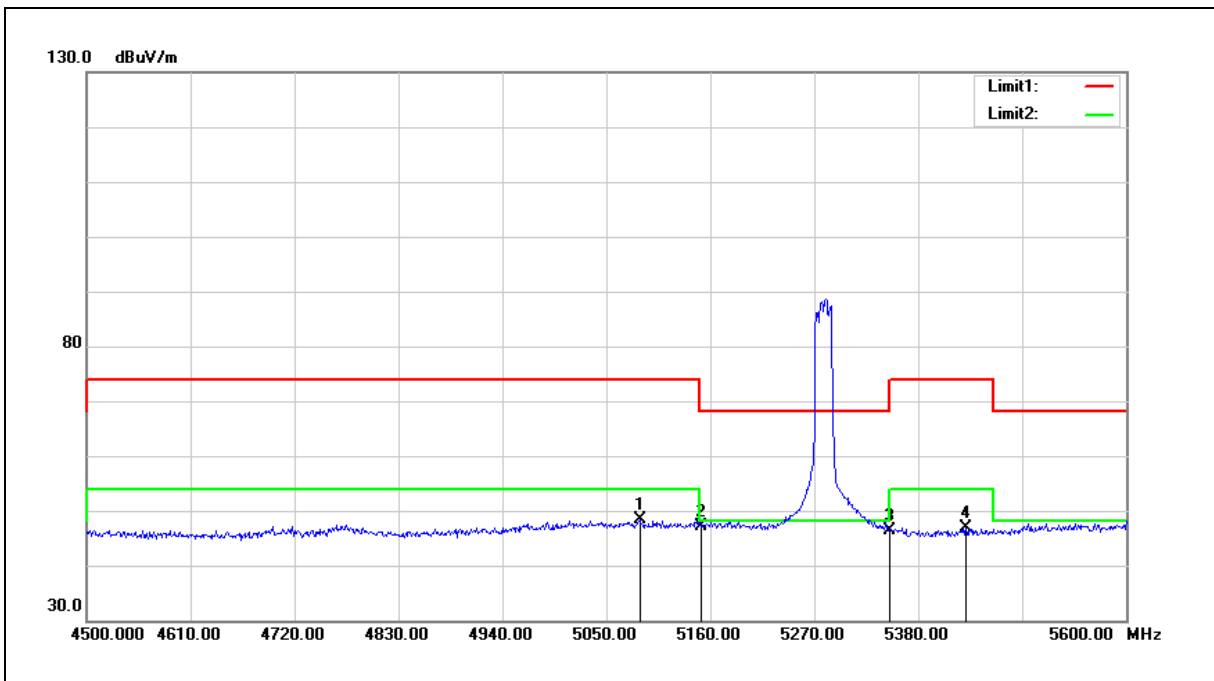

| No. | Frequency (MHz) | Reading (dBuV) | Correct Factor (dB/m) | Result (dBuV/m) | Limit (dBuV/m) | Margin (dB) | Remark |
|-----|-----------------|----------------|-----------------------|-----------------|----------------|-------------|--------|
| 1 | 5085.200 | 43.92 | 4.52 | 48.44 | 54.00 | -5.56 | AVG |
| 2 | 5150.000 | 42.47 | 4.60 | 47.07 | 54.00 | -6.93 | AVG |
| 3 | 5350.000 | 41.64 | 4.84 | 46.48 | 54.00 | -7.52 | AVG |
| 4 | 5430.600 | 41.92 | 4.93 | 46.85 | 54.00 | -7.15 | AVG |

Note:1.Result (dBuV/m) = Correct Factor (dB/m) + Reading(dBuV).

2.Correction factor (dB/m) = Antenna Factor (dB/m) + Cable loss (dB) – Pre-Amplifier gain (dB).

3.When the peak results are less than average limit, so not need to evaluate the average.



| | | | |
|-------------|-----------------|----------------|-----|
| Standard: | FCC Part 15.407 | Test Distance: | 3 m |
| Test item: | Band edge | | |
| Frequency: | 5280 MHz | | |
| Mode: | Mode 2 | | |
| Ant.Polar.: | Vertical | | |

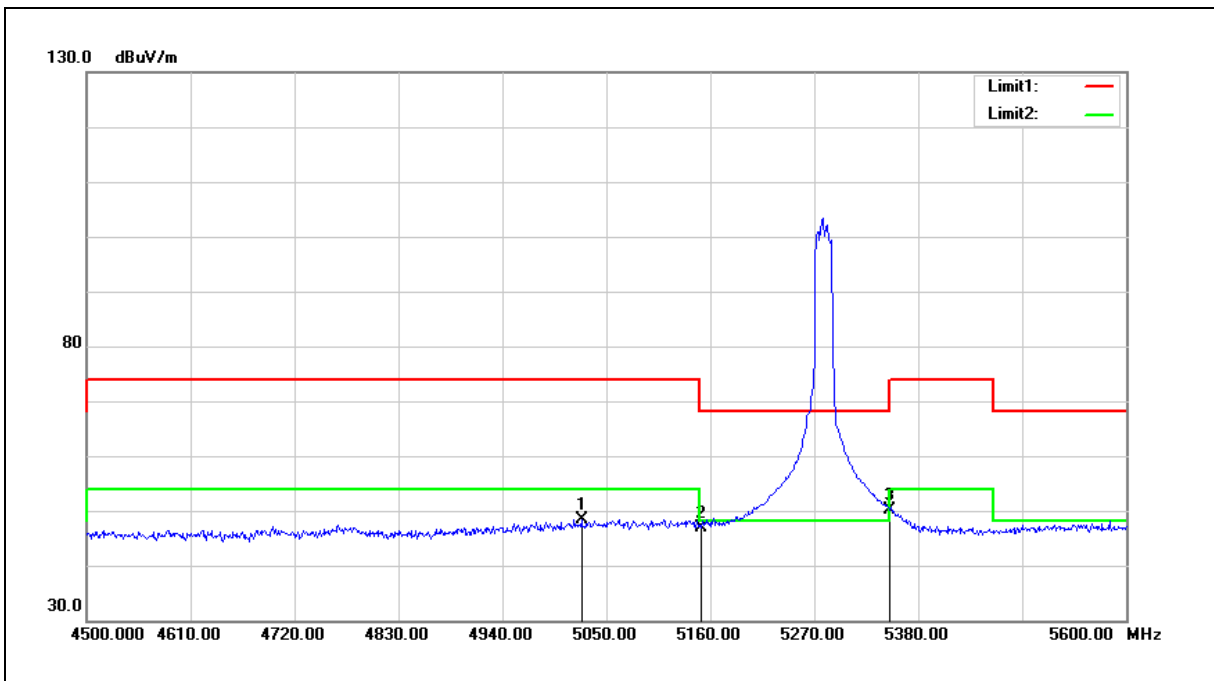

| No. | Frequency (MHz) | Reading (dBuV) | Correct Factor (dB/m) | Result (dBuV/m) | Limit (dBuV/m) | Margin (dB) | Remark |
|-----|-----------------|----------------|-----------------------|-----------------|----------------|-------------|--------|
| 1 | 5023.600 | 44.03 | 4.45 | 48.48 | 54.00 | -5.52 | AVG |
| 2 | 5150.000 | 42.22 | 4.60 | 46.82 | 54.00 | -7.18 | AVG |
| 3 | 5350.000 | 45.39 | 4.84 | 50.23 | 54.00 | -3.77 | AVG |

Note:1.Result (dBuV/m) = Correct Factor (dB/m) + Reading(dBuV).

2.Correction factor (dB/m) = Antenna Factor (dB/m) + Cable loss (dB) – Pre-Amplifier gain (dB).

3.When the peak results are less than average limit, so not need to evaluate the average.



| | | | |
|-------------|-----------------|----------------|-----|
| Standard: | FCC Part 15.407 | Test Distance: | 3 m |
| Test item: | Band edge | | |
| Frequency: | 5320 MHz | | |
| Mode: | Mode 2 | | |
| Ant.Polar.: | Horizontal | | |

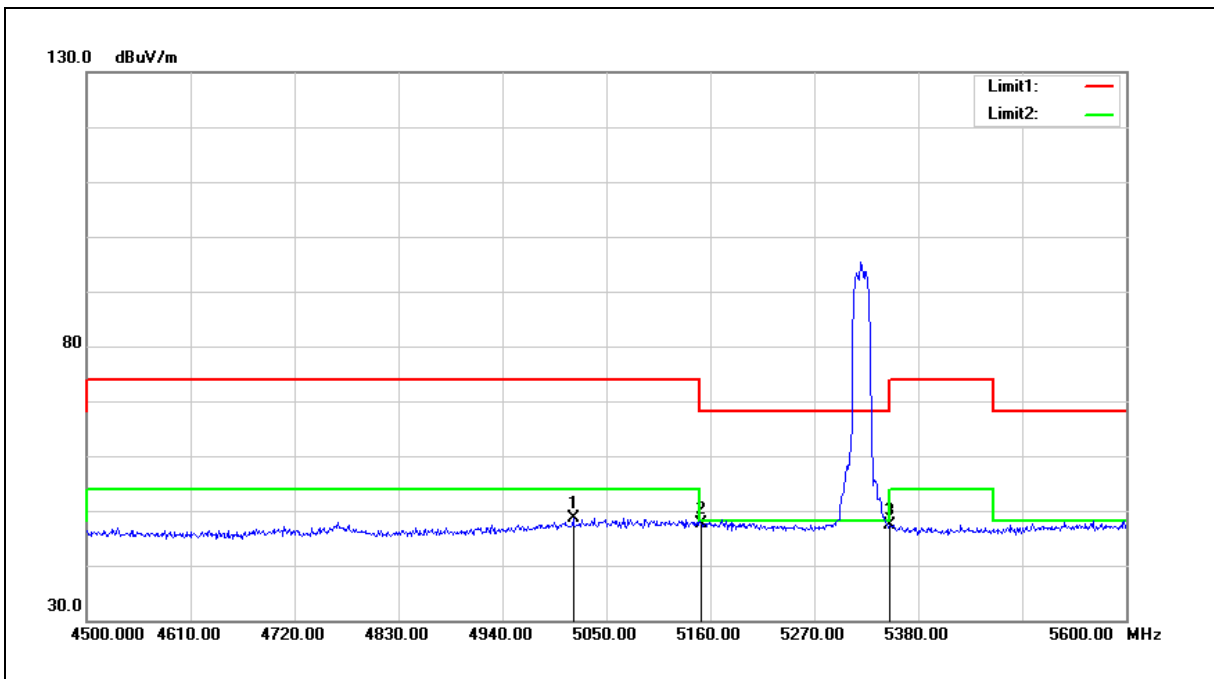

| No. | Frequency (MHz) | Reading (dBuV) | Correct Factor (dB/m) | Result (dBuV/m) | Limit (dBuV/m) | Margin (dB) | Remark |
|-----|-----------------|----------------|-----------------------|-----------------|----------------|-------------|--------|
| 1 | 5014.800 | 44.30 | 4.44 | 48.74 | 54.00 | -5.26 | AVG |
| 2 | 5150.000 | 42.95 | 4.60 | 47.55 | 54.00 | -6.45 | AVG |
| 3 | 5350.000 | 42.66 | 4.84 | 47.50 | 54.00 | -6.50 | AVG |

Note:1.Result (dBuV/m) = Correct Factor (dB/m) + Reading(dBuV).

2.Correction factor (dB/m) = Antenna Factor (dB/m) + Cable loss (dB) – Pre-Amplifier gain (dB).

3.When the peak results are less than average limit, so not need to evaluate the average.



| | | | |
|-------------|-----------------|----------------|-----|
| Standard: | FCC Part 15.407 | Test Distance: | 3 m |
| Test item: | Band edge | | |
| Frequency: | 5320 MHz | | |
| Mode: | Mode 2 | | |
| Ant.Polar.: | Vertical | | |

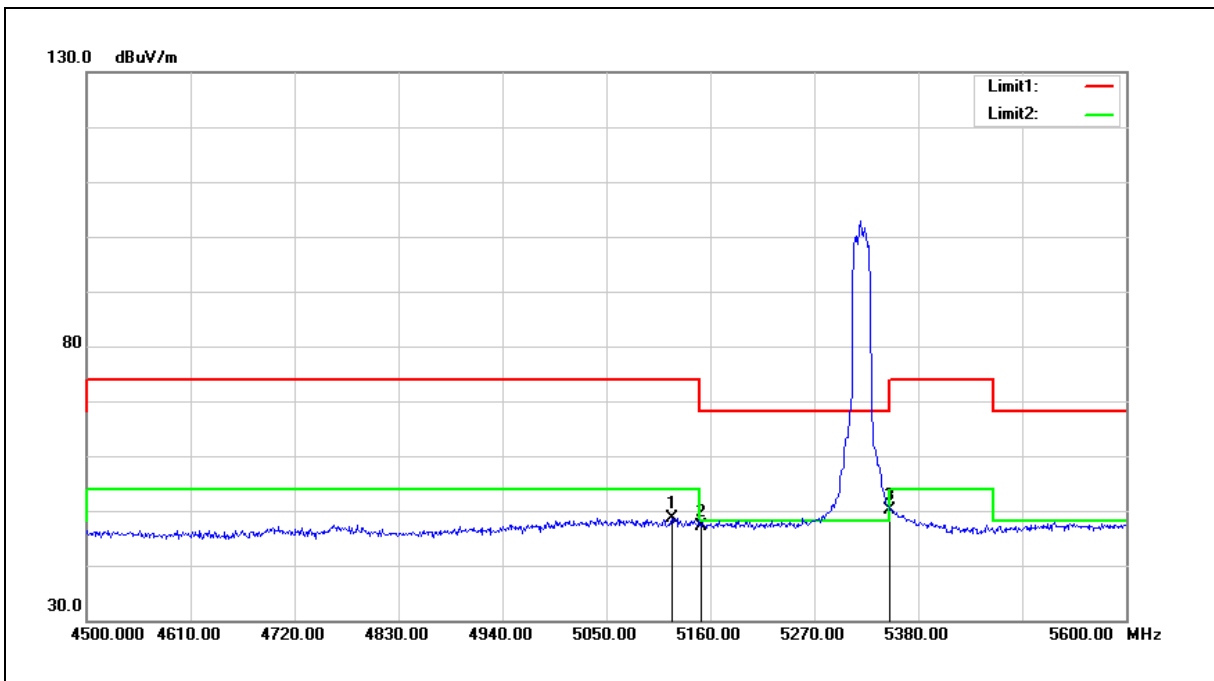

| No. | Frequency (MHz) | Reading (dBuV) | Correct Factor (dB/m) | Result (dBuV/m) | Limit (dBuV/m) | Margin (dB) | Remark |
|-----|-----------------|----------------|-----------------------|-----------------|----------------|-------------|--------|
| 1 | 5119.300 | 44.03 | 4.57 | 48.60 | 54.00 | -5.40 | AVG |
| 2 | 5150.000 | 42.48 | 4.60 | 47.08 | 54.00 | -6.92 | AVG |
| 3 | 5350.000 | 45.38 | 4.84 | 50.22 | 54.00 | -3.78 | AVG |

Note:1.Result (dBuV/m) = Correct Factor (dB/m) + Reading(dBuV).

2.Correction factor (dB/m) = Antenna Factor (dB/m) + Cable loss (dB) – Pre-Amplifier gain (dB).

3.When the peak results are less than average limit, so not need to evaluate the average.



| | | | |
|-------------|-----------------|----------------|-----|
| Standard: | FCC Part 15.407 | Test Distance: | 3 m |
| Test item: | Band edge | | |
| Frequency: | 5500 MHz | | |
| Mode: | Mode 2 | | |
| Ant.Polar.: | Horizontal | | |

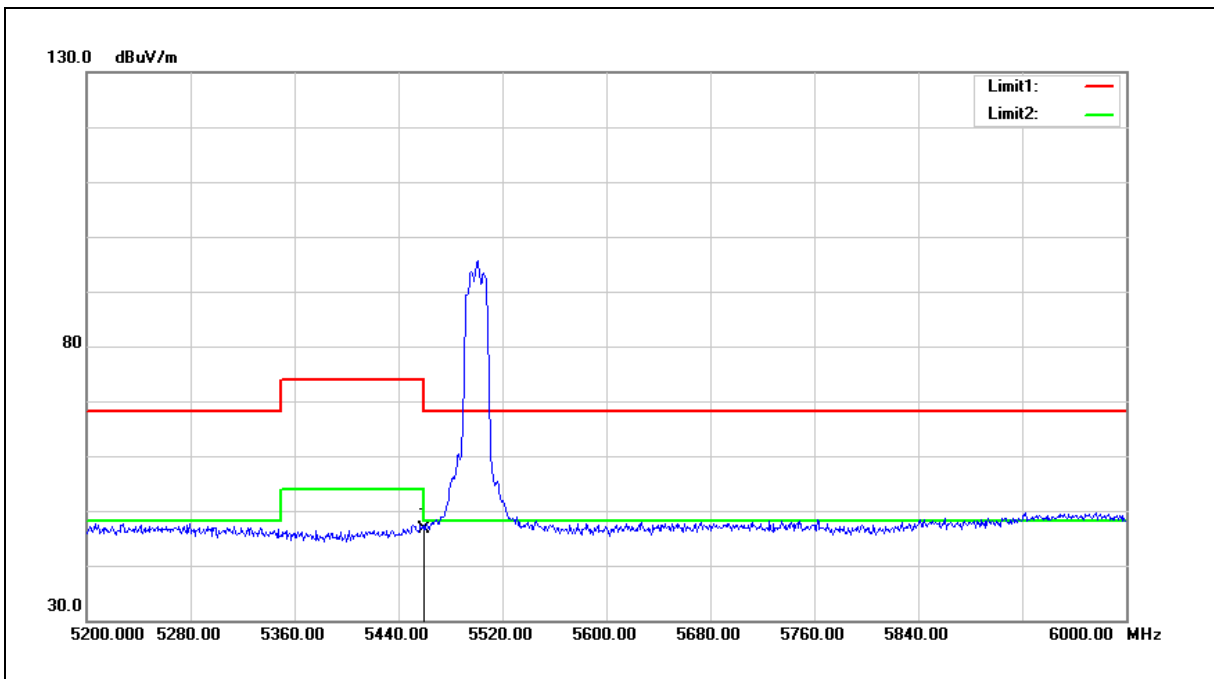

| No. | Frequency (MHz) | Reading (dBuV) | Correct Factor (dB/m) | Result (dBuV/m) | Limit (dBuV/m) | Margin (dB) | Remark |
|-----|-----------------|----------------|-----------------------|-----------------|----------------|-------------|--------|
| 1 | 5460.000 | 41.77 | 4.97 | 46.74 | 54.00 | -7.26 | AVG |

- Note:1.Result (dBuV/m) = Correct Factor (dB/m) + Reading(dBuV).
 2.Correction factor (dB/m) = Antenna Factor (dB/m) + Cable loss (dB) – Pre-Amplifier gain (dB).
 3.When the peak results are less than average limit, so not need to evaluate the average.



| | | | |
|-------------|-----------------|----------------|-----|
| Standard: | FCC Part 15.407 | Test Distance: | 3 m |
| Test item: | Band edge | | |
| Frequency: | 5500 MHz | | |
| Mode: | Mode 2 | | |
| Ant.Polar.: | Vertical | | |

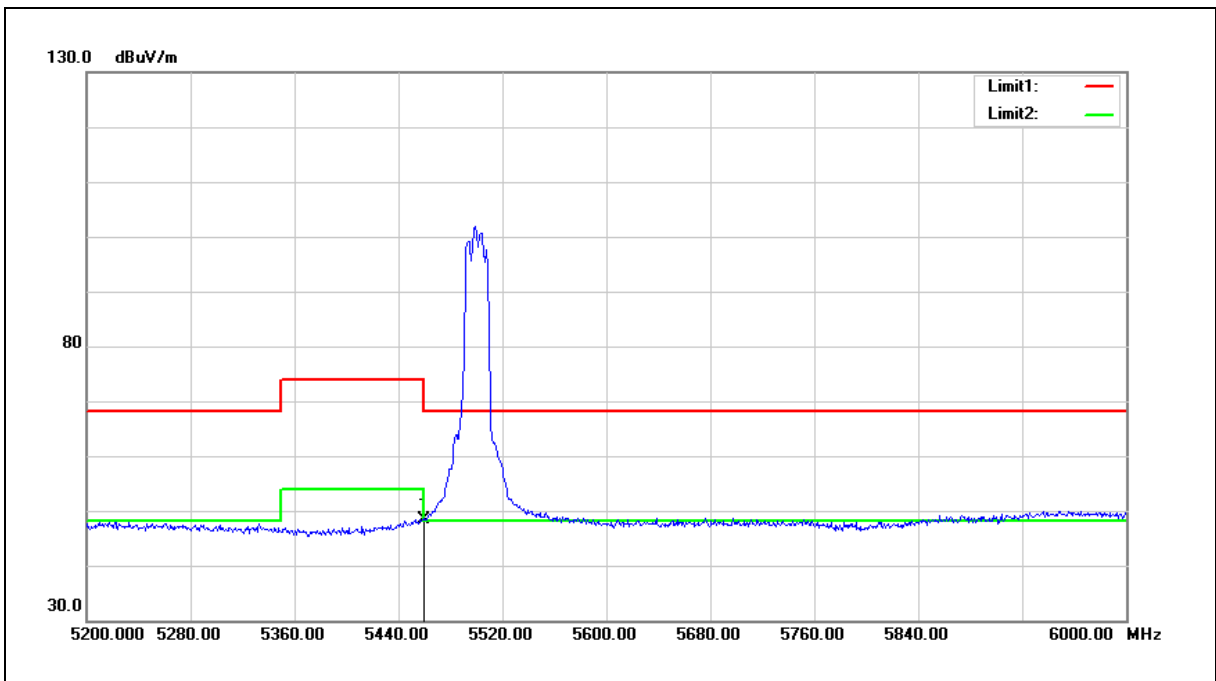

| No. | Frequency (MHz) | Reading (dBuV) | Correct Factor (dB/m) | Result (dBuV/m) | Limit (dBuV/m) | Margin (dB) | Remark |
|-----|-----------------|----------------|-----------------------|-----------------|----------------|-------------|--------|
| 1 | 5460.000 | 43.49 | 4.97 | 48.46 | 54.00 | -5.54 | AVG |

Note:1.Result (dBuV/m) = Correct Factor (dB/m) + Reading(dBuV).

2.Correction factor (dB/m) = Antenna Factor (dB/m) + Cable loss (dB) – Pre-Amplifier gain (dB).

3.When the peak results are less than average limit, so not need to evaluate the average.



| | | | |
|-------------|-----------------|----------------|-----|
| Standard: | FCC Part 15.407 | Test Distance: | 3 m |
| Test item: | Band edge | | |
| Frequency: | 5560 MHz | | |
| Mode: | Mode 2 | | |
| Ant.Polar.: | Horizontal | | |

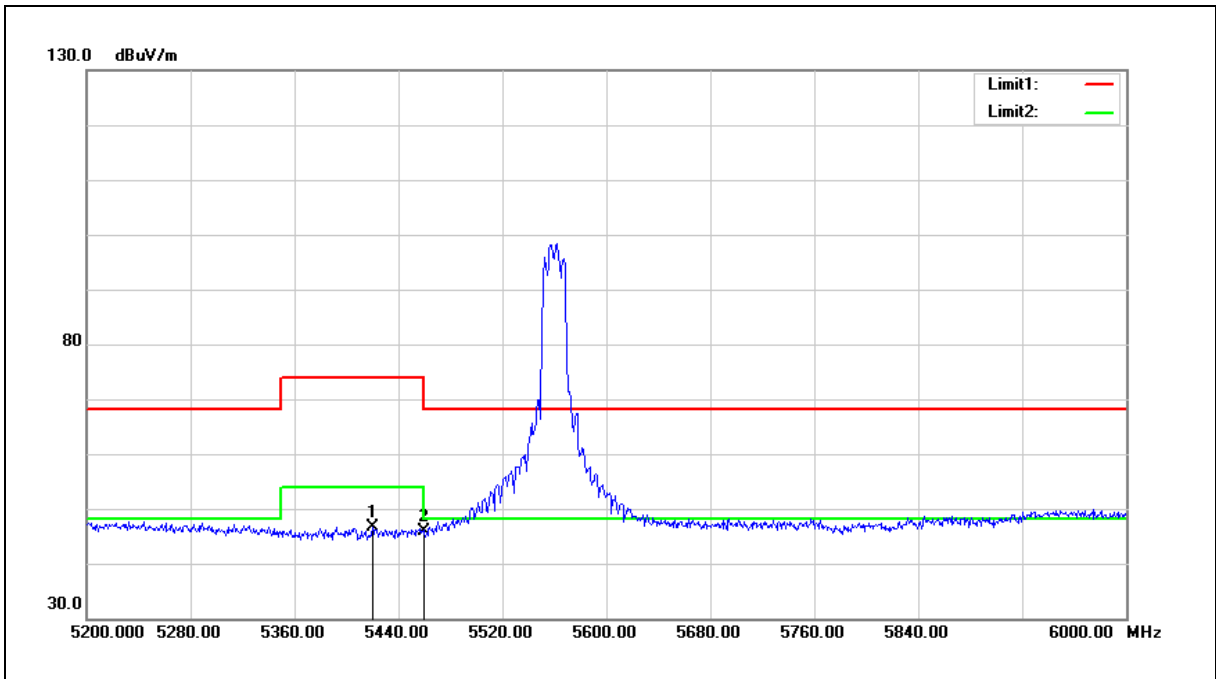

| No. | Frequency (MHz) | Reading (dBuV) | Correct Factor (dB/m) | Result (dBuV/m) | Limit (dBuV/m) | Margin (dB) | Remark |
|-----|-----------------|----------------|-----------------------|-----------------|----------------|-------------|--------|
| 1 | 5420.000 | 41.80 | 4.92 | 46.72 | 54.00 | -7.28 | AVG |
| 2 | 5460.000 | 40.81 | 4.97 | 45.78 | 54.00 | -8.22 | AVG |

Note:1.Result (dBuV/m) = Correct Factor (dB/m) + Reading(dBuV).

2.Correction factor (dB/m) = Antenna Factor (dB/m) + Cable loss (dB) – Pre-Amplifier gain (dB).

3.When the peak results are less than average limit, so not need to evaluate the average.



| | | | |
|-------------|-----------------|----------------|-----|
| Standard: | FCC Part 15.407 | Test Distance: | 3 m |
| Test item: | Band edge | | |
| Frequency: | 5560 MHz | | |
| Mode: | Mode 2 | | |
| Ant.Polar.: | Vertical | | |

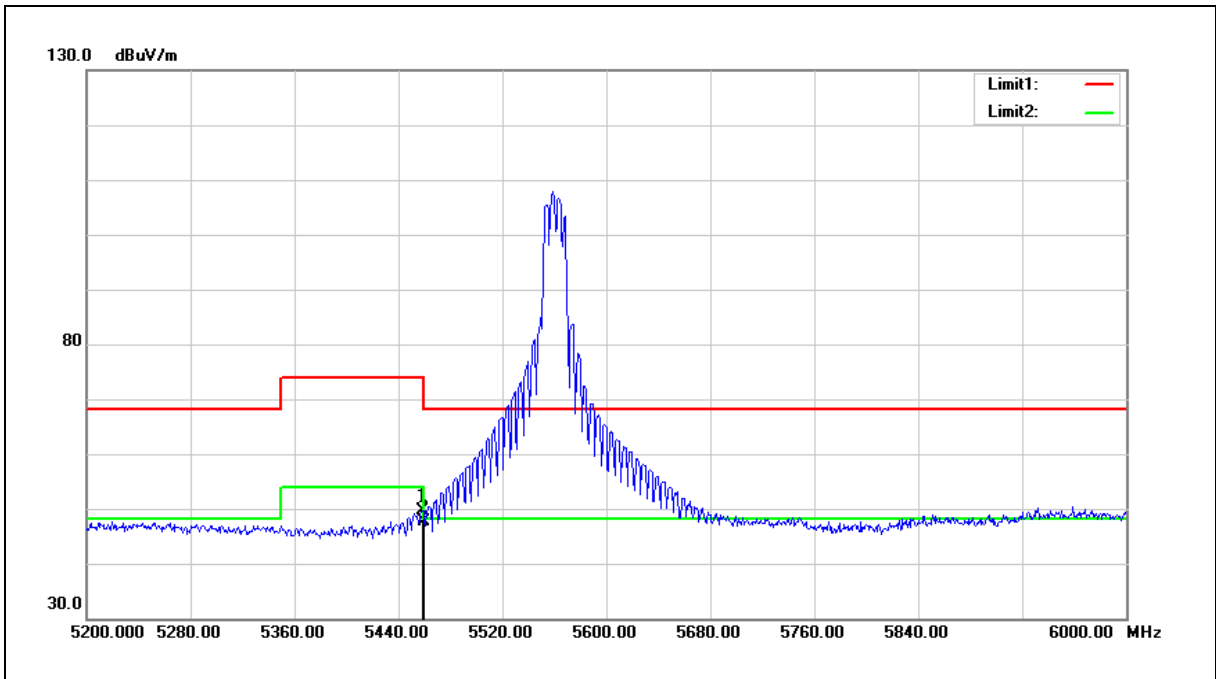

| No. | Frequency (MHz) | Reading (dBuV) | Correct Factor (dB/m) | Result (dBuV/m) | Limit (dBuV/m) | Margin (dB) | Remark |
|-----|-----------------|----------------|-----------------------|-----------------|----------------|-------------|--------|
| 1 | 5458.400 | 44.62 | 4.97 | 49.59 | 54.00 | -4.41 | AVG |
| 2 | 5460.000 | 42.72 | 4.97 | 47.69 | 54.00 | -6.31 | AVG |

Note:1.Result (dBuV/m) = Correct Factor (dB/m) + Reading(dBuV).

2.Correction factor (dB/m) = Antenna Factor (dB/m) + Cable loss (dB) – Pre-Amplifier gain (dB).

3.When the peak results are less than average limit, so not need to evaluate the average.



| | | | |
|-------------|-----------------|----------------|-----|
| Standard: | FCC Part 15.407 | Test Distance: | 3 m |
| Test item: | Band edge | | |
| Frequency: | 5700 MHz | | |
| Mode: | Mode 2 | | |
| Ant.Polar.: | Horizontal | | |

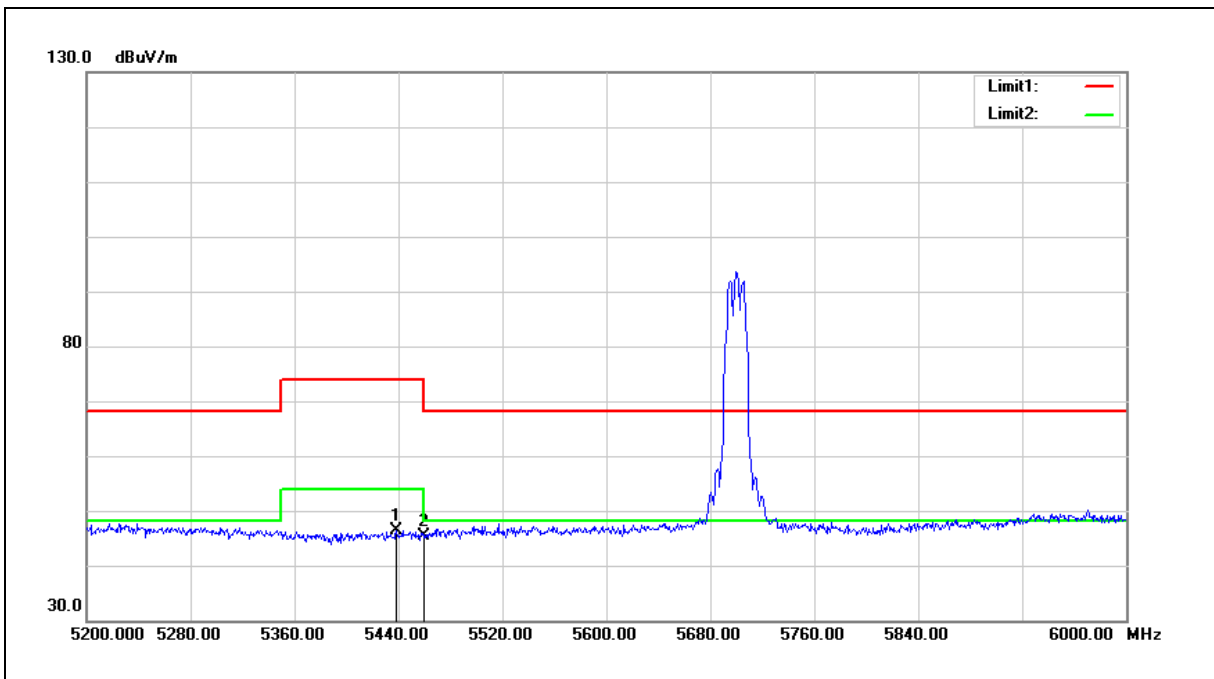

| No. | Frequency (MHz) | Reading (dBuV) | Correct Factor (dB/m) | Result (dBuV/m) | Limit (dBuV/m) | Margin (dB) | Remark |
|-----|-----------------|----------------|-----------------------|-----------------|----------------|-------------|--------|
| 1 | 5438.400 | 41.39 | 4.94 | 46.33 | 54.00 | -7.67 | AVG |
| 2 | 5460.000 | 40.53 | 4.97 | 45.50 | 54.00 | -8.50 | AVG |

Note:1.Result (dBuV/m) = Correct Factor (dB/m) + Reading(dBuV).

2.Correction factor (dB/m) = Antenna Factor (dB/m) + Cable loss (dB) – Pre-Amplifier gain (dB).

3.When the peak results are less than average limit, so not need to evaluate the average.



| | | | |
|-------------|-----------------|----------------|-----|
| Standard: | FCC Part 15.407 | Test Distance: | 3 m |
| Test item: | Band edge | | |
| Frequency: | 5700 MHz | | |
| Mode: | Mode 2 | | |
| Ant.Polar.: | Vertical | | |

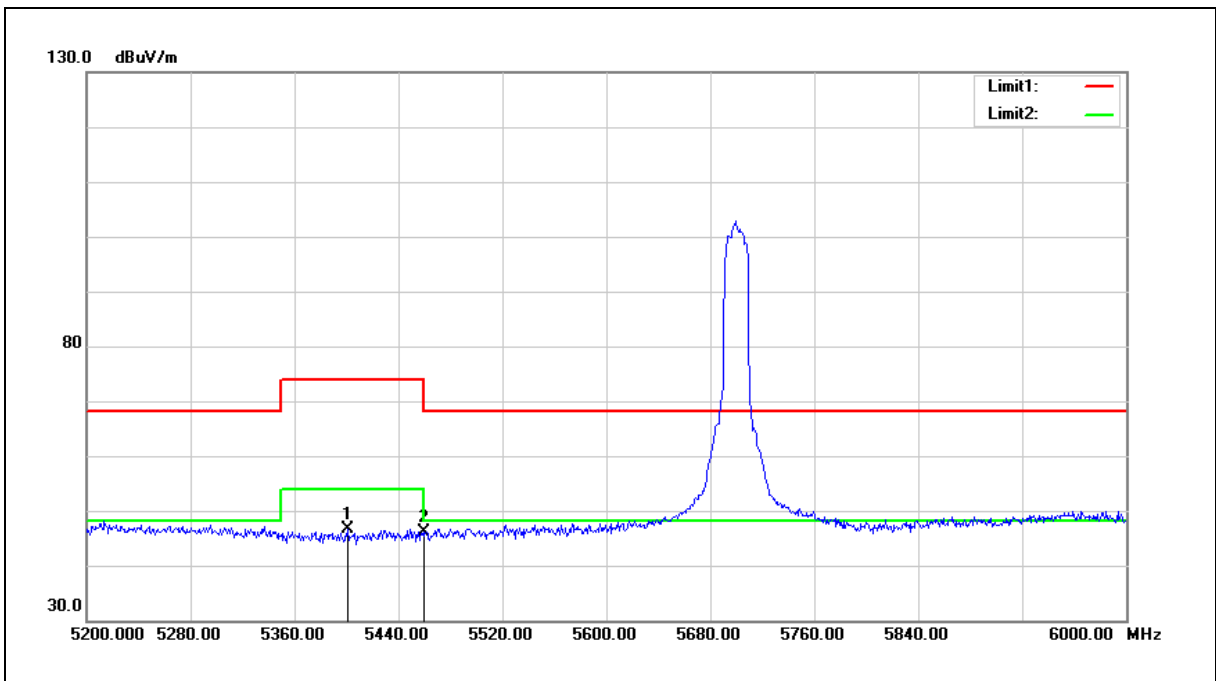

| No. | Frequency (MHz) | Reading (dBuV) | Correct Factor (dB/m) | Result (dBuV/m) | Limit (dBuV/m) | Margin (dB) | Remark |
|-----|-----------------|----------------|-----------------------|-----------------|----------------|-------------|--------|
| 1 | 5400.800 | 41.79 | 4.90 | 46.69 | 54.00 | -7.31 | AVG |
| 2 | 5460.000 | 41.15 | 4.97 | 46.12 | 54.00 | -7.88 | AVG |

Note:1.Result (dBuV/m) = Correct Factor (dB/m) + Reading(dBuV).

2.Correction factor (dB/m) = Antenna Factor (dB/m) + Cable loss (dB) – Pre-Amplifier gain (dB).

3.When the peak results are less than average limit, so not need to evaluate the average.



| | | | |
|-------------|-----------------|----------------|-----|
| Standard: | FCC Part 15.407 | Test Distance: | 3 m |
| Test item: | Band edge | | |
| Frequency: | 5720 MHz | | |
| Mode: | Mode 2 | | |
| Ant.Polar.: | Horizontal | | |

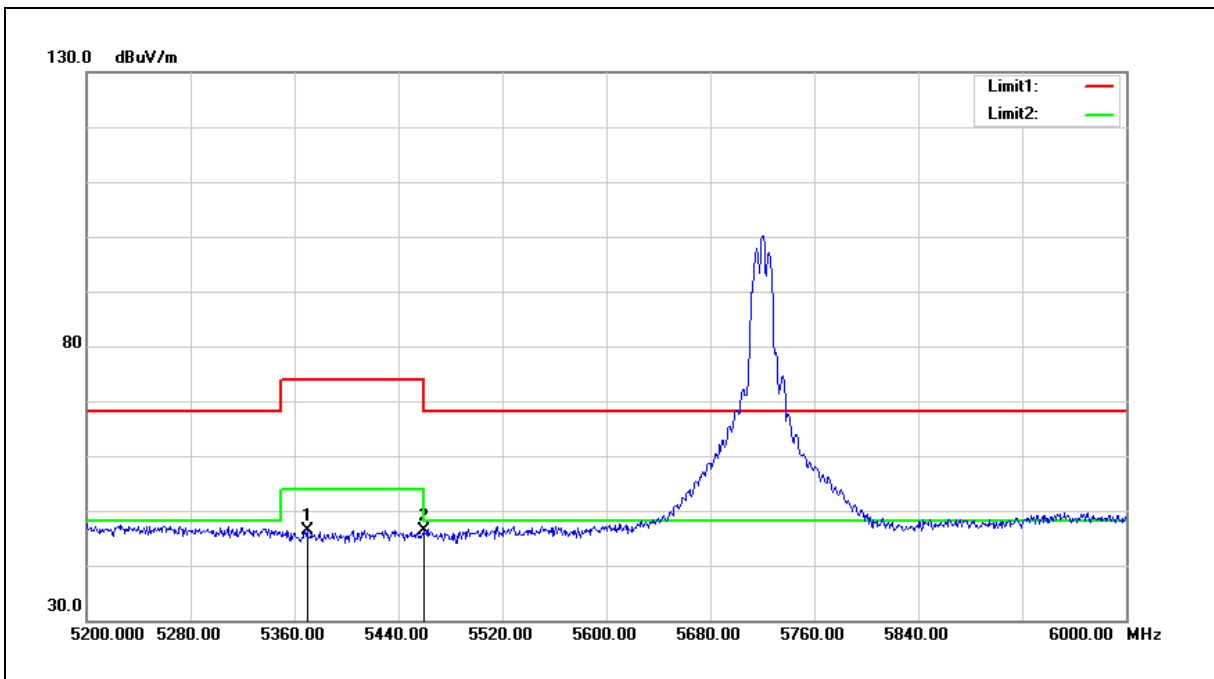

| No. | Frequency (MHz) | Reading (dBuV) | Correct Factor (dB/m) | Result (dBuV/m) | Limit (dBuV/m) | Margin (dB) | Remark |
|-----|-----------------|----------------|-----------------------|-----------------|----------------|-------------|--------|
| 1 | 5369.600 | 41.58 | 4.87 | 46.45 | 54.00 | -7.55 | AVG |
| 2 | 5460.000 | 41.43 | 4.97 | 46.40 | 54.00 | -7.60 | AVG |

Note:1.Result (dBuV/m) = Correct Factor (dB/m) + Reading(dBuV).

2.Correction factor (dB/m) = Antenna Factor (dB/m) + Cable loss (dB) – Pre-Amplifier gain (dB).

3.When the peak results are less than average limit, so not need to evaluate the average.



| | | | |
|-------------|-----------------|----------------|-----|
| Standard: | FCC Part 15.407 | Test Distance: | 3 m |
| Test item: | Band edge | | |
| Frequency: | 5720 MHz | | |
| Mode: | Mode 2 | | |
| Ant.Polar.: | Vertical | | |

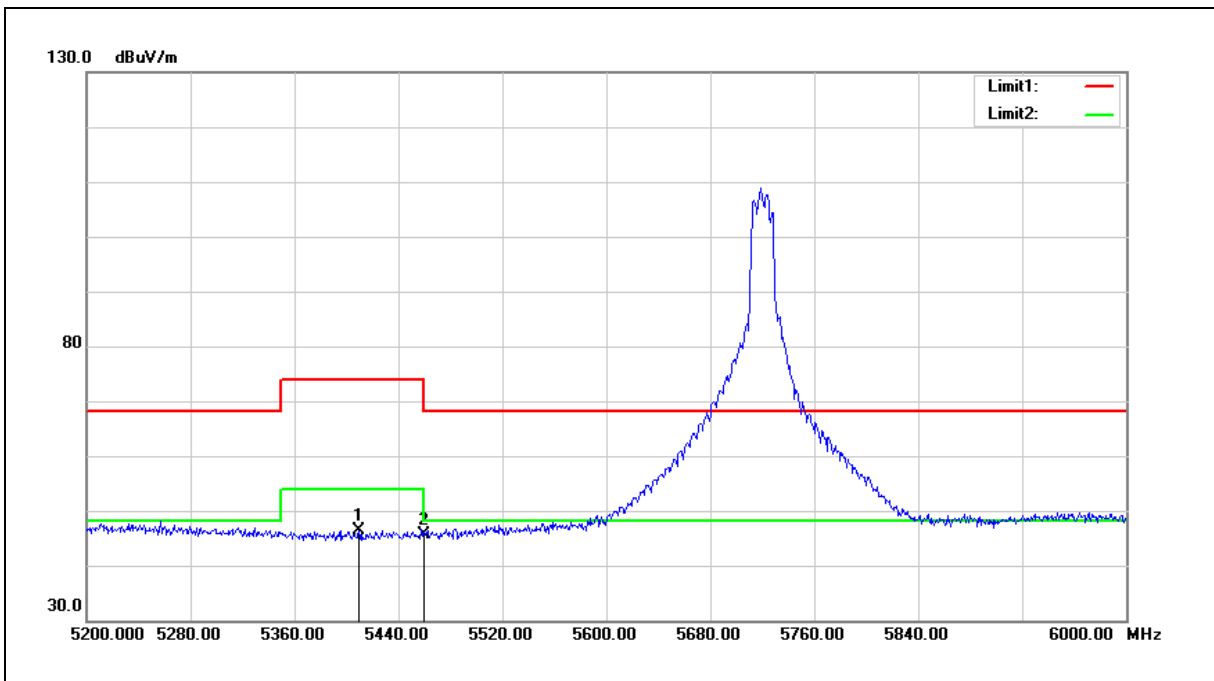

| No. | Frequency (MHz) | Reading (dBuV) | Correct Factor (dB/m) | Result (dBuV/m) | Limit (dBuV/m) | Margin (dB) | Remark |
|-----|-----------------|----------------|-----------------------|-----------------|----------------|-------------|--------|
| 1 | 5409.600 | 41.49 | 4.91 | 46.40 | 54.00 | -7.60 | AVG |
| 2 | 5460.000 | 40.77 | 4.97 | 45.74 | 54.00 | -8.26 | AVG |

Note:1.Result (dBuV/m) = Correct Factor (dB/m) + Reading(dBuV).

2.Correction factor (dB/m) = Antenna Factor (dB/m) + Cable loss (dB) – Pre-Amplifier gain (dB).

3.When the peak results are less than average limit, so not need to evaluate the average.



| | | | |
|-------------|-----------------|----------------|-----|
| Standard: | FCC Part 15.407 | Test Distance: | 3 m |
| Test item: | Band edge | | |
| Frequency: | 5180 MHz | | |
| Mode: | Mode 8 | | |
| Ant.Polar.: | Horizontal | | |

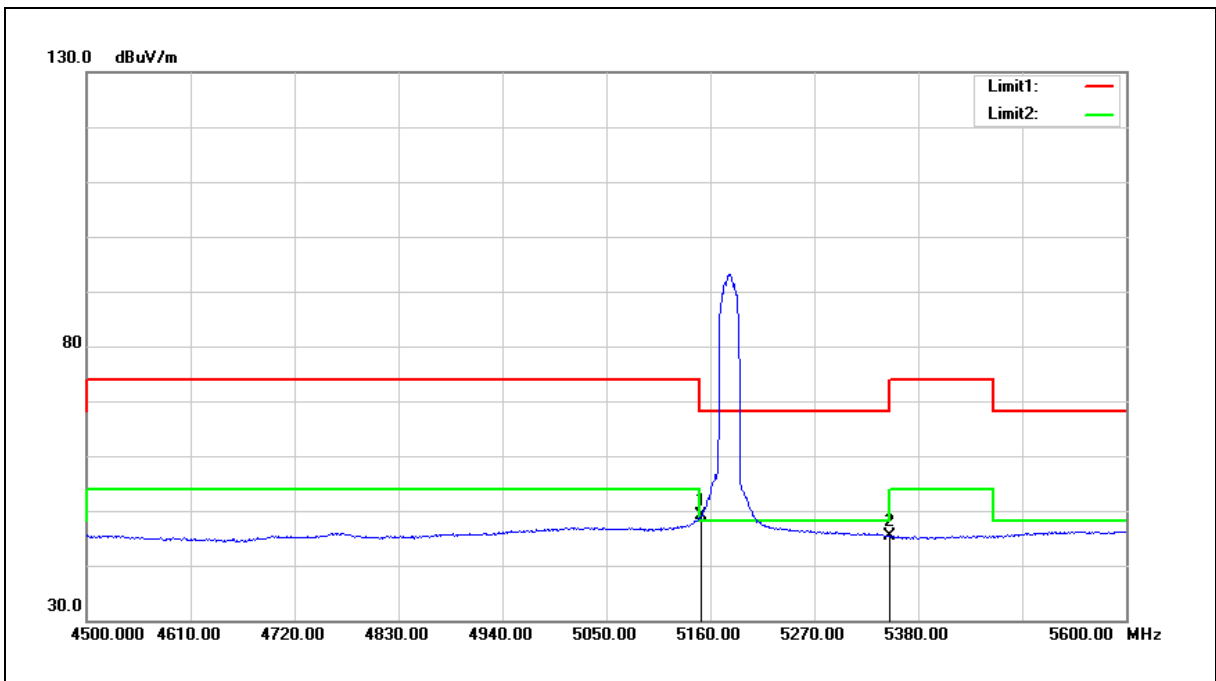

| No. | Frequency (MHz) | Reading (dBuV) | Correct Factor (dB/m) | Result (dBuV/m) | Limit (dBuV/m) | Margin (dB) | Remark |
|-----|-----------------|----------------|-----------------------|-----------------|----------------|-------------|--------|
| 1 | 5150.000 | 44.61 | 4.60 | 49.21 | 54.00 | -4.79 | AVG |
| 2 | 5350.000 | 40.49 | 4.84 | 45.33 | 54.00 | -8.67 | AVG |

Note:1.Result (dBuV/m) = Correct Factor (dB/m) + Reading(dBuV).

2.Correction factor (dB/m) = Antenna Factor (dB/m) + Cable loss (dB) – Pre-Amplifier gain (dB).

3.When the peak results are less than average limit, so not need to evaluate the average.



| | | | |
|-------------|-----------------|----------------|-----|
| Standard: | FCC Part 15.407 | Test Distance: | 3 m |
| Test item: | Band edge | | |
| Frequency: | 5180 MHz | | |
| Mode: | Mode 8 | | |
| Ant.Polar.: | Vertical | | |

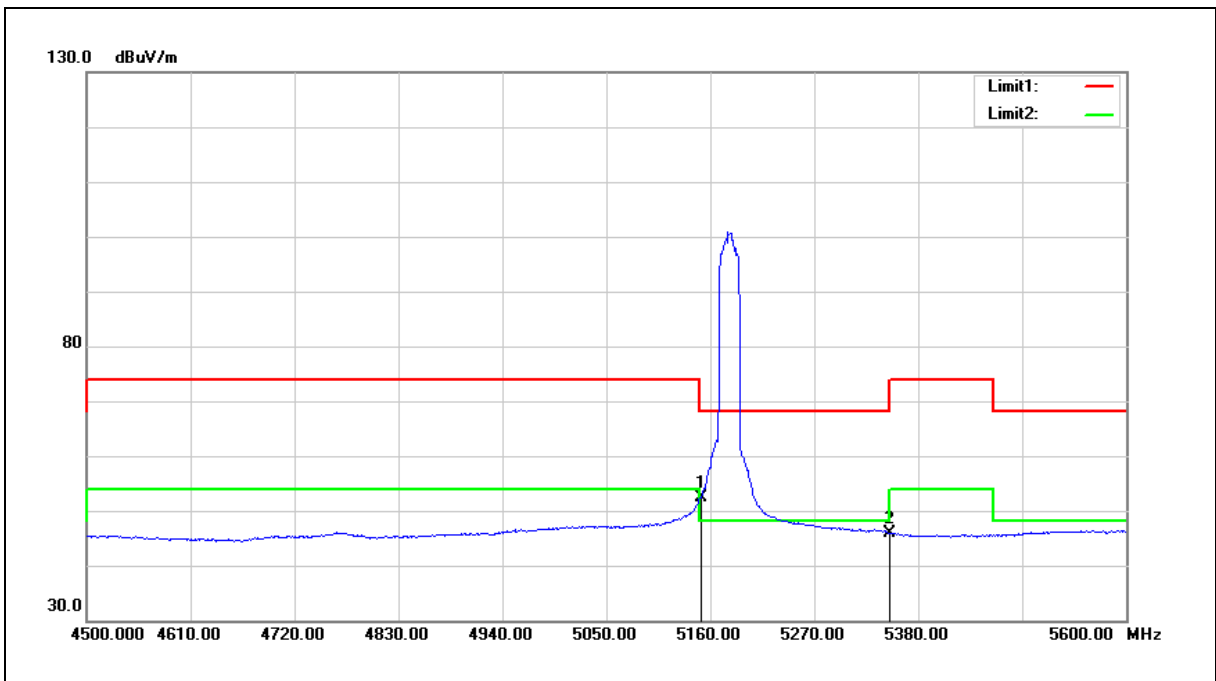

| No. | Frequency (MHz) | Reading (dBuV) | Correct Factor (dB/m) | Result (dBuV/m) | Limit (dBuV/m) | Margin (dB) | Remark |
|-----|-----------------|----------------|-----------------------|-----------------|----------------|-------------|--------|
| 1 | 5150.000 | 47.69 | 4.60 | 52.29 | 54.00 | -1.71 | AVG |
| 2 | 5350.000 | 41.04 | 4.84 | 45.88 | 54.00 | -8.12 | AVG |

Note:1.Result (dBuV/m) = Correct Factor (dB/m) + Reading(dBuV).

2.Correction factor (dB/m) = Antenna Factor (dB/m) + Cable loss (dB) – Pre-Amplifier gain (dB).

3.When the peak results are less than average limit, so not need to evaluate the average.



| | | | |
|-------------|-----------------|----------------|-----|
| Standard: | FCC Part 15.407 | Test Distance: | 3 m |
| Test item: | Band edge | | |
| Frequency: | 5200 MHz | | |
| Mode: | Mode 8 | | |
| Ant.Polar.: | Horizontal | | |

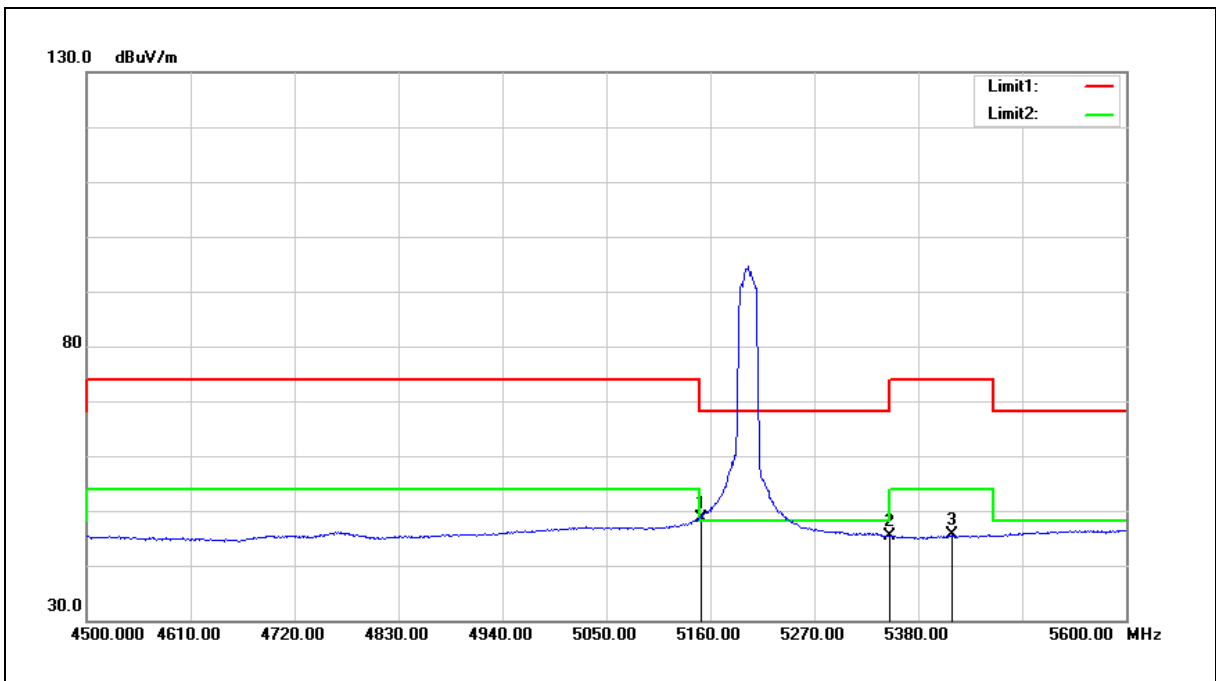

| No. | Frequency (MHz) | Reading (dBuV) | Correct Factor (dB/m) | Result (dBuV/m) | Limit (dBuV/m) | Margin (dB) | Remark |
|-----|-----------------|----------------|-----------------------|-----------------|----------------|-------------|--------|
| 1 | 5150.000 | 44.12 | 4.60 | 48.72 | 54.00 | -5.28 | AVG |
| 2 | 5350.000 | 40.46 | 4.84 | 45.30 | 54.00 | -8.70 | AVG |
| 3 | 5415.200 | 40.67 | 4.91 | 45.58 | 54.00 | -8.42 | AVG |

Note:1.Result (dBuV/m) = Correct Factor (dB/m) + Reading(dBuV).

2.Correction factor (dB/m) = Antenna Factor (dB/m) + Cable loss (dB) – Pre-Amplifier gain (dB).

3.When the peak results are less than average limit, so not need to evaluate the average.



| | | | |
|-------------|-----------------|----------------|-----|
| Standard: | FCC Part 15.407 | Test Distance: | 3 m |
| Test item: | Band edge | | |
| Frequency: | 5200 MHz | | |
| Mode: | Mode 8 | | |
| Ant.Polar.: | Vertical | | |

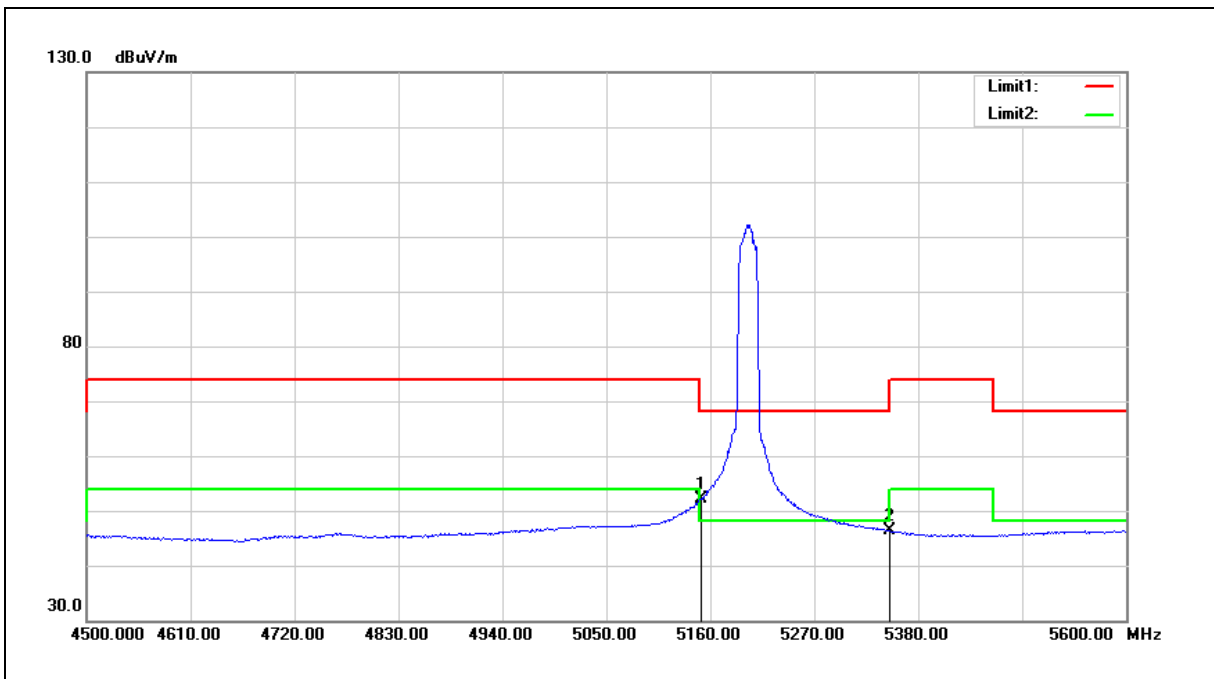

| No. | Frequency (MHz) | Reading (dBuV) | Correct Factor (dB/m) | Result (dBuV/m) | Limit (dBuV/m) | Margin (dB) | Remark |
|-----|-----------------|----------------|-----------------------|-----------------|----------------|-------------|--------|
| 1 | 5150.000 | 47.62 | 4.60 | 52.22 | 54.00 | -1.78 | AVG |
| 2 | 5350.000 | 41.50 | 4.84 | 46.34 | 54.00 | -7.66 | AVG |

Note:1.Result (dBuV/m) = Correct Factor (dB/m) + Reading(dBuV).

2.Correction factor (dB/m) = Antenna Factor (dB/m) + Cable loss (dB) – Pre-Amplifier gain (dB).

3.When the peak results are less than average limit, so not need to evaluate the average.



| | | | |
|-------------|-----------------|----------------|-----|
| Standard: | FCC Part 15.407 | Test Distance: | 3 m |
| Test item: | Band edge | | |
| Frequency: | 5240 MHz | | |
| Mode: | Mode 8 | | |
| Ant.Polar.: | Horizontal | | |

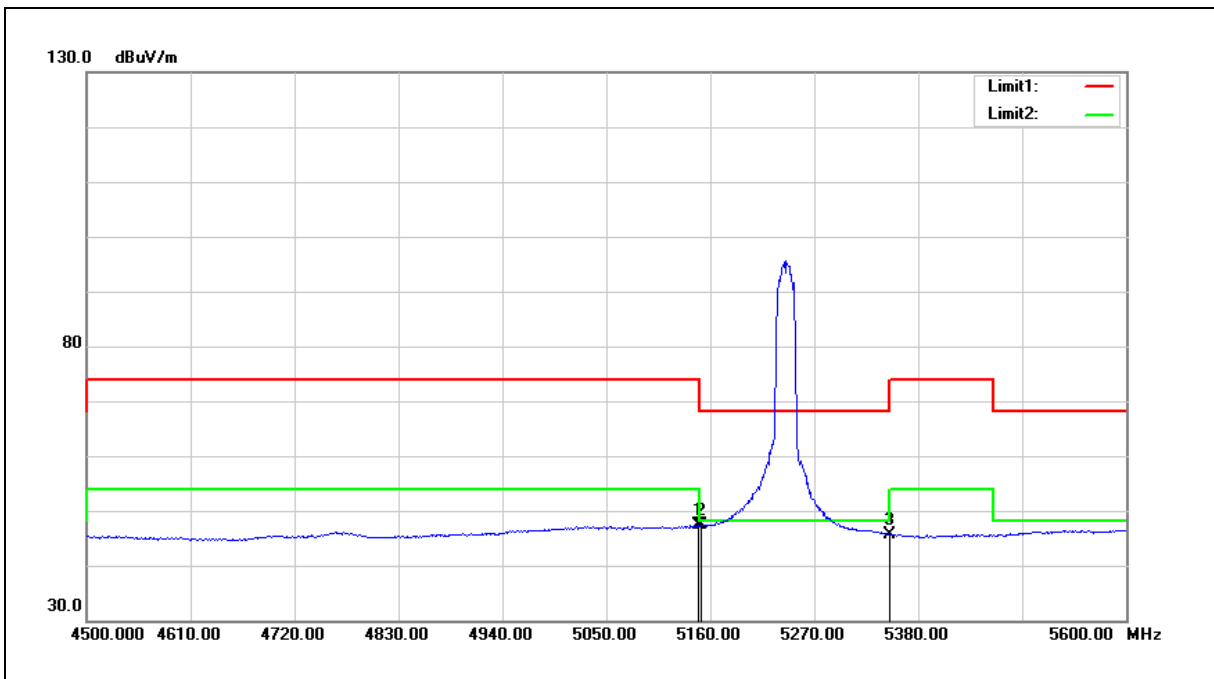

| No. | Frequency (MHz) | Reading (dBuV) | Correct Factor (dB/m) | Result (dBuV/m) | Limit (dBuV/m) | Margin (dB) | Remark |
|-----|-----------------|----------------|-----------------------|-----------------|----------------|-------------|--------|
| 1 | 5147.900 | 42.69 | 4.60 | 47.29 | 54.00 | -6.71 | AVG |
| 2 | 5150.000 | 42.67 | 4.60 | 47.27 | 54.00 | -6.73 | AVG |
| 3 | 5350.000 | 40.87 | 4.84 | 45.71 | 54.00 | -8.29 | AVG |

Note:1.Result (dBuV/m) = Correct Factor (dB/m) + Reading(dBuV).

2.Correction factor (dB/m) = Antenna Factor (dB/m) + Cable loss (dB) – Pre-Amplifier gain (dB).

3.When the peak results are less than average limit, so not need to evaluate the average.



| | | | |
|-------------|-----------------|----------------|-----|
| Standard: | FCC Part 15.407 | Test Distance: | 3 m |
| Test item: | Band edge | | |
| Frequency: | 5240 MHz | | |
| Mode: | Mode 8 | | |
| Ant.Polar.: | Vertical | | |

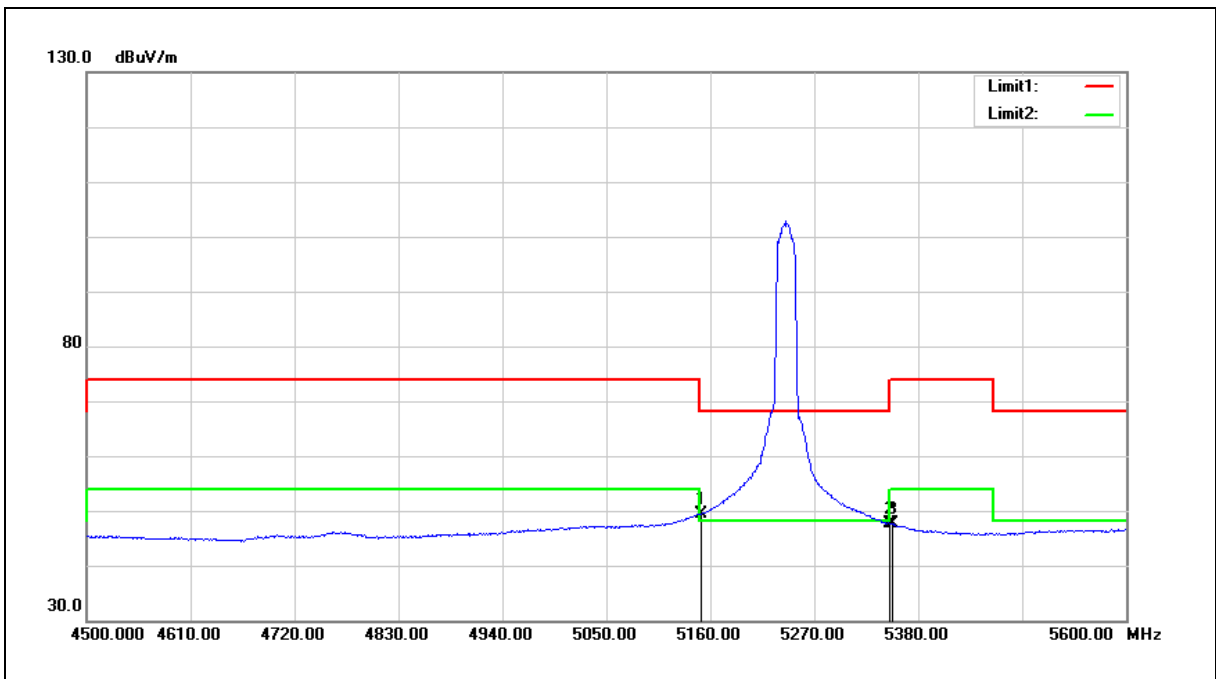

| No. | Frequency (MHz) | Reading (dBuV) | Correct Factor (dB/m) | Result (dBuV/m) | Limit (dBuV/m) | Margin (dB) | Remark |
|-----|-----------------|----------------|-----------------------|-----------------|----------------|-------------|--------|
| 1 | 5150.000 | 44.85 | 4.60 | 49.45 | 54.00 | -4.55 | AVG |
| 2 | 5350.000 | 42.76 | 4.84 | 47.60 | 54.00 | -6.40 | AVG |
| 3 | 5352.500 | 42.80 | 4.84 | 47.64 | 54.00 | -6.36 | AVG |

Note:1.Result (dBuV/m) = Correct Factor (dB/m) + Reading(dBuV).

2.Correction factor (dB/m) = Antenna Factor (dB/m) + Cable loss (dB) – Pre-Amplifier gain (dB).

3.When the peak results are less than average limit, so not need to evaluate the average.



| | | | |
|-------------|-----------------|----------------|-----|
| Standard: | FCC Part 15.407 | Test Distance: | 3 m |
| Test item: | Band edge | | |
| Frequency: | 5260 MHz | | |
| Mode: | Mode 8 | | |
| Ant.Polar.: | Horizontal | | |

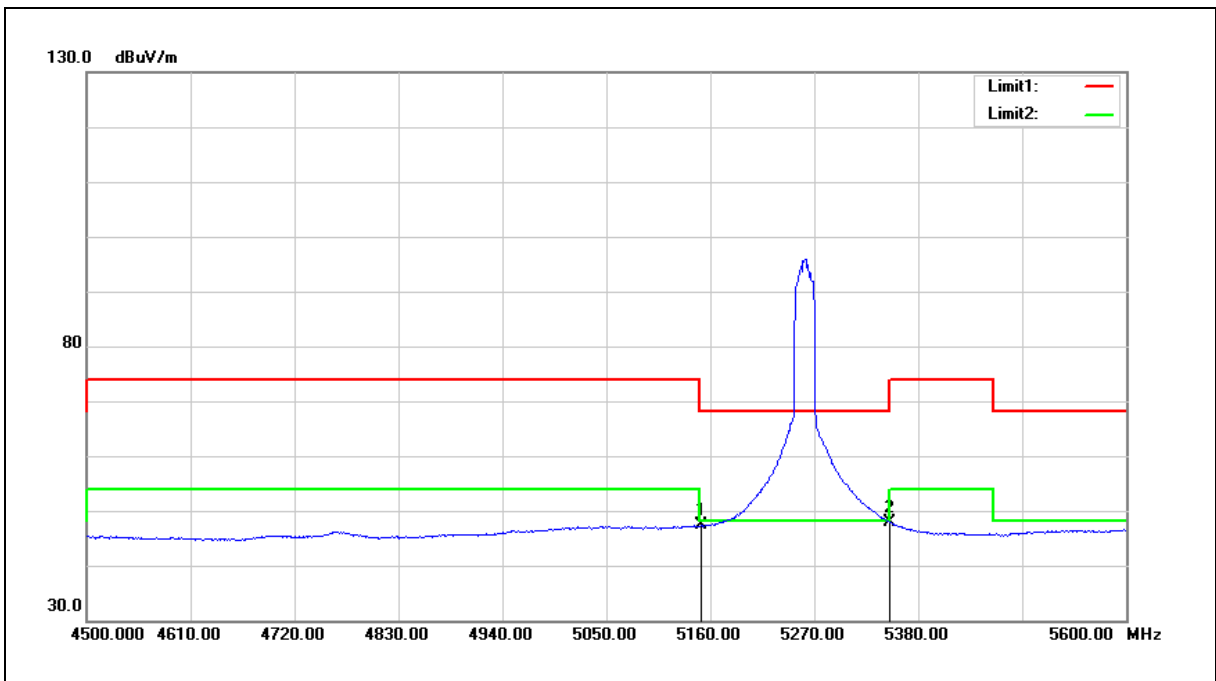

| No. | Frequency (MHz) | Reading (dBuV) | Correct Factor (dB/m) | Result (dBuV/m) | Limit (dBuV/m) | Margin (dB) | Remark |
|-----|-----------------|----------------|-----------------------|-----------------|----------------|-------------|--------|
| 1 | 5150.000 | 42.68 | 4.60 | 47.28 | 54.00 | -6.72 | AVG |
| 2 | 5350.000 | 42.94 | 4.84 | 47.78 | 54.00 | -6.22 | AVG |

Note:1.Result (dBuV/m) = Correct Factor (dB/m) + Reading(dBuV).

2.Correction factor (dB/m) = Antenna Factor (dB/m) + Cable loss (dB) – Pre-Amplifier gain (dB).

3.When the peak results are less than average limit, so not need to evaluate the average.



| | | | |
|-------------|-----------------|----------------|-----|
| Standard: | FCC Part 15.407 | Test Distance: | 3 m |
| Test item: | Band edge | | |
| Frequency: | 5260 MHz | | |
| Mode: | Mode 8 | | |
| Ant.Polar.: | Vertical | | |

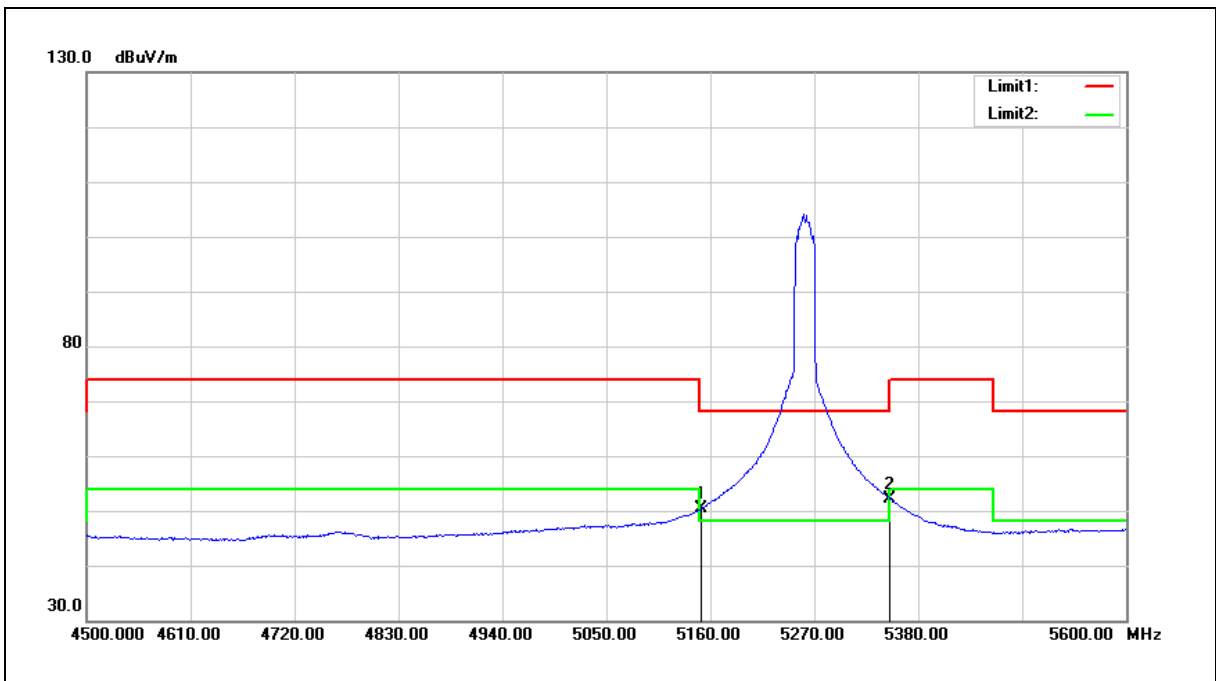

| No. | Frequency (MHz) | Reading (dBuV) | Correct Factor (dB/m) | Result (dBuV/m) | Limit (dBuV/m) | Margin (dB) | Remark |
|-----|-----------------|----------------|-----------------------|-----------------|----------------|-------------|--------|
| 1 | 5150.000 | 45.71 | 4.60 | 50.31 | 54.00 | -3.69 | AVG |
| 2 | 5350.000 | 47.34 | 4.84 | 52.18 | 54.00 | -1.82 | AVG |

Note:1.Result (dBuV/m) = Correct Factor (dB/m) + Reading(dBuV).

2.Correction factor (dB/m) = Antenna Factor (dB/m) + Cable loss (dB) – Pre-Amplifier gain (dB).

3.When the peak results are less than average limit, so not need to evaluate the average.



| | | | |
|-------------|-----------------|----------------|-----|
| Standard: | FCC Part 15.407 | Test Distance: | 3 m |
| Test item: | Band edge | | |
| Frequency: | 5280 MHz | | |
| Mode: | Mode 8 | | |
| Ant.Polar.: | Horizontal | | |

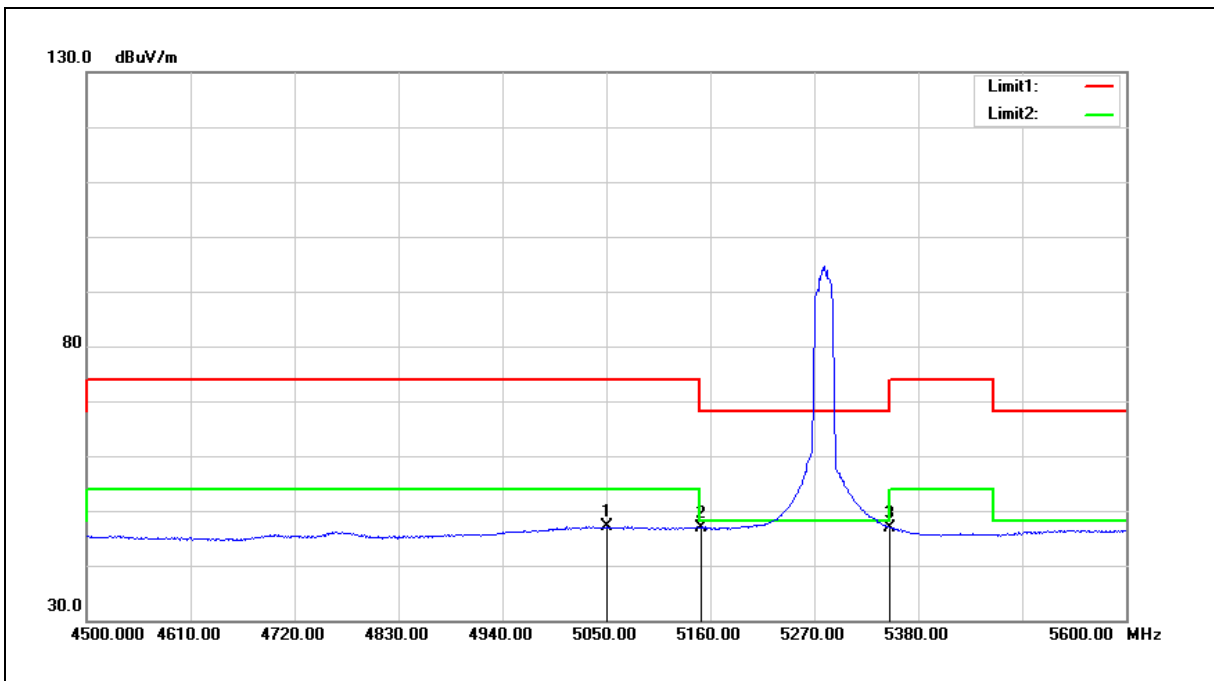

| No. | Frequency (MHz) | Reading (dBuV) | Correct Factor (dB/m) | Result (dBuV/m) | Limit (dBuV/m) | Margin (dB) | Remark |
|-----|-----------------|----------------|-----------------------|-----------------|----------------|-------------|--------|
| 1 | 5051.100 | 42.68 | 4.48 | 47.16 | 54.00 | -6.84 | AVG |
| 2 | 5150.000 | 42.19 | 4.60 | 46.79 | 54.00 | -7.21 | AVG |
| 3 | 5350.000 | 42.09 | 4.84 | 46.93 | 54.00 | -7.07 | AVG |

Note:1.Result (dBuV/m) = Correct Factor (dB/m) + Reading(dBuV).

2.Correction factor (dB/m) = Antenna Factor (dB/m) + Cable loss (dB) – Pre-Amplifier gain (dB).

3.When the peak results are less than average limit, so not need to evaluate the average.



| | | | |
|-------------|-----------------|----------------|-----|
| Standard: | FCC Part 15.407 | Test Distance: | 3 m |
| Test item: | Band edge | | |
| Frequency: | 5280 MHz | | |
| Mode: | Mode 8 | | |
| Ant.Polar.: | Vertical | | |

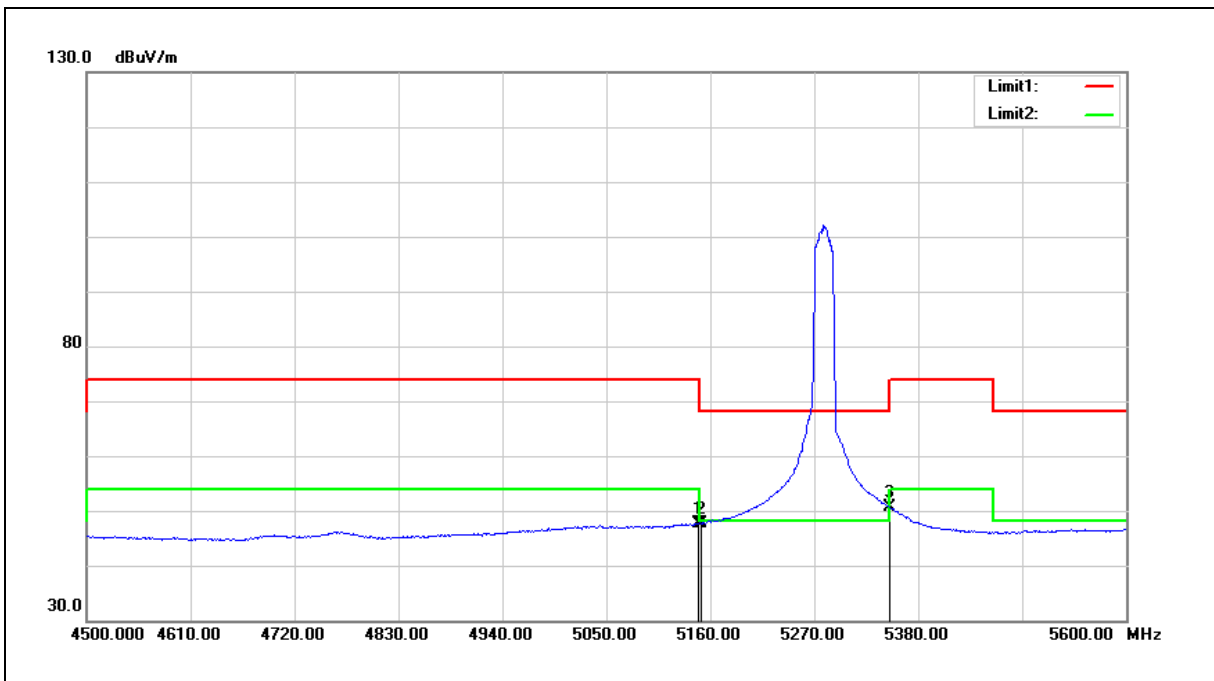

| No. | Frequency (MHz) | Reading (dBuV) | Correct Factor (dB/m) | Result (dBuV/m) | Limit (dBuV/m) | Margin (dB) | Remark |
|-----|-----------------|----------------|-----------------------|-----------------|----------------|-------------|--------|
| 1 | 5147.900 | 43.14 | 4.60 | 47.74 | 54.00 | -6.26 | AVG |
| 2 | 5150.000 | 43.11 | 4.60 | 47.71 | 54.00 | -6.29 | AVG |
| 3 | 5350.000 | 45.73 | 4.84 | 50.57 | 54.00 | -3.43 | AVG |

Note:1.Result (dBuV/m) = Correct Factor (dB/m) + Reading(dBuV).

2.Correction factor (dB/m) = Antenna Factor (dB/m) + Cable loss (dB) – Pre-Amplifier gain (dB).

3.When the peak results are less than average limit, so not need to evaluate the average.



| | | | |
|-------------|-----------------|----------------|-----|
| Standard: | FCC Part 15.407 | Test Distance: | 3 m |
| Test item: | Band edge | | |
| Frequency: | 5320 MHz | | |
| Mode: | Mode 8 | | |
| Ant.Polar.: | Horizontal | | |

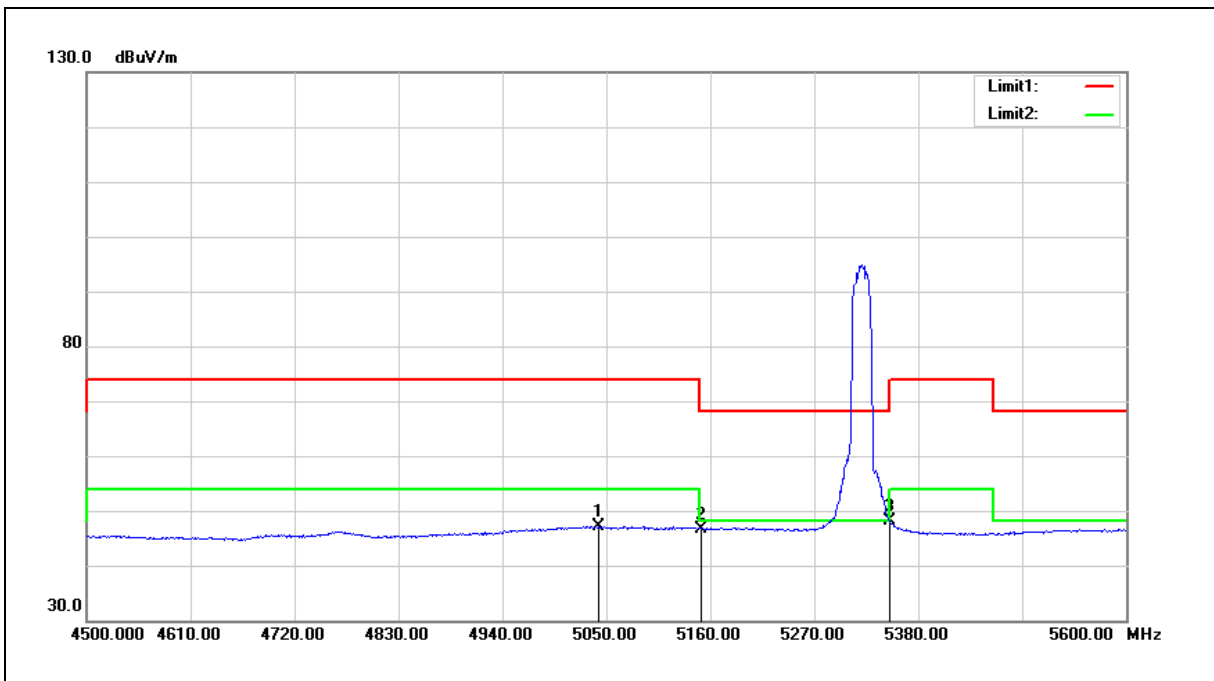

| No. | Frequency (MHz) | Reading (dBuV) | Correct Factor (dB/m) | Result (dBuV/m) | Limit (dBuV/m) | Margin (dB) | Remark |
|-----|-----------------|----------------|-----------------------|-----------------|----------------|-------------|--------|
| 1 | 5041.200 | 42.64 | 4.46 | 47.10 | 54.00 | -6.90 | AVG |
| 2 | 5150.000 | 42.08 | 4.60 | 46.68 | 54.00 | -7.32 | AVG |
| 3 | 5350.000 | 43.32 | 4.84 | 48.16 | 54.00 | -5.84 | AVG |

Note:1.Result (dBuV/m) = Correct Factor (dB/m) + Reading(dBuV).

2.Correction factor (dB/m) = Antenna Factor (dB/m) + Cable loss (dB) – Pre-Amplifier gain (dB).

3.When the peak results are less than average limit, so not need to evaluate the average.



| | | | |
|-------------|-----------------|----------------|-----|
| Standard: | FCC Part 15.407 | Test Distance: | 3 m |
| Test item: | Band edge | | |
| Frequency: | 5320 MHz | | |
| Mode: | Mode 8 | | |
| Ant.Polar.: | Vertical | | |

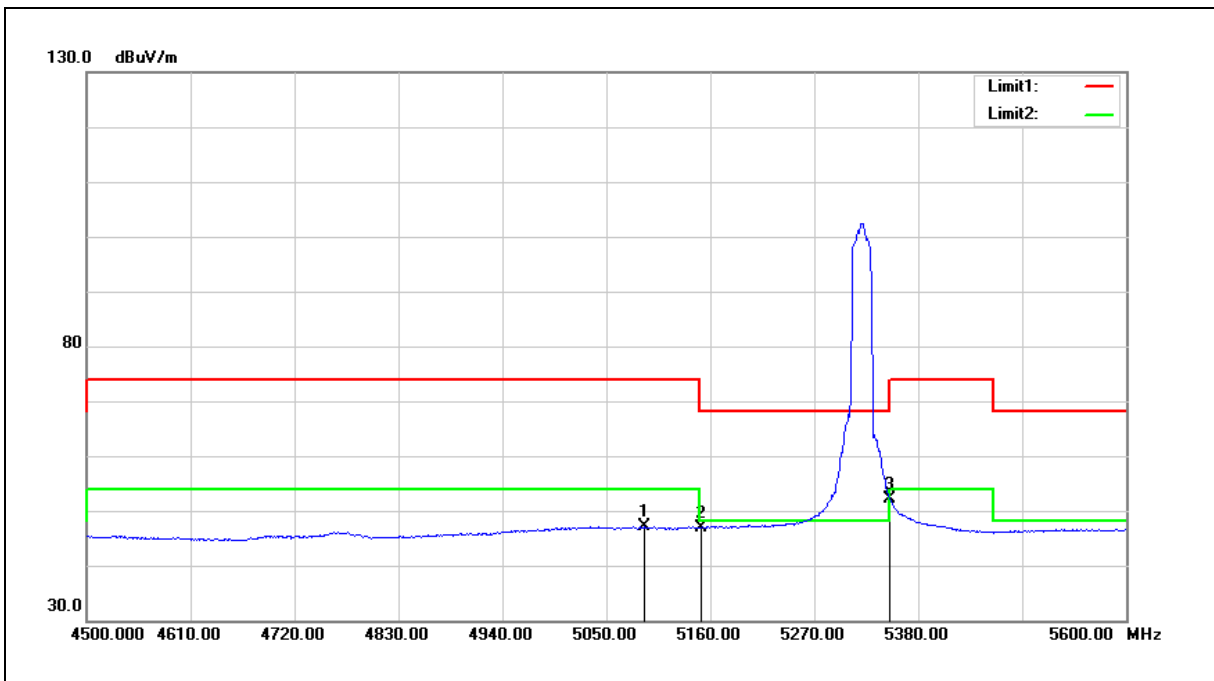

| No. | Frequency (MHz) | Reading (dBuV) | Correct Factor (dB/m) | Result (dBuV/m) | Limit (dBuV/m) | Margin (dB) | Remark |
|-----|-----------------|----------------|-----------------------|-----------------|----------------|-------------|--------|
| 1 | 5090.700 | 42.60 | 4.52 | 47.12 | 54.00 | -6.88 | AVG |
| 2 | 5150.000 | 42.34 | 4.60 | 46.94 | 54.00 | -7.06 | AVG |
| 3 | 5350.000 | 47.23 | 4.84 | 52.07 | 54.00 | -1.93 | AVG |

Note:1.Result (dBuV/m) = Correct Factor (dB/m) + Reading(dBuV).

2.Correction factor (dB/m) = Antenna Factor (dB/m) + Cable loss (dB) – Pre-Amplifier gain (dB).

3.When the peak results are less than average limit, so not need to evaluate the average.



| | | | |
|-------------|-----------------|----------------|-----|
| Standard: | FCC Part 15.407 | Test Distance: | 3 m |
| Test item: | Band edge | | |
| Frequency: | 5500 MHz | | |
| Mode: | Mode 8 | | |
| Ant.Polar.: | Horizontal | | |

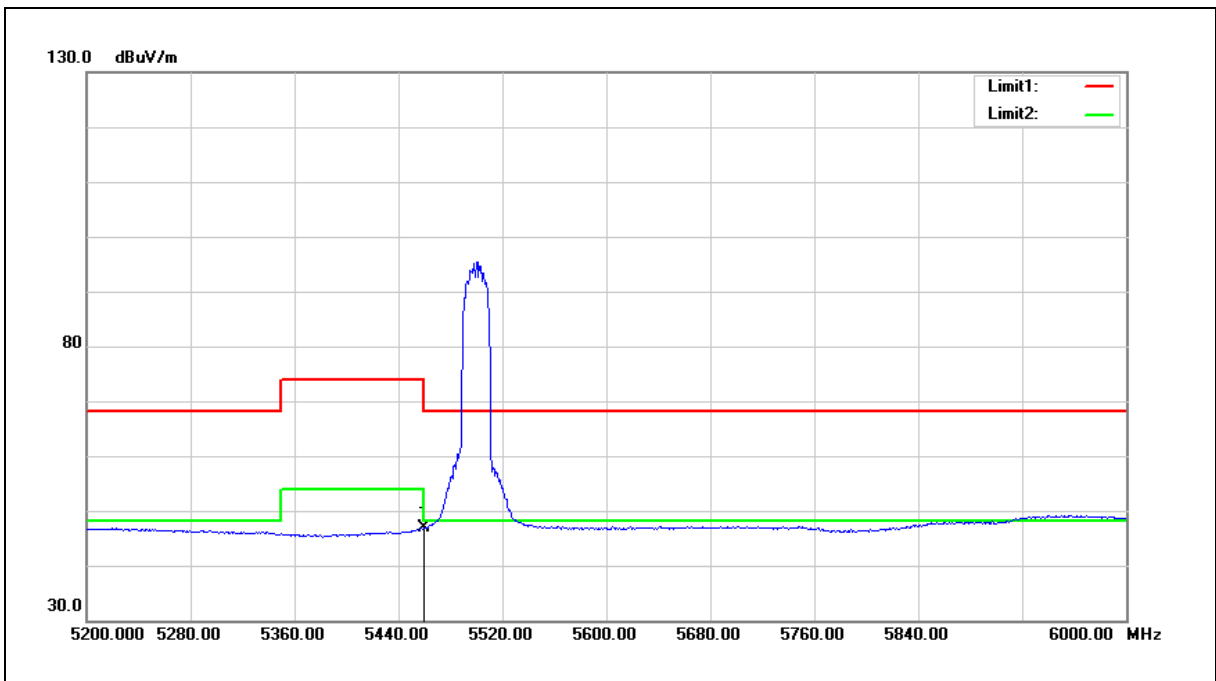

| No. | Frequency (MHz) | Reading (dBuV) | Correct Factor (dB/m) | Result (dBuV/m) | Limit (dBuV/m) | Margin (dB) | Remark |
|-----|-----------------|----------------|-----------------------|-----------------|----------------|-------------|--------|
| 1 | 5460.000 | 41.91 | 4.97 | 46.88 | 54.00 | -7.12 | AVG |

- Note:1.Result (dBuV/m) = Correct Factor (dB/m) + Reading(dBuV).
- 2.Correction factor (dB/m) = Antenna Factor (dB/m) + Cable loss (dB) – Pre-Amplifier gain (dB).
- 3.When the peak results are less than average limit, so not need to evaluate the average.



| | | | |
|-------------|-----------------|----------------|-----|
| Standard: | FCC Part 15.407 | Test Distance: | 3 m |
| Test item: | Band edge | | |
| Frequency: | 5500 MHz | | |
| Mode: | Mode 8 | | |
| Ant.Polar.: | Vertical | | |

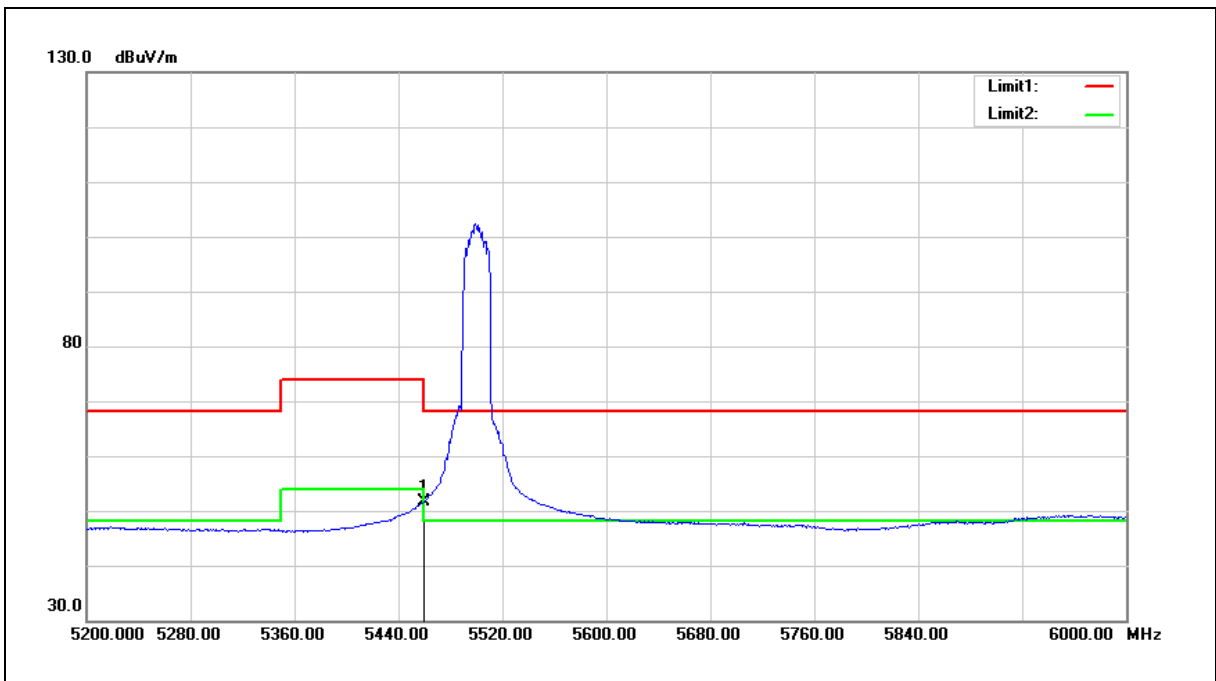

| No. | Frequency (MHz) | Reading (dBuV) | Correct Factor (dB/m) | Result (dBuV/m) | Limit (dBuV/m) | Margin (dB) | Remark |
|-----|-----------------|----------------|-----------------------|-----------------|----------------|-------------|--------|
| 1 | 5460.000 | 46.72 | 4.97 | 51.69 | 54.00 | -2.31 | AVG |

Note:1.Result (dBuV/m) = Correct Factor (dB/m) + Reading(dBuV).

2.Correction factor (dB/m) = Antenna Factor (dB/m) + Cable loss (dB) – Pre-Amplifier gain (dB).

3.When the peak results are less than average limit, so not need to evaluate the average.



| | | | |
|-------------|-----------------|----------------|-----|
| Standard: | FCC Part 15.407 | Test Distance: | 3 m |
| Test item: | Band edge | | |
| Frequency: | 5560 MHz | | |
| Mode: | Mode 8 | | |
| Ant.Polar.: | Horizontal | | |

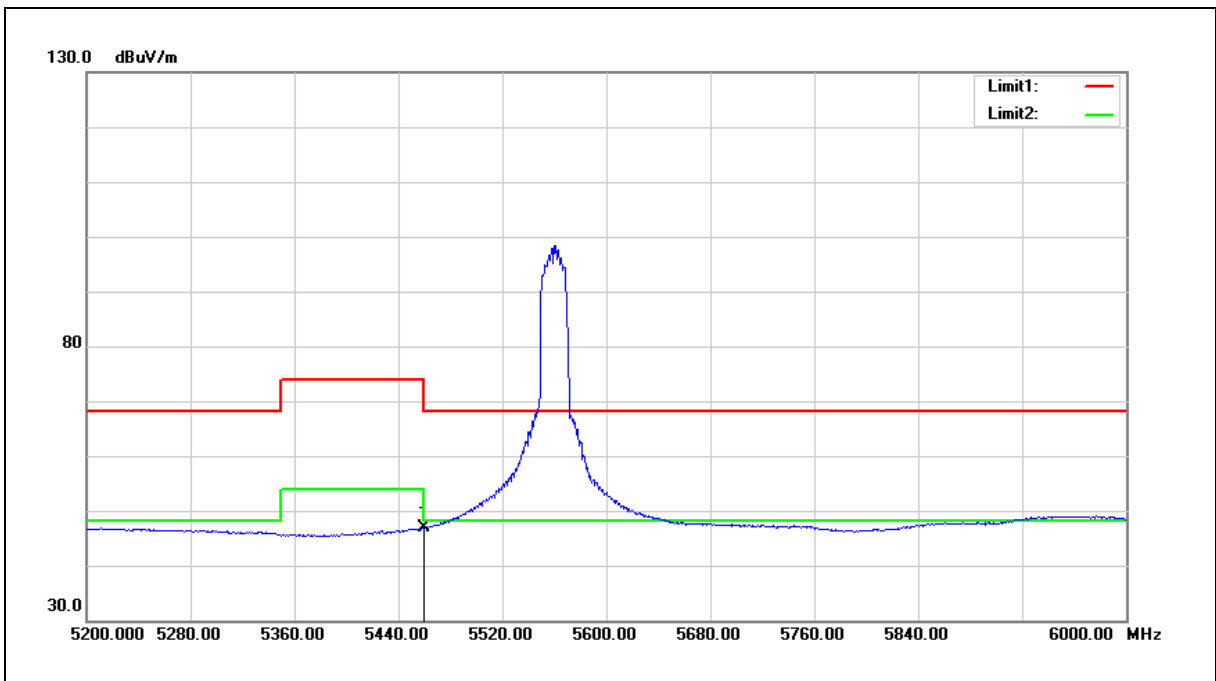

| No. | Frequency (MHz) | Reading (dBuV) | Correct Factor (dB/m) | Result (dBuV/m) | Limit (dBuV/m) | Margin (dB) | Remark |
|-----|-----------------|----------------|-----------------------|-----------------|----------------|-------------|--------|
| 1 | 5460.000 | 41.96 | 4.97 | 46.93 | 54.00 | -7.07 | AVG |

Note:1.Result (dBuV/m) = Correct Factor (dB/m) + Reading(dBuV).

2.Correction factor (dB/m) = Antenna Factor (dB/m) + Cable loss (dB) – Pre-Amplifier gain (dB).

3.When the peak results are less than average limit, so not need to evaluate the average.



| | | | |
|-------------|-----------------|----------------|-----|
| Standard: | FCC Part 15.407 | Test Distance: | 3 m |
| Test item: | Band edge | | |
| Frequency: | 5560 MHz | | |
| Mode: | Mode 8 | | |
| Ant.Polar.: | Vertical | | |

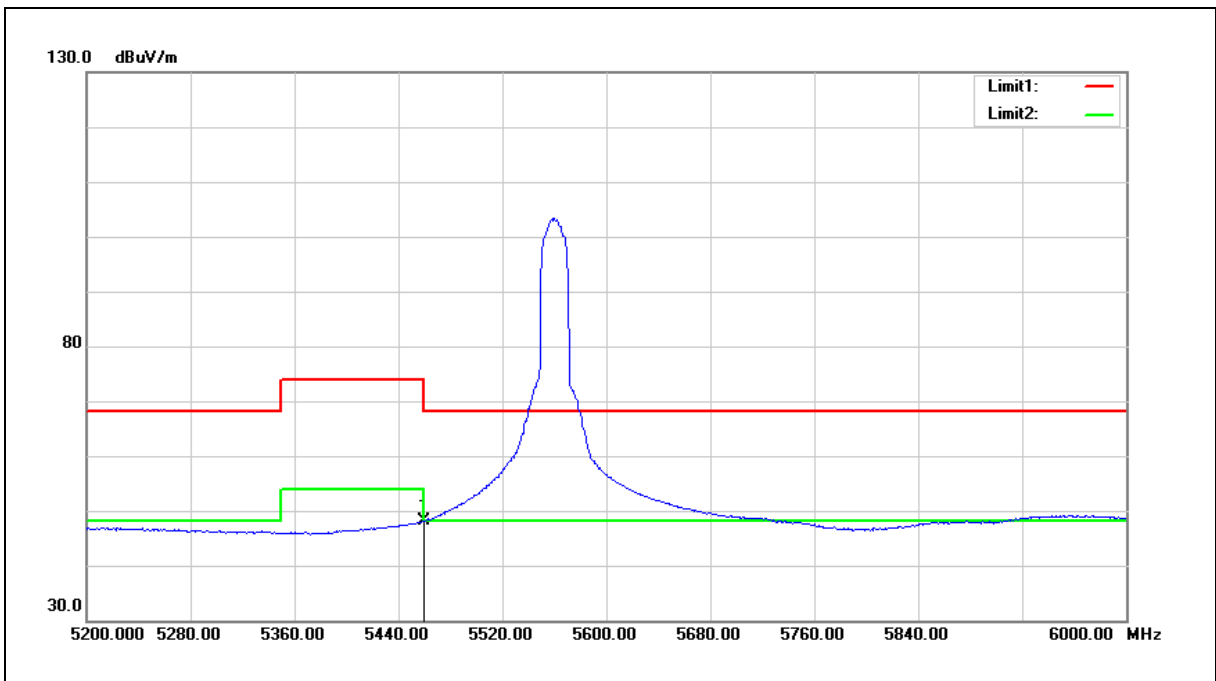

| No. | Frequency (MHz) | Reading (dBuV) | Correct Factor (dB/m) | Result (dBuV/m) | Limit (dBuV/m) | Margin (dB) | Remark |
|-----|-----------------|----------------|-----------------------|-----------------|----------------|-------------|--------|
| 1 | 5460.000 | 43.14 | 4.97 | 48.11 | 54.00 | -5.89 | AVG |

Note:1.Result (dBuV/m) = Correct Factor (dB/m) + Reading(dBuV).

2.Correction factor (dB/m) = Antenna Factor (dB/m) + Cable loss (dB) – Pre-Amplifier gain (dB).

3.When the peak results are less than average limit, so not need to evaluate the average.



| | | | |
|-------------|-----------------|----------------|-----|
| Standard: | FCC Part 15.407 | Test Distance: | 3 m |
| Test item: | Band edge | | |
| Frequency: | 5700 MHz | | |
| Mode: | Mode 8 | | |
| Ant.Polar.: | Horizontal | | |

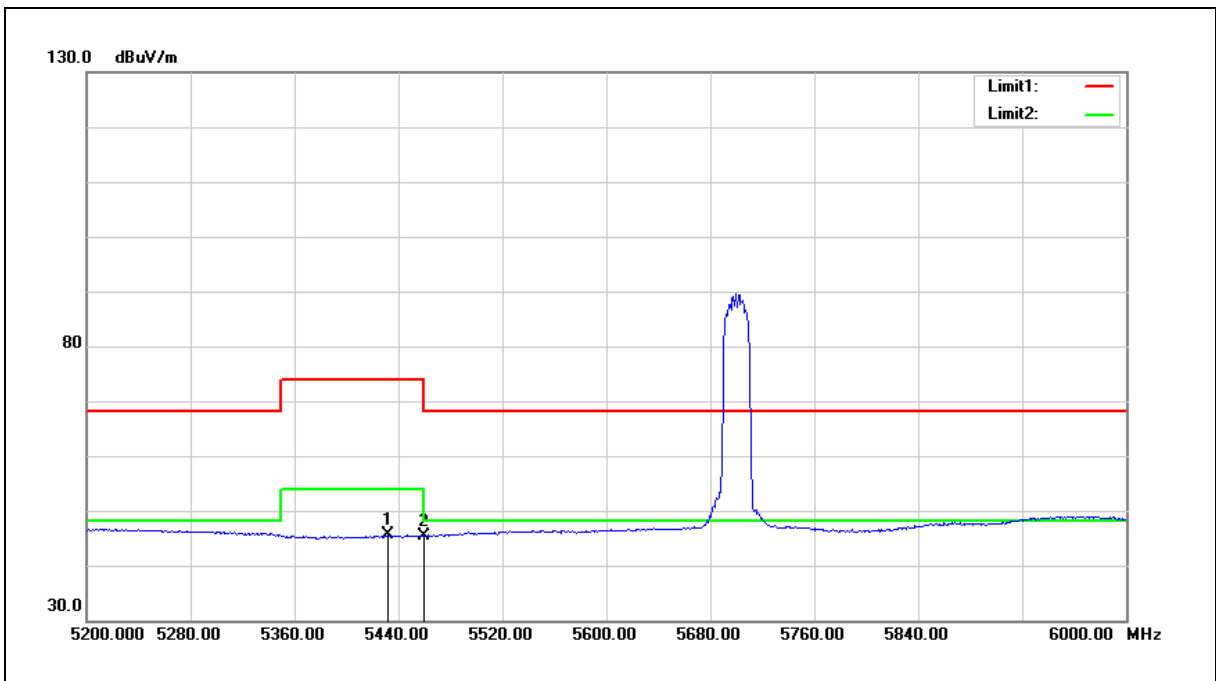

| No. | Frequency (MHz) | Reading (dBuV) | Correct Factor (dB/m) | Result (dBuV/m) | Limit (dBuV/m) | Margin (dB) | Remark |
|-----|-----------------|----------------|-----------------------|-----------------|----------------|-------------|--------|
| 1 | 5432.000 | 40.60 | 4.94 | 45.54 | 54.00 | -8.46 | AVG |
| 2 | 5460.000 | 40.50 | 4.97 | 45.47 | 54.00 | -8.53 | AVG |

Note:1.Result (dBuV/m) = Correct Factor (dB/m) + Reading(dBuV).

2.Correction factor (dB/m) = Antenna Factor (dB/m) + Cable loss (dB) – Pre-Amplifier gain (dB).

3.When the peak results are less than average limit, so not need to evaluate the average.



| | | | |
|-------------|-----------------|----------------|-----|
| Standard: | FCC Part 15.407 | Test Distance: | 3 m |
| Test item: | Band edge | | |
| Frequency: | 5700 MHz | | |
| Mode: | Mode 8 | | |
| Ant.Polar.: | Vertical | | |

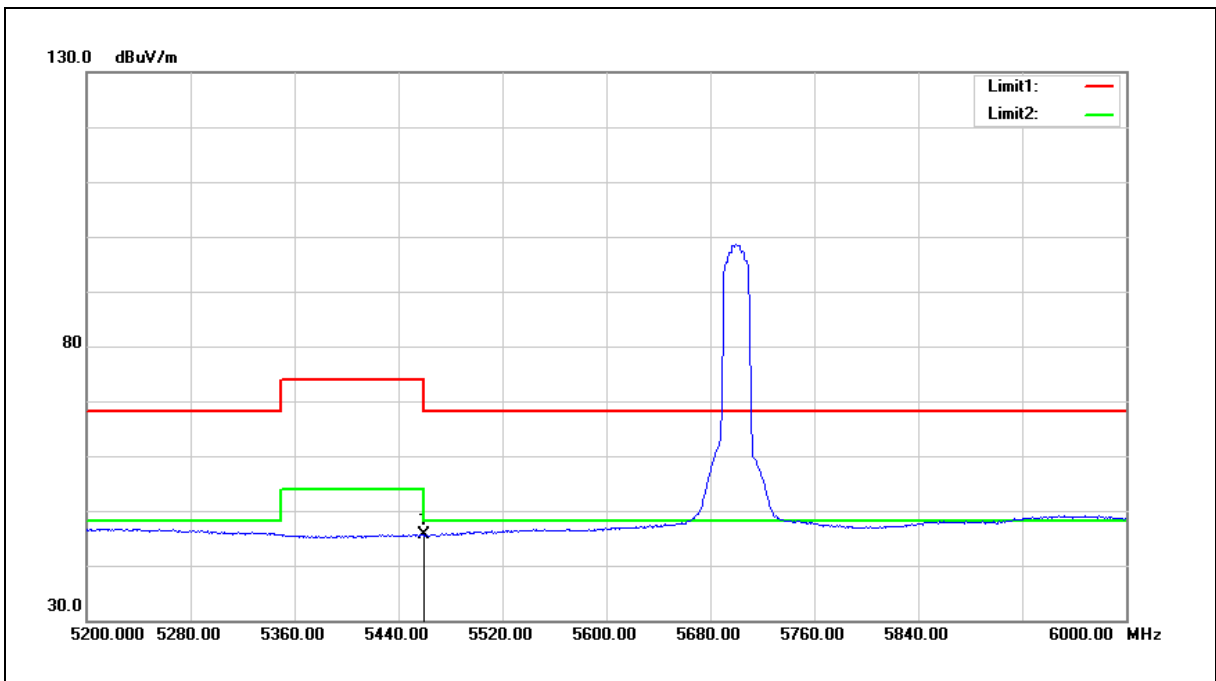

| No. | Frequency (MHz) | Reading (dBuV) | Correct Factor (dB/m) | Result (dBuV/m) | Limit (dBuV/m) | Margin (dB) | Remark |
|-----|-----------------|----------------|-----------------------|-----------------|----------------|-------------|--------|
| 1 | 5460.000 | 40.56 | 4.97 | 45.53 | 54.00 | -8.47 | AVG |

Note:1.Result (dBuV/m) = Correct Factor (dB/m) + Reading(dBuV).

2.Correction factor (dB/m) = Antenna Factor (dB/m) + Cable loss (dB) – Pre-Amplifier gain (dB).

3.When the peak results are less than average limit, so not need to evaluate the average.



| | | | |
|-------------|-----------------|----------------|-----|
| Standard: | FCC Part 15.407 | Test Distance: | 3 m |
| Test item: | Band edge | | |
| Frequency: | 5720 MHz | | |
| Mode: | Mode 8 | | |
| Ant.Polar.: | Horizontal | | |

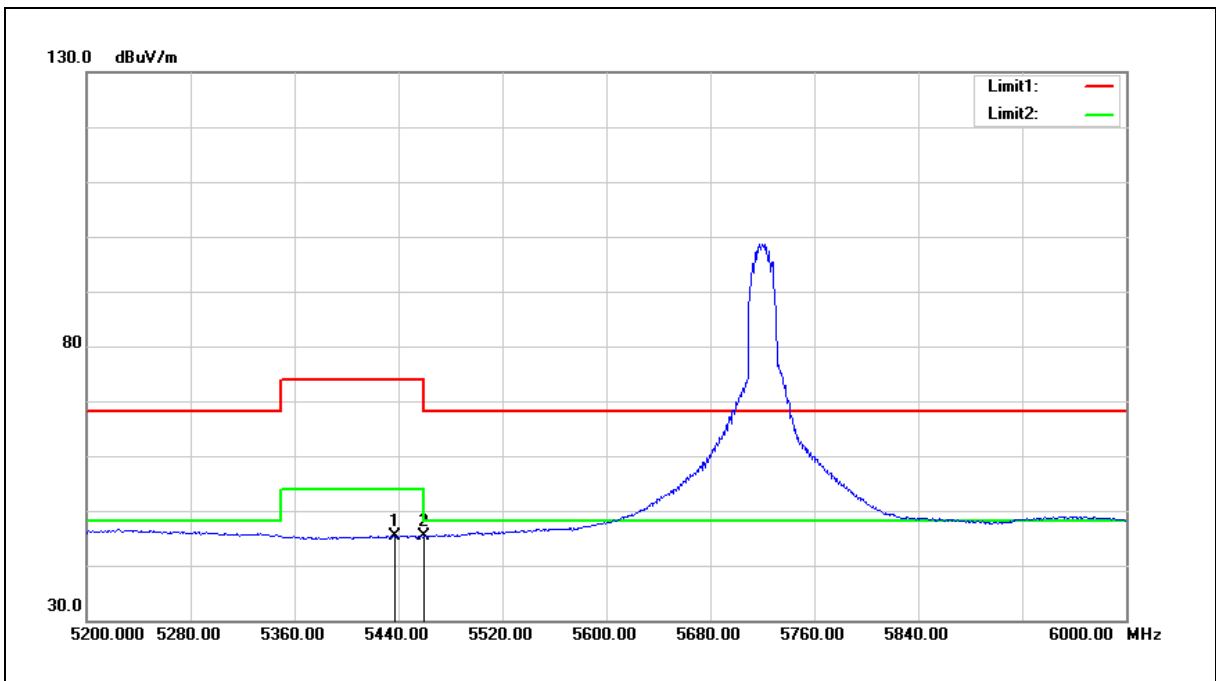

| No. | Frequency (MHz) | Reading (dBuV) | Correct Factor (dB/m) | Result (dBuV/m) | Limit (dBuV/m) | Margin (dB) | Remark |
|-----|-----------------|----------------|-----------------------|-----------------|----------------|-------------|--------|
| 1 | 5437.600 | 40.48 | 4.94 | 45.42 | 54.00 | -8.58 | AVG |
| 2 | 5460.000 | 40.42 | 4.97 | 45.39 | 54.00 | -8.61 | AVG |

Note:1.Result (dBuV/m) = Correct Factor (dB/m) + Reading(dBuV).

2.Correction factor (dB/m) = Antenna Factor (dB/m) + Cable loss (dB) – Pre-Amplifier gain (dB).

3.When the peak results are less than average limit, so not need to evaluate the average.



| | | | |
|-------------|-----------------|----------------|-----|
| Standard: | FCC Part 15.407 | Test Distance: | 3 m |
| Test item: | Band edge | | |
| Frequency: | 5720 MHz | | |
| Mode: | Mode 8 | | |
| Ant.Polar.: | Vertical | | |

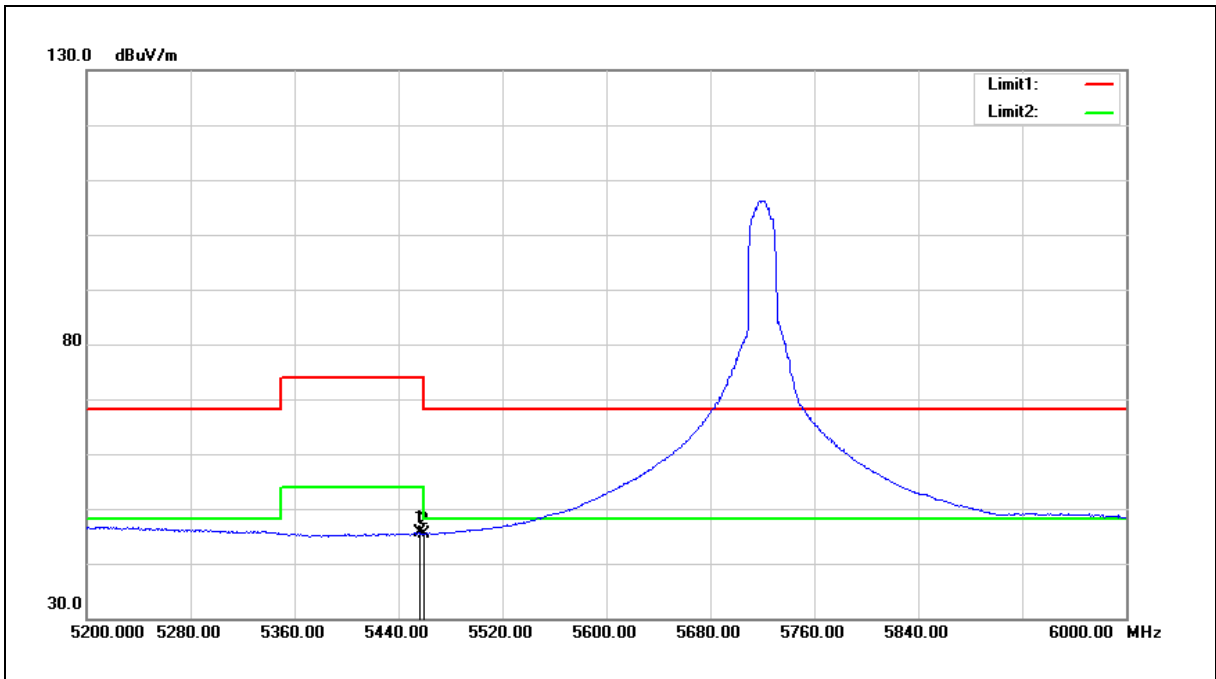

| No. | Frequency (MHz) | Reading (dBuV) | Correct Factor (dB/m) | Result (dBuV/m) | Limit (dBuV/m) | Margin (dB) | Remark |
|-----|-----------------|----------------|-----------------------|-----------------|----------------|-------------|--------|
| 1 | 5456.000 | 40.60 | 4.96 | 45.56 | 54.00 | -8.44 | AVG |
| 2 | 5460.000 | 40.38 | 4.97 | 45.35 | 54.00 | -8.65 | AVG |

Note:1.Result (dBuV/m) = Correct Factor (dB/m) + Reading(dBuV).

2.Correction factor (dB/m) = Antenna Factor (dB/m) + Cable loss (dB) – Pre-Amplifier gain (dB).

3.When the peak results are less than average limit, so not need to evaluate the average.



| | | | |
|-------------|-----------------|----------------|-----|
| Standard: | FCC Part 15.407 | Test Distance: | 3 m |
| Test item: | Band edge | | |
| Frequency: | 5190 MHz | | |
| Mode: | Mode 9 | | |
| Ant.Polar.: | Horizontal | | |

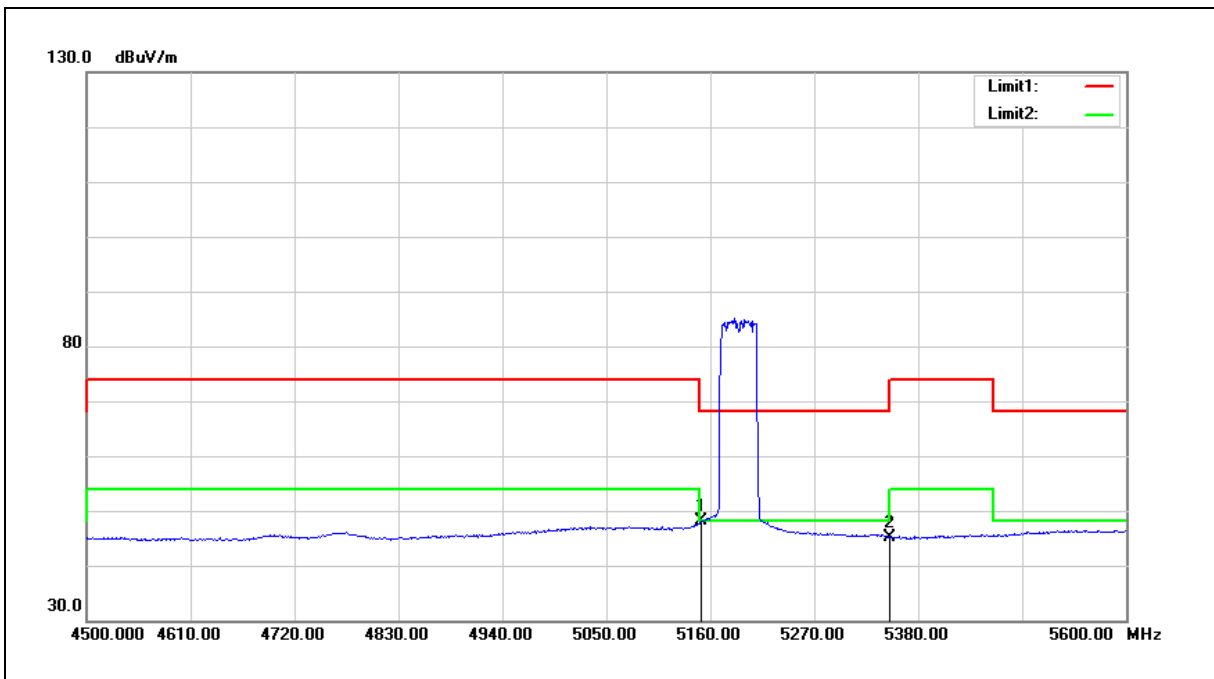

| No. | Frequency (MHz) | Reading (dBuV) | Correct Factor (dB/m) | Result (dBuV/m) | Limit (dBuV/m) | Margin (dB) | Remark |
|-----|-----------------|----------------|-----------------------|-----------------|----------------|-------------|--------|
| 1 | 5150.000 | 43.48 | 4.60 | 48.08 | 54.00 | -5.92 | AVG |
| 2 | 5350.000 | 40.29 | 4.84 | 45.13 | 54.00 | -8.87 | AVG |

Note:1.Result (dBuV/m) = Correct Factor (dB/m) + Reading(dBuV).

2.Correction factor (dB/m) = Antenna Factor (dB/m) + Cable loss (dB) – Pre-Amplifier gain (dB).

3.When the peak results are less than average limit, so not need to evaluate the average.



| | | | |
|-------------|-----------------|----------------|-----|
| Standard: | FCC Part 15.407 | Test Distance: | 3 m |
| Test item: | Band edge | | |
| Frequency: | 5190 MHz | | |
| Mode: | Mode 9 | | |
| Ant.Polar.: | Vertical | | |

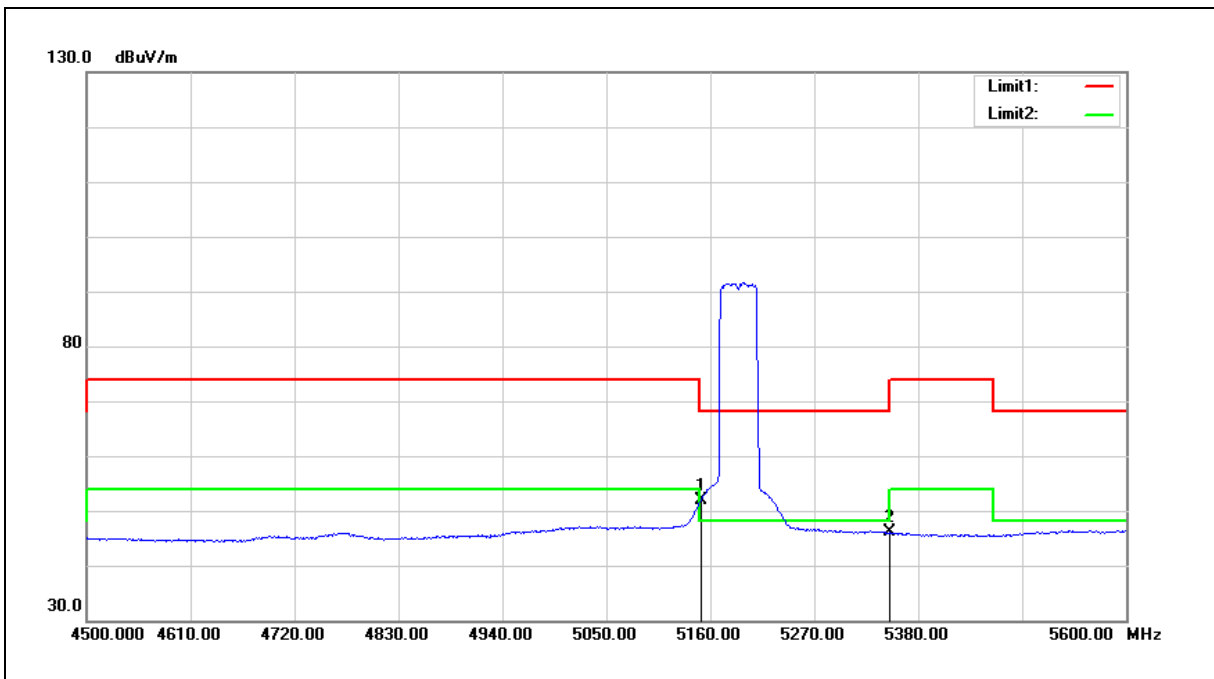

| No. | Frequency (MHz) | Reading (dBuV) | Correct Factor (dB/m) | Result (dBuV/m) | Limit (dBuV/m) | Margin (dB) | Remark |
|-----|-----------------|----------------|-----------------------|-----------------|----------------|-------------|--------|
| 1 | 5150.000 | 47.31 | 4.60 | 51.91 | 54.00 | -2.09 | AVG |
| 2 | 5350.000 | 41.17 | 4.84 | 46.01 | 54.00 | -7.99 | AVG |

Note:1.Result (dBuV/m) = Correct Factor (dB/m) + Reading(dBuV).

2.Correction factor (dB/m) = Antenna Factor (dB/m) + Cable loss (dB) – Pre-Amplifier gain (dB).

3.When the peak results are less than average limit, so not need to evaluate the average.



| | | | |
|-------------|-----------------|----------------|-----|
| Standard: | FCC Part 15.407 | Test Distance: | 3 m |
| Test item: | Band edge | | |
| Frequency: | 5230 MHz | | |
| Mode: | Mode 9 | | |
| Ant.Polar.: | Horizontal | | |

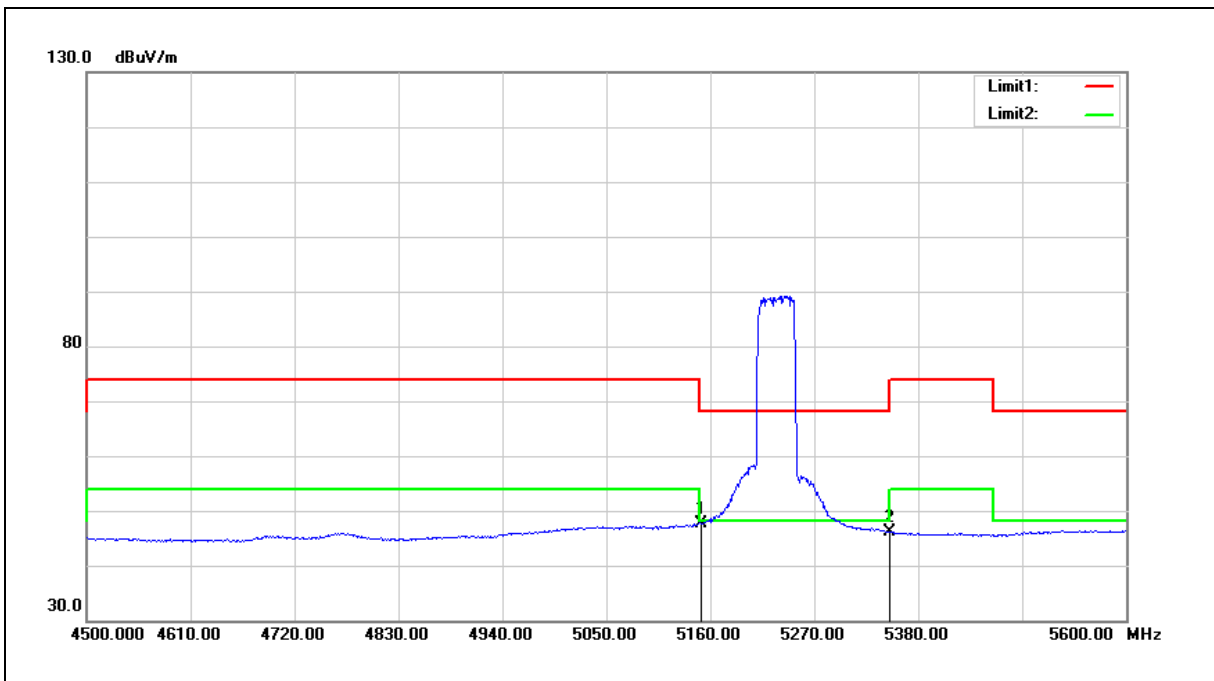

| No. | Frequency (MHz) | Reading (dBuV) | Correct Factor (dB/m) | Result (dBuV/m) | Limit (dBuV/m) | Margin (dB) | Remark |
|-----|-----------------|----------------|-----------------------|-----------------|----------------|-------------|--------|
| 1 | 5150.000 | 43.11 | 4.60 | 47.71 | 54.00 | -6.29 | AVG |
| 2 | 5350.000 | 41.23 | 4.84 | 46.07 | 54.00 | -7.93 | AVG |

Note:1.Result (dBuV/m) = Correct Factor (dB/m) + Reading(dBuV).

2.Correction factor (dB/m) = Antenna Factor (dB/m) + Cable loss (dB) – Pre-Amplifier gain (dB).

3.When the peak results are less than average limit, so not need to evaluate the average.



| | | | |
|-------------|-----------------|----------------|-----|
| Standard: | FCC Part 15.407 | Test Distance: | 3 m |
| Test item: | Band edge | | |
| Frequency: | 5230 MHz | | |
| Mode: | Mode 9 | | |
| Ant.Polar.: | Vertical | | |

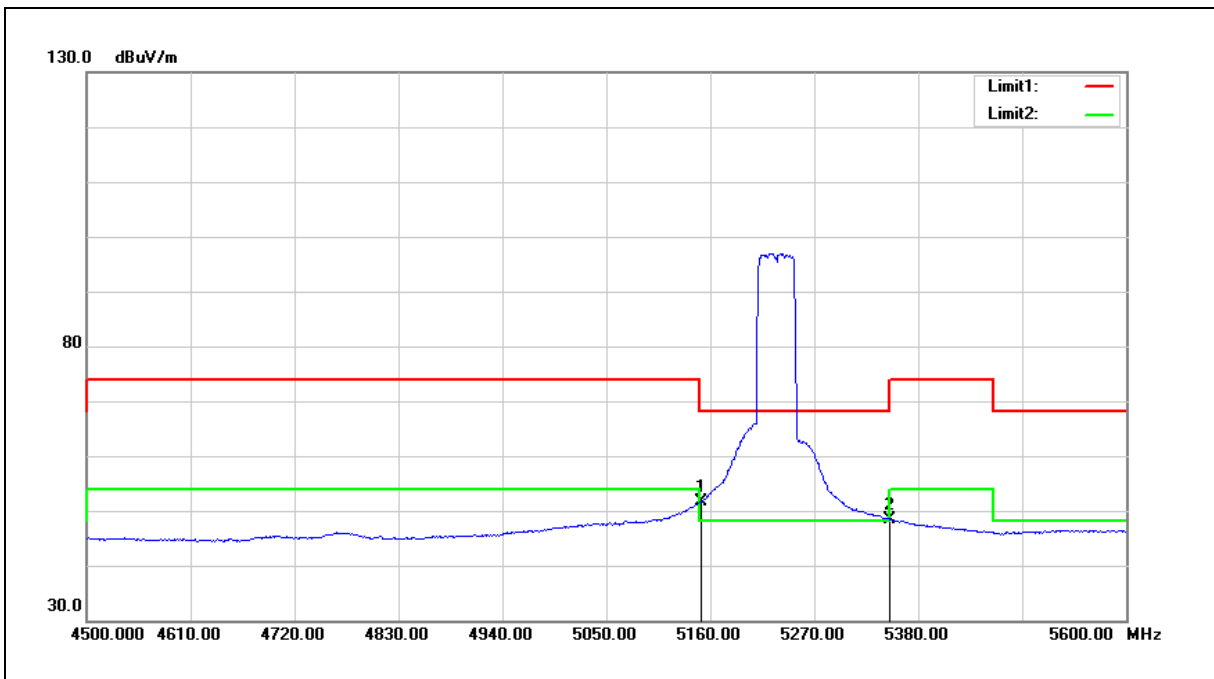

| No. | Frequency (MHz) | Reading (dBuV) | Correct Factor (dB/m) | Result (dBuV/m) | Limit (dBuV/m) | Margin (dB) | Remark |
|-----|-----------------|----------------|-----------------------|-----------------|----------------|-------------|--------|
| 1 | 5150.000 | 47.03 | 4.60 | 51.63 | 54.00 | -2.37 | AVG |
| 2 | 5350.000 | 43.62 | 4.84 | 48.46 | 54.00 | -5.54 | AVG |

Note:1.Result (dBuV/m) = Correct Factor (dB/m) + Reading(dBuV).

2.Correction factor (dB/m) = Antenna Factor (dB/m) + Cable loss (dB) – Pre-Amplifier gain (dB).

3.When the peak results are less than average limit, so not need to evaluate the average.



| | | | |
|-------------|-----------------|----------------|-----|
| Standard: | FCC Part 15.407 | Test Distance: | 3 m |
| Test item: | Band edge | | |
| Frequency: | 5270 MHz | | |
| Mode: | Mode 9 | | |
| Ant.Polar.: | Horizontal | | |

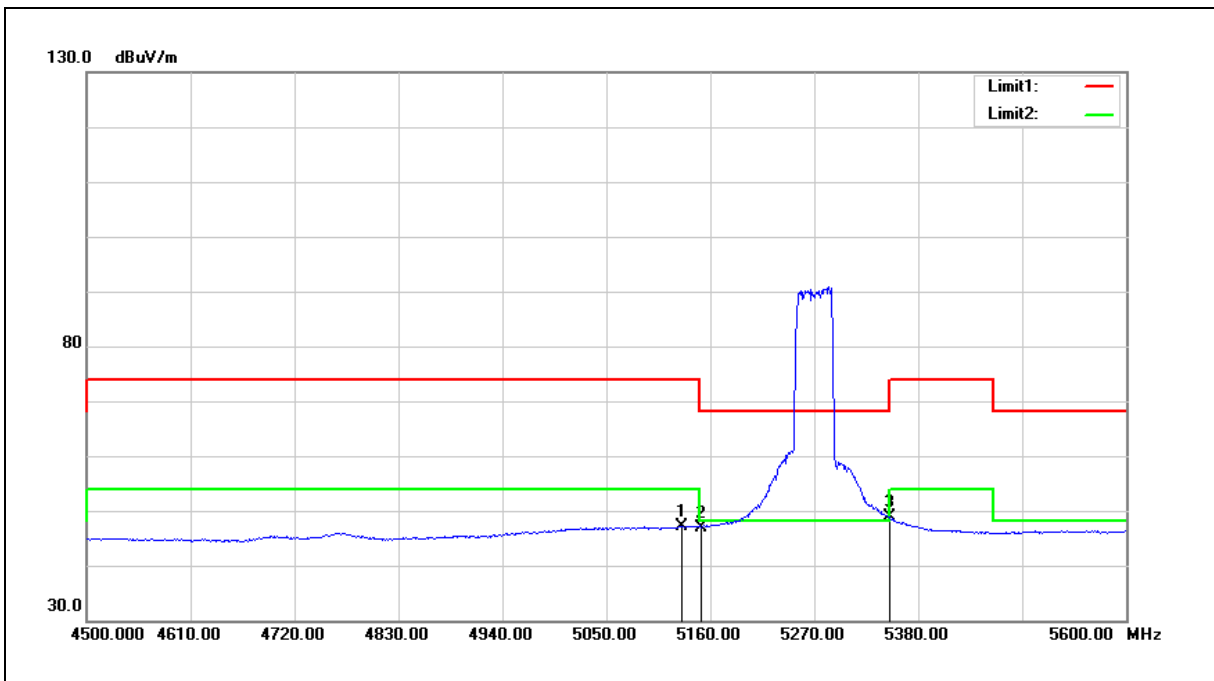

| No. | Frequency (MHz) | Reading (dBuV) | Correct Factor (dB/m) | Result (dBuV/m) | Limit (dBuV/m) | Margin (dB) | Remark |
|-----|-----------------|----------------|-----------------------|-----------------|----------------|-------------|--------|
| 1 | 5129.200 | 42.65 | 4.57 | 47.22 | 54.00 | -6.78 | AVG |
| 2 | 5150.000 | 42.38 | 4.60 | 46.98 | 54.00 | -7.02 | AVG |
| 3 | 5350.000 | 43.97 | 4.84 | 48.81 | 54.00 | -5.19 | AVG |

Note:1.Result (dBuV/m) = Correct Factor (dB/m) + Reading(dBuV).

2.Correction factor (dB/m) = Antenna Factor (dB/m) + Cable loss (dB) – Pre-Amplifier gain (dB).

3.When the peak results are less than average limit, so not need to evaluate the average.



| | | | |
|-------------|-----------------|----------------|-----|
| Standard: | FCC Part 15.407 | Test Distance: | 3 m |
| Test item: | Band edge | | |
| Frequency: | 5270 MHz | | |
| Mode: | Mode 9 | | |
| Ant.Polar.: | Vertical | | |

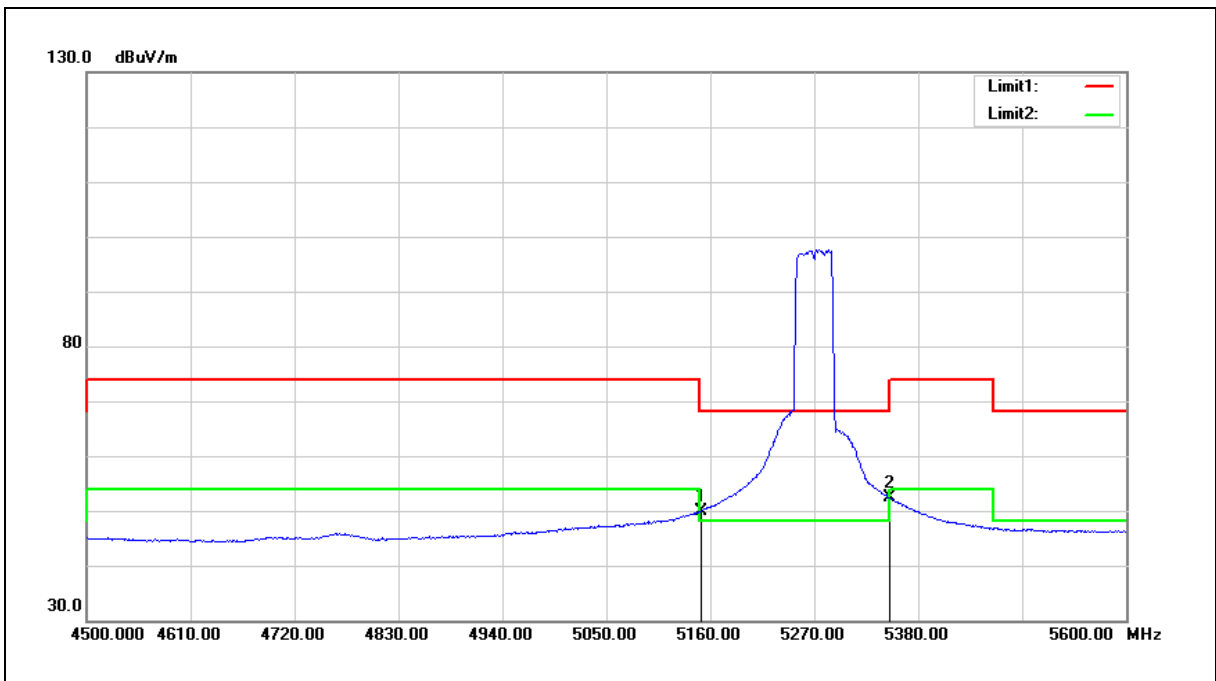

| No. | Frequency (MHz) | Reading (dBuV) | Correct Factor (dB/m) | Result (dBuV/m) | Limit (dBuV/m) | Margin (dB) | Remark |
|-----|-----------------|----------------|-----------------------|-----------------|----------------|-------------|--------|
| 1 | 5150.000 | 45.28 | 4.60 | 49.88 | 54.00 | -4.12 | AVG |
| 2 | 5350.000 | 47.42 | 4.84 | 52.26 | 54.00 | -1.74 | AVG |

Note:1.Result (dBuV/m) = Correct Factor (dB/m) + Reading(dBuV).

2.Correction factor (dB/m) = Antenna Factor (dB/m) + Cable loss (dB) – Pre-Amplifier gain (dB).

3.When the peak results are less than average limit, so not need to evaluate the average.



| | | | |
|-------------|-----------------|----------------|-----|
| Standard: | FCC Part 15.407 | Test Distance: | 3 m |
| Test item: | Band edge | | |
| Frequency: | 5310 MHz | | |
| Mode: | Mode 9 | | |
| Ant.Polar.: | Horizontal | | |

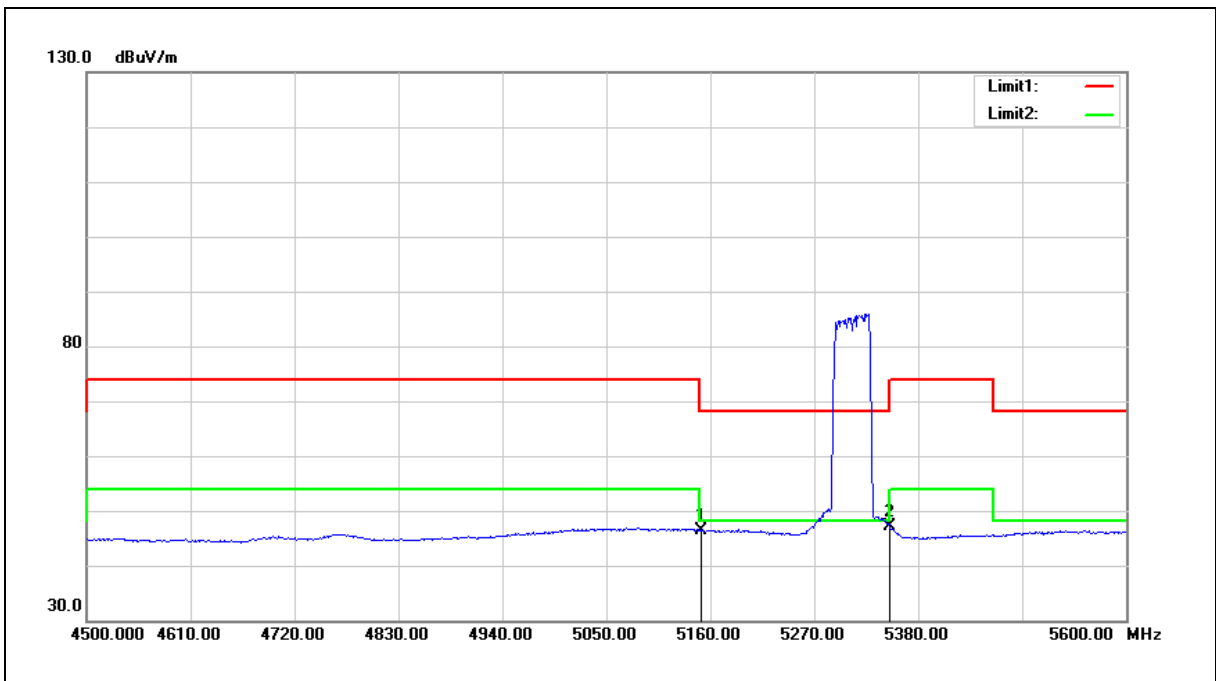

| No. | Frequency (MHz) | Reading (dBuV) | Correct Factor (dB/m) | Result (dBuV/m) | Limit (dBuV/m) | Margin (dB) | Remark |
|-----|-----------------|----------------|-----------------------|-----------------|----------------|-------------|--------|
| 1 | 5150.000 | 41.89 | 4.60 | 46.49 | 54.00 | -7.51 | AVG |
| 2 | 5350.000 | 42.19 | 4.84 | 47.03 | 54.00 | -6.97 | AVG |

Note:1.Result (dBuV/m) = Correct Factor (dB/m) + Reading(dBuV).

2.Correction factor (dB/m) = Antenna Factor (dB/m) + Cable loss (dB) – Pre-Amplifier gain (dB).

3.When the peak results are less than average limit, so not need to evaluate the average.



| | | | |
|-------------|-----------------|----------------|-----|
| Standard: | FCC Part 15.407 | Test Distance: | 3 m |
| Test item: | Band edge | | |
| Frequency: | 5310 MHz | | |
| Mode: | Mode 9 | | |
| Ant.Polar.: | Vertical | | |

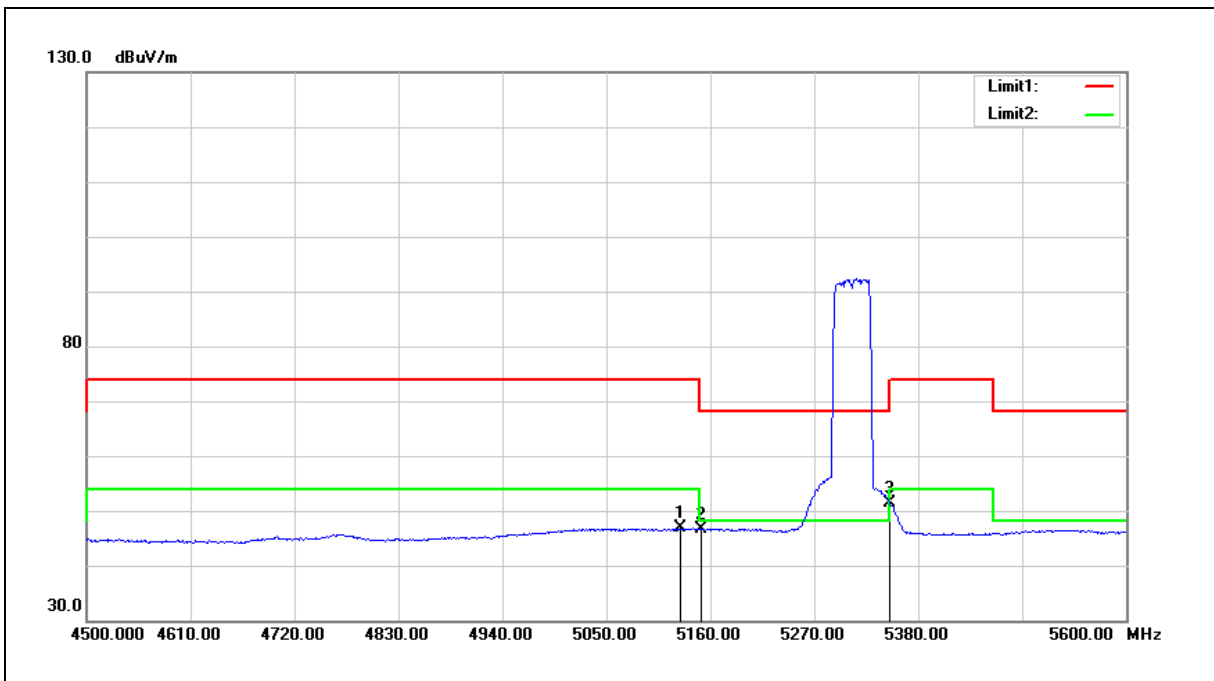

| No. | Frequency (MHz) | Reading (dBuV) | Correct Factor (dB/m) | Result (dBuV/m) | Limit (dBuV/m) | Margin (dB) | Remark |
|-----|-----------------|----------------|-----------------------|-----------------|----------------|-------------|--------|
| 1 | 5128.100 | 42.28 | 4.57 | 46.85 | 54.00 | -7.15 | AVG |
| 2 | 5150.000 | 42.13 | 4.60 | 46.73 | 54.00 | -7.27 | AVG |
| 3 | 5350.000 | 46.51 | 4.84 | 51.35 | 54.00 | -2.65 | AVG |

Note:1.Result (dBuV/m) = Correct Factor (dB/m) + Reading(dBuV).

2.Correction factor (dB/m) = Antenna Factor (dB/m) + Cable loss (dB) – Pre-Amplifier gain (dB).

3.When the peak results are less than average limit, so not need to evaluate the average.



| | | | |
|-------------|-----------------|----------------|-----|
| Standard: | FCC Part 15.407 | Test Distance: | 3 m |
| Test item: | Band edge | | |
| Frequency: | 5510 MHz | | |
| Mode: | Mode 9 | | |
| Ant.Polar.: | Horizontal | | |

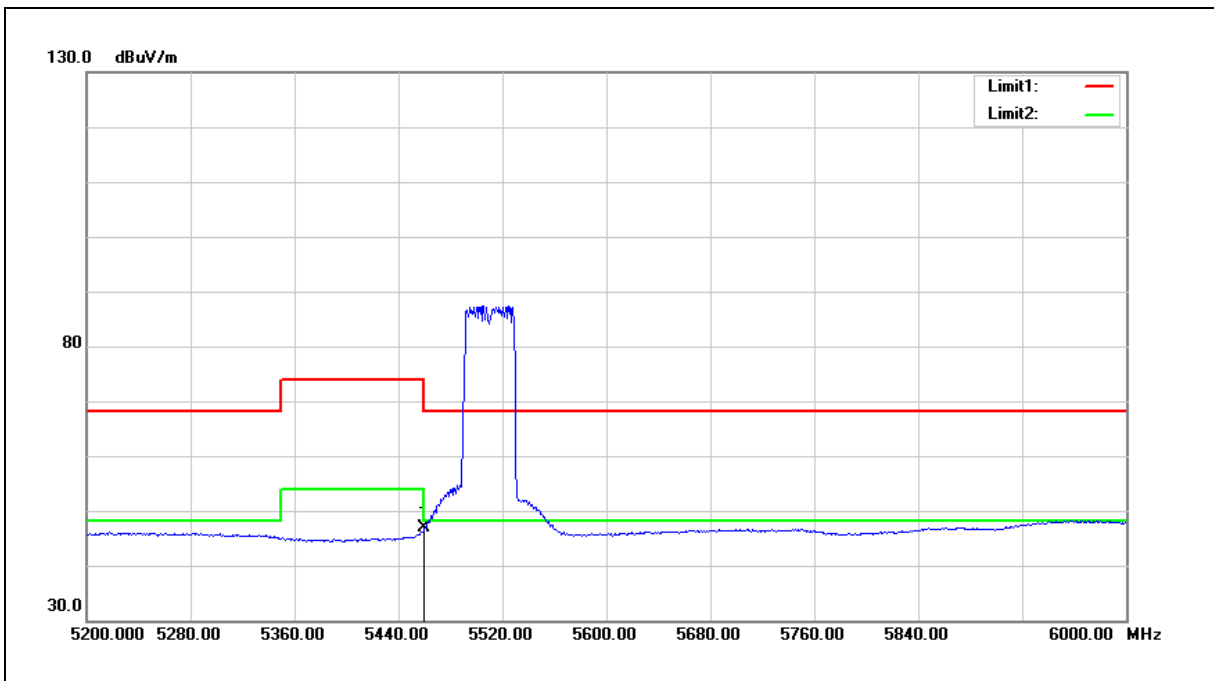

| No. | Frequency (MHz) | Reading (dBuV) | Correct Factor (dB/m) | Result (dBuV/m) | Limit (dBuV/m) | Margin (dB) | Remark |
|-----|-----------------|----------------|-----------------------|-----------------|----------------|-------------|--------|
| 1 | 5460.000 | 41.99 | 4.97 | 46.96 | 54.00 | -7.04 | AVG |

Note:1.Result (dBuV/m) = Correct Factor (dB/m) + Reading(dBuV).

2.Correction factor (dB/m) = Antenna Factor (dB/m) + Cable loss (dB) – Pre-Amplifier gain (dB).

3.When the peak results are less than average limit, so not need to evaluate the average.



| | | | |
|-------------|-----------------|----------------|-----|
| Standard: | FCC Part 15.407 | Test Distance: | 3 m |
| Test item: | Band edge | | |
| Frequency: | 5510 MHz | | |
| Mode: | Mode 9 | | |
| Ant.Polar.: | Vertical | | |

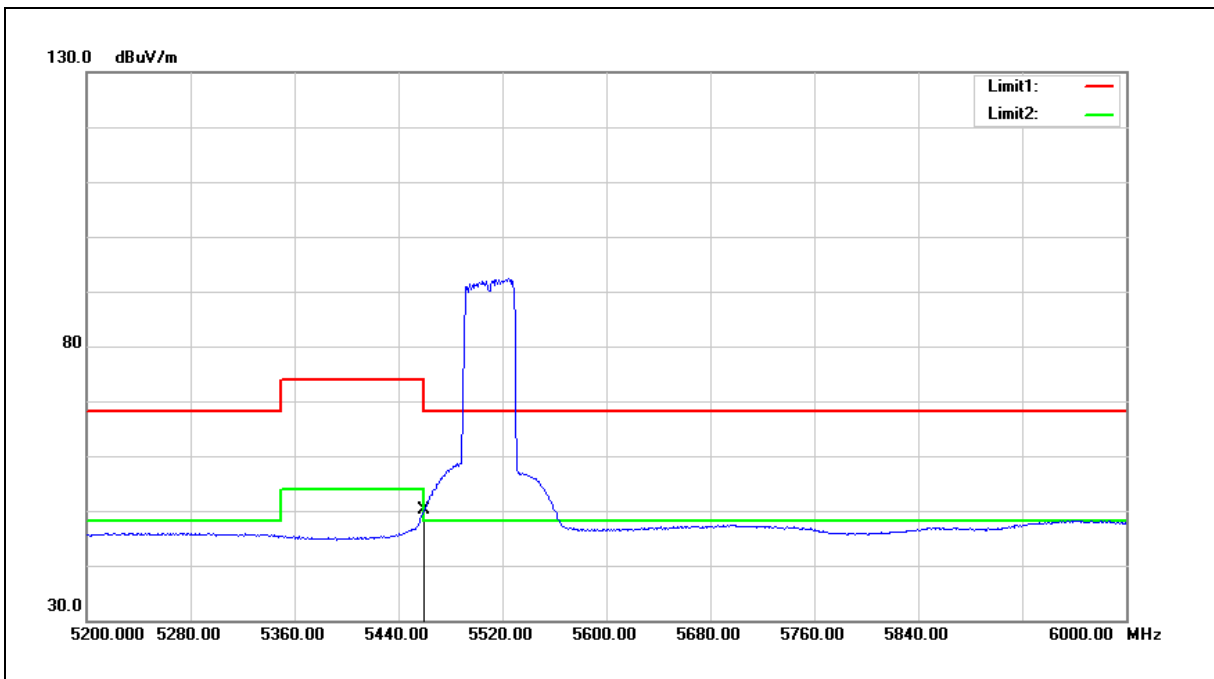

| No. | Frequency (MHz) | Reading (dBuV) | Correct Factor (dB/m) | Result (dBuV/m) | Limit (dBuV/m) | Margin (dB) | Remark |
|-----|-----------------|----------------|-----------------------|-----------------|----------------|-------------|--------|
| 1 | 5460.000 | 45.23 | 4.97 | 50.20 | 54.00 | -3.80 | AVG |

- Note:1.Result (dBuV/m) = Correct Factor (dB/m) + Reading(dBuV).
- 2.Correction factor (dB/m) = Antenna Factor (dB/m) + Cable loss (dB) – Pre-Amplifier gain (dB).
- 3.When the peak results are less than average limit, so not need to evaluate the average.



| | | | |
|-------------|-----------------|----------------|-----|
| Standard: | FCC Part 15.407 | Test Distance: | 3 m |
| Test item: | Band edge | | |
| Frequency: | 5550 MHz | | |
| Mode: | Mode 9 | | |
| Ant.Polar.: | Horizontal | | |

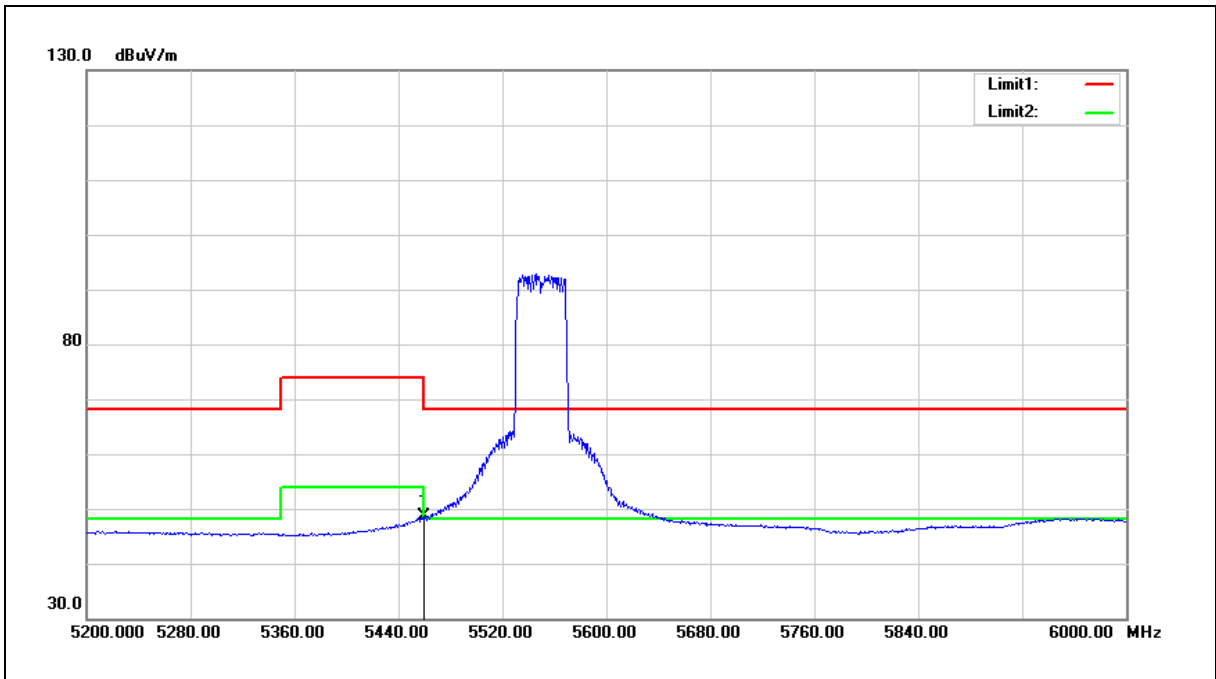

| No. | Frequency (MHz) | Reading (dBuV) | Correct Factor (dB/m) | Result (dBuV/m) | Limit (dBuV/m) | Margin (dB) | Remark |
|-----|-----------------|----------------|-----------------------|-----------------|----------------|-------------|--------|
| 1 | 5460.000 | 43.62 | 4.97 | 48.59 | 54.00 | -5.41 | AVG |

Note:1.Result (dBuV/m) = Correct Factor (dB/m) + Reading(dBuV).

2.Correction factor (dB/m) = Antenna Factor (dB/m) + Cable loss (dB) – Pre-Amplifier gain (dB).

3.When the peak results are less than average limit, so not need to evaluate the average.



| | | | |
|-------------|-----------------|----------------|-----|
| Standard: | FCC Part 15.407 | Test Distance: | 3 m |
| Test item: | Band edge | | |
| Frequency: | 5550 MHz | | |
| Mode: | Mode 9 | | |
| Ant.Polar.: | Vertical | | |

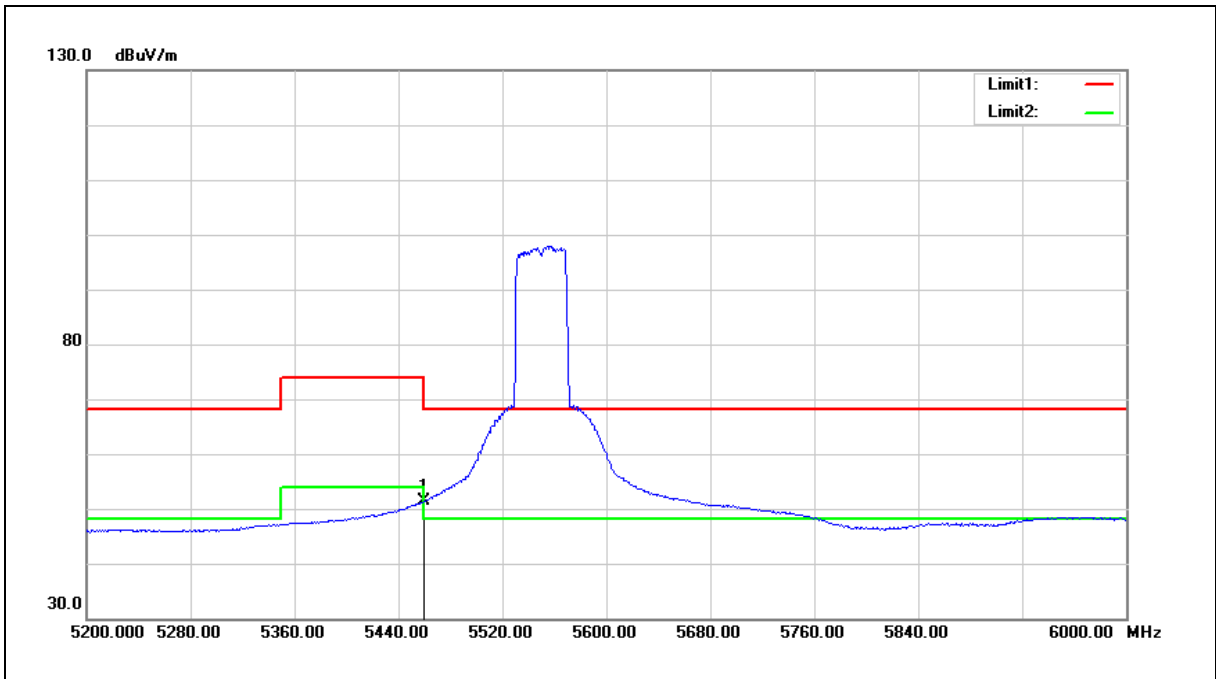

| No. | Frequency (MHz) | Reading (dBuV) | Correct Factor (dB/m) | Result (dBuV/m) | Limit (dBuV/m) | Margin (dB) | Remark |
|-----|-----------------|----------------|-----------------------|-----------------|----------------|-------------|--------|
| 1 | 5460.000 | 46.46 | 4.97 | 51.43 | 54.00 | -2.57 | AVG |

Note:1.Result (dBuV/m) = Correct Factor (dB/m) + Reading(dBuV).

2.Correction factor (dB/m) = Antenna Factor (dB/m) + Cable loss (dB) – Pre-Amplifier gain (dB).

3.When the peak results are less than average limit, so not need to evaluate the average.



| | | | |
|-------------|-----------------|----------------|-----|
| Standard: | FCC Part 15.407 | Test Distance: | 3 m |
| Test item: | Band edge | | |
| Frequency: | 5670 MHz | | |
| Mode: | Mode 9 | | |
| Ant.Polar.: | Horizontal | | |

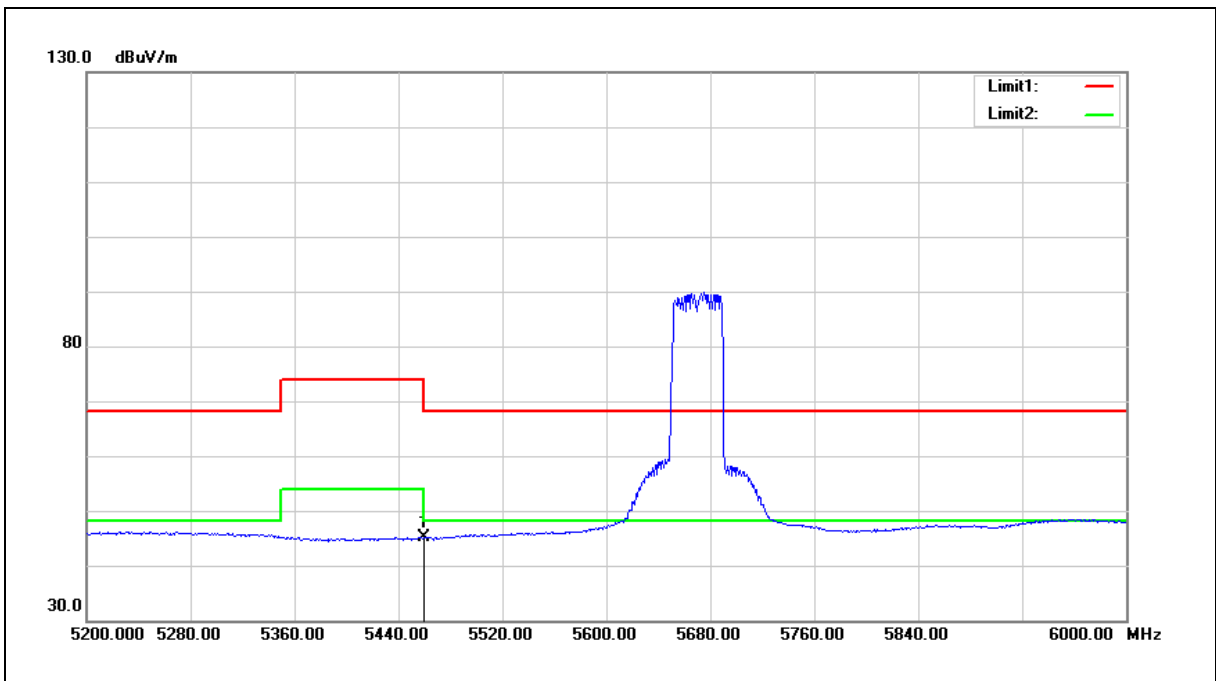

| No. | Frequency (MHz) | Reading (dBuV) | Correct Factor (dB/m) | Result (dBuV/m) | Limit (dBuV/m) | Margin (dB) | Remark |
|-----|-----------------|----------------|-----------------------|-----------------|----------------|-------------|--------|
| 1 | 5460.000 | 40.27 | 4.97 | 45.24 | 54.00 | -8.76 | AVG |

Note:1.Result (dBuV/m) = Correct Factor (dB/m) + Reading(dBuV).

2.Correction factor (dB/m) = Antenna Factor (dB/m) + Cable loss (dB) – Pre-Amplifier gain (dB).

3.When the peak results are less than average limit, so not need to evaluate the average.



| | | | |
|-------------|-----------------|----------------|-----|
| Standard: | FCC Part 15.407 | Test Distance: | 3 m |
| Test item: | Band edge | | |
| Frequency: | 5670 MHz | | |
| Mode: | Mode 9 | | |
| Ant.Polar.: | Vertical | | |

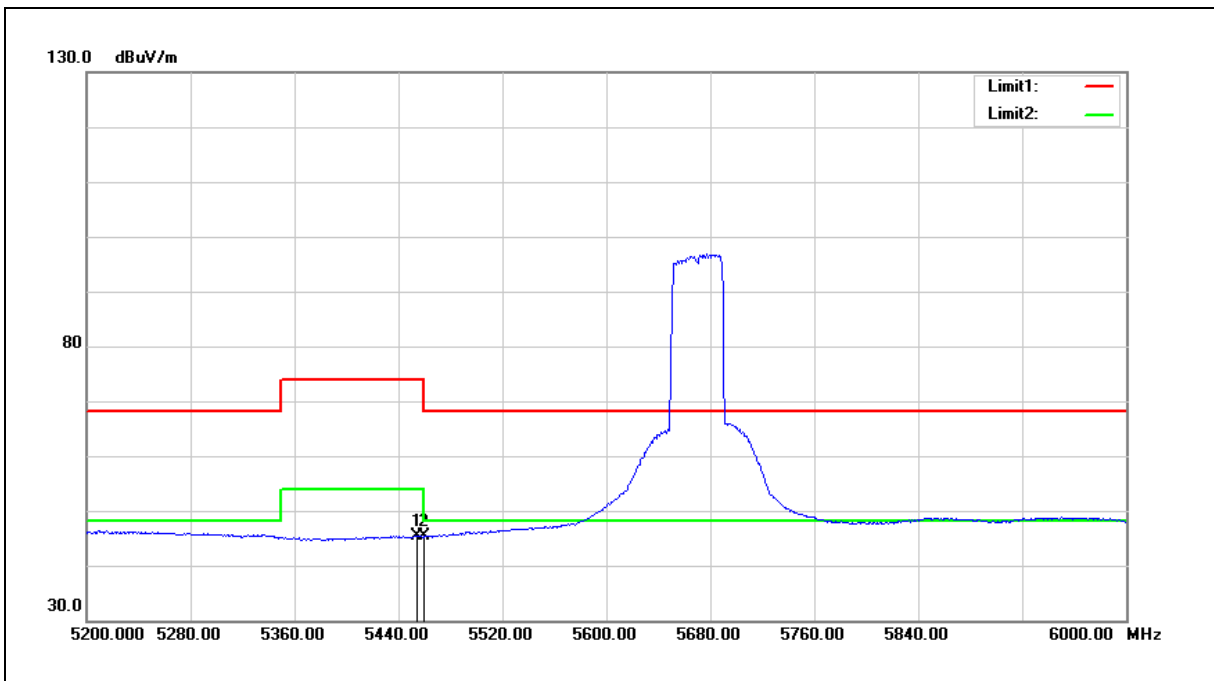

| No. | Frequency (MHz) | Reading (dBuV) | Correct Factor (dB/m) | Result (dBuV/m) | Limit (dBuV/m) | Margin (dB) | Remark |
|-----|-----------------|----------------|-----------------------|-----------------|----------------|-------------|--------|
| 1 | 5454.400 | 40.49 | 4.95 | 45.44 | 54.00 | -8.56 | AVG |
| 2 | 5460.000 | 40.51 | 4.97 | 45.48 | 54.00 | -8.52 | AVG |

Note:1.Result (dBuV/m) = Correct Factor (dB/m) + Reading(dBuV).

2.Correction factor (dB/m) = Antenna Factor (dB/m) + Cable loss (dB) – Pre-Amplifier gain (dB).

3.When the peak results are less than average limit, so not need to evaluate the average.



| | | | |
|-------------|-----------------|----------------|-----|
| Standard: | FCC Part 15.407 | Test Distance: | 3 m |
| Test item: | Band edge | | |
| Frequency: | 5710 MHz | | |
| Mode: | Mode 9 | | |
| Ant.Polar.: | Horizontal | | |

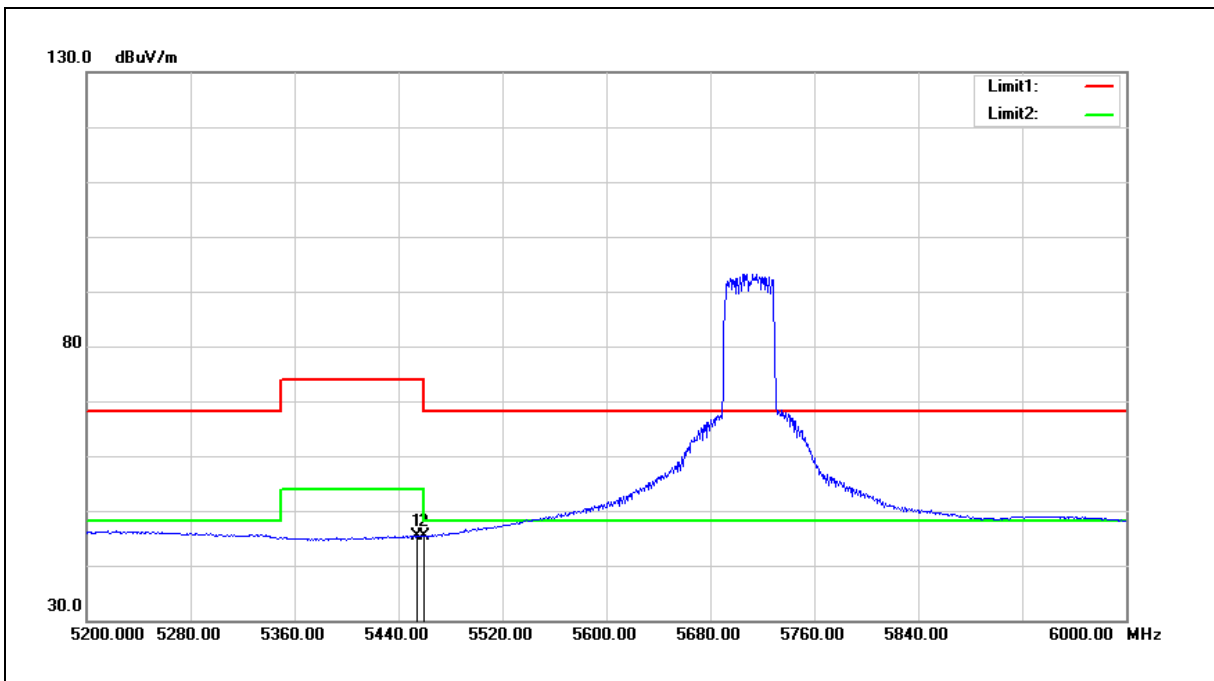

| No. | Frequency (MHz) | Reading (dBuV) | Correct Factor (dB/m) | Result (dBuV/m) | Limit (dBuV/m) | Margin (dB) | Remark |
|-----|-----------------|----------------|-----------------------|-----------------|----------------|-------------|--------|
| 1 | 5454.400 | 40.50 | 4.95 | 45.45 | 54.00 | -8.55 | AVG |
| 2 | 5460.000 | 40.38 | 4.97 | 45.35 | 54.00 | -8.65 | AVG |

Note:1.Result (dBuV/m) = Correct Factor (dB/m) + Reading(dBuV).

2.Correction factor (dB/m) = Antenna Factor (dB/m) + Cable loss (dB) – Pre-Amplifier gain (dB).

3.When the peak results are less than average limit, so not need to evaluate the average.



| | | | |
|-------------|-----------------|----------------|-----|
| Standard: | FCC Part 15.407 | Test Distance: | 3 m |
| Test item: | Band edge | | |
| Frequency: | 5710 MHz | | |
| Mode: | Mode 9 | | |
| Ant.Polar.: | Vertical | | |

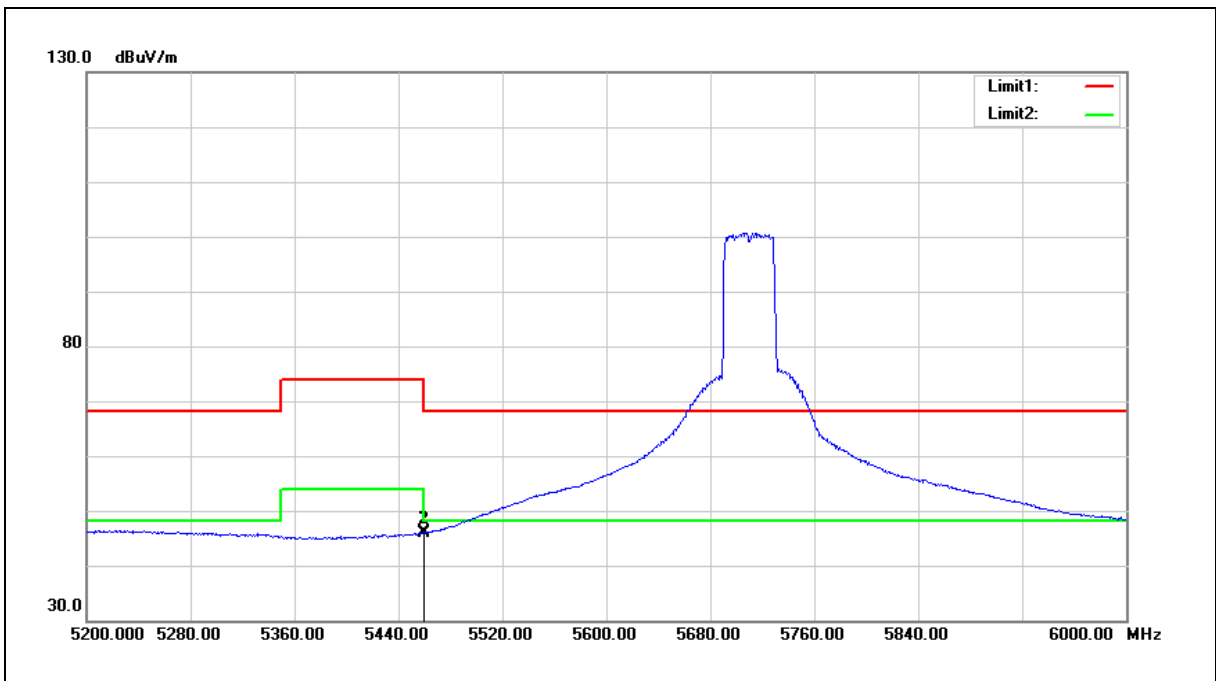

| No. | Frequency (MHz) | Reading (dBuV) | Correct Factor (dB/m) | Result (dBuV/m) | Limit (dBuV/m) | Margin (dB) | Remark |
|-----|-----------------|----------------|-----------------------|-----------------|----------------|-------------|--------|
| 1 | 5459.200 | 41.04 | 4.97 | 46.01 | 54.00 | -7.99 | AVG |
| 2 | 5460.000 | 40.98 | 4.97 | 45.95 | 54.00 | -8.05 | AVG |

Note:1.Result (dBuV/m) = Correct Factor (dB/m) + Reading(dBuV).

2.Correction factor (dB/m) = Antenna Factor (dB/m) + Cable loss (dB) – Pre-Amplifier gain (dB).

3.When the peak results are less than average limit, so not need to evaluate the average.



| | | | |
|-------------|-----------------|----------------|-----|
| Standard: | FCC Part 15.407 | Test Distance: | 3 m |
| Test item: | Band edge | | |
| Frequency: | 5210 MHz | | |
| Mode: | Mode 10 | | |
| Ant.Polar.: | Horizontal | | |

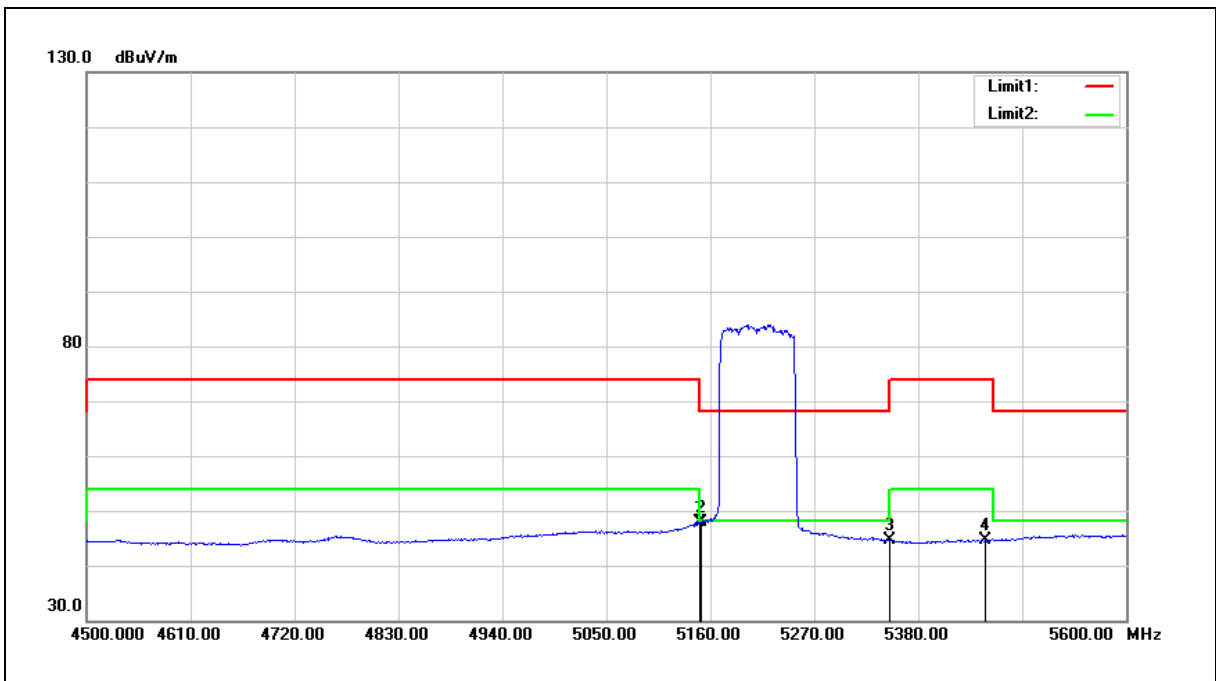

| No. | Frequency (MHz) | Reading (dBuV) | Correct Factor (dB/m) | Result (dBuV/m) | Limit (dBuV/m) | Margin (dB) | Remark |
|-----|-----------------|----------------|-----------------------|-----------------|----------------|-------------|--------|
| 1 | 5149.000 | 43.36 | 4.60 | 47.96 | 54.00 | -6.04 | AVG |
| 2 | 5150.000 | 43.29 | 4.60 | 47.89 | 54.00 | -6.11 | AVG |
| 3 | 5350.000 | 39.69 | 4.84 | 44.53 | 54.00 | -9.47 | AVG |
| 4 | 5450.400 | 39.74 | 4.95 | 44.69 | 54.00 | -9.31 | AVG |

Note:1.Result (dBuV/m) = Correct Factor (dB/m) + Reading(dBuV).

2.Correction factor (dB/m) = Antenna Factor (dB/m) + Cable loss (dB) – Pre-Amplifier gain (dB).

3.When the peak results are less than average limit, so not need to evaluate the average.



| | | | |
|-------------|-----------------|----------------|-----|
| Standard: | FCC Part 15.407 | Test Distance: | 3 m |
| Test item: | Band edge | | |
| Frequency: | 5210 MHz | | |
| Mode: | Mode 10 | | |
| Ant.Polar.: | Vertical | | |

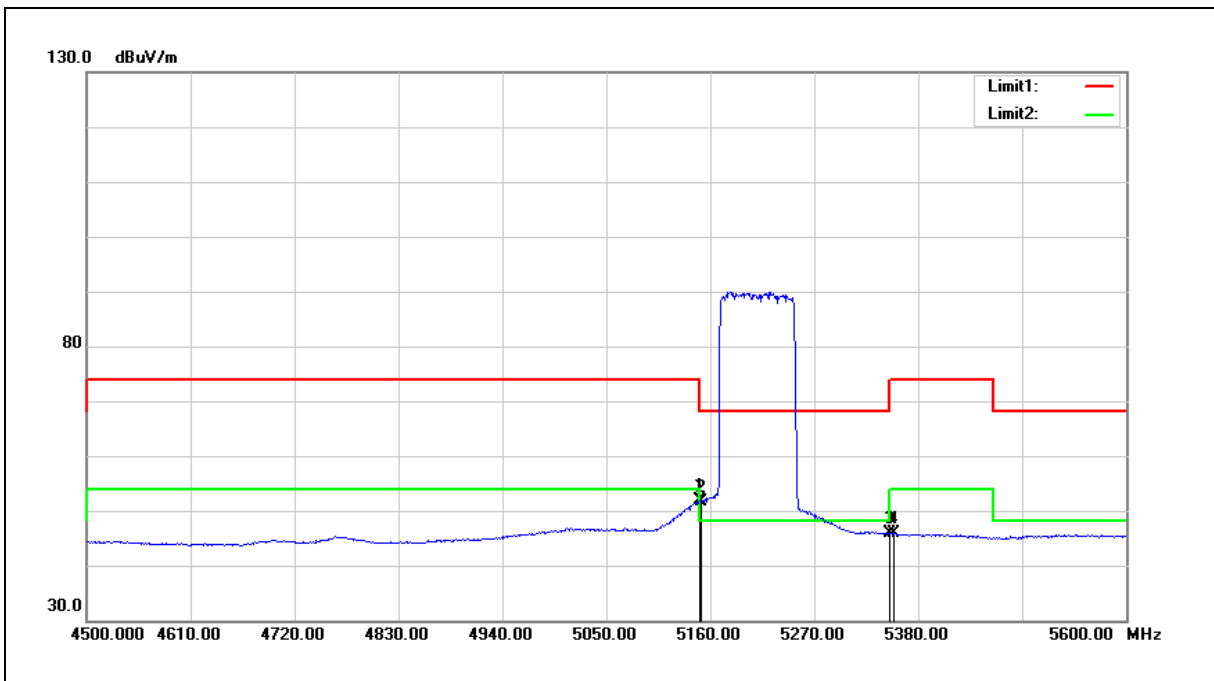

| No. | Frequency (MHz) | Reading (dBuV) | Correct Factor (dB/m) | Result (dBuV/m) | Limit (dBuV/m) | Margin (dB) | Remark |
|-----|-----------------|----------------|-----------------------|-----------------|----------------|-------------|--------|
| 1 | 5149.000 | 47.26 | 4.60 | 51.86 | 54.00 | -2.14 | AVG |
| 2 | 5150.000 | 47.11 | 4.60 | 51.71 | 54.00 | -2.29 | AVG |
| 3 | 5350.000 | 40.97 | 4.84 | 45.81 | 54.00 | -8.19 | AVG |
| 4 | 5353.600 | 40.99 | 4.84 | 45.83 | 54.00 | -8.17 | AVG |

Note:1.Result (dBuV/m) = Correct Factor (dB/m) + Reading(dBuV).

2.Correction factor (dB/m) = Antenna Factor (dB/m) + Cable loss (dB) – Pre-Amplifier gain (dB).

3.When the peak results are less than average limit, so not need to evaluate the average.



| | | | |
|-------------|-----------------|----------------|-----|
| Standard: | FCC Part 15.407 | Test Distance: | 3 m |
| Test item: | Band edge | | |
| Frequency: | 5290 MHz | | |
| Mode: | Mode 10 | | |
| Ant.Polar.: | Horizontal | | |

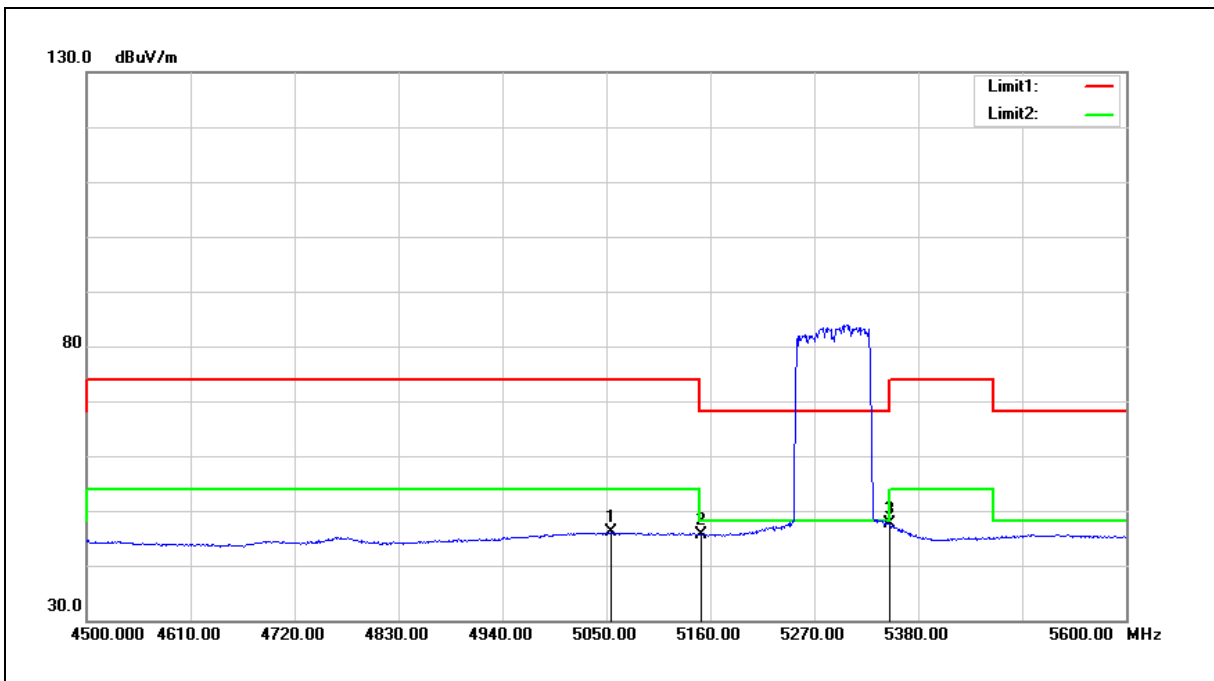

| No. | Frequency (MHz) | Reading (dBuV) | Correct Factor (dB/m) | Result (dBuV/m) | Limit (dBuV/m) | Margin (dB) | Remark |
|-----|-----------------|----------------|-----------------------|-----------------|----------------|-------------|--------|
| 1 | 5055.500 | 41.53 | 4.48 | 46.01 | 54.00 | -7.99 | AVG |
| 2 | 5150.000 | 41.02 | 4.60 | 45.62 | 54.00 | -8.38 | AVG |
| 3 | 5350.000 | 42.71 | 4.84 | 47.55 | 54.00 | -6.45 | AVG |

Note:1.Result (dBuV/m) = Correct Factor (dB/m) + Reading(dBuV).

2.Correction factor (dB/m) = Antenna Factor (dB/m) + Cable loss (dB) – Pre-Amplifier gain (dB).

3.When the peak results are less than average limit, so not need to evaluate the average.



| | | | |
|-------------|-----------------|----------------|-----|
| Standard: | FCC Part 15.407 | Test Distance: | 3 m |
| Test item: | Band edge | | |
| Frequency: | 5290 MHz | | |
| Mode: | Mode 10 | | |
| Ant.Polar.: | Vertical | | |

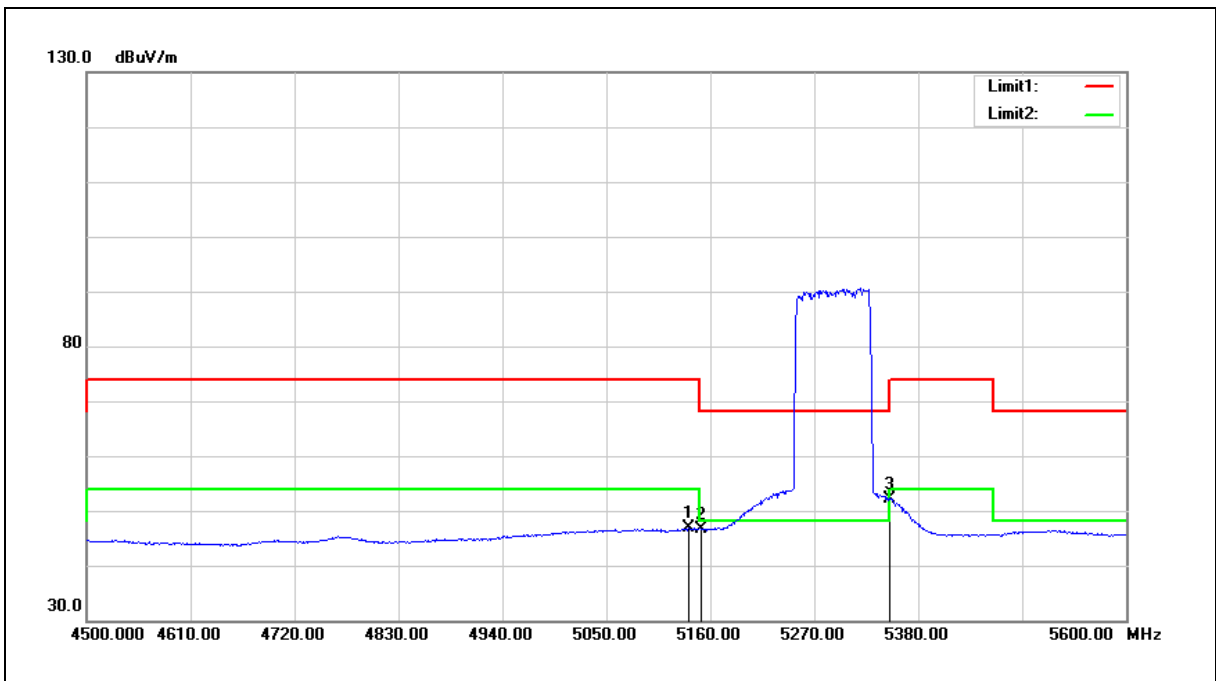

| No. | Frequency (MHz) | Reading (dBuV) | Correct Factor (dB/m) | Result (dBuV/m) | Limit (dBuV/m) | Margin (dB) | Remark |
|-----|-----------------|----------------|-----------------------|-----------------|----------------|-------------|--------|
| 1 | 5136.900 | 42.19 | 4.59 | 46.78 | 54.00 | -7.22 | AVG |
| 2 | 5150.000 | 42.11 | 4.60 | 46.71 | 54.00 | -7.29 | AVG |
| 3 | 5350.000 | 47.29 | 4.84 | 52.13 | 54.00 | -1.87 | AVG |

Note:1.Result (dBuV/m) = Correct Factor (dB/m) + Reading(dBuV).

2.Correction factor (dB/m) = Antenna Factor (dB/m) + Cable loss (dB) – Pre-Amplifier gain (dB).

3.When the peak results are less than average limit, so not need to evaluate the average.



| | | | |
|-------------|-----------------|----------------|-----|
| Standard: | FCC Part 15.407 | Test Distance: | 3 m |
| Test item: | Band edge | | |
| Frequency: | 5530 MHz | | |
| Mode: | Mode 10 | | |
| Ant.Polar.: | Horizontal | | |

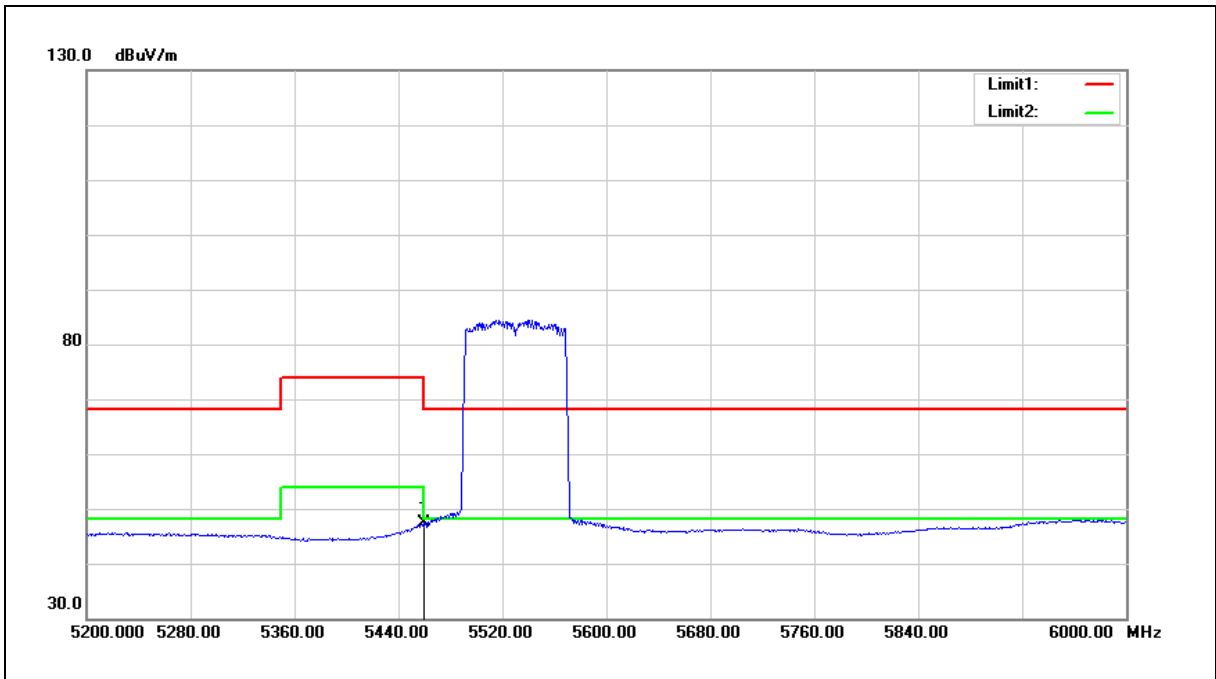

| No. | Frequency (MHz) | Reading (dBuV) | Correct Factor (dB/m) | Result (dBuV/m) | Limit (dBuV/m) | Margin (dB) | Remark |
|-----|-----------------|----------------|-----------------------|-----------------|----------------|-------------|--------|
| 1 | 5460.000 | 42.36 | 4.97 | 47.33 | 54.00 | -6.67 | AVG |

Note:1.Result (dBuV/m) = Correct Factor (dB/m) + Reading(dBuV).

2.Correction factor (dB/m) = Antenna Factor (dB/m) + Cable loss (dB) – Pre-Amplifier gain (dB).

3.When the peak results are less than average limit, so not need to evaluate the average.



| | | | |
|-------------|-----------------|----------------|-----|
| Standard: | FCC Part 15.407 | Test Distance: | 3 m |
| Test item: | Band edge | | |
| Frequency: | 5530 MHz | | |
| Mode: | Mode 10 | | |
| Ant.Polar.: | Vertical | | |

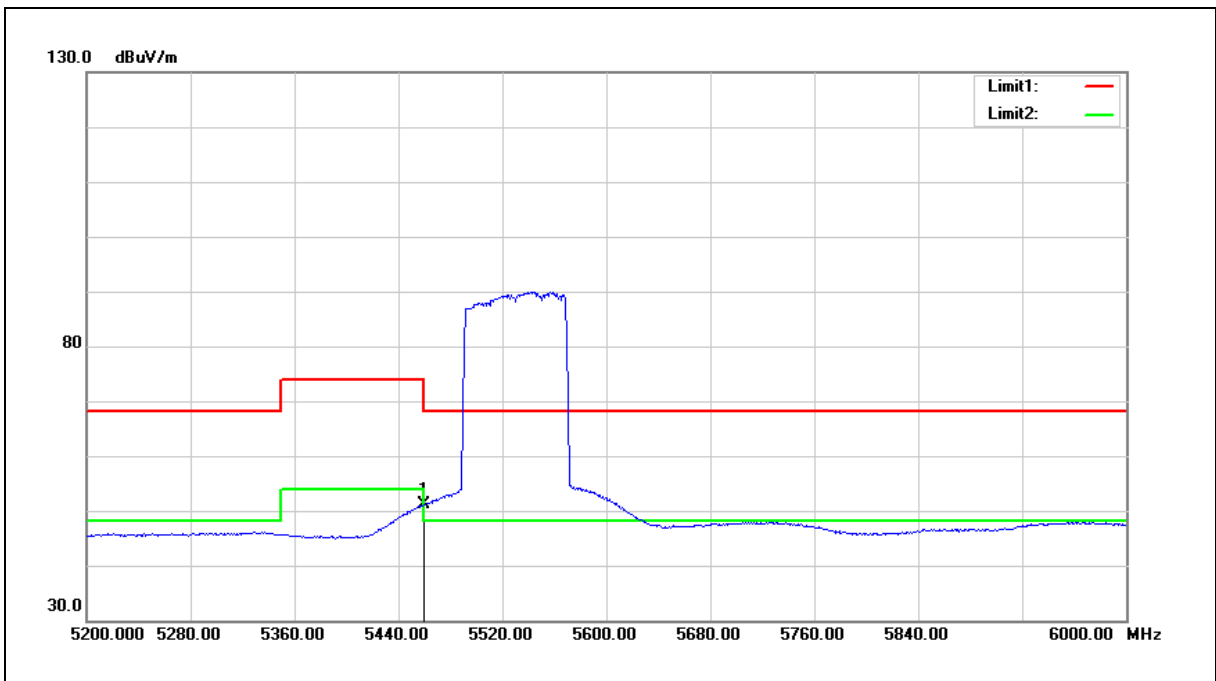

| No. | Frequency (MHz) | Reading (dBuV) | Correct Factor (dB/m) | Result (dBuV/m) | Limit (dBuV/m) | Margin (dB) | Remark |
|-----|-----------------|----------------|-----------------------|-----------------|----------------|-------------|--------|
| 1 | 5460.000 | 46.16 | 4.97 | 51.13 | 54.00 | -2.87 | AVG |

Note:1.Result (dBuV/m) = Correct Factor (dB/m) + Reading(dBuV).

2.Correction factor (dB/m) = Antenna Factor (dB/m) + Cable loss (dB) – Pre-Amplifier gain (dB).

3.When the peak results are less than average limit, so not need to evaluate the average.



| | | | |
|-------------|-----------------|----------------|-----|
| Standard: | FCC Part 15.407 | Test Distance: | 3 m |
| Test item: | Band edge | | |
| Frequency: | 5690 MHz | | |
| Mode: | Mode 10 | | |
| Ant.Polar.: | Horizontal | | |

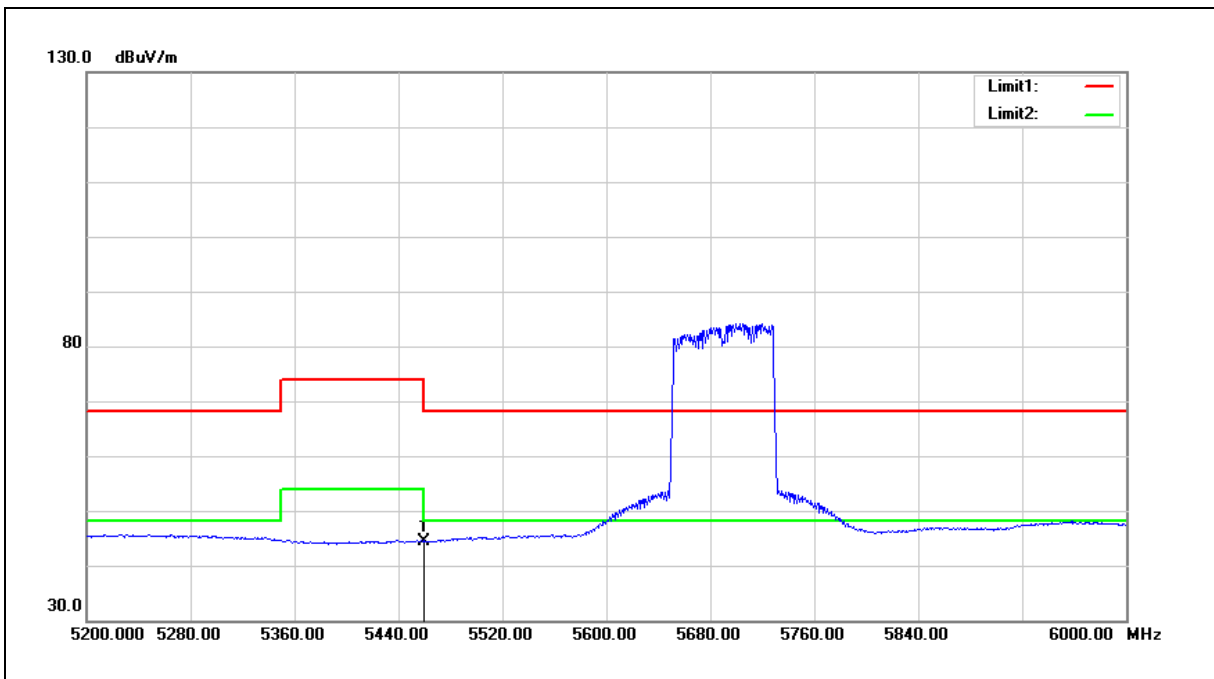

| No. | Frequency (MHz) | Reading (dBuV) | Correct Factor (dB/m) | Result (dBuV/m) | Limit (dBuV/m) | Margin (dB) | Remark |
|-----|-----------------|----------------|-----------------------|-----------------|----------------|-------------|--------|
| 1 | 5460.000 | 39.38 | 4.97 | 44.35 | 54.00 | -9.65 | AVG |

Note:1.Result (dBuV/m) = Correct Factor (dB/m) + Reading(dBuV).

2.Correction factor (dB/m) = Antenna Factor (dB/m) + Cable loss (dB) – Pre-Amplifier gain (dB).

3.When the peak results are less than average limit, so not need to evaluate the average.



| | | | |
|-------------|-----------------|----------------|-----|
| Standard: | FCC Part 15.407 | Test Distance: | 3 m |
| Test item: | Band edge | | |
| Frequency: | 5690 MHz | | |
| Mode: | Mode 10 | | |
| Ant.Polar.: | Vertical | | |

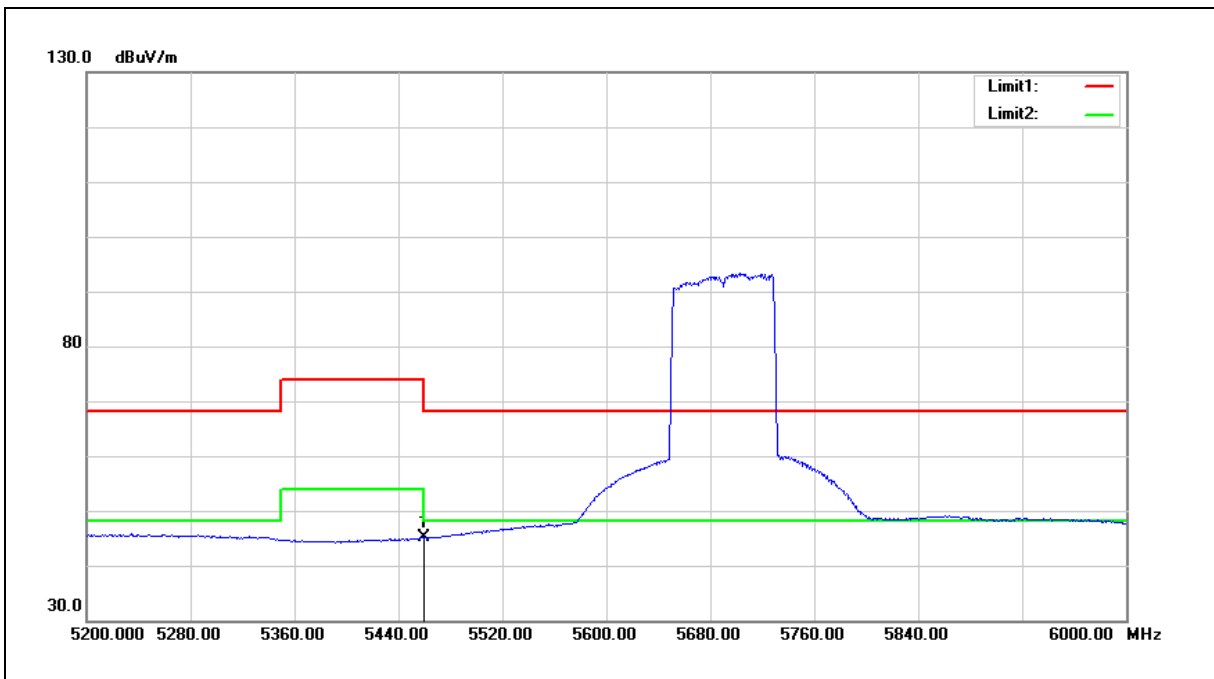

| No. | Frequency (MHz) | Reading (dBuV) | Correct Factor (dB/m) | Result (dBuV/m) | Limit (dBuV/m) | Margin (dB) | Remark |
|-----|-----------------|----------------|-----------------------|-----------------|----------------|-------------|--------|
| 1 | 5460.000 | 40.17 | 4.97 | 45.14 | 54.00 | -8.86 | AVG |

Note:1.Result (dBuV/m) = Correct Factor (dB/m) + Reading(dBuV).

2.Correction factor (dB/m) = Antenna Factor (dB/m) + Cable loss (dB) – Pre-Amplifier gain (dB).

3.When the peak results are less than average limit, so not need to evaluate the average.