

## RF Test Report

Applicant : Askey Computer Corp  
Product Type : Wi-Fi and Bluetooth functionalities module  
Trade Name : ASKEY  
Model Number : STI625X  
Applicable Standard : FCC 47 CFR PART 15 SUBPART C  
ANSI C63.10:2013  
Received Date : Aug. 17, 2021  
Test Period : Aug. 27 ~ Sep. 09, 2021  
Issued Date : Sep. 28, 2021

### Issued by

A Test Lab Techno Corp.  
No. 140-1, Changan Street, Bade District,  
Taoyuan City 33465, Taiwan (R.O.C.)  
Tel : +886-3-2710188 / Fax : +886-3-2710190



Taiwan Accreditation Foundation accreditation number: 1330  
Frequency Range : 9 kHz to 40 GHz  
Test Firm MRA designation number: TW0010

#### Note:

1. The test results are valid only for samples provided by customers and under the test conditions described in this report.
2. This report shall not be reproduced except in full, without the written approval of A Test Lab Technology Corporation.
3. The relevant information is provided by customers in this test report. According to the correctness, appropriateness or completeness of the information provided by the customer, if there is any doubt or error in the information which affects the validity of the test results, the laboratory does not take the responsibility.



### Revision History

Rev.	Issued Date	Revisions	Revised By
00	Sep. 24, 2021	Initial Issue	Tobey Cheng
01	Sep. 28, 2021	Update chapter 1.1 (P.5)	Tobey Cheng

## Verification of Compliance

Applicant : Askey Computer Corp  
Product Type : Wi-Fi and Bluetooth functionalities module  
Trade Name : ASKEY  
Model Number : STI625X  
FCC ID : H8N-STI625X  
EUT Rated Voltage : VBAT DC 3.3 V & VDDIO DC 1.8 V  
Test Voltage : 120 Vac / 60 Hz  
Applicable Standard : FCC 47 CFR PART 15 SUBPART C  
ANSI C63.10:2013  
Test Result : Complied

Performing Lab. : A Test Lab Techno Corp.  
No. 140-1, Changan Street, Bade District,  
Taoyuan City 33465, Taiwan (R.O.C.)  
Tel : +886-3-2710188 / Fax : +886-3-2710190  
Taiwan Accreditation Foundation accreditation number: 1330  
<http://www.atl-lab.com.tw/e-index.htm>



A Test Lab Techno Corp. tested the above equipment in accordance with the requirements set forth in the above standards. All indications of Pass/Fail in this report are opinions expressed by A Test Lab Techno Corp. based on interpretations and/or observations of test results. The test results show that the equipment tested is capable of demonstrating compliance with the requirements as documented in this report.

Approved By : \_\_\_\_\_  
(Kai Yu Yang)



## TABLE OF CONTENTS

<b>1</b>	<b>General Information .....</b>	<b>5</b>
	1.1. Summary of Test Result.....	5
	1.2. Measurement Uncertainty.....	6
<b>2</b>	<b>EUT Description .....</b>	<b>7</b>
<b>3</b>	<b>Test Methodology.....</b>	<b>8</b>
	3.1. Mode of Operation.....	8
	3.2. EUT Test Step.....	8
	3.3. Configuration of Test System Details .....	9
	3.4. Test Instruments .....	10
	3.5. Test Site Environment.....	11
<b>4</b>	<b>Measurement Procedure.....</b>	<b>12</b>
	4.1. Maximum Conducted Output Power Measurement.....	12
	4.2. AC Power Line Conducted Emission Measurement.....	13
	4.3. Radiated Emission Measurement .....	15
	4.4. 20 dB RF Bandwidth Measurement .....	18
	4.5. Carrier Frequency Separation Measurement .....	19
	4.6. Number of Hopping Measurement.....	20
	4.7. Time of Occupancy (Dwell Time) Measurement.....	21
	4.8. Out of Band Conducted Emissions Measurement.....	22
	4.9. Antenna Measurement .....	22
<b>5</b>	<b>Test Results.....</b>	<b>23</b>
	Annex A. Conducted Emission .....	23
	Annex B. Conducted Test Results .....	25
	Annex C. Radiated Emission Measurement .....	44
<b>6</b>	<b>EUT Photos.....</b>	<b>82</b>

# 1 General Information

## 1.1. Summary of Test Result

Standard	Item	Result	Remark
15.207	AC Power Conducted Emission	PASS	----
15.203	Antenna Requirement	PASS	----
15.247(b)(1)	Max. Output Power	PASS	----
15.247(d)	Transmitter Radiated Emissions	PASS	----
15.247(a)(1)	20 dB RF Bandwidth	PASS	----
15.247(a)(1)	Carrier Frequency Separation	PASS	----
15.247(a)(1)(iii)	Number of Hopping	PASS	----
15.247(a)(1)(iii)	Time of Occupancy (Dwell Time)	PASS	----
15.247(d)	Out of Band Conducted Spurious Emission	PASS	----

### Decision Rule

- Uncertainty is not included.
- Uncertainty is included.

Standard	Description
CFR47, Part 15, Subpart C	Intentional Radiators
ANSI C63. 10: 2013	American National Standard of Procedures for Compliance Testing of Unlicensed Wireless Devices
DA 00-705	Filing and Measurement Guidelines for Frequency Hopping Spread Spectrum Systems
KDB 558074 D01 v05r02	The device is designed according to specifications of SIG . So it has a full support to Medium access protocol and fully compliant with the KDB558074 standard. The device is compliant Pseudorandom hopping, Equal hopping frequency, receiver bandwidth synchronize and have same bandwidth with transmitted signal. And the ability to have adaptive hopping when encountering other signals.



## 1.2. Measurement Uncertainty

Test Item	Frequency Range	Uncertainty
Conducted Emission	150 kHz ~ 30 MHz	2.7 dB
Radiated Emission	9 kHz ~ 30 MHz	2.2 dB
	30 MHz ~ 1000 MHz	5.1 dB
	1000 MHz ~ 18000 MHz	5.2 dB
	18000 MHz ~ 26500 MHz	4.6 dB
	26500 MHz ~ 40000 MHz	4.6 dB
Conducted Output Power	1.1 dB	
RF Bandwidth	4.7 %	
Power Spectral Density	1.1 dB	

## 2 EUT Description

Applicant	Askey Computer Corp 10F, No. 119, JIANKANG RD. ZHONGHE DIST, NEW TAIPEI CITY, Taiwan	
Manufacturer	Askey Computer Corp 10F, No. 119, JIANKANG RD. ZHONGHE DIST, NEW TAIPEI CITY, Taiwan	
Product	Wi-Fi and Bluetooth functionalities module	
Trade Name	ASKEY	
Model Number	STI625X	
FCC ID	H8N-STI625X	
Frequency Range	2402 ~ 2480 MHz	
Modulation Type	GFSK for 1 Mbps	
	$\pi/4$ -DQPSK for 2 Mbps	
	8DPSK for 3 Mbps	
Operate Temp. Range	0 ~ 40 °C	
Antenna information	Type	Max. Gain (dBi)
	Dipole Antenna	2.45
Max. RF Output Power	GFSK for 1 Mbps	0.00681 W
	$\pi/4$ -DQPSK for 2 Mbps	0.00979 W
	8DPSK for 3 Mbps	0.00998 W

### 3 Test Methodology

#### 3.1. Mode of Operation

Decision of Test ATL has verified the construction and function in typical operation. All the test modes were carried out with the EUT in normal operation, which was shown in this test report and defined as:

Pre-Test Mode
Mode 1: Transmit mode
Mode 2: GFSK Continuous TX mode
Mode 3: $\pi/4$ -DQPSK Continuous TX mode
Mode 4: 8DPSK Continuous TX mode

After verification, all tests were carried out with the worst case test modes.

By preliminary testing and verifying three axis (X, Y and Z) position of EUT transmitted status, it was found that "Z axis" position was the worst, then the final test was executed the worst condition and test data were recorded in this report.

Final-Test Mode
Mode 1: Transmit mode
Mode 2: GFSK Continuous TX mode
Mode 4: 8DPSK Continuous TX mode

Description of Test Modes

Preliminary tests were performed in different modulation to find the worst case. The modulation has shown the worst-case in section 4.5. Investigation has been done on all the possible configurations for searching the worst cases.

#### 3.2. EUT Test Step

1	Setup the EUT shown on "Configuration of Test System Details."
2	Turn on the power of all equipment.
3	Turn on TX function
4	EUT run test program.

Measurement Software			
No.	Description	Software	Version
1	Conducted Emission	EZ EMC	1.1.4.3
2	Radiated Emission	EZ EMC	1.1.4.4



### 3.3. Configuration of Test System Details

#### Conducted Emission

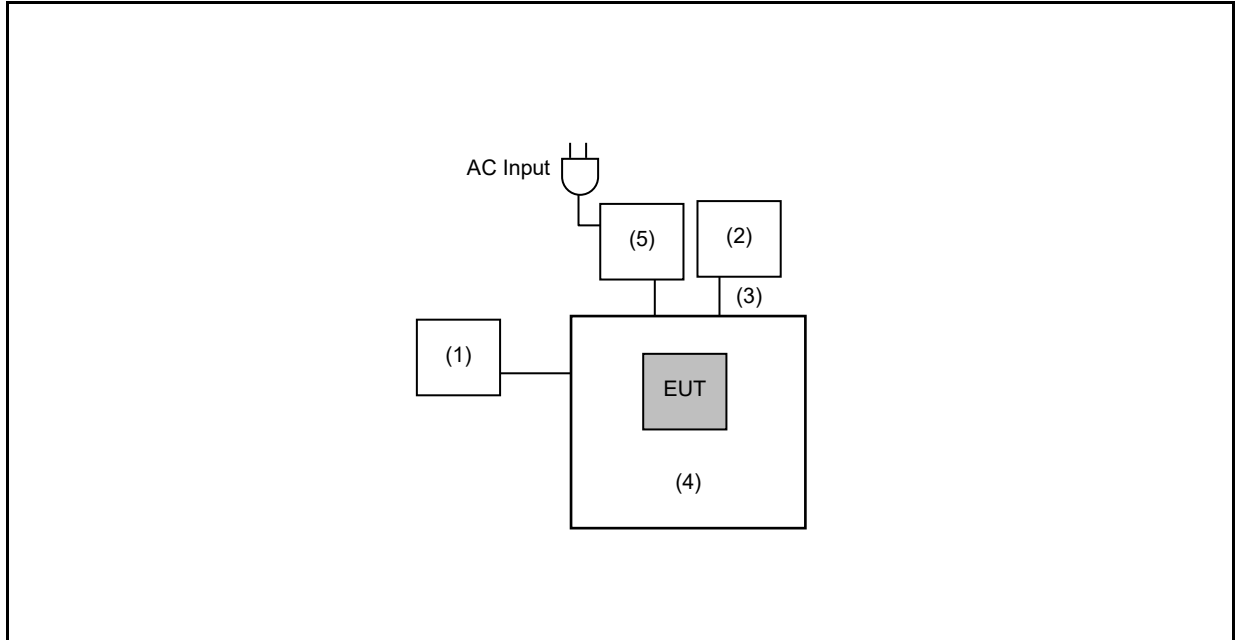

#### Radiated Emissions

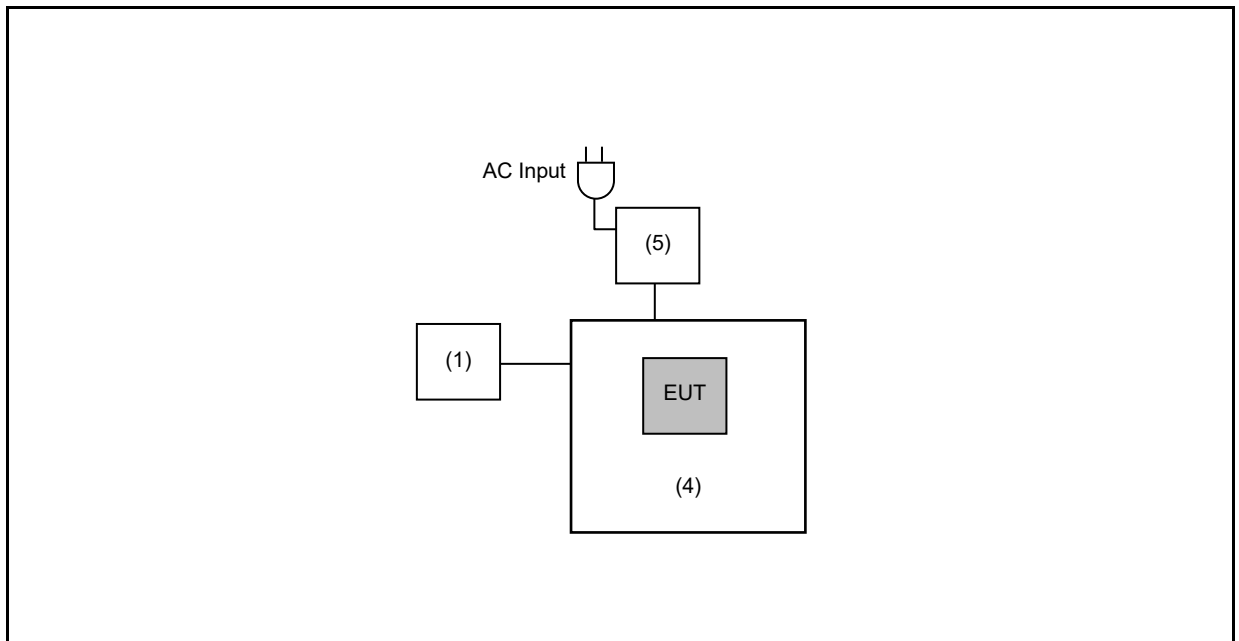



Devices Description					
	Product	Manufacturer	Model Number	Serial Number	Power Cord
(1)	Notebook	acer	N19C1	NXEG8TA008109033BD3400	---
(2)	LCD Monitor	ViewSonic	VS16861	UZJ195120842	---
(3)	HDMI Cable	Avier	K48GHS	---	---
(4)	Fixture	Askey	STI625x	---	---
(5)	AC Adapter	Delta	ADP-90WH KBA	---	---

### 3.4. Test Instruments

For Conducted Emission

Test Period: Sep. 09, 2021

Testing Engineer: Andy Lu

Equipment	Manufacturer	Model Number	Serial Number	Cal. Date	Cal. Period
Test Receiver	R&S	ESCI	100367	05/21/2021	1 year
LISN	R&S	ENV216	101040	03/29/2021	1 year
LISN	R&S	ENV216	101041	04/08/2021	1 year
RF Cable	Woken	00100D1380194M	TE-02-03	05/28/2021	1 year

Note: N.C.R. = No Calibration Request.



For Radiated Emissions

Test Period: Aug. 27 ~ Sep. 07, 2021

Testing Engineer: Hung Chou, Marc Yeh, Eva Lee

Equipment	Manufacturer	Model Number	Serial Number	Cal. Date	Cal. Period
Spectrum Analyzer (2 Hz~50 GHz)	Keysight	N9030B	MY57143537	04/19/2021	1 year
Pre Amplifier (100 kHz~1.3 GHz)	Agilent	8447D	2944A11119	01/15/2021	1 year
Pre Amplifier (1~26.5 GHz)	Agilent	8449B	3008A02237	10/21/2020	1 year
Broadband Antenna	Schwarzbeck	VULB9168	01146	07/19/2021	1 year
Horn Antenna (1~18 GHz)	SCHWARZBECK MESS-ELEKTRONIK	BBHA9120D	02207	07/09/2021	1 year
Horn Antenna (18~40 GHz)	ETS	3116	00086467	12/03/2020	1 year
Coaxial Cable	Titan	T0710AT327A10A 100	J11005	08/06/2021	1 year
Coaxial Cable	Titan	T0710AT327A10A 900	J11004	08/06/2021	1 year
Coaxial Cable	Titan	T0712AT340A12A 900	J11002	08/06/2021	1 year

For Conducted

Test Period: Aug. 27 ~ Sep. 07, 2021

Testing Engineer: Brian Lin, Andy Lu

Equipment	Manufacturer	Model Number	Serial Number	Cal. Date	Cal. Period
Power Sensor	Anritsu	MA2411B	1126022	09/01/2020 09/03/2021	1 year
Power Meter	Anritsu	ML2495A	1135009	09/01/2020 09/03/2021	1 year
Spectrum Analyzer	Keysight	N9010B	MY59071418	03/17/2021	1 year

Note: N.C.R. = No Calibration Request.

### 3.5. Test Site Environment

Items	Required (IEC 60068-1)	Actual
Temperature (°C)	15-35	20-30
Humidity (%RH)	25-75	45-75

## 4 Measurement Procedure

### 4.1. Maximum Conducted Output Power Measurement

#### ■ Limit

For frequency hopping systems operating in the 2400–2483.5 MHz band employing at least 75 non-overlapping hopping channels < 0.125 watt.

#### ■ Test Setup

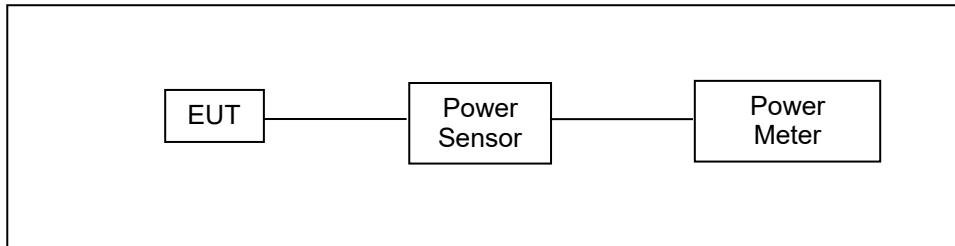

#### ■ Test Procedure

Testing must be done according to this procedure, FCC Public Notice DA 00-705 - Filing and Measurement Guidelines for Frequency Hopping Spread Spectrum Systems. This is the only method recognized by the FCC. The tests below are run with the EUT's transmitter set at high power in TX mode. The EUT is needed to force selection of output power level and channel number. While testing, EUT was set to transmit continuously. Remove the Subjective device's antenna and connect the RF output port to power sensor. The maximum peak output power shall not exceed 1 watt.

Use a direct connection between the antenna port of transmitter and the power sensor, for prevent the power sensor input attenuation 40-50 dB. Set the RBW Bandwidth of the emission or use a channel power meter mode. For antennas with gains of 6 dBi or less, maximum allowed transmitter output is 1 watt (+30 dBm). For antennas with gains greater than 6 dBi, transmitter output level must be decreased by an amount equal to  $(\text{GAIN} - 6)/3$  dBm. The antenna port of the EUT was connected to the input of a power sensor. Power was read directly and cable loss correction was added to the reading to obtain power at the EUT antenna terminals.

## 4.2. AC Power Line Conducted Emission Measurement

### ■ Limit

Frequency (MHz)	Quasi-peak	Average
0.15 - 0.5	66 to 56	56 to 46
0.50 - 5.0	56	46
5.0 - 30.0	60	50

### ■ Test Setup

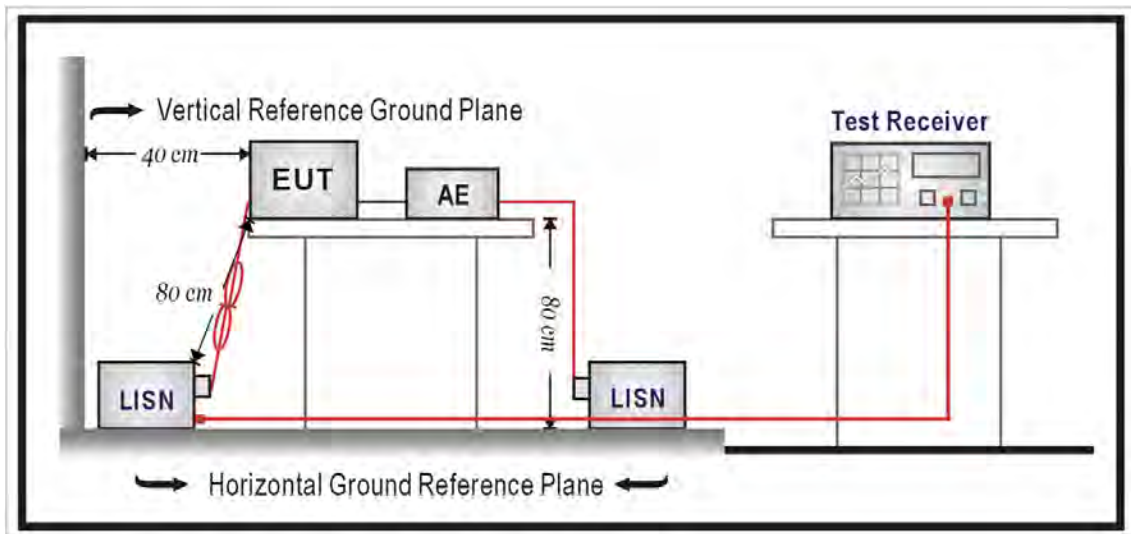

### ■ Test Procedure

The EUT and simulators are connected to the main power through a line impedance stabilization network (L.I.S.N.). This provides a  $50 \Omega // 50 \mu\text{H}$  coupling impedance for the measuring equipment. The peripheral devices are also connected to the main power through a LISN that provides a  $50 \Omega // 50 \mu\text{H}$  coupling impedance with 50 ohm termination.

Tabletop device shall be placed on a non-conducting platform, of nominal size 1 m by 1.5 m, raised 80 cm above the reference ground plane. The wall of screened room shall be located 40 cm to the rear of the EUT. Other surfaces of tabletop or floor standing EUT shall be at least 80 cm from any other ground conducting surface including one or more LISNs. For floor-standing device shall be placed under the EUT with a 12 mm insulating material.

Conducted emissions were investigated over the frequency range from 0.15 MHz to 30 MHz using a resolution bandwidth of 9 kHz. The equipment under test (EUT) shall be meet the limits in section 4.1, as applicable, including the average limit and the quasi-peak limit when using respectively, an average detector and quasi-peak detector measured in accordance with the methods described of related standard. When all of peak value were complied with quasi-peak and average limit from 150 kHz to 30 MHz then quasi-peak and average measurement was unnecessary.

The AMN shall be placed 0.8 m from the boundary of the unit under test and bonded to a ground reference plane for AMNs mounted on top of the ground reference plane. This distance is between the closest points of the AMN and the EUT. All other units of the EUT and associated equipment shall be at least 0.8 m from the AMN. If the mains power cable is longer than 1 m then the cable shall be folded back and forth at the centre of the lead to form a bundle no longer than 0.4 m. All of interconnecting cables that hang closer than 40 cm to the ground plane shall be folded back and forth in the center forming a bundle 30 cm to 40 cm long. All of EUT and AE shall be separate place more than 0.1 m. All  $50 \Omega$  ports of the LISN shall be resistively terminated into  $50 \Omega$  loads when not connected to the measuring instrument.

If the reading of the measuring receiver shows fluctuations close to the limit, the reading shall be observed for at least 15 s at each measurement frequency; the higher reading shall be recorded with the exception of any brief isolated high reading which shall be ignored.

### 4.3. Radiated Emission Measurement

■ **Limit**

According to §15.209(a), except as provided elsewhere in this subpart, the emissions from an intentional radiator shall not exceed the field strength levels specified in the following table:

Frequency (MHz)	Field Strength ( $\mu\text{V}/\text{m}$ at meter)	Measurement Distance (meters)
0.009 – 0.490	2400 / F (kHz)	300
0.490 – 1.705	24000 / F (kHz)	30
1.705 – 30.0	30	30
30 - 88	100**	3
88-216	150**	3
216-960	200**	3
Above 960	500	3

\*\* Except as provided in paragraph (g), fundamental emissions from intentional radiators operating under this Section shall not be located in the frequency bands 54-72 MHz, 76-88 MHz, 174-216 MHz or 470-806 MHz. However, operation within these frequency bands is permitted under other sections of this Part, e.g., Sections 15.231 and 15.241.

■ **Setup**

9 kHz ~ 30 MHz

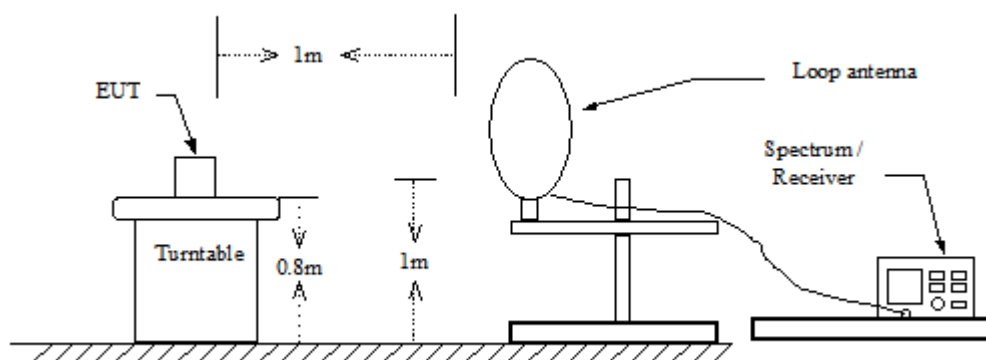

Below 1 GHz

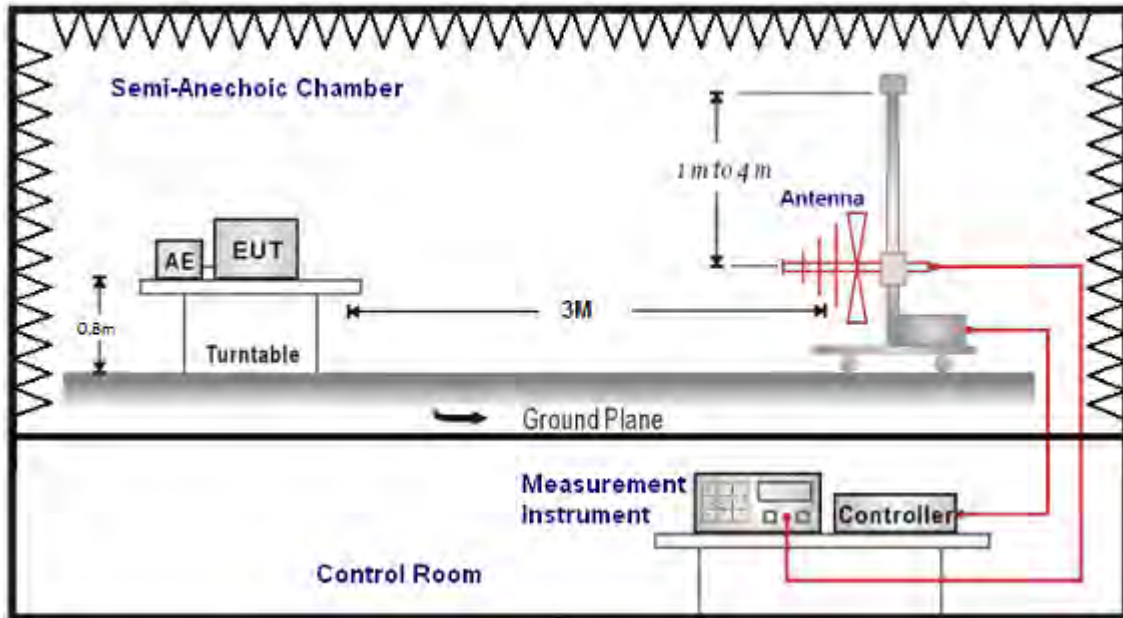

Above 1 GHz

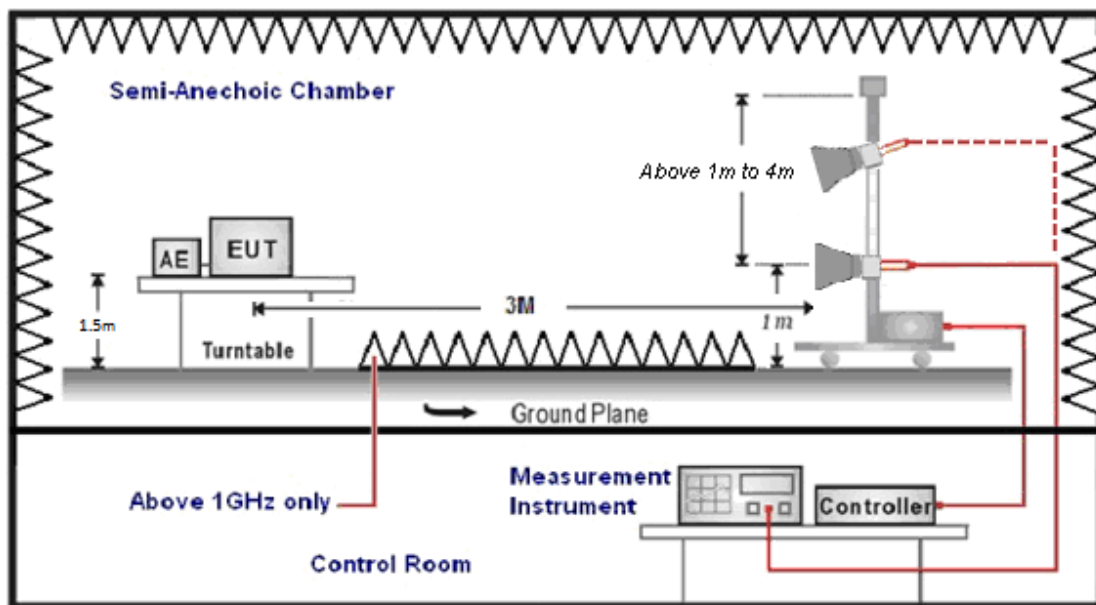



## ■ Test Procedure

Final radiation measurements were made on a three-meter, Semi Anechoic Chamber. The EUT system was placed on a nonconductive turntable which is 0.8 or 1.5 meters height, top surface 1.0 x 1.5 meter. The spectrum was examined from 250 MHz to 2.5 GHz in order to cover the whole spectrum below 10th harmonic which could generate from the EUT. During the test, EUT was set to transmit continuously & Measurements spectrum range from 9 kHz to 26.5 GHz is investigated.

For measurements below 1 GHz the resolution bandwidth is set to 100 kHz for peak detection measurements or 120 kHz for quasi-peak detection measurements. Peak detection is used unless otherwise noted as quasi-peak.

For measurements above 1 GHz the resolution bandwidth is set to 1 MHz, and then the video bandwidth is set to 3 MHz for peak measurements and 10 Hz for average measurements when Duty cycle >98 % / 1/T for average measurements when Duty cycle <98 %. A nonconductive material surrounded the EUT to supporting the EUT for standing on three orthogonal planes. At each condition, the EUT was rotated 360 degrees, and the antenna was raised and lowered from one to four meters to find the maximum emission levels. Measurements were taken using both horizontal and vertical antenna polarization.

SCHWARZBECK MESS-ELEKTRONIK Biconilog Antenna at 3 Meter and the SCHWARZBECK Double Ridged Guide Antenna was used in frequencies 1 – 26.5 GHz at a distance of 1 meter. All test results were extrapolated to equivalent signal at 3 meters utilizing an inverse linear distance extrapolation Factor (20 dB/decade).

For testing above 1 GHz, the emission level of the EUT in peak mode was 20 dB lower than average limit (that means the emission level in peak mode also complies with the limit in average mode), then testing will be stopped and peak values of EUT will be reported, otherwise, the emissions will be measured in average mode again and reported.

Appropriate preamplifiers were used for improving sensitivity and precautions were taken to avoid overloading or desensitizing the spectrum analyzer. No post – detector video filters were used in the test.

The spectrum analyzer's 6 dB bandwidth was set to 1 MHz, and the analyzer was operated in the peak detection mode, for frequencies both below and up 1 GHz. The average levels were obtained by subtracting the duty cycle correction factor from the peak readings.

The following procedures were used to convert the emission levels measured in decibels referenced to 1 microvolt (dBuV) into field intensity in micro volts per meter (uV/m).

The actual field intensity in decibels referenced to 1 microvolt in to field intensity in micro volts per meter (dBuV/m).

The actual field intensity in referenced to 1 microvolt per meter (dBuV/m) is determined by algebraically adding the measured reading in dBuV, the antenna factor (dB), and cable loss (dB) and Subtracting the gain of preamplifier (dB) is auto calculate in spectrum analyzer.

$$(1) \text{ Amplitude (dBuV/m) = FI (dBuV) +AF (dBuV) +CL (dBuV)-Gain (dB)}$$

FI= Reading of the field intensity.

AF= Antenna factor.

CL= Cable loss.

P.S Amplitude is auto calculate in spectrum analyzer.

$$(2) \text{ Actual Amplitude (dBuV/m) = Amplitude (dBuV)-Dis(dB)}$$

The FCC specified emission limits were calculated according the EUT operating frequency and by following linear interpolation equations:

(a) For fundamental frequency : Transmitter Output < +30 dBm

(b) For spurious frequency : Spurious emission limits = fundamental emission limit /10

Data of measurement within this frequency range without mark in the table above means the reading of emissions are attenuated more than 20 dB below the permissible limits or the field strength is too small to be measured.

#### 4.4. 20 dB RF Bandwidth Measurement

■ **Limit**

N/A

■ **Test Setup**

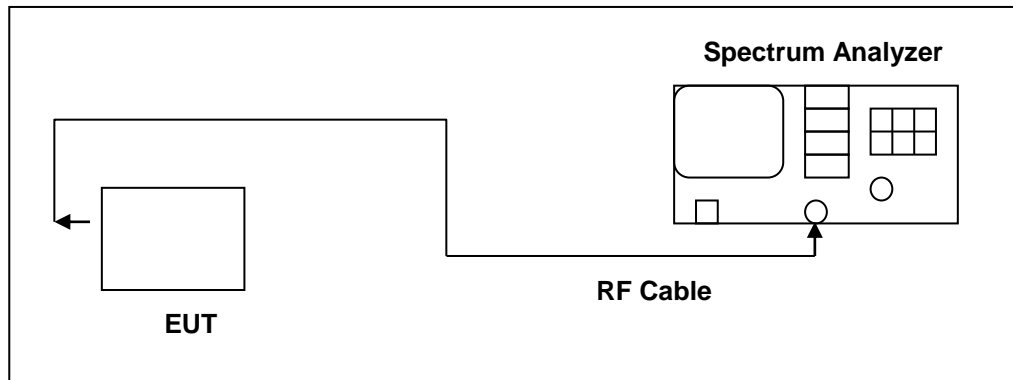

■ **Test Procedure**

Testing must be done according to this procedure, FCC Public Notice DA 00-705 - Filing and Measurement Guidelines for Frequency Hopping Spread Spectrum Systems. This is the only method recognized by the FCC. The RF output port of the Equipment-Under-Test is directly coupled to the input of the EMC analyzer through a specialized RF connector and a 10 dB passive attenuator. A fully charged battery was used for the supply voltage. The Bluetooth frequency hopping function of the EUT was enabled. The spectrum analyzer used the following settings:

1. Span = approx. 2 to 3 times the 20 dB bandwidth, centered on a hopping frequency
2. RBW  $\geq$  1 % of the 20 dB span
3. VBW  $\geq$  RBW
4. Sweep = auto
5. Detector function = peak
6. Trace = max hold

The trace was allowed to stabilize. The EUT was transmitting at its maximum data rate. The marker-to-peak function was used to set the marker to the peak of the emission. The marker-delta function was used to measure 20 dB down one side of the emission. The marker-delta function and marker was moved to the other side of the emission until it was even with the reference marker. The marker-delta reading at this point was the 20 dB bandwidth of the emission.

## 4.5. Carrier Frequency Separation Measurement

### ■ Limit

Title 47 of the CFR, Part 15 Subpart (c) 15.247(a)(1) requires the measurement of the bandwidth of the transmission between the -20 dB points on the transmitted spectrum. The results of this test determine the limits for channel spacing. The channel spacing shall be a minimum of 25 kHz or the 20 dB bandwidth, whichever is greater. Alternatively, frequency hopping systems operating in the 2400-2483.5 MHz band may have hopping channel carrier frequencies that are separated by 25 kHz or two-thirds of the 20 dB bandwidth of the hopping channel.

### ■ Test Setup

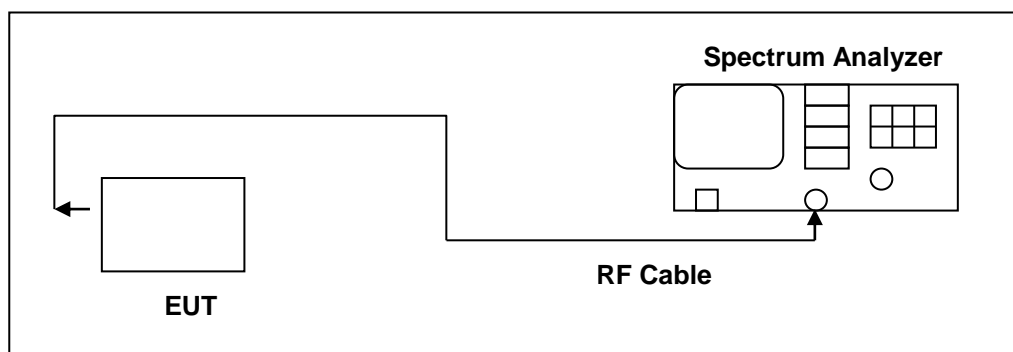

### ■ Test Procedure

Testing must be done according to this procedure, FCC Public Notice DA 00-705 - Filing and Measurement Guidelines for Frequency Hopping Spread Spectrum Systems. This is the only method recognized by the FCC. The RF output port of the Equipment-Under-Test is directly coupled to the input of the EMC analyzer through a specialized RF connector and a 10 dB passive attenuator. A fully charged battery was used for the supply voltage. The Bluetooth frequency hopping function of the EUT was enabled. The following spectrum analyzer settings were used:

1. Span = wide enough to capture the peaks of two adjacent channels
2. Resolution (or IF) Bandwidth (RBW)  $\geq 1\%$  of the span
3. Video (or Average) Bandwidth (VBW)  $\geq$  RBW
4. Sweep = auto
5. Detector function = peak
6. Trace = max hold

The trace was allowed to stabilize. The marker-delta function was used to determine the separation between the peaks of the adjacent channels.

#### 4.6. Number of Hopping Measurement

■ **Limit**

Frequency hopping systems in the 2400–2483.5 MHz band shall use at least 15 channels.

■ **Test Setup**

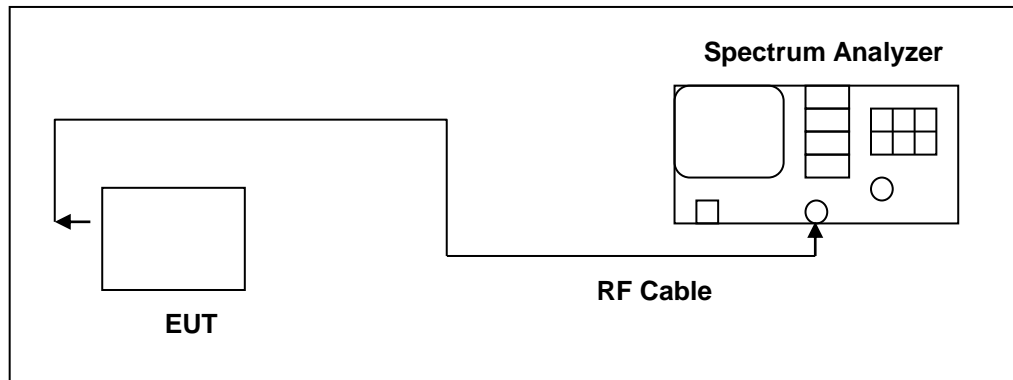

■ **Test Procedure**

Testing must be done according to this procedure, FCC Public Notice DA 00-705 - Filing and Measurement Guidelines for Frequency Hopping Spread Spectrum Systems. This is the only method recognized by the FCC. The RF output port of the Equipment-Under-Test is directly coupled to the input of the EMC analyzer through a specialized RF connector and a 10 dB passive attenuator. A fully charged battery was used for the supply voltage. The Bluetooth frequency hopping function of the EUT was enabled. The spectrum analyzer used the following settings:

1. Span = the frequency band of operation
2. RBW  $\geq$  1 % of the span
3. VBW  $\geq$  RBW
4. Sweep = auto
5. Detector function = peak
6. Trace = max hold

The trace was allowed to stabilize.

## 4.7. Time of Occupancy (Dwell Time) Measurement

### ■ Limit

The average time of occupancy on any channel shall not be greater than 0.4 seconds within a period of 0.4 seconds multiplied by the number of hopping channels employed.

### ■ Test Setup

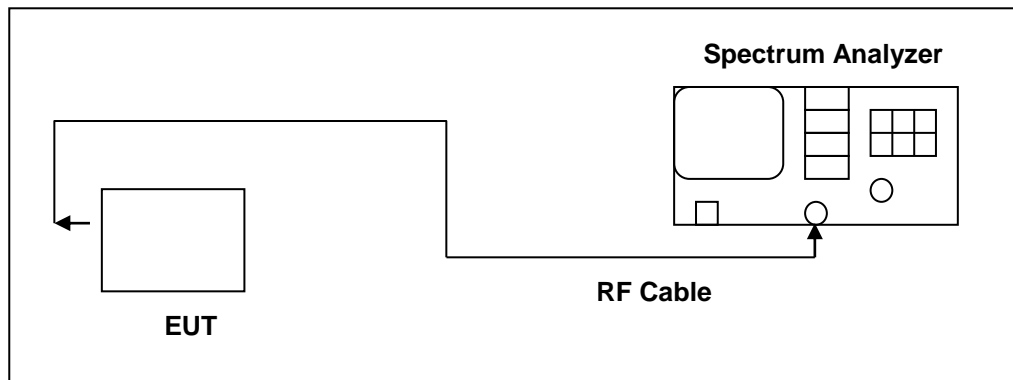

### ■ Test Procedure

Testing must be done according to this procedure, FCC Public Notice DA 00-705 - Filing and Measurement Guidelines for Frequency Hopping Spread Spectrum Systems. This is the only method recognized by the FCC. The RF output port of the Equipment-Under-Test is directly coupled to the input of the spectrum through a specialized RF connector and a 10 dB passive attenuator. A fully charged battery was used for the supply voltage. The Bluetooth hopping function of the EUT was enabled. The following spectrum analyzer settings were used:

1. Span = zero span, centered on a hopping channel
2. RBW = 1 MHz
3. VBW  $\geq$  RBW
4. Sweep = as necessary to capture the entire dwell time per hopping channel
5. Detector function = peak
6. Trace = max hold

The marker-delta function was used to determine the dwell time.

## 4.8. Out of Band Conducted Emissions Measurement

### ■ Limit

In any 100 kHz bandwidth outside the frequency band in which the spread spectrum or digitally modulated intentional radiator is operating, the radio frequency power that is produced by the intentional radiator shall be at least 20 dB below that in the 100 kHz bandwidth within the band that contains the highest level of the desired power

### ■ Test Setup

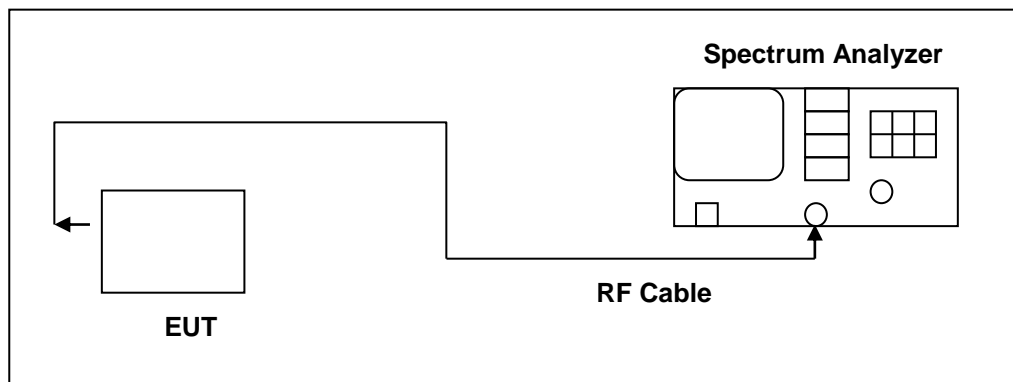

### ■ Test Procedure

Testing must be done according to this procedure, FCC Public Notice DA 00-705 - Filing and Measurement Guidelines for Frequency Hopping Spread Spectrum Systems. This is the only method recognized by the FCC. In any 100 kHz bandwidth outside the EUT pass band, the RF power produced by the modulation products of the spreading sequence, the information sequence, and the carrier frequency shall be at least 20 dB below that of the maximum in-band 100 kHz emission, antenna output of the EUT was coupled directly to spectrum analyzer; if an external attenuator and/or cable was used, these losses are compensated for with the analyzer OFFSET function. All other types of emissions from the EUT shall meet the general limits for radiated frequencies outside the pass band. The test was performed at 3 channels (Channel 0, 39, 78)

## 4.9. Antenna Measurement

### ■ Limit

For intentional device, according to 15.203, an intentional radiator shall be designed to ensure that no antenna other than that furnished by the responsible party shall be used with the device.

And According to 15.247 (b)(4), if transmitting antennas of directional gain greater than 6 dBi are used, the power shall be reduced by the amount in dB that the directional gain of the antenna exceeds 6 dBi.

### ■ Antenna Connector Construction

See section 2 – antenna information.

## 5 Test Results

### Annex A. Conducted Emission

Standard:	FCC Part 15.247	Line:	L1
Test item:	Conducted Emission	Power:	AC 120 V/60 Hz
Mode:	Mode 1		
Description:			

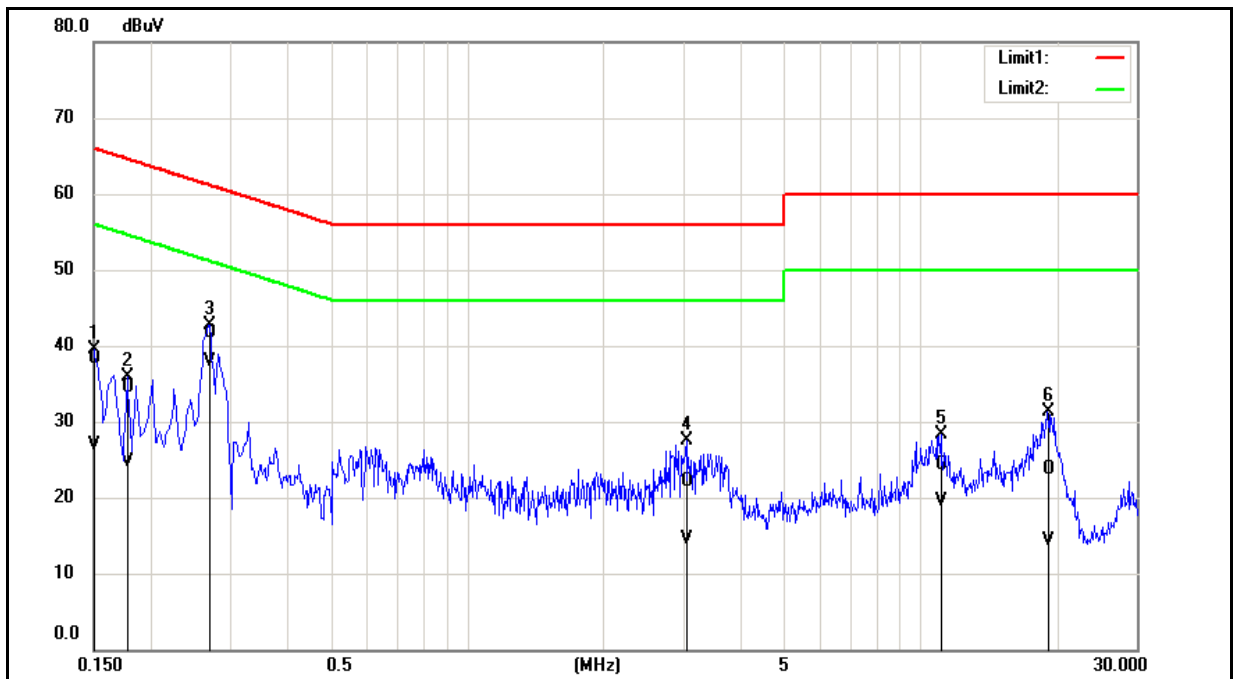

No.	Frequency (MHz)	QP reading (dBuV)	AVG reading (dBuV)	Correction factor (dB)	QP result (dBuV)	AVG result (dBuV)	QP limit (dBuV)	AVG limit (dBuV)	QP margin (dB)	AVG margin (dB)	Remark
1	0.1500	28.58	17.07	9.74	38.32	26.81	66.00	56.00	-27.68	-29.19	Pass
2	0.1780	24.73	15.02	9.74	34.47	24.76	64.58	54.58	-30.11	-29.82	Pass
3	0.2700	31.94	28.12	9.74	41.68	37.86	61.12	51.12	-19.44	-13.26	Pass
4	3.0460	12.32	4.64	9.83	22.15	14.47	56.00	46.00	-33.85	-31.53	Pass
5	11.1340	14.32	9.50	9.98	24.30	19.48	60.00	50.00	-35.70	-30.52	Pass
6	19.0500	13.57	4.32	10.04	23.61	14.36	60.00	50.00	-36.39	-35.64	Pass

Note: 1. Result (dBuV) = Correction factor (dB) + Reading(dBuV).

2. Correction factor (dB) = Cable loss (dB) + L.I.S.N. factor (dB).



Standard:	FCC Part 15.247	Line:	N
Test item:	Conducted Emission	Power:	AC 120 V/60 Hz
Mode:	Mode 1		
Description:			

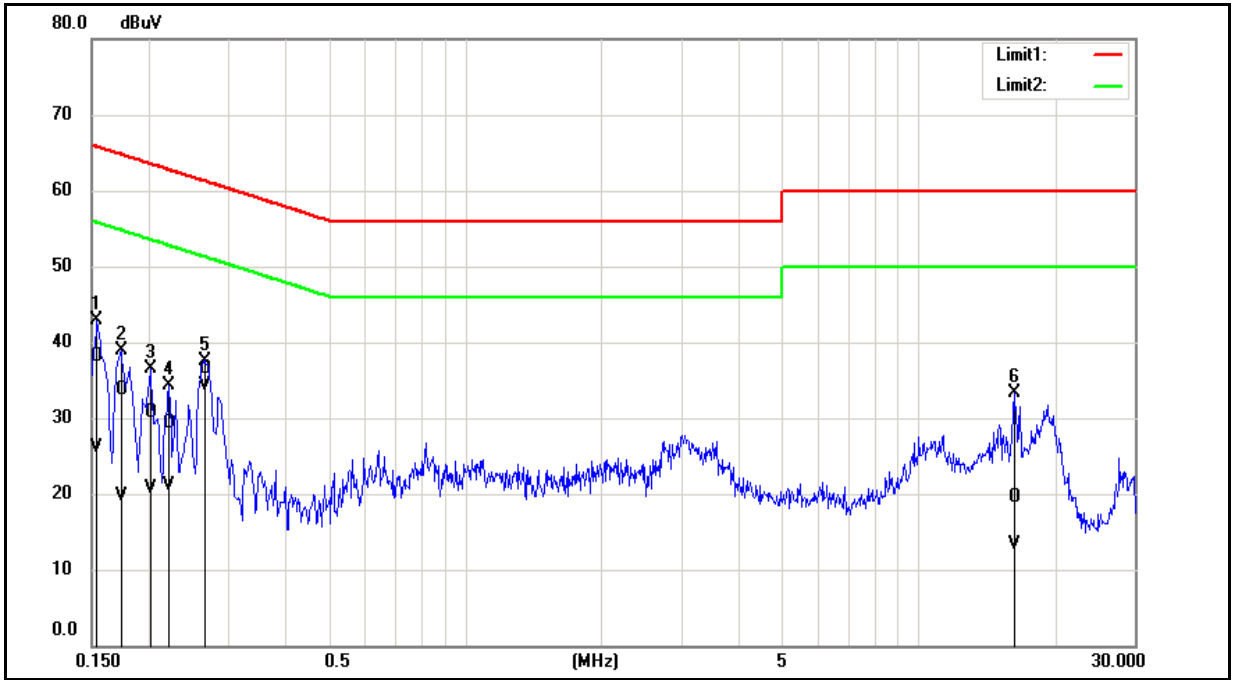

No.	Frequency (MHz)	QP reading (dBuV)	AVG reading (dBuV)	Correction factor (dB)	QP result (dBuV)	AVG result (dBuV)	QP limit (dBuV)	AVG limit (dBuV)	QP margin (dB)	AVG margin (dB)	Remark
1	0.1540	28.29	16.28	9.74	38.03	26.02	65.78	55.78	-27.75	-29.76	Pass
2	0.1740	23.89	9.89	9.74	33.63	19.63	64.77	54.77	-31.14	-35.14	Pass
3	0.2020	21.03	10.90	9.73	30.76	20.63	63.53	53.53	-32.77	-32.90	Pass
4	0.2220	19.63	11.42	9.73	29.36	21.15	62.74	52.74	-33.38	-31.59	Pass
5	0.2660	26.69	24.51	9.73	36.42	34.24	61.24	51.24	-24.82	-17.00	Pass
6	16.2260	9.32	3.26	10.13	19.45	13.39	60.00	50.00	-40.55	-36.61	Pass

Note: 1. Result (dBuV) = Correction factor (dB) + Reading(dBuV).  
2. Correction factor (dB) = Cable loss (dB) + L.I.S.N. factor (dB).





## Annex B. Conducted Test Results

### Maximum Conducted Output Power Measurement

Test Mode	Frequency (MHz)	Packet Type	RF Power setting in Test Software	Test Software Version
Mode 2	2402	DH1	Default	Ampak RFTestTool ver:7.1
		DH3	Default	
		DH5	Default	
	2441	DH1	Default	
		DH3	Default	
		DH5	Default	
	2480	DH1	Default	
		DH3	Default	
		DH5	Default	
Mode 3	2402	2DH1	Default	
		2DH3	Default	
		2DH5	Default	
	2441	2DH1	Default	
		2DH3	Default	
		2DH5	Default	
	2480	2DH1	Default	
		2DH3	Default	
		2DH5	Default	
Mode 4	2402	3DH1	Default	
		3DH3	Default	
		3DH5	Default	
	2441	3DH1	Default	
		3DH3	Default	
		3DH5	Default	
	2480	3DH1	Default	
		3DH3	Default	
		3DH5	Default	

Test Mode	Frequency (MHz)	Packet Type	Average Power		Peak Power		Limit (W)
			(dBm)	(W)	(dBm)	(W)	
Mode 2	2402	DH1	7.29	0.00536	7.75	0.00596	≤ 0.125
		DH3	7.33	0.00541	7.80	0.00603	≤ 0.125
		DH5	7.47	0.00558	7.89	0.00615	≤ 0.125
	2441	DH1	7.87	0.00612	8.09	0.00644	≤ 0.125
		DH3	7.90	0.00617	8.10	0.00646	≤ 0.125
		DH5	8.03	0.00635	8.23	0.00665	≤ 0.125
	2480	DH1	8.11	0.00647	8.30	0.00676	≤ 0.125
		DH3	8.13	0.00650	8.31	0.00678	≤ 0.125
		DH5	8.16	0.00655	<b>8.33</b>	<b>0.00681</b>	≤ 0.125
Mode 3	2402	2DH1	6.25	0.00422	8.81	0.00760	≤ 0.125
		2DH3	6.28	0.00425	8.97	0.00789	≤ 0.125
		2DH5	6.31	0.00428	9.02	0.00798	≤ 0.125
	2441	2DH1	6.61	0.00458	9.09	0.00811	≤ 0.125
		2DH3	6.69	0.00467	9.11	0.00815	≤ 0.125
		2DH5	6.70	0.00468	9.20	0.00832	≤ 0.125
	2480	2DH1	7.15	0.00519	9.71	0.00935	≤ 0.125
		2DH3	7.19	0.00524	9.77	0.00948	≤ 0.125
		2DH5	7.21	0.00526	<b>9.91</b>	<b>0.00979</b>	≤ 0.125
Mode 4	2402	3DH1	6.27	0.00424	8.89	0.00774	≤ 0.125
		3DH3	6.30	0.00427	9.06	0.00805	≤ 0.125
		3DH5	6.36	0.00433	9.11	0.00815	≤ 0.125
	2441	3DH1	6.63	0.00460	9.39	0.00869	≤ 0.125
		3DH3	6.70	0.00468	9.41	0.00873	≤ 0.125
		3DH5	6.71	0.00469	9.50	0.00891	≤ 0.125
	2480	3DH1	7.26	0.00532	9.90	0.00977	≤ 0.125
		3DH3	7.29	0.00536	9.95	0.00989	≤ 0.125
		3DH5	7.32	0.00540	<b>9.99</b>	<b>0.00998</b>	≤ 0.125

Note: The relevant measured result has the offset with cable loss already.



**20 dB RF Bandwidth Measurement**

Test Mode	Frequency (MHz)	Measurement Results (MHz)
Mode 2	2402	0.980
	2441	0.979
	2480	0.982
Mode 4	2402	1.310
	2441	1.312
	2480	1.311

■ Test Graphs

Mode 2: GFSK Continuous TX mode													
2402 MHz	<p>Center Frequency: 2.40200000 GHz Span: 3.0000 MHz CF Step: 300.000 kHz #Res BW: 30.000 kHz #Video BW: 100.00 kHz Sweep: 3.20 ms (1001 pts)</p> <table border="1"> <tr> <td>Occupied Bandwidth</td> <td>888.26 kHz</td> <td>Total Power</td> <td>15.7 dBm</td> </tr> <tr> <td>Transmit Freq Error</td> <td>-8.239 kHz</td> <td>% of OBW Power</td> <td>99.00 %</td> </tr> <tr> <td>x dB Bandwidth</td> <td>980.1 kHz</td> <td>x dB</td> <td>-20.00 dB</td> </tr> </table>	Occupied Bandwidth	888.26 kHz	Total Power	15.7 dBm	Transmit Freq Error	-8.239 kHz	% of OBW Power	99.00 %	x dB Bandwidth	980.1 kHz	x dB	-20.00 dB
Occupied Bandwidth	888.26 kHz	Total Power	15.7 dBm										
Transmit Freq Error	-8.239 kHz	% of OBW Power	99.00 %										
x dB Bandwidth	980.1 kHz	x dB	-20.00 dB										
2441 MHz	<p>Center Frequency: 2.44100000 GHz Span: 3.0000 MHz CF Step: 300.000 kHz #Res BW: 30.000 kHz #Video BW: 100.00 kHz Sweep: 3.20 ms (1001 pts)</p> <table border="1"> <tr> <td>Occupied Bandwidth</td> <td>889.29 kHz</td> <td>Total Power</td> <td>16.3 dBm</td> </tr> <tr> <td>Transmit Freq Error</td> <td>-14.679 kHz</td> <td>% of OBW Power</td> <td>99.00 %</td> </tr> <tr> <td>x dB Bandwidth</td> <td>979.0 kHz</td> <td>x dB</td> <td>-20.00 dB</td> </tr> </table>	Occupied Bandwidth	889.29 kHz	Total Power	16.3 dBm	Transmit Freq Error	-14.679 kHz	% of OBW Power	99.00 %	x dB Bandwidth	979.0 kHz	x dB	-20.00 dB
Occupied Bandwidth	889.29 kHz	Total Power	16.3 dBm										
Transmit Freq Error	-14.679 kHz	% of OBW Power	99.00 %										
x dB Bandwidth	979.0 kHz	x dB	-20.00 dB										
2480 MHz	<p>Center Frequency: 2.48000000 GHz Span: 3.0000 MHz CF Step: 300.000 kHz #Res BW: 30.000 kHz #Video BW: 100.00 kHz Sweep: 3.20 ms (1001 pts)</p> <table border="1"> <tr> <td>Occupied Bandwidth</td> <td>889.03 kHz</td> <td>Total Power</td> <td>16.5 dBm</td> </tr> <tr> <td>Transmit Freq Error</td> <td>-22.207 kHz</td> <td>% of OBW Power</td> <td>99.00 %</td> </tr> <tr> <td>x dB Bandwidth</td> <td>982.2 kHz</td> <td>x dB</td> <td>-20.00 dB</td> </tr> </table>	Occupied Bandwidth	889.03 kHz	Total Power	16.5 dBm	Transmit Freq Error	-22.207 kHz	% of OBW Power	99.00 %	x dB Bandwidth	982.2 kHz	x dB	-20.00 dB
Occupied Bandwidth	889.03 kHz	Total Power	16.5 dBm										
Transmit Freq Error	-22.207 kHz	% of OBW Power	99.00 %										
x dB Bandwidth	982.2 kHz	x dB	-20.00 dB										

Mode 4: 8DPSK Continuous TX mode	
2402 MHz	<p>Center 2.402000 GHz #Res BW 30.000 kHz Span 3 MHz Sweep 3.20 ms (1001 pts)</p> <p>Occupied Bandwidth: 1.1902 MHz Total Power: 15.3 dBm Transmit Freq Error: -9.022 kHz % of OBW Power: 99.00 % x dB Bandwidth: 1.310 MHz x dB: -20.00 dB</p>
2441 MHz	<p>Center 2.441000 GHz #Res BW 30.000 kHz Span 3 MHz Sweep 3.20 ms (1001 pts)</p> <p>Occupied Bandwidth: 1.1929 MHz Total Power: 15.5 dBm Transmit Freq Error: -16.105 kHz % of OBW Power: 99.00 % x dB Bandwidth: 1.312 MHz x dB: -20.00 dB</p>
2480 MHz	<p>Center 2.480000 GHz #Res BW 30.000 kHz Span 3 MHz Sweep 3.20 ms (1001 pts)</p> <p>Occupied Bandwidth: 1.1929 MHz Total Power: 16.3 dBm Transmit Freq Error: -23.450 kHz % of OBW Power: 99.00 % x dB Bandwidth: 1.311 MHz x dB: -20.00 dB</p>



**Carrier Frequency Separation Measurement**

Test Mode	Frequency (MHz)	Measurement Results (MHz)	Limit (MHz)
Mode 2	2402	1.000	$\geq$ 0.653
	2441	1.000	$\geq$ 0.653
	2480	1.000	$\geq$ 0.655
Mode 4	2402	1.000	$\geq$ 0.873
	2441	1.000	$\geq$ 0.875
	2480	1.000	$\geq$ 0.874

■ Test Graphs

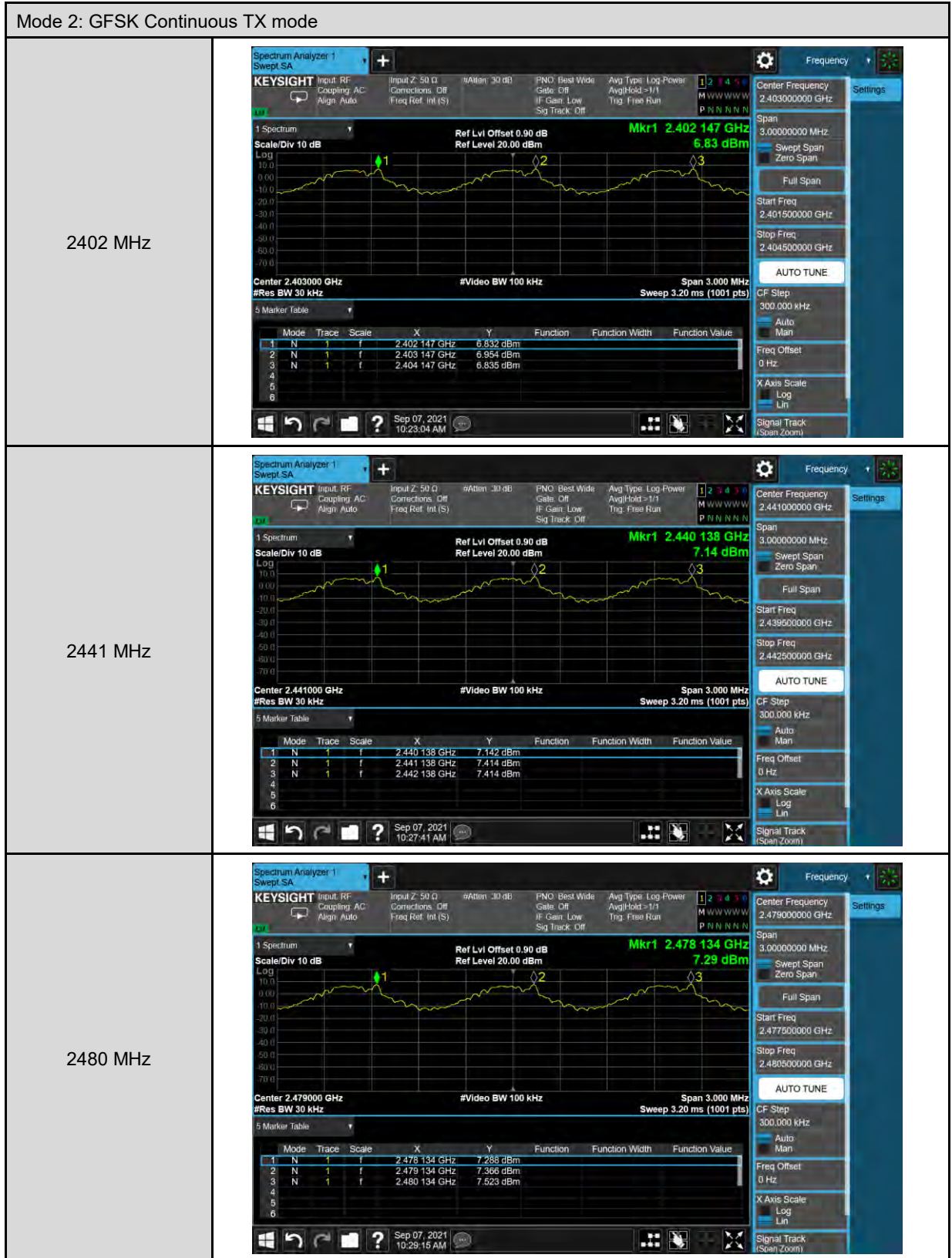

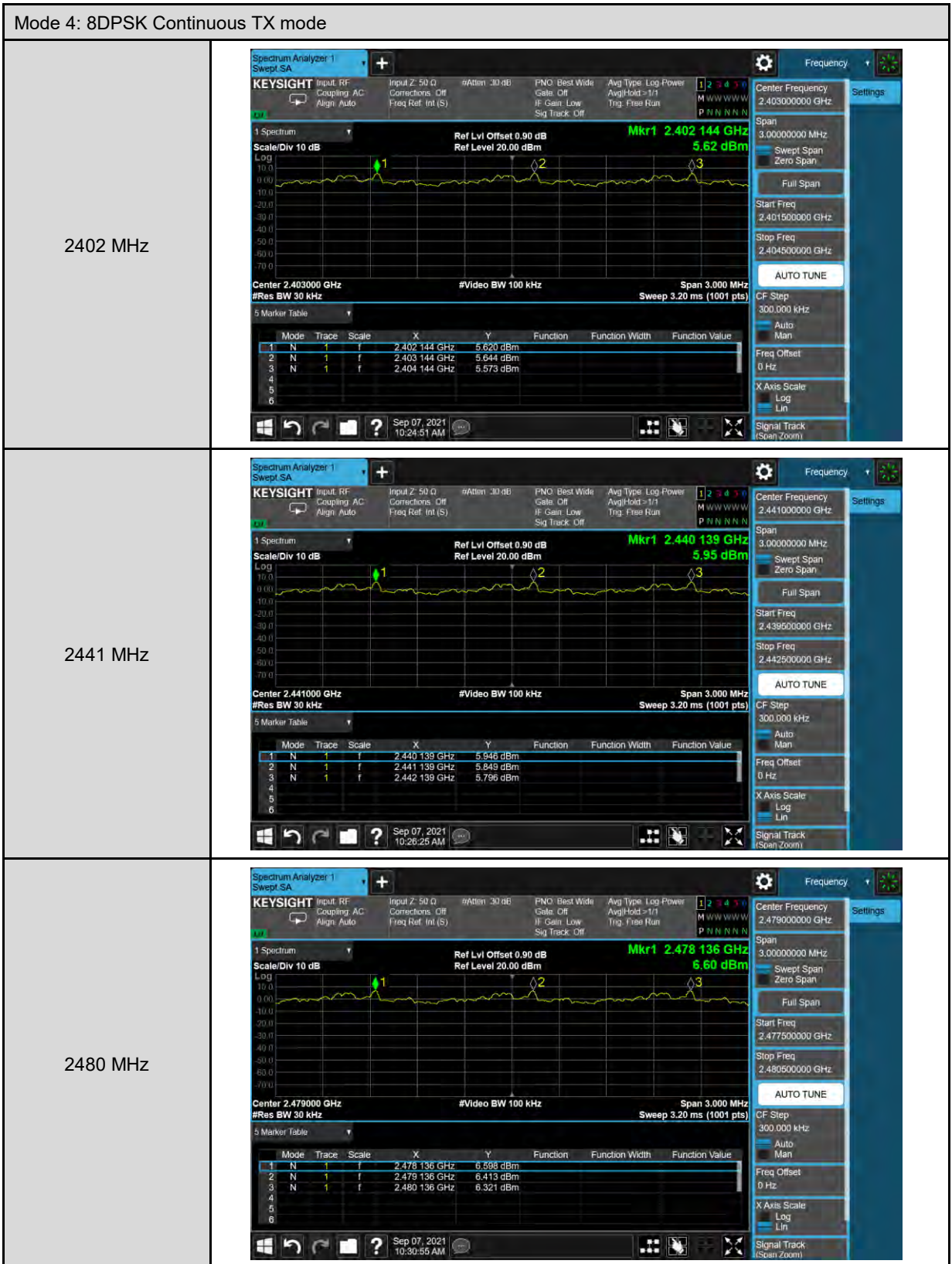







**Number of Hopping Measurement**

Test Mode	Frequency Range (MHz)	Measurement Results (Ch)	Limit (ch)
Mode 2	2402 - 2480	79	≥ 15
Mode 4	2402 - 2480	79	≥ 15

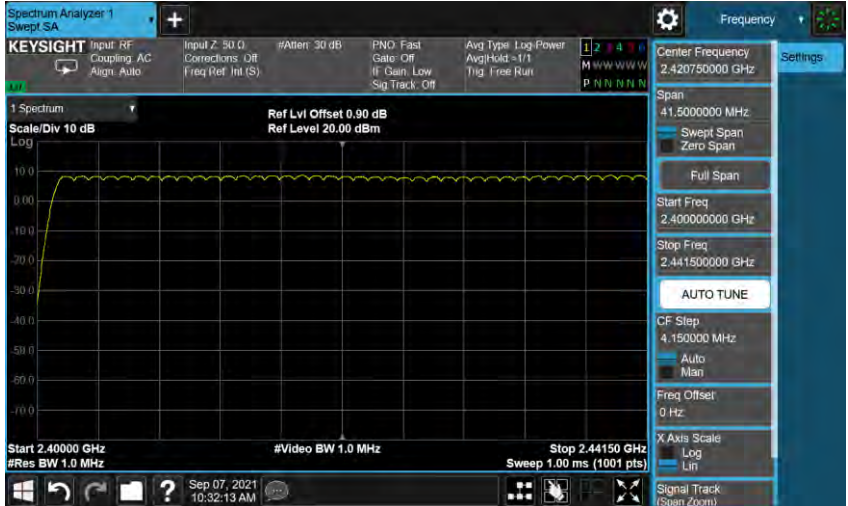
■ Test Graphs

Mode 2: GFSK Continuous TX mode	
CH0~CH39	
CH40~CH78	

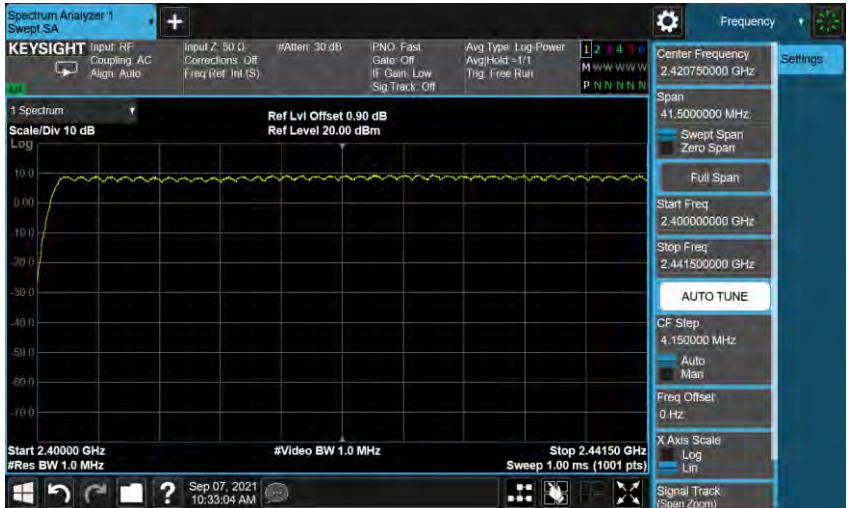
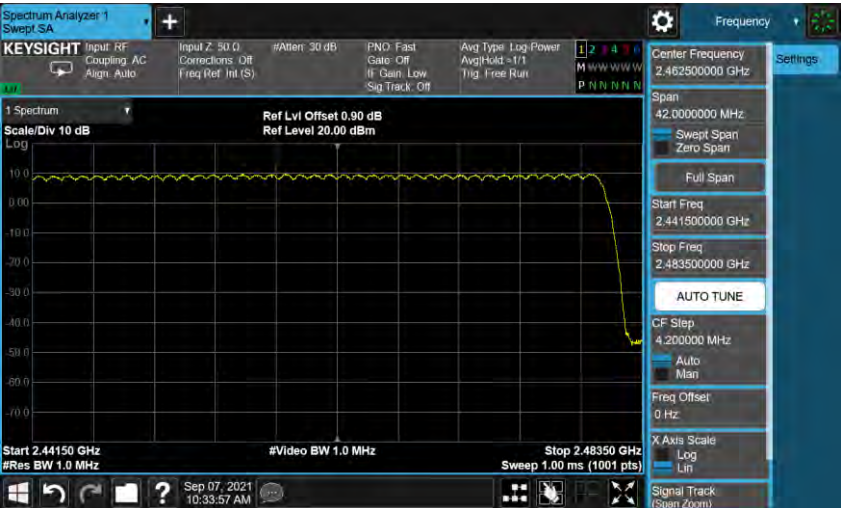
Mode 4: 8DPSK Continuous TX mode	
CH0~CH39	
CH40~CH78	



**Time of Occupancy (Dwell Time) Measurement**

Mode 2: GFSK Continuous TX mode	
DH1	
Cycle Calculate	$79CH * 0.4 = 31.6 \text{ (sec)}$
The EUT Hopping Number per Sec	1600 times/sec
Each Channel Dwell Times per Sec	$800/79CH = 10.13(\text{times/sec})$
Each Channel Dwell Times on Cycle(1)	$31.6 * 10.13 = 320.108(\text{times})$
Each Channel Dwell Times (2)	0.450 ms (sec)
Dwell Times on Cycle (1) * (2)	144.049 ms (sec)
LIMIT(msec)	$< = 400$
DH3	
Cycle Calculate	$79CH * 0.4 = 31.6 \text{ (sec)}$
The EUT Hopping Number per Sec	1600 times/sec
Each Channel Dwell Times per Sec	$400/79CH = 5.1(\text{times/sec})$
Each Channel Dwell Times on Cycle(1)	$31.6 * 5.1 = 161.16(\text{times})$
Each Channel Dwell Times (2)	1.670 ms (sec)
Dwell Times on Cycle (1) * (2)	267.026 ms (sec)
LIMIT(msec)	$< = 400$
DH5	
Cycle Calculate	$79CH * 0.4 = 31.6 \text{ (sec)}$
The EUT Hopping Number per Sec	1600 times/sec
Each Channel Dwell Times per Sec	$266.7/79CH = 3.37(\text{times/sec})$
Each Channel Dwell Times on Cycle(1)	$31.6 * 3.37 = 106.492(\text{times})$
Each Channel Dwell Times (2)	2.920 ms (sec)
Dwell Times on Cycle (1) * (2)	311.879 ms (sec)
LIMIT(msec)	$< = 400$



Mode 4: 8DPSK Continuous TX mode	
<b>3DH1</b>	
Cycle Calculate	$79CH * 0.4 = 31.6 \text{ (sec)}$
The EUT Hopping Number per Sec	1600 times/sec
Each Channel Dwell Times per Sec	$800/79CH = 10.13(\text{times/sec})$
Each Channel Dwell Times on Cycle(1)	$31.6 * 10.13 = 320.108(\text{times})$
Each Channel Dwell Times (2)	0.450 ms (sec)
Dwell Times on Cycle (1) * (2)	144.049 ms (sec)
LIMIT(msec)	$< = 400$
<b>3DH3</b>	
Cycle Calculate	$79CH * 0.4 = 31.6 \text{ (sec)}$
The EUT Hopping Number per Sec	1600 times/sec
Each Channel Dwell Times per Sec	$400/79CH = 5.1(\text{times/sec})$
Each Channel Dwell Times on Cycle(1)	$31.6 * 5.1 = 161.16(\text{times})$
Each Channel Dwell Times (2)	1.680 ms (sec)
Dwell Times on Cycle (1) * (2)	268.625 ms (sec)
LIMIT(msec)	$< = 400$
<b>3DH5</b>	
Cycle Calculate	$79CH * 0.4 = 31.6 \text{ (sec)}$
The EUT Hopping Number per Sec	1600 times/sec
Each Channel Dwell Times per Sec	$266.7/79CH = 3.37(\text{times/sec})$
Each Channel Dwell Times on Cycle(1)	$31.6 * 3.37 = 106.492(\text{times})$
Each Channel Dwell Times (2)	2.960 ms (sec)
Dwell Times on Cycle (1) * (2)	316.152 ms (sec)
LIMIT(msec)	$< = 400$



■ Test Graphs

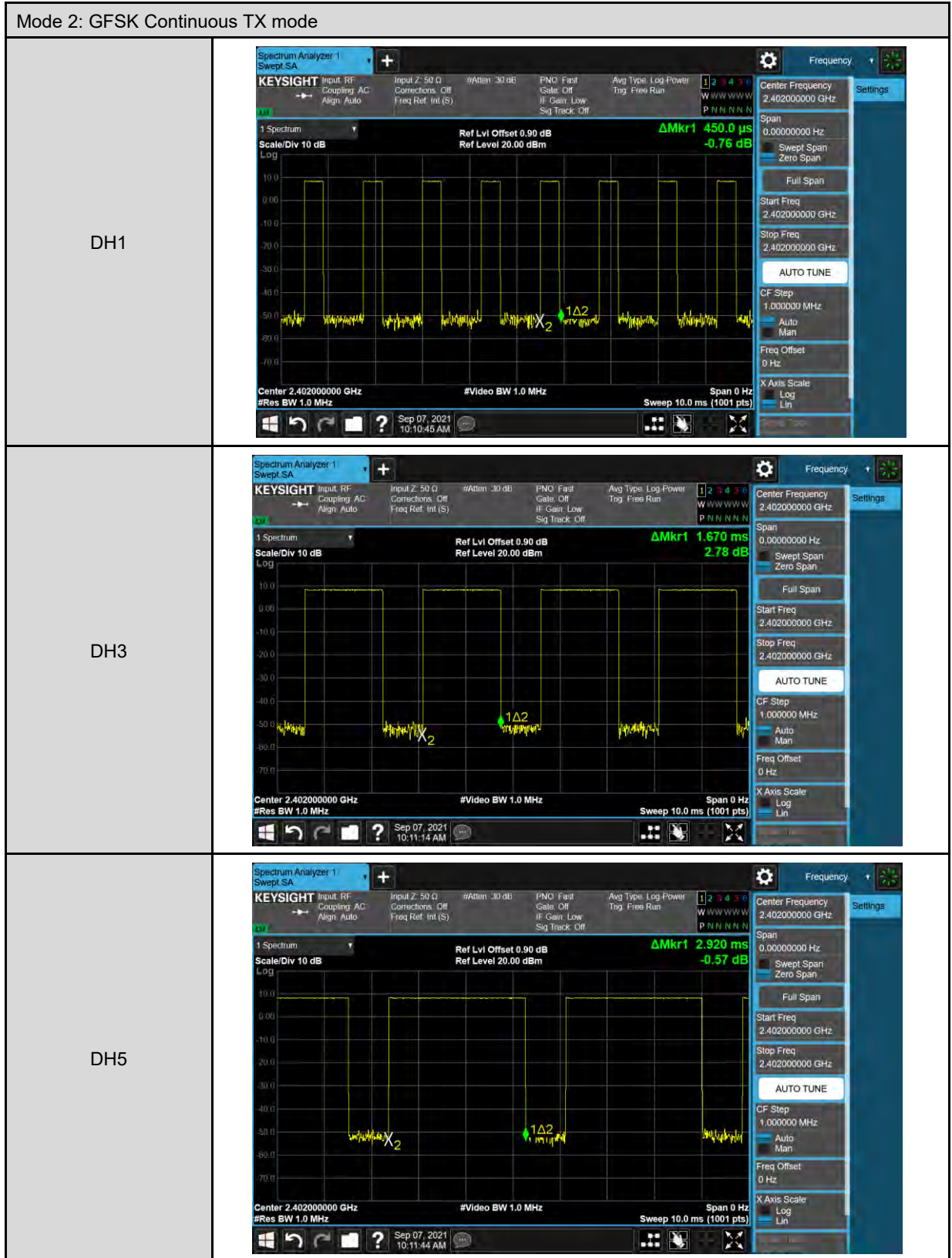

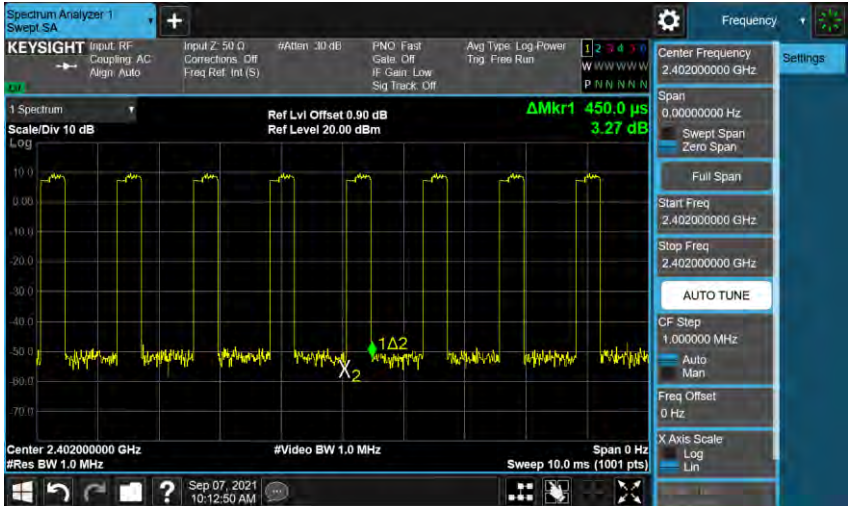
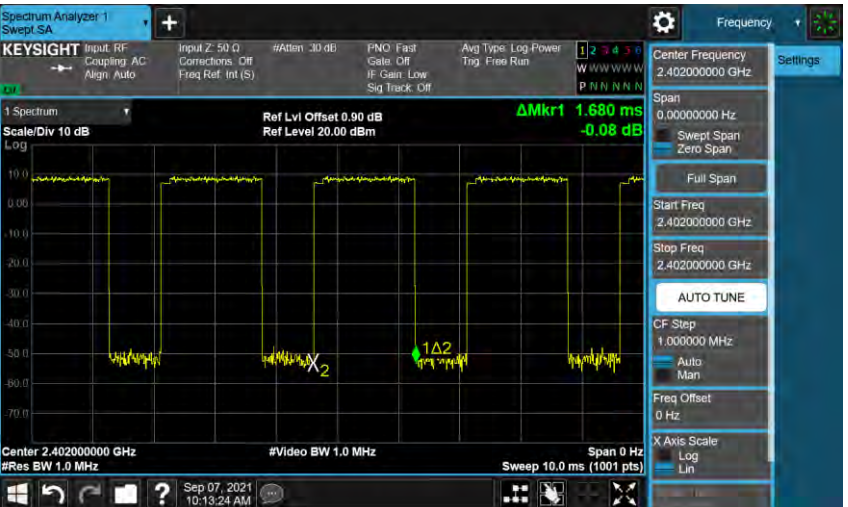
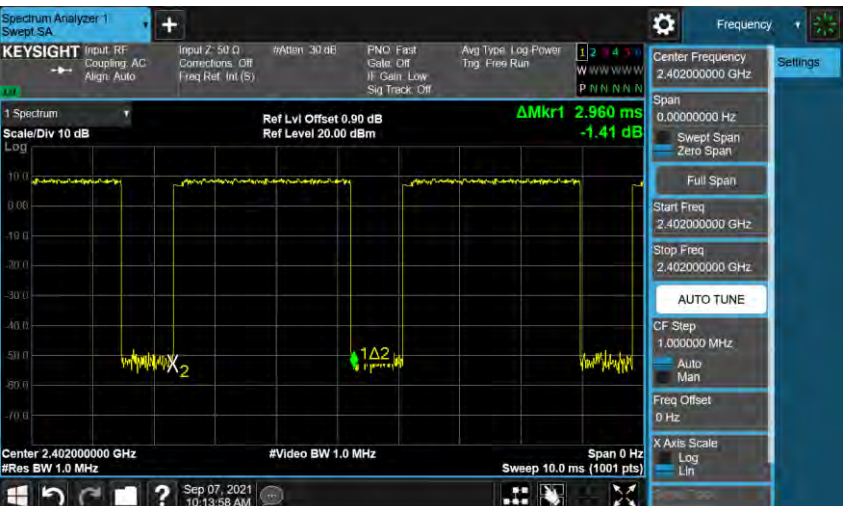

Mode 4: 8DPSK Continuous TX mode	
3DH1	
3DH3	
3DH5	

### Out of Band Conducted Spurious Emission

#### Test Graphs

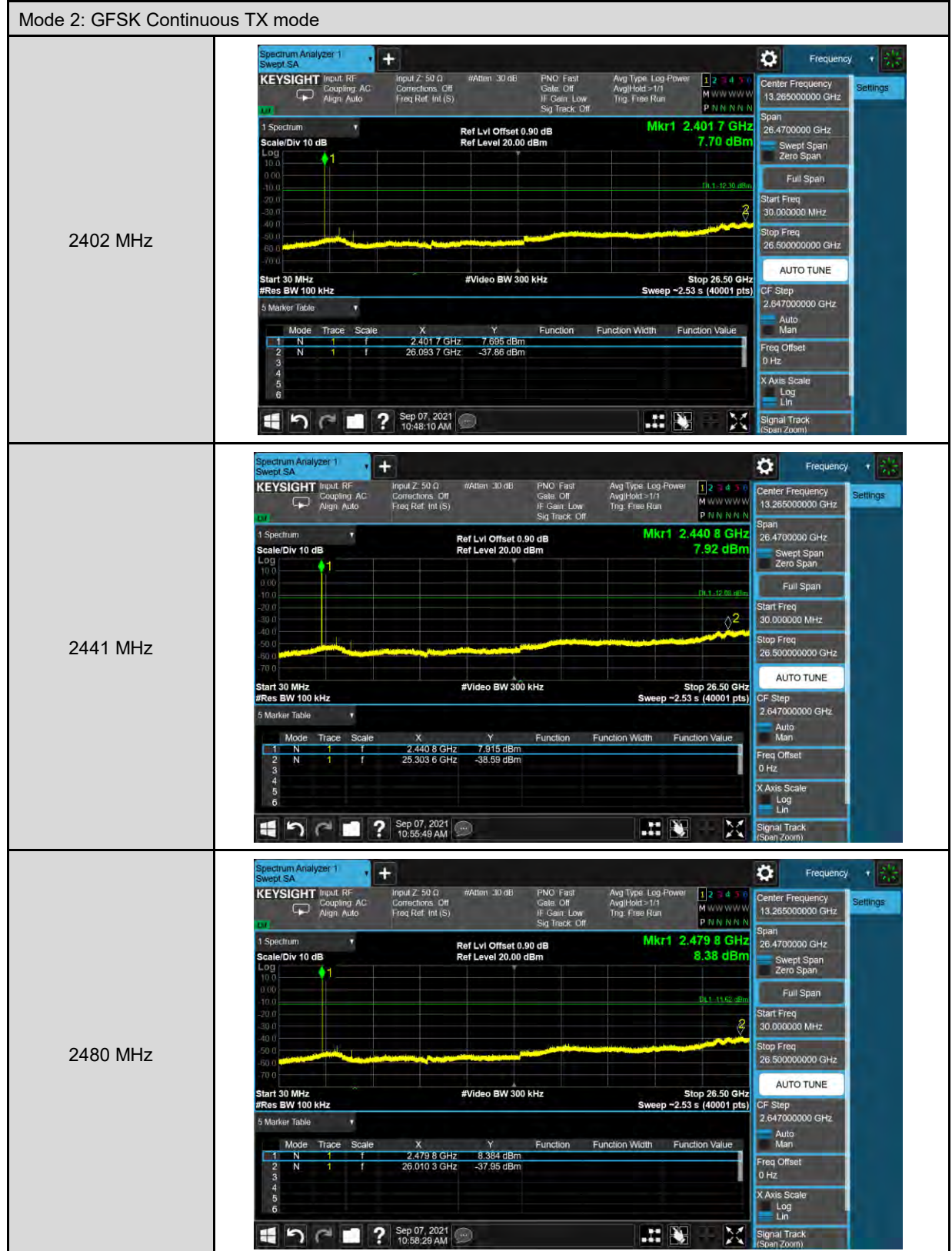



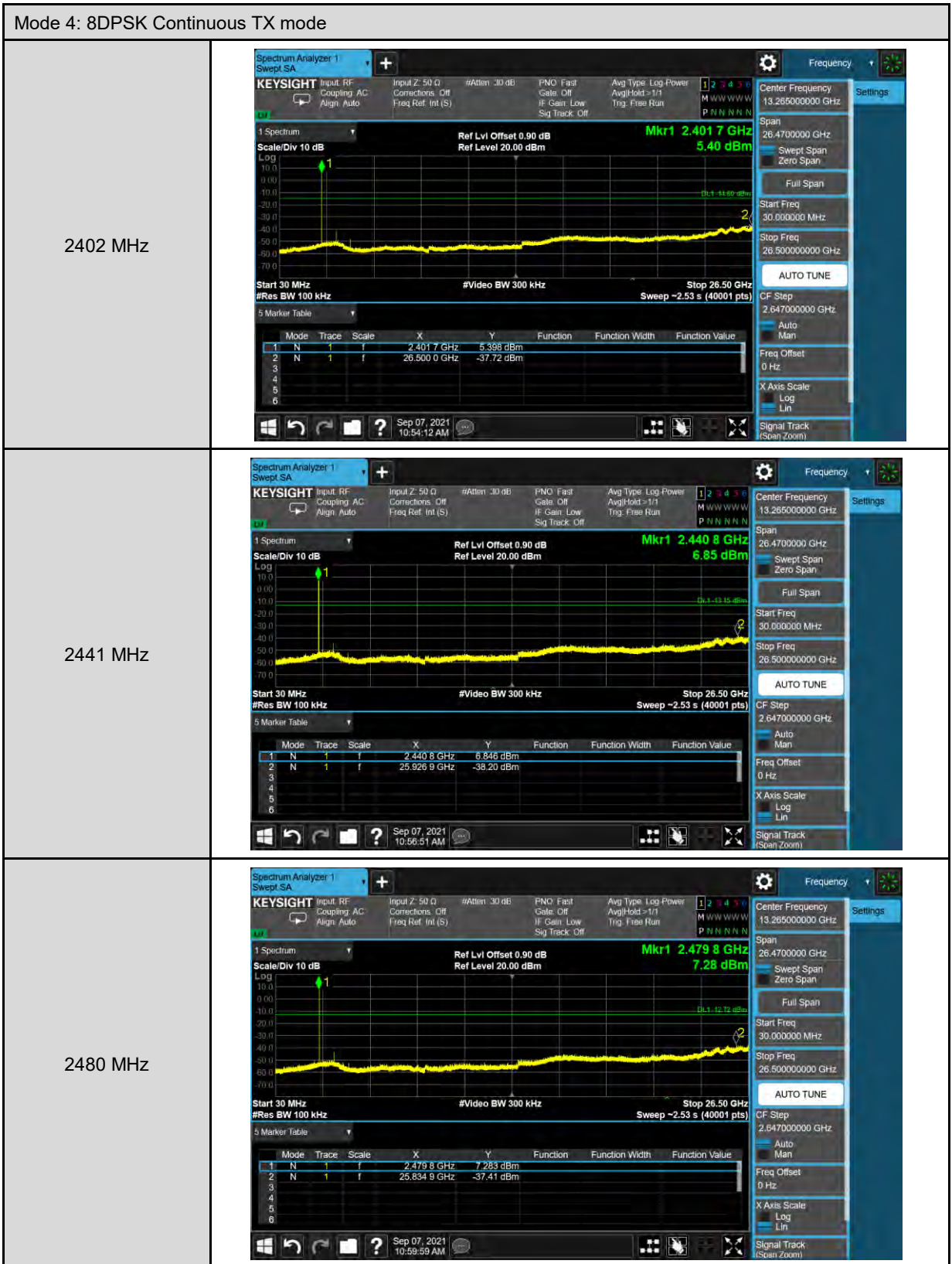

### Conducted Band Edge

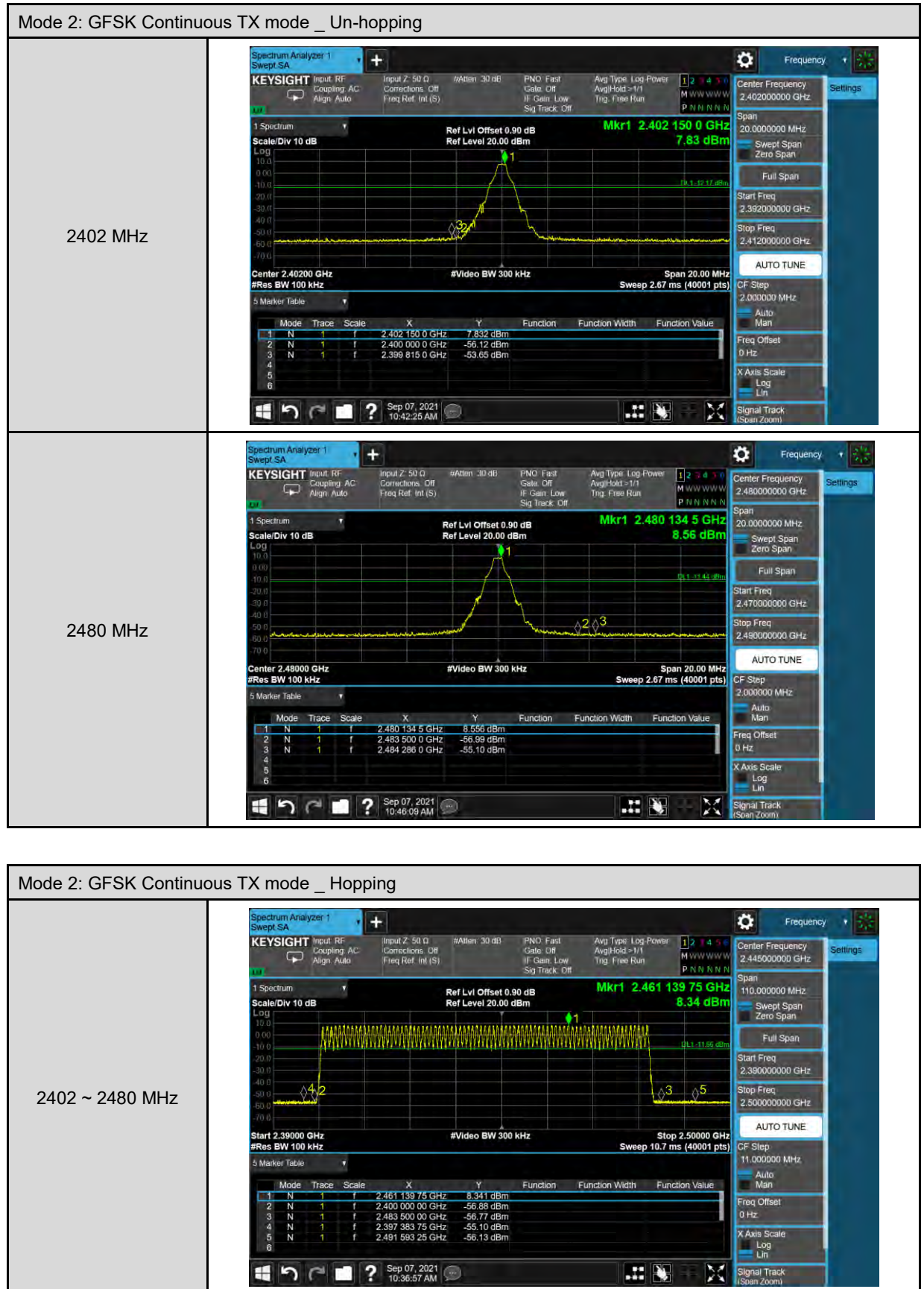

Mode 4: 8DPSK Continuous TX mode \_ Un-hopping

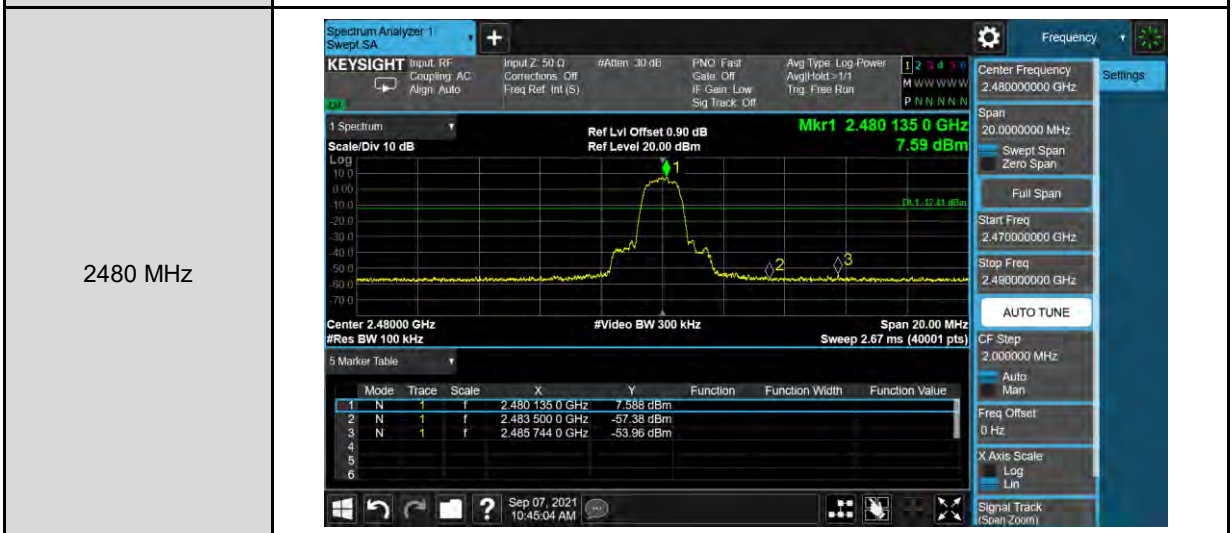
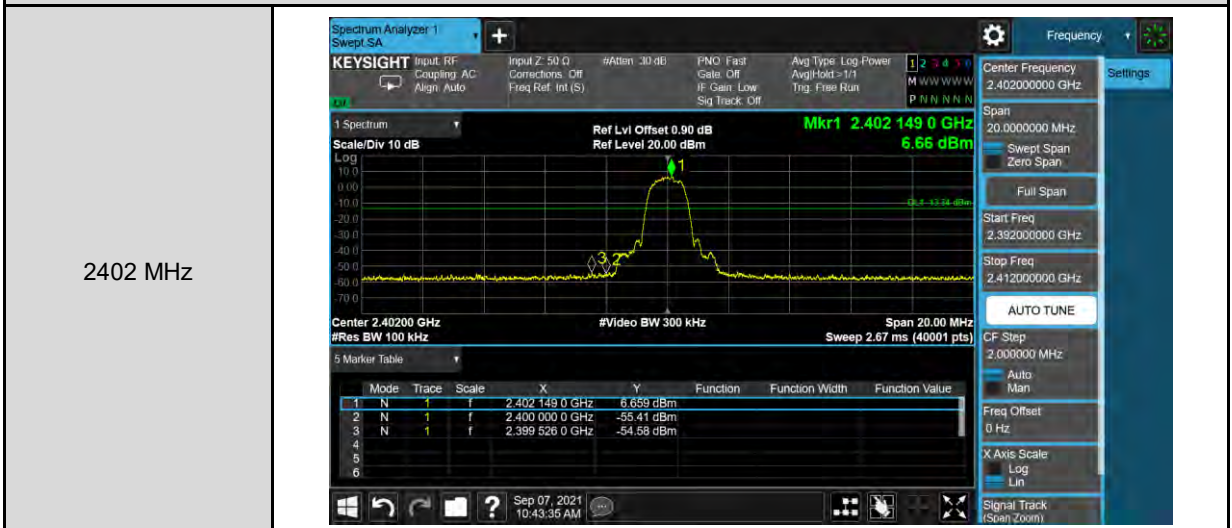

Mode 4: 8DPSK Continuous TX mode \_ Hopping

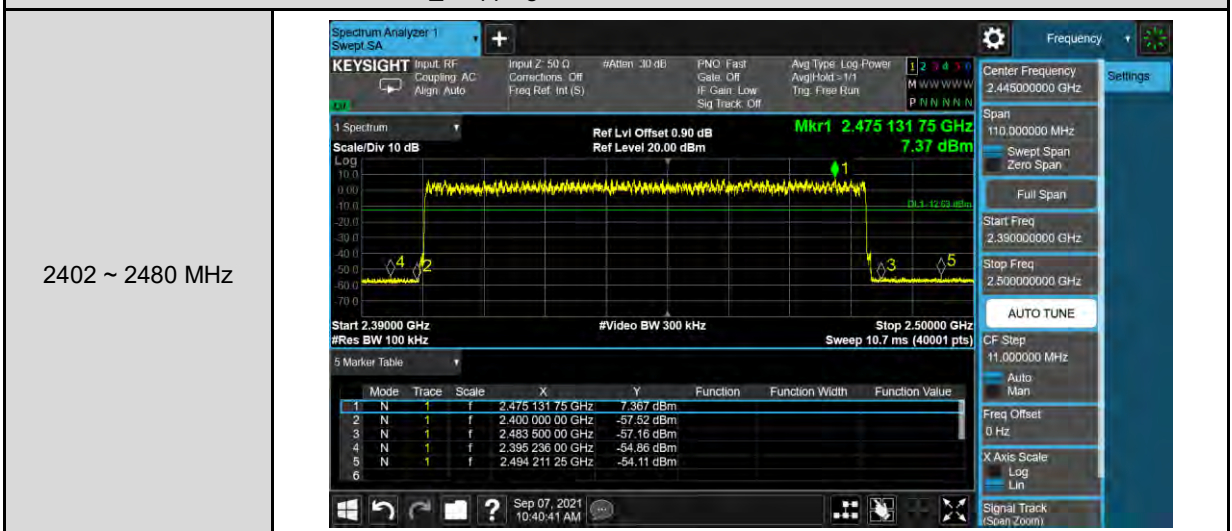



### Annex C. Radiated Emission Measurement

Below 1 GHz

Standard:	FCC Part 15.247	Test Distance:	3 m
Frequency:	2480 MHz		
Mode:	Mode 4		
Ant.Polar.:	Horizontal		

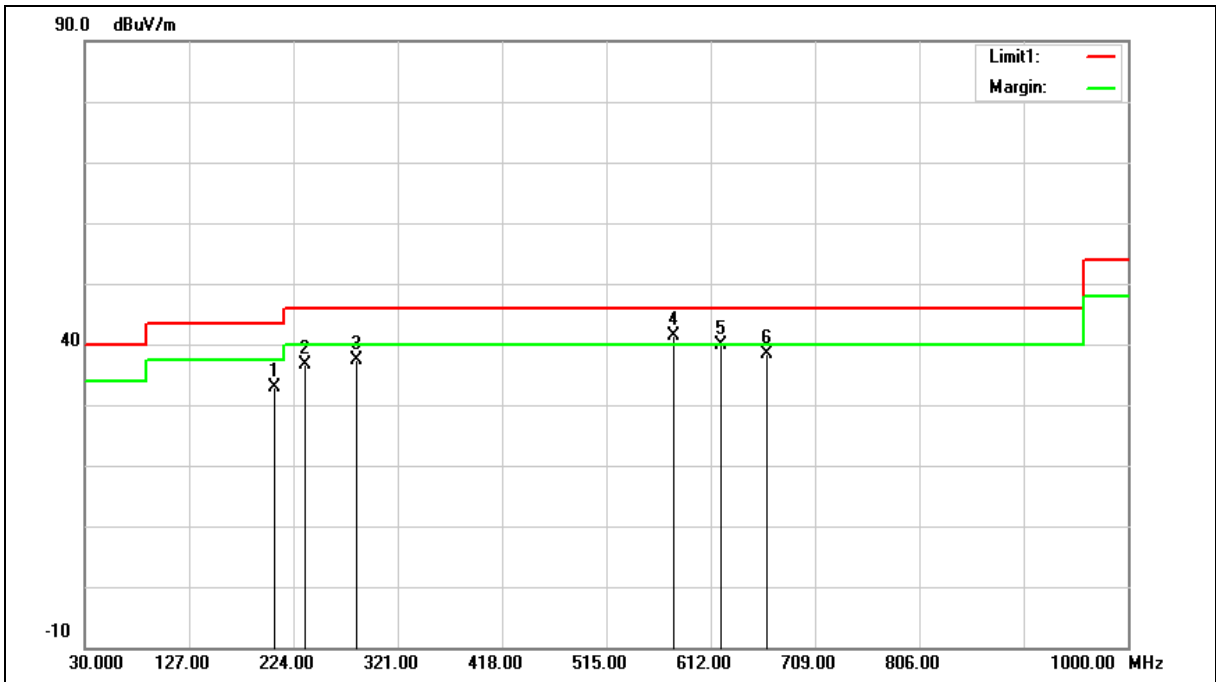

No.	Frequency (MHz)	Reading (dBuV)	Correct Factor (dB/m)	Result (dBuV/m)	Limit (dBuV/m)	Margin (dB)	Remark
1	206.5400	42.04	-9.13	32.91	43.50	-10.59	QP
2	234.6700	44.34	-7.64	36.70	46.00	-9.30	QP
3	282.2000	43.19	-5.84	37.35	46.00	-8.65	QP
4	577.0800	41.54	-0.10	41.44	46.00	-4.56	QP
5	621.7000	39.21	0.79	40.00	46.00	-6.00	QP
6	664.3800	36.93	1.44	38.37	46.00	-7.63	QP

Note:1.Result (dBuV/m) = Correct Factor (dB/m) + Reading(dBuV).

Example: 32.91 = -9.13 + 42.04

2.Correction factor (dB/m) = Antenna Factor (dB/m) + Cable loss (dB) – Pre-Amplifier gain (dB).

3.When the peak results are less than average limit, so not need to evaluate the average.



Standard:	FCC Part 15.247	Test Distance:	3 m
Frequency:	2480 MHz		
Mode:	Mode 4		
Ant.Polar.:	Vertical		

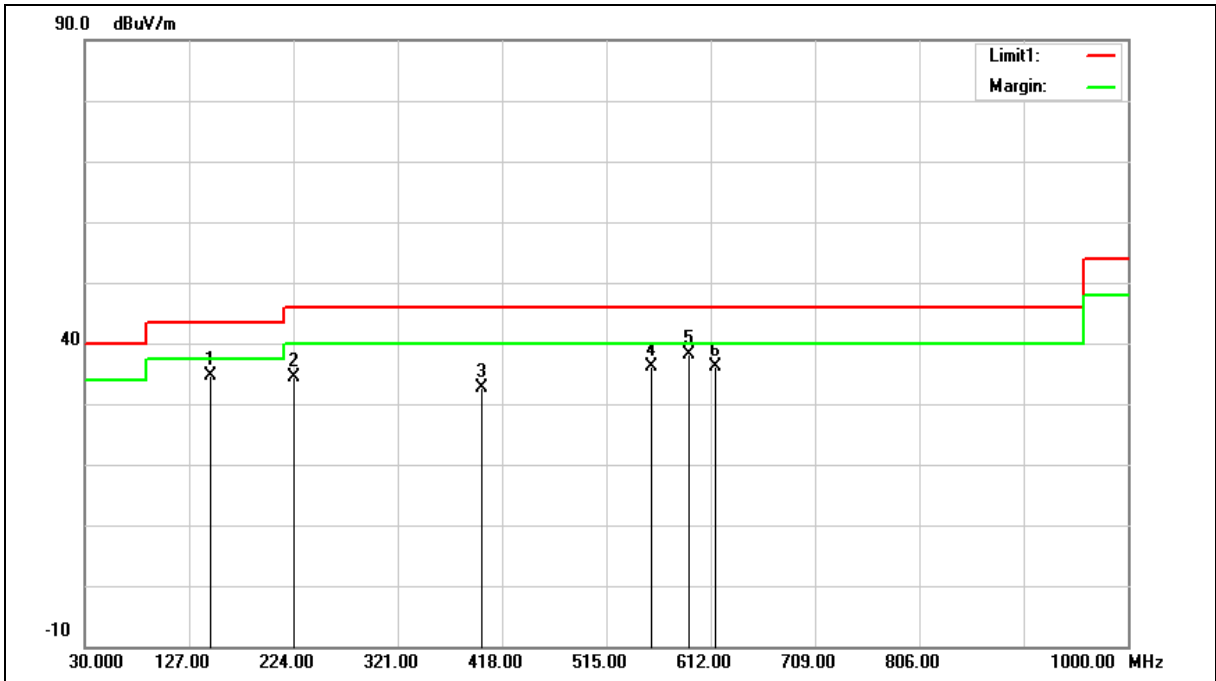

No.	Frequency (MHz)	Reading (dBuV)	Correct Factor (dB/m)	Result (dBuV/m)	Limit (dBuV/m)	Margin (dB)	Remark
1	147.3700	41.39	-6.83	34.56	43.50	-8.94	QP
2	224.0000	42.61	-8.33	34.28	46.00	-11.72	QP
3	399.5700	36.03	-3.30	32.73	46.00	-13.27	QP
4	556.7100	36.80	-0.68	36.12	46.00	-9.88	QP
5	591.6300	37.85	0.31	38.16	46.00	-7.84	QP
6	615.8800	35.36	0.73	36.09	46.00	-9.91	QP

Note:1.Result (dBuV/m) = Correct Factor (dB/m) + Reading(dBuV).

Example:  $34.56 = -6.83 + 41.39$

2.Correction factor (dB/m) = Antenna Factor (dB/m) + Cable loss (dB) – Pre-Amplifier gain (dB).

3.When the peak results are less than average limit, so not need to evaluate the average.



### Harmonic

Above 1 GHz

Standard:	FCC Part 15.247	Test Distance:	3 m
Test item:	Harmonic		
Frequency:	2402 MHz		
Mode:	Mode 2		
Ant.Polar.:	Horizontal		

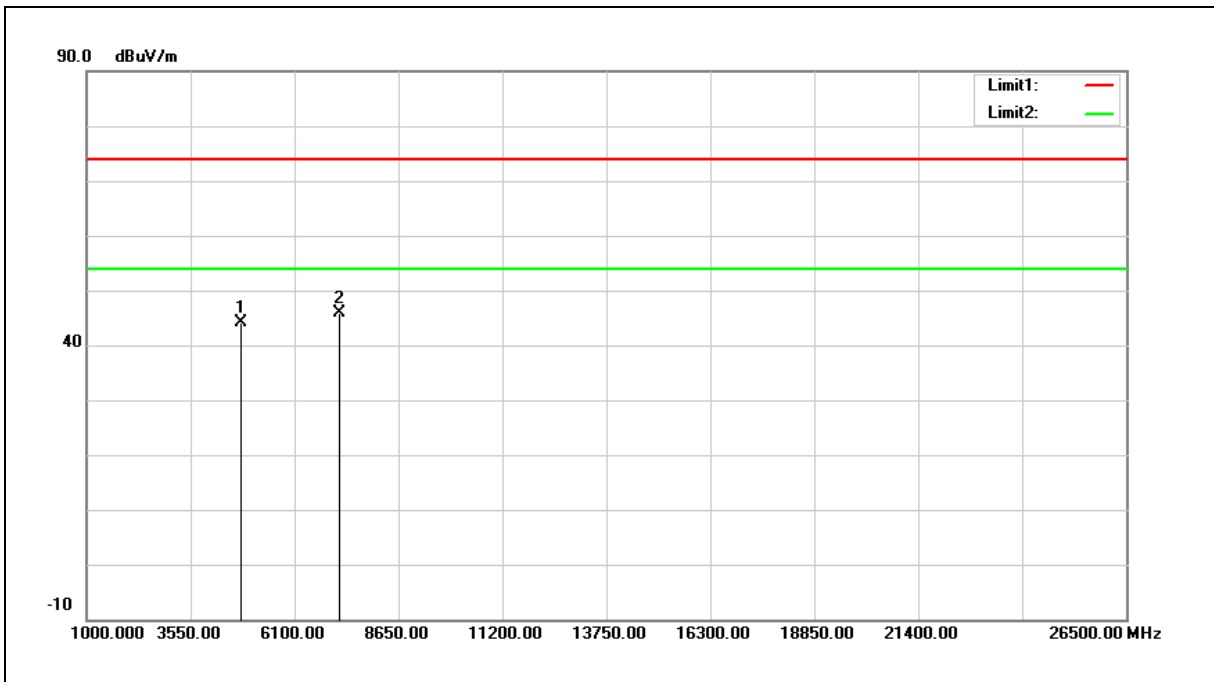

No.	Frequency (MHz)	Reading (dBuV)	Correct Factor (dB/m)	Result (dBuV/m)	Limit (dBuV/m)	Margin (dB)	Remark
1	4804.000	40.33	3.79	44.12	74.00	-29.88	peak
2	7206.000	36.16	9.76	45.92	74.00	-28.08	peak

Note:1.Result (dBuV/m) = Correct Factor (dB/m) + Reading(dBuV).

Example: 44.12 = 3.79 + 40.33

2.Correction factor (dB/m) = Antenna Factor (dB/m) + Cable loss (dB) – Pre-Amplifier gain (dB).

3.When the peak results are less than average limit, so not need to evaluate the average.



Standard:	FCC Part 15.247	Test Distance:	3 m
Test item:	Harmonic		
Frequency:	2402 MHz		
Mode:	Mode 2		
Ant.Polar.:	Vertical		

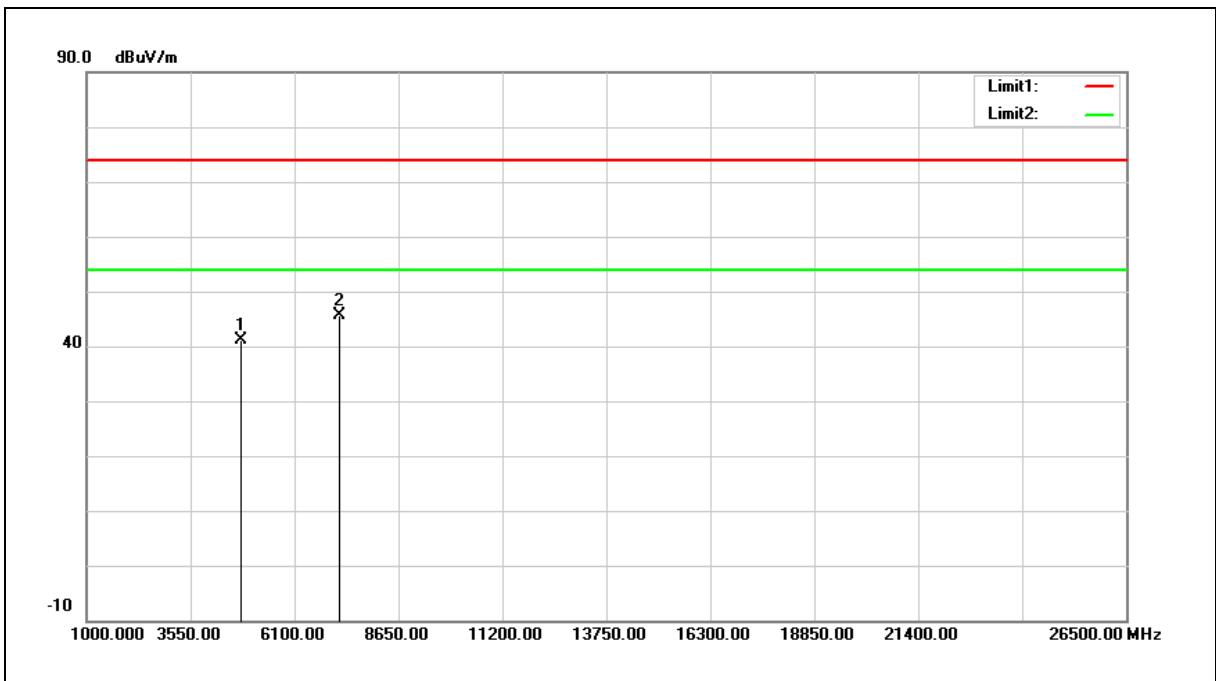

No.	Frequency (MHz)	Reading (dBuV)	Correct Factor (dB/m)	Result (dBuV/m)	Limit (dBuV/m)	Margin (dB)	Remark
1	4804.000	37.38	3.79	41.17	74.00	-32.83	peak
2	7206.000	35.80	9.76	45.56	74.00	-28.44	peak

Note: 1. Result (dBuV/m) = Correct Factor (dB/m) + Reading (dBuV).

Example:  $41.17 = 3.79 + 37.38$

2. Correction factor (dB/m) = Antenna Factor (dB/m) + Cable loss (dB) – Pre-Amplifier gain (dB).

3. When the peak results are less than average limit, so not need to evaluate the average.



Standard:	FCC Part 15.247	Test Distance:	3 m
Test item:	Harmonic		
Frequency:	2441 MHz		
Mode:	Mode 2		
Ant.Polar.:	Horizontal		

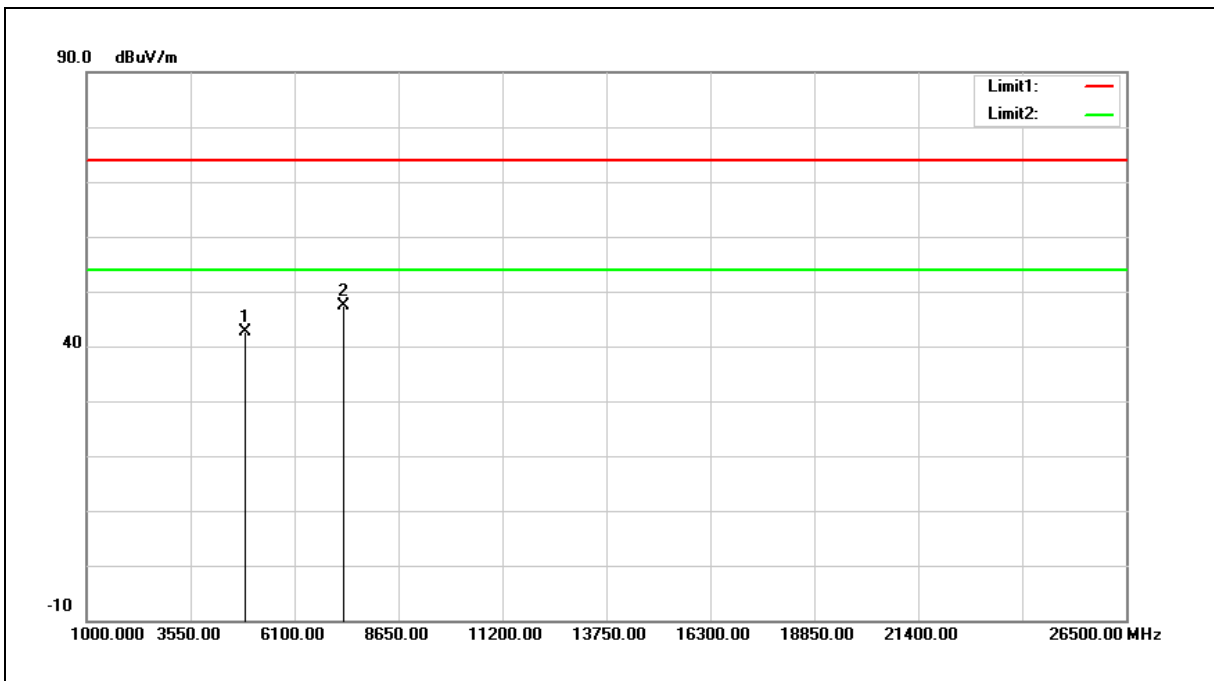

No.	Frequency (MHz)	Reading (dBuV)	Correct Factor (dB/m)	Result (dBuV/m)	Limit (dBuV/m)	Margin (dB)	Remark
1	4882.000	38.54	4.04	42.58	74.00	-31.42	peak
2	7323.000	37.14	10.17	47.31	74.00	-26.69	peak

- Note: 1.Result (dBuV/m) = Correct Factor (dB/m) + Reading(dBuV).  
 2.Correction factor (dB/m) = Antenna Factor (dB/m) + Cable loss (dB) – Pre-Amplifier gain (dB).  
 3.When the peak results are less than average limit, so not need to evaluate the average.





Standard:	FCC Part 15.247	Test Distance:	3 m
Test item:	Harmonic		
Frequency:	2441 MHz		
Mode:	Mode 2		
Ant.Polar.:	Vertical		

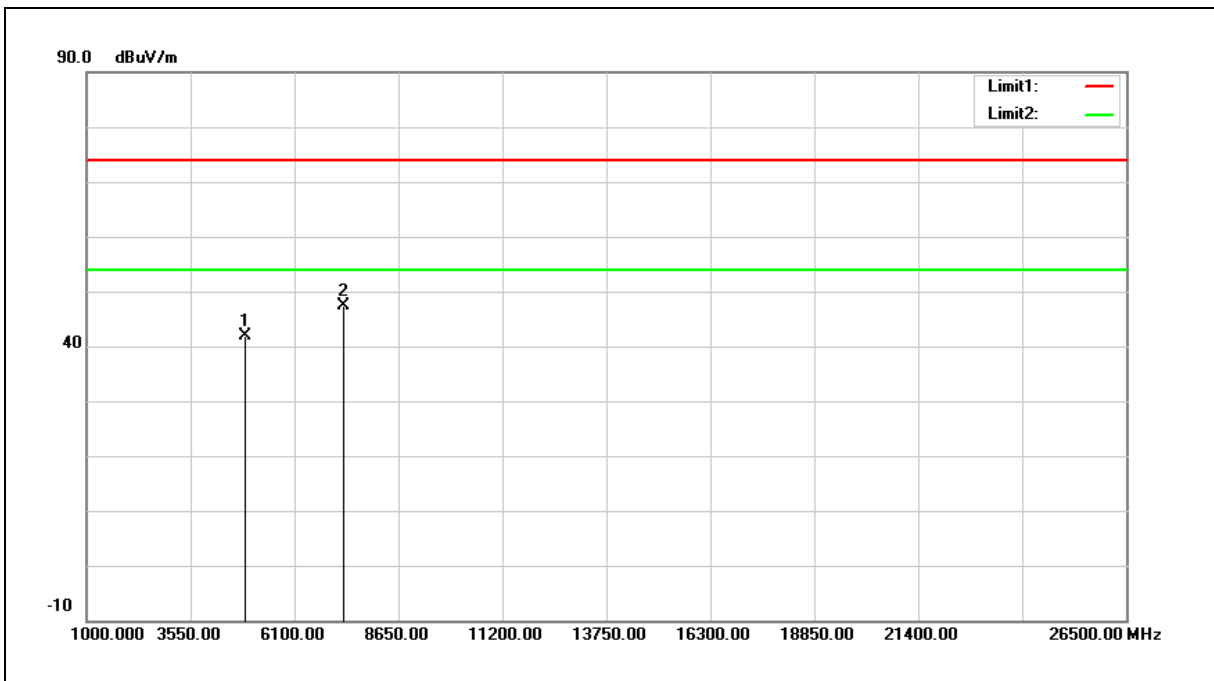

No.	Frequency (MHz)	Reading (dBuV)	Correct Factor (dB/m)	Result (dBuV/m)	Limit (dBuV/m)	Margin (dB)	Remark
1	4882.000	37.88	4.04	41.92	74.00	-32.08	peak
2	7323.000	37.11	10.17	47.28	74.00	-26.72	peak

- Note: 1. Result (dBuV/m) = Correct Factor (dB/m) + Reading(dBuV).  
 2. Correction factor (dB/m) = Antenna Factor (dB/m) + Cable loss (dB) – Pre-Amplifier gain (dB).  
 3. When the peak results are less than average limit, so not need to evaluate the average.



Standard:	FCC Part 15.247	Test Distance:	3 m
Test item:	Harmonic		
Frequency:	2480 MHz		
Mode:	Mode 2		
Ant.Polar.:	Horizontal		

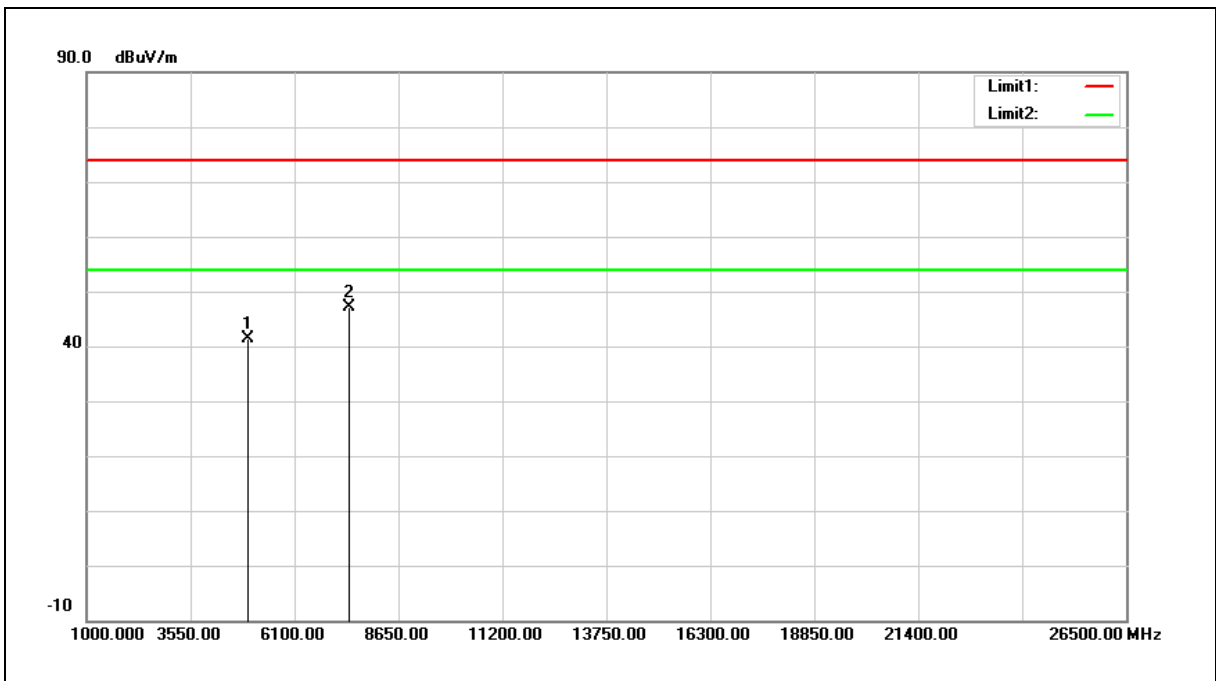

No.	Frequency (MHz)	Reading (dBuV)	Correct Factor (dB/m)	Result (dBuV/m)	Limit (dBuV/m)	Margin (dB)	Remark
1	4960.000	37.00	4.29	41.29	74.00	-32.71	peak
2	7440.000	36.52	10.59	47.11	74.00	-26.89	peak

- Note: 1. Result (dBuV/m) = Correct Factor (dB/m) + Reading (dBuV).  
 2. Correction factor (dB/m) = Antenna Factor (dB/m) + Cable loss (dB) – Pre-Amplifier gain (dB).  
 3. When the peak results are less than average limit, so not need to evaluate the average.



Standard:	FCC Part 15.247	Test Distance:	3 m
Test item:	Harmonic		
Frequency:	2480 MHz		
Mode:	Mode 2		
Ant.Polar.:	Vertical		

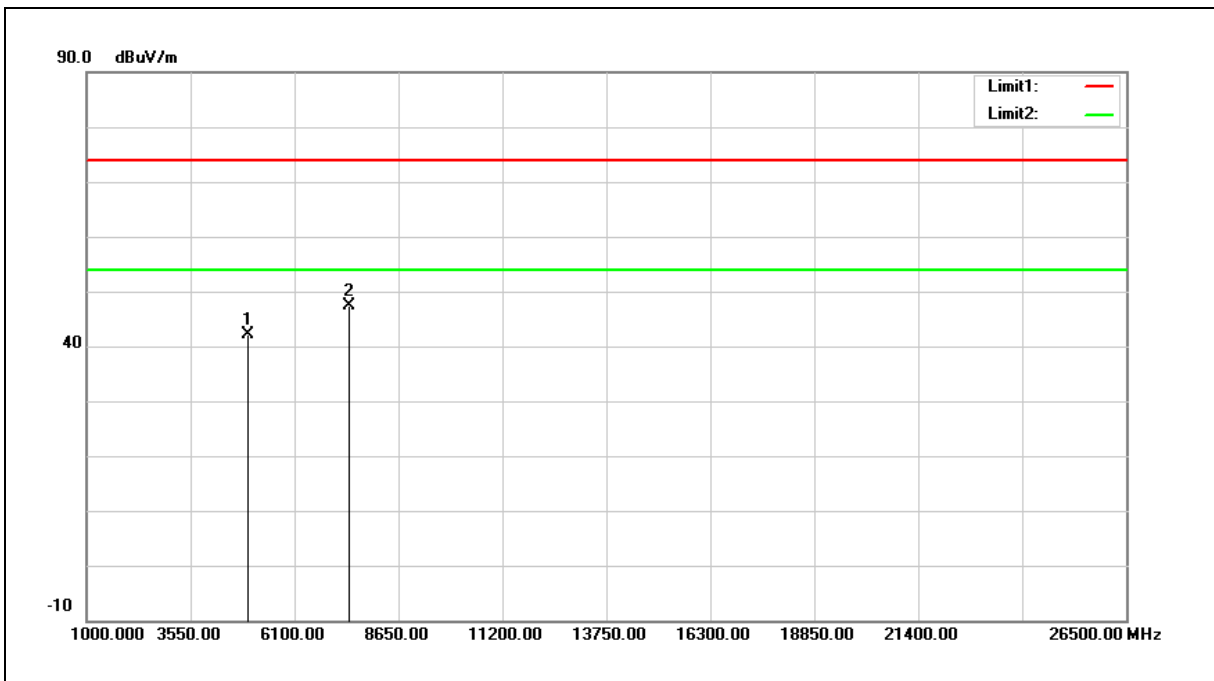

No.	Frequency (MHz)	Reading (dBuV)	Correct Factor (dB/m)	Result (dBuV/m)	Limit (dBuV/m)	Margin (dB)	Remark
1	4960.000	37.96	4.29	42.25	74.00	-31.75	peak
2	7440.000	36.77	10.59	47.36	74.00	-26.64	peak

Note: 1. Result (dBuV/m) = Correct Factor (dB/m) + Reading(dBuV).

2. Correction factor (dB/m) = Antenna Factor (dB/m) + Cable loss (dB) – Pre-Amplifier gain (dB).

3. When the peak results are less than average limit, so not need to evaluate the average.



Standard:	FCC Part 15.247	Test Distance:	3 m
Test item:	Harmonic		
Frequency:	2402 MHz		
Mode:	Mode 4		
Ant.Polar.:	Horizontal		

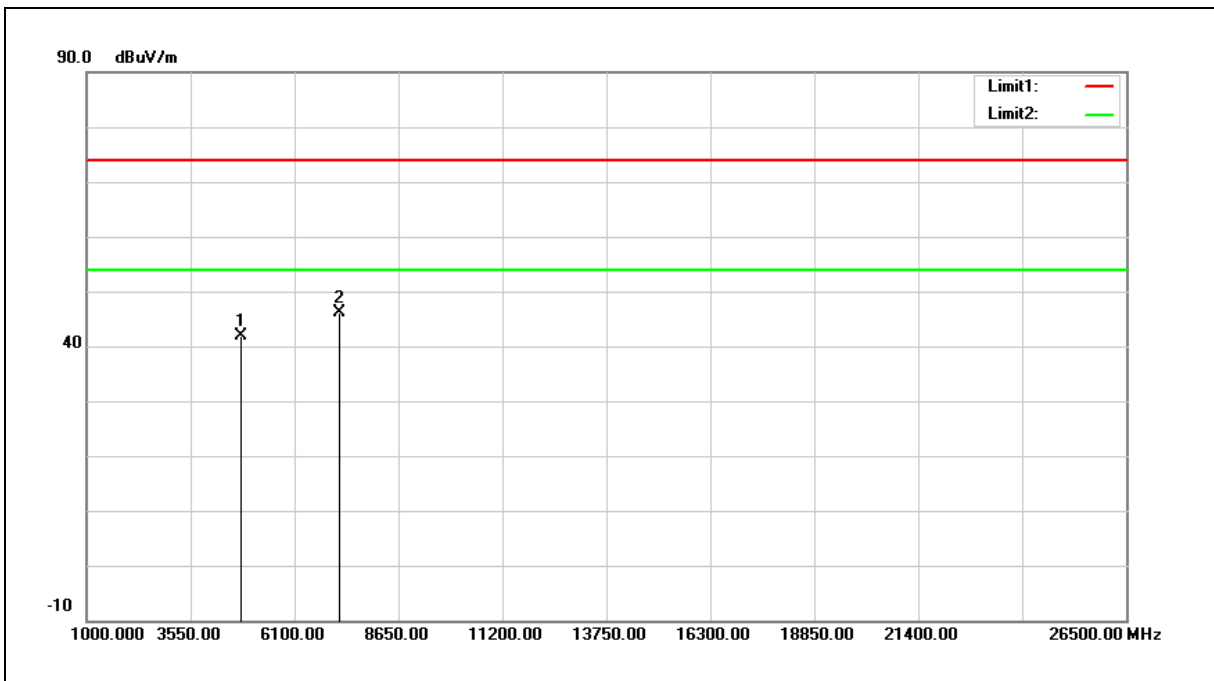

No.	Frequency (MHz)	Reading (dBuV)	Correct Factor (dB/m)	Result (dBuV/m)	Limit (dBuV/m)	Margin (dB)	Remark
1	4804.000	38.19	3.79	41.98	74.00	-32.02	peak
2	7206.000	36.45	9.76	46.21	74.00	-27.79	peak

- Note: 1.Result (dBuV/m) = Correct Factor (dB/m) + Reading(dBuV).  
 2.Correction factor (dB/m) = Antenna Factor (dB/m) + Cable loss (dB) – Pre-Amplifier gain (dB).  
 3.When the peak results are less than average limit, so not need to evaluate the average.



Standard:	FCC Part 15.247	Test Distance:	3 m
Test item:	Harmonic		
Frequency:	2402 MHz		
Mode:	Mode 4		
Ant.Polar.:	Vertical		

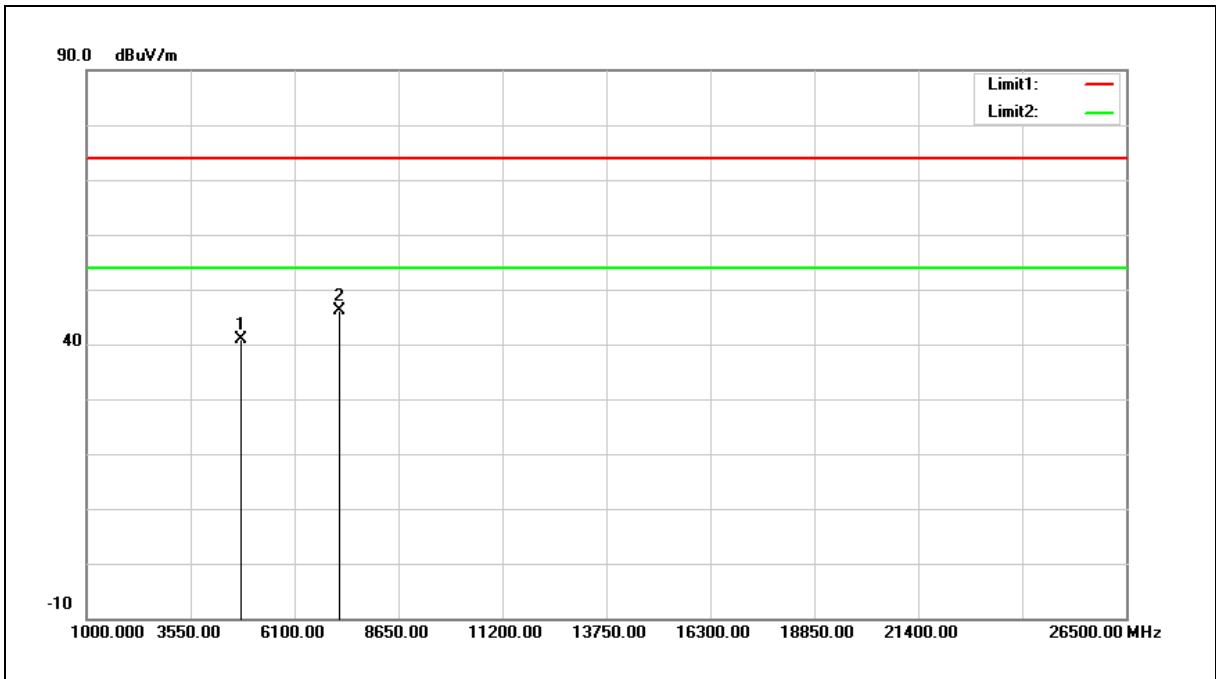

No.	Frequency (MHz)	Reading (dBuV)	Correct Factor (dB/m)	Result (dBuV/m)	Limit (dBuV/m)	Margin (dB)	Remark
1	4804.000	37.18	3.79	40.97	74.00	-33.03	peak
2	7206.000	36.46	9.76	46.22	74.00	-27.78	peak

- Note: 1. Result (dBuV/m) = Correct Factor (dB/m) + Reading (dBuV).  
 2. Correction factor (dB/m) = Antenna Factor (dB/m) + Cable loss (dB) – Pre-Amplifier gain (dB).  
 3. When the peak results are less than average limit, so not need to evaluate the average.



Standard:	FCC Part 15.247	Test Distance:	3 m
Test item:	Harmonic		
Frequency:	2441 MHz		
Mode:	Mode 4		
Ant.Polar.:	Horizontal		

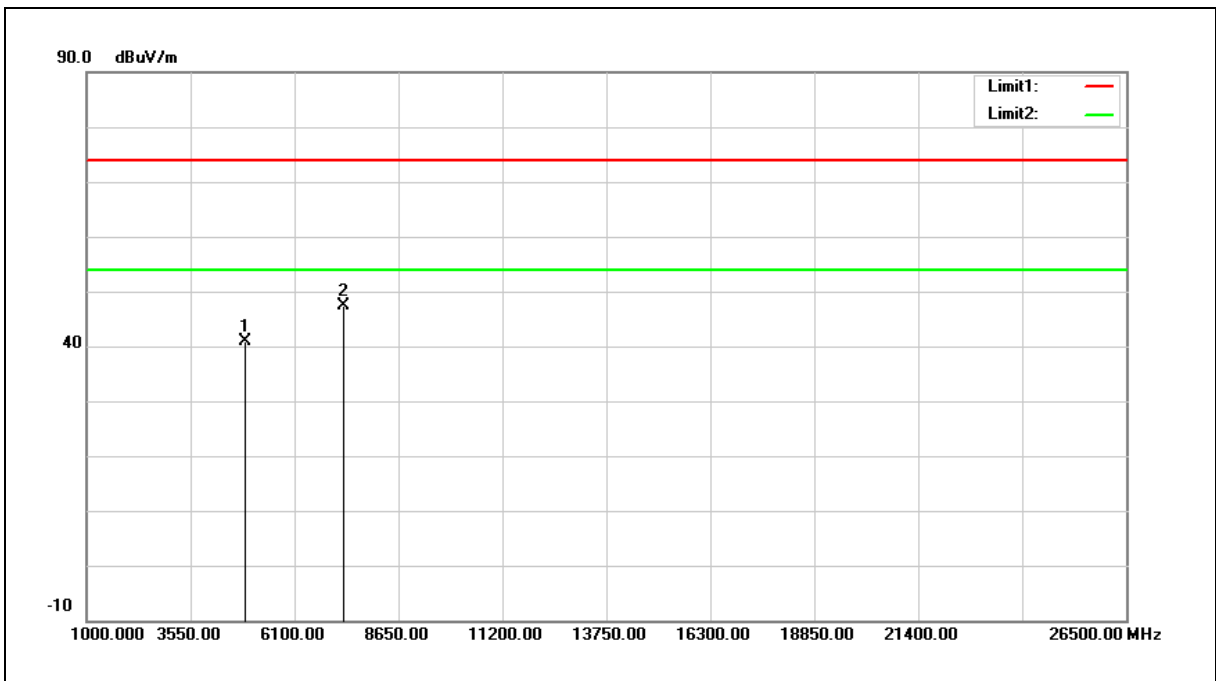

No.	Frequency (MHz)	Reading (dBuV)	Correct Factor (dB/m)	Result (dBuV/m)	Limit (dBuV/m)	Margin (dB)	Remark
1	4882.000	36.77	4.04	40.81	74.00	-33.19	peak
2	7323.000	37.19	10.17	47.36	74.00	-26.64	peak

- Note: 1. Result (dBuV/m) = Correct Factor (dB/m) + Reading (dBuV).  
 2. Correction factor (dB/m) = Antenna Factor (dB/m) + Cable loss (dB) – Pre-Amplifier gain (dB).  
 3. When the peak results are less than average limit, so not need to evaluate the average.



Standard:	FCC Part 15.247	Test Distance:	3 m
Test item:	Harmonic		
Frequency:	2441 MHz		
Mode:	Mode 4		
Ant.Polar.:	Vertical		

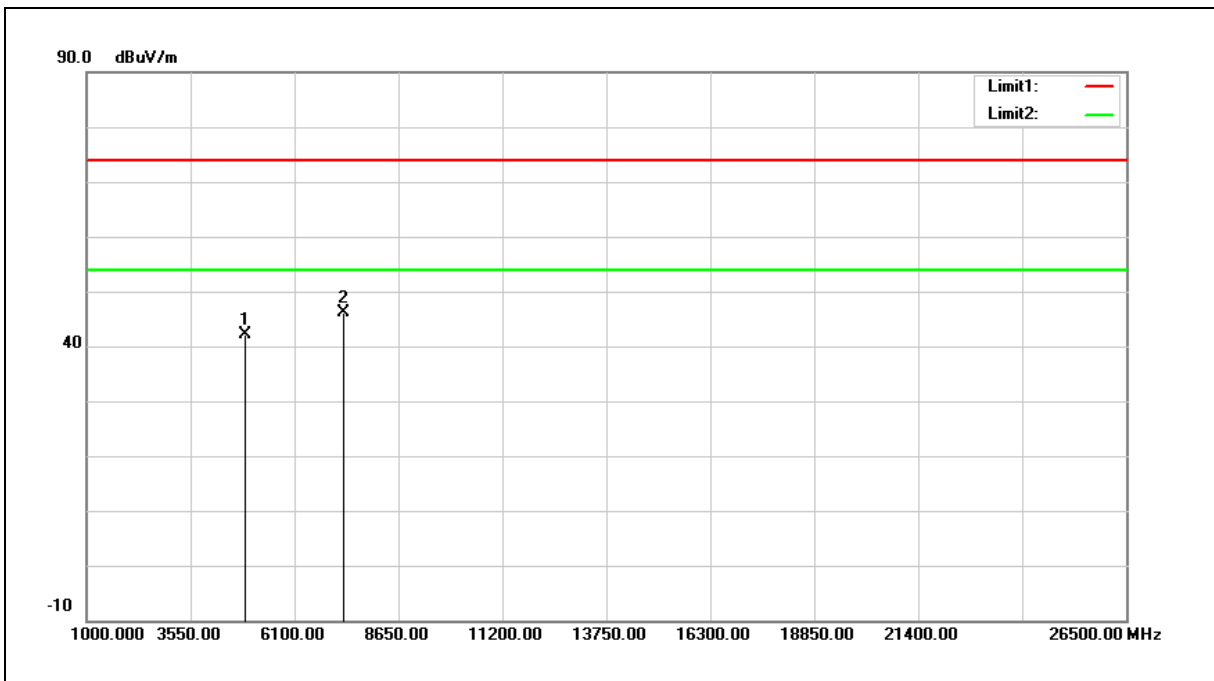

No.	Frequency (MHz)	Reading (dBuV)	Correct Factor (dB/m)	Result (dBuV/m)	Limit (dBuV/m)	Margin (dB)	Remark
1	4882.000	38.00	4.04	42.04	74.00	-31.96	peak
2	7323.000	36.06	10.17	46.23	74.00	-27.77	peak

- Note: 1. Result (dBuV/m) = Correct Factor (dB/m) + Reading(dBuV).  
 2. Correction factor (dB/m) = Antenna Factor (dB/m) + Cable loss (dB) – Pre-Amplifier gain (dB).  
 3. When the peak results are less than average limit, so not need to evaluate the average.



Standard:	FCC Part 15.247	Test Distance:	3 m
Test item:	Harmonic		
Frequency:	2480 MHz		
Mode:	Mode 4		
Ant.Polar.:	Horizontal		

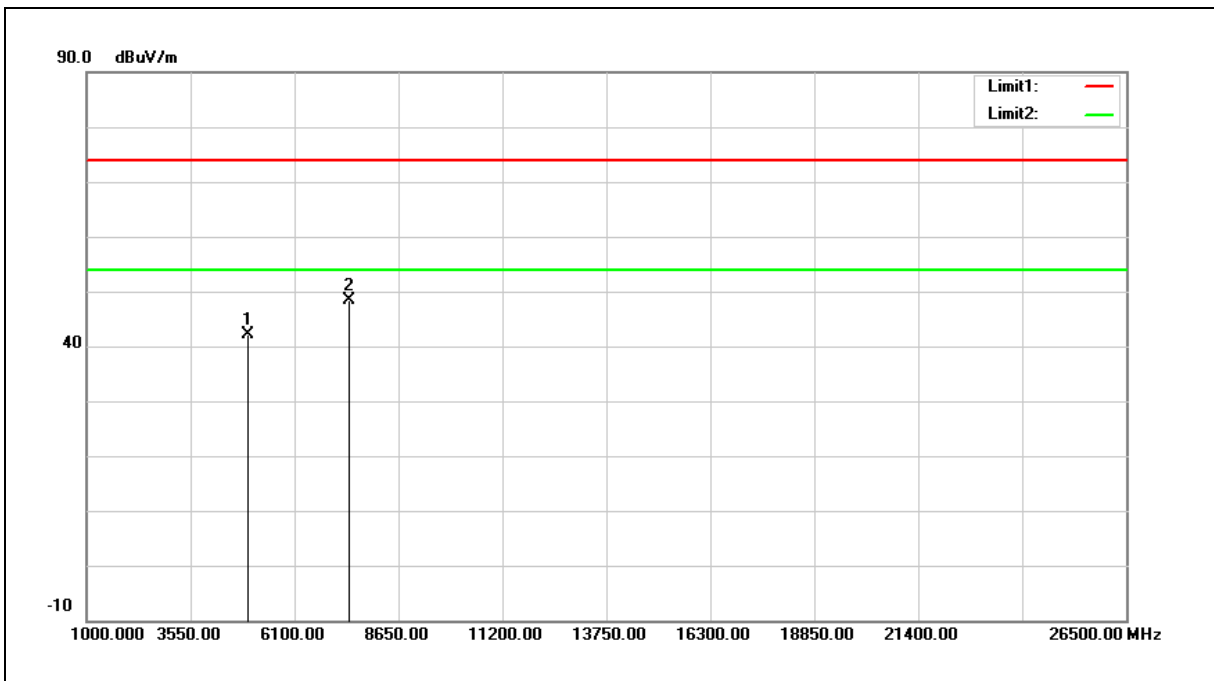

No.	Frequency (MHz)	Reading (dBuV)	Correct Factor (dB/m)	Result (dBuV/m)	Limit (dBuV/m)	Margin (dB)	Remark
1	4960.000	37.73	4.29	42.02	74.00	-31.98	peak
2	7440.000	37.72	10.59	48.31	74.00	-25.69	peak

- Note: 1.Result (dBuV/m) = Correct Factor (dB/m) + Reading(dBuV).  
 2.Correction factor (dB/m) = Antenna Factor (dB/m) + Cable loss (dB) – Pre-Amplifier gain (dB).  
 3.When the peak results are less than average limit, so not need to evaluate the average.





Standard:	FCC Part 15.247	Test Distance:	3 m
Test item:	Harmonic		
Frequency:	2480 MHz		
Mode:	Mode 4		
Ant.Polar.:	Vertical		

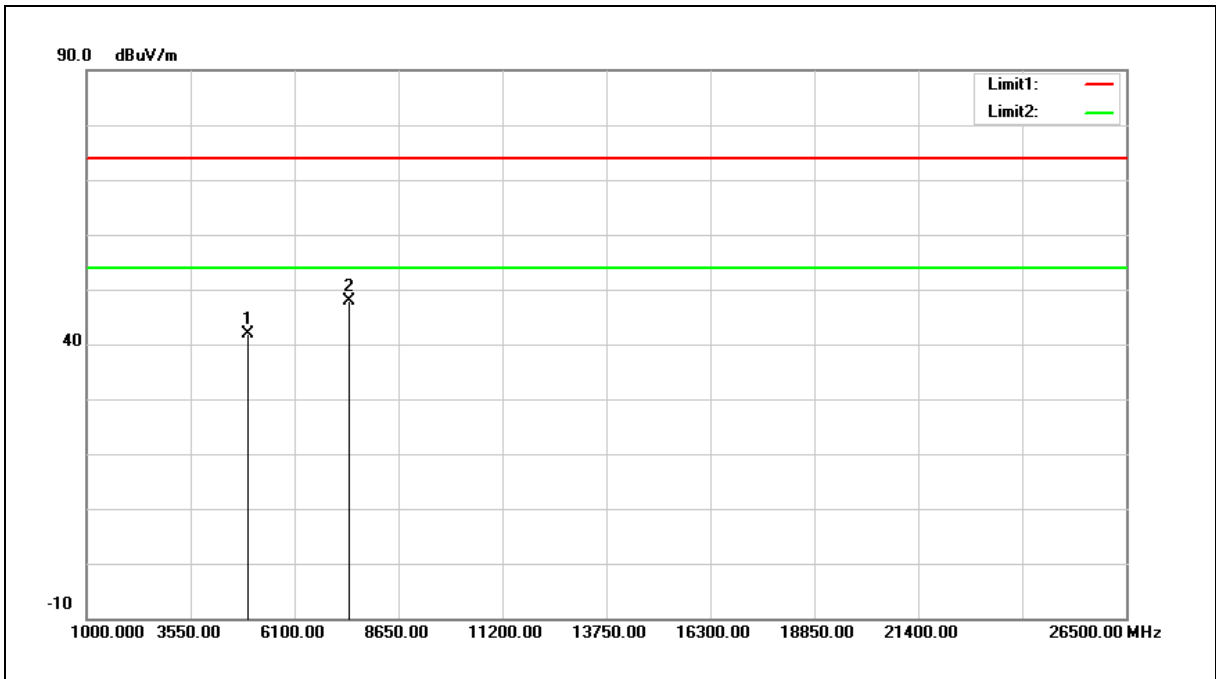

No.	Frequency (MHz)	Reading (dBuV)	Correct Factor (dB/m)	Result (dBuV/m)	Limit (dBuV/m)	Margin (dB)	Remark
1	4960.000	37.67	4.29	41.96	74.00	-32.04	peak
2	7440.000	37.20	10.59	47.79	74.00	-26.21	peak

Note: 1. Result (dBuV/m) = Correct Factor (dB/m) + Reading (dBuV).

2. Correction factor (dB/m) = Antenna Factor (dB/m) + Cable loss (dB) – Pre-Amplifier gain (dB).

3. When the peak results are less than average limit, so not need to evaluate the average.



**Band Edge**

**Peak**

Standard:	FCC Part 15.247	Test Distance:	3 m
Test item:	Band edge		
Frequency:	2402 MHz		
Mode:	Mode 2		
Ant.Polar.:	Horizontal		

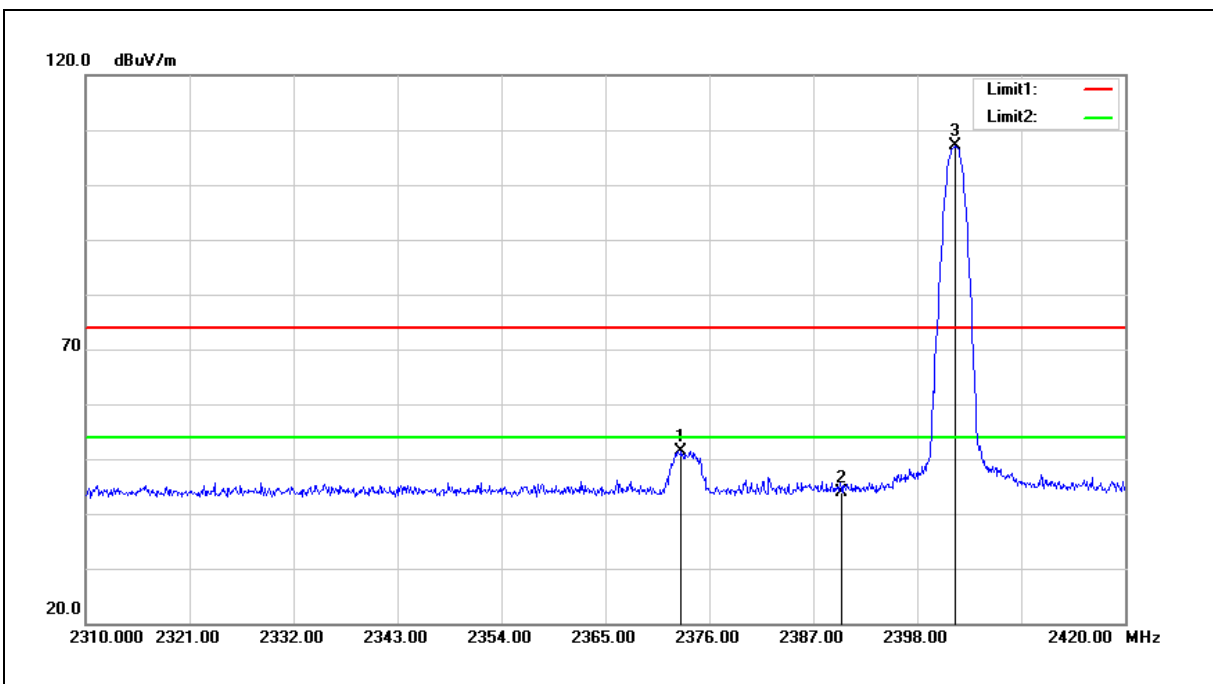

No.	Frequency (MHz)	Reading (dBuV)	Correct Factor (dB/m)	Result (dBuV/m)	Limit (dBuV/m)	Margin (dB)	Remark
1	2373.030	53.79	-2.35	51.44	74.00	-22.56	peak
2	2390.000	46.18	-2.28	43.90	74.00	-30.10	peak
3	2401.960	109.28	-2.23	107.05	--	--	peak

Note:1.Result (dBuV/m) = Correct Factor (dB/m) + Reading(dBuV).

2.Correction factor (dB/m) = Antenna Factor (dB/m) + Cable loss (dB) – Pre-Amplifier gain (dB).

3.When the peak results are less than average limit, so not need to evaluate the average.



Standard:	FCC Part 15.247	Test Distance:	3 m
Test item:	Band edge		
Frequency:	2402 MHz		
Mode:	Mode 2		
Ant.Polar.:	Vertical		

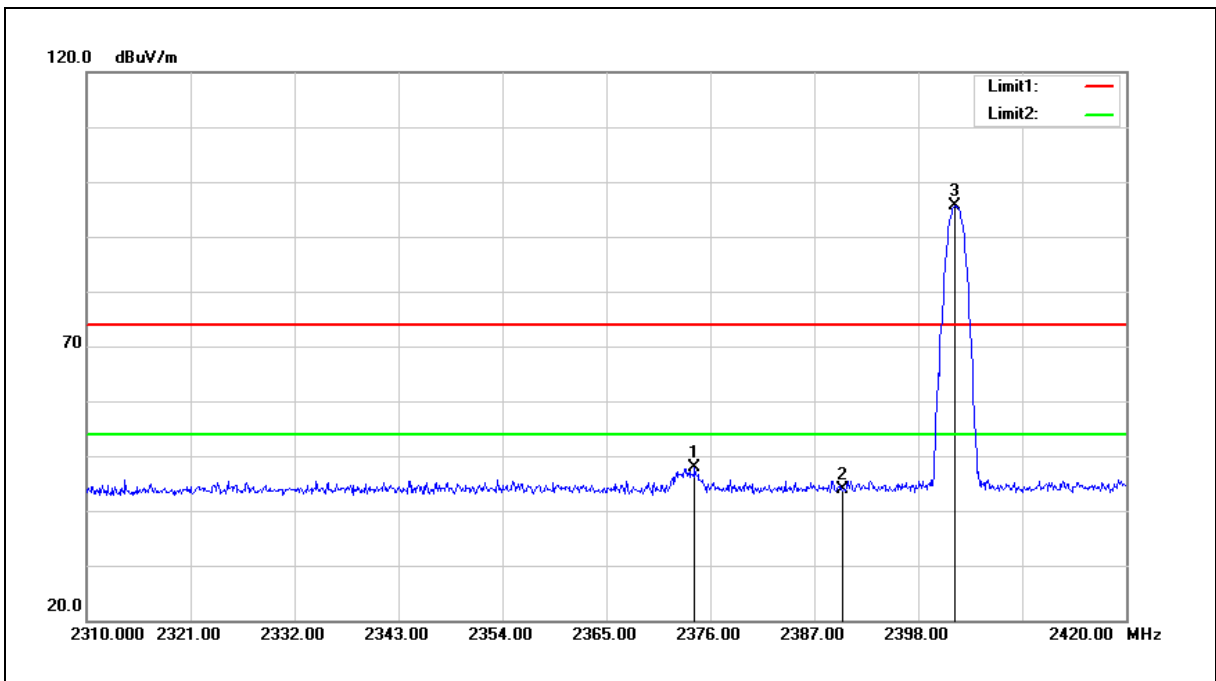

No.	Frequency (MHz)	Reading (dBuV)	Correct Factor (dB/m)	Result (dBuV/m)	Limit (dBuV/m)	Margin (dB)	Remark
1	2374.350	50.10	-2.34	47.76	74.00	-26.24	peak
2	2390.000	46.06	-2.28	43.78	74.00	-30.22	peak
3	2401.850	97.76	-2.23	95.53	--	--	peak

Note:1.Result (dBuV/m) = Correct Factor (dB/m) + Reading(dBuV).

2.Correction factor (dB/m) = Antenna Factor (dB/m) + Cable loss (dB) – Pre-Amplifier gain (dB).

3.When the peak results are less than average limit, so not need to evaluate the average.

Standard:	FCC Part 15.247	Test Distance:	3 m
Test item:	Band edge		
Frequency:	2480 MHz		
Mode:	Mode 2		
Ant.Polar.:	Horizontal		

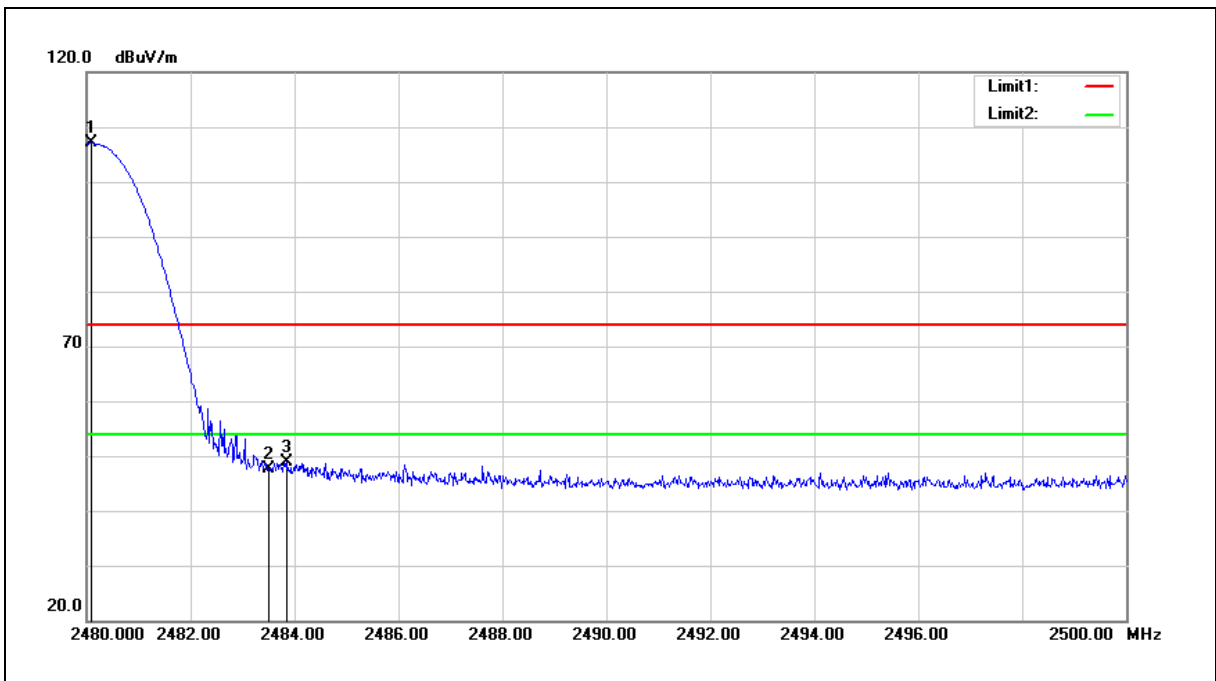

No.	Frequency (MHz)	Reading (dBuV)	Correct Factor (dB/m)	Result (dBuV/m)	Limit (dBuV/m)	Margin (dB)	Remark
1	2480.100	108.97	-1.95	107.02	--	--	peak
2	2483.500	49.66	-1.94	47.72	74.00	-26.28	peak
3	2483.860	50.78	-1.94	48.84	74.00	-25.16	peak

Note:1.Result (dBuV/m) = Correct Factor (dB/m) + Reading(dBuV).

2.Correction factor (dB/m) = Antenna Factor (dB/m) + Cable loss (dB) – Pre-Amplifier gain (dB).

3.When the peak results are less than average limit, so not need to evaluate the average.



Standard:	FCC Part 15.247	Test Distance:	3 m
Test item:	Band edge		
Frequency:	2480 MHz		
Mode:	Mode 2		
Ant.Polar.:	Vertical		

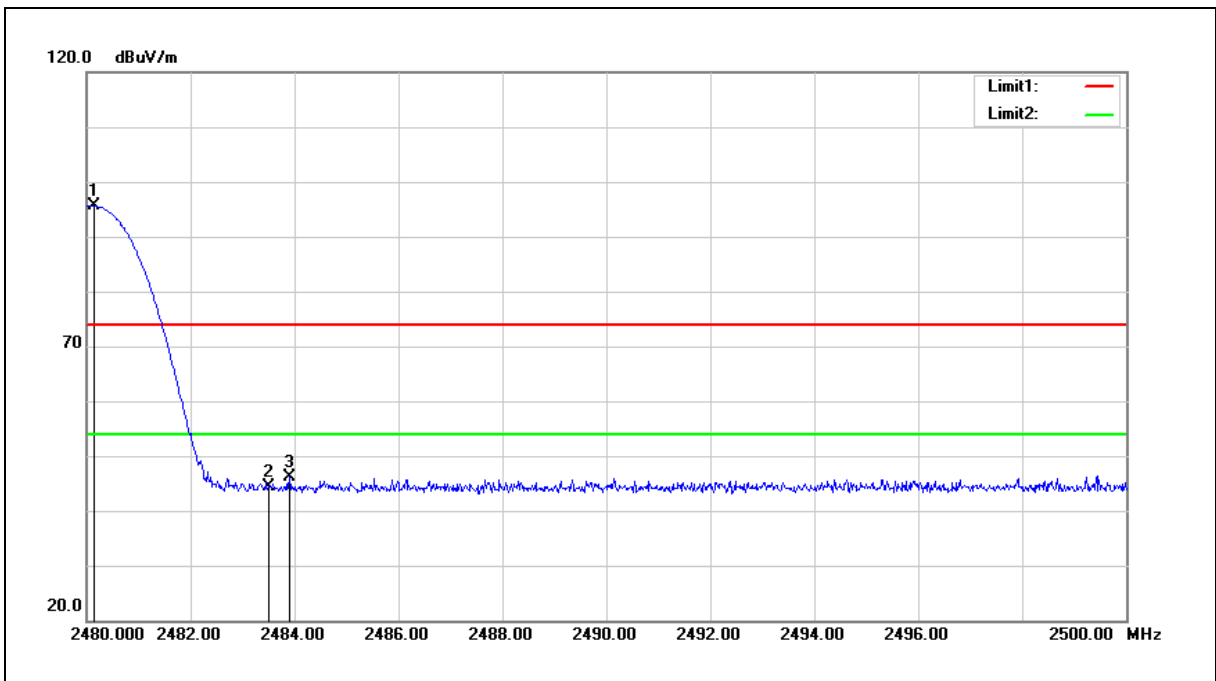

No.	Frequency (MHz)	Reading (dBuV)	Correct Factor (dB/m)	Result (dBuV/m)	Limit (dBuV/m)	Margin (dB)	Remark
1	2480.140	97.59	-1.95	95.64	--	--	peak
2	2483.500	46.25	-1.94	44.31	74.00	-29.69	peak
3	2483.900	48.00	-1.94	46.06	74.00	-27.94	peak

Note:1.Result (dBuV/m) = Correct Factor (dB/m) + Reading(dBuV).

2.Correction factor (dB/m) = Antenna Factor (dB/m) + Cable loss (dB) – Pre-Amplifier gain (dB).

3.When the peak results are less than average limit, so not need to evaluate the average.



Standard:	FCC Part 15.247	Test Distance:	3 m
Test item:	Band edge		
Frequency:	Hopping		
Mode:	Mode 2		
Ant.Polar.:	Horizontal		

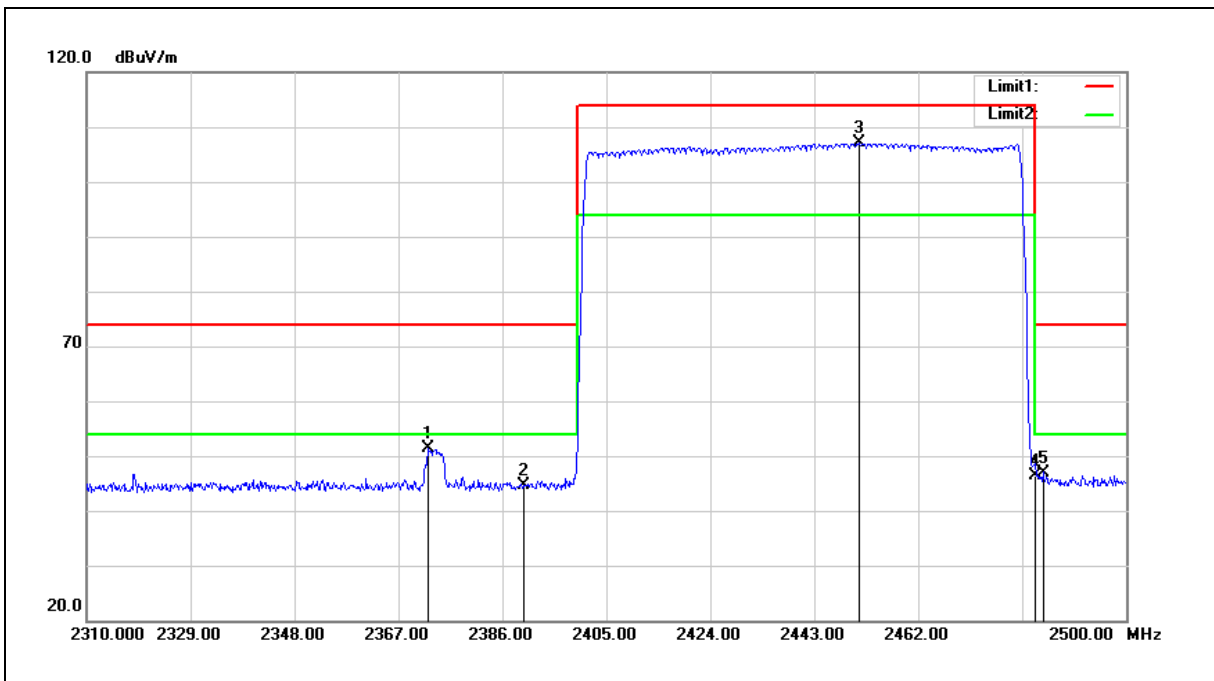

No.	Frequency (MHz)	Reading (dBuV)	Correct Factor (dB/m)	Result (dBuV/m)	Limit (dBuV/m)	Margin (dB)	Remark
1	2372.320	53.70	-2.35	51.35	74.00	-22.65	peak
2	2390.000	46.83	-2.28	44.55	74.00	-29.45	peak
3	2451.170	109.07	-2.06	107.01	--	--	peak
4	2483.500	48.39	-1.94	46.45	74.00	-27.55	peak
5	2484.800	48.92	-1.92	47.00	74.00	-27.00	peak

Note:1.Result (dBuV/m) = Correct Factor (dB/m) + Reading(dBuV).

2.Correction factor (dB/m) = Antenna Factor (dB/m) + Cable loss (dB) – Pre-Amplifier gain (dB).

3.When the peak results are less than average limit, so not need to evaluate the average.



Standard:	FCC Part 15.247	Test Distance:	3 m
Test item:	Band edge		
Frequency:	Hopping		
Mode:	Mode 2		
Ant.Polar.:	Vertical		

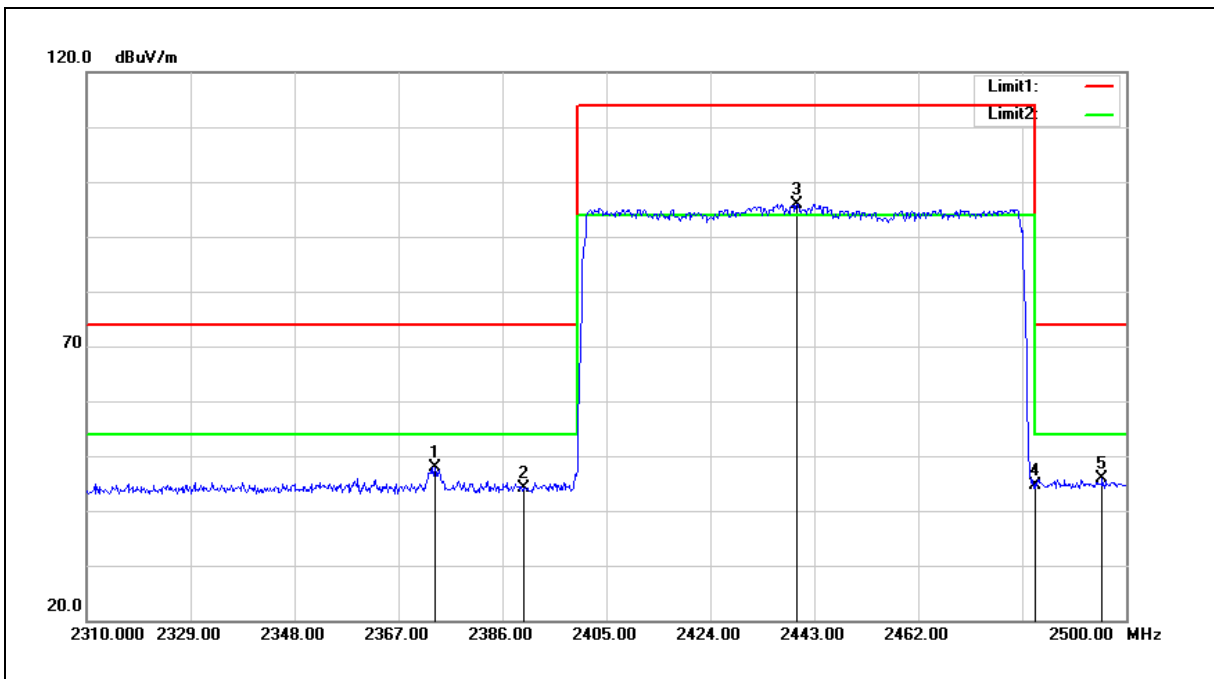

No.	Frequency (MHz)	Reading (dBuV)	Correct Factor (dB/m)	Result (dBuV/m)	Limit (dBuV/m)	Margin (dB)	Remark
1	2373.650	50.28	-2.34	47.94	74.00	-26.06	peak
2	2390.000	46.48	-2.28	44.20	74.00	-29.80	peak
3	2439.770	98.09	-2.10	95.99	--	--	peak
4	2483.500	46.51	-1.94	44.57	74.00	-29.43	peak
5	2495.630	47.81	-1.88	45.93	74.00	-28.07	peak

Note:1.Result (dBuV/m) = Correct Factor (dB/m) + Reading(dBuV).

2.Correction factor (dB/m) = Antenna Factor (dB/m) + Cable loss (dB) – Pre-Amplifier gain (dB).

3.When the peak results are less than average limit, so not need to evaluate the average.



Standard:	FCC Part 15.247	Test Distance:	3 m
Test item:	Band edge		
Frequency:	2402 MHz		
Mode:	Mode 4		
Ant.Polar.:	Horizontal		

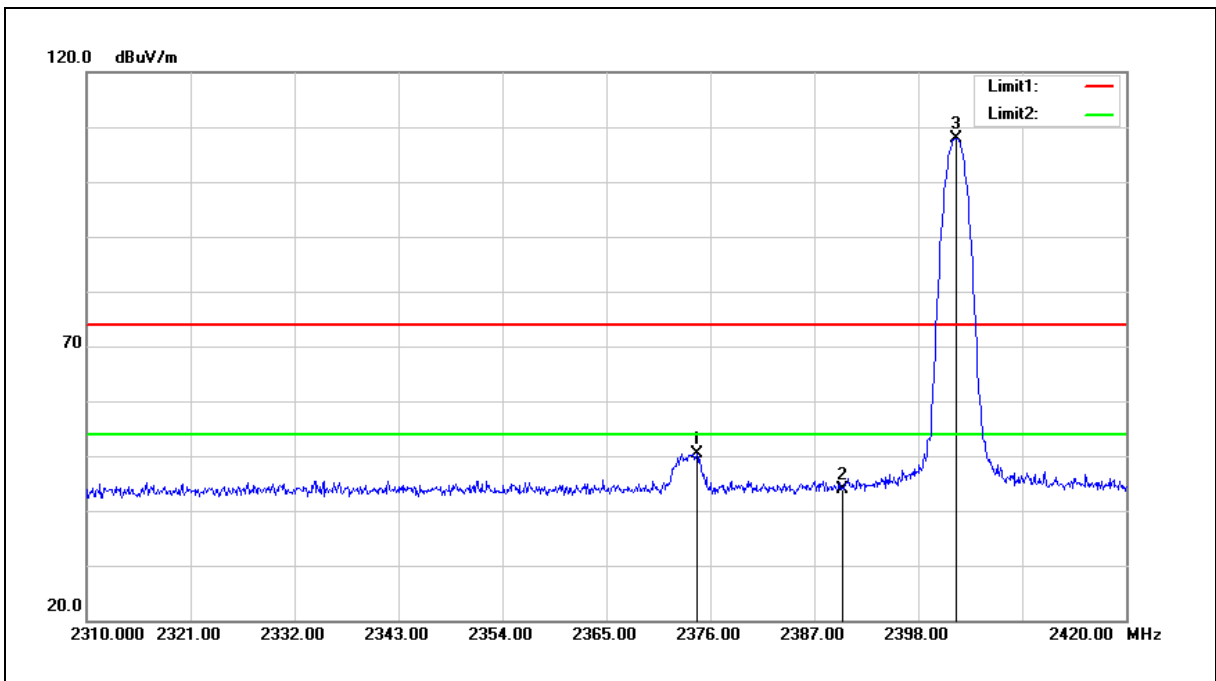

No.	Frequency (MHz)	Reading (dBuV)	Correct Factor (dB/m)	Result (dBuV/m)	Limit (dBuV/m)	Margin (dB)	Remark
1	2374.570	52.76	-2.34	50.42	74.00	-23.58	peak
2	2390.000	46.25	-2.28	43.97	74.00	-30.03	peak
3	2401.960	110.19	-2.23	107.96	--	--	peak

Note:1.Result (dBuV/m) = Correct Factor (dB/m) + Reading(dBuV).

2.Correction factor (dB/m) = Antenna Factor (dB/m) + Cable loss (dB) – Pre-Amplifier gain (dB).

3.When the peak results are less than average limit, so not need to evaluate the average.





Standard:	FCC Part 15.247	Test Distance:	3 m
Test item:	Band edge		
Frequency:	2402 MHz		
Mode:	Mode 4		
Ant.Polar.:	Vertical		

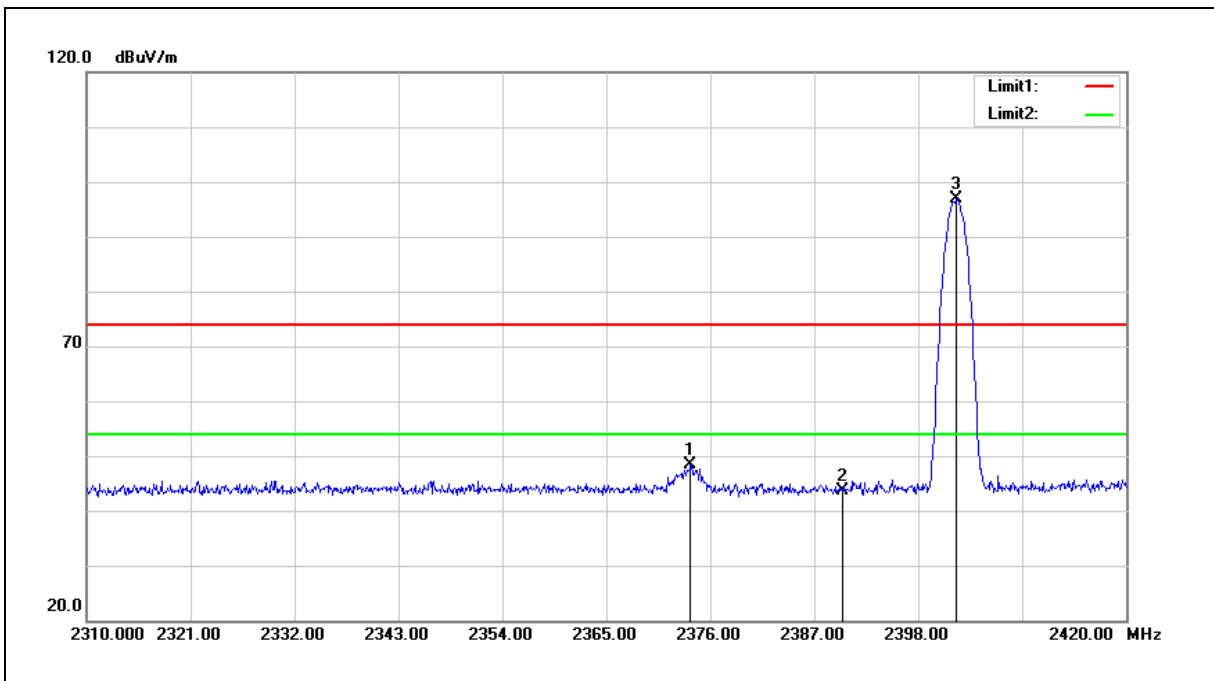

No.	Frequency (MHz)	Reading (dBuV)	Correct Factor (dB/m)	Result (dBuV/m)	Limit (dBuV/m)	Margin (dB)	Remark
1	2373.910	50.82	-2.34	48.48	74.00	-25.52	peak
2	2390.000	45.94	-2.28	43.66	74.00	-30.34	peak
3	2402.070	99.08	-2.23	96.85	--	--	peak

Note:1.Result (dBuV/m) = Correct Factor (dB/m) + Reading(dBuV).

2.Correction factor (dB/m) = Antenna Factor (dB/m) + Cable loss (dB) – Pre-Amplifier gain (dB).

3.When the peak results are less than average limit, so not need to evaluate the average.

Standard:	FCC Part 15.247	Test Distance:	3 m
Test item:	Band edge		
Frequency:	2480 MHz		
Mode:	Mode 4		
Ant.Polar.:	Horizontal		

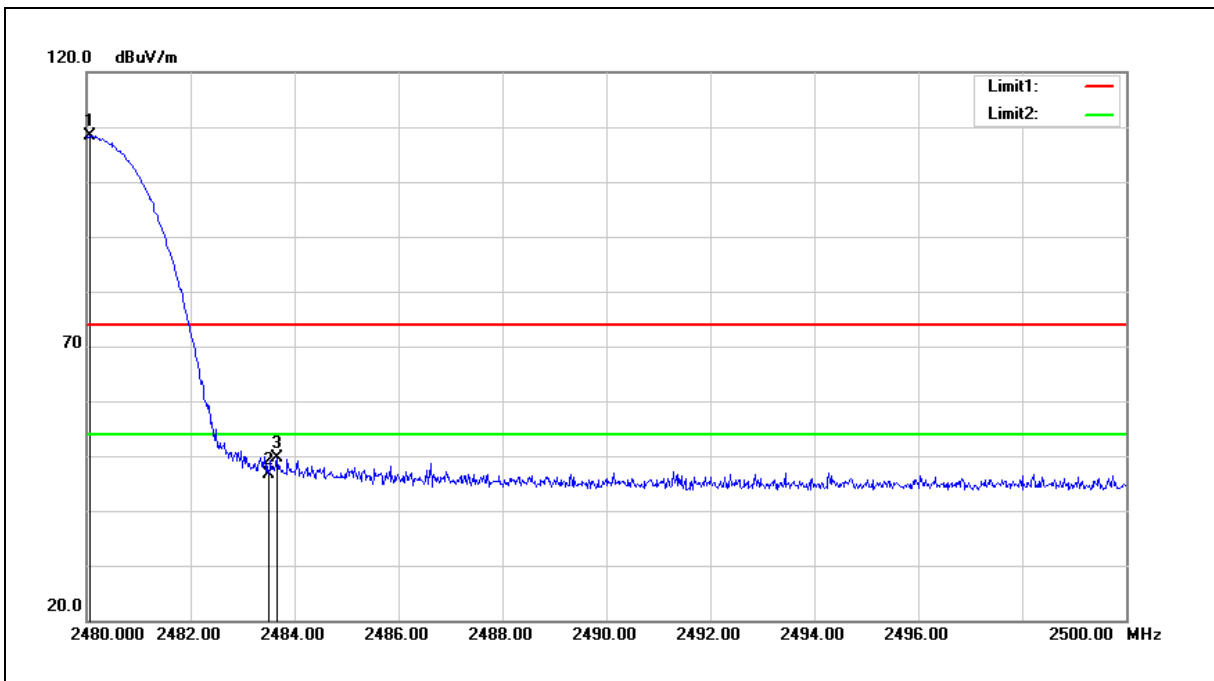

No.	Frequency (MHz)	Reading (dBuV)	Correct Factor (dB/m)	Result (dBuV/m)	Limit (dBuV/m)	Margin (dB)	Remark
1	2480.060	110.44	-1.95	108.49	--	--	peak
2	2483.500	48.60	-1.94	46.66	74.00	-27.34	peak
3	2483.660	51.64	-1.94	49.70	74.00	-24.30	peak

Note:1.Result (dBuV/m) = Correct Factor (dB/m) + Reading(dBuV).

2.Correction factor (dB/m) = Antenna Factor (dB/m) + Cable loss (dB) – Pre-Amplifier gain (dB).

3.When the peak results are less than average limit, so not need to evaluate the average.



Standard:	FCC Part 15.247	Test Distance:	3 m
Test item:	Band edge		
Frequency:	2480 MHz		
Mode:	Mode 4		
Ant.Polar.:	Vertical		

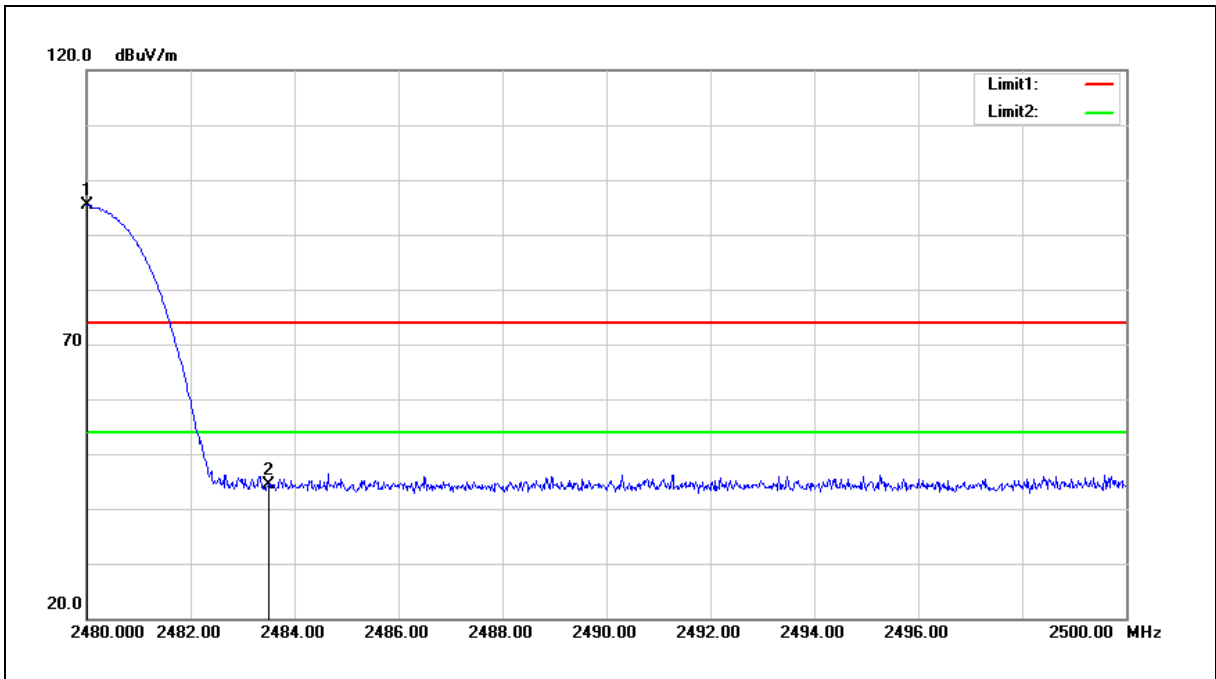

No.	Frequency (MHz)	Reading (dBuV)	Correct Factor (dB/m)	Result (dBuV/m)	Limit (dBuV/m)	Margin (dB)	Remark
1	2480.000	97.38	-1.95	95.43	--	--	peak
2	2483.500	46.43	-1.94	44.49	74.00	-29.51	peak

Note: 1. Result (dBuV/m) = Correct Factor (dB/m) + Reading(dBuV).

2. Correction factor (dB/m) = Antenna Factor (dB/m) + Cable loss (dB) – Pre-Amplifier gain (dB).

3. When the peak results are less than average limit, so not need to evaluate the average.



Standard:	FCC Part 15.247	Test Distance:	3 m
Test item:	Band edge		
Frequency:	Hopping		
Mode:	Mode 4		
Ant.Polar.:	Horizontal		

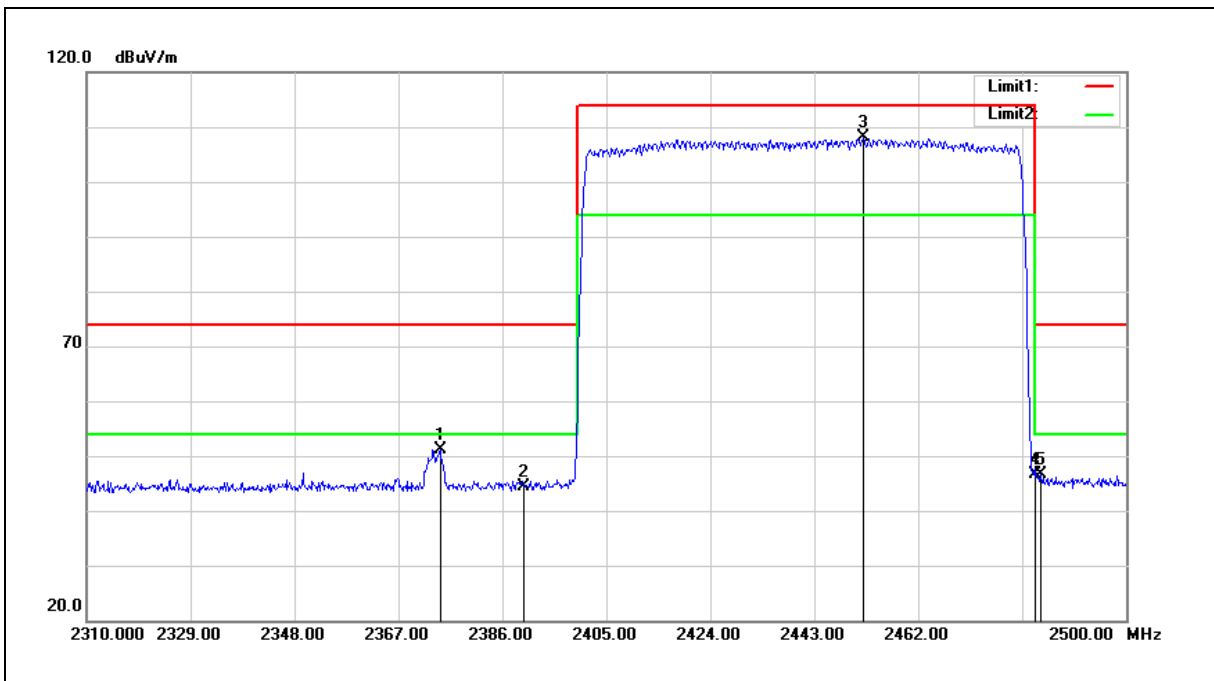

No.	Frequency (MHz)	Reading (dBuV)	Correct Factor (dB/m)	Result (dBuV/m)	Limit (dBuV/m)	Margin (dB)	Remark
1	2374.600	53.40	-2.34	51.06	74.00	-22.94	peak
2	2390.000	46.75	-2.28	44.47	74.00	-29.53	peak
3	2451.930	110.14	-2.05	108.09	--	--	peak
4	2483.500	48.49	-1.94	46.55	74.00	-27.45	peak
5	2484.420	48.62	-1.92	46.70	74.00	-27.30	peak

Note:1.Result (dBuV/m) = Correct Factor (dB/m) + Reading(dBuV).

2.Correction factor (dB/m) = Antenna Factor (dB/m) + Cable loss (dB) – Pre-Amplifier gain (dB).

3.When the peak results are less than average limit, so not need to evaluate the average.



Standard:	FCC Part 15.247	Test Distance:	3 m
Test item:	Band edge		
Frequency:	Hopping		
Mode:	Mode 4		
Ant.Polar.:	Vertical		

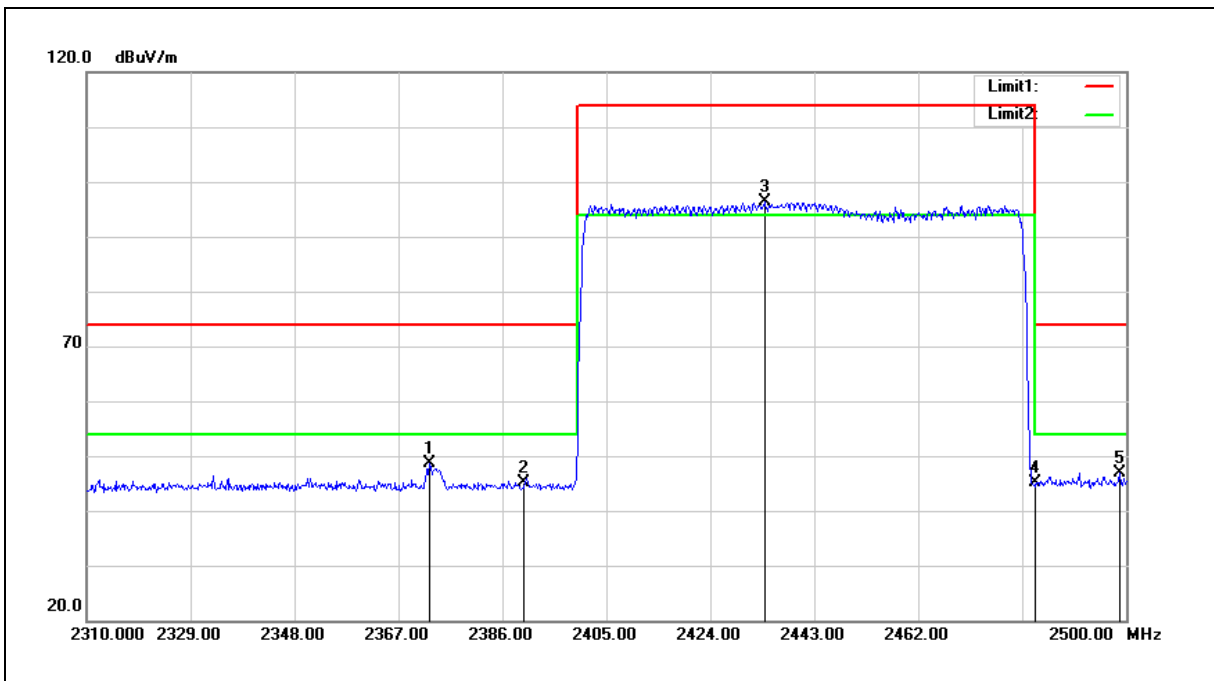

No.	Frequency (MHz)	Reading (dBuV)	Correct Factor (dB/m)	Result (dBuV/m)	Limit (dBuV/m)	Margin (dB)	Remark
1	2372.700	50.88	-2.35	48.53	74.00	-25.47	peak
2	2390.000	47.31	-2.28	45.03	74.00	-28.97	peak
3	2433.880	98.49	-2.12	96.37	--	--	peak
4	2483.500	47.11	-1.94	45.17	74.00	-28.83	peak
5	2498.860	48.77	-1.87	46.90	74.00	-27.10	peak

Note:1.Result (dBuV/m) = Correct Factor (dB/m) + Reading(dBuV).

2.Correction factor (dB/m) = Antenna Factor (dB/m) + Cable loss (dB) – Pre-Amplifier gain (dB).

3.When the peak results are less than average limit, so not need to evaluate the average.



**Average**

Standard:	FCC Part 15.247	Test Distance:	3 m
Test item:	Band edge		
Frequency:	2402 MHz		
Mode:	Mode 2		
Ant.Polar.:	Horizontal		

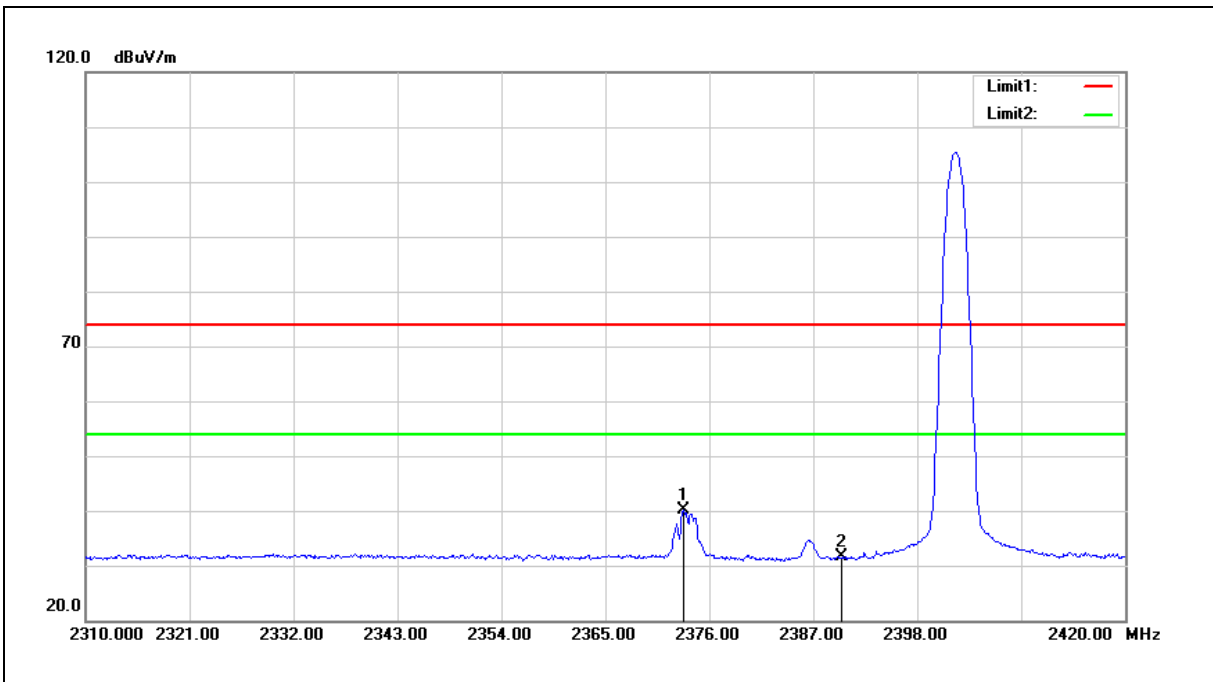

No.	Frequency (MHz)	Reading (dBuV)	Correct Factor (dB/m)	Result (dBuV/m)	Limit (dBuV/m)	Margin (dB)	Remark
1	2373.250	42.46	-2.34	40.12	54.00	-13.88	AVG
2	2390.000	33.96	-2.28	31.68	54.00	-22.32	AVG

Note:1.Result (dBuV/m) = Correct Factor (dB/m) + Reading(dBuV).

2.Correction factor (dB/m) = Antenna Factor (dB/m) + Cable loss (dB) – Pre-Amplifier gain (dB).

3.When the peak results are less than average limit, so not need to evaluate the average.



Standard:	FCC Part 15.247	Test Distance:	3 m
Test item:	Band edge		
Frequency:	2402 MHz		
Mode:	Mode 2		
Ant.Polar.:	Vertical		

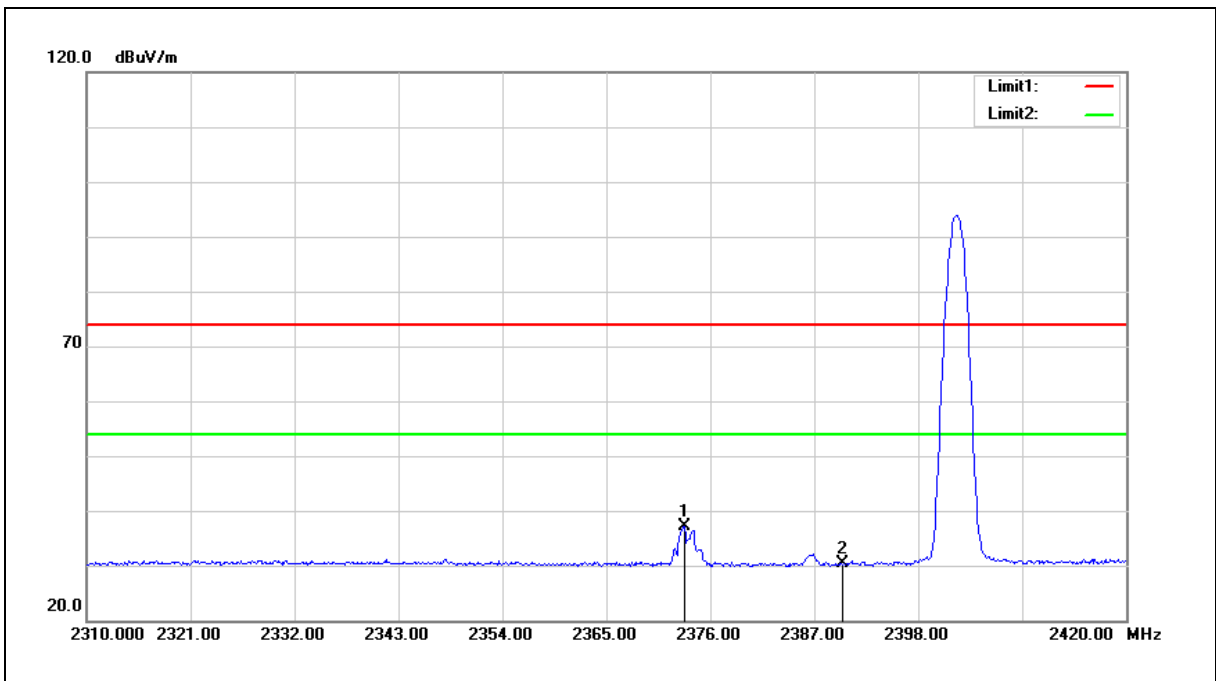

No.	Frequency (MHz)	Reading (dBuV)	Correct Factor (dB/m)	Result (dBuV/m)	Limit (dBuV/m)	Margin (dB)	Remark
1	2373.250	39.55	-2.34	37.21	54.00	-16.79	AVG
2	2390.000	32.54	-2.28	30.26	54.00	-23.74	AVG

- Note: 1.Result (dBuV/m) = Correct Factor (dB/m) + Reading(dBuV).
- 2.Correction factor (dB/m) = Antenna Factor (dB/m) + Cable loss (dB) – Pre-Amplifier gain (dB).
- 3.When the peak results are less than average limit, so not need to evaluate the average.



Standard:	FCC Part 15.247	Test Distance:	3 m
Test item:	Band edge		
Frequency:	2480 MHz		
Mode:	Mode 2		
Ant.Polar.:	Horizontal		

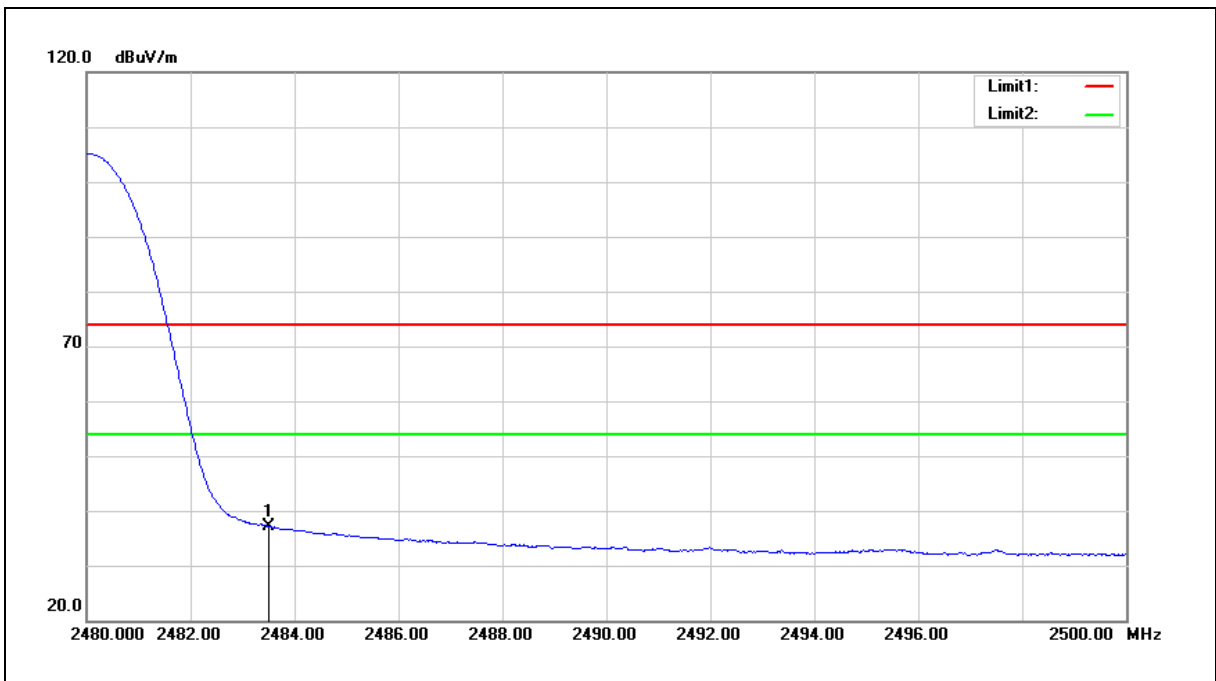

No.	Frequency (MHz)	Reading (dBuV)	Correct Factor (dB/m)	Result (dBuV/m)	Limit (dBuV/m)	Margin (dB)	Remark
1	2483.500	39.17	-1.94	37.23	54.00	-16.77	AVG

Note:1.Result (dBuV/m) = Correct Factor (dB/m) + Reading(dBuV).

2.Correction factor (dB/m) = Antenna Factor (dB/m) + Cable loss (dB) – Pre-Amplifier gain (dB).

3.When the peak results are less than average limit, so not need to evaluate the average.





Standard:	FCC Part 15.247	Test Distance:	3 m
Test item:	Band edge		
Frequency:	2480 MHz		
Mode:	Mode 2		
Ant.Polar.:	Vertical		

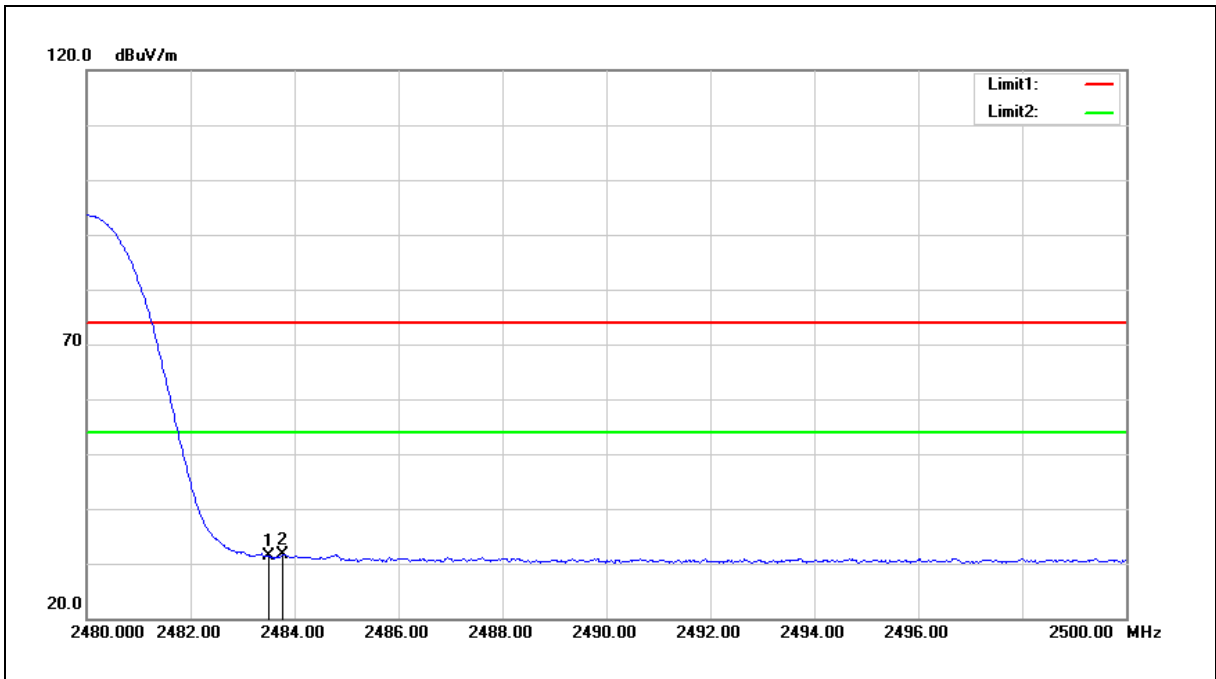

No.	Frequency (MHz)	Reading (dBuV)	Correct Factor (dB/m)	Result (dBuV/m)	Limit (dBuV/m)	Margin (dB)	Remark
1	2483.500	33.31	-1.94	31.37	54.00	-22.63	AVG
2	2483.780	33.67	-1.94	31.73	54.00	-22.27	AVG

Note: 1. Result (dBuV/m) = Correct Factor (dB/m) + Reading(dBuV).

2. Correction factor (dB/m) = Antenna Factor (dB/m) + Cable loss (dB) – Pre-Amplifier gain (dB).

3. When the peak results are less than average limit, so not need to evaluate the average.



Standard:	FCC Part 15.247	Test Distance:	3 m
Test item:	Band edge		
Frequency:	Hopping		
Mode:	Mode 2		
Ant.Polar.:	Horizontal		

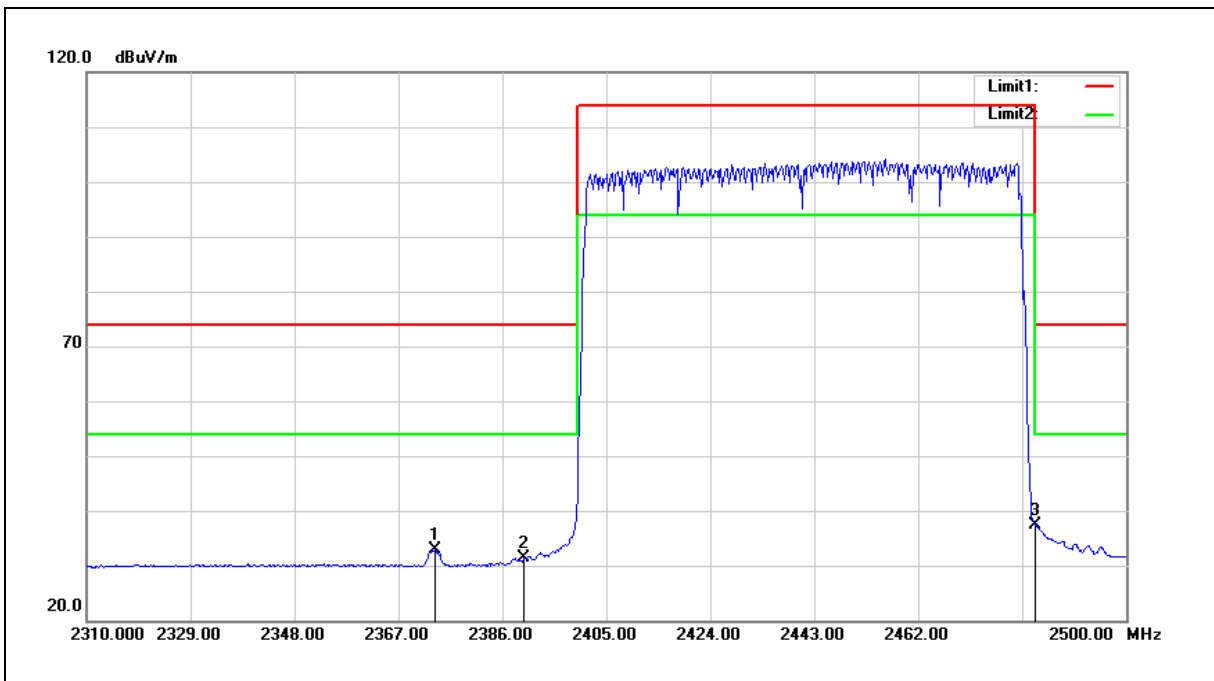

No.	Frequency (MHz)	Reading (dBuV)	Correct Factor (dB/m)	Result (dBuV/m)	Limit (dBuV/m)	Margin (dB)	Remark
1	2373.650	35.20	-2.34	32.86	54.00	-21.14	AVG
2	2390.000	33.55	-2.28	31.27	54.00	-22.73	AVG
3	2483.500	39.31	-1.94	37.37	54.00	-16.63	AVG

Note:1.Result (dBuV/m) = Correct Factor (dB/m) + Reading(dBuV).

2.Correction factor (dB/m) = Antenna Factor (dB/m) + Cable loss (dB) – Pre-Amplifier gain (dB).

3.When the peak results are less than average limit, so not need to evaluate the average.



Standard:	FCC Part 15.247	Test Distance:	3 m
Test item:	Band edge		
Frequency:	Hopping		
Mode:	Mode 2		
Ant.Polar.:	Vertical		

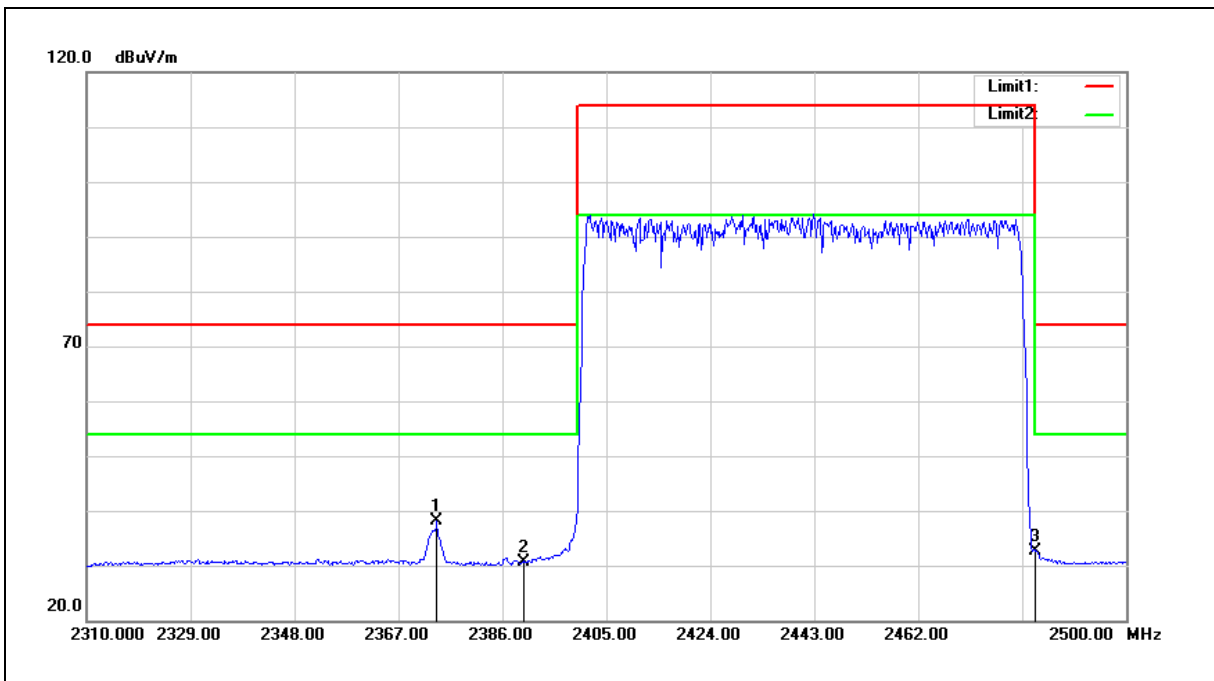

No.	Frequency (MHz)	Reading (dBuV)	Correct Factor (dB/m)	Result (dBuV/m)	Limit (dBuV/m)	Margin (dB)	Remark
1	2374.030	40.46	-2.34	38.12	54.00	-15.88	AVG
2	2390.000	32.92	-2.28	30.64	54.00	-23.36	AVG
3	2483.500	34.62	-1.94	32.68	54.00	-21.32	AVG

Note:1.Result (dBuV/m) = Correct Factor (dB/m) + Reading(dBuV).

2.Correction factor (dB/m) = Antenna Factor (dB/m) + Cable loss (dB) – Pre-Amplifier gain (dB).

3.When the peak results are less than average limit, so not need to evaluate the average.



Standard:	FCC Part 15.247	Test Distance:	3 m
Test item:	Band edge		
Frequency:	2402 MHz		
Mode:	Mode 4		
Ant.Polar.:	Horizontal		

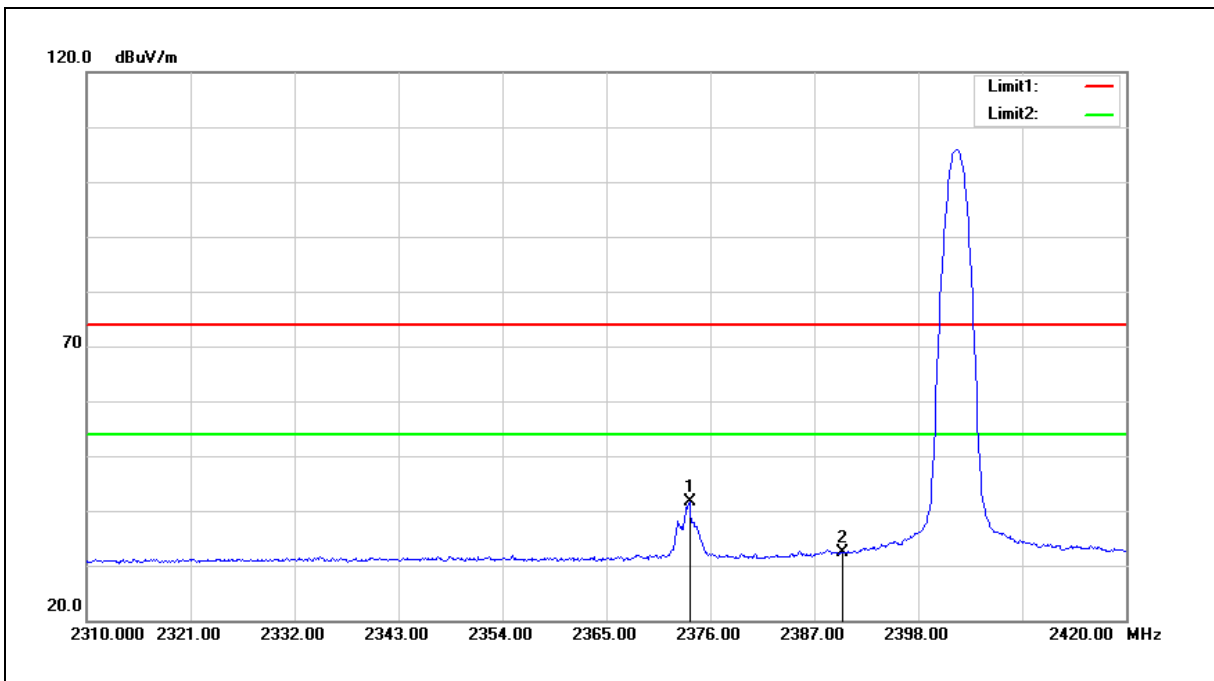

No.	Frequency (MHz)	Reading (dBuV)	Correct Factor (dB/m)	Result (dBuV/m)	Limit (dBuV/m)	Margin (dB)	Remark
1	2373.800	44.01	-2.34	41.67	54.00	-12.33	AVG
2	2390.000	34.65	-2.28	32.37	54.00	-21.63	AVG

Note: 1. Result (dBuV/m) = Correct Factor (dB/m) + Reading(dBuV).

2. Correction factor (dB/m) = Antenna Factor (dB/m) + Cable loss (dB) – Pre-Amplifier gain (dB).

3. When the peak results are less than average limit, so not need to evaluate the average.



Standard:	FCC Part 15.247	Test Distance:	3 m
Test item:	Band edge		
Frequency:	2402 MHz		
Mode:	Mode 4		
Ant.Polar.:	Vertical		

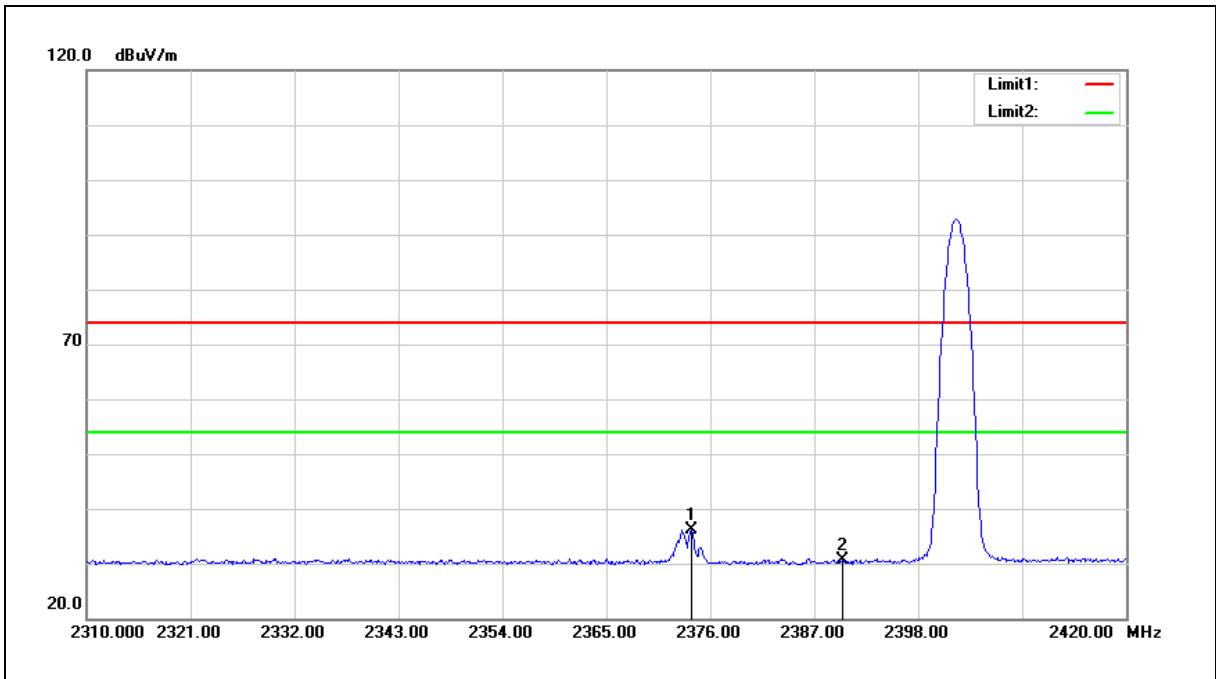

No.	Frequency (MHz)	Reading (dBuV)	Correct Factor (dB/m)	Result (dBuV/m)	Limit (dBuV/m)	Margin (dB)	Remark
1	2374.020	38.52	-2.34	36.18	54.00	-17.82	AVG
2	2390.000	32.80	-2.28	30.52	54.00	-23.48	AVG

- Note: 1. Result (dBuV/m) = Correct Factor (dB/m) + Reading(dBuV).
2. Correction factor (dB/m) = Antenna Factor (dB/m) + Cable loss (dB) – Pre-Amplifier gain (dB).
3. When the peak results are less than average limit, so not need to evaluate the average.



Standard:	FCC Part 15.247	Test Distance:	3 m
Test item:	Band edge		
Frequency:	2480 MHz		
Mode:	Mode 4		
Ant.Polar.:	Horizontal		

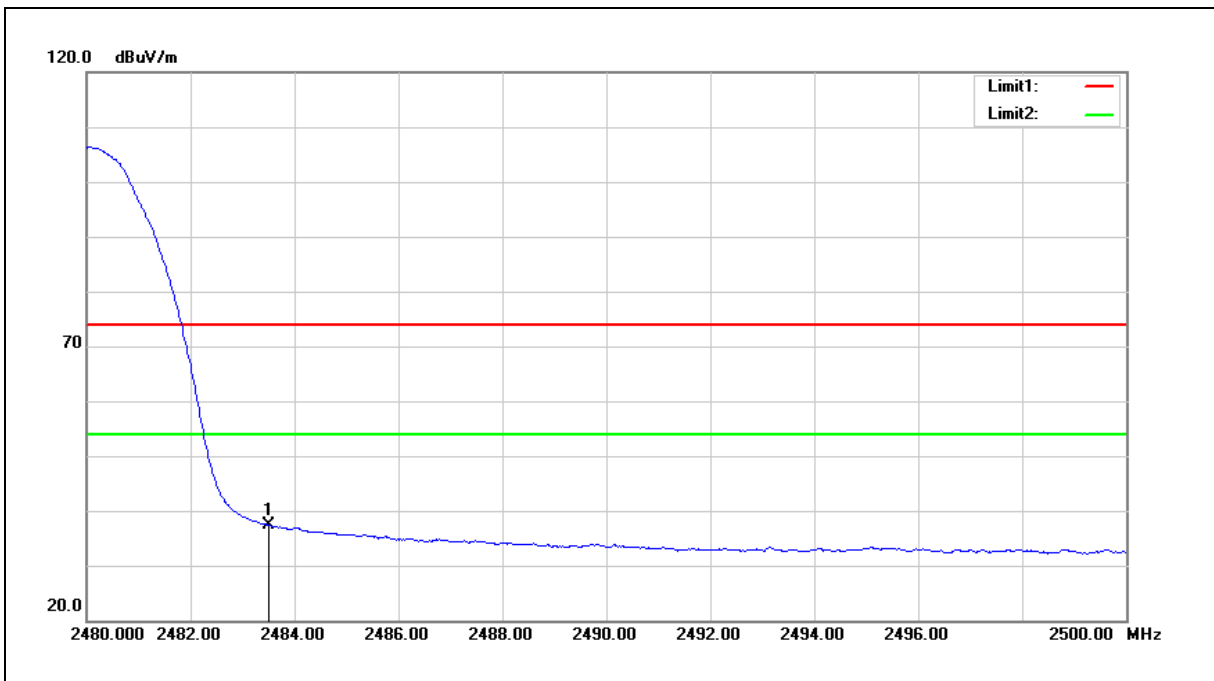

No.	Frequency (MHz)	Reading (dBuV)	Correct Factor (dB/m)	Result (dBuV/m)	Limit (dBuV/m)	Margin (dB)	Remark
1	2483.500	39.30	-1.94	37.36	54.00	-16.64	AVG

- Note: 1.Result (dBuV/m) = Correct Factor (dB/m) + Reading(dBuV).
- 2.Correction factor (dB/m) = Antenna Factor (dB/m) + Cable loss (dB) – Pre-Amplifier gain (dB).
- 3.When the peak results are less than average limit, so not need to evaluate the average.



Standard:	FCC Part 15.247	Test Distance:	3 m
Test item:	Band edge		
Frequency:	2480 MHz		
Mode:	Mode 4		
Ant.Polar.:	Vertical		

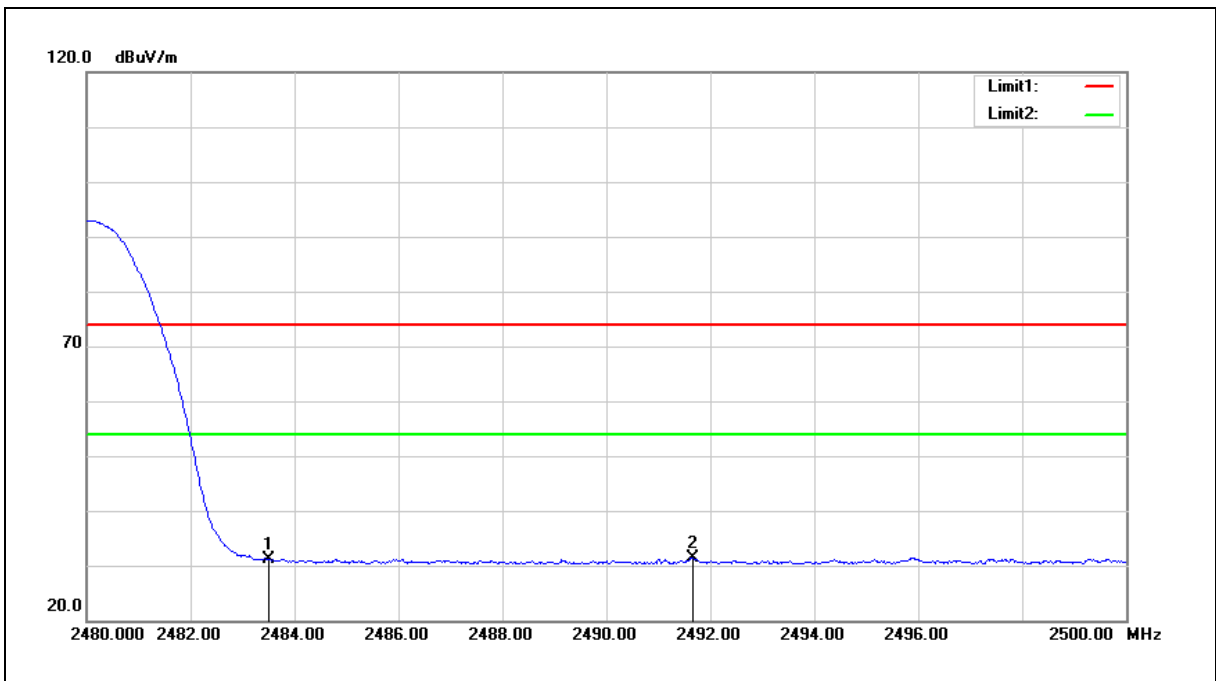

No.	Frequency (MHz)	Reading (dBuV)	Correct Factor (dB/m)	Result (dBuV/m)	Limit (dBuV/m)	Margin (dB)	Remark
1	2483.500	33.03	-1.94	31.09	54.00	-22.91	AVG
2	2491.660	33.32	-1.90	31.42	54.00	-22.58	AVG

Note: 1. Result (dBuV/m) = Correct Factor (dB/m) + Reading(dBuV).

2. Correction factor (dB/m) = Antenna Factor (dB/m) + Cable loss (dB) – Pre-Amplifier gain (dB).

3. When the peak results are less than average limit, so not need to evaluate the average.



Standard:	FCC Part 15.247	Test Distance:	3 m
Test item:	Band edge		
Frequency:	Hopping		
Mode:	Mode 4		
Ant.Polar.:	Horizontal		

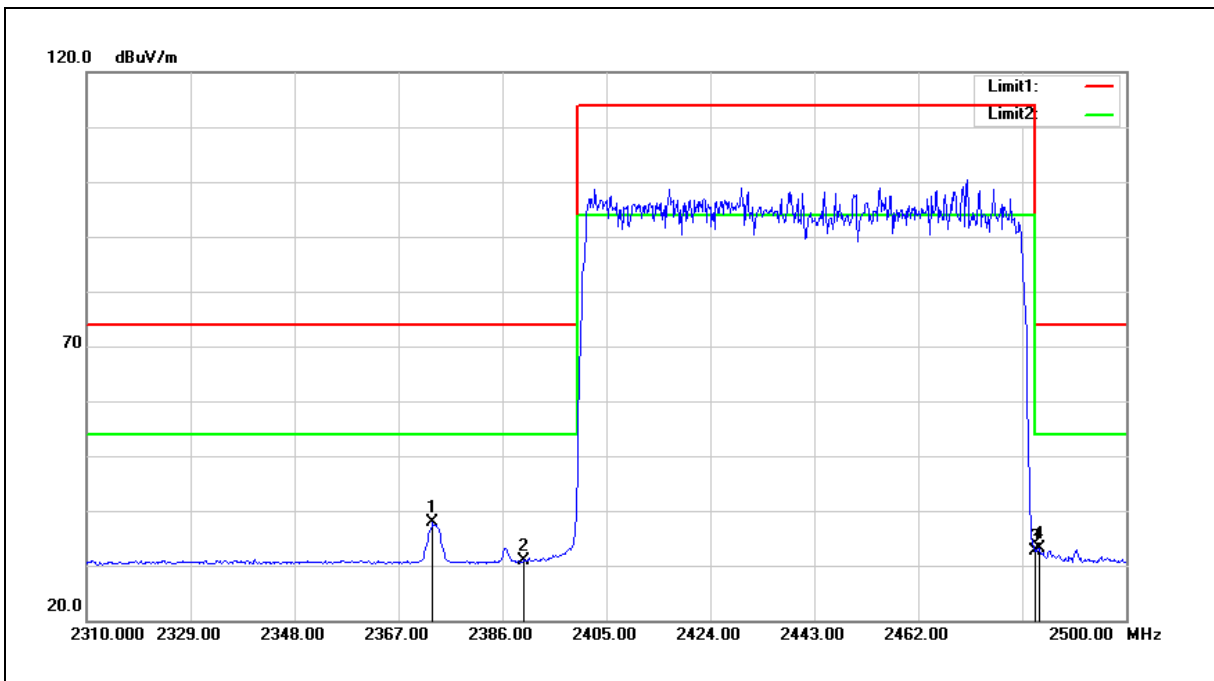

No.	Frequency (MHz)	Reading (dBuV)	Correct Factor (dB/m)	Result (dBuV/m)	Limit (dBuV/m)	Margin (dB)	Remark
1	2373.270	40.13	-2.34	37.79	54.00	-16.21	AVG
2	2390.000	33.19	-2.28	30.91	54.00	-23.09	AVG
3	2483.500	34.55	-1.94	32.61	54.00	-21.39	AVG
4	2484.230	35.14	-1.92	33.22	54.00	-20.78	AVG

Note:1.Result (dBuV/m) = Correct Factor (dB/m) + Reading(dBuV).

2.Correction factor (dB/m) = Antenna Factor (dB/m) + Cable loss (dB) – Pre-Amplifier gain (dB).

3.When the peak results are less than average limit, so not need to evaluate the average.





Standard:	FCC Part 15.247	Test Distance:	3 m
Test item:	Band edge		
Frequency:	Hopping		
Mode:	Mode 4		
Ant.Polar.:	Vertical		

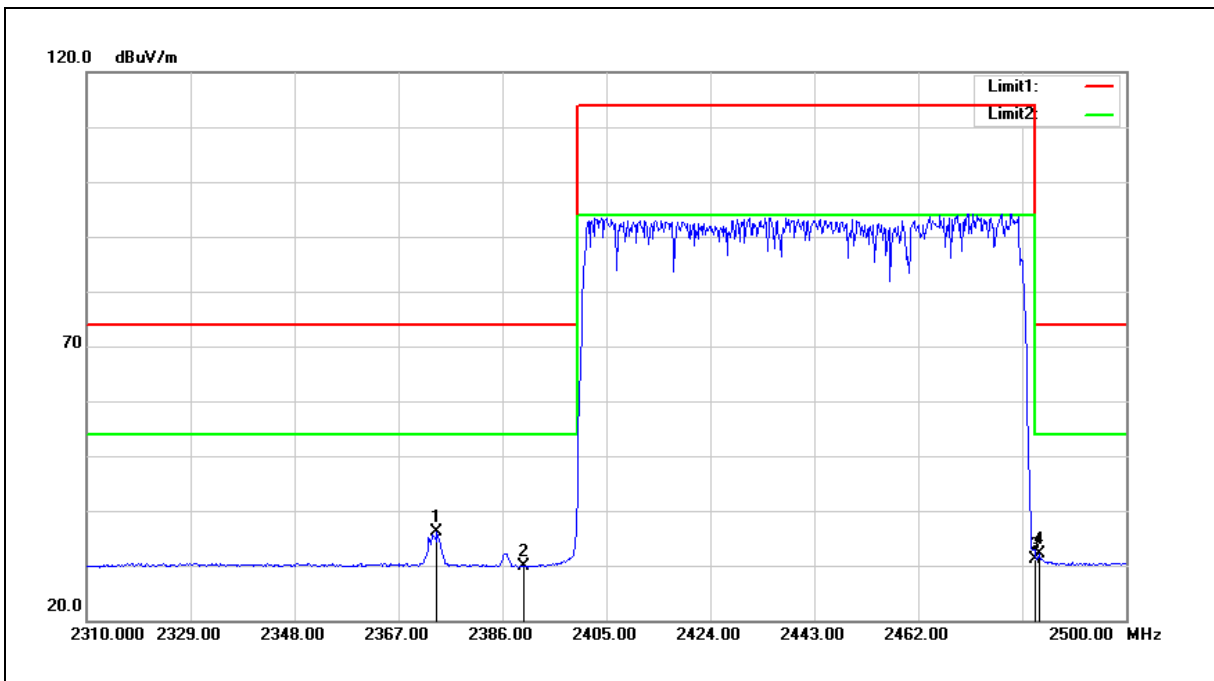

No.	Frequency (MHz)	Reading (dBuV)	Correct Factor (dB/m)	Result (dBuV/m)	Limit (dBuV/m)	Margin (dB)	Remark
1	2374.030	38.37	-2.34	36.03	54.00	-17.97	AVG
2	2390.000	32.05	-2.28	29.77	54.00	-24.23	AVG
3	2483.500	33.14	-1.94	31.20	54.00	-22.80	AVG
4	2484.230	34.16	-1.92	32.24	54.00	-21.76	AVG

Note: 1. Result (dBuV/m) = Correct Factor (dB/m) + Reading (dBuV).

2. Correction factor (dB/m) = Antenna Factor (dB/m) + Cable loss (dB) – Pre-Amplifier gain (dB).

3. When the peak results are less than average limit, so not need to evaluate the average.



## 6 EUT Photos

Please refer to the document number: 21-1180\_FCC\_External Photos and 21-1180\_FCC\_Internal Photos.

---END---