

FCC Test Report (Co-Located)

Report No.: RF180713C31-6

FCC ID: H8N-RTL0102VW

Test Model: TM-RTL0102

Received Date: Jul. 13, 2018

Test Date: Oct. 18, 2018

Issued Date: Oct. 19, 2018

Applicant: ASKEY COMPUTER CORP.

Address: 10F, NO. 119, JIANKANG RD., ZHONGHE DIST., NEW TAIPEI CITY
23585, TAIWAN, R.O.C.

Issued By: Bureau Veritas Consumer Products Services (H.K.) Ltd., Taoyuan Branch

Lab Address: No. 47-2, 14th Ling, Chia Pau Vil., Lin Kou Dist., New Taipei City, Taiwan
(R.O.C.)

Test Location: No. 19, Hwa Ya 2nd Rd., Wen Hwa Vil., Kwei Shan Dist., Taoyuan City
33383, TAIWAN (R.O.C.)

**FCC Registration /
Designation Number:** 788550 / TW0003



This report is for your exclusive use. Any copying or replication of this report to or for any other person or entity, or use of our name or trademark, is permitted only with our prior written permission. This report sets forth our findings solely with respect to the test samples identified herein. The results set forth in this report are not indicative or representative of the quality or characteristics of the lot from which a test sample was taken or any similar or identical product unless specifically and expressly noted. Our report includes all of the tests requested by you and the results thereof based upon the information that you provided to us. You have 60 days from date of issuance of this report to notify us of any material error or omission caused by our negligence, provided, however, that such notice shall be in writing and shall specifically address the issue you wish to raise. A failure to raise such issue within the prescribed time shall constitute your unqualified acceptance of the completeness of this report, the tests conducted and the correctness of the report contents. Unless specific mention, the uncertainty of measurement has been explicitly taken into account to declare the compliance or non-compliance to the specification. The report must not be used by the client to claim product certification, approval, or endorsement by TAF or any government agencies.

Table of Contents

| | |
|--|-----------|
| Release Control Record | 3 |
| 1 Certificate of Conformity | 4 |
| 2 Summary of Test Results | 5 |
| 2.1 Measurement Uncertainty | 5 |
| 2.2 Modification Record | 5 |
| 3 General Information | 6 |
| 3.1 General Description of EUT | 6 |
| 3.2 Description of Test Modes | 8 |
| 3.2.1 Test Mode Applicability and Tested Channel Detail | 9 |
| 3.3 Description of Support Units | 10 |
| 3.3.1 Configuration of System under Test | 10 |
| 3.4 General Description of Applied Standards | 10 |
| 4 Test Types and Results | 11 |
| 4.1 Radiated Emission and Bandedge Measurement..... | 11 |
| 4.1.1 Limits of Radiated Emission and Bandedge Measurement | 11 |
| 4.1.2 Test Instruments | 12 |
| 4.1.3 Test Procedures..... | 13 |
| 4.1.4 Deviation from Test Standard | 13 |
| 4.1.5 Test Setup..... | 14 |
| 4.1.6 EUT Operating Conditions..... | 15 |
| 4.1.7 Test Results | 16 |
| 4.2 Conducted Out of Band Emission Measurement..... | 18 |
| 4.2.1 Limits of Conducted Out of Band Emission Measurement..... | 18 |
| 4.2.2 Test Setup..... | 18 |
| 4.2.3 Test Instruments | 18 |
| 4.2.4 Test Procedure | 18 |
| 4.2.5 Deviation from Test Standard | 18 |
| 4.2.6 EUT Operating Condition | 18 |
| 4.2.7 Test Results | 18 |
| 5 Pictures of Test Arrangements | 20 |
| Appendix – Information on the Testing Laboratories | 21 |

Release Control Record

| Issue No. | Description | Date Issued |
|---------------|------------------|---------------|
| RF180713C31-6 | Original release | Oct. 19, 2018 |

1 Certificate of Conformity

Product: LTE WiFi Gateway
Brand: T-Mobile
Test Model: TM-RTL0102
Sample Status: Engineering sample
Applicant: ASKEY COMPUTER CORP.
Test Date: Oct. 18, 2018
Standards: 47 CFR FCC Part 15, Subpart C (Section 15.247)
47 CFR FCC Part 15, Subpart E (Section 15.407)
ANSI C63.10-2013

The above equipment has been tested by **Bureau Veritas Consumer Products Services (H.K.) Ltd., Taoyuan Branch**, and found compliance with the requirement of the above standards. The test record, data evaluation & Equipment Under Test (EUT) configurations represented herein are true and accurate accounts of the measurements of the sample's RF characteristics under the conditions specified in this report.

Prepared by : Celine Chou , **Date:** Oct. 19, 2018
Celine Chou / Specialist

Approved by : Bruce Chen , **Date:** Oct. 19, 2018
Bruce Chen / Project Engineer

2 Summary of Test Results

| Applied Standard: | 47 CFR FCC Part 15, Subpart C (Section 15.247) 47 CFR FCC Part 15, Subpart E (Section 15.407) | | |
|--|--|--------|---|
| FCC Clause | Test Item | Result | Remarks |
| 15.205 / 15.209 / 15.247(d) 15.407(b) (1/2/3/4(i/ii)/6) | Radiated Emissions | Pass | Meet the requirement of limit. Minimum passing margin is -5.1dB at 65.58MHz. |

2.1 Measurement Uncertainty

Where relevant, the following measurement uncertainty levels have been estimated for tests performed on the EUT as specified in CISPR 16-4-2:

| Measurement | Frequency | Expanded Uncertainty (k=2) (\pm) |
|--------------------------------|-----------------|--------------------------------------|
| Radiated Emissions up to 1 GHz | 30MHz ~ 200MHz | 3.86 dB |
| | 200MHz ~1000MHz | 3.87 dB |
| Radiated Emissions above 1 GHz | 1GHz ~ 18GHz | 2.29 dB |
| | 18GHz ~ 40GHz | 2.29 dB |

2.2 Modification Record

There were no modifications required for compliance.

3 General Information

3.1 General Description of EUT

| | |
|---------------------|--|
| Product | LTE WiFi Gateway |
| Brand | T-Mobile |
| Test Model | TM-RTL0102 |
| Status of EUT | Engineering sample |
| Power Supply Rating | 12Vdc from Adapter 3.7Vdc from Battery |
| Modulation Type | CCK, DQPSK, DBPSK for DSSS 256QAM, 64QAM, 16QAM, QPSK, BPSK for OFDM |
| Transfer Rate | 802.11b: 11/5.5/2/1Mbps 802.11a/g: 54/48/36/24/18/12/9/6Mbps 802.11n: up to 300Mbps 802.11ac: up to 867Mbps |
| Operating Frequency | 2.4GHz: 2412 ~ 2462MHz 5.0GHz: 5180 ~ 5240MHz, 5745 ~ 5825MHz |
| Number of Channel | 2412 ~ 2462MHz: 802.11b, 802.11g, 802.11n (HT20): 11 802.11n (HT40): 7 5180 ~ 5240MHz: 802.11a, 802.11n (HT20), 802.11ac (VHT20): 4 802.11n (HT40), 802.11ac (VHT40): 2 802.11ac (VHT80): 1 5745 ~ 5825MHz: 802.11a, 802.11n (HT20), 802.11ac (VHT20): 5 802.11n (HT40), 802.11ac (VHT40): 2 802.11ac (VHT80): 1 |
| Output Power | 2412 ~ 2462MHz: 233.538mW 5180 ~ 5240MHz: 94.773mW (For Indoor Access Point – Adapter Mode) 5180 ~ 5240MHz: 39.236mW (For Outdoor Access Point – Battery Mode) 5745 ~ 5825MHz: 75.069mW |
| Antenna Type | Refer to note |
| Antenna Connector | Refer to note |
| Accessory Device | Adapter, Battery |
| Cable Supplied | NA |

Note:

1. The EUT incorporates a MIMO function. Physically, the EUT provides 2 completed transmitters and 2 receivers.

| Modulation Mode | TX Function |
|------------------|-------------|
| 802.11a | 2TX |
| 802.11b | 2TX |
| 802.11g | 2TX |
| 802.11n (HT20) | 2TX |
| 802.11n (HT40) | 2TX |
| 802.11ac (VHT20) | 2TX |
| 802.11ac (VHT40) | 2TX |
| 802.11ac (VHT80) | 2TX |

* The modulation and bandwidth are similar for 802.11n mode for 20MHz/40MHz and 802.11ac mode for 20MHz/40MHz, therefore investigated worst case to representative mode in test report. (Final test mode refer section 3.2.1)

2. The EUT consumes power from the following adapters.

| Adapter 1 | |
|------------|---|
| Brand | FLYPOWER |
| Model | PS24L120K2000UD |
| Input | 100-240Vac, 50/60Hz, 0.8A Max. |
| Output | 12.0Vdc, 2.0A |
| Power Line | 1.45m DC cable without core attached on adapter |

| Adapter 2 | |
|------------|--|
| Brand | Asian Power Devices Inc. |
| Model | WB-24J12FU |
| Input | 100-240Vac, 50-60Hz, 0.7A Max. |
| Output | 12.0Vdc, 2.0A |
| Power Line | 1.5m DC cable without core attached on adapter |

* After pre-test, adapter 1 is the worst case and for final test.

| Battery | |
|---------|--------------------------|
| Brand | ASKEY COMPUTER CORP. |
| Model | BP18-002390 |
| Rating | 3.7Vdc, 5200mAh, 19.24Wh |

3. The following antennas were provided to the EUT.

| Antenna Item | Antenna Type | Connector | Gain(dBi) | |
|--------------|--------------|------------|-----------|------|
| | | | 2.4GHz | 5GHz |
| 1 | Monopole | i-pex(MHF) | 2.3 | 5.0 |
| 2 | | | 2.5 | 2.5 |

4. 2.4GHz & 5GHz & WWAN technology can transmit at same time .
5. The 2.4GHz & 5GHz are share a common antenna and WWAN operating on another antenna.
6. Spurious emission of the simultaneous operation (WLAN, WWAN) has been evaluated and no non-compliance was found.

3.2 Description of Test Modes

For 2.4GHz

11 channels are provided for 802.11b, 802.11g and 802.11n (HT20):

| Channel | Frequency | Channel | Frequency |
|---------|-----------|---------|-----------|
| 1 | 2412MHz | 7 | 2442MHz |
| 2 | 2417MHz | 8 | 2447MHz |
| 3 | 2422MHz | 9 | 2452MHz |
| 4 | 2427MHz | 10 | 2457MHz |
| 5 | 2432MHz | 11 | 2462MHz |
| 6 | 2437MHz | | |

7 channels are provided for 802.11n (HT40):

| Channel | Frequency | Channel | Frequency |
|---------|-----------|---------|-----------|
| 3 | 2422MHz | 7 | 2442MHz |
| 4 | 2427MHz | 8 | 2447MHz |
| 5 | 2432MHz | 9 | 2452MHz |
| 6 | 2437MHz | | |

For 5180 ~ 5240MHz:

4 channels are provided for 802.11a, 802.11n (HT20):

| Channel | Frequency | Channel | Frequency |
|---------|-----------|---------|-----------|
| 36 | 5180 MHz | 44 | 5220 MHz |
| 40 | 5200 MHz | 48 | 5240 MHz |

2 channels are provided for 802.11n (HT40):

| Channel | Frequency | Channel | Frequency |
|---------|-----------|---------|-----------|
| 38 | 5190 MHz | 46 | 5230 MHz |

1 channel is provided for 802.11ac (VHT80):

| Channel | Frequency |
|---------|-----------|
| 42 | 5210MHz |

For 5745 ~ 5825MHz:

5 channels are provided for 802.11a, 802.11n (HT20):

| Channel | Frequency | Channel | Frequency |
|---------|-----------|---------|-----------|
| 149 | 5745MHz | 161 | 5805MHz |
| 153 | 5765MHz | 165 | 5825MHz |
| 157 | 5785MHz | | |

2 channels are provided for 802.11n (HT40):

| Channel | Frequency | Channel | Frequency |
|---------|-----------|---------|-----------|
| 151 | 5755MHz | 159 | 5795MHz |

1 channel is provided for 802.11ac (VHT80):

| Channel | Frequency |
|---------|-----------|
| 155 | 5775MHz |

3.2.1 Test Mode Applicability and Tested Channel Detail

| EUT Configure Mode | Applicable to | | | Description |
|--------------------|---------------|-------|----|-------------|
| | RE \geq 1G | RE<1G | OB | |
| - | √ | √ | √ | - |

Where RE \geq 1G: Radiated Emission above 1GHz & Bandedge Measurement

RE<1G: Radiated Emission below 1GHz

Note: The EUT was positioned on X-plane.

Radiated Emission Test (Above 1GHz):

- Pre-Scan has been conducted to determine the worst-case mode from all possible combinations between available modulations, data rates and antenna ports (if EUT with antenna diversity architecture).
- Following channel(s) was (were) selected for the final test as listed below.

| EUT Configure Mode | Mode | Freq. Range (MHz) | Available Channel | Tested Channel | Modulation Technology |
|--------------------|-----------|-------------------|-------------------|----------------|-----------------------|
| - | 802.11g + | 2412 ~ 2462 | 1 to 11 | 6 + 40 | OFDM |
| | 802.11a | 5180 ~ 5240 | 36 to 48 | | OFDM |

Radiated Emission Test (Below 1GHz):

- Pre-Scan has been conducted to determine the worst-case mode from all possible combinations between available modulations, data rates and antenna ports (if EUT with antenna diversity architecture).
- Following channel(s) was (were) selected for the final test as listed below.

| EUT Configure Mode | Mode | Freq. Range (MHz) | Available Channel | Tested Channel | Modulation Technology |
|--------------------|-----------|-------------------|-------------------|----------------|-----------------------|
| - | 802.11g + | 2412 ~ 2462 | 1 to 11 | 6 + 40 | OFDM |
| | 802.11a | 5180 ~ 5240 | 36 to 48 | | OFDM |

Conducted Out-Band Emission Measurement

- Pre-Scan has been conducted to determine the worst-case mode from all possible combinations between available modulations, data rates and antenna ports (if EUT with antenna diversity architecture).
- Following channel(s) was (were) selected for the final test as listed below.

| EUT Configure Mode | Mode | Freq. Range (MHz) | Available Channel | Tested Channel | Modulation Technology |
|--------------------|-----------|-------------------|-------------------|----------------|-----------------------|
| - | 802.11g + | 2412 ~ 2462 | 1 to 11 | 6 + 40 | OFDM |
| | 802.11a | 5180 ~ 5240 | 36 to 48 | | OFDM |

Test Condition:

| Applicable to | Environmental Conditions | Input Power | Tested by |
|---------------|--------------------------|--------------|-------------|
| RE \geq 1G | 26 deg. C, 67% RH | 120Vac, 60Hz | Willy Cheng |
| RE<1G | 23 deg. C, 66% RH | 120Vac, 60Hz | Willy Cheng |
| OB | 26 deg. C, 67% RH | 120Vac, 60Hz | Willy Cheng |

3.3 Description of Support Units

The EUT has been tested as an independent unit together with other necessary accessories or support units. The following support units or accessories were used to form a representative test configuration during the tests.

| ID | Product | Brand | Model No. | Serial No. | FCC ID | Remarks |
|----|----------|-------|-----------|------------|------------------|---------|
| A. | Notebook | DELL | E5410 | 1HC2XM1 | FCC DoC Approved | - |

Note:

1. All power cords of the above support units are non-shielded (1.8m).
2. Item A acted as a communication partner to transfer data.

| ID | Descriptions | Qty. | Length (m) | Shielding (Yes/No) | Cores (Qty.) | Remarks |
|----|--------------|------|------------|--------------------|--------------|---------|
| 1. | RJ45, Cat5e | 1 | 3 | N | 0 | - |

3.3.1 Configuration of System under Test

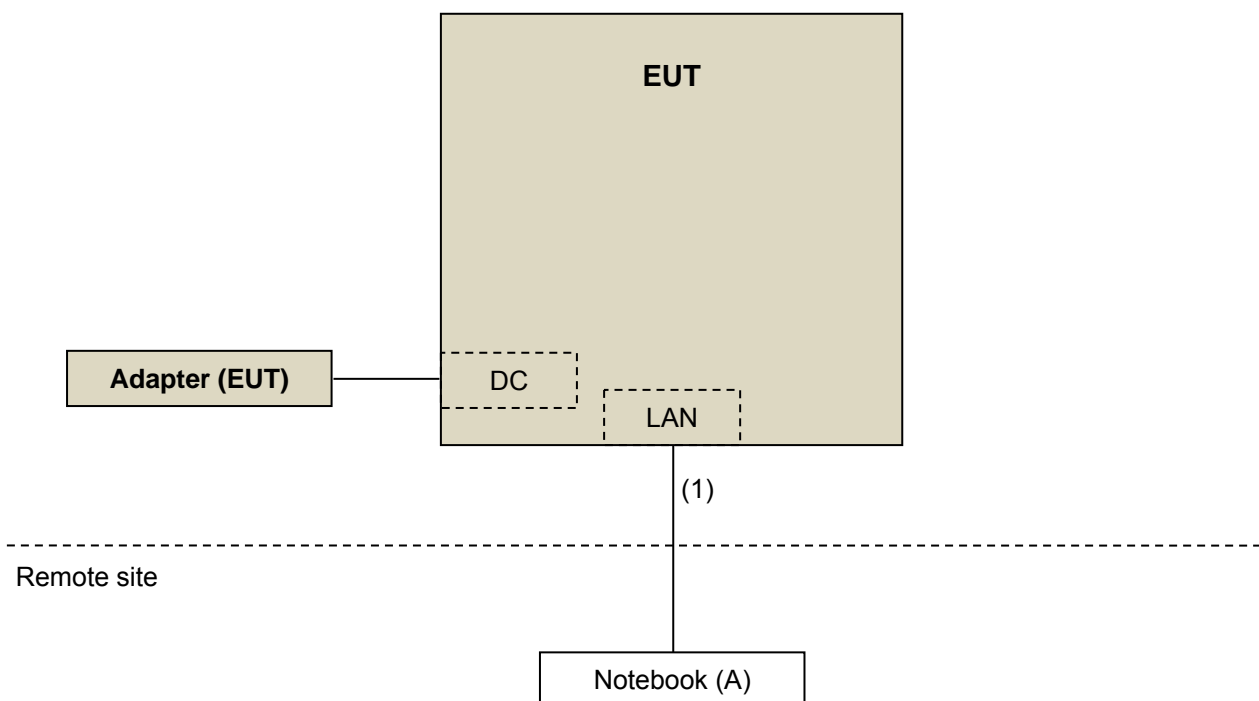

3.4 General Description of Applied Standards

The EUT is a RF Product. According to the specification of the EUT declared by the manufacturer, it must comply with the requirements of the following standards:

FCC Part 15, Subpart C (15.247)

FCC Part 15, Subpart E (15.407)

ANSI C63.10-2013

All test items have been performed and recorded as per the above standards.

4 Test Types and Results

4.1 Radiated Emission and Bandedge Measurement

4.1.1 Limits of Radiated Emission and Bandedge Measurement

Radiated emissions which fall in the restricted bands must comply with the radiated emission limits specified as below table. Other emissions shall be at least 30dB below the highest level of the desired power:

| Frequencies (MHz) | Field Strength (microvolts/meter) | Measurement Distance (meters) |
|-------------------|-----------------------------------|-------------------------------|
| 0.009 ~ 0.490 | 2400/F(kHz) | 300 |
| 0.490 ~ 1.705 | 24000/F(kHz) | 30 |
| 1.705 ~ 30.0 | 30 | 30 |
| 30 ~ 88 | 100 | 3 |
| 88 ~ 216 | 150 | 3 |
| 216 ~ 960 | 200 | 3 |
| Above 960 | 500 | 3 |

Note:

1. The lower limit shall apply at the transition frequencies.
2. Emission level (dBuV/m) = 20 log Emission level (uV/m).
3. For frequencies above 1000MHz, the field strength limits are based on average detector, however, the peak field strength of any emission shall not exceed the maximum permitted average limits, specified above by more than 20dB under any condition of modulation.

Limits of unwanted emission out of the restricted bands

| Applicable To | | Limit | |
|--|---|---|---|
| 789033 D02 General UNII Test Procedure New Rules v02r01 | | Field Strength at 3m | |
| | | PK: 74 (dBµV/m) | AV: 54 (dBµV/m) |
| Frequency Band | Applicable To | EIRP Limit | Equivalent Field Strength at 3m |
| 5150~5250 MHz | 15.407(b)(1) | PK: -27 (dBm/MHz) | PK: 68.2(dBµV/m) |
| 5250~5350 MHz | 15.407(b)(2) | | |
| 5470~5725 MHz | 15.407(b)(3) | | |
| 5725~5850 MHz | <input checked="" type="checkbox"/> 15.407(b)(4)(i) | PK: -27 (dBm/MHz) ^{*1} PK: 10 (dBm/MHz) ^{*2} PK: 15.6 (dBm/MHz) ^{*3} PK: 27 (dBm/MHz) ^{*4} | PK: 68.2(dBµV/m) ^{*1} PK: 105.2 (dBµV/m) ^{*2} PK: 110.8(dBµV/m) ^{*3} PK: 122.2 (dBµV/m) ^{*4} |
| | <input type="checkbox"/> 15.407(b)(4)(ii) | Emission limits in section 15.247(d) | |
| ^{*1} beyond 75 MHz or more above of the band edge. | | ^{*2} below the band edge increasing linearly to 10 dBm/MHz at 25 MHz above. | |
| ^{*3} below the band edge increasing linearly to a level of 15.6 dBm/MHz at 5 MHz above. | | ^{*4} from 5 MHz above or below the band edge increasing linearly to a level of 27 dBm/MHz at the band edge. | |

Note: The following formula is used to convert the equipment isotropic radiated power (eirp) to field strength:

$$E = \frac{1000000\sqrt{30P}}{3} \mu\text{V/m, where P is the eirp (Watts).}$$

4.1.2 Test Instruments

| Description & Manufacturer | Model No. | Serial No. | Cal. Date | Cal. Due |
|--|---------------------------------------|---------------------------------|---------------|---------------|
| Test Receiver ROHDE & SCHWARZ | ESIB7 | 100187 | May 29, 2018 | May 28, 2019 |
| Spectrum Analyzer ROHDE & SCHWARZ | FSP40 | 100041 | Dec. 12, 2017 | Dec. 11, 2018 |
| BILOG Antenna SCHWARZBECK | VULB9168 | 9168-171 | Dec. 11, 2017 | Dec. 10, 2018 |
| HORN Antenna SCHWARZBECK | 9120D | 209 | Dec. 13, 2017 | Dec. 12, 2018 |
| HORN Antenna SCHWARZBECK | BBHA 9170 | BBHA9170241 | Dec. 01, 2017 | Nov. 30, 2018 |
| Loop Antenna TESEQ | HLA 6121 | 45745 | Jun. 14, 2018 | Jun. 13, 2019 |
| Preamplifier Agilent (Below 1GHz) | 8447D | 2944A10738 | Aug. 21, 2018 | Aug. 20, 2019 |
| Preamplifier Agilent (Above 1GHz) | 8449B | 3008A02465 | Apr. 03, 2018 | Apr. 02, 2019 |
| RF signal cable HUBER+SUHNER | SUCOFLEX 104 | Cable-CH3-03 (223653/4) | Aug. 21, 2018 | Aug. 20, 2019 |
| RF signal cable HUBER+SUHNER& EMCI | SUCOFLEX 104&EMC104-SM-S M-8000 | Cable-CH3-03 (309224+170907) | Aug. 21, 2018 | Aug. 20, 2019 |
| Software BV ADT | ADT_Radiated_ V7.6.15.9.5 | NA | NA | NA |
| Antenna Tower inn-co GmbH | MA 4000 | 013303 | NA | NA |
| Antenna Tower Controller BV ADT | AT100 | AT93021702 | NA | NA |
| Turn Table BV ADT | TT100 | TT93021702 | NA | NA |
| Turn Table Controller BV ADT | SC100 | SC93021702 | NA | NA |
| Boresight Antenna Fixture | FBA-01 | FBA-SIP01 | NA | NA |
| Pre-amplifier (18GHz-40GHz) EMC | EMC184045B | 980175 | Nov. 14, 2017 | Nov. 13, 2018 |

- Note:
1. The calibration interval of the above test instruments is 12 months and the calibrations are traceable to NML/ROC and NIST/USA.
 2. The test was performed in HwaYa Chamber 3.
 3. The horn antenna and preamplifier (model: 8449B) are used only for the measurement of emission frequency above 1GHz if tested.
 4. The FCC Designation Number is TW0003. The number will be varied with the Lab location and scope as attached.
 5. The IC Site Registration No. is IC 7450F-3.

4.1.3 Test Procedures

For Radiated emission below 30MHz

- a. The EUT was placed on the top of a rotating table 0.8 meters above the ground at a 3 meter chamber room. The table was rotated 360 degrees to determine the position of the highest radiation.
- b. The EUT was set 3 meters away from the interference-receiving antenna, which was mounted on the top of a variable-height antenna tower.
- c. Parallel, perpendicular, and ground-parallel orientations of the antenna are set to make the measurement.
- d. For each suspected emission, the EUT was arranged to its worst case and the rotatable table was turned from 0 degrees to 360 degrees to find the maximum reading.
- e. The test-receiver system was set to Quasi-Peak Detect Function and Specified Bandwidth with Maximum Hold Mode.

Note:

1. The resolution bandwidth and video bandwidth of test receiver/spectrum analyzer is 9kHz at frequency below 30MHz.

For Radiated emission above 30MHz

- a. The EUT was placed on the top of a rotating table 0.8 meters (for 30MHz ~ 1GHz) / 1.5 meters (for above 1GHz) above the ground at 3 meter chamber room for test. The table was rotated 360 degrees to determine the position of the highest radiation.
- b. The EUT was set 3 meters away from the interference-receiving antenna, which was mounted on the top of a variable-height antenna tower.
- c. The height of antenna is varied from one meter to four meters above the ground to determine the maximum value of the field strength. Both horizontal and vertical polarizations of the antenna are set to make the measurement.
- d. For each suspected emission, the EUT was arranged to its worst case and then the antenna was tuned to heights from 1 meter to 4 meters and the rotatable table was turned from 0 degrees to 360 degrees to find the maximum reading.
- e. The test-receiver system was set to quasi-peak detect function and specified bandwidth with maximum hold mode when the test frequency is below 1 GHz.
- f. The test-receiver system was set to peak and average detect function and specified bandwidth with maximum hold mode when the test frequency is above 1 GHz. If the peak reading value also meets average limit, measurement with the average detector is unnecessary.

Note:

1. The resolution bandwidth and video bandwidth of test receiver/spectrum analyzer is 120kHz for Quasi-peak detection (QP) at frequency below 1GHz.
2. The resolution bandwidth of test receiver/spectrum analyzer is 1 MHz and the video bandwidth is 3 MHz for Peak detection (PK) at frequency above 1GHz.
3. The resolution bandwidth of test receiver/spectrum analyzer is 1MHz and the video bandwidth is $\geq 1/T$ (Duty cycle < 98%) or 10Hz (Duty cycle $\geq 98\%$) for Average detection (AV) at frequency above 1GHz.
4. All modes of operation were investigated and the worst-case emissions are reported.

4.1.4 Deviation from Test Standard

No deviation.

4.1.5 Test Setup

For Radiated emission below 30MHz

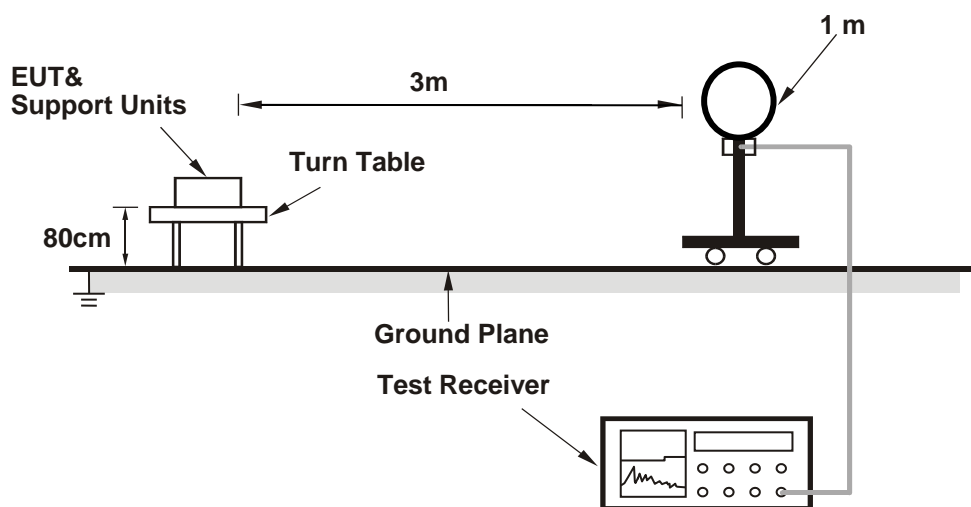

For Radiated emission 30MHz to 1GHz

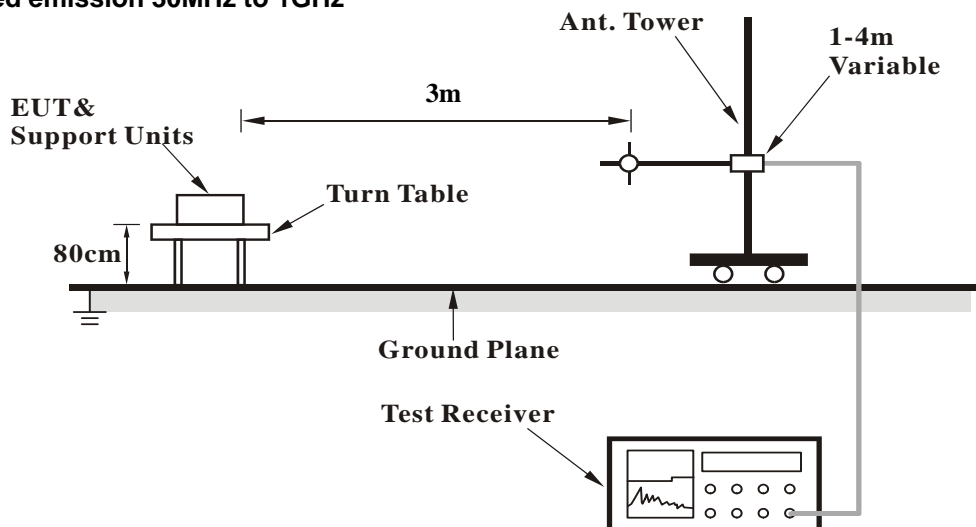

For Radiated emission above 1GHz

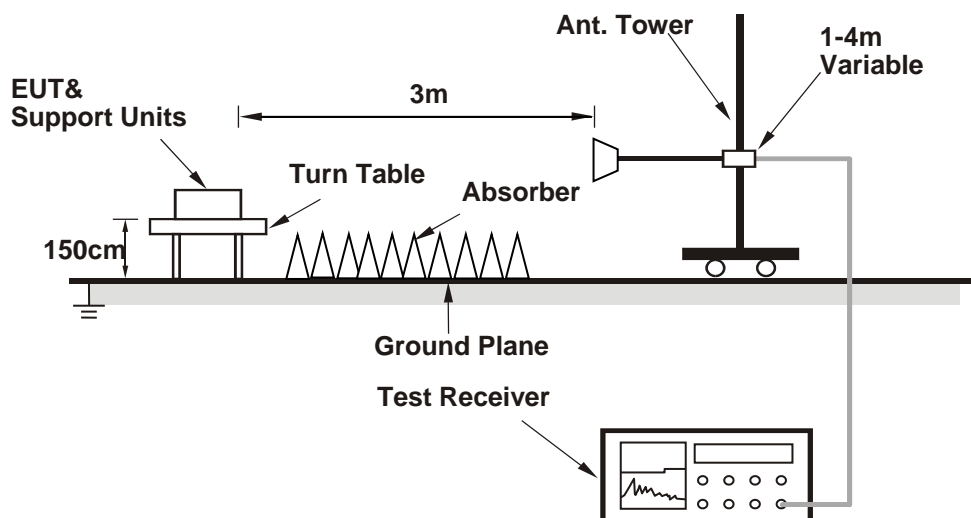

For the actual test configuration, please refer to the attached file (Test Setup Photo).

4.1.6 EUT Operating Conditions

- Placed the EUT on the testing table.
- Prepared a notebook to act as a communication partner and placed it outside of testing area.
- The communication partner connected with EUT via a RJ45 cable and ran a test program (provided by manufacturer) to enable EUT under transmission condition continuously at specific channel frequency.
- The communication partner sent data to EUT by command "PING".

4.1.7 Test Results

Above 1GHz Data:

802.11g + 802.11a

| | | | |
|-----------------|--------------|-------------------|---------------------------|
| CHANNEL | CH 6 + CH 40 | DETECTOR FUNCTION | Peak (PK) Average (AV) |
| FREQUENCY RANGE | 1GHz ~ 40GHz | | |

| ANTENNA POLARITY & TEST DISTANCE: HORIZONTAL AT 3 M | | | | | | | | |
|---|-------------|-------------------------|----------------|-------------|--------------------|----------------------|------------------|--------------------------|
| NO. | FREQ. (MHz) | EMISSION LEVEL (dBuV/m) | LIMIT (dBuV/m) | MARGIN (dB) | ANTENNA HEIGHT (m) | TABLE ANGLE (Degree) | RAW VALUE (dBuV) | CORRECTION FACTOR (dB/m) |
| 1 | *2437.00 | 113.9 PK | | | 1.68 H | 234 | 81.0 | 32.9 |
| 2 | *2437.00 | 103.1 AV | | | 1.68 H | 234 | 70.2 | 32.9 |
| 3 | 4874.00 | 52.9 PK | 74.0 | -21.1 | 2.96 H | 202 | 42.9 | 10.0 |
| 4 | 4874.00 | 37.2 AV | 54.0 | -16.8 | 2.96 H | 202 | 27.2 | 10.0 |
| 5 | *5200.00 | 101.4 PK | | | 1.85 H | 264 | 61.5 | 39.9 |
| 6 | *5200.00 | 91.7 AV | | | 1.85 H | 264 | 51.8 | 39.9 |
| 7 | #10400.00 | 55.9 PK | 68.2 | -12.3 | 1.48 H | 233 | 36.2 | 19.7 |

| ANTENNA POLARITY & TEST DISTANCE: VERTICAL AT 3 M | | | | | | | | |
|---|-------------|-------------------------|----------------|-------------|--------------------|----------------------|------------------|--------------------------|
| NO. | FREQ. (MHz) | EMISSION LEVEL (dBuV/m) | LIMIT (dBuV/m) | MARGIN (dB) | ANTENNA HEIGHT (m) | TABLE ANGLE (Degree) | RAW VALUE (dBuV) | CORRECTION FACTOR (dB/m) |
| 1 | *2437.00 | 111.6 PK | | | 1.93 V | 164 | 78.7 | 32.9 |
| 2 | *2437.00 | 99.7 AV | | | 1.93 V | 164 | 66.8 | 32.9 |
| 3 | 4874.00 | 53.8 PK | 74.0 | -20.2 | 1.79 V | 233 | 43.8 | 10.0 |
| 4 | 4874.00 | 39.6 AV | 54.0 | -14.4 | 1.79 V | 233 | 29.6 | 10.0 |
| 5 | *5200.00 | 101.5 PK | | | 1.64 V | 185 | 61.6 | 39.9 |
| 6 | *5200.00 | 90.8 AV | | | 1.64 V | 185 | 50.9 | 39.9 |
| 7 | #10400.00 | 54.6 PK | 68.2 | -13.6 | 2.58 V | 115 | 34.9 | 19.7 |

Remarks:

1. Emission Level(dBuV/m) = Raw Value(dBuV) + Correction Factor(dB/m)
2. Correction Factor(dB/m) = Antenna Factor(dB/m) + Cable Factor(dB) – Pre-Amplifier Factor(dB)
3. The other emission levels were very low against the limit.
4. Margin value = Emission Level – Limit value
5. " * ": Fundamental frequency.
6. " # ": The radiated frequency is out of the restricted band.

Below 1GHz data

802.11g + 802.11n (HT40)

| | | | |
|-----------------|--------------|----------------------|-----------------|
| CHANNEL | CH 6 + CH 40 | DETECTOR FUNCTION | Quasi-Peak (QP) |
| FREQUENCY RANGE | 9kHz ~ 1GHz | | |

ANTENNA POLARITY & TEST DISTANCE: HORIZONTAL AT 3 M

| NO. | FREQ. (MHz) | EMISSION LEVEL (dBuV/m) | LIMIT (dBuV/m) | MARGIN (dB) | ANTENNA HEIGHT (m) | TABLE ANGLE (Degree) | RAW VALUE (dBuV) | CORRECTION FACTOR (dB/m) |
|-----|-------------|-------------------------|----------------|-------------|--------------------|----------------------|------------------|--------------------------|
| 1 | 39.64 | 29.6 QP | 40.0 | -10.4 | 1.99 H | 256 | 39.6 | -10.0 |
| 2 | 69.84 | 34.5 QP | 40.0 | -5.5 | 2.00 H | 151 | 45.7 | -11.2 |
| 3 | 99.72 | 31.9 QP | 43.5 | -11.6 | 1.49 H | 96 | 45.6 | -13.7 |
| 4 | 439.96 | 28.6 QP | 46.0 | -17.4 | 1.00 H | 206 | 33.0 | -4.4 |
| 5 | 584.43 | 31.8 QP | 46.0 | -14.2 | 1.01 H | 286 | 33.3 | -1.5 |
| 6 | 653.46 | 31.8 QP | 46.0 | -14.2 | 1.49 H | 255 | 32.2 | -0.4 |

ANTENNA POLARITY & TEST DISTANCE: VERTICAL AT 3 M

| NO. | FREQ. (MHz) | EMISSION LEVEL (dBuV/m) | LIMIT (dBuV/m) | MARGIN (dB) | ANTENNA HEIGHT (m) | TABLE ANGLE (Degree) | RAW VALUE (dBuV) | CORRECTION FACTOR (dB/m) |
|----------|--------------|-------------------------|----------------|-------------|--------------------|----------------------|------------------|--------------------------|
| 1 | 39.64 | 32.5 QP | 40.0 | -7.5 | 1.01 V | 182 | 42.5 | -10.0 |
| 2 | 65.58 | 34.9 QP | 40.0 | -5.1 | 1.01 V | 173 | 45.3 | -10.4 |
| 3 | 89.74 | 33.7 QP | 43.5 | -9.8 | 1.51 V | 264 | 48.5 | -14.8 |
| 4 | 442.34 | 28.9 QP | 46.0 | -17.1 | 1.99 V | 253 | 33.2 | -4.3 |
| 5 | 655.18 | 31.3 QP | 46.0 | -14.7 | 1.51 V | 249 | 31.7 | -0.4 |
| 6 | 899.63 | 34.3 QP | 46.0 | -11.7 | 1.01 V | 346 | 30.4 | 3.9 |

Remarks:

1. Emission Level(dBuV/m) = Raw Value(dBuV) + Correction Factor(dB/m)
2. Correction Factor(dB/m) = Antenna Factor(dB/m) + Cable Factor(dB) – Pre-Amplifier Factor(dB)
3. The other emission levels were very low against the limit.
4. Margin value = Emission Level – Limit value

4.2 Conducted Out of Band Emission Measurement

4.2.1 Limits of Conducted Out of Band Emission Measurement

Below 30dB of the highest emission level of operating band (in 100kHz Resolution Bandwidth).

4.2.2 Test Setup

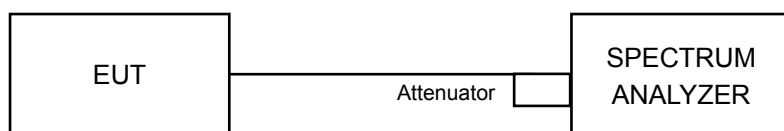

4.2.3 Test Instruments

Refer to section 4.1.2 to get information of above instrument.

4.2.4 Test Procedure

MEASUREMENT PROCEDURE REF

- Set the RBW = 100 kHz.
- Set the VBW \geq 300 kHz.
- Detector = average.
- Sweep time = auto couple.
- Trace mode = max hold.
- Allow trace to fully stabilize.
- Use the peak marker function to determine the maximum power level in any 100 kHz band segment within the fundamental EBW.

MEASUREMENT PROCEDURE OOB

- Set RBW = 100 kHz.
- Set VBW \geq 300 kHz.
- Detector = average.
- Sweep = auto couple.
- Trace Mode = max hold.
- Allow trace to fully stabilize.
- Use the peak marker function to determine the maximum amplitude level.

4.2.5 Deviation from Test Standard

No deviation.

4.2.6 EUT Operating Condition

The software provided by client to enable the EUT under transmission condition continuously at lowest, middle and highest channel frequencies individually.

4.2.7 Test Results

The spectrum plots are attached on the following pages. D1 line indicates the highest level, and D2 line indicates the 30dB offset below D1. It shows compliance with the requirement.

802.11g CH 6 + 802.11a CH 40

Chain 0

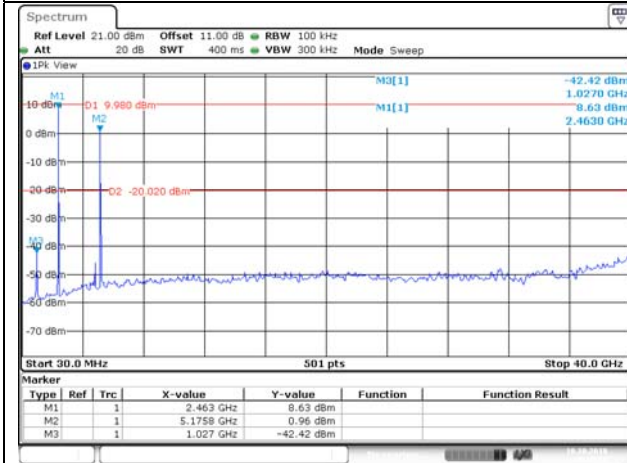

Chain 1

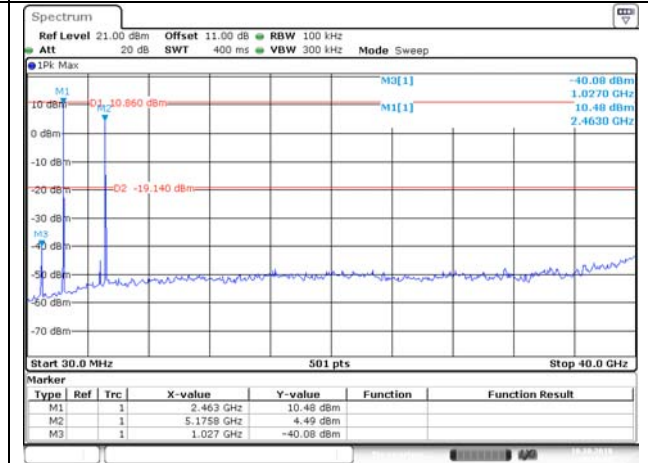

5 Pictures of Test Arrangements

Please refer to the attached file (Test Setup Photo).

Appendix – Information on the Testing Laboratories

We, Bureau Veritas Consumer Products Services (H.K.) Ltd., Taoyuan Branch, were founded in 1988 to provide our best service in EMC, Radio, Telecom and Safety consultation. Our laboratories are FCC recognized accredited test firms and accredited and approved according to ISO/IEC 17025.

If you have any comments, please feel free to contact us at the following:

Linko EMC/RF Lab

Tel: 886-2-26052180

Fax: 886-2-26051924

Hsin Chu EMC/RF/Telecom Lab

Tel: 886-3-6668565

Fax: 886-3-6668323

Hwa Ya EMC/RF/Safety Lab

Tel: 886-3-3183232

Fax: 886-3-3270892

Email: service.adt@tw.bureauveritas.com

Web Site: www.bureauveritas-adt.com

The address and road map of all our labs can be found in our web site also.

--- END ---