



MEASUREMENT REPORT

FCC PART 15.247 Bluetooth v4.0

FCC ID: H8N-QBREMOTE

APPLICANT: ASKEY COMPUTER CORP

Application Type: Certification

Product: QBee Remote Control

Model No.: BLE REMOTE

Brand Name: ASKEY

FCC Classification: Digital Transmission System (DTS)

FCC Rule Part(s): Part 15.247

Test Procedure(s): ANSI C63.10-2013, KDB 558074 D01v03r04

Test Date: December 25 ~ 30, 2015

Reviewed By : Robin Wu
(Robin Wu)

Approved By : Marlin Chen
(Marlin Chen)



The test results relate only to the samples tested.

This equipment has been shown to be capable of compliance with the applicable technical standards as indicated in the measurement report and was tested in accordance with the measurement procedures specified in KDB 558074 D01v03r04. Test results reported herein relate only to the item(s) tested.

The test report shall not be reproduced except in full without the written approval of MRT Technology (Suzhou) Co., Ltd.

Revision History

Report No.	Version	Description	Issue Date
1512RSU00317	Rev. 01	Initial report	04-06-2016

CONTENTS

Description	Page
1. INTRODUCTION	6
1.1. Scope	6
1.2. MRT Test Location	6
2. PRODUCT INFORMATION	7
2.1. Feature of Equipment under Test	7
2.2. Product Specification Subjective to this Report	7
2.3. Working Frequencies	7
2.4. Device Capabilities	8
2.5. Test Configuration	8
2.6. EMI Suppression Device(s)/Modifications	8
2.7. Labeling Requirements	8
2.8. Test Software	8
3. DESCRIPTION OF TEST	9
3.1. Evaluation Procedure	9
3.2. AC Line Conducted Emissions	9
3.3. Radiated Emissions	10
4. ANTENNA REQUIREMENTS	11
5. TEST EQUIPMENT CALIBRATION DATE	12
6. MEASUREMENT UNCERTAINTY	13
7. TEST RESULT	14
7.1. Summary	14
7.2. 6dB Bandwidth Measurement	15
7.2.1. Test Limit	15
7.2.2. Test Procedure used	15
7.2.3. Test Setting	15
7.2.4. Test Setup	15
7.2.5. Test Result	16
7.3. Output Power Measurement	17
7.3.1. Test Limit	17
7.3.2. Test Procedure Used	17
7.3.3. Test Setting	17
7.3.4. Test Setup	17
7.3.5. Test Result of Output Power	18
7.4. Power Spectral Density Measurement	19

7.4.1.	Test Limit	19
7.4.2.	Test Procedure Used	19
7.4.3.	Test Setting	19
7.4.4.	Test Setup.....	19
7.4.5.	Test Result.....	20
7.5.	Conducted Band Edge and Out-of-Band Emissions.....	21
7.5.1.	Test Limit	21
7.5.2.	Test Procedure Used	21
7.5.3.	Test Setting.....	21
7.5.4.	Test Setup.....	22
7.5.5.	Test Result.....	23
7.6.	Radiated Spurious Emission Measurement.....	25
7.6.1.	Test Limit	25
7.6.2.	Test Procedure Used	25
7.6.3.	Test Setting	25
7.6.4.	Test Setup.....	27
7.6.5.	Test Result.....	29
7.7.	Radiated Restricted Band Edge Measurement	38
7.7.1.	Test Result.....	38
7.8.	AC Conducted Emissions Measurement.....	46
7.8.1.	Test Limit	46
7.8.2.	Test Setup.....	46
7.8.3.	Test Result.....	46
8.	CONCLUSION.....	47

§2.1033 General Information

Applicant:	ASKEY COMPUTER CORP
Applicant Address:	10F, No.119, JIANKANG RD., ZHONGHE DIST., NEW TAIPEI CITY 23585, TAIWAN, R.O.C.
Manufacturer:	ASKEY COMPUTER CORP
Manufacturer Address:	10F, No.119, JIANKANG RD., ZHONGHE DIST., NEW TAIPEI CITY 23585, TAIWAN, R.O.C.
Test Site:	MRT Technology (Suzhou) Co., Ltd
Test Site Address:	D8 Building, Youxin Industrial Park, No.2 Tian'edang Rd., Wuzhong Economic Development Zone, Suzhou, China
MRT Registration No.:	809388
FCC Rule Part(s):	Part 15.247
Model No.:	BLE REMOTE
FCC ID:	H8N-QBREMOTE
Test Device Serial No.:	N/A <input type="checkbox"/> Production <input checked="" type="checkbox"/> Pre-Production <input type="checkbox"/> Engineering
FCC Classification:	Digital Transmission System (DTS)

Test Facility / Accreditations

Measurements were performed at MRT Laboratory located in Tian'edang Rd., Suzhou, China.

- MRT facility is a FCC registered (MRT Reg. No. 809388) test facility with the site description report on file and has met all the requirements specified in Section 2.948 of the FCC Rules.
- MRT facility is an IC registered (MRT Reg. No. 11384A-1) test laboratory with the site description on file at Industry Canada.
- MRT facility is a VCCI registered (R-4179, G-814, C-4664, T-2206) test laboratory with the site description on file at VCCI Council.
- MRT Lab is accredited to ISO 17025 by the American Association for Laboratory Accreditation (A2LA) under the American Association for Laboratory Accreditation Program (A2LA Cert. No. 3628.01) in EMC, Telecommunications and Radio testing for FCC, Industry Canada, EU and TELEC Rules.



1. INTRODUCTION

1.1. Scope

Measurement and determination of electromagnetic emissions (EMC) of radio frequency devices including intentional and/or unintentional radiators for compliance with the technical rules and regulations of the Federal Communications Commission and the Industry Canada Certification and Engineering Bureau.

1.2. MRT Test Location

The map below shows the location of the MRT LABORATORY, its proximity to the Taihu Lake. These measurement tests were conducted at the MRT Technology (Suzhou) Co., Ltd. Facility located at D8 Building, Youxin Industrial Park, No.2 Tian'edang Rd., Wuzhong Economic Development Zone, Suzhou, China. The detailed description of the measurement facility was found to be in compliance with the requirements of § 2.948 according to ANSI C63.4-2009 on September 30, 2013.



2. PRODUCT INFORMATION

2.1. Feature of Equipment under Test

Product Name	QBee Remote Control
Model No.	BLE REMOTE

2.2. Product Specification Subjective to this Report

Bluetooth Frequency	2402 ~ 2480MHz
Bluetooth Version	v4.0
Type of modulation	FHSS
Data Rate	1Mbps(GFSK)
Antenna Gain	-4.4dBi

2.3. Working Frequencies for this report

Channel List for BLE

Channel	Frequency	Channel	Frequency	Channel	Frequency
00	2402 MHz	01	2404 MHz	02	2406 MHz
03	2408 MHz	04	2410 MHz	05	2412 MHz
06	2414 MHz	07	2416 MHz	08	2418 MHz
09	2420 MHz	10	2422 MHz	11	2424 MHz
12	2426 MHz	13	2428 MHz	14	2430 MHz
15	2432 MHz	16	2434 MHz	17	2436 MHz
18	2438 MHz	19	2440 MHz	20	2442 MHz
21	2444 MHz	22	2446 MHz	23	2448 MHz
24	2450 MHz	25	2452 MHz	26	2454 MHz
27	2456 MHz	28	2458 MHz	29	2460 MHz
30	2462 MHz	31	2464 MHz	32	2466 MHz
33	2468 MHz	34	2470 MHz	35	2472 MHz
36	2474 MHz	37	2476 MHz	38	2478 MHz
39	2480 MHz	--	--	--	--

2.4. Device Capabilities

This device contains the following capabilities:

Bluetooth (v4.0)

2.5. Test Configuration

The **QBee Remote Control FCC ID: H8N-QBREMOTE** was tested per the guidance of KDB 558074 D01v03r04. ANSI C63.10-2013 was used to reference the appropriate EUT setup for radiated spurious emissions testing and AC line conducted testing.

2.6. EMI Suppression Device(s)/Modifications

No EMI suppression device(s) were added and/or no modifications were made during testing.

2.7. Labeling Requirements

Per 2.1074 & 15.19; Docket 95-19

The label shall be permanently affixed at a conspicuous location on the device; instruction manual or pamphlet supplied to the user and be readily visible to the purchaser at the time of purchase.

However, when the device is so small wherein placement of the label with specified statement is not practical, only the FCC ID must be displayed on the device per Section 15.19(a)(5). Please see attachment for FCC ID label and label location.

2.8. Test Software

The test utility software used during testing was “uEnergyTest”.

3. DESCRIPTION OF TEST

3.1. Evaluation Procedure

The measurement procedures described in the American National Standard for Testing Unlicensed Wireless Devices (ANSI C63.10-2013), and the guidance provided in KDB 558074 D01v03r04 were used in the measurement of the **QBee Remote Control FCC ID: H8N-QBREMOTE**.

Deviation from measurement procedure.....None

3.2. AC Line Conducted Emissions

The line-conducted facility is located inside an 8'x4'x4' shielded enclosure. A 1 m x 2m wooden table 80cm high is placed 40cm away from the vertical wall and 80cm away from the sidewall of the shielded room. Two 10kHz-30MHz, 50Ω/50uH Line-Impedance Stabilization Networks (LISNs) are bonded to the shielded room floor. Power to the LISNs is filtered by external high-current high-insertion loss power line filters. These filters attenuate ambient signal noise from entering the measurement lines. These filters are also bonded to the shielded enclosure.

The EUT is powered from one LISN and the support equipment is powered from the second LISN. All interconnecting cables more than 1 meter were shortened to a 1 meter length by non-inductive bundling (serpentine fashion) and draped over the back edge of the test table. All cables were at least 40cm above the horizontal reference ground-plane. Power cables for support equipment were routed down to the second LISN while ensuring that that cables were not draped over the second LISN.

Sufficient time for the EUT, support equipment, and test equipment was allowed in order for them to warm up to their normal operating condition. The RF output of the LISN was connected to the receiver and exploratory measurements were made to determine the frequencies producing the maximum emission from the EUT. The receiver was scanned from 150kHz to 30MHz. The detector function was set to peak mode for exploratory measurements while the bandwidth of the analyzer was set to 9kHz. The EUT, support equipment, and interconnecting cables were arranged and manipulated to maximize each emission. Each emission was also maximized by varying: power lines, the mode of operation or data exchange speed, or support equipment whichever determined the worst-case emission. Once the worst case emissions have been identified, the one EUT cable configuration/arrangement and mode of operation that produced these emissions were used for final measurements on the same test site. The analyzer is set to CISPR quasi-peak and average detectors with a 9kHz resolution bandwidth for final measurements.

An extension cord was used to connect to a single LISN which powered by EUT. The extension cord was calibrated with LISN, the impedance and insertion loss are compliance with the requirements as stated in ANSI C63.10-2013 at Clause 6.2.

Line conducted emissions test results are shown in Section 7.8.

3.3. Radiated Emissions

The radiated test facilities consisted of an indoor 3 meter semi-anechoic chamber used for final measurements and exploratory measurements, when necessary. The measurement area is contained within the semi-anechoic chamber which is shielded from any ambient interference. For measurements above 1GHz absorbers are arranged on the floor between the turn table and the Antenna mast in such a way so as to maximize the reduction of reflections. For measurements below 1GHz, the absorbers are removed. A MF Model 210SS turntable is used for radiated measurement. It is a continuously rotatable, remote controlled, metallic turntable and 2 meters (6.56 ft.) in diameter. The turn table is flush with the raised floor of the chamber in order to maintain its function as a ground plane. An 80cm high PVC support structure is placed on top of the turntable. For all measurements, the spectrum was scanned through all EUT azimuths and from 1 to 4 meter receive Antenna height using a broadband Antenna from 30MHz up to the upper frequency shown in 15.33(b)(1) depending on the highest frequency generated or used in the device or on which the device operates or tunes. For frequencies above 1GHz, linearly polarized double ridge horn Antennas were used. For frequencies below 30MHz, a calibrated loop Antenna was used. When exploratory measurements were necessary, they were performed at 1 meter test distance inside the semi-anechoic chamber using broadband Antennas, broadband amplifiers, and spectrum analyzers to determine the frequencies and modes producing the maximum emissions. Sufficient time for the EUT, support equipment, and test equipment was allowed in order for them to warm up to their normal operating condition. The test set-up for frequencies below 1GHz was placed on top of the 0.8 meter high, 1 x 1.5 meter table; and test set-up for frequencies 1-40GHz was placed on top of the 1.5 meter high, 1 x 1.5 meter table. The EUT, support equipment, and interconnecting cables were arranged and manipulated to maximize each emission. Appropriate precaution was taken to ensure that all emissions from the EUT were maximized and investigated. The system configuration, clock speed, mode of operation or video resolution, if applicable, turntable azimuth, and receive Antenna height was noted for each frequency found.

Final measurements were made in the semi-anechoic chamber using calibrated, linearly polarized broadband and horn Antennas. The test setup was configured to the setup that produced the worst case emissions. The spectrum analyzer was set to investigate all frequencies required for testing to compare the highest radiated disturbances with respect to the specified limits. The turntable containing the EUT was rotated through 360 degrees and the height of the receive Antenna was varied 1 to 4 meters and stopped at the azimuth and height producing the maximum emission. Each emission was maximized by changing the orientation of the EUT through three orthogonal planes and changing the polarity of the receive Antenna, whichever produced the worst-case emissions. According to 3dB Beam-Width of horn Antenna, the horn Antenna should be always directed to the EUT when rising height.

4. ANTENNA REQUIREMENTS

Excerpt from §15.203 of the FCC Rules/Regulations:

“An intentional radiator antenna shall be designed to ensure that no antenna other than that furnished by the responsible party can be used with the device. The use of a permanently attached antenna or of an antenna that uses a unique coupling to the intentional radiator shall be considered sufficient to comply with the provisions of this section.”

- The antenna of the **QBee Remote Control** is **permanently attached**.
- There are no provisions for connection to an external antenna.

Conclusion:

The **QBee Remote Control FCC ID: H8N-QBREMOTE** unit complies with the requirement of §15.203.

5. TEST EQUIPMENT CALIBRATION DATE

Conducted Emissions - SR2

Instrument	Manufacturer	Type No.	Asset No.	Cali. Interval	Cali. Due Date
EMI Test Receiver	R&S	ESR7	MRTSUE06001	1 year	2016/11/03
Two-Line V-Network	R&S	ENV216	MRTSUE06002	1 year	2016/11/03
Two-Line V-Network	R&S	ENV216	MRTSUE06003	1 year	2016/11/03
Temperature/Humidity Meter	Yuhuaze	HTC-2	MRTSUE06182	1 year	2016/11/20

Radiated Emissions - AC2

Instrument	Manufacturer	Type No.	Asset No.	Cali. Interval	Cali. Due Date
Spectrum Analyzer	Agilent	E4447A	MRTSUE06028	1 year	2016/06/23
EMI Test Receiver	R&S	ESR7	MRTSUE06001	1 year	2016/11/03
Preamplifier	Agilent	83017A	MRTSUE06020	1 year	2016/03/29
Preamplifier	Schwarzbeck	BBV9721	MRTSUE06121	1 year	2016/04/15
Loop Antenna	Schwarzbeck	FMZB1519	MRTSUE06025	1 year	2016/11/07
TRILOG Antenna	Schwarzbeck	VULB9162	MRTSUE06022	1 year	2016/11/07
Broad-Band Horn Antenna	Schwarzbeck	BBHA9120D	MRTSUE06023	1 year	2016/11/07
Broadband Horn Antenna	Schwarzbeck	BBHA9170	MRTSUE06024	1 year	2016/11/20
Temperature/Humidity Meter	Ouleinuo	ETH529	MRTSUE06170	1 year	2016/11/20

Conducted Test Equipment - TR3

Instrument	Manufacturer	Type No.	Asset No.	Cali. Interval	Cali. Due Date
Spectrum Analyzer	Agilent	N9020A	MRTSUE06106	1 year	2016/05/08
USB Wideband Power Sensor	Boonton	55006	MRTSUE06109	1 year	2016/05/08
Temperature/Humidity Meter	Yuhuaze	HTC-2	MRTSUE06180	1 year	2016/12/20

Software	Version	Function
e3	V8.3.5	EMI Test Software

6. MEASUREMENT UNCERTAINTY

Where relevant, the following test uncertainty levels have been estimated for tests performed on the EUT as specified in CISPR 16-4-2. This uncertainty represents an expanded uncertainty expressed at approximately the 95% confidence level using a coverage factor of $k = 2$.

AC Conducted Emission Measurement - SR2
Measuring Uncertainty for a Level of Confidence of 95% ($U=2Uc(y)$): 150kHz~30MHz: 3.46dB
Radiated Emission Measurement - AC2
Measuring Uncertainty for a Level of Confidence of 95% ($U=2Uc(y)$): 9kHz ~ 1GHz: 4.18dB 1GHz ~ 25GHz: 4.76dB

7. TEST RESULT

7.1. Summary

Company Name: ASKEY COMPUTER CORP
FCC ID: H8N-QBREMOTE
FCC Classification: Digital Transmission System (DTS)
Data Rate(s) Tested: 1Mbps(GFSK) (BLE)

FCC Part Section(s)	Test Description	Test Limit	Test Condition	Test Result	Reference
15.247(a)(2)	6dB Bandwidth	$\geq 500\text{kHz}$	Conducted	Pass	Section 7.2
15.247(b)(3)	Output Power	$\leq 1\text{Watt}$		Pass	Section 7.3
15.247(e)	Power Spectral Density	$\leq 8\text{dBm} / 3\text{kHz Band}$		Pass	Section 7.4
15.247(d)	Band Edge / Out-of-Band Emissions	$\geq 20\text{dBc(Peak)}$		Pass	Section 7.5
15.205 15.209	General Field Strength Limits (Restricted Bands and Radiated Emission Limits)	Emissions in restricted bands must meet the radiated limits detailed in 15.209	Radiated	Pass	Section 7.6 & 7.7
15.207	AC Conducted Emissions 150kHz - 30MHz	$< \text{FCC 15.207 limits}$	Line Conducted	N/A	Section 7.8

Notes:

- 1) All modes of operation and data rates were investigated. For radiated emission test, every axis (X, Y, Z) was also verified. The test results shown in the following sections represent the worst case emissions.
- 2) The analyzer plots shown in this section were all taken with a correction table loaded into the analyzer. The correction table was used to account for the losses of the cables and attenuators used as part of the system to connect the EUT to the analyzer at all frequencies of interest.
- 3) All antenna port conducted emissions testing was performed on a test bench with the antenna port of the EUT connected to the spectrum analyzer through calibrated cables and attenuators.

7.2. 6dB Bandwidth Measurement

7.2.1. Test Limit

The minimum 6dB bandwidth shall be at least 500 kHz.

7.2.2. Test Procedure used

KDB 558074 D01v03r04 - Section 8.2 Option 2

7.2.3. Test Setting

1. The Spectrum's automatic bandwidth measurement capability was used to perform the 6dB bandwidth measurement. The "X" dB bandwidth parameter was set to $X = 6$. The bandwidth measurement was not influenced by any intermediate power nulls in the fundamental emission.
2. Set RBW = 100 kHz
3. VBW $\geq 3 \times$ RBW
4. Detector = Peak
5. Trace mode = max hold
6. Sweep = auto couple
7. Allow the trace was allowed to stabilize

7.2.4. Test Setup

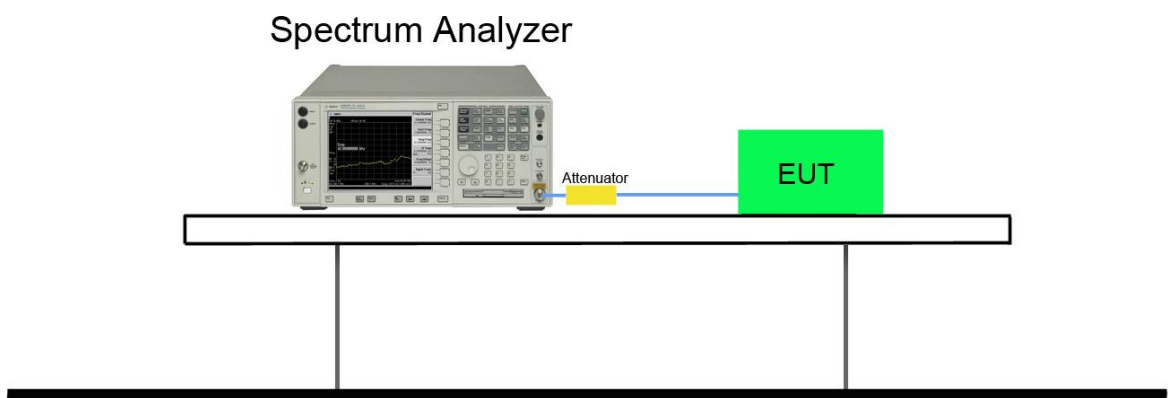

7.2.5. Test Result

Test Mode	Data Rate (Mbps)	Channel No.	Frequency (MHz)	6dB Bandwidth (MHz)	Limit (MHz)	Result
BLE	1	00	2402	0.69	≥ 0.5	Pass
BLE	1	19	2440	0.69	≥ 0.5	Pass
BLE	1	39	2480	0.68	≥ 0.5	Pass

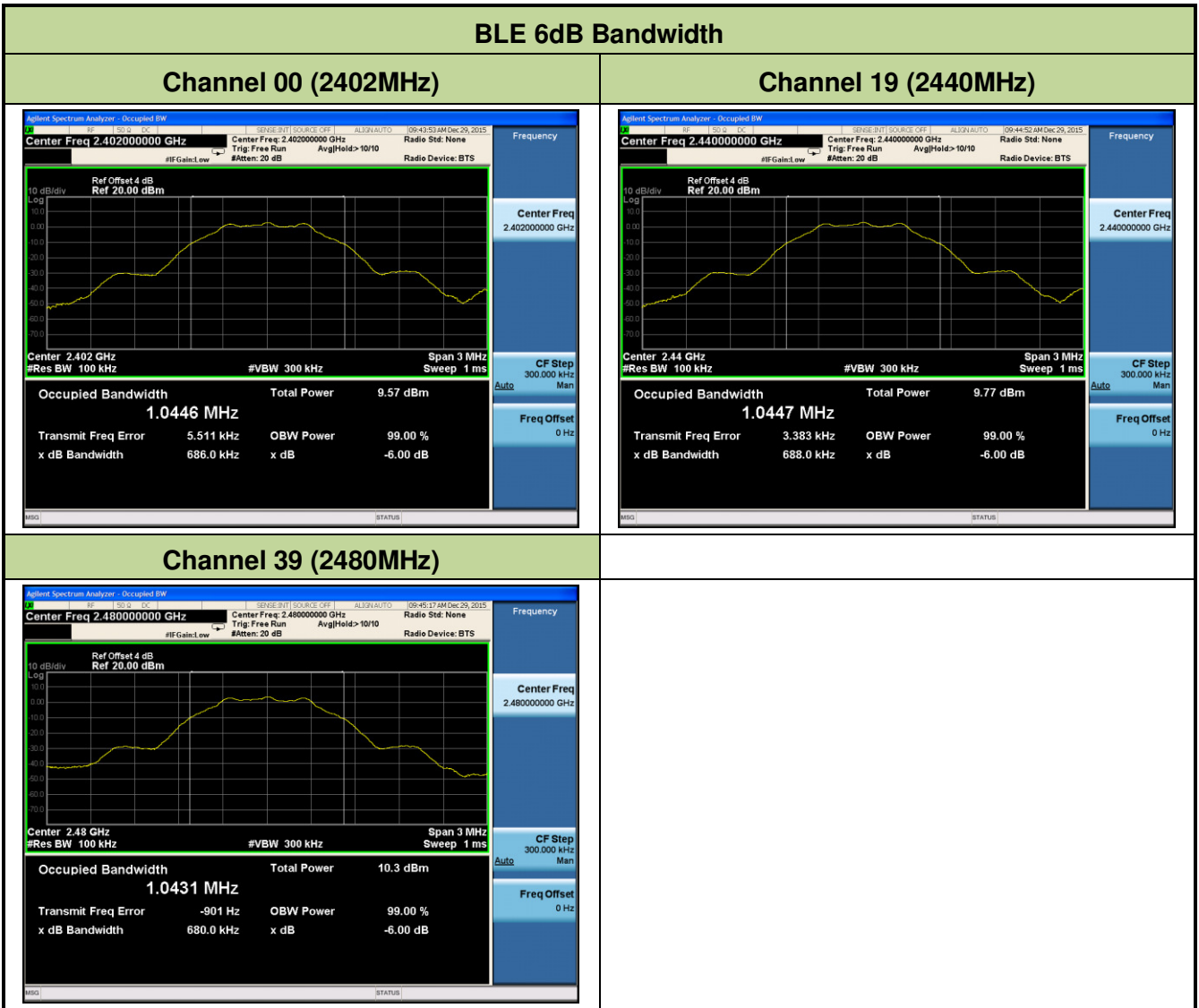

7.3. Output Power Measurement

7.3.1. Test Limit

The maximum out power shall be less 1 Watt (30dBm).

7.3.2. Test Procedure Used

KDB 558074 D01v03r04 - Section 9.1.2 PKPM1 - Peak Power Method

7.3.3. Test Setting

Method PKPM1 (Peak Power Measurement of Signals with DTS BW \leq 50MHz)

Peak power measurements were performed only when the EUT was transmitting at its maximum power control level using a broadband power meter with a pulse sensor. The pulse sensor employs a VBW = 50MHz so this method was only used for signals whose DTS bandwidth was less than or equal to 50MHz.

7.3.4. Test Setup

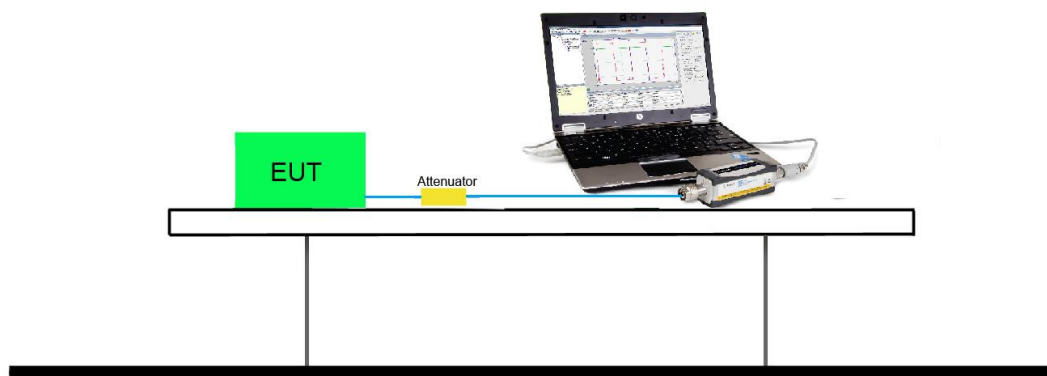

7.3.5. Test Result of Output Power

Test Result of Peak Output Power

Test Mode	Data Rate (Mbps)	Channel No.	Frequency (MHz)	Peak Power (dBm)	Limit (dBm)	Result
BLE	1	00	2402	3.29	≤ 30	Pass
BLE	1	19	2440	3.65	≤ 30	Pass
BLE	1	39	2480	4.23	≤ 30	Pass

Test Result of Average Output Power (Reporting Only)

Test Mode	Data Rate (Mbps)	Channel No.	Frequency (MHz)	Average Power (dBm)	Limit (dBm)	Result
BLE	1	00	2402	2.93	≤ 30	Pass
BLE	1	19	2440	3.36	≤ 30	Pass
BLE	1	39	2480	3.94	≤ 30	Pass

7.4. Power Spectral Density Measurement

7.4.1. Test Limit

The maximum permissible power spectral density is 8dBm in any 3 kHz band.

7.4.2. Test Procedure Used

KDB 558074 D01v03r04 - Section 10.2 Method PKPSD

7.4.3. Test Setting

1. Analyzer was set to the center frequency of the DTS channel under investigation
2. Span = 1.5 times the DTS channel bandwidth
3. RBW = 3kHz
4. VBW = 10kHz
5. Detector = peak
6. Sweep time = auto couple
7. Trace mode = max hold
8. Trace was allowed to stabilize

7.4.4. Test Setup

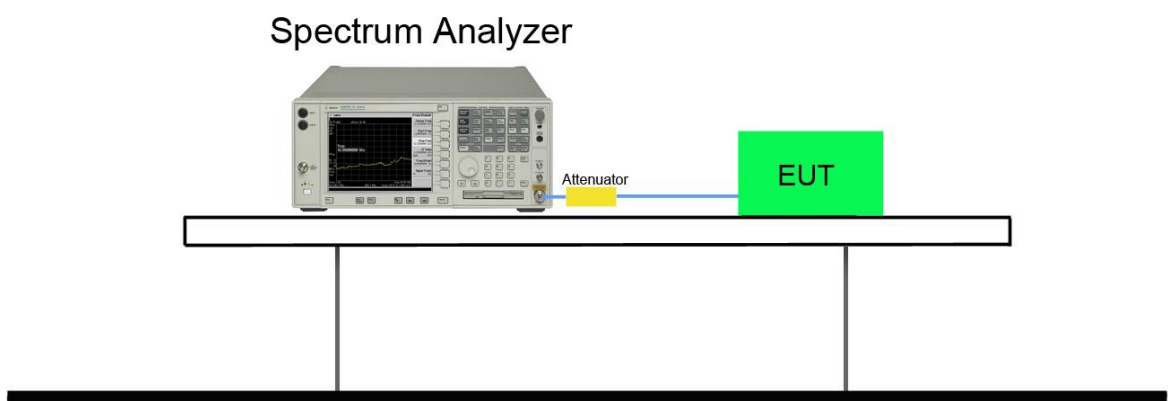

7.4.5. Test Result

Test Mode	Data Rate (Mbps)	Channel No.	Frequency (MHz)	PSD Result (dBm / 3kHz)	Limit (dBm / 3kHz)	Result
BLE	1	00	2402	-12.32	≤ 8	Pass
BLE	1	19	2440	-12.49	≤ 8	Pass
BLE	1	39	2480	-11.77	≤ 8	Pass

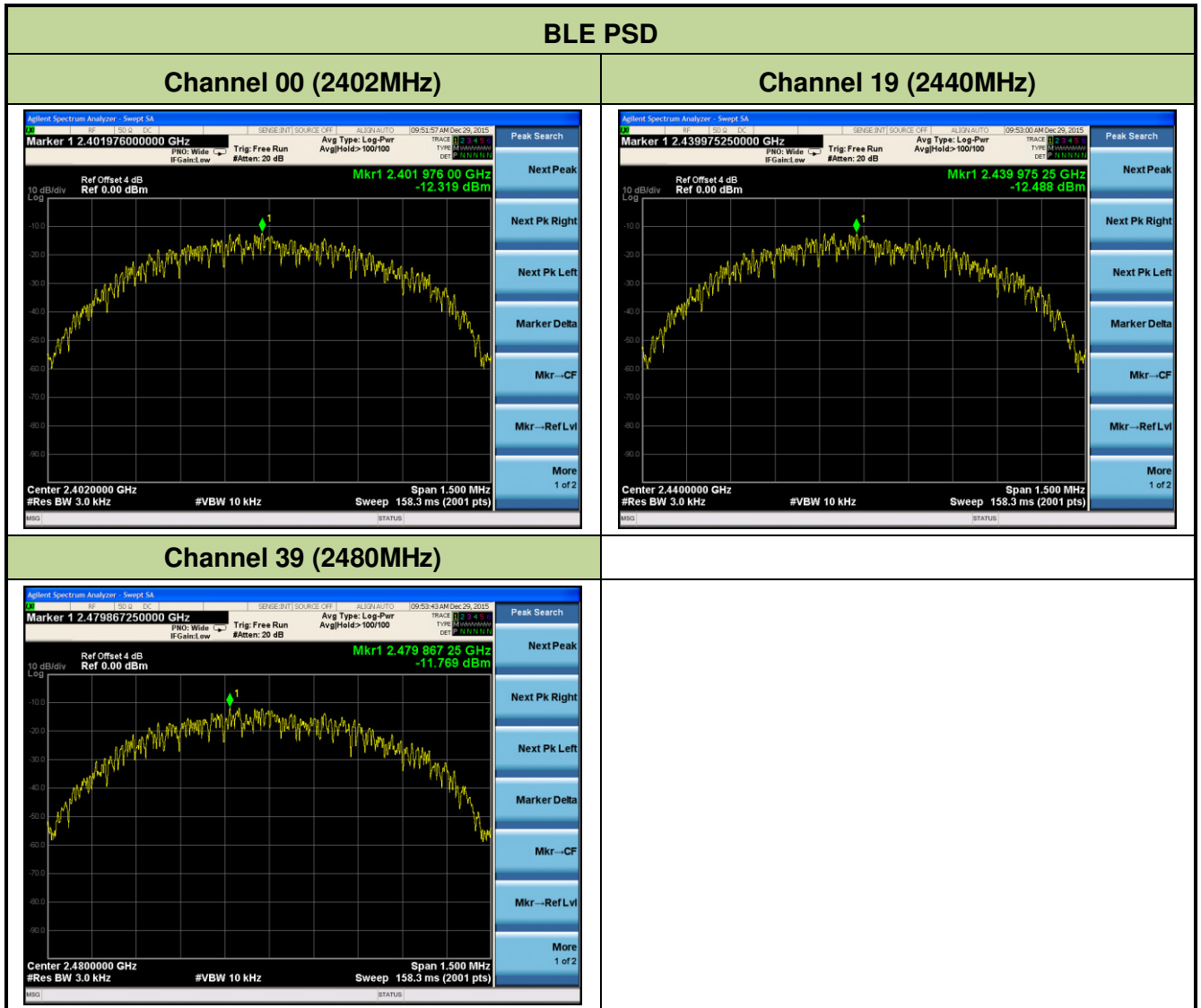

7.5. Conducted Band Edge and Out-of-Band Emissions

7.5.1. Test Limit

The limit for out-of-band spurious emissions at the band edge is 20dB below the fundamental emission level, as determined from the in-band power measurement of the DTS channel performed in a 100kHz bandwidth per the PSD procedure.

7.5.2. Test Procedure Used

KDB 558074 D01v03r04 - Section 11.2 & Section 11.3

7.5.3. Test Setting

1. Reference level measurement

- (a) Set instrument center frequency to DTS channel center frequency
- (b) Set the span to ≥ 1.5 times the DTS bandwidth
- (c) Set the RBW = 100 kHz
- (d) Set the VBW $\geq 3 \times$ RBW
- (e) Detector = peak
- (f) Sweep time = auto couple
- (g) Trace mode = max hold
- (h) Allow trace to fully stabilize

2. Emission level measurement

- (a) Set the center frequency and span to encompass frequency range to be measured
- (b) RBW = 100kHz
- (c) VBW = 300kHz
- (d) Detector = Peak
- (e) Number of sweep points $\geq 2 \times$ Span/RBW
- (f) Trace mode = max hold
- (g) Sweep time = auto couple
- (h) The trace was allowed to stabilize

7.5.4. Test Setup

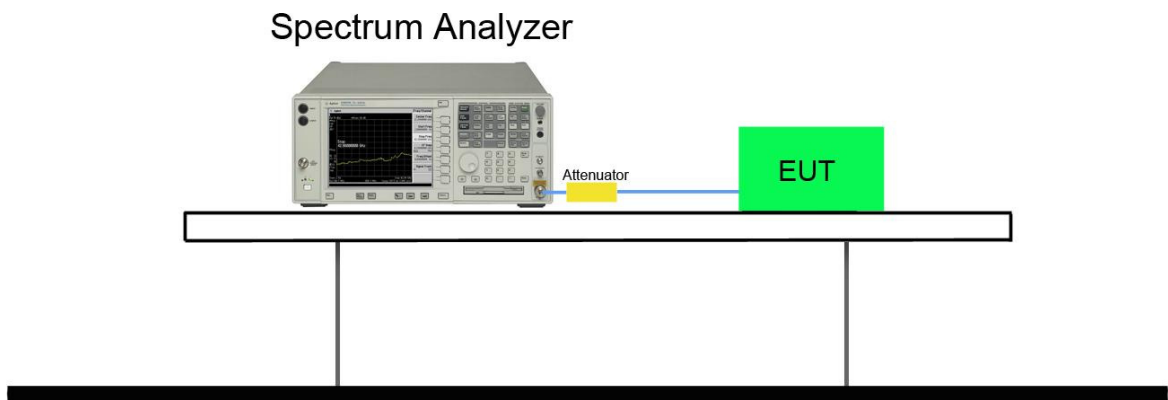

7.5.5. Test Result

Test Mode	Data Rate (Mbps)	Channel No.	Frequency (MHz)	Limit	Result
BLE	1	00	2402	20dBc	Pass
BLE	1	19	2440	20dBc	Pass
BLE	1	39	2480	20dBc	Pass

BLE Out-of-Band Emissions

Channel 00 (2402MHz)

100kHz PSD reference Level

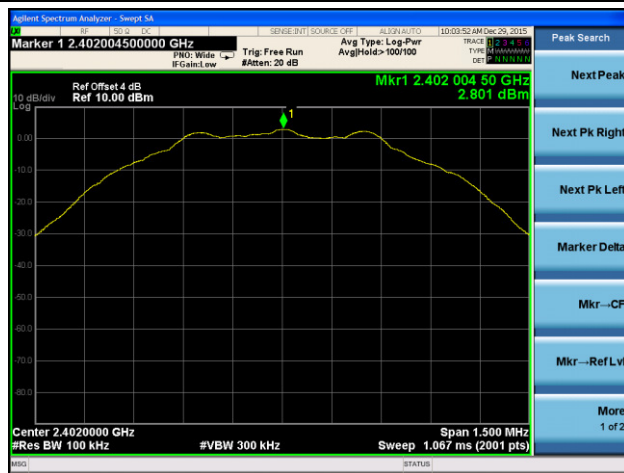

Low Band Edge

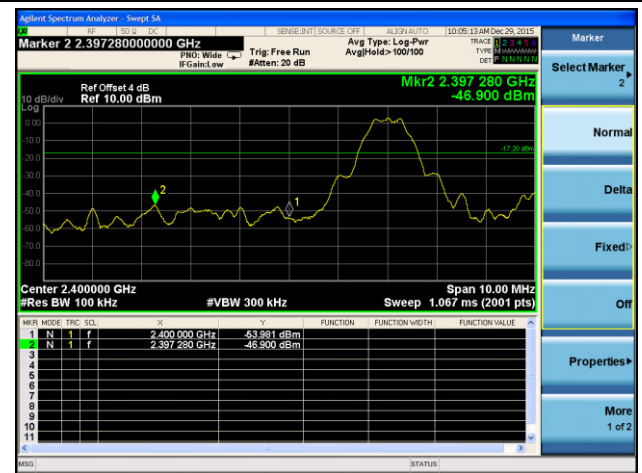

Spurious Emission 30MHz ~ 25GHz

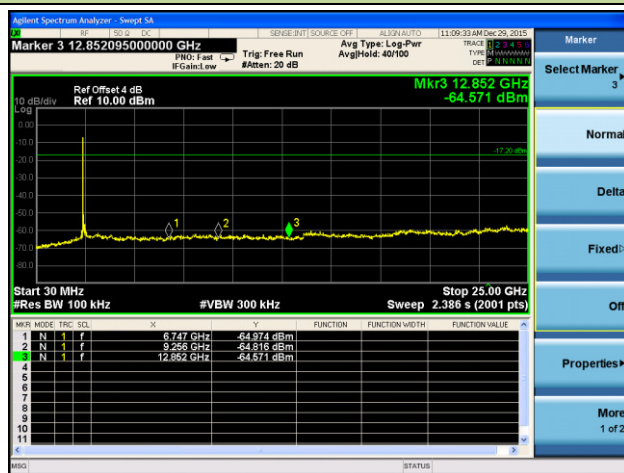

Channel 19 (2440MHz)

100kHz PSD reference Level



Spurious Emission 30MHz ~ 25GHz

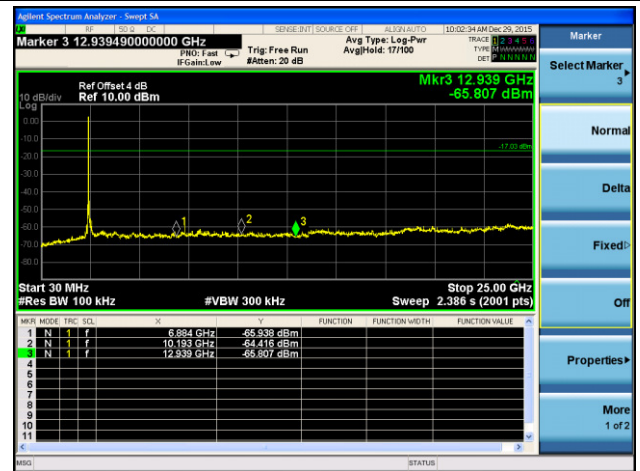

Channel 39 (2480MHz)

100kHz PSD reference Level

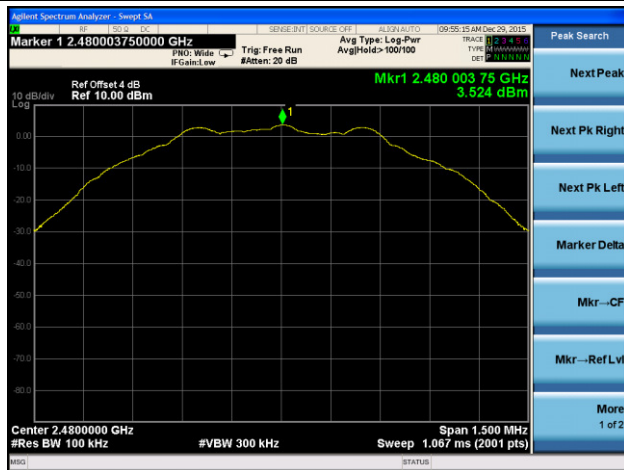

High Band Edge

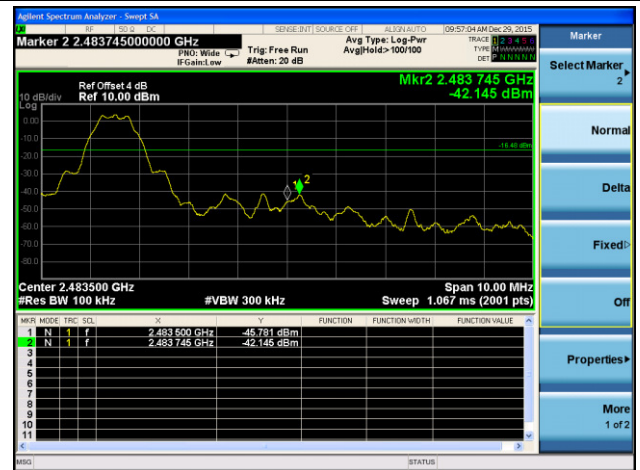

Spurious Emission 30MHz ~ 25GHz

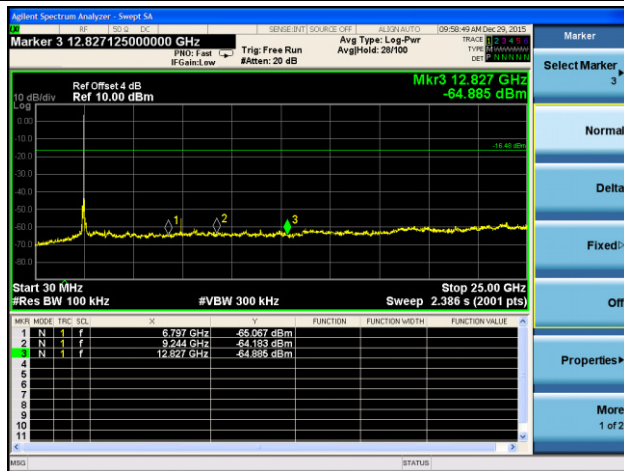

7.6. Radiated Spurious Emission Measurement

7.6.1. Test Limit

All out of band emissions appearing in a restricted band as specified in Section 15.205 of the Title 47 CFR must not exceed the limits shown in Table per Section 15.209.

FCC Part 15 Subpart C Paragraph 15.209		
Frequency [MHz]	Field Strength [V/m]	Measured Distance [Meters]
0.009 - 0.490	2400/F (kHz)	300
0.490 - 1.705	24000/F (kHz)	30
1.705 - 30	30	30
30 - 88	100	3
88 - 216	150	3
216 - 960	200	3
Above 960	500	3

7.6.2. Test Procedure Used

KDB 558074 D01v03r04 - Section 12.2.3 (quasi-peak measurements)

KDB 558074 D01v03r04 - Section 12.2.4 (peak power measurements)

KDB 558074 D01v03r04 - Section 12.2.5 (average power measurements)

7.6.3. Test Setting

Peak Field Strength Measurements per Section 12.2.4 of KDB 558074 D01v03r04

1. Analyzer center frequency was set to the frequency of the radiated spurious emission of interest
2. RBW = as specified in Table 1
3. VBW = 3MHz
4. Detector = peak
5. Sweep time = auto couple

6. Trace mode = max hold
7. Trace was allowed to stabilize

Table 1 - RBW as a function of frequency

Frequency	RBW
9 ~ 150 kHz	200 ~ 300 Hz
0.15 ~ 30 MHz	9 ~ 10 kHz
30 ~ 1000 MHz	100 ~ 120 kHz
> 1000 MHz	1 MHz

Average Field Strength Measurements per Section 12.2.5.3 of KDB 558074 D01v03r04

1. Analyzer center frequency was set to the frequency of the radiated spurious emission of interest
2. RBW = 1MHz
3. VBW $\geq 1/T$
4. De As an alternative, the instrument may be set to linear detector mode. Ensure that video filtering is applied in linear voltage domain (rather than in a log or dB domain). Some instruments require linear display mode in order to accomplish this. Others have a setting for Average-VBW Type, which can be set to "Voltage" regardless of the display mode
5. Detector = Peak
6. Sweep time = auto
7. Trace mode = max hold
8. Allow max hold to run for at least 50 times (1/duty cycle) traces

7.6.4. Test Setup

9kHz ~ 30MHz Test Setup:

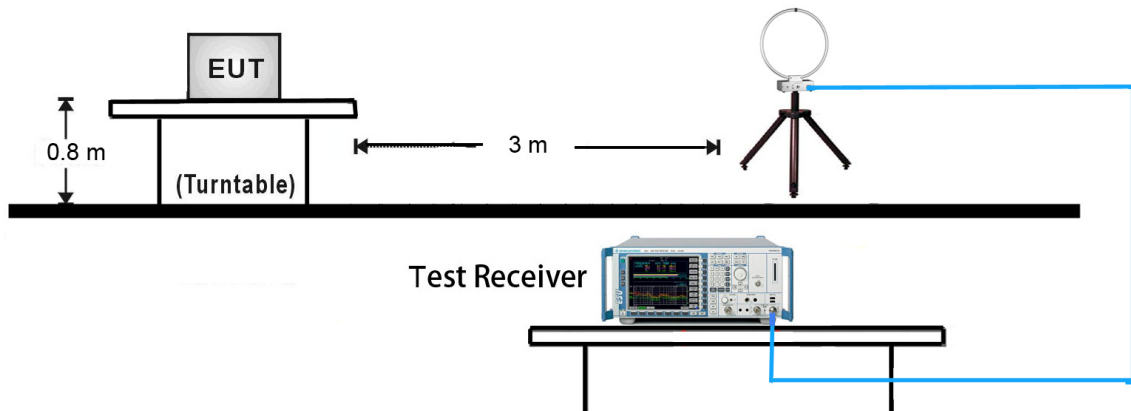

30MHz ~ 1GHz Test Setup:

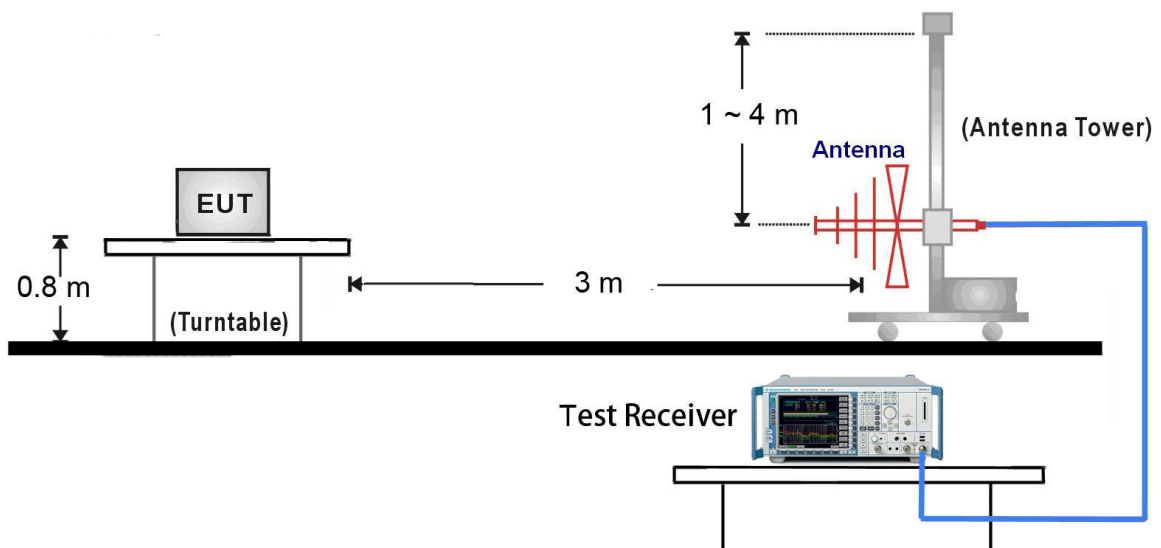

1GHz ~ 18GHz Test Setup:

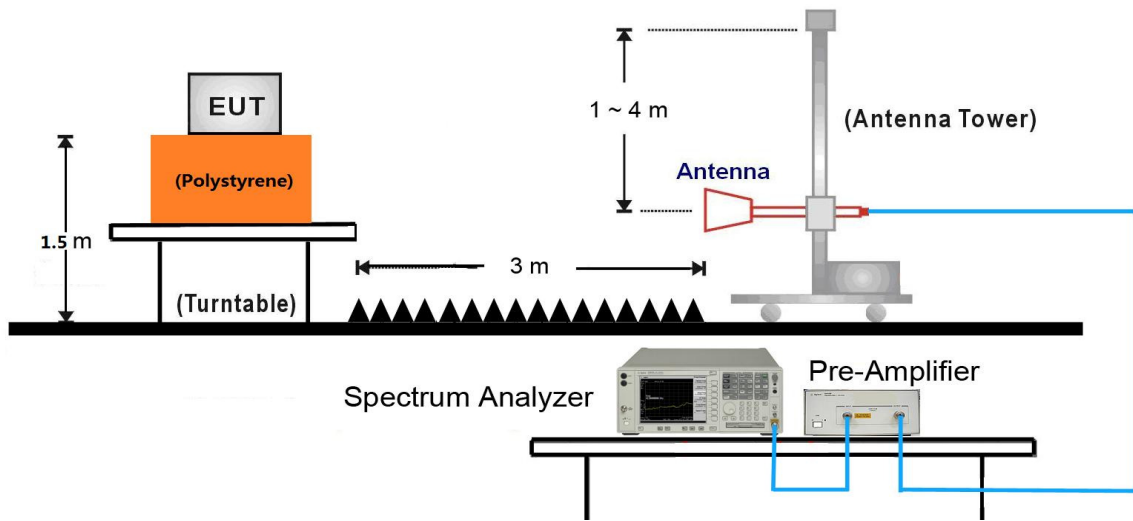

18GHz ~ 25GHz Test Setup:

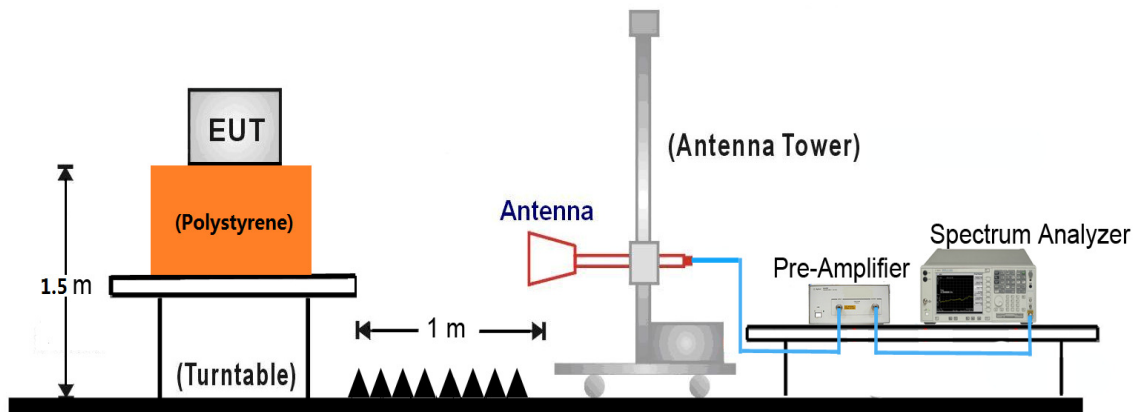

7.6.5. Test Result

Test Mode:	BLE	Test Site:	AC1
Test Channel:	00	Test Engineer:	Roy Cheng
Remark:	1. Average measurement was not performed if peak level lower than average limit. 2. Other frequency was 20dB below limit line within 1-18GHz, there is not show in the report.		

Mark	Frequency (MHz)	Reading Level (dBμV)	Factor (dB)	Measure Level (dBμV/m)	Limit (dBμV/m)	Margin (dB)	Detector	Polarization
	4808.0	47.6	2.0	49.6	74	-24.4	Peak	Horizontal
	7290.0	34.9	9.6	44.5	74	-29.5	Peak	Horizontal
*	8913.5	34.0	10.5	44.5	74	-29.5	Peak	Horizontal
*	9882.5	34.3	11.7	46.0	74	-28.0	Peak	Horizontal
	4808.0	41.4	2.0	43.4	74	-30.6	Peak	Vertical
	7655.5	35.1	9.6	44.7	74	-29.3	Peak	Vertical
*	8624.5	33.8	10.1	43.9	74	-30.1	Peak	Vertical
*	10307.5	34.2	13.2	47.4	74	-26.6	Peak	Vertical

Note 1: "*" is not in restricted band, its limit is 20dBc of the fundamental emission level (91.1dBμV/m) or 15.209 which is higher.

Note 2: Measure Level (dBμV/m) = Reading Level (dBμV) + Factor (dB)

Factor (dB) = Cable Loss (dB) + Antenna Factor (dB/m) - Pre_Amplifier Gain (dB)

Test Mode:	BLE	Test Site:	AC1
Test Channel:	19	Test Engineer:	Roy Cheng
Remark:	1. Average measurement was not performed if peak level lower than average limit. 2. Other frequency was 20dB below limit line within 1-18GHz, there is not show in the report.		

Mark	Frequency (MHz)	Reading Level (dB μ V)	Factor (dB)	Measure Level (dB μ V/m)	Limit (dB μ V/m)	Margin (dB)	Detector	Polarization
	4876.0	47.7	1.9	49.6	74	-24.4	Peak	Horizontal
	7324.0	36.3	9.6	45.9	74	-28.1	Peak	Horizontal
*	8752.0	34.0	10.4	44.4	74	-29.6	Peak	Horizontal
*	10596.5	34.6	14.0	48.6	74	-25.4	Peak	Horizontal
	4884.5	43.2	2.0	45.2	74	-28.8	Peak	Vertical
	7324.0	40.9	9.6	50.5	74	-23.5	Peak	Vertical
*	8947.5	34.7	10.4	45.1	74	-28.9	Peak	Vertical
*	10248.0	34.0	12.9	46.9	74	-27.1	Peak	Vertical

Note 1: "*" is not in restricted band, its limit is 20dBc of the fundamental emission level (90.3dB μ V/m) or 15.209 which is higher.

Note 2: Measure Level (dB μ V/m) = Reading Level (dB μ V) + Factor (dB)

Factor (dB) = Cable Loss (dB) + Antenna Factor (dB/m) - Pre_Amplifier Gain (dB)

Test Mode:	BLE	Test Site:	AC1
Test Channel:	39	Test Engineer:	Roy Cheng
Remark:	1. Average measurement was not performed if peak level lower than average limit. 2. Other frequency was 20dB below limit line within 1-18GHz, there is not show in the report.		

Mark	Frequency (MHz)	Reading Level (dBμV)	Factor (dB)	Measure Level (dBμV/m)	Limit (dBμV/m)	Margin (dB)	Detector	Polarization
	4961.0	47.8	1.9	49.7	74	-24.3	Peak	Horizontal
	7443.0	40.1	9.9	50.0	74	-24.0	Peak	Horizontal
*	8684.0	33.8	10.3	44.1	74	-29.9	Peak	Horizontal
*	10120.5	34.7	12.3	47.0	74	-27.0	Peak	Horizontal
	4961.0	42.8	1.9	44.7	74	-29.3	Peak	Vertical
	7443.0	43.7	9.9	53.6	74	-20.4	Peak	Vertical
*	8743.5	33.7	10.5	44.2	74	-29.8	Peak	Vertical
*	10367.0	33.2	13.5	46.7	74	-27.3	Peak	Vertical

Note 1: "*" is not in restricted band, its limit is 20dBc of the fundamental emission level (86.1dBμV/m) or 15.209 which is higher.

Note 2: Measure Level (dBμV/m) = Reading Level (dBμV) + Factor (dB)

Factor (dB) = Cable Loss (dB) + Antenna Factor (dB/m) - Pre_Amplifier Gain (dB)

The worst case of Radiated Emission below 1GHz:

Site: AC2	Time: 2015/12/30 - 11:27
Limit: FCC_Part15.209_RE(3m)	Engineer: Roy Cheng
Probe: VULB9162_0.03-8GHz	Polarity: Horizontal
EUT: QBee Remote Control	Power: DC 3V
Worse Case Mode: Transmit by BLE at channel 2402MHz	

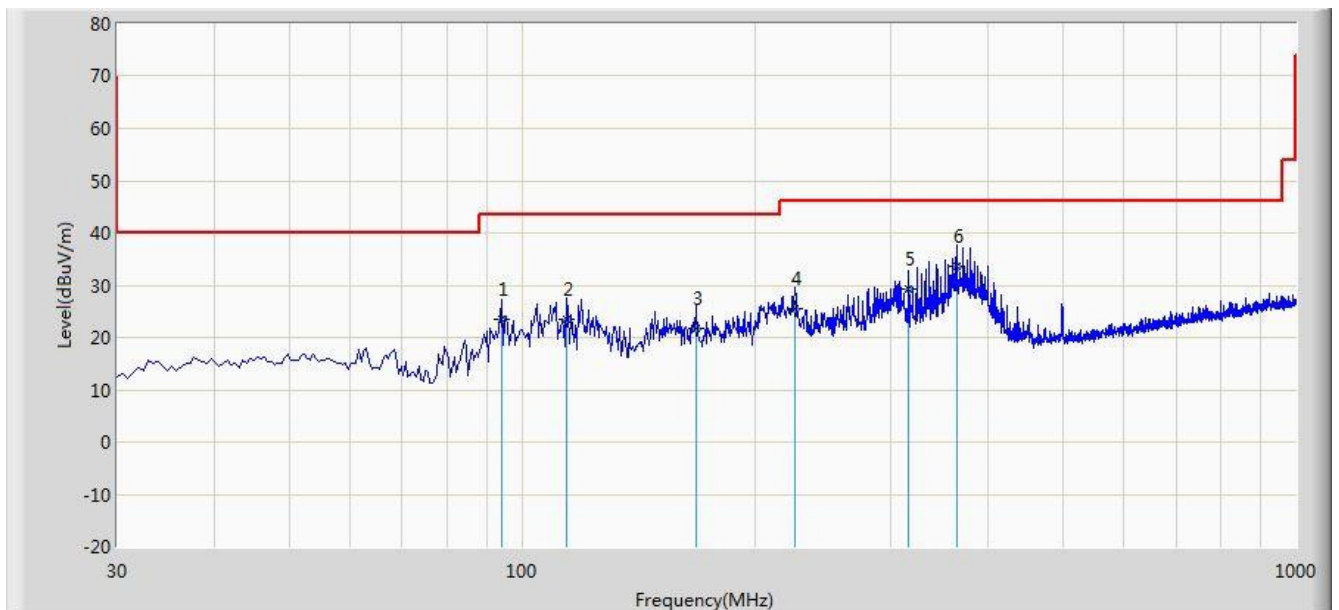

No	Flag	Mark	Frequency (MHz)	Measure Level (dBuV/m)	Reading Level (dBuV)	Over Limit (dB)	Limit (dBuV/m)	Factor (dB)	Type
1			94.020	23.448	11.240	-20.052	43.500	12.208	QP
2			114.390	23.544	11.360	-19.956	43.500	12.184	QP
3			168.225	21.659	11.470	-21.841	43.500	10.189	QP
4			224.970	25.504	12.640	-20.496	46.000	12.865	QP
5			316.150	29.349	14.370	-16.651	46.000	14.979	QP
6		*	364.165	33.561	17.480	-12.439	46.000	16.081	QP

Note: Measure Level (dB μ V/m) = Reading Level (dB μ V) + Factor (dB)

Factor (dB) = Cable Loss (dB) + Antenna Factor (dB/m)

Site: AC2	Time: 2015/12/30 - 11:29
Limit: FCC_Part15.209_RE(3m)	Engineer: Roy Cheng
Probe: VULB9162_0.03-8GHz	Polarity: Vertical
EUT: QBee Remote Control	Power: DC 3V
Worse Case Mode: Transmit by BLE at channel 2402MHz	

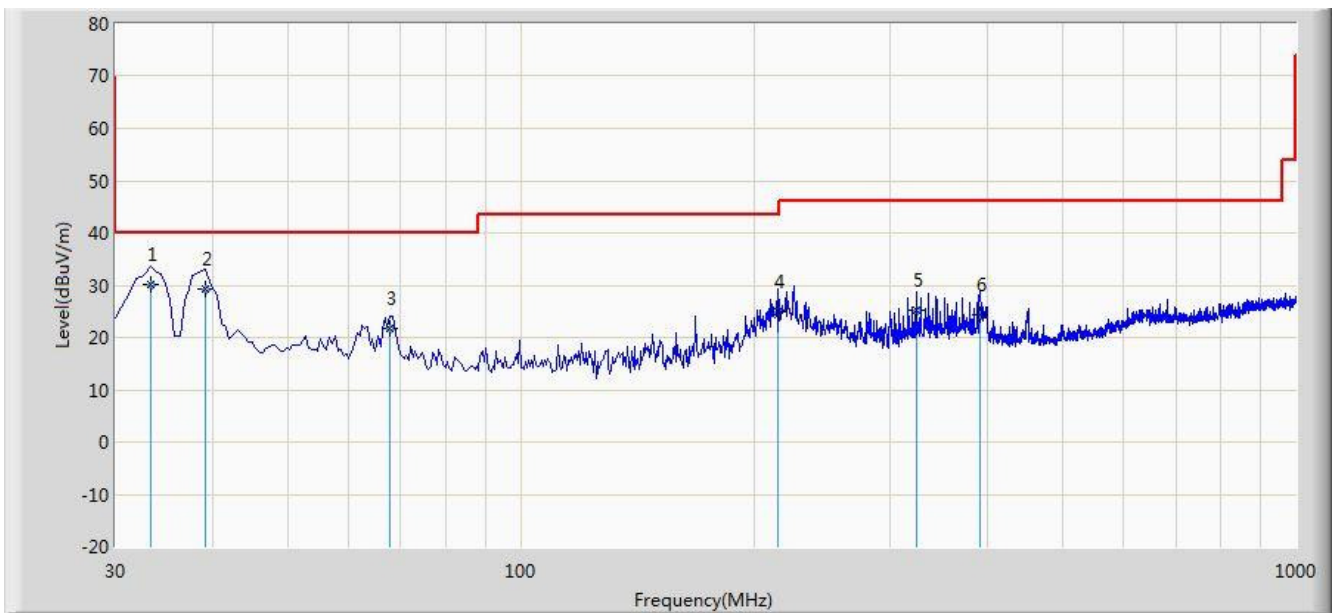

No	Flag	Mark	Frequency (MHz)	Measure Level (dBuV/m)	Reading Level (dBuV)	Over Limit (dB)	Limit (dBuV/m)	Factor (dB)	Type
1		*	33.395	30.287	17.640	-9.713	40.000	12.647	QP
2			39.215	29.178	15.470	-10.822	40.000	13.707	QP
3			67.830	21.635	10.030	-18.365	40.000	11.606	QP
4			214.300	24.911	12.390	-18.589	43.500	12.522	QP
5			323.910	25.341	10.140	-20.659	46.000	15.200	QP
6			391.810	24.246	7.690	-21.754	46.000	16.556	QP

Note: Measure Level (dB μ V/m) = Reading Level (dB μ V) + Factor (dB)

Factor (dB) = Cable Loss (dB) + Antenna Factor (dB/m)

Site: AC2	Time: 2015/12/30 - 15:32
Limit: FCC_Part15.209_RE(3m)	Engineer: Roy Cheng
Probe: FMZB1519_0.009-30MHz	Polarity: Face On
EUT: QBee Remote Control	Power: DC 3V
Note: There is the ambient noise within frequency range 9kHz~30MHz.	

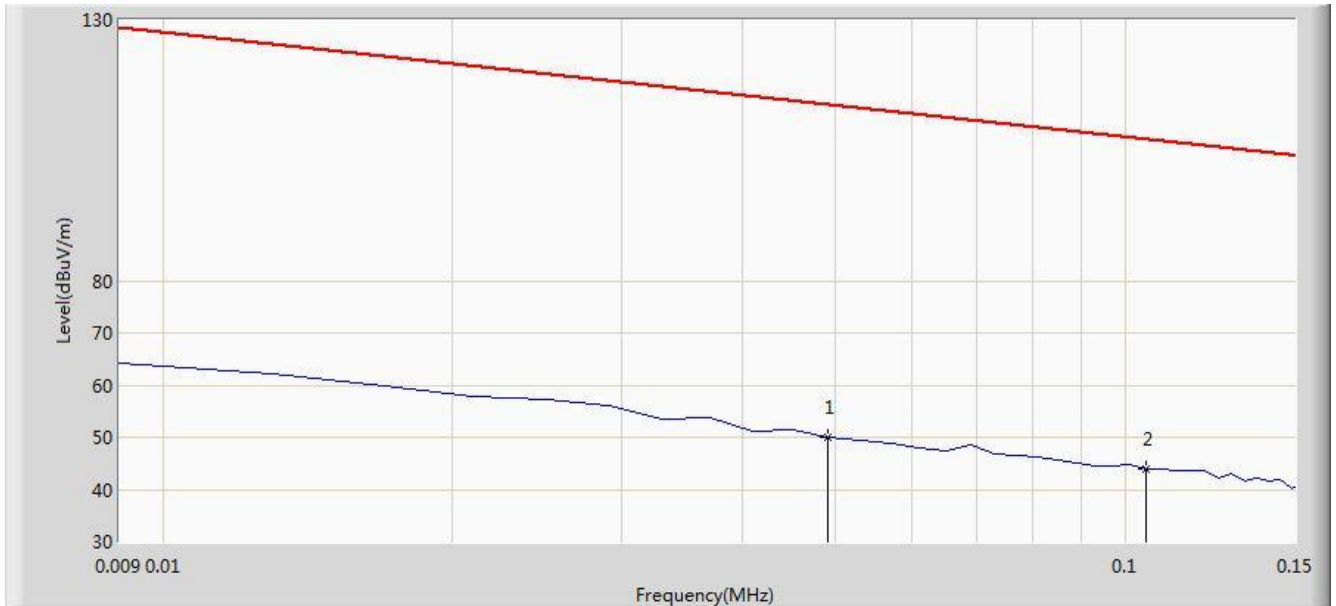

No	Flag	Mark	Frequency (MHz)	Measure Level (dBuV/m)	Reading Level (dBuV)	Over Limit (dB)	Limit (dBuV/m)	Factor (dB)	Type
1			0.049	50.112	29.552	-63.677	113.789	20.560	PK
2		*	0.105	44.043	23.845	-63.130	107.173	20.198	PK

Note: Measure Level (dB μ V/m) = Reading Level (dB μ V) + Factor (dB)

Factor (dB) = Cable Loss (dB) + Antenna Factor (dB/m)

Site: AC2	Time: 2015/12/30 - 15:32
Limit: FCC_Part15.209_RE(3m)	Engineer: Roy Cheng
Probe: FMZB1519_0.009-30MHz	Polarity: Face On
EUT: QBee Remote Control	Power: DC 3V
Note: There is the ambient noise within frequency range 9kHz~30MHz.	

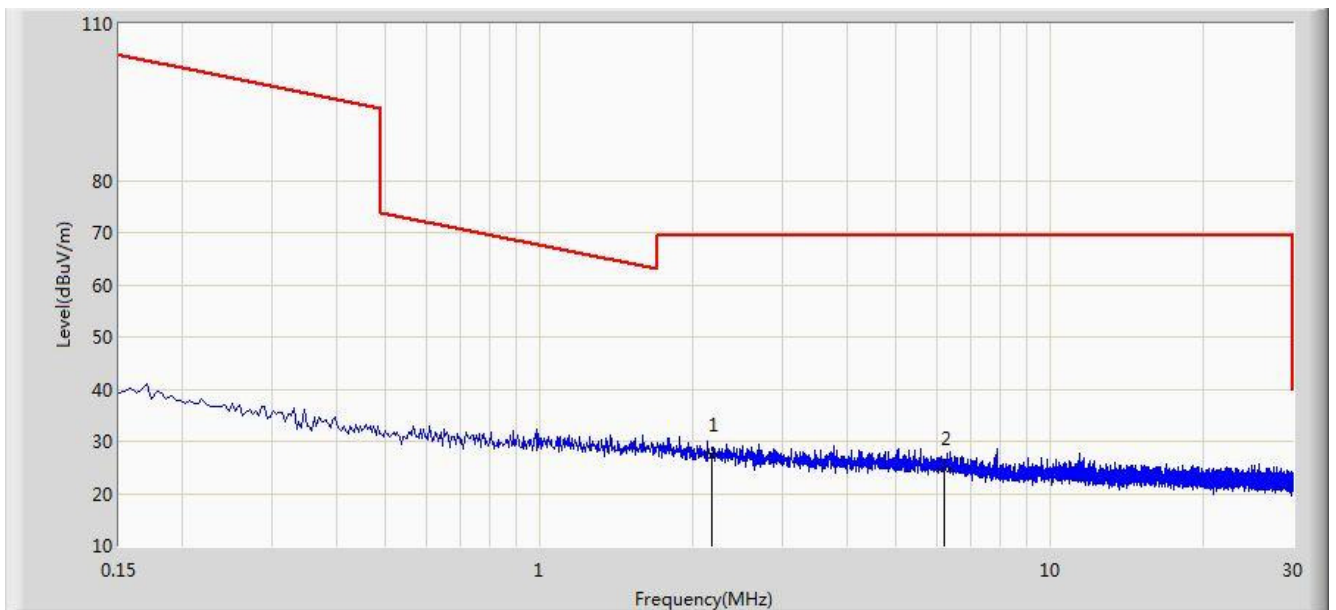

No	Flag	Mark	Frequency (MHz)	Measure Level (dBuV/m)	Reading Level (dBuV)	Over Limit (dB)	Limit (dBuV/m)	Factor (dB)	Type
1		*	2.175	27.371	6.960	-42.129	69.500	20.412	QP
2			6.216	24.786	4.701	-44.714	69.500	20.085	QP

Note: Measure Level (dB μ V/m) = Reading Level (dB μ V) + Factor (dB)

Factor (dB) = Cable Loss (dB) + Antenna Factor (dB/m)

Site: AC2	Time: 2015/12/30 - 15:32
Limit: FCC_Part15.209_RE(1m)	Engineer: Roy Cheng
Probe: BBHA9170_18-40GHz	Polarity: Horizontal
EUT: QBee Remote Control	Power: DC 3V
Note: There is the ambient noise within frequency range 18GHz~25GHz.	

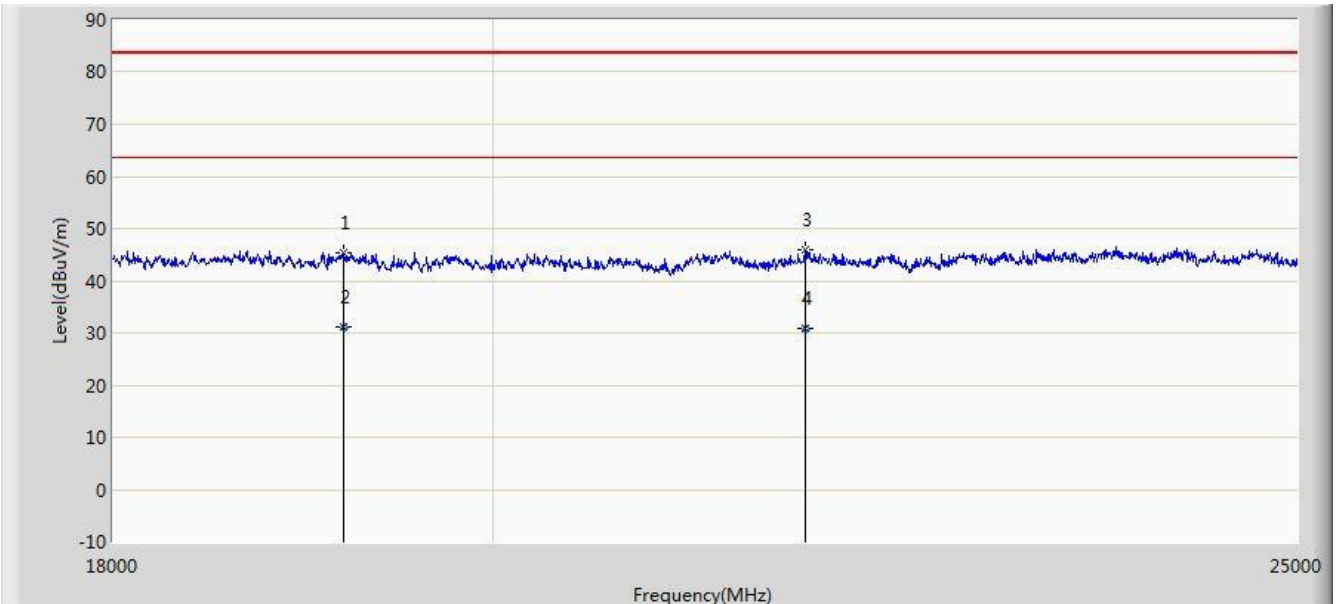

No	Flag	Mark	Frequency (MHz)	Measure Level (dBuV/m)	Reading Level (dBuV)	Over Limit (dB)	Limit (dBuV/m)	Factor (dB)	Type
1			19194.250	45.350	44.174	-38.150	83.500	1.176	PK
2		*	19194.250	31.296	30.120	-32.204	63.500	1.176	AV
3			21812.250	45.806	45.995	-37.694	83.500	-0.189	PK
4			21812.250	31.001	31.190	-32.499	63.500	-0.189	AV

Note: Measure Level (dB μ V/m) = Reading Level (dB μ V) + Factor (dB)

Factor (dB) = Cable Loss (dB) + Antenna Factor (dB/m) - Pre_Amplifier Gain (dB)

Site: AC2	Time: 2015/12/30 - 15:32
Limit: FCC_Part15.209_RE(1m)	Engineer: Roy Cheng
Probe: BBHA9170_18-40GHz	Polarity: Vertical
EUT: QBee Remote Control	Power: DC 3V
Note: There is the ambient noise within frequency range 18GHz~25GHz.	

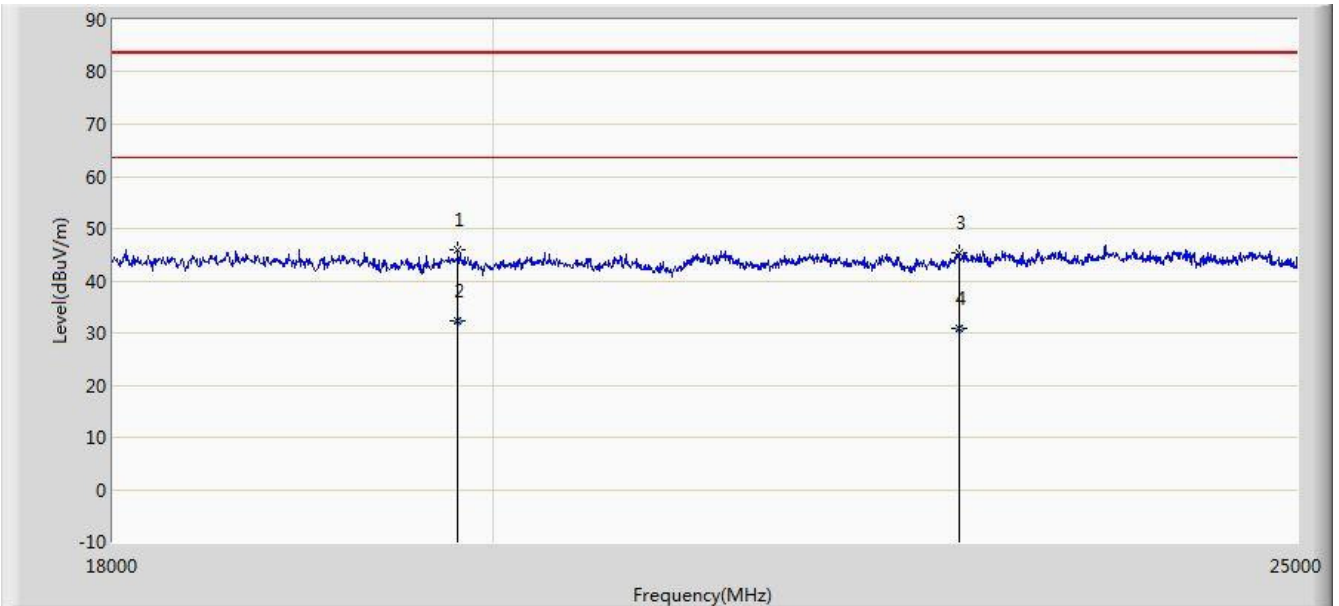

No	Flag	Mark	Frequency (MHz)	Measure Level (dBuV/m)	Reading Level (dBuV)	Over Limit (dB)	Limit (dBuV/m)	Factor (dB)	Type
1			19810.500	46.028	45.623	-37.472	83.500	0.405	PK
2		*	19810.500	32.225	31.820	-31.275	63.500	0.405	AV
3			22764.250	45.366	44.798	-38.134	83.500	0.568	PK
4			22764.250	30.798	30.230	-32.702	63.500	0.568	AV

Note: Measure Level (dB μ V/m) = Reading Level (dB μ V) + Factor (dB)

Factor (dB) = Cable Loss (dB) + Antenna Factor (dB/m) - Pre_Amplifier Gain (dB)

7.7. Radiated Restricted Band Edge Measurement

7.7.1. Test Result

Site: AC2	Time: 2015/12/30 - 13:56
Limit: FCC_Part15.209_RE(3m)	Engineer: Lewis Huang
Probe: BBHA9120D_1-18GHz	Polarity: Horizontal
EUT: QBee Remote Control	Power: DC 3V
Test Mode: Transmit by BLE at Channel 2402MHz	

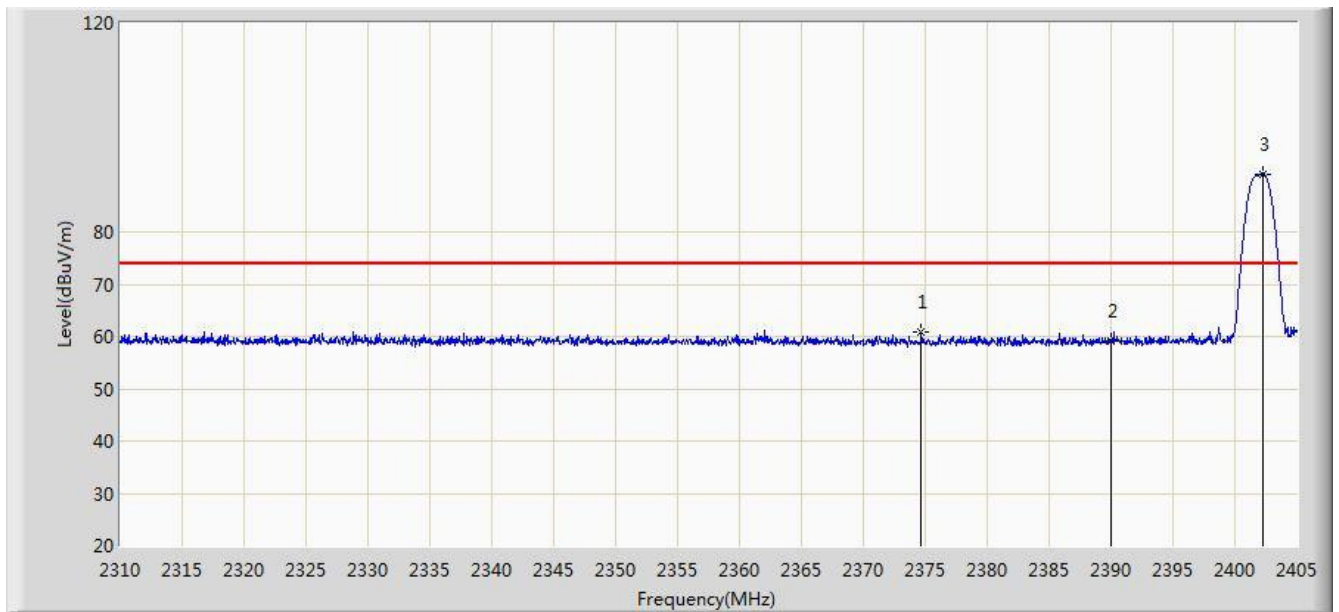

No	Flag	Mark	Frequency (MHz)	Measure Level (dBuV/m)	Reading Level (dBuV)	Over Limit (dB)	Limit (dBuV/m)	Factor (dB)	Type
1			2374.695	60.975	28.611	-13.025	74.000	32.364	PK
2			2390.000	59.226	26.858	-14.774	74.000	32.368	PK
3		*	2402.292	91.127	58.781	N/A	N/A	32.346	PK

Note: Measure Level (dB μ V/m) = Reading Level (dB μ V) + Factor (dB)

Factor (dB) = Cable Loss (dB) + Antenna Factor (dB/m)

Site: AC2	Time: 2015/12/30 - 13:59
Limit: FCC_Part15.209_RE(3m)	Engineer: Lewis Huang
Probe: BBHA9120D_1-18GHz	Polarity: Horizontal
EUT: QBee Remote Control	Power: DC 3V
Test Mode: Transmit by BLE at Channel 2402MHz	

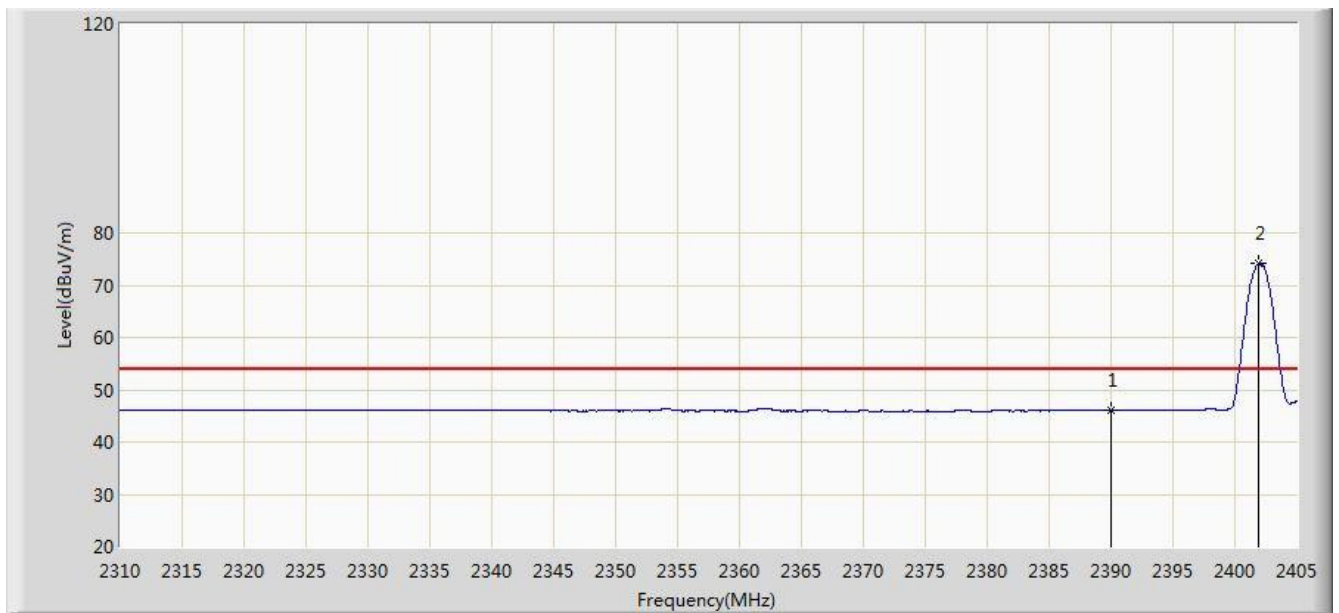

No	Flag	Mark	Frequency (MHz)	Measure Level (dBuV/m)	Reading Level (dBuV)	Over Limit (dB)	Limit (dBuV/m)	Factor (dB)	Type
1			2390.000	46.062	13.694	-7.938	54.000	32.368	AV
2		*	2401.913	74.207	41.860	N/A	N/A	32.347	AV

Note: Measure Level (dB μ V/m) = Reading Level (dB μ V) + Factor (dB)

Factor (dB) = Cable Loss (dB) + Antenna Factor (dB/m)

Site: AC2	Time: 2015/12/30 - 13:59
Limit: FCC_Part15.209_RE(3m)	Engineer: Lewis Huang
Probe: BBHA9120D_1-18GHz	Polarity: Vertical
EUT: QBee Remote Control	Power: DC 3V
Test Mode: Transmit by BLE at Channel 2402MHz	

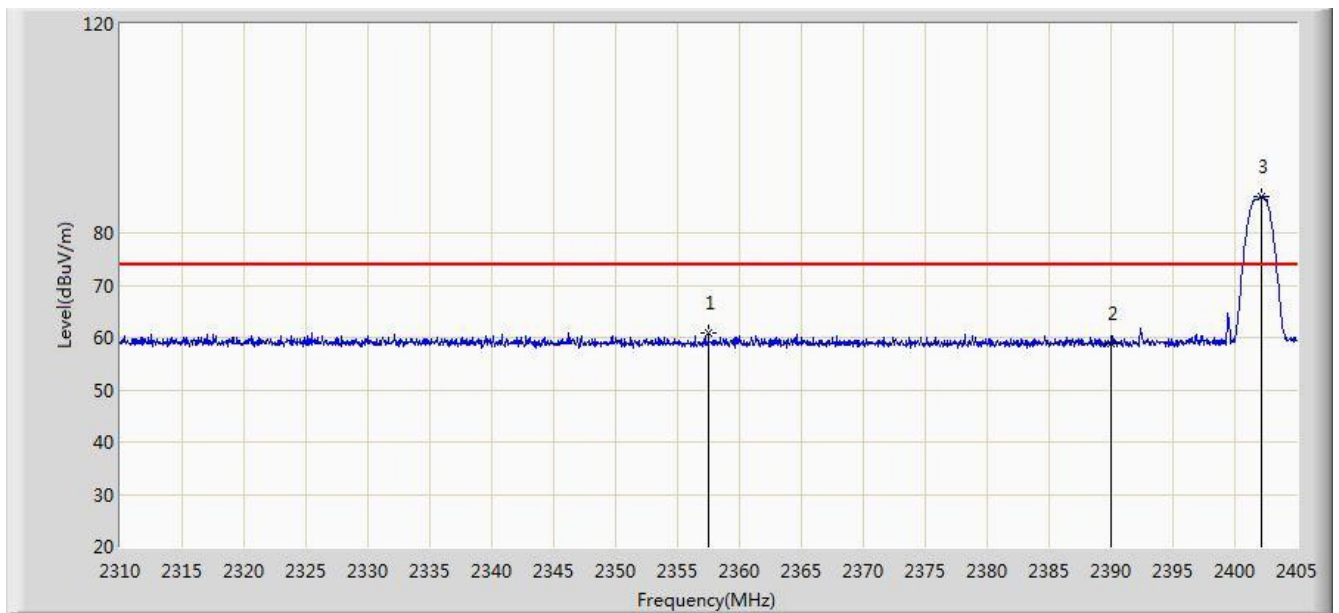

No	Flag	Mark	Frequency (MHz)	Measure Level (dBuV/m)	Reading Level (dBuV)	Over Limit (dB)	Limit (dBuV/m)	Factor (dB)	Type
1			2357.500	60.870	28.450	-13.130	74.000	32.420	PK
2			2390.000	58.730	26.362	-15.270	74.000	32.368	PK
3		*	2402.198	87.018	54.672	N/A	N/A	32.346	PK

Note: Measure Level (dB μ V/m) = Reading Level (dB μ V) + Factor (dB)

Factor (dB) = Cable Loss (dB) + Antenna Factor (dB/m)

Site: AC2	Time: 2015/12/30 - 14:04
Limit: FCC_Part15.209_RE(3m)	Engineer: Lewis Huang
Probe: BBHA9120D_1-18GHz	Polarity: Vertical
EUT: QBee Remote Control	Power: DC 3V
Test Mode: Transmit by BLE at Channel 2402MHz	

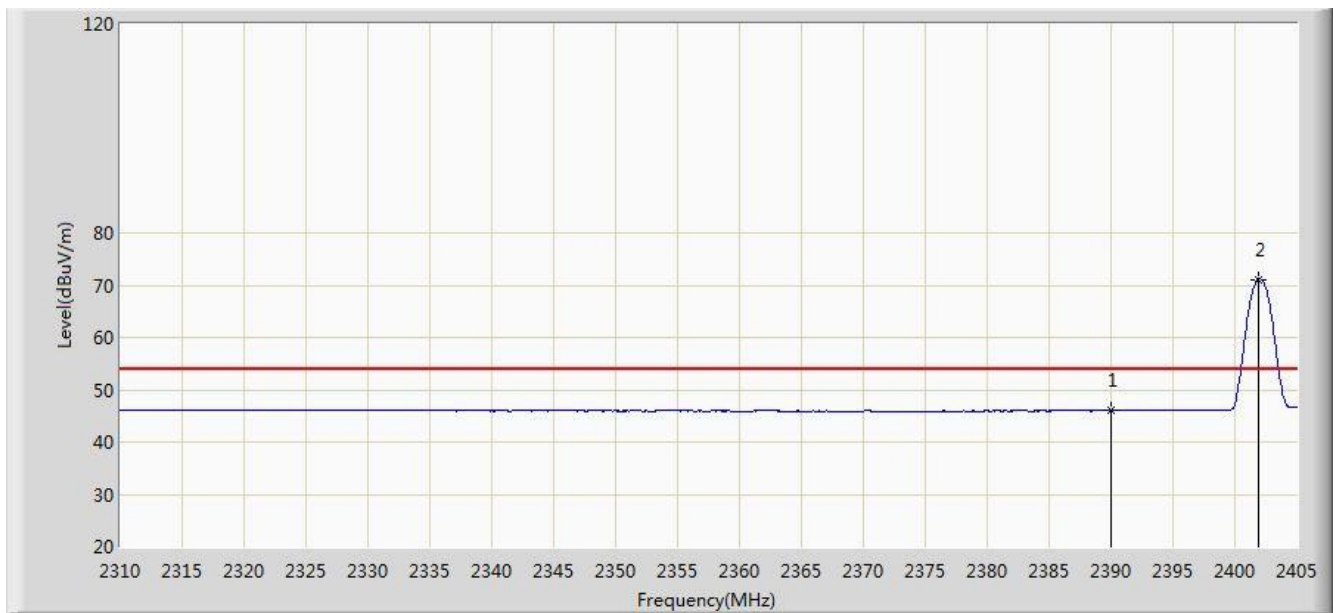

No	Flag	Mark	Frequency (MHz)	Measure Level (dBuV/m)	Reading Level (dBuV)	Over Limit (dB)	Limit (dBuV/m)	Factor (dB)	Type
1			2390.000	46.029	13.661	-7.971	54.000	32.368	AV
2		*	2401.913	71.148	38.801	N/A	N/A	32.347	AV

Note: Measure Level (dB μ V/m) = Reading Level (dB μ V) + Factor (dB)

Factor (dB) = Cable Loss (dB) + Antenna Factor (dB/m)

Site: AC2	Time: 2015/12/30 - 14:06
Limit: FCC_Part15.209_RE(3m)	Engineer: Lewis Huang
Probe: BBHA9120D_1-18GHz	Polarity: Horizontal
EUT: QBee Remote Control	Power: DC 3V
Test Mode: Transmit by BLE at Channel 2480MHz	

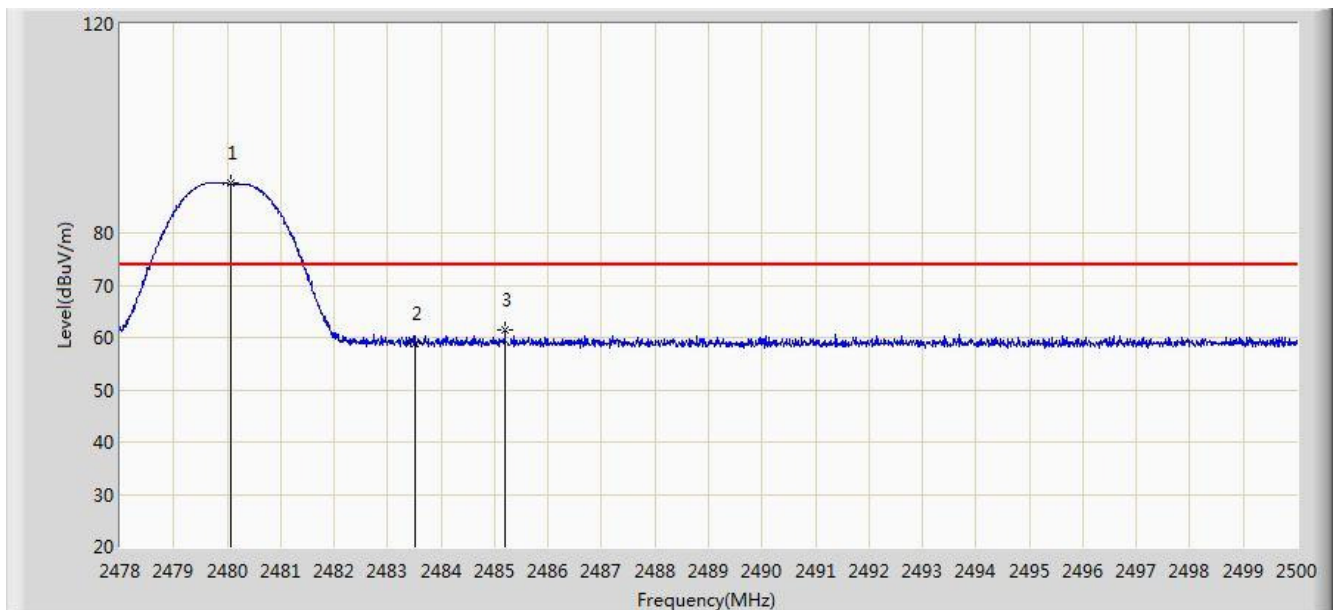

No	Flag	Mark	Frequency (MHz)	Measure Level (dBuV/m)	Reading Level (dBuV)	Over Limit (dB)	Limit (dBuV/m)	Factor (dB)	Type
1		*	2480.057	89.423	57.080	N/A	N/A	32.343	PK
2			2483.500	58.857	26.508	-15.143	74.000	32.349	PK
3			2485.194	61.552	29.200	-12.448	74.000	32.352	PK

Note: Measure Level (dB μ V/m) = Reading Level (dB μ V) + Factor (dB)

Factor (dB) = Cable Loss (dB) + Antenna Factor (dB/m)

Site: AC2	Time: 2015/12/30 - 14:09
Limit: FCC_Part15.209_RE(3m)	Engineer: Lewis Huang
Probe: BBHA9120D_1-18GHz	Polarity: Horizontal
EUT: QBee Remote Control	Power: DC 3V
Test Mode: Transmit by BLE at Channel 2480MHz	

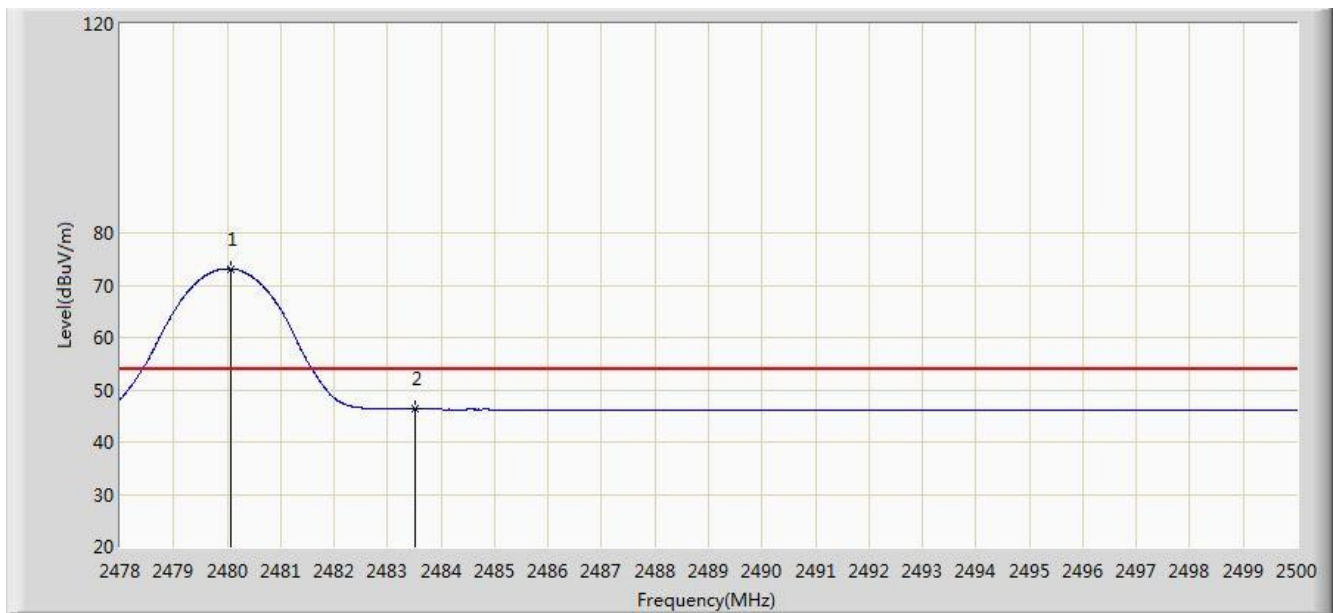

No	Flag	Mark	Frequency (MHz)	Measure Level (dBuV/m)	Reading Level (dBuV)	Over Limit (dB)	Limit (dBuV/m)	Factor (dB)	Type
1		*	2480.079	73.164	40.821	N/A	N/A	32.343	AV
2			2483.500	46.297	13.948	-7.703	54.000	32.349	AV

Note: Measure Level (dB μ V/m) = Reading Level (dB μ V) + Factor (dB)

Factor (dB) = Cable Loss (dB) + Antenna Factor (dB/m)

Site: AC2	Time: 2015/12/30 - 14:09
Limit: FCC_Part15.209_RE(3m)	Engineer: Lewis Huang
Probe: BBHA9120D_1-18GHz	Polarity: Vertical
EUT: QBee Remote Control	Power: DC 3V
Test Mode: Transmit by BLE at Channel 2480MHz	

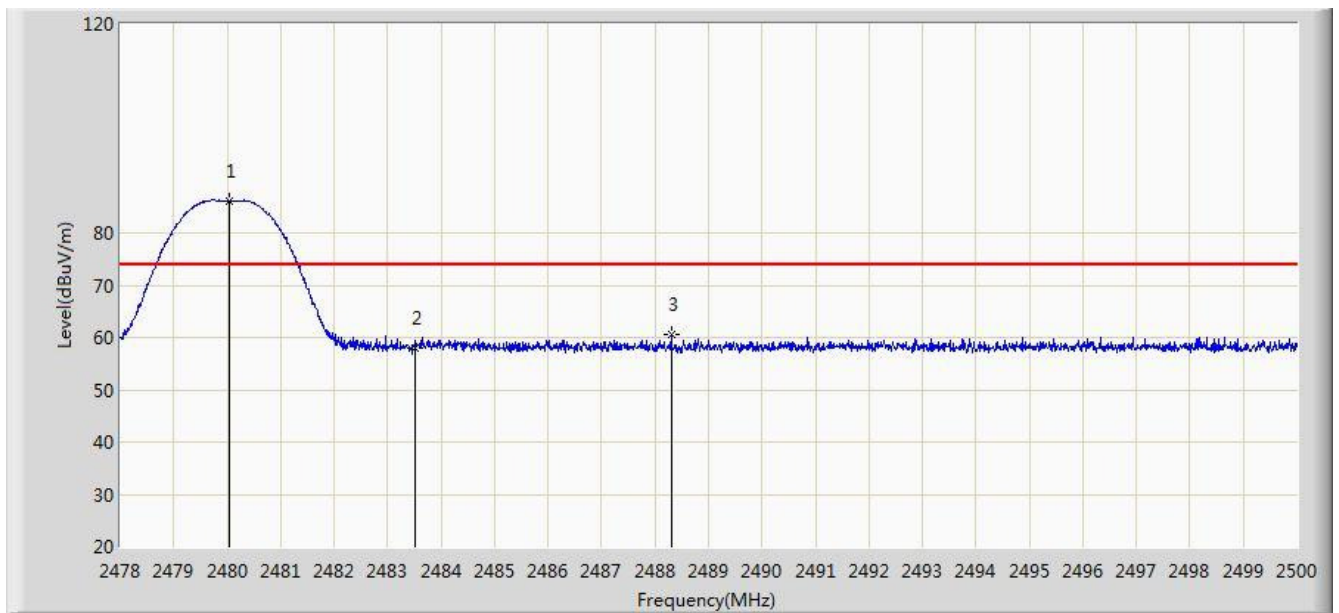

No	Flag	Mark	Frequency (MHz)	Measure Level (dBuV/m)	Reading Level (dBuV)	Over Limit (dB)	Limit (dBuV/m)	Factor (dB)	Type
1		*	2480.046	86.129	53.786	N/A	N/A	32.343	PK
2			2483.500	57.977	25.628	-16.023	74.000	32.349	PK
3			2488.307	60.690	28.333	-13.310	74.000	32.356	PK

Note: Measure Level (dB μ V/m) = Reading Level (dB μ V) + Factor (dB)

Factor (dB) = Cable Loss (dB) + Antenna Factor (dB/m)

Site: AC2	Time: 2015/12/30 - 14:12
Limit: FCC_Part15.209_RE(3m)	Engineer: Lewis Huang
Probe: BBHA9120D_1-18GHz	Polarity: Vertical
EUT: QBee Remote Control	Power: DC 3V
Test Mode: Transmit by BLE at Channel 2480MHz	

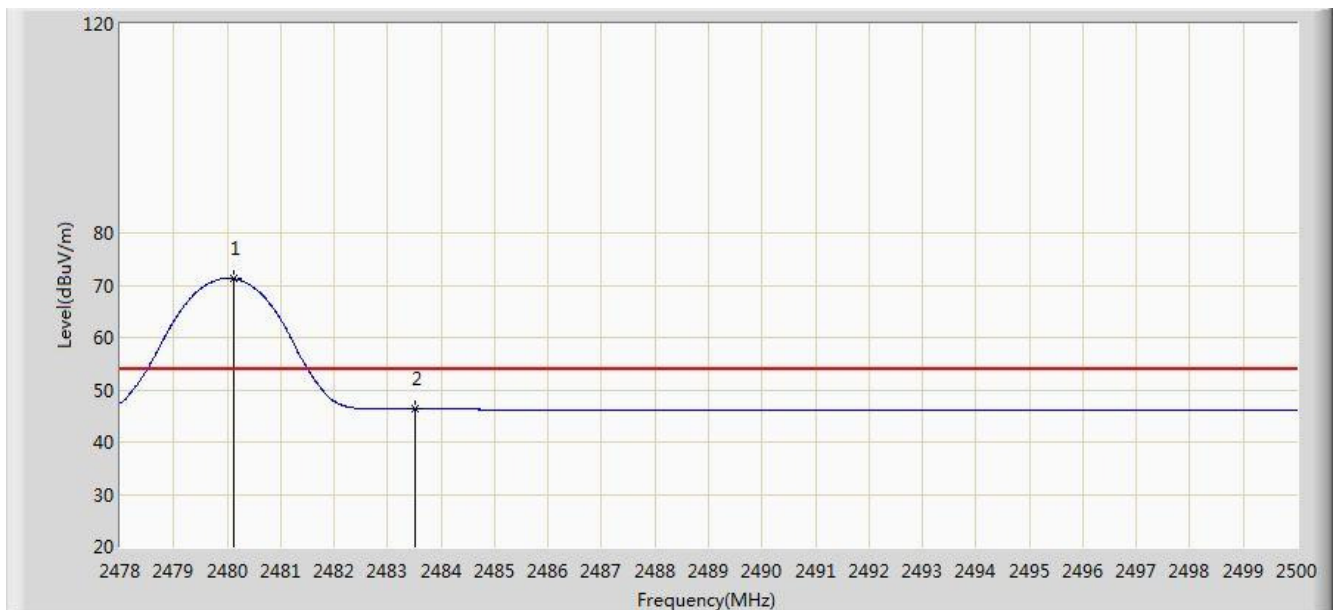

No	Flag	Mark	Frequency (MHz)	Measure Level (dBuV/m)	Reading Level (dBuV)	Over Limit (dB)	Limit (dBuV/m)	Factor (dB)	Type
1		*	2480.112	71.250	38.907	N/A	N/A	32.343	AV
2			2483.500	46.327	13.978	-7.673	54.000	32.349	AV

Note: Measure Level (dB μ V/m) = Reading Level (dB μ V) + Factor (dB)

Factor (dB) = Cable Loss (dB) + Antenna Factor (dB/m)

7.8. AC Conducted Emissions Measurement

7.8.1. Test Limit

FCC Part 15 Subpart C Paragraph 15.207 Limits		
Frequency (MHz)	QP (dBuV)	AV (dBuV)
0.15 - 0.50	66 - 56	56 - 46
0.50 - 5.0	56	46
5.0 - 30	60	50

Note 1: The lower limit shall apply at the transition frequencies.

Note 2: The limit decreases linearly with the logarithm of the frequency in the range 0.15MHz to 0.5MHz.

7.8.2. Test Setup

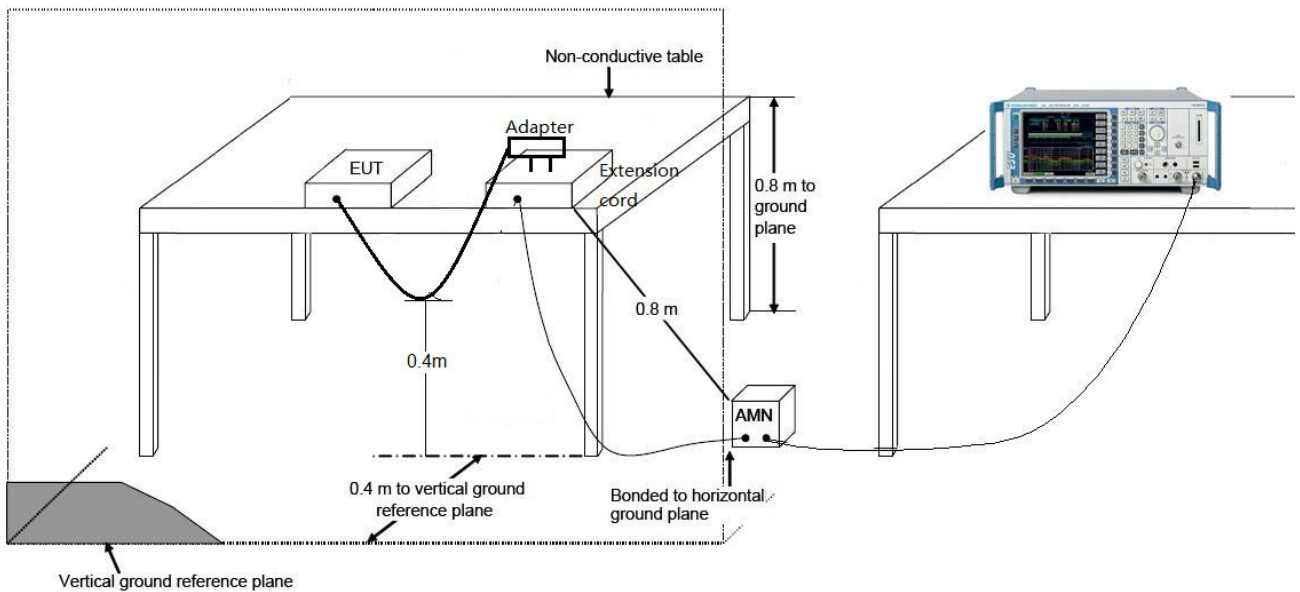

7.8.3. Test Result

The EUT was powered on by the battery, so the test item need not be performed.

8. CONCLUSION

The data collected relate only the item(s) tested and show that the **QBe Remote Control FCC ID: H8N-QBREMOTE** is in compliance with Part 15C of the FCC Rules.

————— The End —————