

FCC Test Report

(Part 27: LTE Band 4, 13)

Report No.: RF160621C08-10

FCC ID: H8N-PCT5230

Test Model: ADR1776

Received Date: Jun. 21, 2016

Test Date: Aug. 03 ~ Aug. 24, 2016

Issued Date: Aug. 25, 2016

Applicant: ASKEY COMPUTER CORP.

Address: 10F, NO. 119, JIANKANG RD., ZHONGHE DIST., NEW TAIPEI CITY
23585, TAIWAN, R.O.C.

Issued By: Bureau Veritas Consumer Products Services (H.K.) Ltd., Taoyuan Branch

Lab Address: No. 47-2, 14th Ling, Chia Pau Vil., Lin Kou Dist., New Taipei City, Taiwan,
R.O.C.

Test Location: No. 19, Hwa Ya 2nd Rd., Wen Hwa Vil., Kwei Shan Dist., Taoyuan City
33383, TAIWAN (R.O.C.)



This report is for your exclusive use. Any copying or replication of this report to or for any other person or entity, or use of our name or trademark, is permitted only with our prior written permission. This report sets forth our findings solely with respect to the test samples identified herein. The results set forth in this report are not indicative or representative of the quality or characteristics of the lot from which a test sample was taken or any similar or identical product unless specifically and expressly noted. Our report includes all of the tests requested by you and the results thereof based upon the information that you provided to us. You have 60 days from date of issuance of this report to notify us of any material error or omission caused by our negligence, provided, however, that such notice shall be in writing and shall specifically address the issue you wish to raise. A failure to raise such issue within the prescribed time shall constitute your unqualified acceptance of the completeness of this report, the tests conducted and the correctness of the report contents. Unless specific mention, the uncertainty of measurement has been explicitly taken into account to declare the compliance or non-compliance to the specification. The report must not be used by the client to claim product certification, approval, or endorsement by TAF or any government agency

Table of Contents

Release Control Record	3
1 Certificate of Conformity	4
2 Summary of Test Results	5
2.1 Measurement Uncertainty.....	5
2.2 Test Site and Instruments.....	6
3 General Information	7
3.1 General Description of EUT.....	7
3.2 Configuration of System under Test.....	8
3.2.1 Description of Support Units.....	8
3.3 Test Mode Applicability and Tested Channel Detail.....	9
3.4 EUT Operating Conditions.....	12
3.5 General Description of Applied Standards.....	12
4 Test Types and Results	13
4.1 Output Power Measurement.....	13
4.1.1 Limits of Output Power Measurement.....	13
4.1.2 Test Procedures.....	13
4.1.3 Test Setup.....	14
4.1.4 Test Results.....	15
4.2 Frequency Stability Measurement.....	26
4.2.1 Limits of Frequency Stability Measurement.....	26
4.2.2 Test Procedure.....	26
4.2.3 Test Setup.....	26
4.2.4 Test Results.....	27
4.3 Emission Bandwidth Measurement.....	28
4.3.1 Limits of Emission Bandwidth Measurement.....	28
4.3.2 Test Procedure.....	28
4.3.3 Test Setup.....	28
4.3.4 Test Result.....	29
4.4 Channel Edge Measurement.....	37
4.4.1 Limits of Band Edge Measurement.....	37
4.4.2 Test Setup.....	37
4.4.3 Test Procedures.....	37
4.4.4 Test Results.....	38
4.5 Peak to Average Ratio.....	46
4.5.1 Limits of Peak to Average Ratio Measurement.....	46
4.5.2 Test Setup.....	46
4.5.3 Test Procedures.....	46
4.5.4 Test Results.....	47
4.6 Conducted Spurious Emissions.....	54
4.6.1 Limits of Conducted Spurious Emissions Measurement.....	54
4.6.2 Test Setup.....	54
4.6.3 Test Procedure.....	54
4.6.4 Test Results.....	55
4.7 Radiated Emission Measurement.....	77
4.7.1 Limits of Radiated Emission Measurement.....	77
4.7.2 Test Procedure.....	77
4.7.3 Deviation from Test Standard.....	77
4.7.4 Test Setup.....	78
4.7.5 Test Results.....	79
5 Pictures of Test Arrangements	102
Appendix – Information on the Testing Laboratories	103

Release Control Record

Issue No.	Description	Date Issued
RF160621C08-10	Original release.	Aug. 25, 2016

1 Certificate of Conformity

Product: Smart Phone

Brand: Turbonet

Test Model: ADR1776

Sample Status: Engineering sample

Applicant: ASKEY COMPUTER CORP.

Test Date: Aug. 03 ~ Aug. 24, 2016

Standards: FCC Part 27, Subpart C

The above equipment has been tested by **Bureau Veritas Consumer Products Services (H.K.) Ltd., Taoyuan Branch**, and found compliance with the requirement of the above standards. The test record, data evaluation & Equipment Under Test (EUT) configurations represented herein are true and accurate accounts of the measurements of the sample's EMC characteristics under the conditions specified in this report.

Prepared by :  , **Date:** Aug. 25, 2016
Pettie Chen / Senior Specialist

Approved by :  , **Date:** Aug. 25, 2016
Dylan Chiou / Project Engineer

2 Summary of Test Results

Applied Standard: FCC Part 27 & Part 2				
FCC Clause		Test Item	Result	Remarks
LTE Band 4	LTE Band 13			
2.1046 27.50(d)(4)	2.1046 27.50(b)(10)	Equivalent Isotropically Radiated Power	Pass	Meet the requirement of limit.
----	----	Peak To Average Ratio	Pass	Meet the requirement of limit.
2.1055 27.54	2.1055 27.54	Frequency Stability Stay with the authorized bands of operation	Pass	Meet the requirement of limit.
2.1049 27.53(m)(6)	2.1049 27.53(m)(6)	Emission Bandwidth	Pass	Meet the requirement of limit.
2.1051 27.53(h)	2.1051 27.53(c)	Band Edge Measurements	Pass	Meet the requirement of limit.
2.1051 27.53(h)	2.1051 27.53(c)	Conducted Spurious Emissions	Pass	Meet the requirement of limit.
2.1051 27.53(h)	2.1051 27.53(c)	Radiated Spurious Emissions	Pass	Meet the requirement of limit. Minimum passing margin is -24.10dB at 30.00MHz.

2.1 Measurement Uncertainty

Where relevant, the following measurement uncertainty levels have been estimated for tests performed on the EUT as specified in CISPR 16-4-2:

Measurement	Frequency	Expanded Uncertainty (k=2) (±)
Radiated Emissions up to 1 GHz	30MHz ~ 200MHz	3.63 dB
	200MHz ~1000MHz	3.64 dB
Radiated Emissions above 1 GHz	1GHz ~ 18GHz	2.29 dB
	18GHz ~ 40GHz	2.29 dB

2.2 Test Site and Instruments

Description & Manufacturer	Model No.	Serial No.	Cal. Date	Cal. Due
Test Receiver ROHDE & SCHWARZ	ESCS30	100289	Dec. 23, 2015	Dec. 22, 2016
Spectrum Analyzer ROHDE & SCHWARZ	FSP40	100269	Apr. 19, 2016	Apr. 18, 2017
BILOG Antenna SCHWARZBECK	VULB9168	9168-148	Jan. 18, 2016	Jan. 17, 2017
HORN Antenna SCHWARZBECK	BBHA 9120 D	9120D-1169	Jan. 08, 2016	Jan. 07, 2017
HORN Antenna SCHWARZBECK	BBHA 9170	BBHA9170241	Jan. 18, 2016	Jan. 17, 2017
Preamplifier Agilent	8449B	3008A01911	Aug. 09, 2015	Aug. 08, 2016
			Aug. 09, 2016	Aug. 08, 2017
Preamplifier Agilent	8447D	2944A10638	Aug. 09, 2015	Aug. 08, 2016
			Aug. 09, 2016	Aug. 08, 2017
RF signal cable HUBER+SUHNER	SUCOFLEX 104	CABLE-CH9-02(309222 +248780)	Aug. 09, 2015	Aug. 08, 2016
			Aug. 09, 2016	Aug. 08, 2017
RF signal cable HUBER+SUHNER	SUCOFLEX 104	CABLE-CH9-03(274092)	Aug. 09, 2015	Aug. 08, 2016
			Aug. 09, 2016	Aug. 08, 2017
RF signal cable Woken	8D-FB	Cable-CH9-01	Aug. 09, 2015	Aug. 08, 2016
			Aug. 09, 2016	Aug. 08, 2017
Software BV ADT	ADT_Radiated_ V7.6.15.9.4	NA	NA	NA
Antenna Tower EMCO	2070/2080	512.835.4684	NA	NA
Turn Table EMCO	2087-2.03	NA	NA	NA
Antenna Tower & Turn BV ADT	AT100	AT93021705	NA	NA
Turn Table BV ADT	TT100	TT93021705	NA	NA
Turn Table Controller BV ADT	SC100	SC93021705	NA	NA
WIT Standard Temperature And Humidity Chamber	TH-4S-C	W981030	Jun. 08, 2016	Jun. 07, 2017
Mini-Circuits Power Splitter	ZN2PD-9G	NA	Oct. 16, 2015	Oct. 15, 2016
JFW 20dB attenuation	50HF-020-SMA	NA	NA	NA

- Note:
1. The calibration interval of the above test instruments is 12 months and the calibrations are traceable to NML/ROC and NIST/USA.
 2. The test was performed in HwaYa Chamber 9.
 3. The horn antenna and preamplifier (model: 8449B) are used only for the measurement of emission frequency above 1GHz if tested.
 4. The FCC Site Registration No. is 215374.
 5. The IC Site Registration No. is IC 7450F-9.

3 General Information

3.1 General Description of EUT

Product	Smart Phone		
Brand	Turbonet		
Test Model	ADR1776		
Status of EUT	Engineering sample		
Power Supply Rating	3.8Vdc (Battery) 5Vdc or 9Vdc (Adapter or host equipment)		
Modulation Type	QPSK, 16QAM		
Operating Frequency	LTE Band 4	Channel Bandwidth 1.4MHz	1710.7MHz ~ 1754.3MHz
		Channel Bandwidth 3MHz	1711.5MHz ~ 1753.5MHz
		Channel Bandwidth 5MHz	1712.5MHz ~ 1752.5MHz
		Channel Bandwidth 10MHz	1715.0MHz ~ 1750.0MHz
		Channel Bandwidth 15MHz	1717.5MHz ~ 1747.5MHz
		Channel Bandwidth 20MHz	1720.0MHz ~ 1745.0MHz
	LTE Band 13	Channel Bandwidth 5MHz	779.5MHz ~ 784.5MHz
		Channel Bandwidth 10MHz	782MHz
Max. EIRP Power	LTE Band 4	Channel Bandwidth 1.4MHz	257.040mW (24.1dBm)
		Channel Bandwidth 3MHz	263.027mW (24.2dBm)
		Channel Bandwidth 5MHz	269.153mW (24.3dBm)
		Channel Bandwidth 10MHz	269.153mW (24.3dBm)
		Channel Bandwidth 15MHz	269.153mW (24.3dBm)
		Channel Bandwidth 20MHz	263.027mW (24.2dBm)
Max. ERP Power	LTE Band 13	Channel Bandwidth 5MHz	104.713mW (20.2dBm)
		Channel Bandwidth 10MHz	107.152mW (20.3dBm)
Antenna Type	Refer to Note for more details		
Antenna Connector	Refer to Note for more details		
Accessory Device	Refer to Note for more details		
Data Cable Supplied	Refer to Note for more details		

Note:

1. The EUT contains following accessory devices and data cable.

Item	Brand	Model	Specification
Battery	FUJI	492005	3.8V, 11.21Wh or 2950mAh
USB cable	N/A	N/A	0.95m shielded cable without core
Adapter	DELTA Electronics, INC.	ADP-18GW B	I/P: 100-240Vac, 0.5A, 50-60Hz O/P: 5Vdc, 2A charger 9Vdc, 2A fast charger

2. The EUT uses following antennas.

Antenna	Frequency Range (MHz)	Antenna Gain (dBi)	Antenna Type	Antenna Connector
WWAN	1710-1755	-0.02	Embedded	Spring
WWAN	779-785	-1.16	Embedded	Spring

3.2 Configuration of System under Test

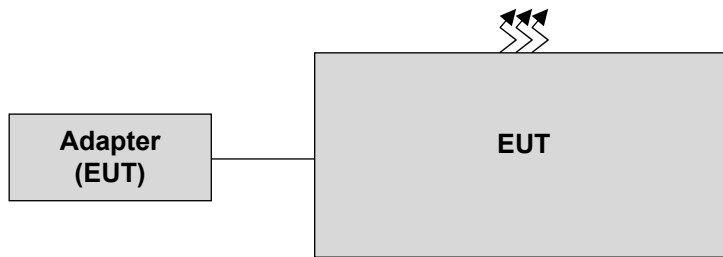

Remote site

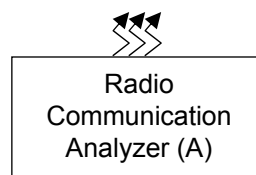

3.2.1 Description of Support Units

The EUT has been tested as an independent unit together with other necessary accessories or support units. The following support units or accessories were used to form a representative test configuration during the tests.

ID	Product	Brand	Model No.	Serial No.	FCC ID	Remarks
A.	Radio Communication Analyzer	Anritsu	MT8820C	6201010284	NA	-

Note:

1. All power cords of the above support units are non-shielded (1.8m).
2. Item A acted as a communication partner to transfer data.

3.3 Test Mode Applicability and Tested Channel Detail

Pre-Scan has been conducted to determine the worst-case mode from all possible combinations between available modulations, data rates, XYZ axis and antenna ports. The worst case was found when positioned on Z-plane. Following channel(s) was (were) selected for the final test as listed below:

LTE Band 4

Test Item	Available Channel	Tested Channel	Channel Bandwidth	Modulation	Mode
Output Power	19957 to 20393	19957(1710.70MHz), 20175(1732.50MHz), 20393(1754.30MHz)	1.4MHz	QPSK	1 RB / 5 RB Offset
	19965 to 20385	19965(1711.50MHz), 20175(1732.50MHz), 20385(1753.50MHz)	3MHz	QPSK	1 RB / 14 RB Offset
	19975 to 20375	19975(1712.50MHz), 20175(1732.50MHz), 20375(1752.50MHz)	5MHz	QPSK	1 RB / 24 RB Offset
	20000 to 20350	20000(1715.00MHz), 20175(1732.50MHz), 20350(1750.00MHz)	10MHz	QPSK	1 RB / 49 RB Offset
	20025 to 20325	20025(1717.50MHz), 20175(1732.50MHz), 20325(1747.50MHz)	15MHz	QPSK	1 RB / 74 RB Offset
	20050 to 20300	20050(1720.00MHz), 20175(1732.50MHz), 20300(1745.00MHz)	20MHz	QPSK	1 RB / 99 RB Offset
Frequency Stability	19957 to 20393	20175(1732.50MHz)	1.4MHz	QPSK	1 RB / 0 RB Offset
Emission Bandwidth	19957 to 20393	19957(1710.70MHz), 20175(1732.50MHz), 20393(1754.30MHz)	1.4MHz	QPSK, 16QAM	6 RB / 0 RB Offset
	19965 to 20385	19965(1711.50MHz), 20175(1732.50MHz), 20385(1753.50MHz)	3MHz	QPSK, 16QAM	15 RB / 0 RB Offset
	19975 to 20375	19975(1712.50MHz), 20175(1732.50MHz), 20375(1752.50MHz)	5MHz	QPSK, 16QAM	25 RB / 0 RB Offset
	20000 to 20350	20000(1715.00MHz), 20175(1732.50MHz), 20350(1750.00MHz)	10MHz	QPSK, 16QAM	50 RB / 0 RB Offset
	20025 to 20325	20025(1717.50MHz), 20175(1732.50MHz), 20325(1747.50MHz)	15MHz	QPSK, 16QAM	75 RB / 0 RB Offset
	20050 to 20300	20050(1720.00MHz), 20175(1732.50MHz), 20300(1745.00MHz)	20MHz	QPSK, 16QAM	100 RB / 0 RB Offset
Channel Edge	19957 to 20393	19957(1710.70MHz), 20393(1754.30MHz)	1.4MHz	QPSK	1 RB / 0 RB Offset 1 RB / 5 RB Offset 6 RB / 0 RB Offset
	19965 to 20385	19965(1711.50MHz), 20385(1753.50MHz)	3MHz	QPSK	1 RB / 0 RB Offset 1 RB / 14 RB Offset 15 RB / 0 RB Offset
	19975 to 20375	19975(1712.50MHz), 20375(1752.50MHz)	5MHz	QPSK	1 RB / 0 RB Offset 1 RB / 24 RB Offset 25 RB / 0 RB Offset
	20000 to 20350	20000(1715.00MHz), 20350(1750.00MHz)	10MHz	QPSK	1 RB / 0 RB Offset 1 RB / 49 RB Offset 50 RB / 0 RB Offset
	20025 to 20325	20025(1717.50MHz), 20325(1747.50MHz)	15MHz	QPSK	1 RB / 0 RB Offset 1 RB / 74 RB Offset 75 RB / 0 RB Offset
	20050 to 20300	20050(1720.00MHz), 20300(1745.00MHz)	20MHz	QPSK	1 RB / 0 RB Offset 1 RB / 99 RB Offset 100 RB / 0 RB Offset

Test Item	Available Channel	Tested Channel	Channel Bandwidth	Modulation	Mode
Conducted Emission	19957 to 20393	19957(1710.70MHz), 20175(1732.50MHz), 20393(1754.30MHz)	1.4MHz	QPSK	1 RB / 0 RB Offset
	19965 to 20385	19965(1711.50MHz), 20175(1732.50MHz), 20385(1753.50MHz)	3MHz	QPSK	1 RB / 0 RB Offset
	19975 to 20375	19975(1712.50MHz), 20175(1732.50MHz), 20375(1752.50MHz)	5MHz	QPSK	1 RB / 0 RB Offset
	20000 to 20350	20000(1715.00MHz), 20175(1732.50MHz), 20350(1750.00MHz)	10MHz	QPSK	1 RB / 0 RB Offset
	20025 to 20325	20025(1717.50MHz), 20175(1732.50MHz), 20325(1747.50MHz)	15MHz	QPSK	1 RB / 0 RB Offset
	20050 to 20300	20050(1720.00MHz), 20175(1732.50MHz), 20300(1745.00MHz)	20MHz	QPSK	1 RB / 0 RB Offset
Radiated Emission Below 1GHz	19957 to 20393	19957(1710.70MHz)	1.4MHz	QPSK	1 RB / 0 RB Offset
	19965 to 20385	19965(1711.50MHz)	3MHz	QPSK	1 RB / 0 RB Offset
	19975 to 20375	19975(1712.50MHz)	5MHz	QPSK	1 RB / 0 RB Offset
	20000 to 20350	20000(1715.00MHz)	10MHz	QPSK	1 RB / 0 RB Offset
	20025 to 20325	20025(1717.50MHz)	15MHz	QPSK	1 RB / 0 RB Offset
	20050 to 20300	20050(1720.00MHz)	20MHz	QPSK	1 RB / 0 RB Offset
Radiated Emission Above 1GHz	19957 to 20393	19957(1710.70MHz), 20175(1732.50MHz), 20393(1754.30MHz)	1.4MHz	QPSK	1 RB / 0 RB Offset
	19965 to 20385	19965(1711.50MHz), 20175(1732.50MHz), 20385(1753.50MHz)	3MHz	QPSK	1 RB / 0 RB Offset
	19975 to 20375	19975(1712.50MHz), 20175(1732.50MHz), 20375(1752.50MHz)	5MHz	QPSK	1 RB / 0 RB Offset
	20000 to 20350	20000(1715.00MHz), 20175(1732.50MHz), 20350(1750.00MHz)	10MHz	QPSK	1 RB / 0 RB Offset
	20025 to 20325	20025(1717.50MHz), 20175(1732.50MHz), 20325(1747.50MHz)	15MHz	QPSK	1 RB / 0 RB Offset
	20050 to 20300	20050(1720.00MHz), 20175(1732.50MHz), 20300(1745.00MHz)	20MHz	QPSK	1 RB / 0 RB Offset

LTE Band 13

Test Item	Available Channel	Tested Channel	Channel Bandwidth	Modulation	Mode
Output Power	23205 to 23255	23205(779.50MHz), 23230(782.00MHz), 23255(784.50MHz)	5MHz	QPSK	1 RB / 0 RB Offset
	23230	23230(782.00MHz)	10MHz	QPSK	1 RB / 0 RB Offset
Frequency Stability	23205 to 23255	23230(782.00MHz)	5MHz	QPSK	1 RB / 0 RB Offset
Emission Bandwidth	23205 to 23255	23205(779.50MHz), 23230(782.00MHz), 23255(784.50MHz)	5MHz	QPSK, 16QAM	25 RB / 0 RB Offset
	23230	23230(782.00MHz)	10MHz	QPSK, 16QAM	50 RB / 0 RB Offset
Channel Edge	23205 to 23255	23205(779.50MHz), 23255(784.50MHz)	5MHz	QPSK	1 RB / 0 RB Offset 1 RB / 24 RB Offset 25 RB / 0 RB Offset
	23230	23230(782.00MHz)	10MHz	QPSK	1 RB / 0 RB Offset 1 RB / 49 RB Offset 50 RB / 0 RB Offset
Conducted Emission	23205 to 23255	23205(779.50MHz), 23230(782.00MHz), 23255(784.50MHz)	5MHz	QPSK	1 RB / 0 RB Offset
	23230	23230(782.00MHz)	10MHz	QPSK	1 RB / 0 RB Offset
Radiated Emission Below 1GHz	23205 to 23255	23205(779.50MHz)	5MHz	QPSK	1 RB / 0 RB Offset
	23230	23230(782.00MHz)	10MHz	QPSK	1 RB / 0 RB Offset
Radiated Emission Above 1GHz	23205 to 23255	23205(779.50MHz), 23230(782.00MHz), 23255(784.50MHz)	5MHz	QPSK	1 RB / 0 RB Offset
	23230	23230(782.00MHz)	10MHz	QPSK	1 RB / 0 RB Offset

Note:

1. For radiated emission below 1 GHz, the low, mid and high channels were pre-tested in chamber. The low channel was the worst case and chosen for final test.
2. The conducted output power for QPSK and 16QAM, measured value of QPSK is higher than 16QAM mode. Therefore, only Emission Bandwidth had been tested under QPSK and 16QAM modes, the others test items were performed under QPSK mode only.

Test Condition:

Test Item	Environmental Conditions	Input Power	Tested By
Output Power	25deg. C, 69%RH	120Vac, 60Hz	Tank Wu
Frequency Stability	24deg. C, 64%RH	120Vac, 60Hz	Match Tsui
Emission Bandwidth	24deg. C, 64%RH	120Vac, 60Hz	Match Tsui
Channel Edge	24deg. C, 64%RH	120Vac, 60Hz	Match Tsui
Conducted Emission	24deg. C, 64%RH	120Vac, 60Hz	Match Tsui
Radiated Emission	20deg. C, 69%RH 25deg. C, 69%RH	120Vac, 60Hz	Bond Tseng Tank Wu

3.4 EUT Operating Conditions

The EUT makes a call to the communication simulator. The communication simulator station system controlled a EUT to export maximum output power under transmission mode and specific channel frequency

3.5 General Description of Applied Standards

The EUT is a RF Product. According to the specifications of the manufacturer, it must comply with the requirements of the following standards:

FCC 47 CFR Part 2

FCC 47 CFR Part 27

KDB 971168 D01 Power Meas License Digital Systems v02r02

ANSI/TIA/EIA-603-C 2004

Note: All test items have been performed and recorded as per the above standards.

4 Test Types and Results

4.1 Output Power Measurement

4.1.1 Limits of Output Power Measurement

Mobile / Portable station are limited to 1 watts e.i.r.p for LTE Band 4 and 3 watts e.r.p for LTE Band 13.

4.1.2 Test Procedures

EIRP / ERP Measurement:

- a. All measurements were done at low, middle and high operational frequency range. RWB and VBW is 5MHz for LTE Mode.
- b. Substitution method is used for E.I.R.P measurement. In the semi-anechoic chamber, EUT placed on the 0.8m height of Turn Table, rotated the table around 360 degrees to search the maximum radiation power and receiver antenna shall be rotated vertical and horizontal polarization and moved height from 1m to 4m to find the maximum polar radiated power. The "Read Value" is the spectrum reading the maximum power value.
- c. The substitution horn antenna is substituted for EUT at the same position and signals generator export the CW signal to the substitution antenna via a TX cable. Rotated the Turn Table and moved receiving antenna to find the maximum radiation power. Adjust output power level of S.G to get a Value of spectrum reading equal to "Read Value" of step b. Record the power level of S.G
- d. $EIRP = \text{Output power level of S.G} - \text{TX cable loss} + \text{Antenna gain of substitution horn}$. E.R.P power can be calculated form E.I.R.P power by subtracting the gain of dipole, $E.R.P \text{ power} = E.I.R.P \text{ power} - 2.15\text{dBi}$.

Conducted Power Measurement:

A power sensor was used on the output port of the EUT. A power meter was used to read the response of the power sensor. Record the power level.

4.1.3 Test Setup

EIRP / ERP MEASUREMENT:

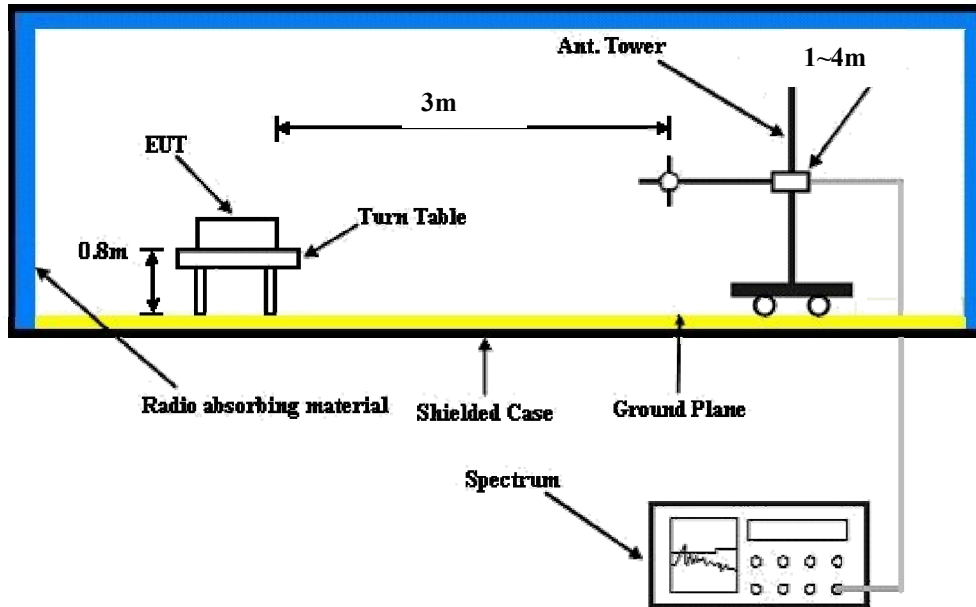

For the actual test configuration, please refer to the attached file (Test Setup Photo).

CONDUCTED POWER MEASUREMENT:



For the actual test configuration, please refer to the attached file (Test Setup Photo).

4.1.4 Test Results

CONDUCTED OUTPUT POWER (dBm)

Band / BW	RB Size	RB Offset	QPSK			16QAM		
			Low CH 19957	Mid CH 20175	High CH 20393	Low CH 19957	Mid CH 20175	High CH 20393
			1710.7 MHz	1732.5 MHz	1754.3 MHz	1710.7 MHz	1732.5 MHz	1754.3 MHz
4 / 1.4M	1	0	22.38	22.14	22.17	21.32	21.08	21.11
	1	2	22.13	21.89	21.92	21.07	20.83	20.86
	1	5	21.96	21.72	21.75	20.90	20.66	20.69
	3	0	22.25	22.01	22.04	21.19	20.95	20.98
	3	1	22.14	21.90	21.93	21.08	20.84	20.87
	3	3	22.20	21.96	21.99	21.14	20.90	20.93
	6	0	21.07	20.83	20.86	20.01	19.77	19.80
Band / BW	RB Size	RB Offset	QPSK			16QAM		
			Low CH 19965	Mid CH 20175	High CH 20385	Low CH 19965	Mid CH 20175	High CH 20385
			1711.5 MHz	1732.5 MHz	1753.5 MHz	1711.5 MHz	1732.5 MHz	1753.5 MHz
4 / 3M	1	0	22.45	22.21	22.24	21.39	21.15	21.18
	1	7	22.20	21.96	21.99	21.14	20.90	20.93
	1	14	22.03	21.79	21.82	20.97	20.73	20.76
	8	0	21.17	20.93	20.96	20.11	19.87	19.90
	8	3	21.06	20.82	20.85	20.00	19.76	19.79
	8	7	21.12	20.88	20.91	20.06	19.82	19.85
	15	0	21.14	20.90	20.93	20.08	19.84	19.87
Band / BW	RB Size	RB Offset	QPSK			16QAM		
			Low CH 19975	Mid CH 20175	High CH 20375	Low CH 19975	Mid CH 20175	High CH 20375
			1712.5 MHz	1732.5 MHz	1752.5 MHz	1712.5 MHz	1732.5 MHz	1752.5 MHz
4 / 5M	1	0	22.54	22.30	22.33	21.48	21.24	21.27
	1	12	22.29	22.05	22.08	21.23	20.99	21.02
	1	24	22.12	21.88	21.91	21.06	20.82	20.85
	12	0	21.26	21.02	21.05	20.20	19.96	19.99
	12	6	21.15	20.91	20.94	20.09	19.85	19.88
	12	13	21.21	20.97	21.00	20.15	19.91	19.94
	25	0	21.23	20.99	21.02	20.17	19.93	19.96

Band / BW	RB Size	RB Offset	QPSK			16QAM		
			Low CH 20000	Mid CH 20175	High CH 20350	Low CH 20000	Mid CH 20175	High CH 20350
			1715 MHz	1732.5 MHz	1750 MHz	1715 MHz	1732.5 MHz	1750 MHz
4 / 10M	1	0	22.66	22.42	22.45	21.60	21.36	21.39
	1	24	22.41	22.17	22.20	21.35	21.11	21.14
	1	49	22.24	22.00	22.03	21.18	20.94	20.97
	25	0	21.38	21.14	21.17	20.32	20.08	20.11
	25	12	21.27	21.03	21.06	20.21	19.97	20.00
	25	25	21.33	21.09	21.12	20.27	20.03	20.06
	50	0	21.35	21.11	21.14	20.29	20.05	20.08
Band / BW	RB Size	RB Offset	QPSK			16QAM		
			Low CH 20025	Mid CH 20175	High CH 20325	Low CH 20025	Mid CH 20175	High CH 20325
			1717.5 MHz	1732.5 MHz	1747.5 MHz	1717.5 MHz	1732.5 MHz	1747.5 MHz
4 / 15M	1	0	22.75	22.51	22.54	21.69	21.45	21.48
	1	37	22.50	22.26	22.29	21.44	21.20	21.23
	1	74	22.33	22.09	22.12	21.27	21.03	21.06
	36	0	21.47	21.23	21.26	20.41	20.17	20.20
	36	19	21.36	21.12	21.15	20.30	20.06	20.09
	36	39	21.42	21.18	21.21	20.36	20.12	20.15
	75	0	21.44	21.20	21.23	20.38	20.14	20.17
Band / BW	RB Size	RB Offset	QPSK			16QAM		
			Low CH 20050	Mid CH 20175	High CH 20300	Low CH 20050	Mid CH 20175	High CH 20300
			1720 MHz	1732.5 MHz	1745 MHz	1720 MHz	1732.5 MHz	1745 MHz
4 / 20M	1	0	22.88	22.64	22.67	21.82	21.58	21.61
	1	50	22.63	22.39	22.42	21.57	21.33	21.36
	1	99	22.46	22.22	22.25	21.40	21.16	21.19
	50	0	21.60	21.36	21.39	20.54	20.30	20.33
	50	25	21.49	21.25	21.28	20.43	20.19	20.22
	50	50	21.55	21.31	21.34	20.49	20.25	20.28
	100	0	21.57	21.33	21.36	20.51	20.27	20.30

Band / BW	RB Size	RB Offset	QPSK			16QAM		
			Low CH 23205	Mid CH 23230	High CH 23255	Low CH 23205	Mid CH 23230	High CH 23255
			779.5 MHz	782 MHz	784.5 MHz	779.5 MHz	782 MHz	784.5 MHz
13 / 5M	1	0	22.11	22.29	22.19	21.05	21.23	21.13
	1	12	22.03	22.21	22.11	20.97	21.15	21.05
	1	24	22.00	22.18	22.08	20.94	21.12	21.02
	12	0	21.01	21.19	21.09	19.95	20.13	20.03
	12	6	20.93	21.11	21.01	19.87	20.05	19.95
	12	13	20.91	21.09	20.99	19.85	20.03	19.93
	25	0	21.06	21.24	21.14	20.00	20.18	20.08
Band / BW	RB Size	RB Offset	QPSK			16QAM		
			Mid CH 23230			Mid CH 23230		
			782MHz			782MHz		
13 / 10M	1	0	22.32			21.27		
	1	24	22.25			21.20		
	1	49	22.22			21.17		
	25	0	21.23			20.18		
	25	12	21.15			20.10		
	25	25	21.13			20.08		
	50	0	21.28			20.23		

EIRP Power (dBm)

LTE Band 4

Channel Bandwidth: 1.4MHz

MODE		TX channel 19957					
Antenna Polarity & Test Distance: Horizontal at 3 M							
No.	Freq. (MHz)	Reading (dBm)	S.G Power Value (dBm)	Correction Factor (dB)	EIRP (dBm)	Limit (dBm)	Margin (dB)
1	1710.70	-16.0	22.0	0.7	22.7	30.0	-7.3
Antenna Polarity & Test Distance: Vertical at 3 M							
No.	Freq. (MHz)	Reading (dBm)	S.G Power Value (dBm)	Correction Factor (dB)	EIRP (dBm)	Limit (dBm)	Margin (dB)
1	1710.70	-14.4	23.4	0.7	24.1	30.0	-5.9

MODE		TX channel 20175					
Antenna Polarity & Test Distance: Horizontal at 3 M							
No.	Freq. (MHz)	Reading (dBm)	S.G Power Value (dBm)	Correction Factor (dB)	EIRP (dBm)	Limit (dBm)	Margin (dB)
1	1732.50	-17.3	21.1	0.6	21.7	30.0	-8.3
Antenna Polarity & Test Distance: Vertical at 3 M							
No.	Freq. (MHz)	Reading (dBm)	S.G Power Value (dBm)	Correction Factor (dB)	EIRP (dBm)	Limit (dBm)	Margin (dB)
1	1732.50	-15.3	23.0	0.6	23.6	30.0	-6.4

MODE		TX channel 20393					
Antenna Polarity & Test Distance: Horizontal at 3 M							
No.	Freq. (MHz)	Reading (dBm)	S.G Power Value (dBm)	Correction Factor (dB)	EIRP (dBm)	Limit (dBm)	Margin (dB)
1	1754.30	-18.0	20.8	0.5	21.3	30.0	-8.7
Antenna Polarity & Test Distance: Vertical at 3 M							
No.	Freq. (MHz)	Reading (dBm)	S.G Power Value (dBm)	Correction Factor (dB)	EIRP (dBm)	Limit (dBm)	Margin (dB)
1	1754.30	-15.4	23.5	0.5	24.0	30.0	-6.0

Note: EIRP (dBm) = S.G Power Value (dBm) + Correction Factor (dB).

Channel Bandwidth: 3MHz

MODE		TX channel 19965					
Antenna Polarity & Test Distance: Horizontal at 3 M							
No.	Freq. (MHz)	Reading (dBm)	S.G Power Value (dBm)	Correction Factor (dB)	EIRP (dBm)	Limit (dBm)	Margin (dB)
1	1711.50	-16.2	21.8	0.7	22.5	30.0	-7.5
Antenna Polarity & Test Distance: Vertical at 3 M							
No.	Freq. (MHz)	Reading (dBm)	S.G Power Value (dBm)	Correction Factor (dB)	EIRP (dBm)	Limit (dBm)	Margin (dB)
1	1711.50	-14.9	22.9	0.7	23.6	30.0	-6.4

MODE		TX channel 20175					
Antenna Polarity & Test Distance: Horizontal at 3 M							
No.	Freq. (MHz)	Reading (dBm)	S.G Power Value (dBm)	Correction Factor (dB)	EIRP (dBm)	Limit (dBm)	Margin (dB)
1	1732.50	-17.3	21.1	0.6	21.7	30.0	-8.3
Antenna Polarity & Test Distance: Vertical at 3 M							
No.	Freq. (MHz)	Reading (dBm)	S.G Power Value (dBm)	Correction Factor (dB)	EIRP (dBm)	Limit (dBm)	Margin (dB)
1	1732.50	-15.0	23.3	0.6	23.9	30.0	-6.1

MODE		TX channel 20385					
Antenna Polarity & Test Distance: Horizontal at 3 M							
No.	Freq. (MHz)	Reading (dBm)	S.G Power Value (dBm)	Correction Factor (dB)	EIRP (dBm)	Limit (dBm)	Margin (dB)
1	1753.50	-17.8	21.0	0.5	21.5	30.0	-8.5
Antenna Polarity & Test Distance: Vertical at 3 M							
No.	Freq. (MHz)	Reading (dBm)	S.G Power Value (dBm)	Correction Factor (dB)	EIRP (dBm)	Limit (dBm)	Margin (dB)
1	1753.50	-15.2	23.7	0.5	24.2	30.0	-5.8

Note: EIRP (dBm) = S.G Power Value (dBm) + Correction Factor (dB).

Channel Bandwidth: 5MHz

MODE		TX channel 19975					
Antenna Polarity & Test Distance: Horizontal at 3 M							
No.	Freq. (MHz)	Reading (dBm)	S.G Power Value (dBm)	Correction Factor (dB)	EIRP (dBm)	Limit (dBm)	Margin (dB)
1	1712.50	-16.3	21.8	0.7	22.5	30.0	-7.5
Antenna Polarity & Test Distance: Vertical at 3 M							
No.	Freq. (MHz)	Reading (dBm)	S.G Power Value (dBm)	Correction Factor (dB)	EIRP (dBm)	Limit (dBm)	Margin (dB)
1	1712.50	-14.8	23.1	0.7	23.8	30.0	-6.2

MODE		TX channel 20175					
Antenna Polarity & Test Distance: Horizontal at 3 M							
No.	Freq. (MHz)	Reading (dBm)	S.G Power Value (dBm)	Correction Factor (dB)	EIRP (dBm)	Limit (dBm)	Margin (dB)
1	1732.50	-17.1	21.3	0.6	21.9	30.0	-8.1
Antenna Polarity & Test Distance: Vertical at 3 M							
No.	Freq. (MHz)	Reading (dBm)	S.G Power Value (dBm)	Correction Factor (dB)	EIRP (dBm)	Limit (dBm)	Margin (dB)
1	1732.50	-14.6	23.7	0.6	24.3	30.0	-5.7

MODE		TX channel 20375					
Antenna Polarity & Test Distance: Horizontal at 3 M							
No.	Freq. (MHz)	Reading (dBm)	S.G Power Value (dBm)	Correction Factor (dB)	EIRP (dBm)	Limit (dBm)	Margin (dB)
1	1752.50	-18.2	20.6	0.5	21.1	30.0	-8.9
Antenna Polarity & Test Distance: Vertical at 3 M							
No.	Freq. (MHz)	Reading (dBm)	S.G Power Value (dBm)	Correction Factor (dB)	EIRP (dBm)	Limit (dBm)	Margin (dB)
1	1752.50	-15.8	23.0	0.5	23.5	30.0	-6.5

Note: EIRP (dBm) = S.G Power Value (dBm) + Correction Factor (dB).

Channel Bandwidth: 10MHz

MODE		TX channel 20000					
Antenna Polarity & Test Distance: Horizontal at 3 M							
No.	Freq. (MHz)	Reading (dBm)	S.G Power Value (dBm)	Correction Factor (dB)	EIRP (dBm)	Limit (dBm)	Margin (dB)
1	1715.00	-17.7	20.4	0.7	21.1	30.0	-8.9
Antenna Polarity & Test Distance: Vertical at 3 M							
No.	Freq. (MHz)	Reading (dBm)	S.G Power Value (dBm)	Correction Factor (dB)	EIRP (dBm)	Limit (dBm)	Margin (dB)
1	1715.00	-14.9	23.0	0.7	23.7	30.0	-6.3

MODE		TX channel 20175					
Antenna Polarity & Test Distance: Horizontal at 3 M							
No.	Freq. (MHz)	Reading (dBm)	S.G Power Value (dBm)	Correction Factor (dB)	EIRP (dBm)	Limit (dBm)	Margin (dB)
1	1732.50	-17.5	20.9	0.6	21.5	30.0	-8.5
Antenna Polarity & Test Distance: Vertical at 3 M							
No.	Freq. (MHz)	Reading (dBm)	S.G Power Value (dBm)	Correction Factor (dB)	EIRP (dBm)	Limit (dBm)	Margin (dB)
1	1732.50	-14.6	23.7	0.6	24.3	30.0	-5.7

MODE		TX channel 20350					
Antenna Polarity & Test Distance: Horizontal at 3 M							
No.	Freq. (MHz)	Reading (dBm)	S.G Power Value (dBm)	Correction Factor (dB)	EIRP (dBm)	Limit (dBm)	Margin (dB)
1	1750.00	-18.1	20.7	0.5	21.2	30.0	-8.8
Antenna Polarity & Test Distance: Vertical at 3 M							
No.	Freq. (MHz)	Reading (dBm)	S.G Power Value (dBm)	Correction Factor (dB)	EIRP (dBm)	Limit (dBm)	Margin (dB)
1	1750.00	-15.7	23.1	0.5	23.6	30.0	-6.4

Note: EIRP (dBm) = S.G Power Value (dBm) + Correction Factor (dB).

Channel Bandwidth: 15MHz

MODE		TX channel 20025					
Antenna Polarity & Test Distance: Horizontal at 3 M							
No.	Freq. (MHz)	Reading (dBm)	S.G Power Value (dBm)	Correction Factor (dB)	EIRP (dBm)	Limit (dBm)	Margin (dB)
1	1717.50	-17.0	21.1	0.7	21.8	30.0	-8.2
Antenna Polarity & Test Distance: Vertical at 3 M							
No.	Freq. (MHz)	Reading (dBm)	S.G Power Value (dBm)	Correction Factor (dB)	EIRP (dBm)	Limit (dBm)	Margin (dB)
1	1717.50	-14.5	23.5	0.7	24.2	30.0	-5.8

MODE		TX channel 20175					
Antenna Polarity & Test Distance: Horizontal at 3 M							
No.	Freq. (MHz)	Reading (dBm)	S.G Power Value (dBm)	Correction Factor (dB)	EIRP (dBm)	Limit (dBm)	Margin (dB)
1	1732.50	-17.5	20.9	0.6	21.5	30.0	-8.5
Antenna Polarity & Test Distance: Vertical at 3 M							
No.	Freq. (MHz)	Reading (dBm)	S.G Power Value (dBm)	Correction Factor (dB)	EIRP (dBm)	Limit (dBm)	Margin (dB)
1	1732.50	-14.6	23.7	0.6	24.3	30.0	-5.7

MODE		TX channel 20325					
Antenna Polarity & Test Distance: Horizontal at 3 M							
No.	Freq. (MHz)	Reading (dBm)	S.G Power Value (dBm)	Correction Factor (dB)	EIRP (dBm)	Limit (dBm)	Margin (dB)
1	1747.50	-17.9	20.8	0.5	21.3	30.0	-8.7
Antenna Polarity & Test Distance: Vertical at 3 M							
No.	Freq. (MHz)	Reading (dBm)	S.G Power Value (dBm)	Correction Factor (dB)	EIRP (dBm)	Limit (dBm)	Margin (dB)
1	1747.50	-15.5	23.2	0.5	23.7	30.0	-6.3

Note: EIRP (dBm) = S.G Power Value (dBm) + Correction Factor (dB).

Channel Bandwidth: 20MHz

MODE		TX channel 20050					
Antenna Polarity & Test Distance: Horizontal at 3 M							
No.	Freq. (MHz)	Reading (dBm)	S.G Power Value (dBm)	Correction Factor (dB)	EIRP (dBm)	Limit (dBm)	Margin (dB)
1	1720.00	-17.5	20.7	0.7	21.4	30.0	-8.6
Antenna Polarity & Test Distance: Vertical at 3 M							
No.	Freq. (MHz)	Reading (dBm)	S.G Power Value (dBm)	Correction Factor (dB)	EIRP (dBm)	Limit (dBm)	Margin (dB)
1	1720.00	-15.1	22.9	0.7	23.6	30.0	-6.4

MODE		TX channel 20175					
Antenna Polarity & Test Distance: Horizontal at 3 M							
No.	Freq. (MHz)	Reading (dBm)	S.G Power Value (dBm)	Correction Factor (dB)	EIRP (dBm)	Limit (dBm)	Margin (dB)
1	1732.50	-17.3	21.1	0.6	21.7	30.0	-8.3
Antenna Polarity & Test Distance: Vertical at 3 M							
No.	Freq. (MHz)	Reading (dBm)	S.G Power Value (dBm)	Correction Factor (dB)	EIRP (dBm)	Limit (dBm)	Margin (dB)
1	1732.50	-14.7	23.6	0.6	24.2	30.0	-5.8

MODE		TX channel 20300					
Antenna Polarity & Test Distance: Horizontal at 3 M							
No.	Freq. (MHz)	Reading (dBm)	S.G Power Value (dBm)	Correction Factor (dB)	EIRP (dBm)	Limit (dBm)	Margin (dB)
1	1745.00	-17.5	21.2	0.5	21.7	30.0	-8.3
Antenna Polarity & Test Distance: Vertical at 3 M							
No.	Freq. (MHz)	Reading (dBm)	S.G Power Value (dBm)	Correction Factor (dB)	EIRP (dBm)	Limit (dBm)	Margin (dB)
1	1745.00	-15.5	23.2	0.5	23.7	30.0	-6.3

Note: EIRP (dBm) = S.G Power Value (dBm) + Correction Factor (dB).

LTE Band 13

Channel Bandwidth: 5MHz

MODE		TX channel 23205					
Antenna Polarity & Test Distance: Horizontal at 3 M							
No.	Freq. (MHz)	Reading (dBm)	S.G Power Value (dBm)	Correction Factor (dB)	ERP (dBm)	Limit (dBm)	Margin (dB)
1	779.50	-15.0	11.0	4.0	15.0	34.8	-19.8
Antenna Polarity & Test Distance: Vertical at 3 M							
No.	Freq. (MHz)	Reading (dBm)	S.G Power Value (dBm)	Correction Factor (dB)	ERP (dBm)	Limit (dBm)	Margin (dB)
1	779.50	-11.1	17.0	4.0	21.0	34.8	-13.8

MODE		TX channel 23230					
Antenna Polarity & Test Distance: Horizontal at 3 M							
No.	Freq. (MHz)	Reading (dBm)	S.G Power Value (dBm)	Correction Factor (dB)	ERP (dBm)	Limit (dBm)	Margin (dB)
1	782.00	-16.1	9.9	4.0	13.9	34.8	-20.9
Antenna Polarity & Test Distance: Vertical at 3 M							
No.	Freq. (MHz)	Reading (dBm)	S.G Power Value (dBm)	Correction Factor (dB)	ERP (dBm)	Limit (dBm)	Margin (dB)
1	782.00	-12.2	15.6	4.0	19.6	34.8	-15.2

MODE		TX channel 23255					
Antenna Polarity & Test Distance: Horizontal at 3 M							
No.	Freq. (MHz)	Reading (dBm)	S.G Power Value (dBm)	Correction Factor (dB)	ERP (dBm)	Limit (dBm)	Margin (dB)
1	784.50	-15.2	10.9	4.0	14.9	34.8	-19.9
Antenna Polarity & Test Distance: Vertical at 3 M							
No.	Freq. (MHz)	Reading (dBm)	S.G Power Value (dBm)	Correction Factor (dB)	ERP (dBm)	Limit (dBm)	Margin (dB)
1	784.50	-11.7	16.2	4.0	20.2	34.8	-14.6

Note: ERP (dBm) = S.G Power Value (dBm) + Correction Factor (dB).

Channel Bandwidth: 10MHz

MODE		TX channel 23230					
Antenna Polarity & Test Distance: Horizontal at 3 M							
No.	Freq. (MHz)	Reading (dBm)	S.G Power Value (dBm)	Correction Factor (dB)	ERP (dBm)	Limit (dBm)	Margin (dB)
1	782.00	-15.4	10.6	4.0	14.6	34.8	-20.2
Antenna Polarity & Test Distance: Vertical at 3 M							
No.	Freq. (MHz)	Reading (dBm)	S.G Power Value (dBm)	Correction Factor (dB)	ERP (dBm)	Limit (dBm)	Margin (dB)
1	782.00	-11.6	16.3	4.0	20.3	34.8	-14.5

Note: ERP (dBm) = S.G Power Value (dBm) + Correction Factor (dB).

4.2 Frequency Stability Measurement

4.2.1 Limits of Frequency Stability Measurement

According to the FCC part 2.1055 shall be tested the frequency stability. The rule is defined that "The frequency stability shall be sufficient to ensure that the fundamental emission stays within the authorized frequency block." The test extreme voltage is according to the 2.1055(d)(1) Vary primary supply voltage from 85 to 115 percent of the nominal value for other than hand carried battery equipment and the extreme temperature rule is comply with specification of EUT $-30^{\circ}\text{C} \sim 50^{\circ}\text{C}$.

4.2.2 Test Procedure

- Device is placed at the oven room. The oven room could control the temperatures and humidity. Power warm up is at least 15 min and power applied should perform before recording frequency error.
- EUT is connected the external power supply to control the AC input power. The test voltage range is from minimum to maximum working voltage. Each step shall be record the frequency error rate.
- The temperature range step is 10 degrees in this test items. All temperature levels shall be hold the $\pm 0.5^{\circ}\text{C}$ during the measurement testing. The each temperature step shall be at least 0.5 hours, consider the EUT could be test under the stability condition.

Note: The frequency error was recorded frequency error from the communication simulator.

4.2.3 Test Setup

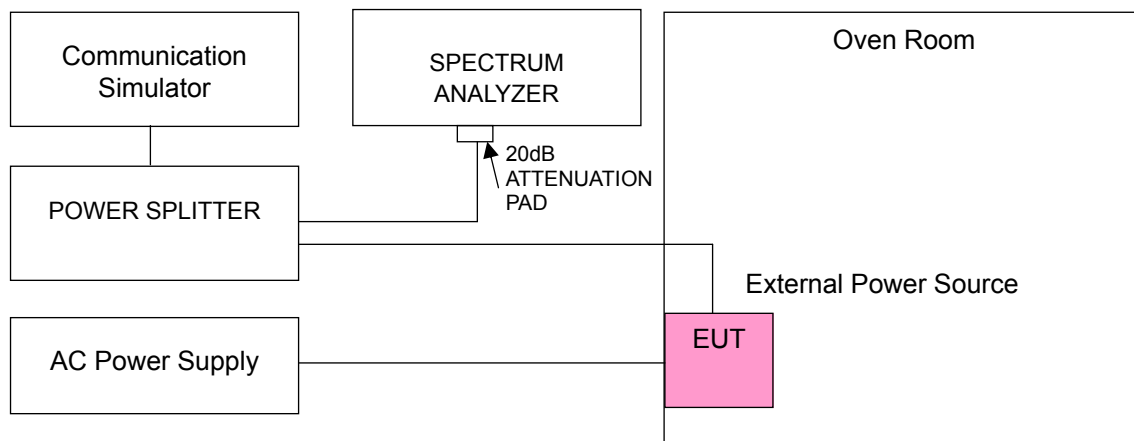

4.2.4 Test Results

Frequency Error vs. Voltage

Voltage (Volts)	Frequency Error (ppm)		Limit (ppm)
	LTE Band 4 CH 20175(1732.50MHz)	LTE Band 13 CH 23230(782.00MHz)	
132	-0.008	-0.015	2.5
120	-0.006	-0.015	2.5
108	-0.006	-0.014	2.5

NOTE: The applicant defined the normal working voltage is from 108Vac to 132Vac.

Frequency Error vs. Temperature.

TEMP. (°C)	Frequency Error (ppm)		Limit (ppm)
	LTE Band 4 CH 20175(1732.50MHz)	LTE Band 13 CH 23230(782.00MHz)	
70	-0.012	-0.025	2.5
60	-0.011	-0.026	2.5
50	-0.009	-0.020	2.5
40	-0.009	-0.020	2.5
30	-0.008	-0.016	2.5
20	-0.006	-0.015	2.5
10	-0.009	-0.019	2.5
0	-0.010	-0.020	2.5
-10	-0.011	-0.025	2.5
-20	-0.014	-0.031	2.5

4.3 Emission Bandwidth Measurement

4.3.1 Limits of Emission Bandwidth Measurement

According to FCC 27.53(m)(6) specified that emission bandwidth is defined as the width of the signal between two points, one below the carrier center frequency and one above the carrier center frequency, outside of which all emissions are attenuated at least 26dB below the transmitter power.

4.3.2 Test Procedure

The transmitter output was connected to the spectrum analyzer through an attenuator. The bandwidth of the fundamental frequency was measured by spectrum analyzer with RBW = 30kHz and VBW = 100kHz (Channel Bandwidth: 1.4MHz), RBW = 51kHz and VBW = 150kHz (Channel Bandwidth: 3MHz and 5MHz), RBW = 100kHz and VBW = 300kHz (Channel Bandwidth: 10MHz), RBW = 200kHz and VBW = 620kHz (Channel Bandwidth: 15MHz) and RBW = 430kHz and VBW = 1.2MHz (Channel Bandwidth: 20MHz). The 26dB bandwidth is defined as the total spectrum the power of which is higher than peak power minus 26dB.

4.3.3 Test Setup

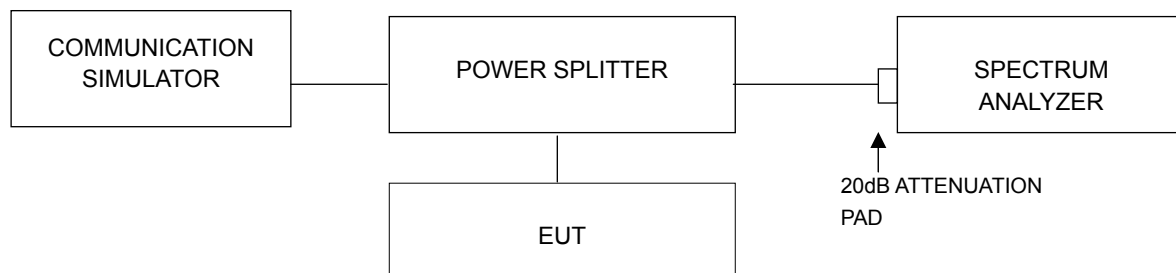

4.3.4 Test Result

LTE Band 4

Channel Bandwidth: 1.4MHz					
Channel	Frequency (MHz)	26dBc Bandwidth (MHz)		Occupied Bandwidth (MHz)	
		QPSK	16QAM	QPSK	16QAM
19957	1710.7	1.54	1.55	1.10	1.10
20175	1732.5	1.57	1.57	1.10	1.10
20393	1754.3	1.57	1.56	1.10	1.10

SPECTRUM PLOT OF WORST VALUE

26dBc Bandwidth

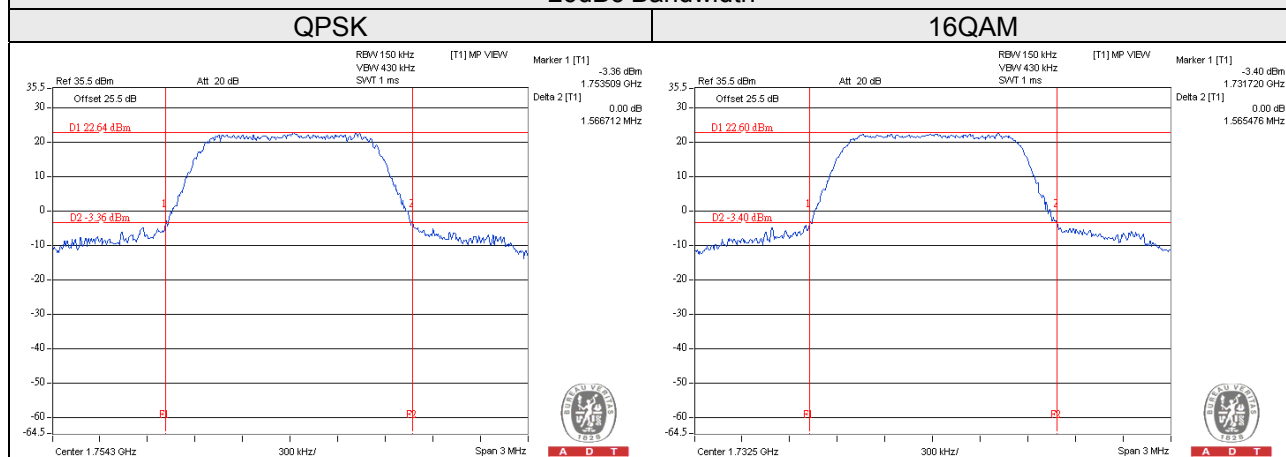

Occupied Bandwidth

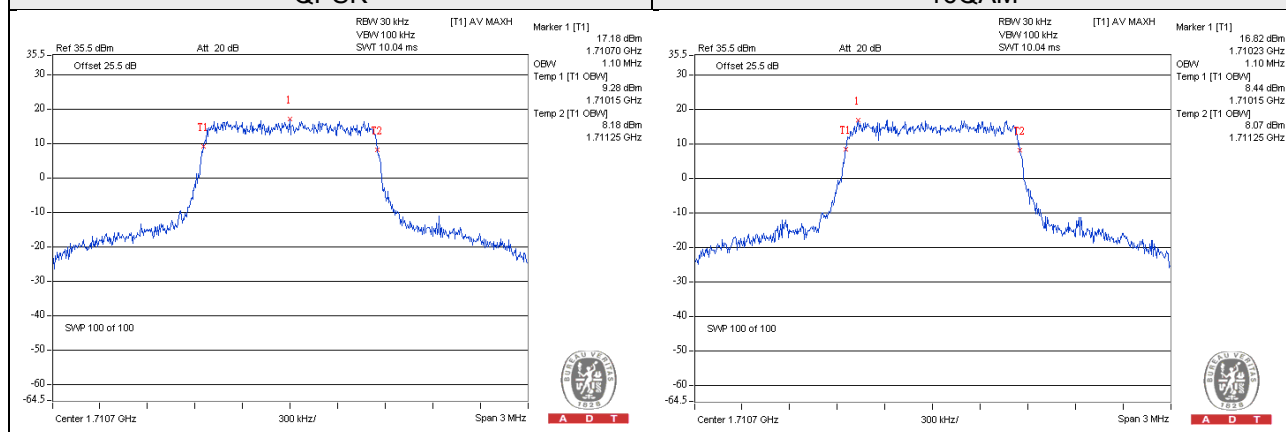

Channel Bandwidth: 3MHz					
Channel	Frequency (MHz)	26dBc Bandwidth (MHz)		Occupied Bandwidth (MHz)	
		QPSK	16QAM	QPSK	16QAM
19965	1711.5	3.05	3.11	2.69	2.68
20175	1732.5	3.11	3.09	2.69	2.70
20385	1753.5	3.07	3.10	2.69	2.69

SPECTRUM PLOT OF WORST VALUE
26dBc Bandwidth

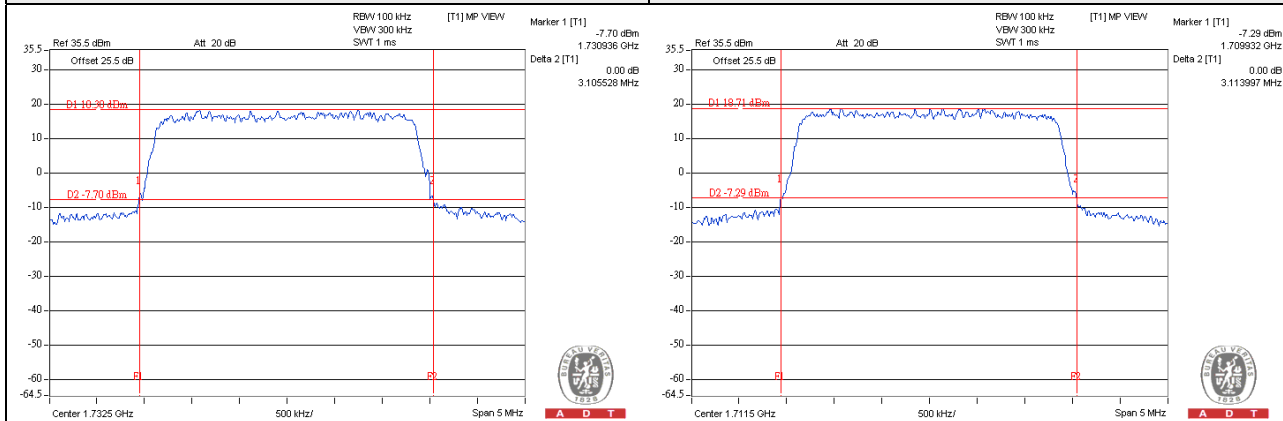

Occupied Bandwidth

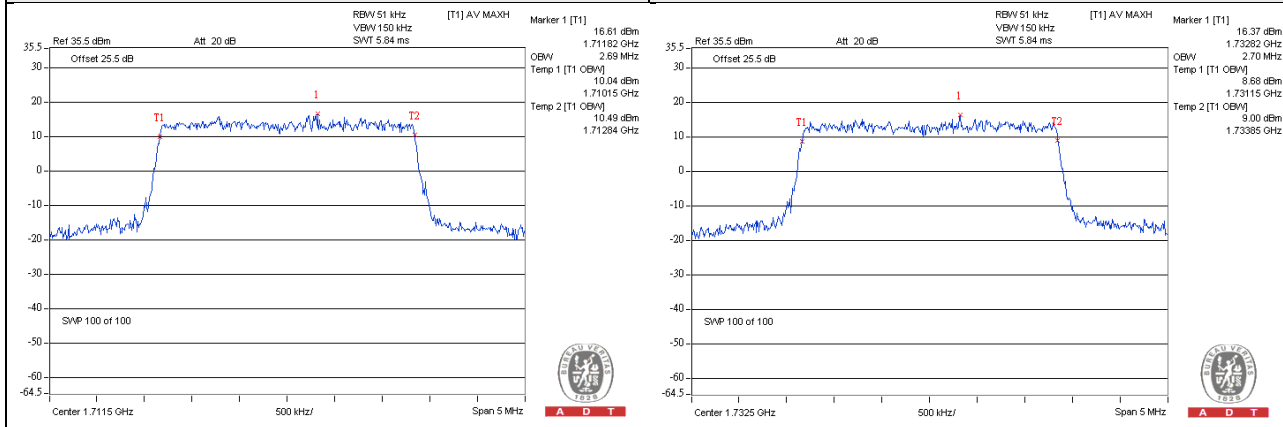

Channel Bandwidth: 5MHz					
Channel	Frequency (MHz)	26dBc Bandwidth (MHz)		Occupied Bandwidth (MHz)	
		QPSK	16QAM	QPSK	16QAM
19975	1712.5	5.05	4.97	4.48	4.48
20175	1732.5	5.07	5.07	4.48	4.48
20375	1752.5	5.03	5.03	4.48	4.50

SPECTRUM PLOT OF WORST VALUE
26dBc Bandwidth

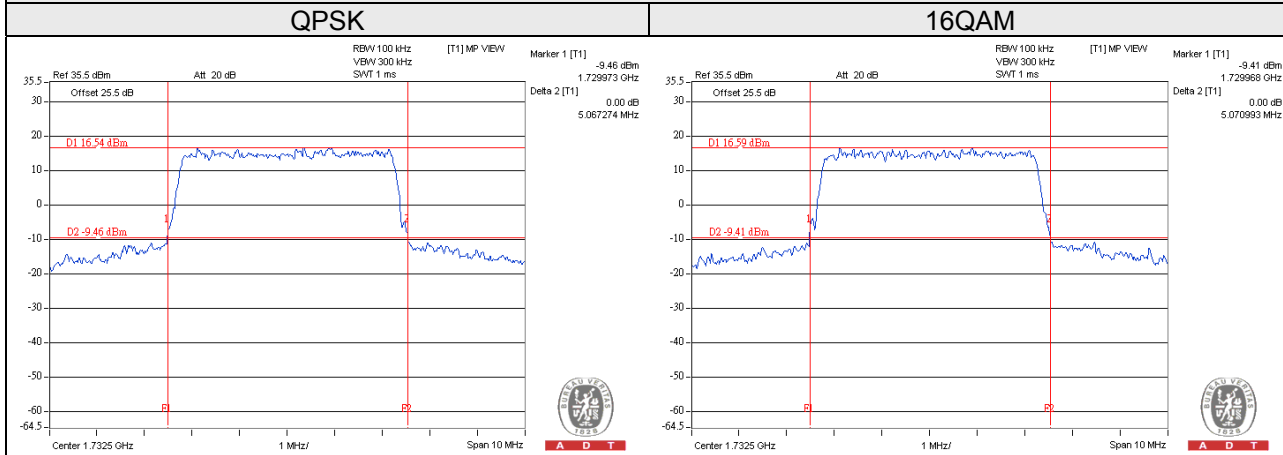

Occupied Bandwidth

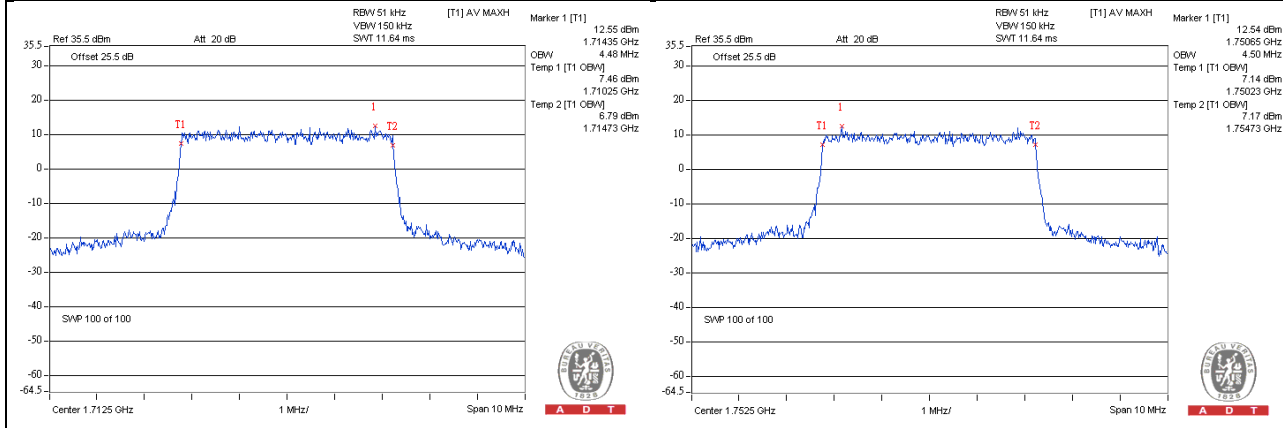

Channel Bandwidth: 10MHz					
Channel	Frequency (MHz)	26dBc Bandwidth (MHz)		Occupied Bandwidth (MHz)	
		QPSK	16QAM	QPSK	16QAM
20000	1715.0	10.00	9.96	8.97	8.97
20175	1732.5	9.79	10.04	8.97	8.93
20350	1750.0	9.92	9.81	8.97	8.97

SPECTRUM PLOT OF WORST VALUE
26dBc Bandwidth

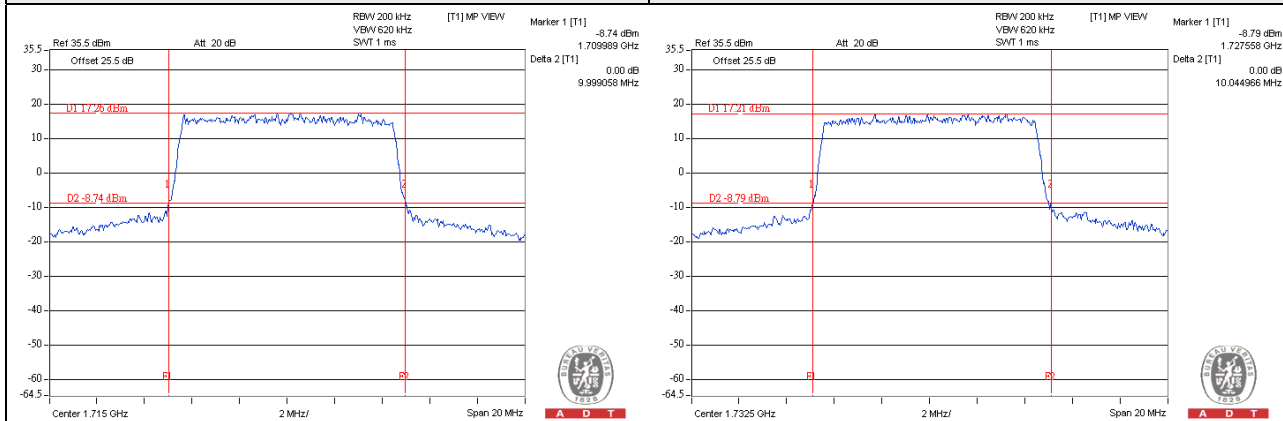

Occupied Bandwidth

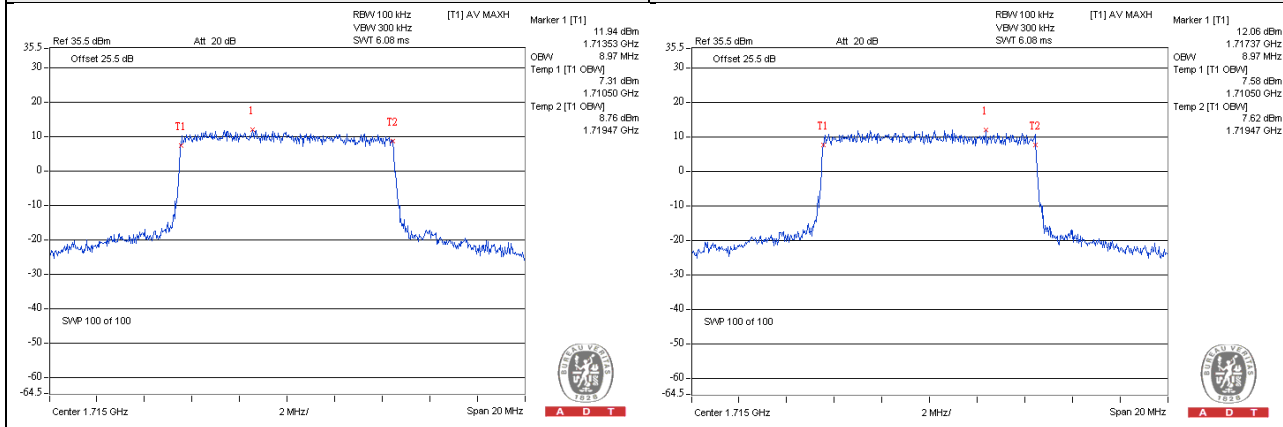

Channel Bandwidth: 15MHz

Channel	Frequency (MHz)	26dBc Bandwidth (MHz)		Occupied Bandwidth (MHz)	
		QPSK	16QAM	QPSK	16QAM
20025	1717.5	14.66	14.71	13.43	13.43
20175	1732.5	14.82	14.77	13.43	13.43
20325	1747.5	14.63	14.71	13.43	13.40

SPECTRUM PLOT OF WORST VALUE

26dBc Bandwidth

QPSK

16QAM

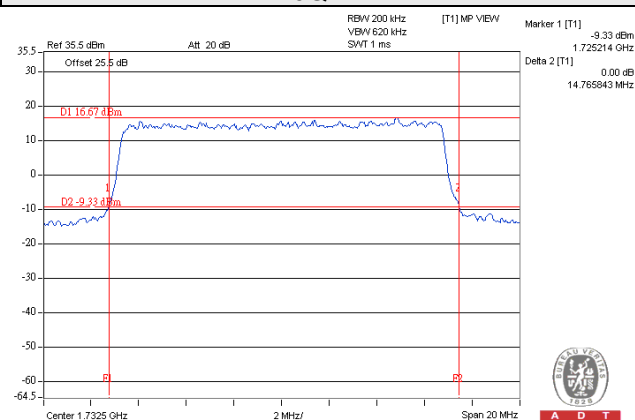
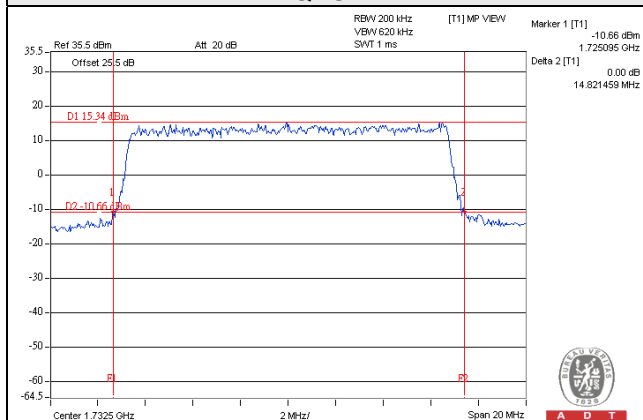

Occupied Bandwidth

QPSK

16QAM

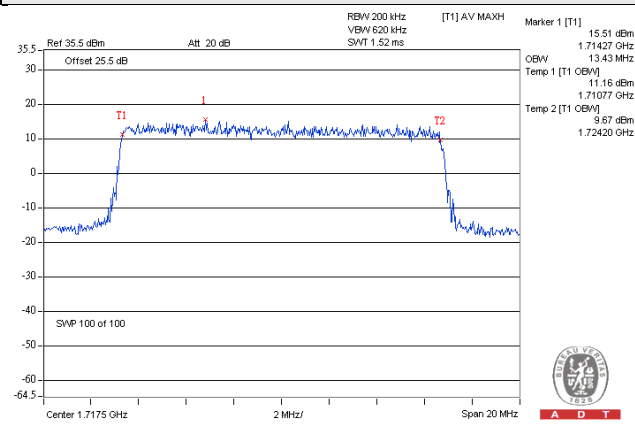
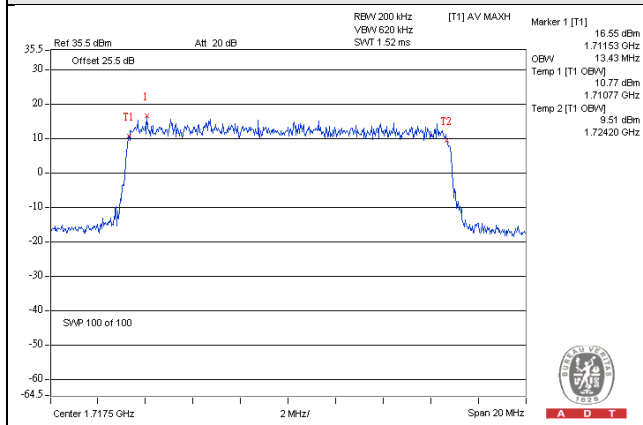

Channel Bandwidth: 20MHz					
Channel	Frequency (MHz)	26dBc Bandwidth (MHz)		Occupied Bandwidth (MHz)	
		QPSK	16QAM	QPSK	16QAM
20050	1720.0	19.47	19.63	18.00	18.00
20175	1732.5	19.54	19.55	17.93	18.07
20300	1745.0	19.52	19.44	17.93	17.93

SPECTRUM PLOT OF WORST VALUE
26dBc Bandwidth

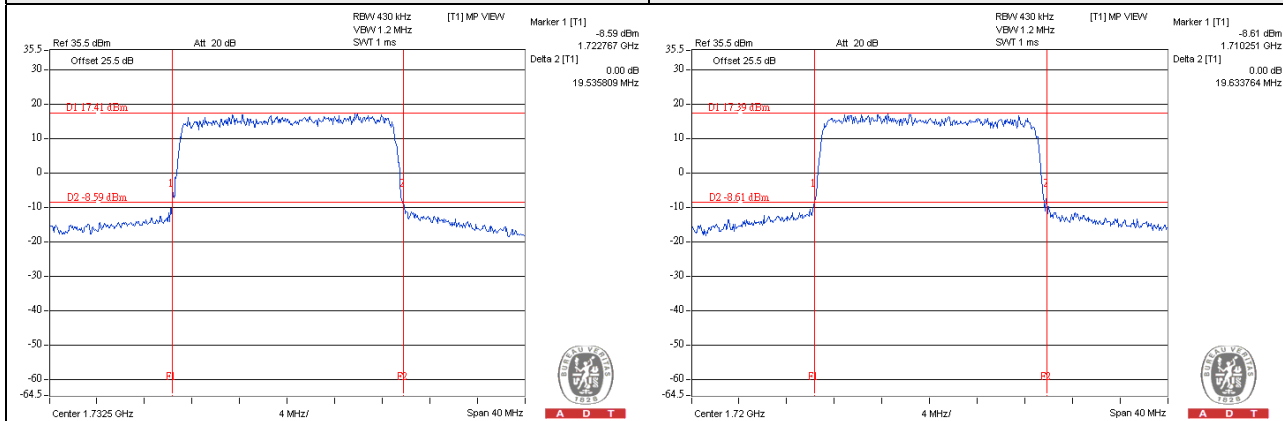

Occupied Bandwidth

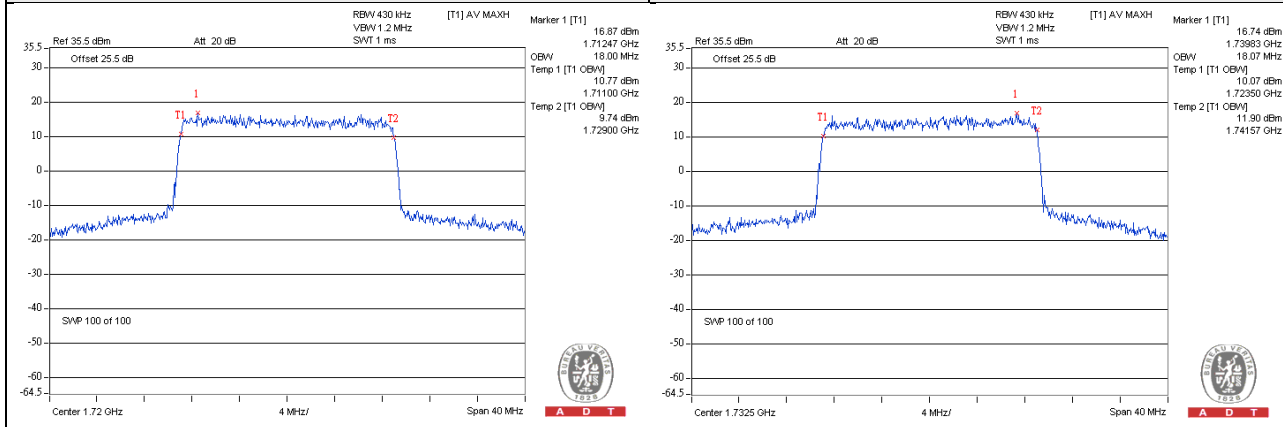

LTE Band 13

Channel Bandwidth: 5MHz					
Channel	Frequency (MHz)	26dBc Bandwidth (MHz)		Occupied Bandwidth (MHz)	
		QPSK	16QAM	QPSK	16QAM
23205	779.5	5.09	5.11	4.48	4.48
23230	782.0	5.13	5.00	4.47	4.47
23255	784.5	5.12	5.05	4.47	4.47

SPECTRUM PLOT OF WORST VALUE

26dBc Bandwidth

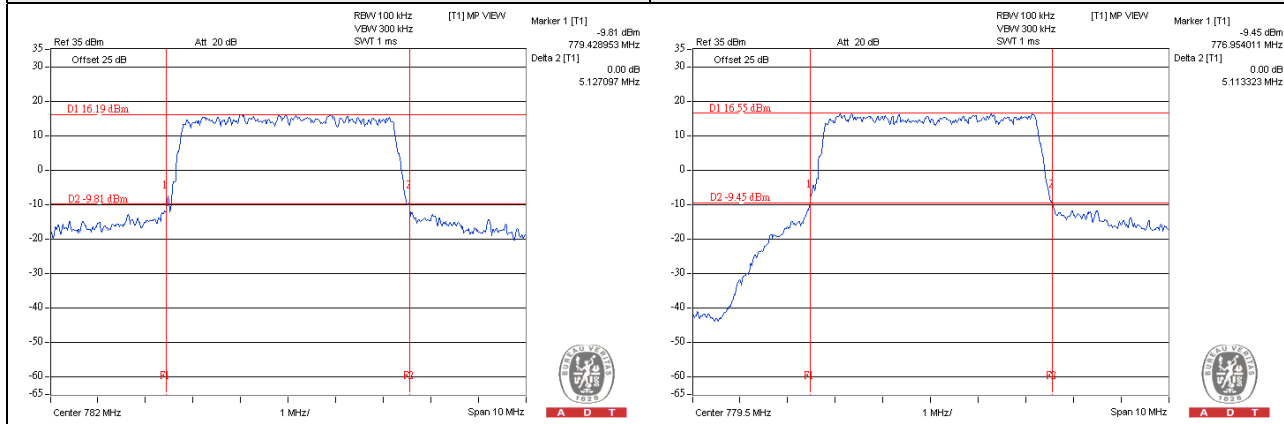

Occupied Bandwidth

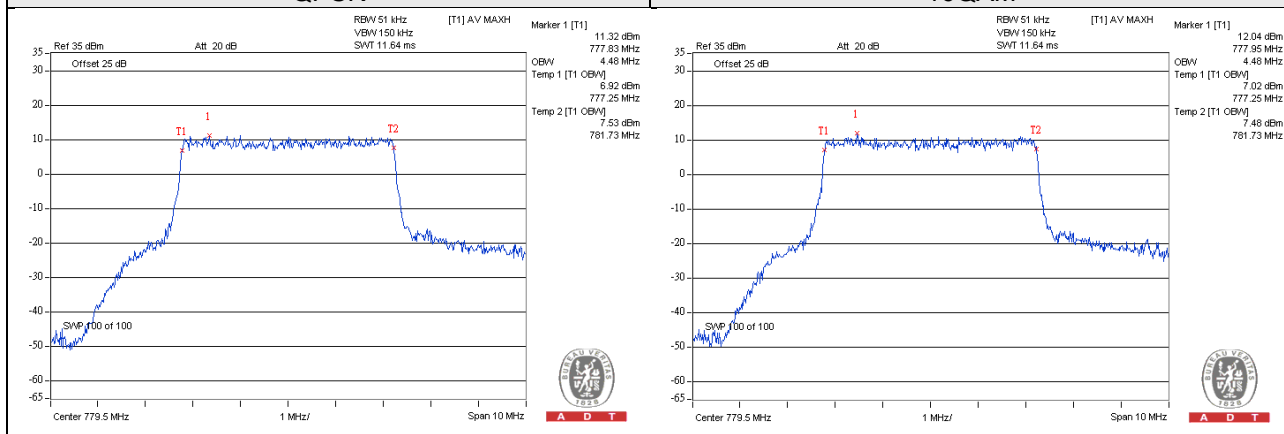

Channel Bandwidth: 10MHz					
Channel	Frequency (MHz)	26dBc Bandwidth (MHz)		Occupied Bandwidth (MHz)	
		QPSK	16QAM	QPSK	16QAM
23230	782.0	9.88	9.76	8.93	8.90

SPECTRUM PLOT OF WORST VALUE

26dBc Bandwidth

QPSK 16QAM

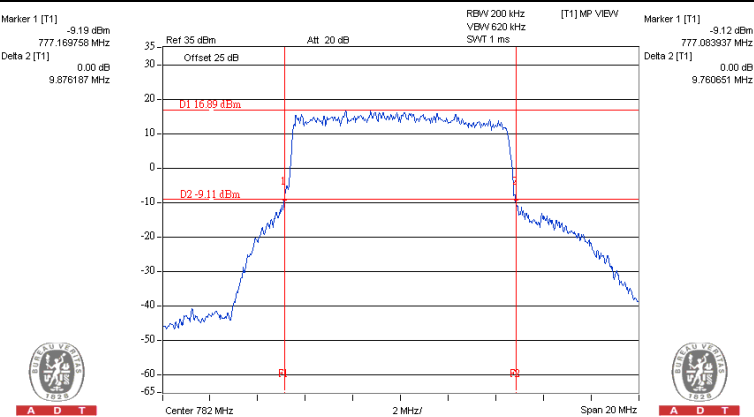
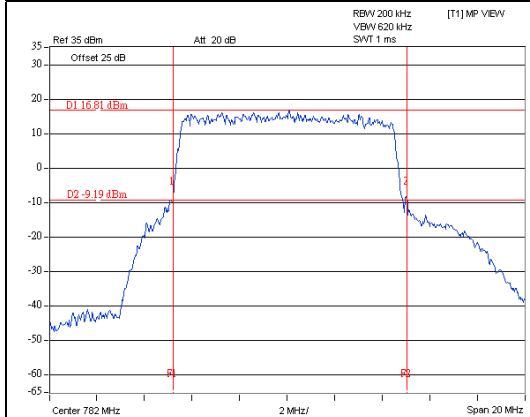

Occupied Bandwidth

QPSK 16QAM

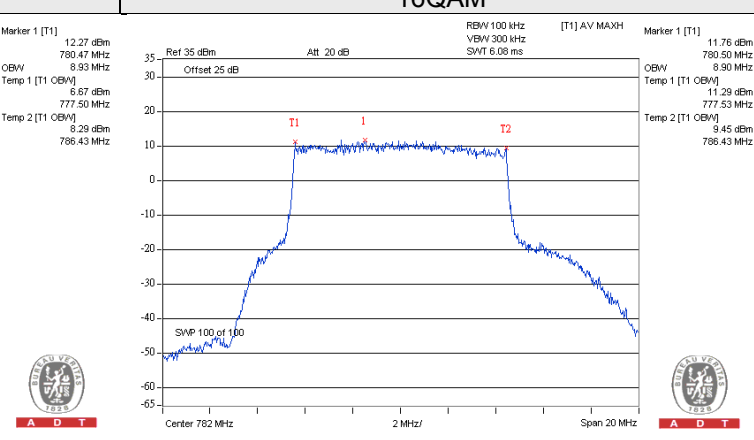
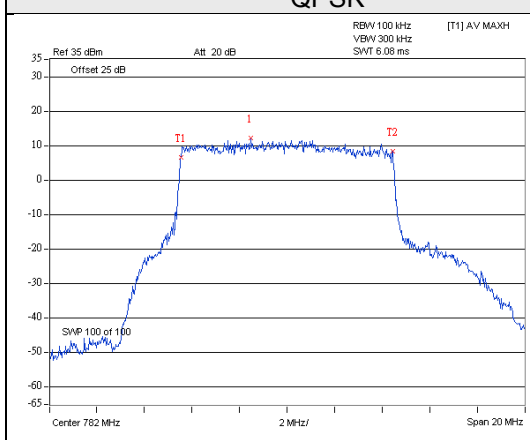

4.4 Channel Edge Measurement

4.4.1 Limits of Band Edge Measurement

For LTE Band 4

According to FCC 27.53(h) for operations in the 1695-1710 MHz, 1710-1755 MHz, 1755-1780 MHz, 1915-1920 MHz, 1995-2000 MHz, 2000-2020 MHz, 2110-2155 MHz, 2155-2180 MHz, and 2180-2200 bands, the power of any emission outside a licensee's frequency block shall be attenuated below the transmitter power (P) in watts by at least $43 + 10 \log_{10}(P)$ dB.

For LTE Band 13

According to FCC 27.53(c) (2) for on any frequency outside the 776-788 MHz band, the power of any emission shall be attenuated outside the band below the transmitter power (P) by at least $43 + 10 \log(P)$ dB.

4.4.2 Test Setup

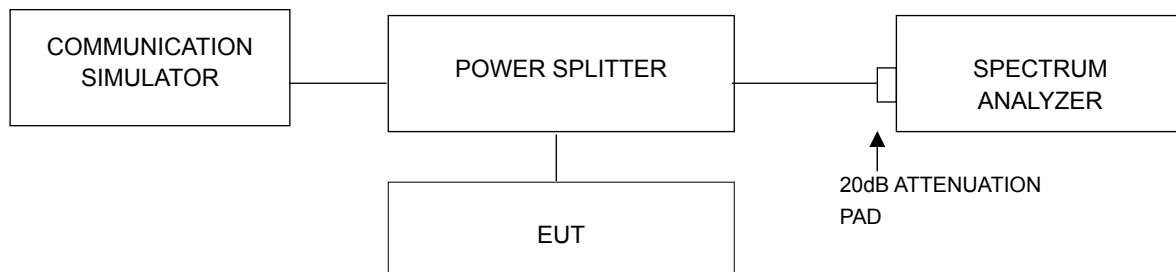

4.4.3 Test Procedures

- The EUT was set up for the rated peak power. The power was measured with Spectrum Analyzer. All measurements were done at 3 channels: low, middle and high operational frequency range.
- The center frequency of spectrum is the band edge frequency and span is 1.5MHz. RBW = 30kHz and VBW = 100kHz (Channel Bandwidth: 1.4MHz and 3MHz), RBW = 51kHz and VBW = 150kHz (Channel Bandwidth: 5MHz), RBW = 100kHz and VBW = 300kHz (Channel Bandwidth: 10MHz), RBW = 200kHz and VBW = 620kHz (Channel Bandwidth: 15MHz) and RBW = 430kHz and VBW = 1.2MHz (Channel Bandwidth: 20MHz).
- Record the max trace plot into the test report.

4.4.4 Test Results

LTE Band 4

Channel Bandwidth: 1.4MHz

Channel 19957 (1710.70MHz)	QPSK	1 RB / 0 RB Offset	Channel 20393 (1754.30MHz)	QPSK	1 RB / 5 RB Offset
-------------------------------	------	--------------------	-------------------------------	------	--------------------

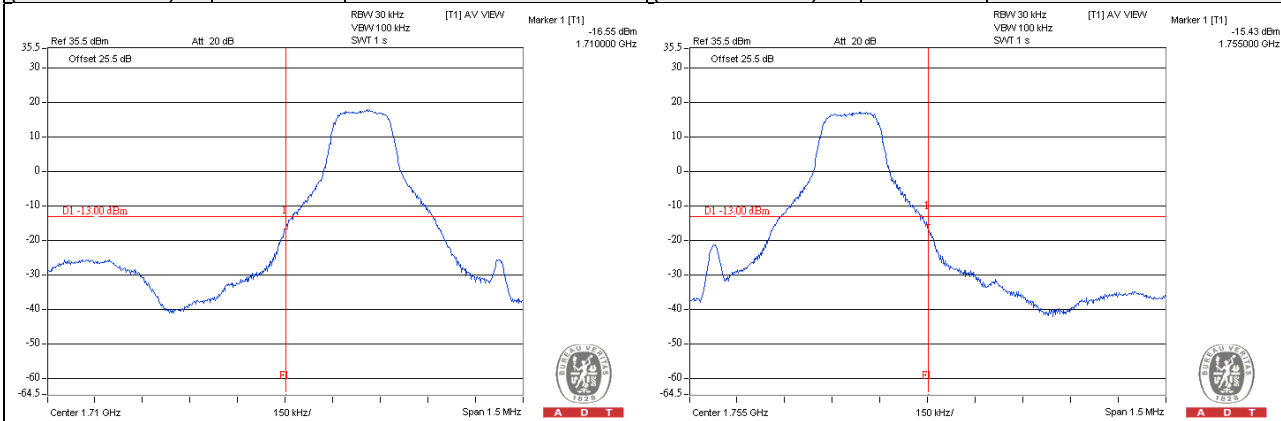

Channel 19957 (1710.70MHz)	QPSK	6 RB / 0 RB Offset	Channel 20393 (1754.30MHz)	QPSK	6 RB / 0 RB Offset
-------------------------------	------	--------------------	-------------------------------	------	--------------------

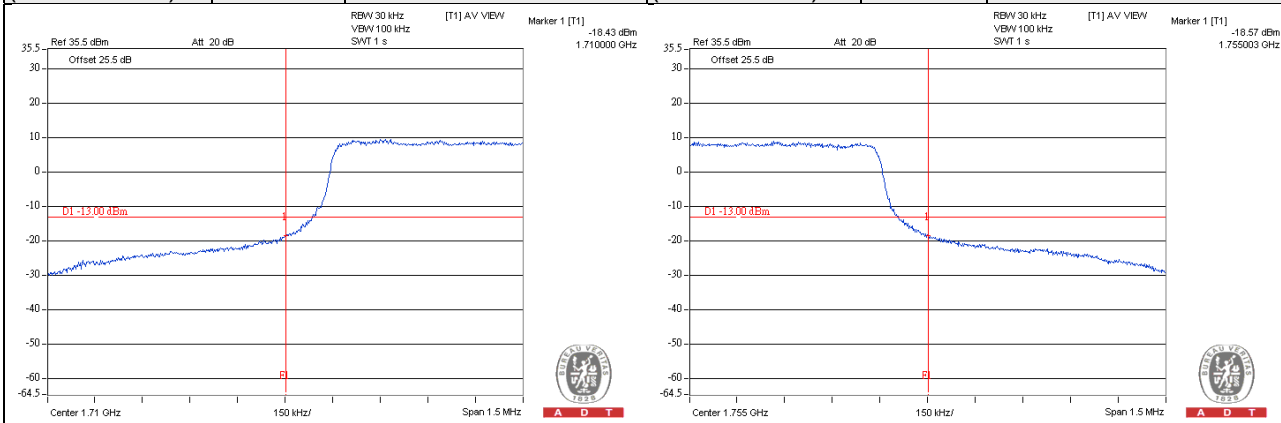

Channel Bandwidth: 3MHz

Channel 19965 (1711.50MHz)	QPSK	1 RB / 0 RB Offset	Channel 20385 (1753.50MHz)	QPSK	1 RB / 14 RB Offset
---------------------------------------	-------------	---------------------------	---------------------------------------	-------------	----------------------------

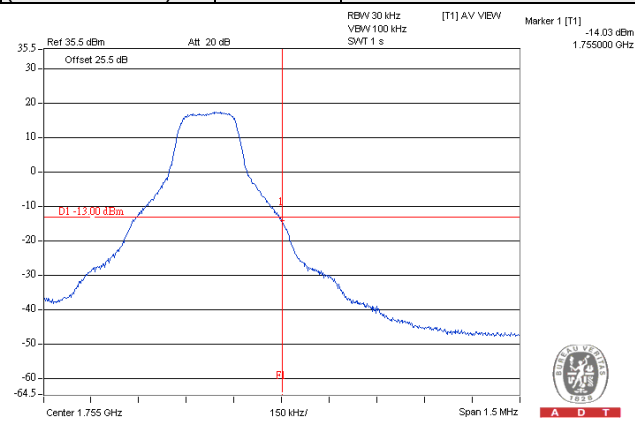
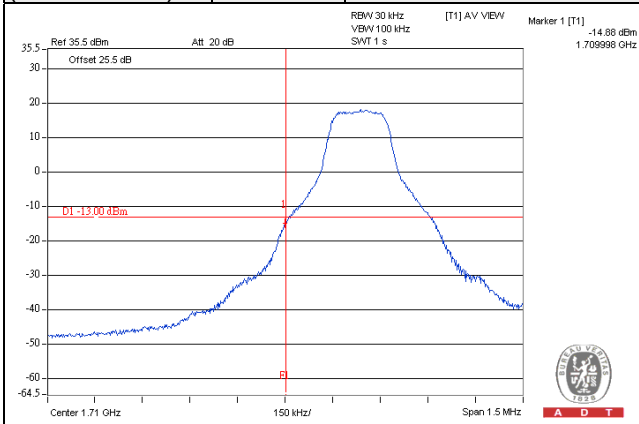

Channel 19965 (1711.50MHz)	QPSK	15 RB / 0 RB Offset	Channel 20385 (1753.50MHz)	QPSK	15 RB / 0 RB Offset
---------------------------------------	-------------	----------------------------	---------------------------------------	-------------	----------------------------

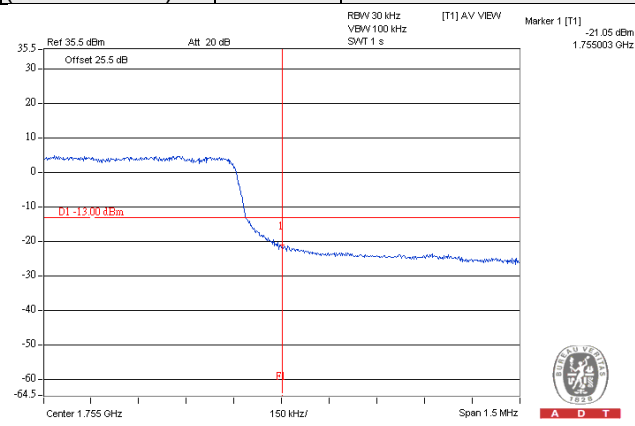
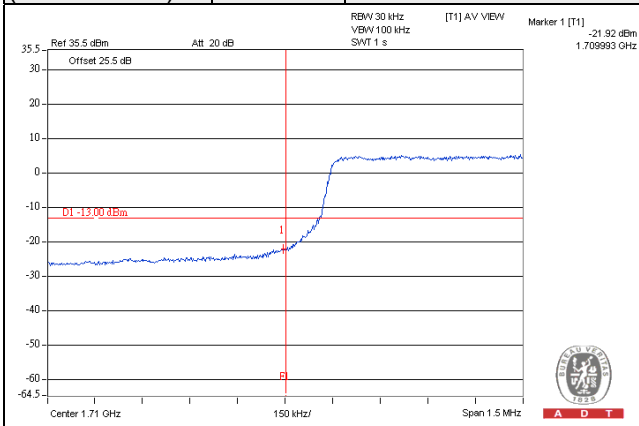

Channel Bandwidth: 5MHz

Channel 19975 (1712.50MHz)	QPSK	1 RB / 0 RB Offset	Channel 20375 (1752.50MHz)	QPSK	1 RB / 24 RB Offset
---------------------------------------	-------------	---------------------------	---------------------------------------	-------------	----------------------------

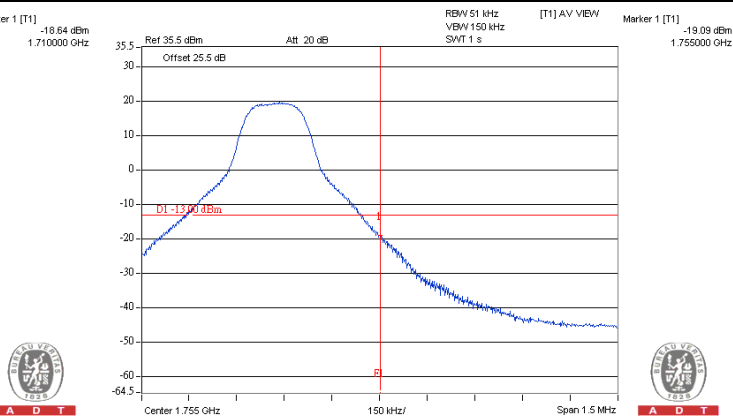
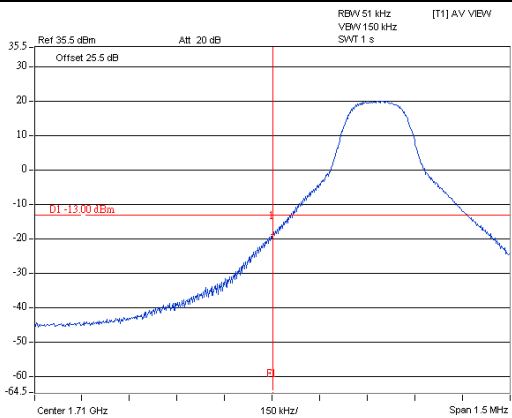

Channel 19975 (1712.50MHz)	QPSK	25 RB / 0 RB Offset	Channel 20375 (1752.50MHz)	QPSK	25 RB / 0 RB Offset
---------------------------------------	-------------	----------------------------	---------------------------------------	-------------	----------------------------

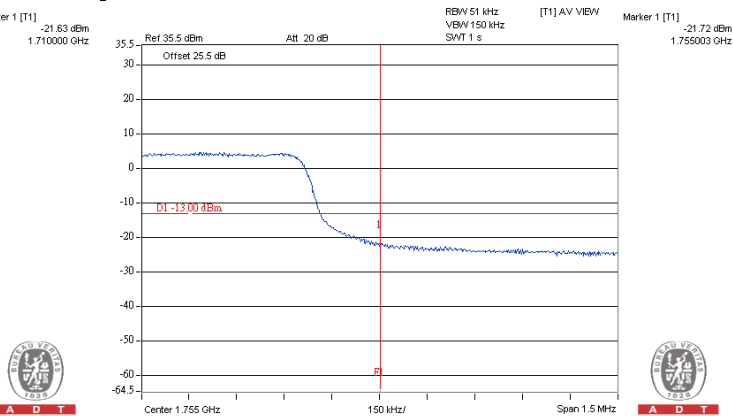
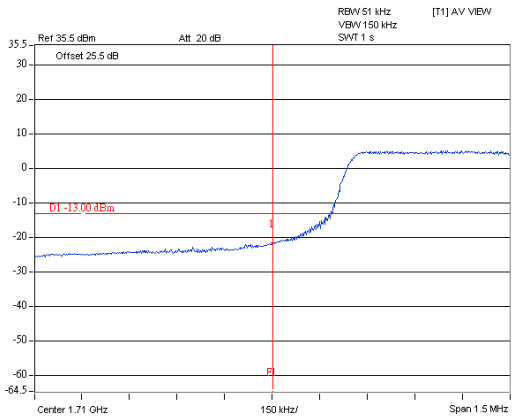

Channel Bandwidth: 10MHz

Channel 20000
(1715.00MHz)

QPSK

1 RB / 0 RB Offset

Channel 20350
(1750.00MHz)

QPSK

1 RB / 49 RB Offset

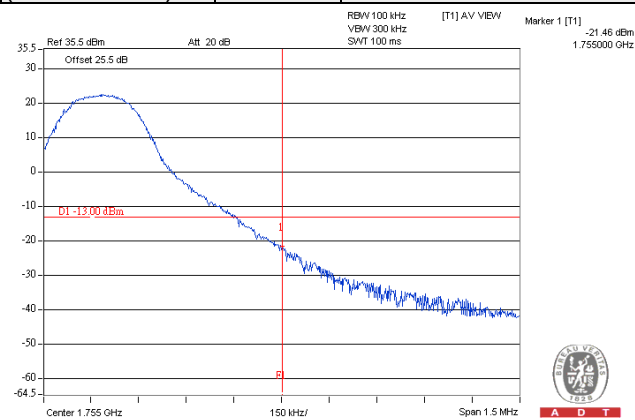
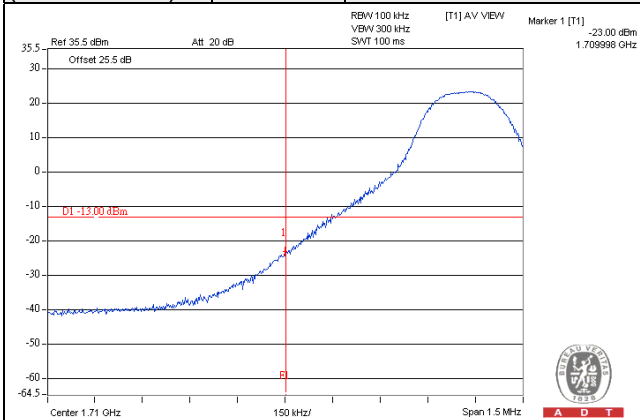

Channel 20000
(1715.00MHz)

QPSK

50 RB / 0 RB Offset

Channel 20350
(1750.00MHz)

QPSK

50 RB / 0 RB Offset

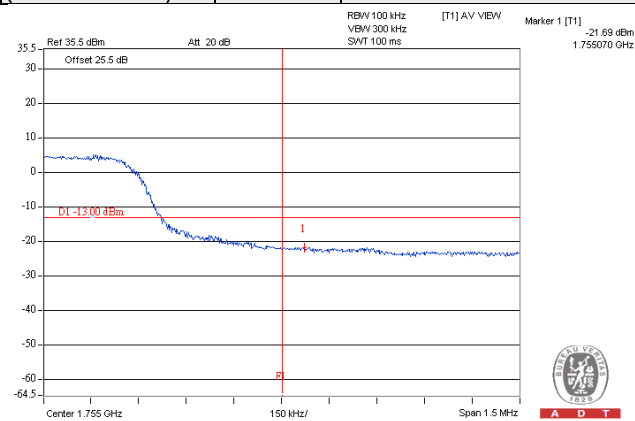
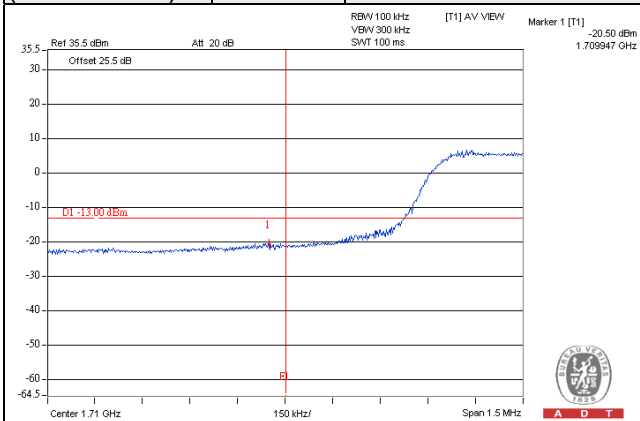

Channel Bandwidth: 15MHz

**Channel 20025
(1717.50MHz)**

QPSK

1 RB / 0 RB Offset

**Channel 20325
(1747.50MHz)**

QPSK

1 RB / 74 RB Offset

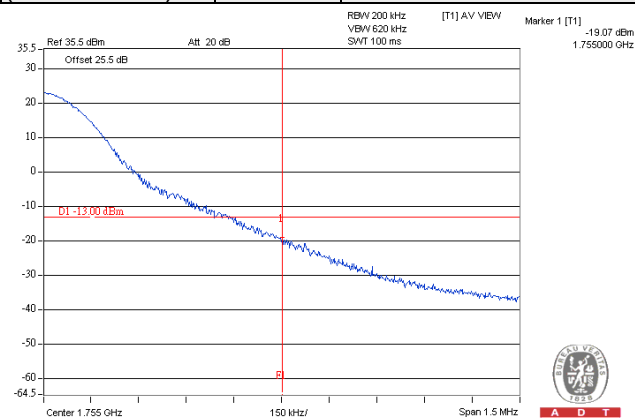
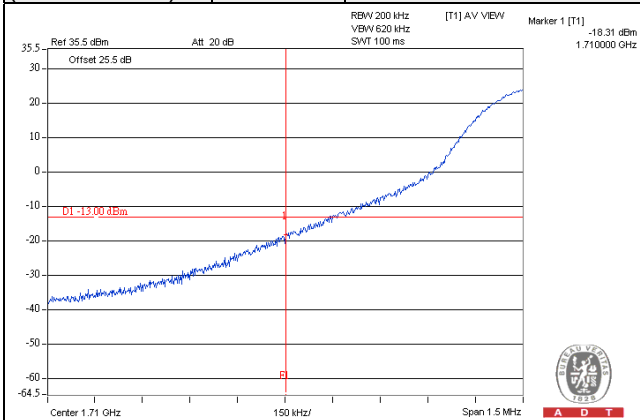

**Channel 20025
(1717.50MHz)**

QPSK

75 RB / 0 RB Offset

**Channel 20325
(1747.50MHz)**

QPSK

75 RB / 0 RB Offset

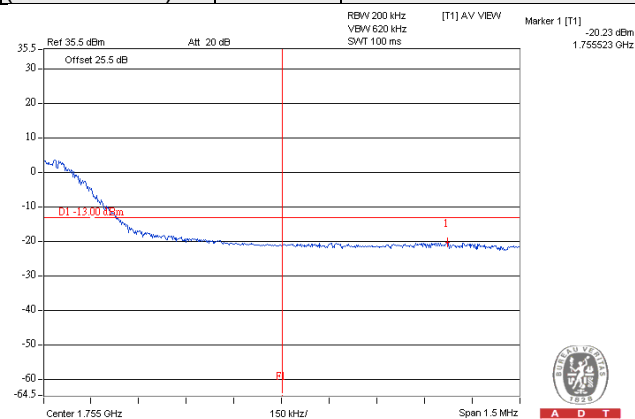
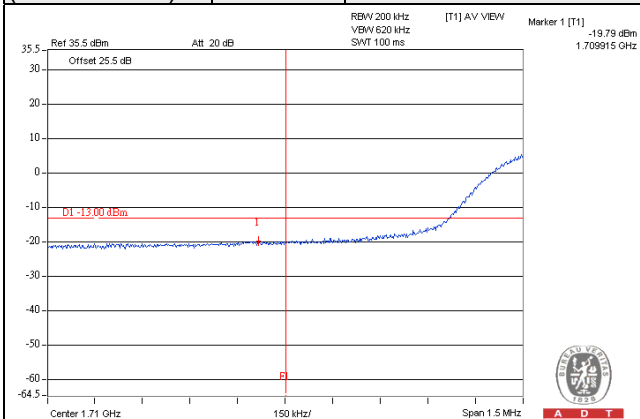

Channel Bandwidth: 20MHz

Channel 20050 (1720.00MHz)	QPSK	1 RB / 0 RB Offset	Channel 20300 (1745.00MHz)	QPSK	1 RB / 99 RB Offset
-------------------------------	------	--------------------	-------------------------------	------	---------------------

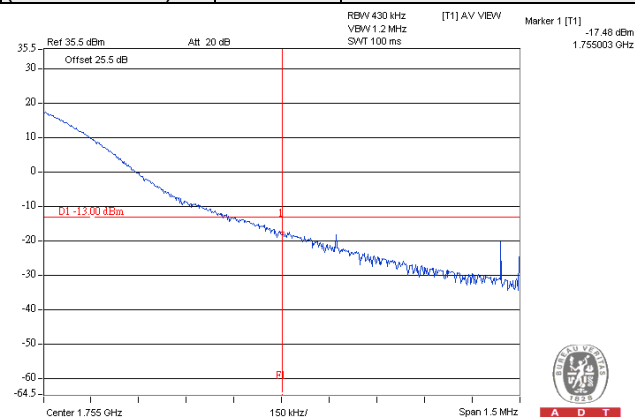
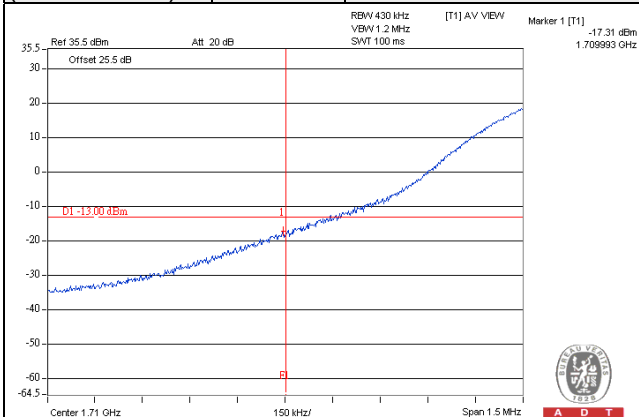

Channel 20050 (1720.00MHz)	QPSK	100 RB / 0 RB Offset	Channel 20300 (1745.00MHz)	QPSK	100 RB / 0 RB Offset
-------------------------------	------	----------------------	-------------------------------	------	----------------------

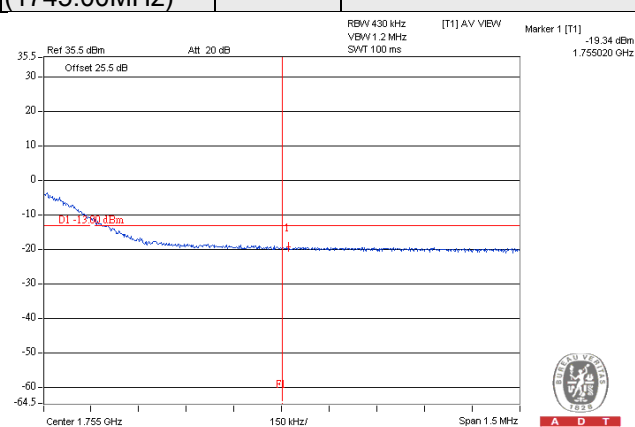
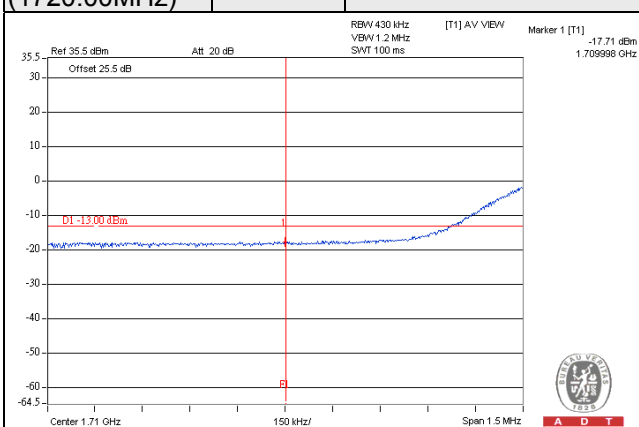

LTE Band 13

Channel Bandwidth: 5MHz

Channel 23205 (779.50MHz)	QPSK	1 RB / 0 RB Offset	Channel 23255 (784.50MHz)	QPSK	1 RB / 24 RB Offset
------------------------------	------	--------------------	------------------------------	------	---------------------

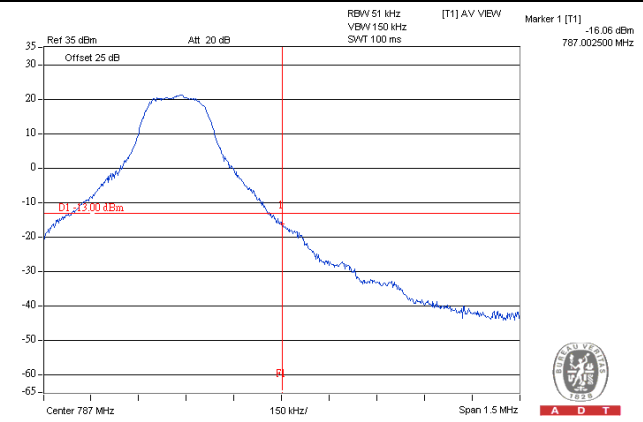
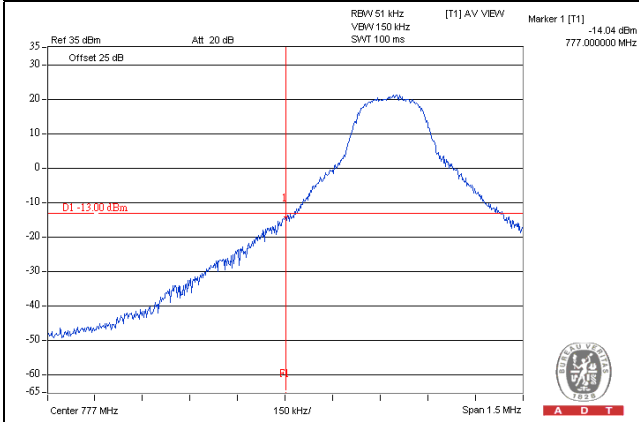

Channel 23205 (779.50MHz)	QPSK	25 RB / 0 RB Offset	Channel 23255 (784.50MHz)	QPSK	25 RB / 0 RB Offset
------------------------------	------	---------------------	------------------------------	------	---------------------

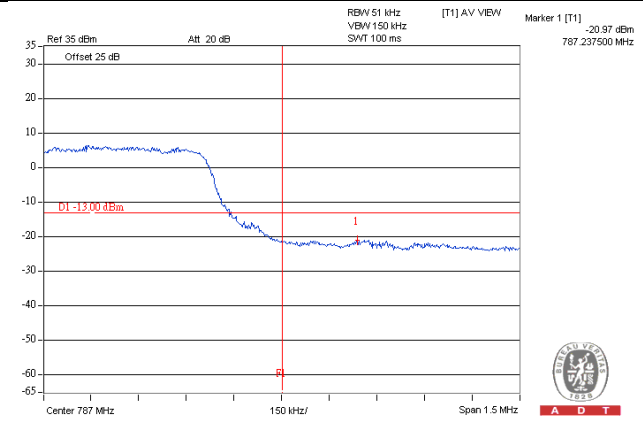
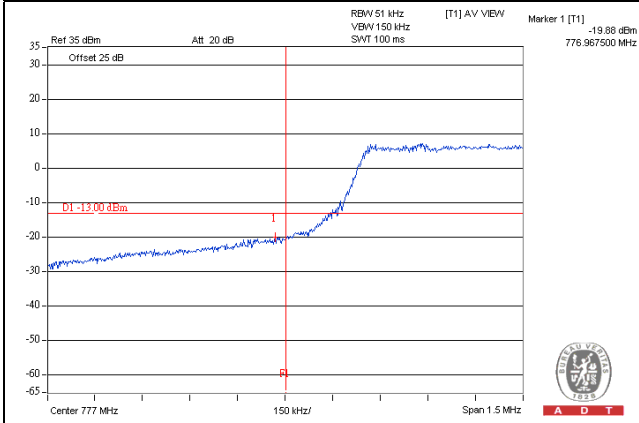

Channel Bandwidth: 10MHz

Channel 23230 (782.00MHz)	QPSK	1 RB / 0 RB Offset	Channel 23230 (782.00MHz)	QPSK	1 RB / 49 RB Offset
--------------------------------------	-------------	---------------------------	--------------------------------------	-------------	----------------------------

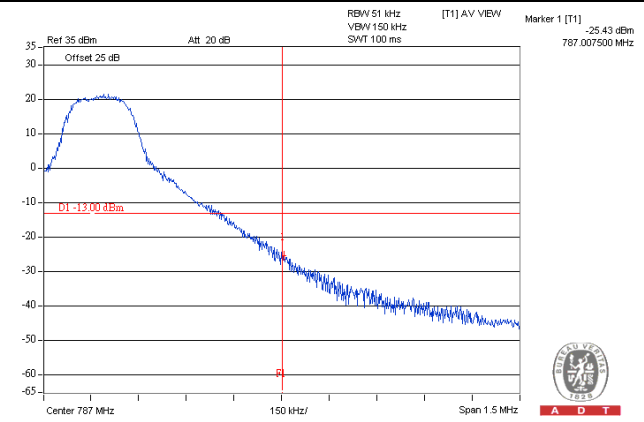
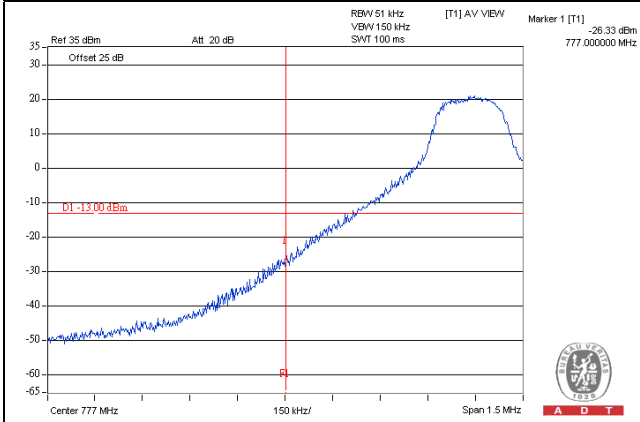

Channel 23230 (782.00MHz)	QPSK	50 RB / 0 RB Offset	Channel 23230 (782.00MHz)	QPSK	50 RB / 0 RB Offset
--------------------------------------	-------------	----------------------------	--------------------------------------	-------------	----------------------------

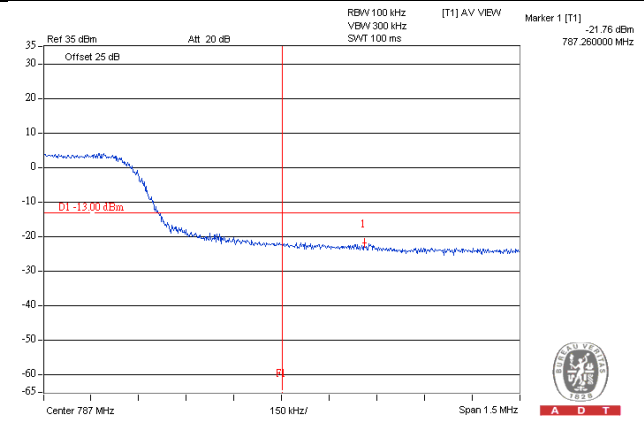
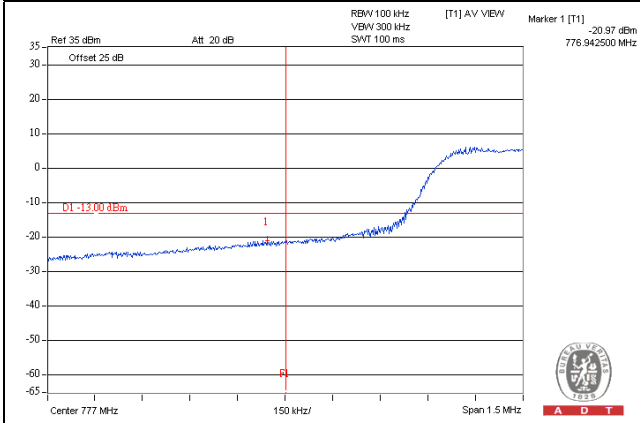

4.5 Peak to Average Ratio

4.5.1 Limits of Peak to Average Ratio Measurement

In measuring transmissions in this band using an average power technique, the peak to-average ratio (PAR) of the transmission may not exceed 13 dB

4.5.2 Test Setup

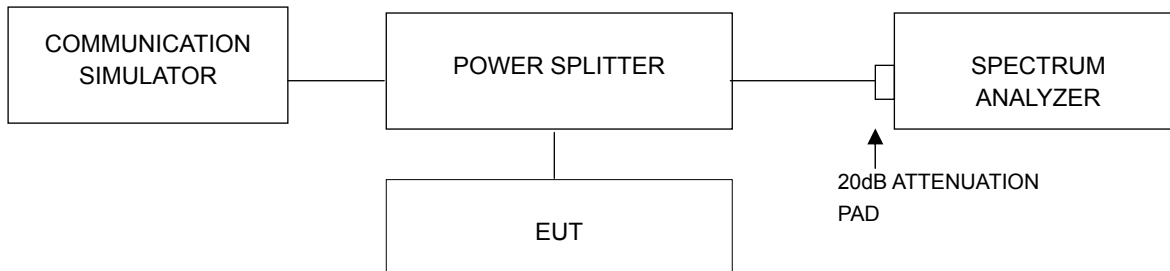

4.5.3 Test Procedures

- Set resolution/measurement bandwidth \geq signal's occupied bandwidth;
- Set the number of counts to a value that stabilizes the measured CCDF curve;
- Record the maximum PAPR level associated with a probability of 0.1%.

4.5.4 Test Results

LTE Band 4

Channel Bandwidth: 1.4MHz			
Channel	Frequency (MHz)	Peak To Average Ratio (dB)	
		QPSK	16QAM
19957	1710.7	4.67	4.74
20175	1732.5	4.92	5.05
20393	1754.3	4.72	4.85

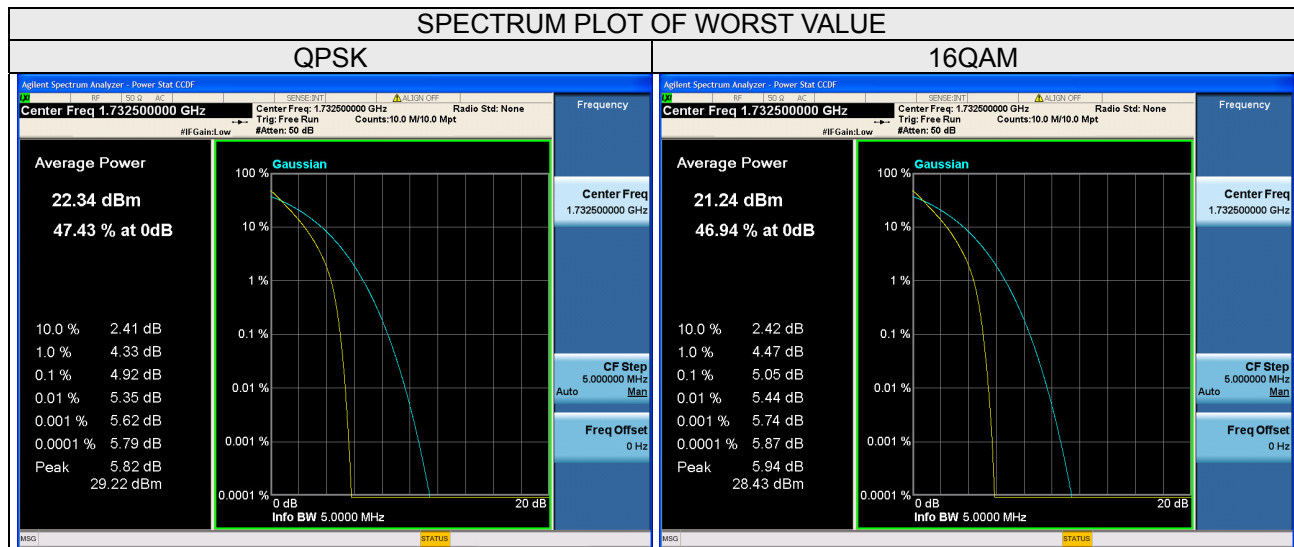

Channel Bandwidth: 3MHz

Channel	Frequency (MHz)	Peak To Average Ratio (dB)	
		QPSK	16QAM
19965	1711.5	4.84	4.79
20175	1732.5	5.13	5.15
20385	1753.5	5.20	5.03

SPECTRUM PLOT OF WORST VALUE



Channel Bandwidth: 5MHz			
Channel	Frequency (MHz)	Peak To Average Ratio (dB)	
		QPSK	16QAM
19975	1712.5	4.58	5.03
20175	1732.5	4.77	5.21
20375	1752.5	5.09	5.11

SPECTRUM PLOT OF WORST VALUE



Channel Bandwidth: 10MHz

Channel	Frequency (MHz)	Peak To Average Ratio (dB)	
		QPSK	16QAM
20000	1715.0	4.72	5.27
20175	1732.5	5.21	5.24
20350	1750.0	5.17	5.19

SPECTRUM PLOT OF WORST VALUE



Channel Bandwidth: 15MHz

Channel	Frequency (MHz)	Peak To Average Ratio (dB)	
		QPSK	16QAM
20025	1717.5	5.09	5.09
20175	1732.5	5.23	5.36
20325	1747.5	5.24	5.30

SPECTRUM PLOT OF WORST VALUE

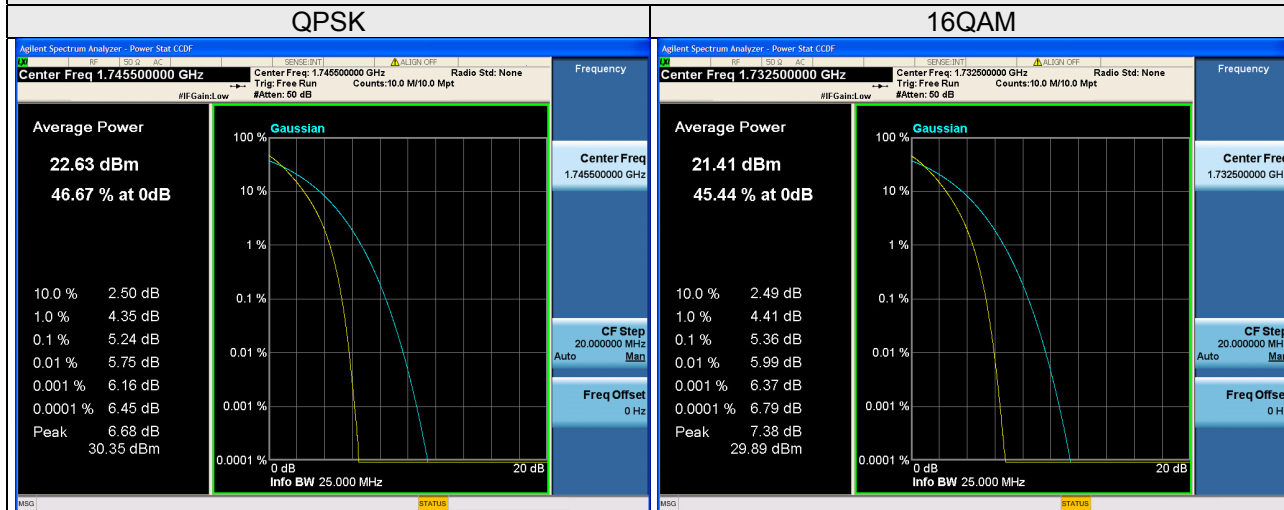

Channel Bandwidth: 20MHz

Channel	Frequency (MHz)	Peak To Average Ratio (dB)	
		QPSK	16QAM
20050	1720.0	5.03	5.38
20175	1732.5	5.32	5.37
20300	1745.0	5.25	5.35

SPECTRUM PLOT OF WORST VALUE

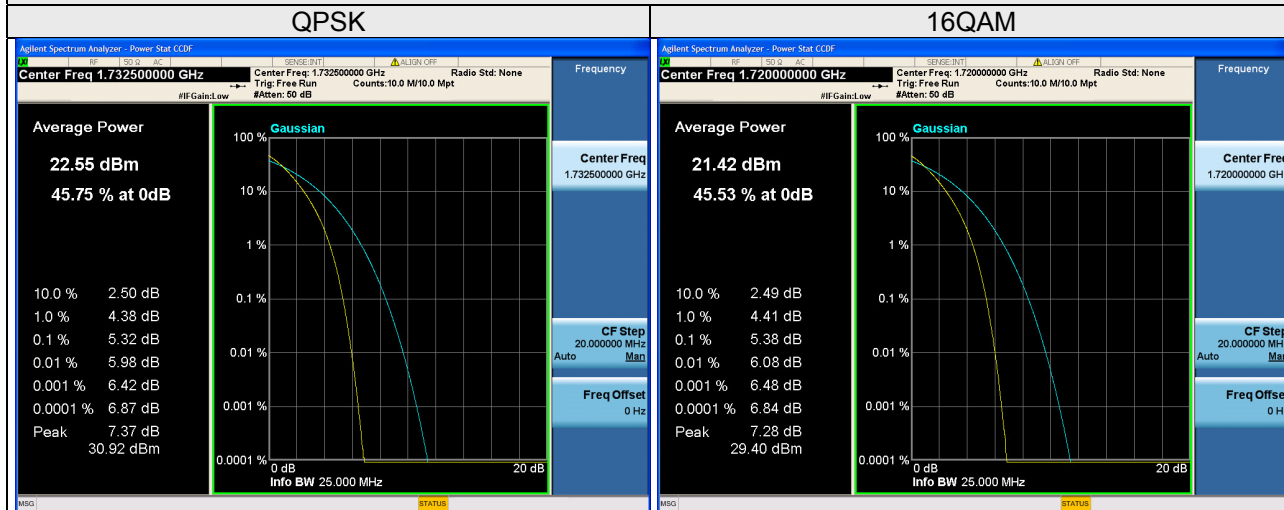

LTE Band 13

Channel Bandwidth: 5MHz			
Channel	Frequency (MHz)	Peak To Average Ratio (dB)	
		QPSK	16QAM
23205	779.5	5.00	5.55
23230	782.0	5.28	5.36
23255	784.5	5.66	5.61

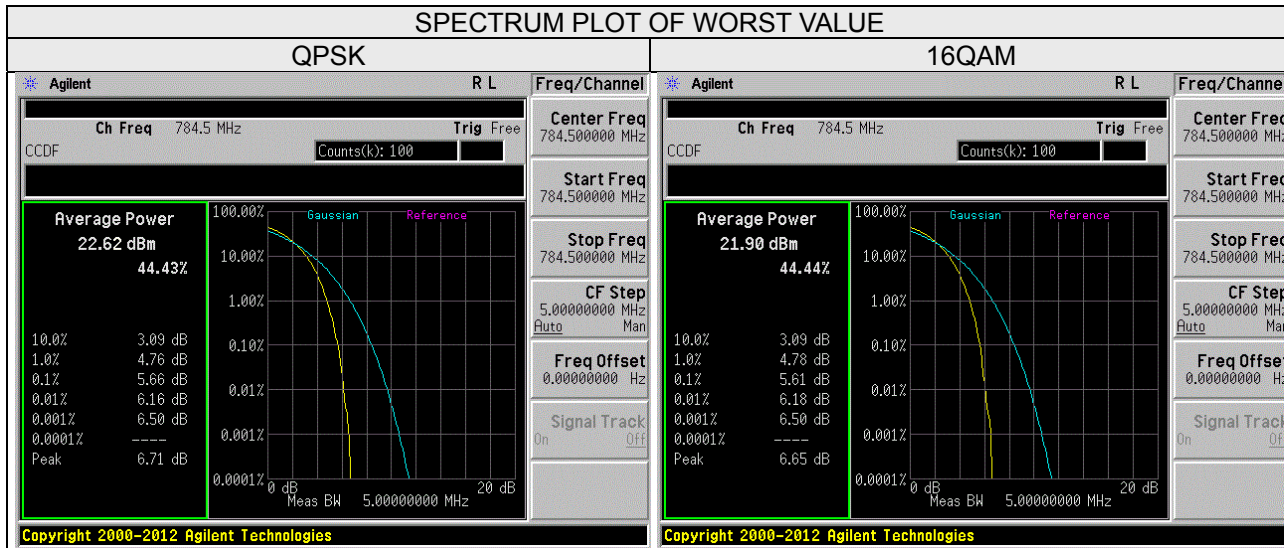

Channel Bandwidth: 10MHz			
Channel	Frequency (MHz)	Peak To Average Ratio (dB)	
		QPSK	16QAM
23230	782.0	5.22	5.19

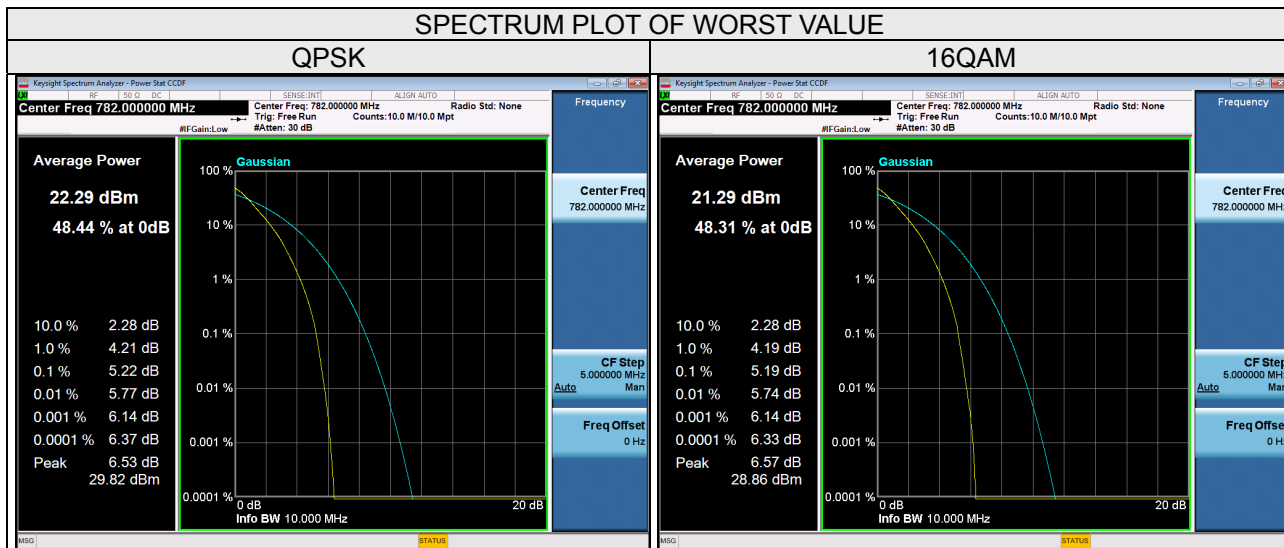

4.6 Conducted Spurious Emissions

4.6.1 Limits of Conducted Spurious Emissions Measurement

For LTE Band 4

According to FCC 27.53(h) for operations in the 1695-1710 MHz, 1710-1755 MHz, 1755-1780 MHz, 1915-1920 MHz, 1995-2000 MHz, 2000-2020 MHz, 2110-2155 MHz, 2155-2180 MHz, and 2180-2200 bands, the power of any emission outside a licensee's frequency block shall be attenuated below the transmitter power (P) in watts by at least $43 + 10 \log_{10}(P)$ dB.

For LTE Band 13

According to FCC 27.53(c) (2) for on any frequency outside the 776-788 MHz band, the power of any emission shall be attenuated outside the band below the transmitter power (P) by at least $43 + 10 \log(P)$ dB.

4.6.2 Test Setup

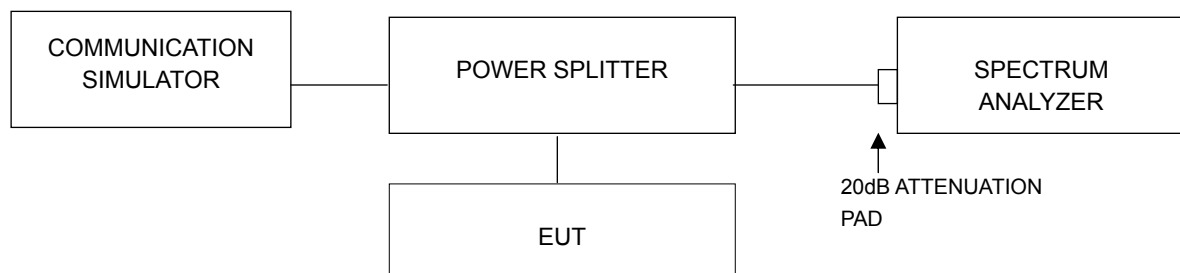

4.6.3 Test Procedure

- All measurements were done at 3 channels: low, middle and high operational frequency range.
- When the spectrum scanned from 9kHz to 20GHz for LTE Band 4 and 9kHz to 9GHz for LTE Band 13 & 17, it shall be connected to the 20dB pad attenuated the carried frequency. The spectrum set RB = 1MHz, VB = 3MHz.

4.6.4 Test Results

LTE Band 4

Channel Bandwidth: 1.4MHz
Channel 19957 (1710.70MHz)
Frequency Range : 9kHz~3GHz
Frequency Range : 3GHz~10GHz

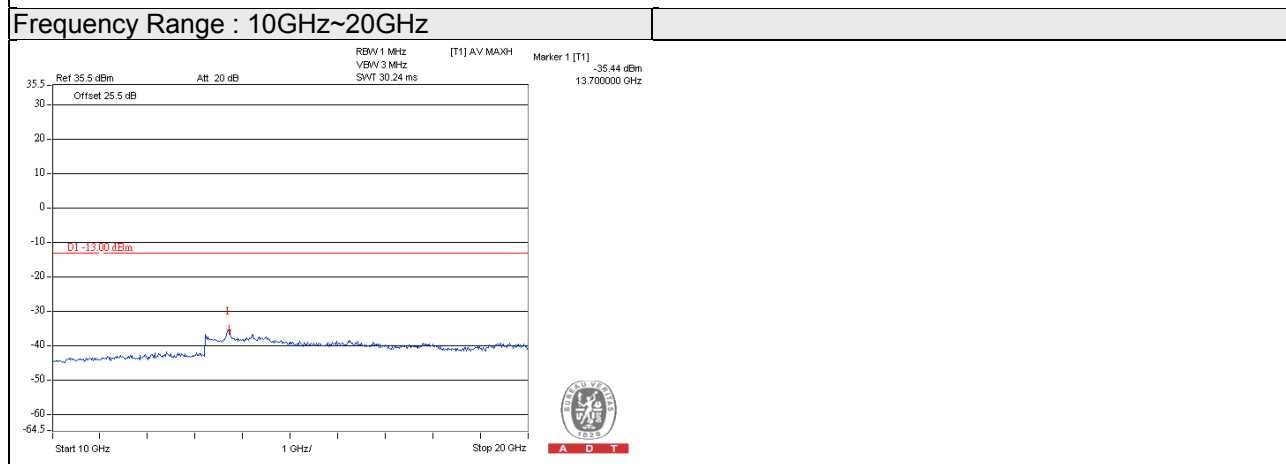
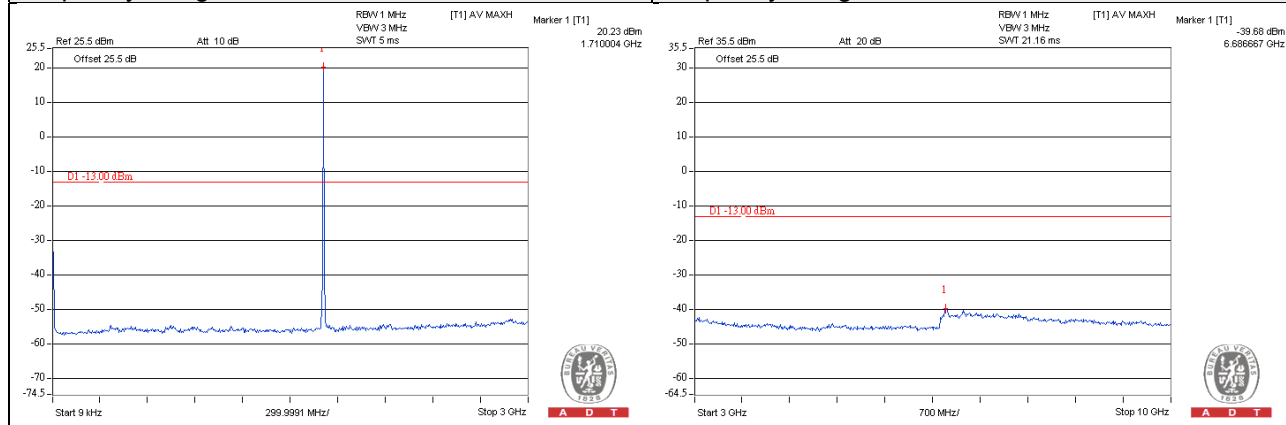

Channel Bandwidth: 1.4MHz
 Channel 20175 (1732.50MHz)
 Frequency Range : 9kHz~3GHz

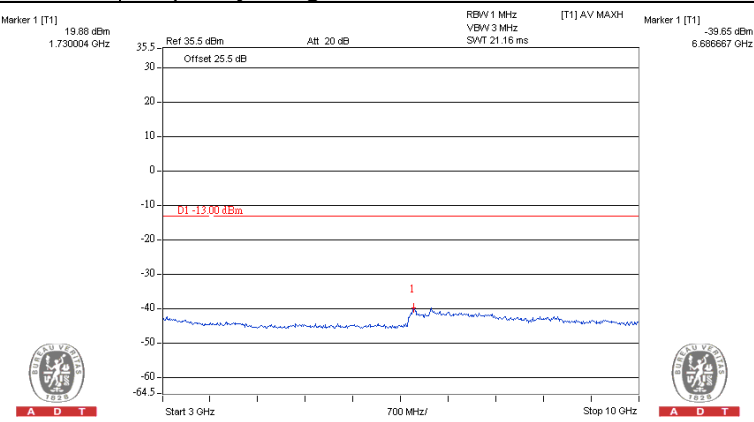
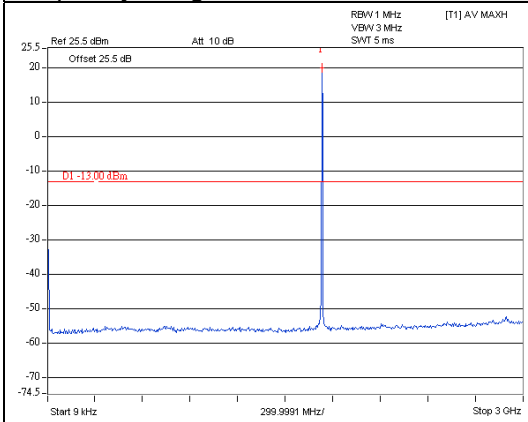

Frequency Range : 10GHz~20GHz

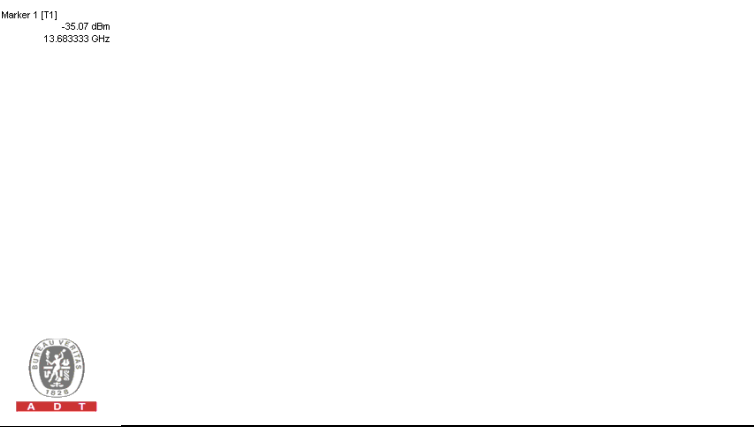
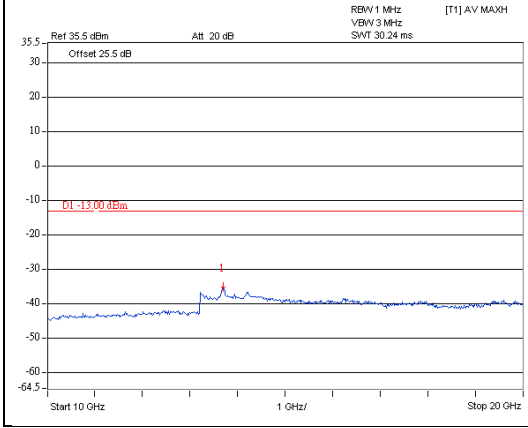

Channel Bandwidth: 1.4MHz

Channel 20393 (1754.30MHz)

Frequency Range : 9kHz~3GHz

Frequency Range : 3GHz~10GHz

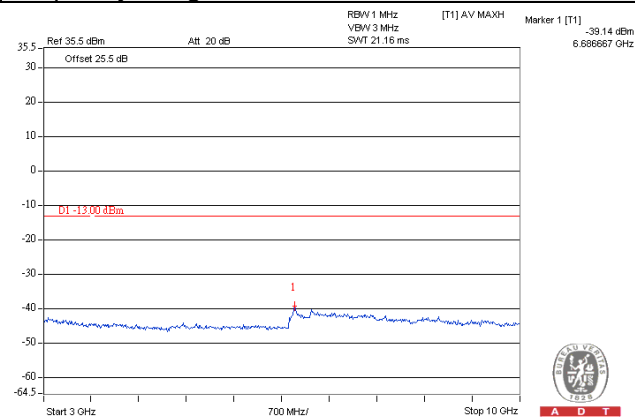
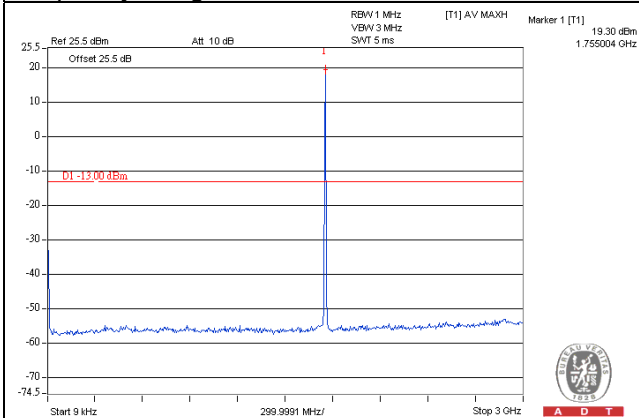

Frequency Range : 10GHz~20GHz

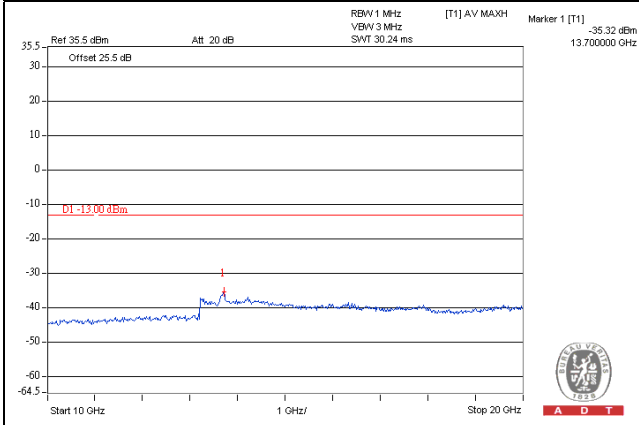

Channel Bandwidth: 3MHz

Channel 19965 (1711.50MHz)

Frequency Range : 9kHz~3GHz

Frequency Range : 3GHz~10GHz

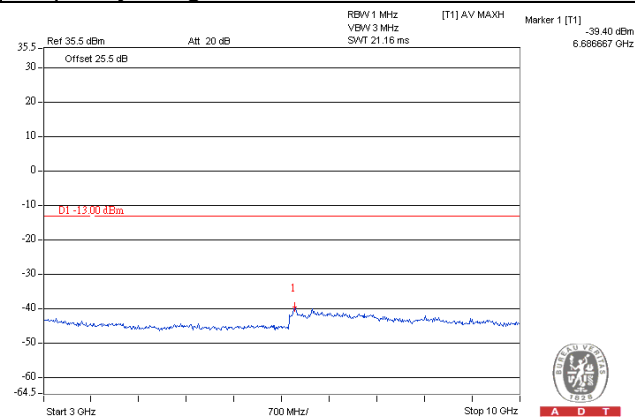
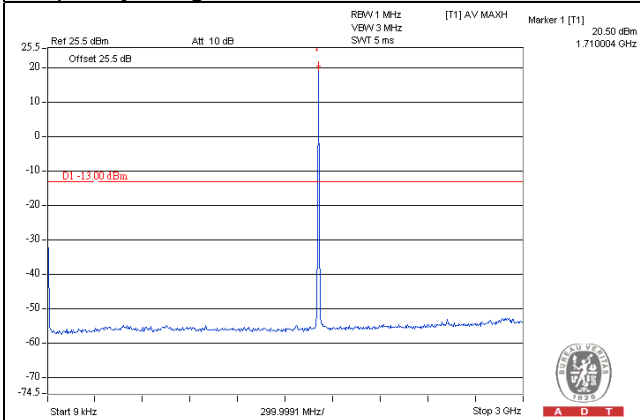

Frequency Range : 10GHz~20GHz

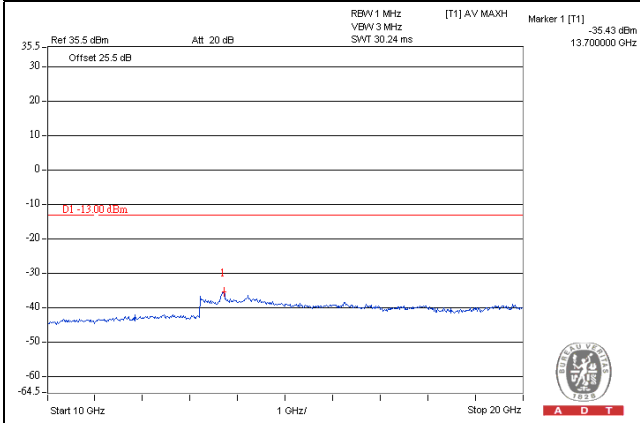

Channel Bandwidth: 3MHz

Channel 20175 (1732.50MHz)

Frequency Range : 9kHz~3GHz

Frequency Range : 3GHz~10GHz

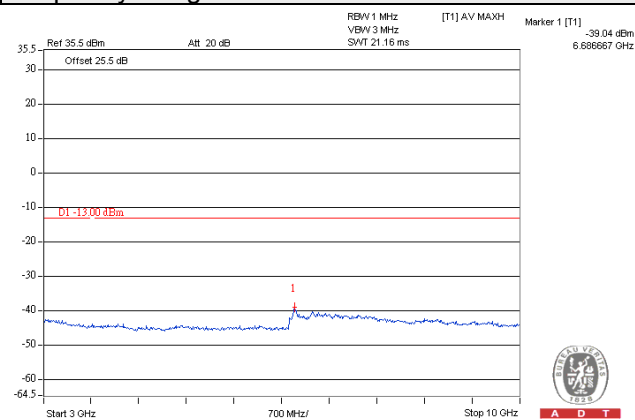
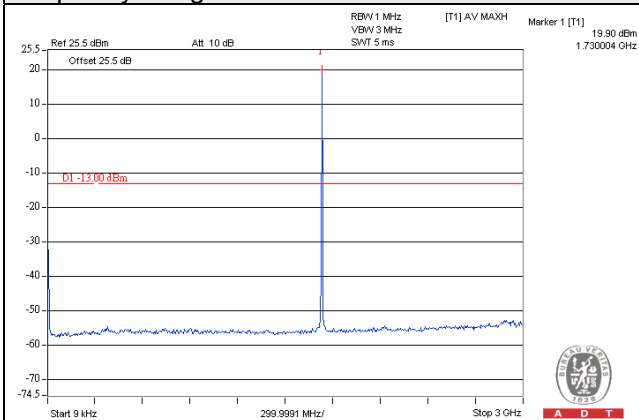

Frequency Range : 10GHz~20GHz

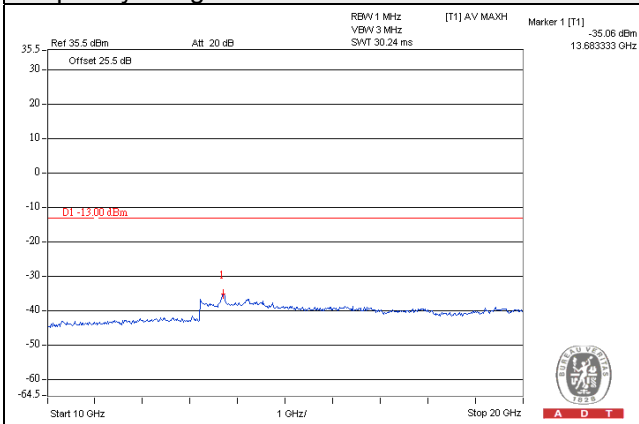

Channel Bandwidth: 3MHz

Channel 20385 (1753.50MHz)

Frequency Range : 9kHz~3GHz

Frequency Range : 3GHz~10GHz

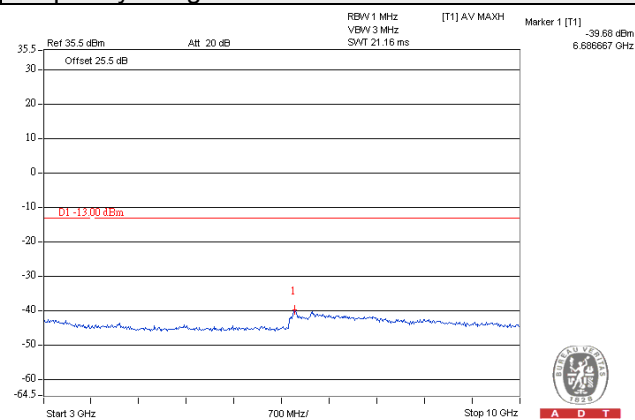
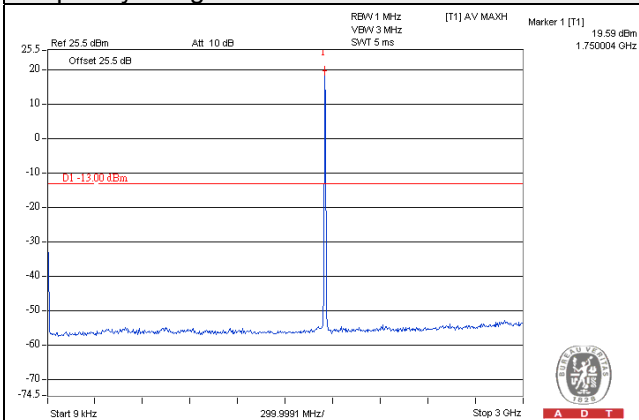

Frequency Range : 10GHz~20GHz

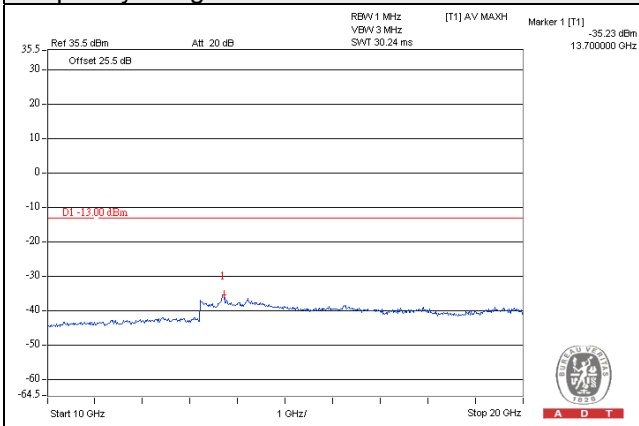

Channel Bandwidth: 5MHz

Channel 19975 (1712.50MHz)

Frequency Range : 9kHz~3GHz

Frequency Range : 3GHz~10GHz

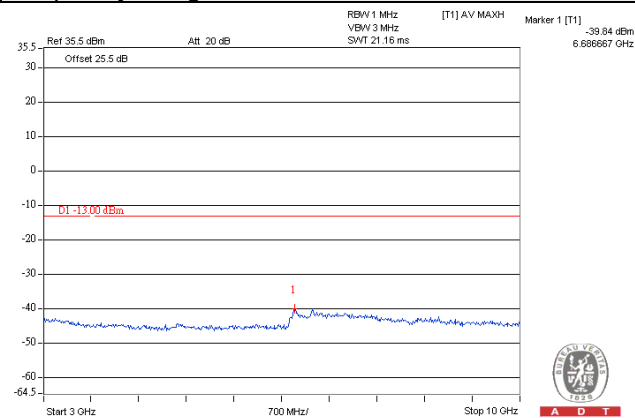
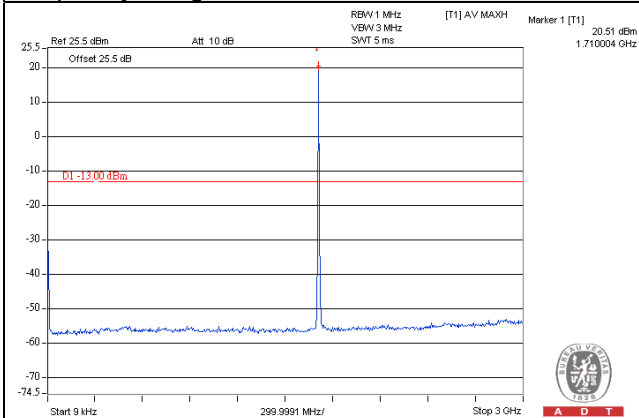

Frequency Range : 10GHz~20GHz

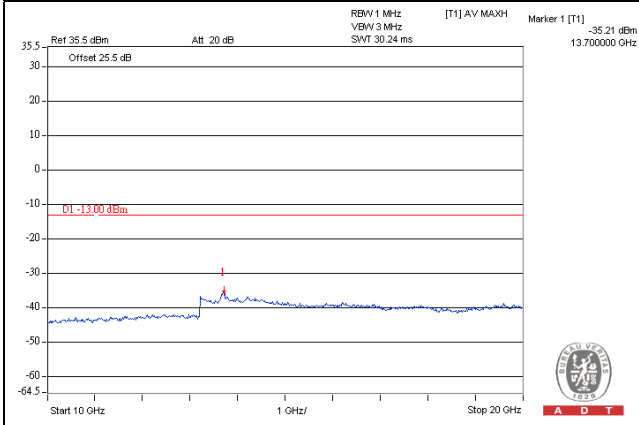

Channel Bandwidth: 5MHz

Channel 20175 (1732.50MHz)

Frequency Range : 9kHz~3GHz

Frequency Range : 3GHz~10GHz

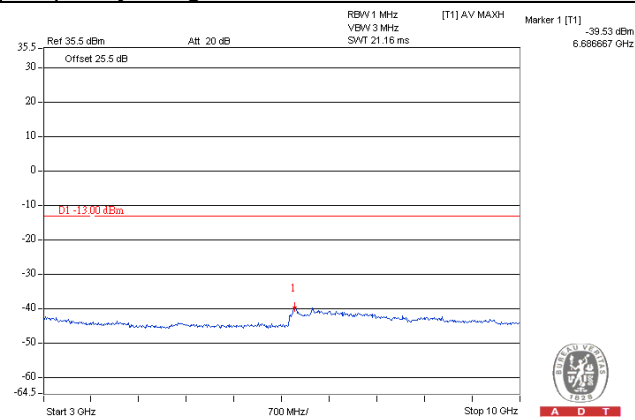
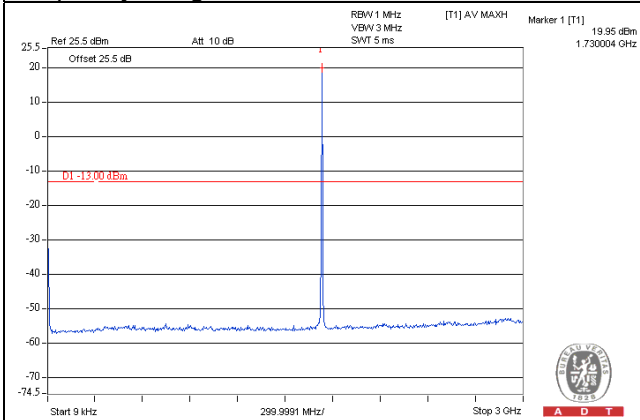

Frequency Range : 10GHz~20GHz

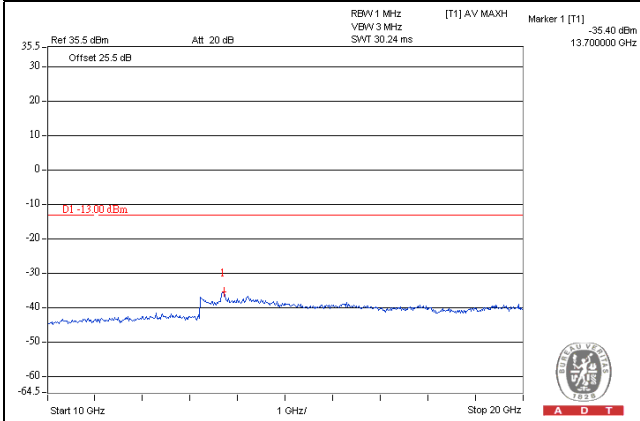

Channel Bandwidth: 5MHz
 Channel 20375 (1752.50MHz)
 Frequency Range : 9kHz~3GHz

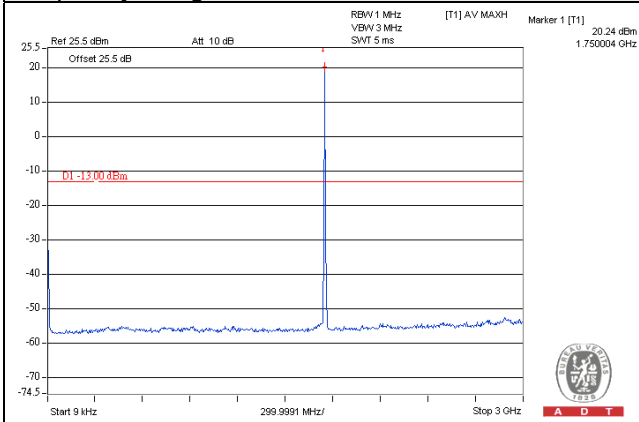

Frequency Range : 3GHz~10GHz

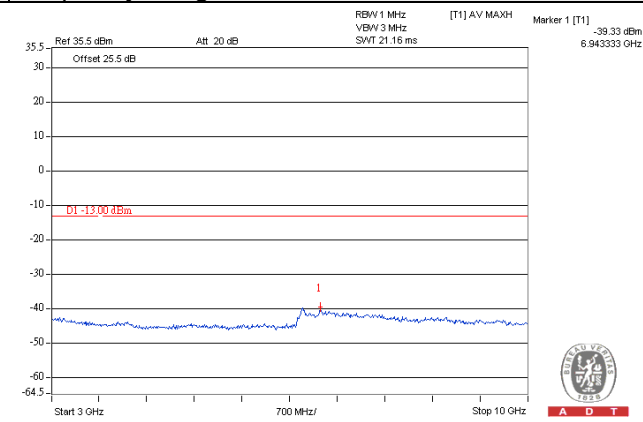

Frequency Range : 10GHz~20GHz

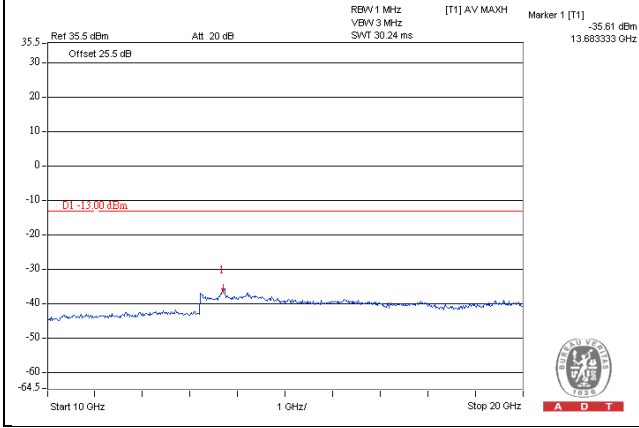

Channel Bandwidth: 10MHz
 Channel 20000 (1715.00MHz)
 Frequency Range : 9kHz~3GHz

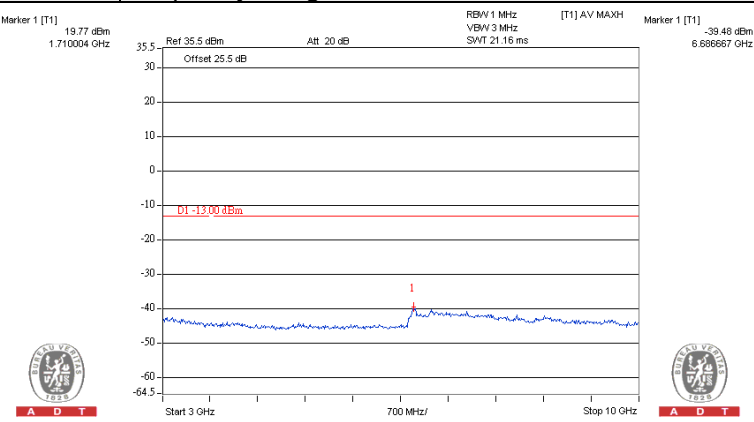
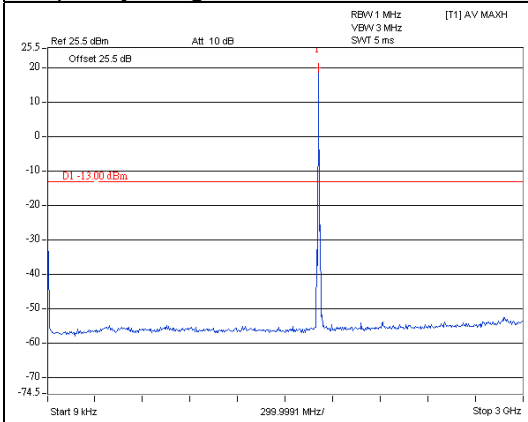

Frequency Range : 10GHz~20GHz

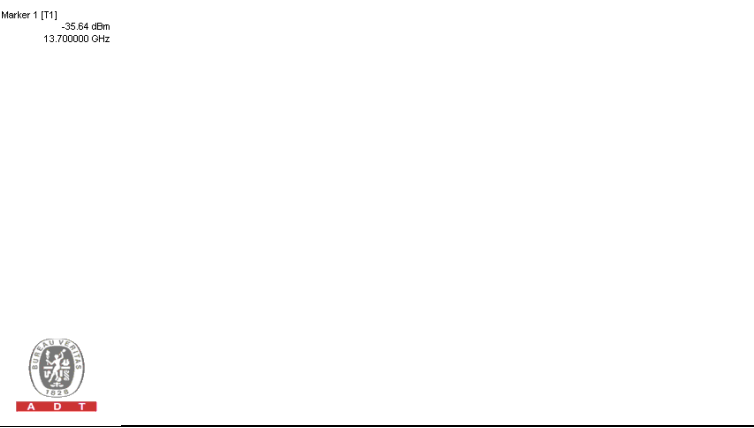
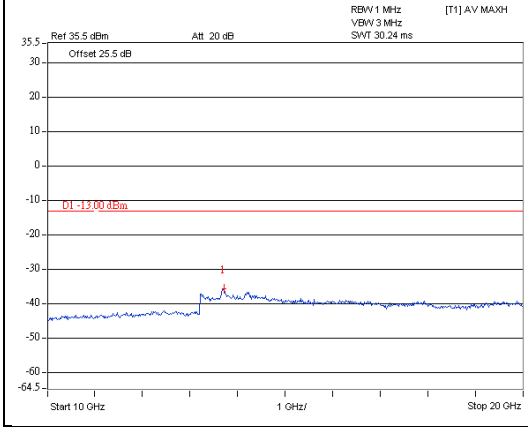

Channel Bandwidth: 10MHz

Channel 20175 (1732.50MHz)

Frequency Range : 9kHz~3GHz

Frequency Range : 3GHz~10GHz

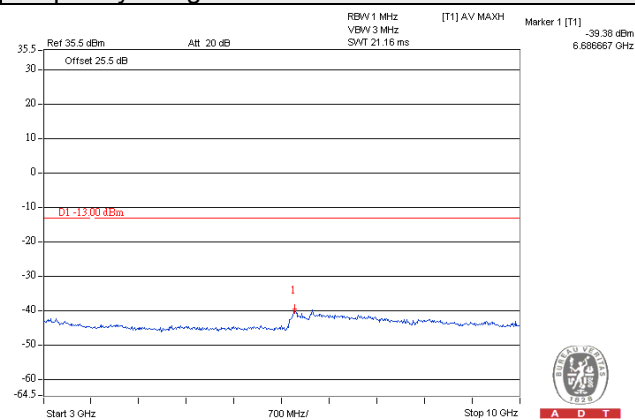
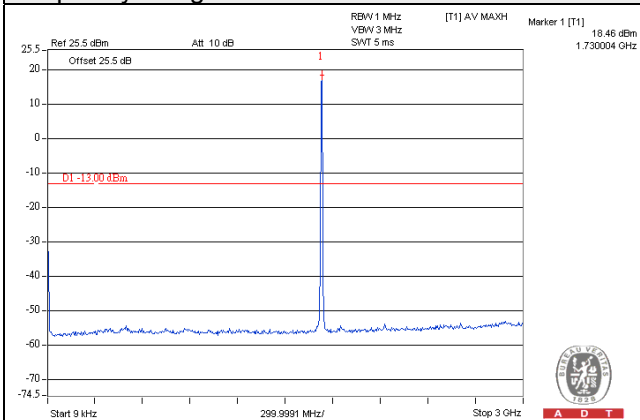

Frequency Range : 10GHz~20GHz

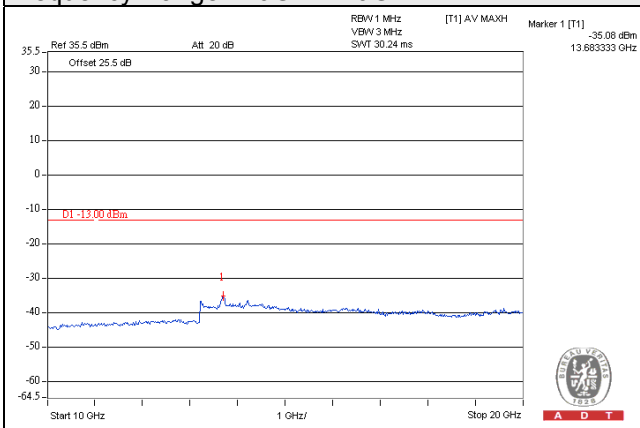

Channel Bandwidth: 10MHz

Channel 20350 (1750.00MHz)

Frequency Range : 9kHz~3GHz

Frequency Range : 3GHz~10GHz

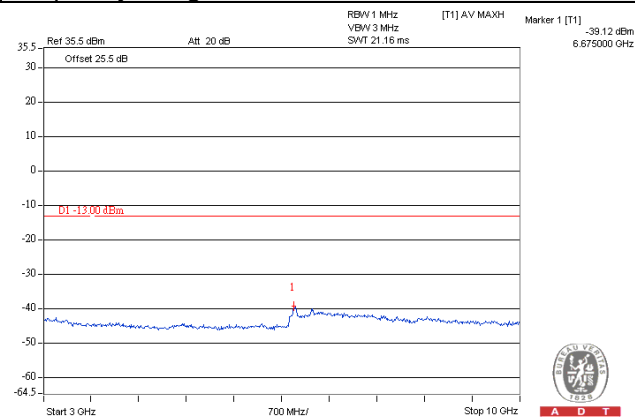
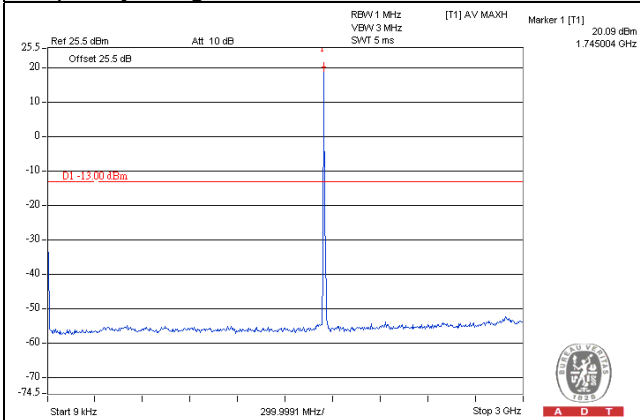

Frequency Range : 10GHz~20GHz

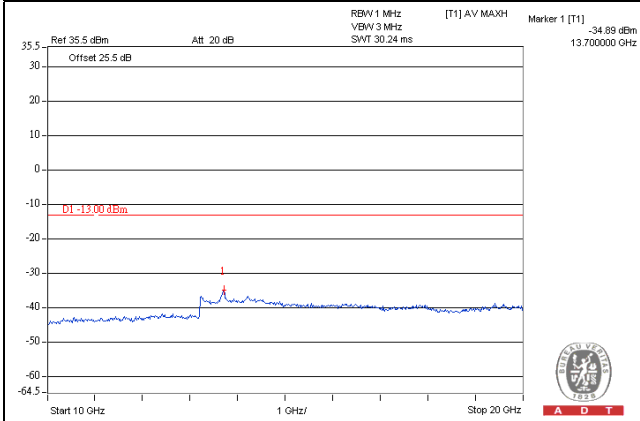

Channel Bandwidth: 15MHz
 Channel 20025 (1717.50MHz)
 Frequency Range : 9kHz~3GHz

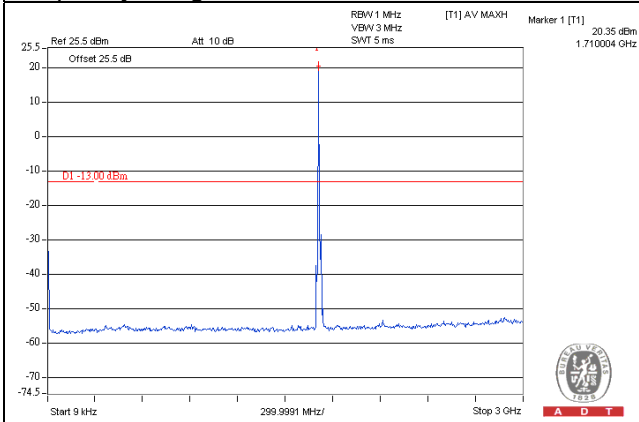

Frequency Range : 3GHz~10GHz

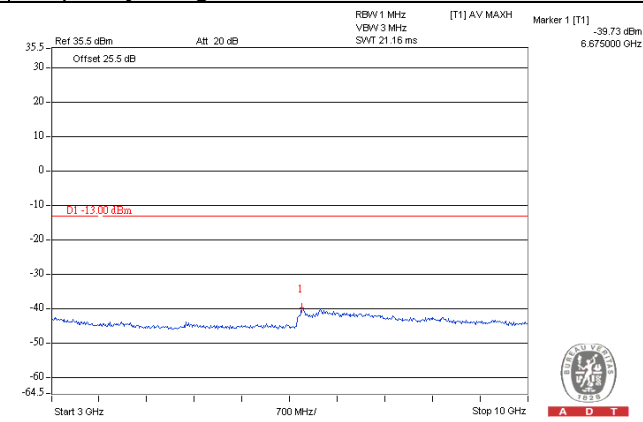

Frequency Range : 10GHz~20GHz

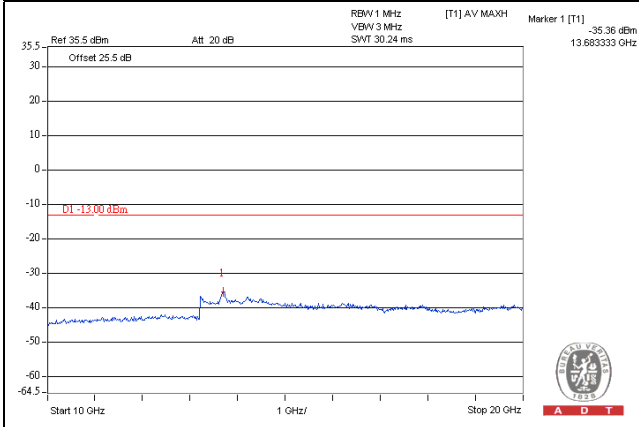

Channel Bandwidth: 15MHz
 Channel 20175 (1732.50MHz)
 Frequency Range : 9kHz~3GHz

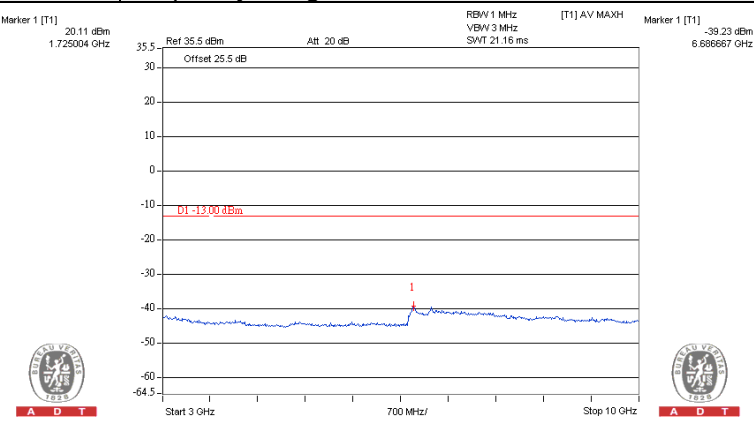
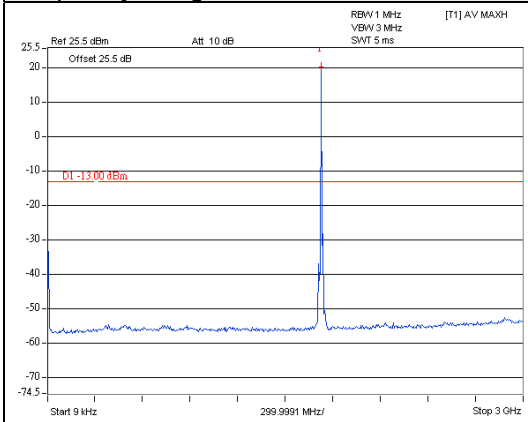

Frequency Range : 10GHz~20GHz

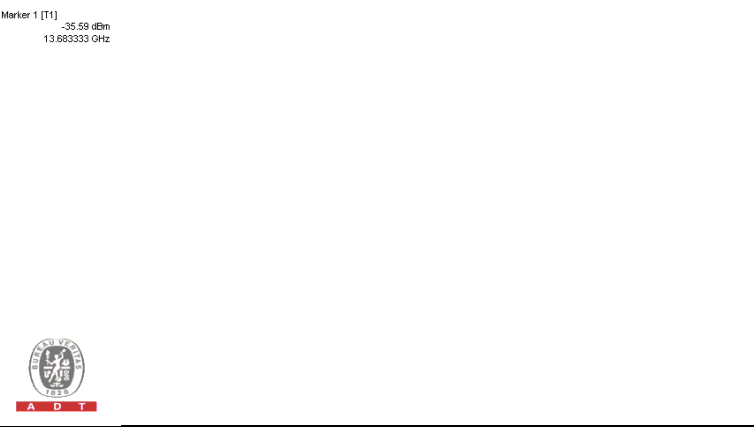
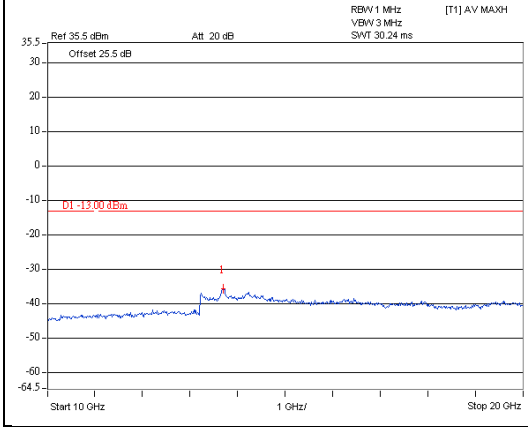

Channel Bandwidth: 15MHz

Channel 20325 (1747.50MHz)

Frequency Range : 9kHz~3GHz

Frequency Range : 3GHz~10GHz

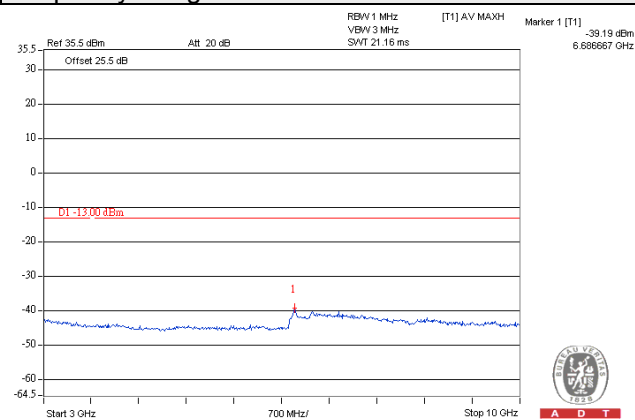
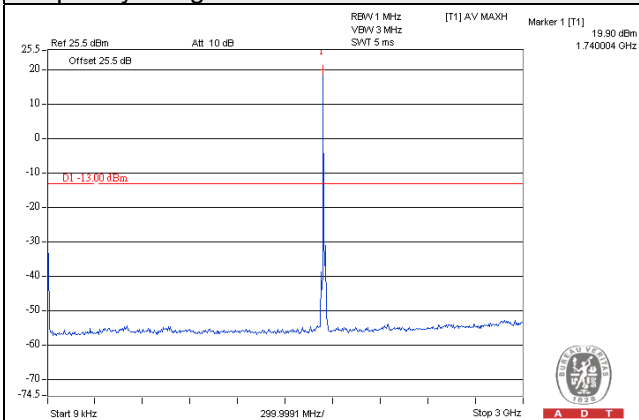

Frequency Range : 10GHz~20GHz

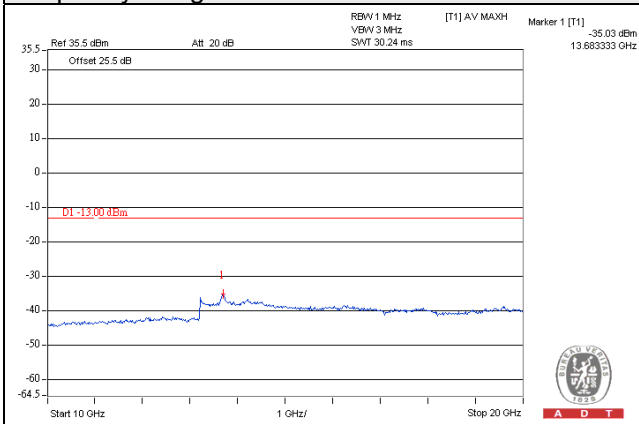

Channel Bandwidth: 20MHz
 Channel 20050 (1720.00MHz)
 Frequency Range : 9kHz~3GHz

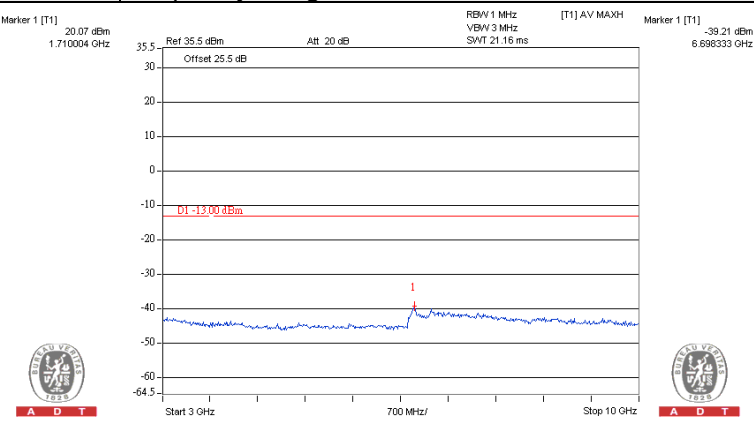
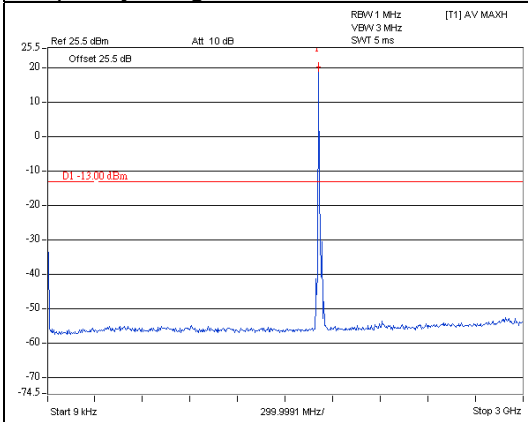

Frequency Range : 10GHz~20GHz

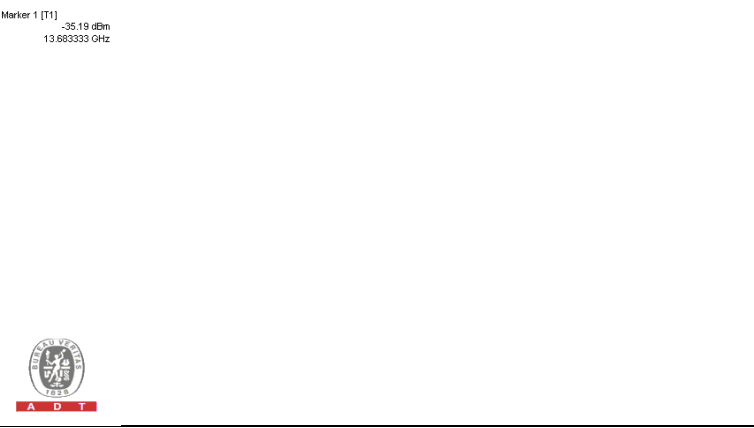
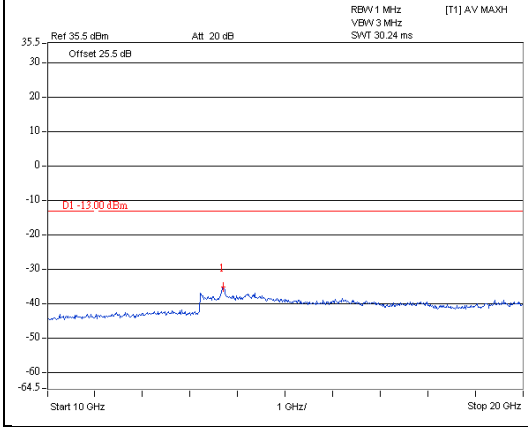

Channel Bandwidth: 20MHz

Channel 20175 (1732.50MHz)

Frequency Range : 9kHz~3GHz

Frequency Range : 3GHz~10GHz

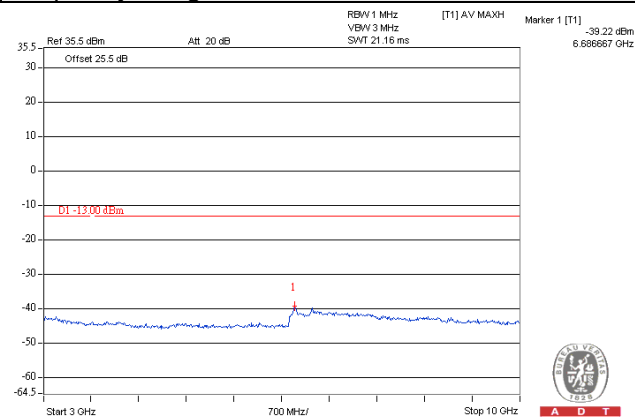
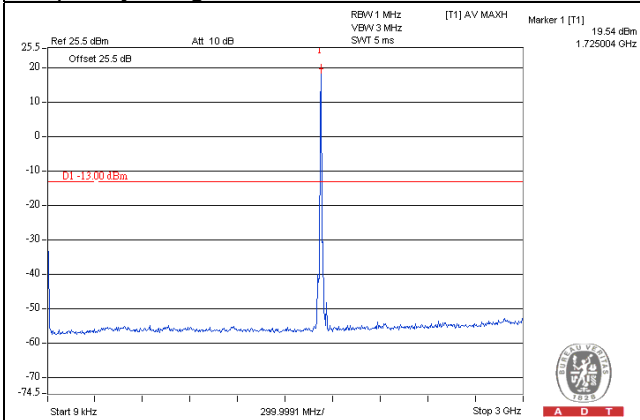

Frequency Range : 10GHz~20GHz

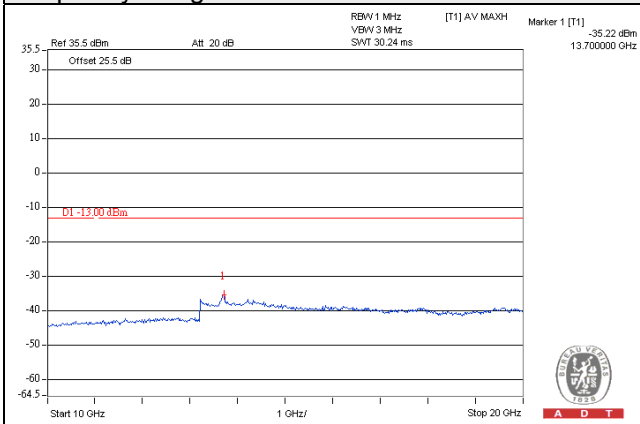

Channel Bandwidth: 20MHz

Channel 20300 (1745.00MHz)

Frequency Range : 9kHz~3GHz

Frequency Range : 3GHz~10GHz

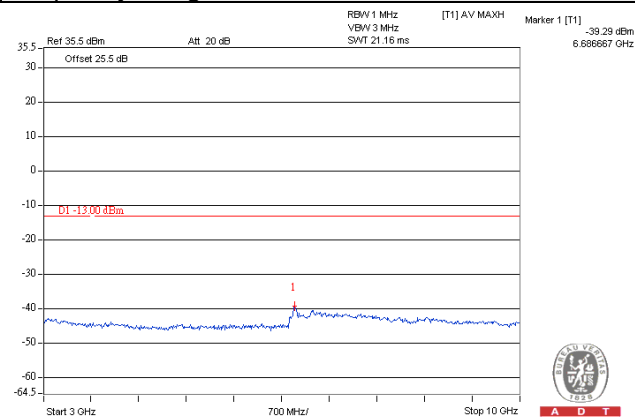
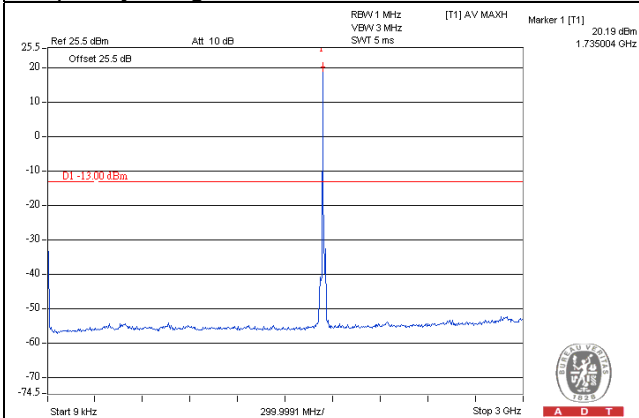

Frequency Range : 10GHz~20GHz

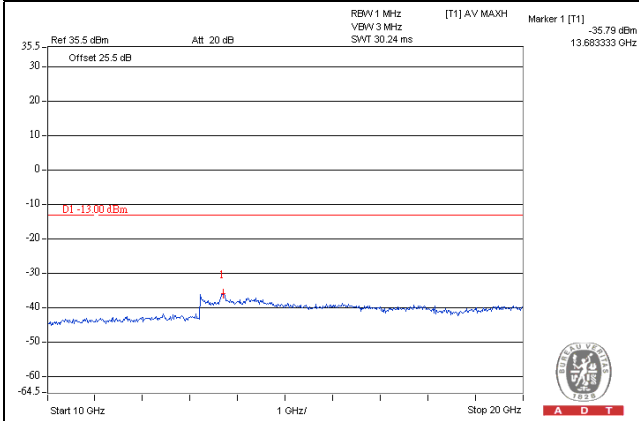

LTE Band 13

Channel Bandwidth: 5MHz

Channel 23205 (779.50MHz)

Frequency Range : 9kHz~1GHz

Frequency Range : 1GHz~4GHz

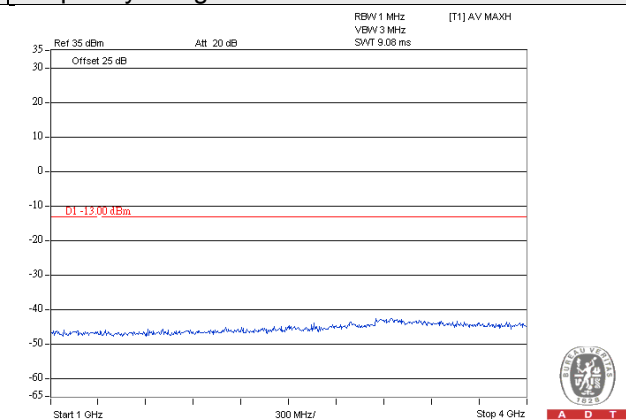
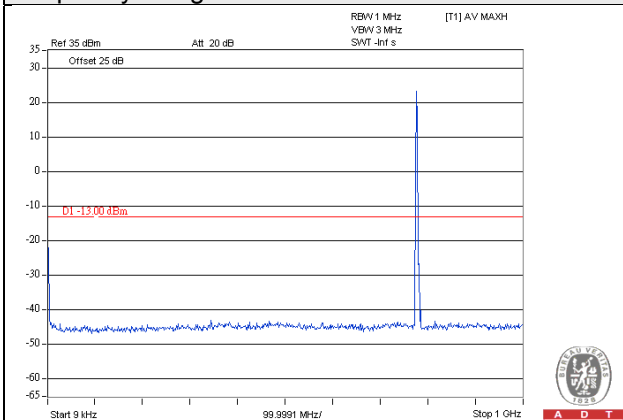

Frequency Range : 4GHz~7GHz

Frequency Range : 7GHz~9GHz

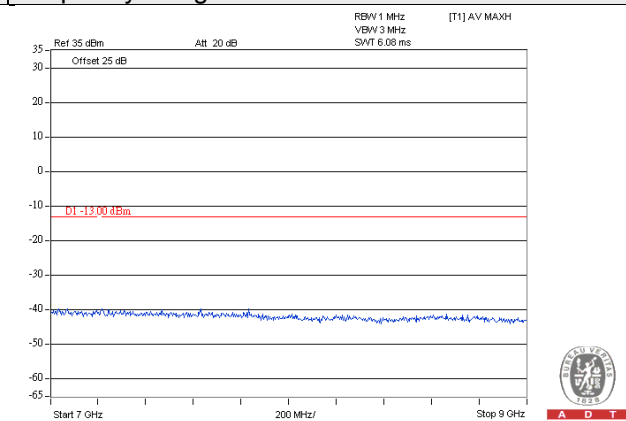
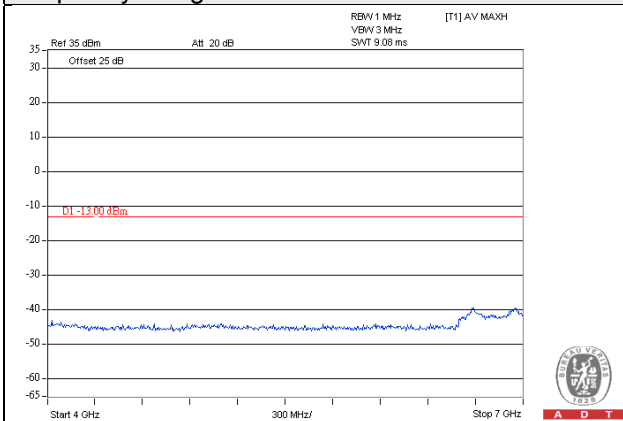

Channel Bandwidth: 5MHz
 Channel 23230 (782.00MHz)

Frequency Range : 9kHz~1GHz

Frequency Range : 1GHz~4GHz

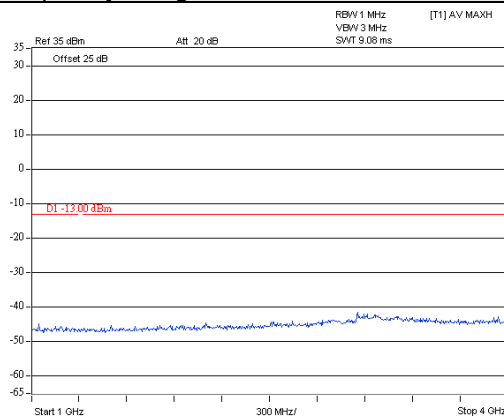
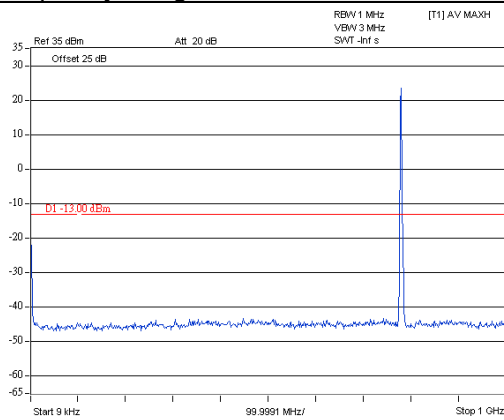

Frequency Range : 4GHz~7GHz

Frequency Range : 7GHz~9GHz

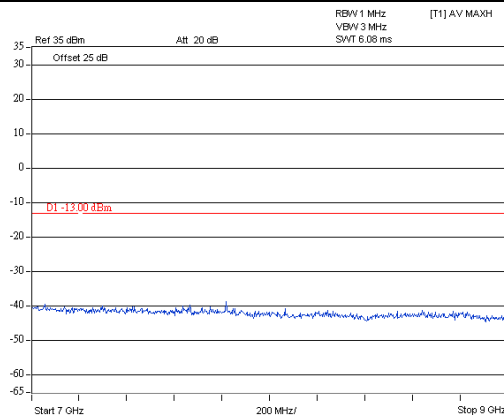
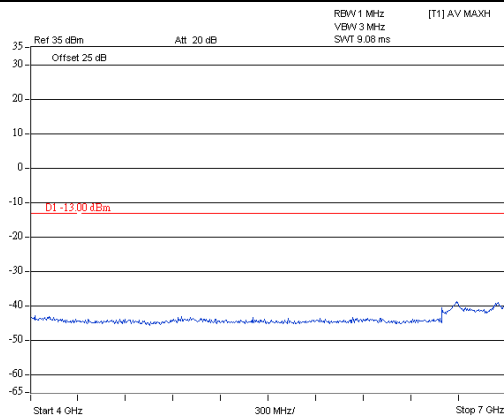

Channel Bandwidth: 5MHz
 Channel 23255 (784.50MHz)

Frequency Range : 9kHz~1GHz

Frequency Range : 1GHz~4GHz

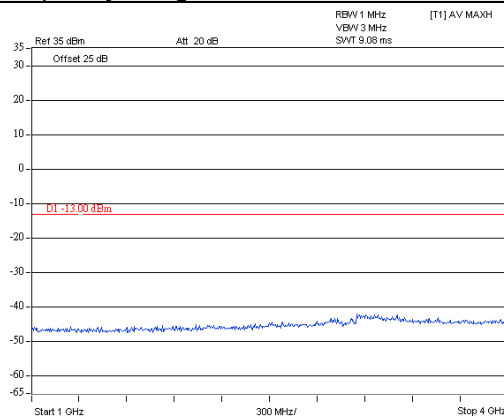
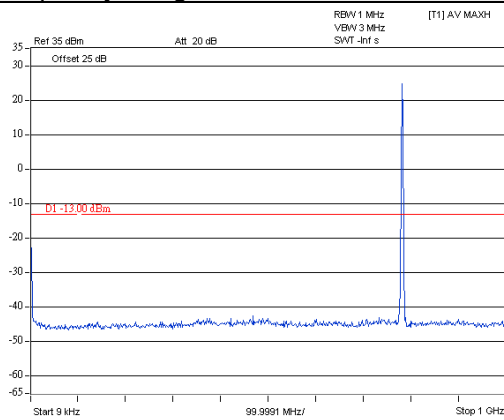

Frequency Range : 4GHz~7GHz

Frequency Range : 7GHz~9GHz

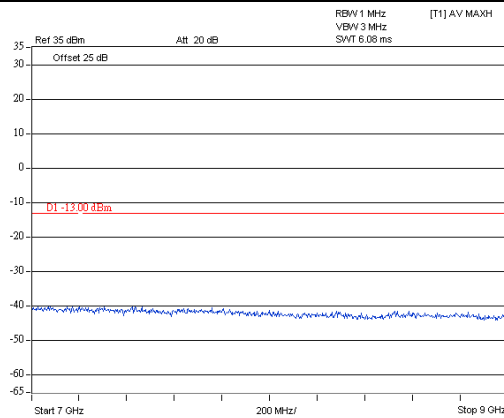
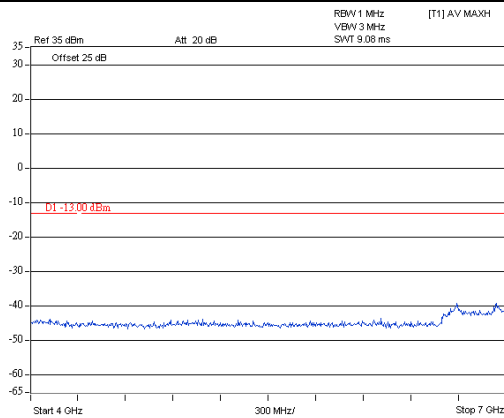

Channel Bandwidth: 10MHz

Channel 23230 (782.00MHz)

Frequency Range : 9kHz~1GHz

Frequency Range : 1GHz~4GHz

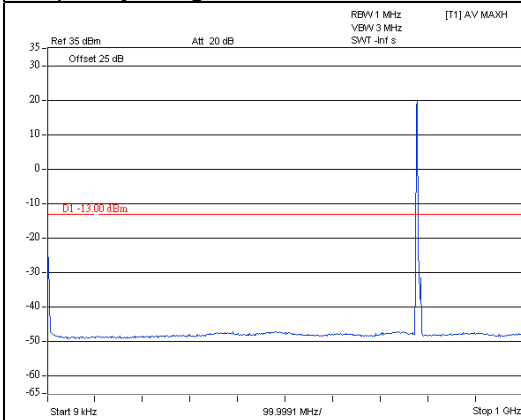

A D T

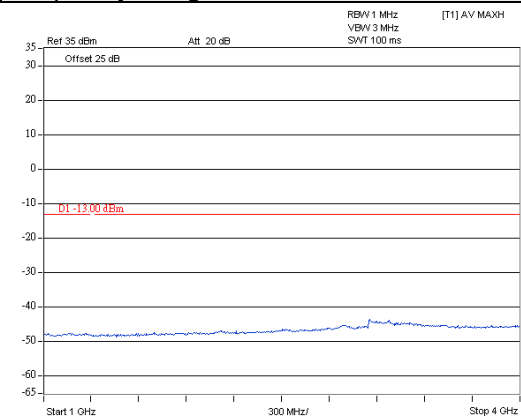

A D T

Frequency Range : 4GHz~7GHz

Frequency Range : 7GHz~9GHz

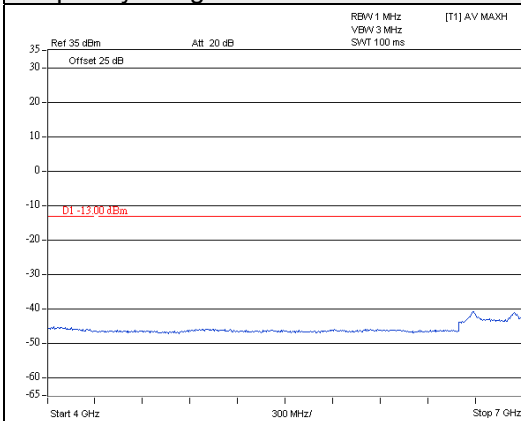

A D T

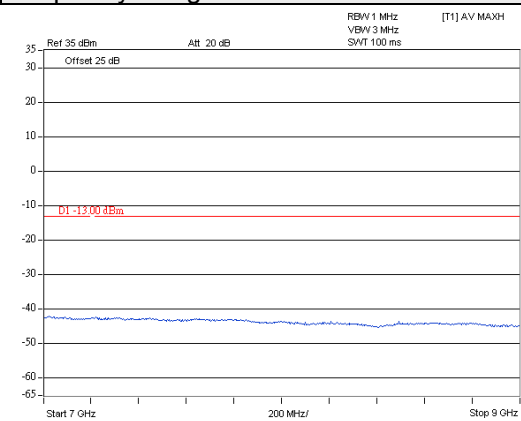

A D T

4.7 Radiated Emission Measurement

4.7.1 Limits of Radiated Emission Measurement

For LTE Band 4

According to FCC 27.53(h) for operations in the 1695-1710 MHz, 1710-1755 MHz, 1755-1780 MHz, 1915-1920 MHz, 1995-2000 MHz, 2000-2020 MHz, 2110-2155 MHz, 2155-2180 MHz, and 2180-2200 bands, the power of any emission outside a licensee's frequency block shall be attenuated below the transmitter power (P) in watts by at least $43 + 10 \log_{10}(P)$ dB.

For LTE Band 13

According to FCC 27.53(c) (2) for on any frequency outside the 776-788 MHz band, the power of any emission shall be attenuated outside the band below the transmitter power (P) by at least $43 + 10 \log(P)$ dB.

4.7.2 Test Procedure

- a. The power was measured with R&S Spectrum Analyzer. All measurements were done at 3 channels (low, middle and high channel of operational frequency range.)
- b. Substitution method is used for E.I.R.P measurement. In the semi-anechoic chamber, EUT placed on the 0.8m height of Turn Table, rotated the table around 360 degrees to search the maximum radiation power and receiver antenna shall be rotated vertical and horizontal polarization and moved height from 1m to 4m to find the maximum polar radiated power. The "Read Value" is the spectrum reading the maximum power value.
- c. The substitution antenna is substituted for EUT at the same position and signals generator export the CW signal to the substitution antenna via a TX cable. Rotated the Turn Table and moved receiving antenna to find the maximum radiation power. Adjust output power level of S.G to get a Value of spectrum reading equal to "Read Value" of step b. Record the power level of S.G
- d. $EIRP = \text{Output power level of S.G} - \text{TX cable loss} + \text{Antenna gain of substitution antenna}$.

Note: The resolution bandwidth and video bandwidth of test receiver/spectrum analyzer is 1MHz/3MHz.

4.7.3 Deviation from Test Standard

No deviation.

4.7.4 Test Setup

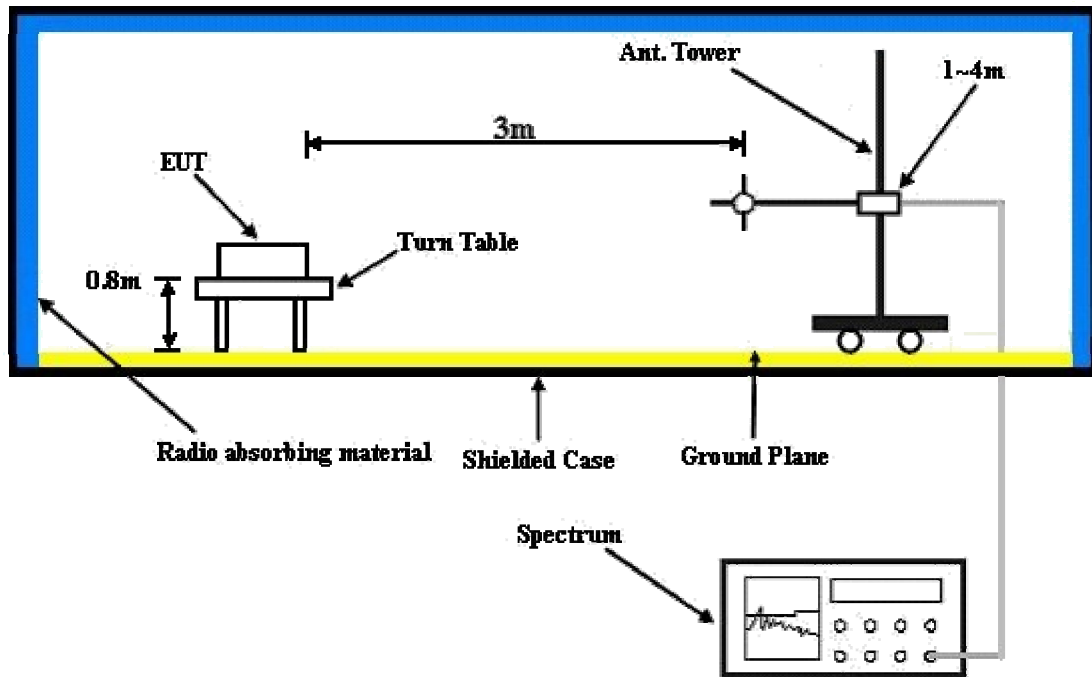

For the actual test configuration, please refer to the attached file (Test Setup Photo).

4.7.5 Test Results

Below 1GHz

LTE Band 4

Channel Bandwidth: 1.4MHz

Mode	TX channel 19957 (1710.70MHz)	Frequency Range	Below 1000 MHz
Environmental Conditions	20deg. C, 69%RH	Input Power	120Vac, 60Hz
Tested By	Tank Wu		

Antenna Polarity & Test Distance: Horizontal at 3 M							
No.	Freq. (MHz)	Reading (dBm)	S.G Power Value (dBm)	Correction Factor (dB)	EIRP (dBm)	Limit (dBm)	Margin (dB)
1	30.00	-50.8	-27.4	-19.4	-46.8	-13.0	-33.8
2	59.10	-47.8	-48.5	-3.8	-52.3	-13.0	-39.3
3	78.50	-49.3	-55.0	0.6	-54.4	-13.0	-41.4
4	152.22	-49.0	-50.4	-2.8	-53.2	-13.0	-40.2
5	189.08	-48.7	-54.3	-2.8	-57.1	-13.0	-44.1
6	365.62	-60.0	-66.2	3.8	-62.4	-13.0	-49.4
Antenna Polarity & Test Distance: Vertical at 3 M							
No.	Freq. (MHz)	Reading (dBm)	S.G Power Value (dBm)	Correction Factor (dB)	EIRP (dBm)	Limit (dBm)	Margin (dB)
1	31.94	-46.7	-38.9	-18.3	-57.2	-13.0	-44.2
2	59.10	-39.6	-42.6	-3.8	-46.4	-13.0	-33.4
3	84.32	-41.3	-46.7	0.4	-46.3	-13.0	-33.3
4	148.34	-49.0	-48.1	-3.0	-51.1	-13.0	-38.1
5	206.54	-54.4	-54.9	-2.0	-56.9	-13.0	-43.9
6	359.80	-55.7	-60.1	4.0	-56.1	-13.0	-43.1

Remarks:

1. Output Power (dBm) = S.G Value (dBm) + Correction Factor (dB).
2. Correction Factor (dB) = Substitution Antenna Gain (dB) + Cable Loss (dB).

Channel Bandwidth: 3MHz

Mode	TX channel 19965 (1711.50MHz)	Frequency Range	Below 1000 MHz
Environmental Conditions	20deg. C, 69%RH	Input Power	120Vac, 60Hz
Tested By	Tank Wu		

Antenna Polarity & Test Distance: Horizontal at 3 M							
No.	Freq. (MHz)	Reading (dBm)	S.G Power Value (dBm)	Correction Factor (dB)	EIRP (dBm)	Limit (dBm)	Margin (dB)
1	39.70	-52.9	-36.9	-13.7	-50.6	-13.0	-37.6
2	57.16	-48.7	-47.6	-4.7	-52.3	-13.0	-39.3
3	78.50	-49.5	-55.2	0.6	-54.6	-13.0	-41.6
4	152.22	-51.1	-52.5	-2.8	-55.3	-13.0	-42.3
5	179.38	-50.8	-55.8	-2.9	-58.7	-13.0	-45.7
6	363.68	-61.4	-67.8	3.9	-63.9	-13.0	-50.9
Antenna Polarity & Test Distance: Vertical at 3 M							
No.	Freq. (MHz)	Reading (dBm)	S.G Power Value (dBm)	Correction Factor (dB)	EIRP (dBm)	Limit (dBm)	Margin (dB)
1	31.94	-33.7	-25.9	-18.3	-44.2	-13.0	-31.2
2	59.10	-40.0	-43.0	-3.8	-46.8	-13.0	-33.8
3	88.20	-38.8	-45.0	-0.2	-45.2	-13.0	-32.2
4	148.34	-51.2	-50.3	-3.0	-53.3	-13.0	-40.3
5	189.08	-53.1	-52.5	-2.8	-55.3	-13.0	-42.3
6	355.92	-58.3	-62.7	4.0	-58.7	-13.0	-45.7

Remarks:

1. Output Power (dBm) = S.G Value (dBm) + Correction Factor (dB).
2. Correction Factor (dB) = Substitution Antenna Gain (dB) + Cable Loss (dB).

Channel Bandwidth: 5MHz

Mode	TX channel 19975 (1712.50MHz)	Frequency Range	Below 1000 MHz
Environmental Conditions	20deg. C, 69%RH	Input Power	120Vac, 60Hz
Tested By	Tank Wu		

Antenna Polarity & Test Distance: Horizontal at 3 M							
No.	Freq. (MHz)	Reading (dBm)	S.G Power Value (dBm)	Correction Factor (dB)	EIRP (dBm)	Limit (dBm)	Margin (dB)
1	30.00	-43.6	-20.2	-19.4	-39.6	-13.0	-26.6
2	59.10	-50.7	-51.4	-3.8	-55.2	-13.0	-42.2
3	80.44	-50.3	-55.7	0.5	-55.2	-13.0	-42.2
4	152.22	-50.1	-51.5	-2.8	-54.3	-13.0	-41.3
5	185.20	-49.5	-55.0	-2.8	-57.8	-13.0	-44.8
6	344.28	-60.6	-68.0	4.0	-64.0	-13.0	-51.0
Antenna Polarity & Test Distance: Vertical at 3 M							
No.	Freq. (MHz)	Reading (dBm)	S.G Power Value (dBm)	Correction Factor (dB)	EIRP (dBm)	Limit (dBm)	Margin (dB)
1	31.94	-43.8	-36.0	-18.3	-54.3	-13.0	-41.3
2	59.10	-39.1	-42.1	-3.8	-45.9	-13.0	-32.9
3	74.62	-37.3	-43.0	0.1	-42.9	-13.0	-29.9
4	150.28	-50.5	-49.6	-3.0	-52.6	-13.0	-39.6
5	204.60	-55.0	-54.9	-2.0	-56.9	-13.0	-43.9
6	355.92	-58.0	-62.4	4.0	-58.4	-13.0	-45.4

Remarks:

1. Output Power (dBm) = S.G Value (dBm) + Correction Factor (dB).
2. Correction Factor (dB) = Substitution Antenna Gain (dB) + Cable Loss (dB).

Channel Bandwidth: 10MHz

Mode	TX channel 20000 (1715.00MHz)	Frequency Range	Below 1000 MHz
Environmental Conditions	20deg. C, 69%RH	Input Power	120Vac, 60Hz
Tested By	Tank Wu		

Antenna Polarity & Test Distance: Horizontal at 3 M							
No.	Freq. (MHz)	Reading (dBm)	S.G Power Value (dBm)	Correction Factor (dB)	EIRP (dBm)	Limit (dBm)	Margin (dB)
1	30.00	-49.4	-26.0	-19.4	-45.4	-13.0	-32.4
2	39.70	-53.9	-37.9	-13.7	-51.6	-13.0	-38.6
3	78.50	-53.1	-58.8	0.6	-58.2	-13.0	-45.2
4	152.22	-52.5	-53.9	-2.8	-56.7	-13.0	-43.7
5	185.20	-50.4	-55.9	-2.8	-58.7	-13.0	-45.7
6	363.68	-61.4	-67.8	3.9	-63.9	-13.0	-50.9
Antenna Polarity & Test Distance: Vertical at 3 M							
No.	Freq. (MHz)	Reading (dBm)	S.G Power Value (dBm)	Correction Factor (dB)	EIRP (dBm)	Limit (dBm)	Margin (dB)
1	30.00	-41.3	-31.8	-19.4	-51.2	-13.0	-38.2
2	59.10	-40.5	-43.5	-3.8	-47.3	-13.0	-34.3
3	88.20	-39.5	-45.7	-0.2	-45.9	-13.0	-32.9
4	152.22	-52.9	-52.0	-2.8	-54.8	-13.0	-41.8
5	204.60	-55.2	-55.1	-2.0	-57.1	-13.0	-44.1
6	458.74	-58.2	-61.8	3.5	-58.3	-13.0	-45.3

Remarks:

1. Output Power (dBm) = S.G Value (dBm) + Correction Factor (dB).
2. Correction Factor (dB) = Substitution Antenna Gain (dB) + Cable Loss (dB).

Channel Bandwidth: 15MHz

Mode	TX channel 20025 (1717.50MHz)	Frequency Range	Below 1000 MHz
Environmental Conditions	20deg. C, 69%RH	Input Power	120Vac, 60Hz
Tested By	Tank Wu		

Antenna Polarity & Test Distance: Horizontal at 3 M							
No.	Freq. (MHz)	Reading (dBm)	S.G Power Value (dBm)	Correction Factor (dB)	EIRP (dBm)	Limit (dBm)	Margin (dB)
1	33.88	-54.0	-34.0	-17.1	-51.1	-13.0	-38.1
2	57.16	-50.1	-49.0	-4.7	-53.7	-13.0	-40.7
3	80.44	-51.7	-57.1	0.5	-56.6	-13.0	-43.6
4	152.22	-51.3	-52.7	-2.8	-55.5	-13.0	-42.5
5	183.26	-50.8	-56.2	-3.0	-59.2	-13.0	-46.2
6	338.46	-61.6	-69.2	4.1	-65.1	-13.0	-52.1
Antenna Polarity & Test Distance: Vertical at 3 M							
No.	Freq. (MHz)	Reading (dBm)	S.G Power Value (dBm)	Correction Factor (dB)	EIRP (dBm)	Limit (dBm)	Margin (dB)
1	33.88	-45.2	-38.7	-17.1	-55.8	-13.0	-42.8
2	59.10	-40.7	-43.7	-3.8	-47.5	-13.0	-34.5
3	86.26	-41.4	-47.4	0.1	-47.3	-13.0	-34.3
4	150.28	-53.0	-52.1	-3.0	-55.1	-13.0	-42.1
5	189.08	-54.2	-53.6	-2.8	-56.4	-13.0	-43.4
6	361.74	-58.6	-62.8	3.8	-59.0	-13.0	-46.0

Remarks:

1. Output Power (dBm) = S.G Value (dBm) + Correction Factor (dB).
2. Correction Factor (dB) = Substitution Antenna Gain (dB) + Cable Loss (dB).

Channel Bandwidth: 20MHz

Mode	TX channel 20050 (1720.00MHz)	Frequency Range	Below 1000 MHz
Environmental Conditions	20deg. C, 69%RH	Input Power	120Vac, 60Hz
Tested By	Tank Wu		

Antenna Polarity & Test Distance: Horizontal at 3 M							
No.	Freq. (MHz)	Reading (dBm)	S.G Power Value (dBm)	Correction Factor (dB)	EIRP (dBm)	Limit (dBm)	Margin (dB)
1	39.70	-53.4	-37.4	-13.7	-51.1	-13.0	-38.1
2	57.16	-52.2	-51.1	-4.7	-55.8	-13.0	-42.8
3	78.50	-51.6	-57.3	0.6	-56.7	-13.0	-43.7
4	154.16	-49.4	-50.8	-2.9	-53.7	-13.0	-40.7
5	177.44	-51.3	-56.2	-3.0	-59.2	-13.0	-46.2
6	361.74	-61.7	-68.1	3.8	-64.3	-13.0	-51.3
Antenna Polarity & Test Distance: Vertical at 3 M							
No.	Freq. (MHz)	Reading (dBm)	S.G Power Value (dBm)	Correction Factor (dB)	EIRP (dBm)	Limit (dBm)	Margin (dB)
1	30.00	-43.1	-33.6	-19.4	-53.0	-13.0	-40.0
2	59.10	-41.0	-44.0	-3.8	-47.8	-13.0	-34.8
3	86.26	-40.7	-46.7	0.1	-46.6	-13.0	-33.6
4	148.34	-53.0	-52.1	-3.0	-55.1	-13.0	-42.1
5	187.14	-55.7	-55.4	-2.7	-58.1	-13.0	-45.1
6	355.92	-58.0	-62.4	4.0	-58.4	-13.0	-45.4

Remarks:

1. Output Power (dBm) = S.G Value (dBm) + Correction Factor (dB).
2. Correction Factor (dB) = Substitution Antenna Gain (dB) + Cable Loss (dB).

LTE Band 13

Channel Bandwidth: 5MHz

Mode	TX channel 23205 (779.50MHz)	Frequency Range	Below 1000 MHz
Environmental Conditions	20deg. C, 69%RH	Input Power	120Vac, 60Hz
Tested By	Tank Wu		

Antenna Polarity & Test Distance: Horizontal at 3 M							
No.	Freq. (MHz)	Reading (dBm)	S.G Power Value (dBm)	Correction Factor (dB)	ERP (dBm)	Limit (dBm)	Margin (dB)
1	39.70	-63.9	-47.9	-13.7	-61.6	-13.0	-48.6
2	78.50	-50.5	-56.2	0.6	-55.6	-13.0	-42.6
3	111.48	-50.7	-55.9	-2.5	-58.4	-13.0	-45.4
4	140.58	-50.4	-53.0	-3.0	-56.0	-13.0	-43.0
5	187.14	-46.1	-51.6	-2.7	-54.3	-13.0	-41.3
6	340.40	-57.4	-64.9	4.0	-60.9	-13.0	-47.9
Antenna Polarity & Test Distance: Vertical at 3 M							
No.	Freq. (MHz)	Reading (dBm)	S.G Power Value (dBm)	Correction Factor (dB)	ERP (dBm)	Limit (dBm)	Margin (dB)
1	30.00	-27.2	-17.7	-19.4	-37.1	-13.0	-24.1
2	57.16	-34.7	-36.9	-4.7	-41.6	-13.0	-28.6
3	88.20	-32.7	-38.9	-0.2	-39.1	-13.0	-26.1
4	152.22	-50.0	-49.1	-2.8	-51.9	-13.0	-38.9
5	187.14	-51.4	-51.1	-2.7	-53.8	-13.0	-40.8
6	361.74	-57.7	-61.9	3.8	-58.1	-13.0	-45.1

Remarks:

1. Output Power (dBm) = S.G Value (dBm) + Correction Factor (dB).
2. Correction Factor (dB) = Substitution Antenna Gain (dB) + Cable Loss (dB).

Channel Bandwidth: 10MHz

Mode	TX channel 23230 (782.00MHz)	Frequency Range	Below 1000 MHz
Environmental Conditions	20deg. C, 69%RH	Input Power	120Vac, 60Hz
Tested By	Tank Wu		

Antenna Polarity & Test Distance: Horizontal at 3 M							
No.	Freq. (MHz)	Reading (dBm)	S.G Power Value (dBm)	Correction Factor (dB)	ERP (dBm)	Limit (dBm)	Margin (dB)
1	33.88	-54.6	-34.6	-17.1	-51.7	-13.0	-38.7
2	57.16	-46.1	-45.0	-4.7	-49.7	-13.0	-36.7
3	76.56	-43.1	-49.0	0.3	-48.7	-13.0	-35.7
4	152.22	-45.2	-46.6	-2.8	-49.4	-13.0	-36.4
5	187.14	-42.0	-47.5	-2.7	-50.2	-13.0	-37.2
6	361.74	-57.2	-63.6	3.8	-59.8	-13.0	-46.8
Antenna Polarity & Test Distance: Vertical at 3 M							
No.	Freq. (MHz)	Reading (dBm)	S.G Power Value (dBm)	Correction Factor (dB)	ERP (dBm)	Limit (dBm)	Margin (dB)
1	33.88	-28.4	-21.9	-17.1	-39.0	-13.0	-26.0
2	59.10	-31.5	-34.5	-3.8	-38.3	-13.0	-25.3
3	84.32	-34.7	-40.1	0.4	-39.7	-13.0	-26.7
4	148.34	-46.4	-45.5	-3.0	-48.5	-13.0	-35.5
5	185.20	-49.8	-49.9	-2.8	-52.7	-13.0	-39.7
6	357.86	-56.0	-60.4	4.0	-56.4	-13.0	-43.4

Remarks:

1. Output Power (dBm) = S.G Value (dBm) + Correction Factor (dB).
2. Correction Factor (dB) = Substitution Antenna Gain (dB) + Cable Loss (dB).

Above 1GHz

Channel Bandwidth: 1.4MHz

Mode	TX channel 19957 (1710.70MHz),	Frequency Range	Above 1000MHz
Environmental Conditions	20deg. C, 69%RH	Input Power	120Vac, 60Hz
Tested By	Bond Tseng		

Antenna Polarity & Test Distance: Horizontal at 3 M							
No.	Freq. (MHz)	Reading (dBm)	S.G Power Value (dBm)	Correction Factor (dB)	EIRP (dBm)	Limit (dBm)	Margin (dB)
1	3421.40	-61.0	-52.4	1.3	-51.1	-13.0	-38.1
2	5132.10	-62.6	-50.4	1.4	-49.0	-13.0	-36.0
Antenna Polarity & Test Distance: Vertical at 3 M							
No.	Freq. (MHz)	Reading (dBm)	S.G Power Value (dBm)	Correction Factor (dB)	EIRP (dBm)	Limit (dBm)	Margin (dB)
1	3421.40	-60.7	-52.6	1.3	-51.3	-13.0	-38.3
2	5132.10	-62.4	-50.6	1.4	-49.2	-13.0	-36.2

Remarks:

1. Output Power (dBm) = S.G Value (dBm) + Correction Factor (dB).
2. Correction Factor (dB) = Substitution Antenna Gain (dB) + Cable Loss (dB).

Mode	TX channel 20175 (1732.50MHz)	Frequency Range	Above 1000MHz
Environmental Conditions	20deg. C, 69%RH	Input Power	120Vac, 60Hz
Tested By	Bond Tseng		

Antenna Polarity & Test Distance: Horizontal at 3 M							
No.	Freq. (MHz)	Reading (dBm)	S.G Power Value (dBm)	Correction Factor (dB)	EIRP (dBm)	Limit (dBm)	Margin (dB)
1	3465.00	-61.2	-52.8	1.4	-51.4	-13.0	-38.4
2	5197.50	-61.6	-50.0	1.4	-48.6	-13.0	-35.6
Antenna Polarity & Test Distance: Vertical at 3 M							
No.	Freq. (MHz)	Reading (dBm)	S.G Power Value (dBm)	Correction Factor (dB)	EIRP (dBm)	Limit (dBm)	Margin (dB)
1	3465.00	-60.9	-53.1	1.4	-51.7	-13.0	-38.7
2	5197.50	-62.4	-50.2	1.4	-48.8	-13.0	-35.8

Remarks:

1. Output Power (dBm) = S.G Value (dBm) + Correction Factor (dB).
2. Correction Factor (dB) = Substitution Antenna Gain (dB) + Cable Loss (dB).

Mode	TX channel 20393 (1754.30MHz)	Frequency Range	Above 1000MHz
Environmental Conditions	20deg. C, 69%RH	Input Power	120Vac, 60Hz
Tested By	Bond Tseng		

Antenna Polarity & Test Distance: Horizontal at 3 M							
No.	Freq. (MHz)	Reading (dBm)	S.G Power Value (dBm)	Correction Factor (dB)	EIRP (dBm)	Limit (dBm)	Margin (dB)
1	3508.60	-61.7	-53.4	1.4	-52.0	-13.0	-39.0
2	5262.90	-62.6	-50.8	1.5	-49.3	-13.0	-36.3
Antenna Polarity & Test Distance: Vertical at 3 M							
No.	Freq. (MHz)	Reading (dBm)	S.G Power Value (dBm)	Correction Factor (dB)	EIRP (dBm)	Limit (dBm)	Margin (dB)
1	3508.60	-61.3	-53.6	1.4	-52.2	-13.0	-39.2
2	5262.90	-62.5	-50.9	1.5	-49.4	-13.0	-36.4

Remarks:

1. Output Power (dBm) = S.G Value (dBm) + Correction Factor (dB).
2. Correction Factor (dB) = Substitution Antenna Gain (dB) + Cable Loss (dB).

Channel Bandwidth: 3MHz

Mode	TX channel 19965 (1711.50MHz)	Frequency Range	Above 1000MHz
Environmental Conditions	20deg. C, 69%RH	Input Power	120Vac, 60Hz
Tested By	Bond Tseng		

Antenna Polarity & Test Distance: Horizontal at 3 M							
No.	Freq. (MHz)	Reading (dBm)	S.G Power Value (dBm)	Correction Factor (dB)	EIRP (dBm)	Limit (dBm)	Margin (dB)
1	3423.00	-61.8	-53.2	1.3	-51.9	-13.0	-38.9
2	5134.50	-62.3	-50.1	1.4	-48.7	-13.0	-35.7
Antenna Polarity & Test Distance: Vertical at 3 M							
No.	Freq. (MHz)	Reading (dBm)	S.G Power Value (dBm)	Correction Factor (dB)	EIRP (dBm)	Limit (dBm)	Margin (dB)
1	3423.00	-61.5	-53.4	1.3	-52.1	-13.0	-39.1
2	5134.50	-62.5	-50.7	1.4	-49.3	-13.0	-36.3

Remarks:

1. Output Power (dBm) = S.G Value (dBm) + Correction Factor (dB).
2. Correction Factor (dB) = Substitution Antenna Gain (dB) + Cable Loss (dB).

Mode	TX channel 20175 (1732.50MHz)	Frequency Range	Above 1000MHz
Environmental Conditions	20deg. C, 69%RH	Input Power	120Vac, 60Hz
Tested By	Bond Tseng		

Antenna Polarity & Test Distance: Horizontal at 3 M							
No.	Freq. (MHz)	Reading (dBm)	S.G Power Value (dBm)	Correction Factor (dB)	EIRP (dBm)	Limit (dBm)	Margin (dB)
1	3465.00	-62.3	-53.9	1.4	-52.5	-13.0	-39.5
2	5197.50	-62.4	-50.8	1.4	-49.4	-13.0	-36.4
Antenna Polarity & Test Distance: Vertical at 3 M							
No.	Freq. (MHz)	Reading (dBm)	S.G Power Value (dBm)	Correction Factor (dB)	EIRP (dBm)	Limit (dBm)	Margin (dB)
1	3465.00	-61.8	-54.0	1.4	-52.6	-13.0	-39.6
2	5197.50	-63.1	-50.9	1.4	-49.5	-13.0	-36.5

Remarks:

1. Output Power (dBm) = S.G Value (dBm) + Correction Factor (dB).
2. Correction Factor (dB) = Substitution Antenna Gain (dB) + Cable Loss (dB).

Mode	TX channel 20385 (1753.50MHz)	Frequency Range	Above 1000MHz
Environmental Conditions	20deg. C, 69%RH	Input Power	120Vac, 60Hz
Tested By	Bond Tseng		

Antenna Polarity & Test Distance: Horizontal at 3 M							
No.	Freq. (MHz)	Reading (dBm)	S.G Power Value (dBm)	Correction Factor (dB)	EIRP (dBm)	Limit (dBm)	Margin (dB)
1	3507.00	-62.1	-53.8	1.4	-52.4	-13.0	-39.4
2	5260.50	-62.3	-50.5	1.5	-49.0	-13.0	-36.0
Antenna Polarity & Test Distance: Vertical at 3 M							
No.	Freq. (MHz)	Reading (dBm)	S.G Power Value (dBm)	Correction Factor (dB)	EIRP (dBm)	Limit (dBm)	Margin (dB)
1	3507.00	-61.6	-53.9	1.4	-52.5	-13.0	-39.5
2	5260.50	-62.3	-50.7	1.5	-49.2	-13.0	-36.2

Remarks:

1. Output Power (dBm) = S.G Value (dBm) + Correction Factor (dB).
2. Correction Factor (dB) = Substitution Antenna Gain (dB) + Cable Loss (dB).

Channel Bandwidth: 5MHz

Mode	TX channel 19975 (1712.50MHz)	Frequency Range	Above 1000MHz
Environmental Conditions	25deg. C, 69%RH	Input Power	120Vac, 60Hz
Tested By	Tank Wu		

Antenna Polarity & Test Distance: Horizontal at 3 M							
No.	Freq. (MHz)	Reading (dBm)	S.G Power Value (dBm)	Correction Factor (dB)	EIRP (dBm)	Limit (dBm)	Margin (dB)
1	3425.00	-60.5	-51.9	1.3	-50.6	-13.0	-37.6
2	5137.50	-62.1	-49.9	1.4	-48.5	-13.0	-35.5
Antenna Polarity & Test Distance: Vertical at 3 M							
No.	Freq. (MHz)	Reading (dBm)	S.G Power Value (dBm)	Correction Factor (dB)	EIRP (dBm)	Limit (dBm)	Margin (dB)
1	3425.00	-60.0	-51.9	1.3	-50.6	-13.0	-37.6
2	5137.50	-61.8	-49.9	1.4	-48.5	-13.0	-35.5

Remarks:

1. Output Power (dBm) = S.G Value (dBm) + Correction Factor (dB).
2. Correction Factor (dB) = Substitution Antenna Gain (dB) + Cable Loss (dB).

Mode	TX channel 20175 (1732.50MHz)	Frequency Range	Above 1000MHz
Environmental Conditions	25deg. C, 69%RH	Input Power	120Vac, 60Hz
Tested By	Tank Wu		

Antenna Polarity & Test Distance: Horizontal at 3 M							
No.	Freq. (MHz)	Reading (dBm)	S.G Power Value (dBm)	Correction Factor (dB)	EIRP (dBm)	Limit (dBm)	Margin (dB)
1	3465.00	-60.8	-52.4	1.4	-51.0	-13.0	-38.0
2	5197.50	-61.2	-49.6	1.4	-48.2	-13.0	-35.2
Antenna Polarity & Test Distance: Vertical at 3 M							
No.	Freq. (MHz)	Reading (dBm)	S.G Power Value (dBm)	Correction Factor (dB)	EIRP (dBm)	Limit (dBm)	Margin (dB)
1	3465.00	-60.5	-52.7	1.4	-51.3	-13.0	-38.3
2	5197.50	-61.9	-49.7	1.4	-48.3	-13.0	-35.3

Remarks:

1. Output Power (dBm) = S.G Value (dBm) + Correction Factor (dB).
2. Correction Factor (dB) = Substitution Antenna Gain (dB) + Cable Loss (dB).

Mode	TX channel 20375 (1752.50MHz)	Frequency Range	Above 1000MHz
Environmental Conditions	25deg. C, 69%RH	Input Power	120Vac, 60Hz
Tested By	Tank Wu		

Antenna Polarity & Test Distance: Horizontal at 3 M							
No.	Freq. (MHz)	Reading (dBm)	S.G Power Value (dBm)	Correction Factor (dB)	EIRP (dBm)	Limit (dBm)	Margin (dB)
1	3505.00	-61.2	-53.0	1.5	-51.5	-13.0	-38.5
2	5257.50	-62.1	-50.3	1.5	-48.8	-13.0	-35.8
Antenna Polarity & Test Distance: Vertical at 3 M							
No.	Freq. (MHz)	Reading (dBm)	S.G Power Value (dBm)	Correction Factor (dB)	EIRP (dBm)	Limit (dBm)	Margin (dB)
1	3505.00	-60.8	-53.2	1.5	-51.7	-13.0	-38.7
2	5257.50	-61.9	-50.3	1.5	-48.8	-13.0	-35.8

Remarks:

1. Output Power (dBm) = S.G Value (dBm) + Correction Factor (dB).
2. Correction Factor (dB) = Substitution Antenna Gain (dB) + Cable Loss (dB).

Channel Bandwidth: 10MHz

Mode	TX channel 20000 (1715.00MHz)	Frequency Range	Above 1000MHz
Environmental Conditions	25deg. C, 69%RH	Input Power	120Vac, 60Hz
Tested By	Tank Wu		

Antenna Polarity & Test Distance: Horizontal at 3 M							
No.	Freq. (MHz)	Reading (dBm)	S.G Power Value (dBm)	Correction Factor (dB)	EIRP (dBm)	Limit (dBm)	Margin (dB)
1	3430.00	-60.7	-52.2	1.4	-50.8	-13.0	-37.8
2	5145.00	-62.0	-49.9	1.4	-48.5	-13.0	-35.5
Antenna Polarity & Test Distance: Vertical at 3 M							
No.	Freq. (MHz)	Reading (dBm)	S.G Power Value (dBm)	Correction Factor (dB)	EIRP (dBm)	Limit (dBm)	Margin (dB)
1	3430.00	-60.2	-52.2	1.4	-50.8	-13.0	-37.8
2	5145.00	-61.7	-49.8	1.4	-48.4	-13.0	-35.4

Remarks:

1. Output Power (dBm) = S.G Value (dBm) + Correction Factor (dB).
2. Correction Factor (dB) = Substitution Antenna Gain (dB) + Cable Loss (dB).

Mode	TX channel 20175 (1732.50MHz)	Frequency Range	Above 1000MHz
Environmental Conditions	25deg. C, 69%RH	Input Power	120Vac, 60Hz
Tested By	Tank Wu		

Antenna Polarity & Test Distance: Horizontal at 3 M							
No.	Freq. (MHz)	Reading (dBm)	S.G Power Value (dBm)	Correction Factor (dB)	EIRP (dBm)	Limit (dBm)	Margin (dB)
1	3465.00	-60.9	-52.5	1.4	-51.1	-13.0	-38.1
2	5197.50	-61.0	-49.4	1.4	-48.0	-13.0	-35.0
Antenna Polarity & Test Distance: Vertical at 3 M							
No.	Freq. (MHz)	Reading (dBm)	S.G Power Value (dBm)	Correction Factor (dB)	EIRP (dBm)	Limit (dBm)	Margin (dB)
1	3465.00	-60.3	-52.5	1.4	-51.1	-13.0	-38.1
2	5197.50	-61.5	-49.3	1.4	-47.9	-13.0	-34.9

Remarks:

1. Output Power (dBm) = S.G Value (dBm) + Correction Factor (dB).
2. Correction Factor (dB) = Substitution Antenna Gain (dB) + Cable Loss (dB).

Mode	TX channel 20350 (1750.00MHz)	Frequency Range	Above 1000MHz
Environmental Conditions	25deg. C, 69%RH	Input Power	120Vac, 60Hz
Tested By	Tank Wu		

Antenna Polarity & Test Distance: Horizontal at 3 M							
No.	Freq. (MHz)	Reading (dBm)	S.G Power Value (dBm)	Correction Factor (dB)	EIRP (dBm)	Limit (dBm)	Margin (dB)
1	3500.00	-61.0	-52.8	1.5	-51.3	-13.0	-38.3
2	5250.00	-61.9	-50.2	1.5	-48.7	-13.0	-35.7
Antenna Polarity & Test Distance: Vertical at 3 M							
No.	Freq. (MHz)	Reading (dBm)	S.G Power Value (dBm)	Correction Factor (dB)	EIRP (dBm)	Limit (dBm)	Margin (dB)
1	3500.00	-60.2	-52.6	1.5	-51.1	-13.0	-38.1
2	5250.00	-61.2	-49.5	1.5	-48.0	-13.0	-35.0

Remarks:

1. Output Power (dBm) = S.G Value (dBm) + Correction Factor (dB).
2. Correction Factor (dB) = Substitution Antenna Gain (dB) + Cable Loss (dB).

Channel Bandwidth: 15MHz

Mode	TX channel 20025 (1717.50MHz)	Frequency Range	Above 1000MHz
Environmental Conditions	25deg. C, 69%RH	Input Power	120Vac, 60Hz
Tested By	Tank Wu		

Antenna Polarity & Test Distance: Horizontal at 3 M							
No.	Freq. (MHz)	Reading (dBm)	S.G Power Value (dBm)	Correction Factor (dB)	EIRP (dBm)	Limit (dBm)	Margin (dB)
1	3435.00	-60.5	-51.9	1.3	-50.6	-13.0	-37.6
2	5152.50	-60.9	-48.9	1.4	-47.5	-13.0	-34.5
Antenna Polarity & Test Distance: Vertical at 3 M							
No.	Freq. (MHz)	Reading (dBm)	S.G Power Value (dBm)	Correction Factor (dB)	EIRP (dBm)	Limit (dBm)	Margin (dB)
1	3435.00	-60.8	-52.7	1.3	-51.4	-13.0	-38.4
2	5152.50	-60.2	-48.2	1.4	-46.8	-13.0	-33.8

Remarks:

1. Output Power (dBm) = S.G Value (dBm) + Correction Factor (dB).
2. Correction Factor (dB) = Substitution Antenna Gain (dB) + Cable Loss (dB).

Mode	TX channel 20175 (1732.50MHz)	Frequency Range	Above 1000MHz
Environmental Conditions	25deg. C, 69%RH	Input Power	120Vac, 60Hz
Tested By	Tank Wu		

Antenna Polarity & Test Distance: Horizontal at 3 M							
No.	Freq. (MHz)	Reading (dBm)	S.G Power Value (dBm)	Correction Factor (dB)	EIRP (dBm)	Limit (dBm)	Margin (dB)
1	3465.00	-60.0	-51.6	1.4	-50.2	-13.0	-37.2
2	5197.50	-60.2	-48.6	1.4	-47.2	-13.0	-34.2
Antenna Polarity & Test Distance: Vertical at 3 M							
No.	Freq. (MHz)	Reading (dBm)	S.G Power Value (dBm)	Correction Factor (dB)	EIRP (dBm)	Limit (dBm)	Margin (dB)
1	3465.00	-59.9	-52.1	1.4	-50.7	-13.0	-37.7
2	5197.50	-60.2	-48.0	1.4	-46.6	-13.0	-33.6

Remarks:

1. Output Power (dBm) = S.G Value (dBm) + Correction Factor (dB).
2. Correction Factor (dB) = Substitution Antenna Gain (dB) + Cable Loss (dB).

Mode	TX channel 20325 (1747.50MHz)	Frequency Range	Above 1000MHz
Environmental Conditions	25deg. C, 69%RH	Input Power	120Vac, 60Hz
Tested By	Tank Wu		

Antenna Polarity & Test Distance: Horizontal at 3 M							
No.	Freq. (MHz)	Reading (dBm)	S.G Power Value (dBm)	Correction Factor (dB)	EIRP (dBm)	Limit (dBm)	Margin (dB)
1	3495.00	-59.9	-51.7	1.5	-50.2	-13.0	-37.2
2	5242.50	-59.5	-47.7	1.4	-46.3	-13.0	-33.3
Antenna Polarity & Test Distance: Vertical at 3 M							
No.	Freq. (MHz)	Reading (dBm)	S.G Power Value (dBm)	Correction Factor (dB)	EIRP (dBm)	Limit (dBm)	Margin (dB)
1	3495.00	-60.0	-52.4	1.5	-50.9	-13.0	-37.9
2	5242.50	-60.1	-48.2	1.4	-46.8	-13.0	-33.8

Remarks:

1. Output Power (dBm) = S.G Value (dBm) + Correction Factor (dB).
2. Correction Factor (dB) = Substitution Antenna Gain (dB) + Cable Loss (dB).

Channel Bandwidth: 20MHz

Mode	TX channel 20050 (1720.00MHz)	Frequency Range	Above 1000MHz
Environmental Conditions	25deg. C, 69%RH	Input Power	120Vac, 60Hz
Tested By	Tank Wu		

Antenna Polarity & Test Distance: Horizontal at 3 M							
No.	Freq. (MHz)	Reading (dBm)	S.G Power Value (dBm)	Correction Factor (dB)	EIRP (dBm)	Limit (dBm)	Margin (dB)
1	3440.00	-59.3	-50.8	1.3	-49.5	-13.0	-36.5
2	5160.00	-60.6	-48.6	1.4	-47.2	-13.0	-34.2
Antenna Polarity & Test Distance: Vertical at 3 M							
No.	Freq. (MHz)	Reading (dBm)	S.G Power Value (dBm)	Correction Factor (dB)	EIRP (dBm)	Limit (dBm)	Margin (dB)
1	3440.00	-59.7	-51.7	1.3	-50.4	-13.0	-37.4
2	5160.00	-60.4	-48.4	1.4	-47.0	-13.0	-34.0

Remarks:

- Output Power (dBm) = S.G Value (dBm) + Correction Factor (dB).
- Correction Factor (dB) = Substitution Antenna Gain (dB) + Cable Loss (dB).

Mode	TX channel 20175 (1732.50MHz)	Frequency Range	Above 1000MHz
Environmental Conditions	25deg. C, 69%RH	Input Power	120Vac, 60Hz
Tested By	Tank Wu		

Antenna Polarity & Test Distance: Horizontal at 3 M							
No.	Freq. (MHz)	Reading (dBm)	S.G Power Value (dBm)	Correction Factor (dB)	EIRP (dBm)	Limit (dBm)	Margin (dB)
1	3465.00	-59.4	-51.0	1.4	-49.6	-13.0	-36.6
2	5197.50	-60.4	-48.8	1.4	-47.4	-13.0	-34.4
Antenna Polarity & Test Distance: Vertical at 3 M							
No.	Freq. (MHz)	Reading (dBm)	S.G Power Value (dBm)	Correction Factor (dB)	EIRP (dBm)	Limit (dBm)	Margin (dB)
1	3465.00	-59.8	-52.0	1.4	-50.6	-13.0	-37.6
2	5197.50	-60.2	-48.0	1.4	-46.6	-13.0	-33.6

Remarks:

- Output Power (dBm) = S.G Value (dBm) + Correction Factor (dB).
- Correction Factor (dB) = Substitution Antenna Gain (dB) + Cable Loss (dB).

Mode	TX channel 20300 (1745.00MHz)	Frequency Range	Above 1000MHz
Environmental Conditions	25deg. C, 69%RH	Input Power	120Vac, 60Hz
Tested By	Tank Wu		

Antenna Polarity & Test Distance: Horizontal at 3 M							
No.	Freq. (MHz)	Reading (dBm)	S.G Power Value (dBm)	Correction Factor (dB)	EIRP (dBm)	Limit (dBm)	Margin (dB)
1	3490.00	-59.7	-51.5	1.5	-50.0	-13.0	-37.0
2	5235.00	-60.5	-48.7	1.4	-47.3	-13.0	-34.3
Antenna Polarity & Test Distance: Vertical at 3 M							
No.	Freq. (MHz)	Reading (dBm)	S.G Power Value (dBm)	Correction Factor (dB)	EIRP (dBm)	Limit (dBm)	Margin (dB)
1	3490.00	-59.3	-51.7	1.5	-50.2	-13.0	-37.2
2	5235.00	-60.8	-48.9	1.4	-47.5	-13.0	-34.5

Remarks:

1. Output Power (dBm) = S.G Value (dBm) + Correction Factor (dB).
2. Correction Factor (dB) = Substitution Antenna Gain (dB) + Cable Loss (dB).

LTE Band 13

Channel Bandwidth: 5MHz

Mode	TX channel 23205 (779.50MHz)	Frequency Range	Above 1000MHz
Environmental Conditions	25deg. C, 69%RH	Input Power	120Vac, 60Hz
Tested By	Tank Wu		

Antenna Polarity & Test Distance: Horizontal at 3 M							
No.	Freq. (MHz)	Reading (dBm)	S.G Power Value (dBm)	Correction Factor (dB)	ERP (dBm)	Limit (dBm)	Margin (dB)
1	1559.00	-57.5	-49.8	1.3	-48.5	-13.0	-35.5
2	2338.50	-54.2	-48.4	0.0	-48.4	-13.0	-35.4
Antenna Polarity & Test Distance: Vertical at 3 M							
No.	Freq. (MHz)	Reading (dBm)	S.G Power Value (dBm)	Correction Factor (dB)	ERP (dBm)	Limit (dBm)	Margin (dB)
1	1559.00	-56.1	-49.3	1.3	-48.0	-13.0	-35.0
2	2338.50	-55.6	-51.7	0.0	-51.7	-13.0	-38.7

Remarks:

1. Output Power (dBm) = S.G Value (dBm) + Correction Factor (dB).
2. Correction Factor (dB) = Substitution Antenna Gain (dB) + Cable Loss (dB).

Mode	TX channel 23230 (782.00MHz)	Frequency Range	Above 1000MHz
Environmental Conditions	25deg. C, 69%RH	Input Power	120Vac, 60Hz
Tested By	Tank Wu		

Antenna Polarity & Test Distance: Horizontal at 3 M							
No.	Freq. (MHz)	Reading (dBm)	S.G Power Value (dBm)	Correction Factor (dB)	ERP (dBm)	Limit (dBm)	Margin (dB)
1	1564.00	-57.9	-50.1	1.2	-48.9	-13.0	-35.9
2	2346.00	-55.5	-49.5	0.0	-49.5	-13.0	-36.5
Antenna Polarity & Test Distance: Vertical at 3 M							
No.	Freq. (MHz)	Reading (dBm)	S.G Power Value (dBm)	Correction Factor (dB)	ERP (dBm)	Limit (dBm)	Margin (dB)
1	1564.00	-55.5	-48.6	1.2	-47.4	-13.0	-34.4
2	2346.00	-56.6	-52.6	0.0	-52.6	-13.0	-39.6

Remarks:

1. Output Power (dBm) = S.G Value (dBm) + Correction Factor (dB).
2. Correction Factor (dB) = Substitution Antenna Gain (dB) + Cable Loss (dB).

Mode	TX channel 23255 (784.50MHz)	Frequency Range	Above 1000MHz
Environmental Conditions	25deg. C, 69%RH	Input Power	120Vac, 60Hz
Tested By	Tank Wu		

Antenna Polarity & Test Distance: Horizontal at 3 M							
No.	Freq. (MHz)	Reading (dBm)	S.G Power Value (dBm)	Correction Factor (dB)	ERP (dBm)	Limit (dBm)	Margin (dB)
1	1569.00	-58.6	-50.8	1.2	-49.6	-13.0	-36.6
2	2353.50	-56.2	-50.2	0.0	-50.2	-13.0	-37.2
Antenna Polarity & Test Distance: Vertical at 3 M							
No.	Freq. (MHz)	Reading (dBm)	S.G Power Value (dBm)	Correction Factor (dB)	ERP (dBm)	Limit (dBm)	Margin (dB)
1	1569.00	-56.4	-49.5	1.2	-48.3	-13.0	-35.3
2	2353.50	-56.4	-52.4	0.0	-52.4	-13.0	-39.4

Remarks:

1. Output Power (dBm) = S.G Value (dBm) + Correction Factor (dB).
2. Correction Factor (dB) = Substitution Antenna Gain (dB) + Cable Loss (dB).

Channel Bandwidth: 10MHz

Mode	TX channel 23230 (782.00MHz)	Frequency Range	Above 1000MHz
Environmental Conditions	25deg. C, 69%RH	Input Power	120Vac, 60Hz
Tested By	Tank Wu		

Antenna Polarity & Test Distance: Horizontal at 3 M							
No.	Freq. (MHz)	Reading (dBm)	S.G Power Value (dBm)	Correction Factor (dB)	ERP (dBm)	Limit (dBm)	Margin (dB)
1	1564.00	-57.5	-49.7	1.2	-48.5	-13.0	-35.5
2	2346.00	-55.2	-49.2	0.0	-49.2	-13.0	-36.2
Antenna Polarity & Test Distance: Vertical at 3 M							
No.	Freq. (MHz)	Reading (dBm)	S.G Power Value (dBm)	Correction Factor (dB)	ERP (dBm)	Limit (dBm)	Margin (dB)
1	1564.00	-55.2	-48.3	1.2	-47.1	-13.0	-34.1
2	2346.00	-56.2	-52.2	0.0	-52.2	-13.0	-39.2

Remarks:

1. Output Power (dBm) = S.G Value (dBm) + Correction Factor (dB).
2. Correction Factor (dB) = Substitution Antenna Gain (dB) + Cable Loss (dB).

5 Pictures of Test Arrangements

Please refer to the attached file (Test Setup Photo).

Appendix – Information on the Testing Laboratories

We, Bureau Veritas Consumer Products Services (H.K.) Ltd., Taoyuan Branch, were founded in 1988 to provide our best service in EMC, Radio, Telecom and Safety consultation. Our laboratories are accredited and approved according to ISO/IEC 17025.

If you have any comments, please feel free to contact us at the following:

Linko EMC/RF Lab

Tel: 886-2-26052180

Fax: 886-2-26051924

Hsin Chu EMC/RF/Telecom Lab

Tel: 886-3-6668565

Fax: 886-3-6668323

Hwa Ya EMC/RF/Safety Lab

Tel: 886-3-3183232

Fax: 886-3-3270892

Email: service.adt@tw.bureauveritas.com

Web Site: www.bureauveritas-adt.com

The address and road map of all our labs can be found in our web site also.

--- END ---