



# FCC RADIO TEST REPORT

**FCC ID** : H8N-ASK-NCQ1338  
**Equipment** : Verizon Internet Gateway  
**Brand Name** : Verizon Internet Gateway  
**Model Name** : ASK-NCQ1338  
**Applicant** : Askey Computer Corporation  
10F, NO. 119, JIANKANG RD., ZHONGHE DIST.,  
NEW TAIPEI CITY 23585, TAIWAN, R.O.C.  
**Manufacturer** : Askey Computer Corporation  
10F, NO. 119, JIANKANG RD., ZHONGHE DIST.,  
NEW TAIPEI CITY 23585, TAIWAN, R.O.C.  
**Standard** : FCC 47 CFR Part 2, 22(H), 24(E), 27

The product was received on Feb. 08, 2021 and testing was started from Mar. 07, 2021 and completed on Mar. 31, 2021. We, Sporton International Inc. EMC & Wireless Communications Laboratory, would like to declare that the tested sample has been evaluated in accordance with the test procedures given in ANSI / TIA-603-E and has been in compliance with the applicable technical standards.

The test results in this report apply exclusively to the tested model / sample. Without written approval of Sporton International Inc. EMC & Wireless Communications Laboratory, the test report shall not be reproduced except in full.

*Louis Wu*

Approved by: Louis Wu

**Sporton International Inc. EMC & Wireless Communications Laboratory**

No. 52, Huaya 1st Rd., Guishan Dist., Taoyuan City 333, Taiwan (R.O.C.)



# Table of Contents

**History of this test report..... 3**

**Summary of Test Result..... 4**

**1 General Description ..... 5**

    1.1 Product Feature of Equipment Under Test..... 5

    1.2 Modification of EUT ..... 5

    1.3 Testing Location ..... 6

    1.4 Applicable Standards..... 7

**2 Test Configuration of Equipment Under Test ..... 8**

    2.1 Test Mode..... 8

    2.2 Connection Diagram of Test System..... 12

    2.3 Support Unit used in test configuration and system ..... 12

    2.4 Measurement Results Explanation Example..... 12

    2.5 Frequency List of Low/Middle/High Channels ..... 13

**3 Conducted Test Items..... 19**

    3.1 Measuring Instruments ..... 19

    3.2 Conducted Output Power and ERP/EIRP ..... 20

    3.3 Peak-to-Average Ratio ..... 21

    3.4 Occupied Bandwidth..... 22

    3.5 Conducted Band Edge ..... 23

    3.6 Conducted Spurious Emission ..... 25

    3.7 Frequency Stability ..... 26

**4 Radiated Test Items ..... 27**

    4.1 Measuring Instruments ..... 27

    4.2 Radiated Spurious Emission Measurement ..... 29

**5 List of Measuring Equipment..... 30**

**6 Uncertainty of Evaluation..... 32**

**Appendix A. Test Results of Conducted Test**

**Appendix B. Test Results of Radiated Test**

**Appendix C. Test Setup Photographs**



### History of this test report

Report No.	Version	Description	Issued Date
FG110616A	01	Initial issue of report	Apr. 08, 2021



### Summary of Test Result

Report Clause	Ref Std. Clause	Test Items	Result (PASS/FAIL)	Remark
3.2	§2.1046	Conducted Output Power	Reporting only	-
	§22.913 (a)(5)	Effective Radiated Power (Band 5)	Pass	
	§27.50 (b)(10)	Effective Radiated Power (Band 13)		
	§24.232 (c)	Equivalent Isotropic Radiated Power (Band 2)		
	§27.50 (d)(4)	Equivalent Isotropic Radiated Power (Band 4) (Band 66)		
3.3	§24.232 (d) §27.50 (d)(5)	Peak-to-Average Ratio	Pass	-
3.4	§2.1049	Occupied Bandwidth	Reporting only	-
3.5	§2.1051 §22.917 (a) §24.238 (a) §27.53 (c)(2)(4) §27.53 (h)	Conducted Band Edge Measurement (Band 2) (Band 4) (Band 5) (Band 13) (Band 66)	Pass	-
3.6	§2.1051 §22.917 (a) §24.238 (a) §27.53 (c)(2) §27.53 (h)	Conducted Spurious Emission (Band 2) (Band 4) (Band 5) (Band 13) (Band 66)	Pass	-
3.7	§2.1055 §22.355 §24.235 §27.54	Frequency Stability Temperature & Voltage	Pass	-
4.2	§2.1053 §22.917 (a) §24.238 (a) §27.53 (c)(2) §27.53 (f) §27.53 (h)	Radiated Spurious Emission (Band 2) (Band 4) (Band 5) (Band 13) (Band 66)	Pass	Under limit 18.21 dB at 1569.000 MHz

**Declaration of Conformity:**

The test results with all measurement uncertainty excluded are presented in accordance with the regulation limits or requirements declared by manufacturers.

**Comments and Explanations:**

The declared of product specification for EUT presented in the report are provided by the manufacturer, and the manufacturer takes all the responsibilities for the accuracy of product specification.

**Reviewed by: Wii Chang**

**Report Producer: Dara Chiu**



# 1 General Description

## 1.1 Product Feature of Equipment Under Test

LTE, 5G NR, Bluetooth-LE, Wi-Fi 2.4GHz 802.11b/g/n/ac/ax, Wi-Fi 5GHz 802.11a/n/ac/ax, and GNSS.

Product Specification subjective to this standard	
Antenna Type	WWAN: Fixed internal PIFA antenna WLAN: Fixed internal Dipole antenna Bluetooth-LE: Fixed internal Dipole antenna GPS: Fixed internal Dipole antenna
Antenna Gain	<b>&lt;Ant. 0&gt;:</b> LTE Band 2: 3.4 dBi LTE Band 4: 3.6 dBi LTE Band 5: 0.4dBi LTE Band 13: -0.2dBi LTE Band 66: 3.8dBi <b>&lt;Ant. 3&gt;:</b> LTE Band 2: 2.0 dBi LTE Band 4: 2.8 dBi LTE Band 5: 0.4dBi LTE Band 13: 0.1dBi LTE Band 66: 2.8dBi

**Remark:** The above EUT's information was declared by manufacturer. Please refer to Comments and Explanations in report summary.

## 1.2 Modification of EUT

No modifications are made to the EUT during all test items.



### 1.3 Testing Location

<b>Test Site</b>	Sporton International Inc. EMC & Wireless Communications Laboratory
<b>Test Site Location</b>	No.52, Huaya 1st Rd., Guishan Dist., Taoyuan City 333, Taiwan (R.O.C.) TEL: +886-3-327-3456 FAX: +886-3-328-4978
<b>Test Site No.</b>	<b>Sporton Site No.</b>
	TH05-HY
<b>Test Engineer</b>	Benjamin Lin
<b>Temperature</b>	22.5 ~ 24.3 °C
<b>Relative Humidity</b>	48.3 ~ 51.4 %

**Note:** The test site complies with ANSI C63.4 2014 requirement.

<b>Test Site</b>	Sporton International Inc. Wensan Laboratory
<b>Test Site Location</b>	No.58, Aly. 75, Ln. 564, Wenhua 3rd, Rd., Guishan Dist., Taoyuan City 333101, Taiwan (R.O.C.) TEL: +886-3-327-0868 FAX: +886-3-327-0855
<b>Test Site No.</b>	<b>Sporton Site No.</b>
	03CH13-HY (TAF Code: 3786)
<b>Test Engineer</b>	Daniel Lee, Jacky Hong, and Wilson Wu
<b>Temperature</b>	20 ~ 25 °C
<b>Relative Humidity</b>	50 ~ 60 %
<b>Remark</b>	The Radiated Spurious Emission test item subcontracted to Sporton International Inc. Wensan Laboratory

**Note:** The test site complies with ANSI C63.4 2014 requirement.

FCC Designation No.: TW1190 and TW0007



## **1.4 Applicable Standards**

According to the specifications of the manufacturer, the EUT must comply with the requirements of the following standards:

- ♦ ANSI C63.26-2015
- ♦ ANSI / TIA-603-E
- ♦ FCC 47 CFR Part 2, 22(H), 24(E), 27
- ♦ FCC KDB 971168 D01 Power Meas. License Digital Systems v03r01
- ♦ FCC KDB 412172 D01 Determining ERP and EIRP v01r01
- ♦ FCC KDB 414788 D01 Radiated Test Site v01r01.

**Remark:**

1. All test items were verified and recorded according to the standards and without any deviation during the test.
2. This EUT has also been tested and complied with the requirements of FCC Part 15, Subpart B, recorded in a separate test report.
3. The TAF code is not including all the FCC KDB listed without accreditation.



## 2 Test Configuration of Equipment Under Test

### 2.1 Test Mode

Antenna port conducted and radiated test items listed below are performed according to KDB 971168 D01 Power Meas. License Digital Systems v03r01 with maximum output power.

For radiated measurement, pre-scanned in three orthogonal panels, X, Y, Z. The worst cases (Y plane) were recorded in this report.

Test Items	Band	Bandwidth (MHz)						Modulation				RB #			Test Channel		
		1.4	3	5	10	15	20	QPSK	16 QAM	64 QAM	256 QAM	1	Half	Full	L	M	H
Max. Output Power	2	v	v	v	v	v	v	v	v	v	v	v	v	v	v	v	v
	4	v	v	v	v	v	v	v	v	v	v	v	v	v	v	v	v
	5	v	v	v	v	-	-	v	v	v	v	v	v	v	v	v	v
	13	-	-	v	v	-	-	v	v	v	v	v	v	v	v	v	v
	66	v	v	v	v	v	v	v	v	v	v	v	v	v	v	v	v
Peak-to-Average Ratio	2						v	v	v	v	v	v		v	v	v	v
	4	Cover by Band 66															
	5				v	-	-	v	v	v	v	v		v	v	v	v
	13	-	-		v	-	-	v	v	v	v	v		v	v	v	v
	66						v	v	v	v	v	v		v	v	v	v
26dB and 99% Bandwidth	2	v	v	v	v	v	v	v	v	v	v			v	v	v	v
	4	Cover by Band 66															
	5	v	v	v	v	-	-	v	v	v	v			v	v	v	v
	13	-	-	v	v	-	-	v	v	v	v			v	v	v	v
	66	v	v	v	v	v	v	v	v	v	v			v	v	v	v
Conducted Band Edge	2	v	v	v	v	v	v	v	v	v	v	v		v	v		v
	4	Cover by Band 66															
	5	v	v	v	v	-	-	v	v	v	v	v		v	v		v
	13	-	-	v	v	-	-	v	v	v	v	v		v	v		v
	66	v	v	v	v	v	v	v	v	v	v	v		v	v		v
Conducted Spurious Emission	2	v	v	v	v	v	v	v	v	v	v	v			v	v	v
	4	Cover by Band 66															
	5	v	v	v	v	-	-	v	v	v	v	v			v	v	v
	13	-	-	v	v	-	-	v	v	v	v	v			v	v	v
	66	v	v	v	v	v	v	v	v	v	v	v			v	v	v





Test Items	Band	Bandwidth (MHz)						Modulation				RB #			Test Channel		
		1.4	3	5	10	15	20	QPSK	16 QAM	64 QAM	256 QAM	1	Half	Full	L	M	H
Frequency Stability	2				v			v						v		v	
	4	Cover by Band 66															
	5				v	-	-	v						v		v	
	13	-	-		v	-	-	v						v		v	
	66				v			v						v		v	
E.R.P / E.I.R.P	2	v	v	v	v	v	v	v	v	v	v	Max. Power					
	4	v	v	v	v	v	v	v	v	v	v						
	5	v	v	v	v	-	-	v	v	v	v						
	13	-	-	v	v	-	-	v	v	v	v						
	66	v	v	v	v	v	v	v	v	v	v						
Radiated Spurious Emission	2	Worst Case												v	v	v	
	4	Cover by Band 66															
	5	Worst Case												v	v	v	
	13	Worst Case												v	v	v	
	66	Worst Case												v	v	v	
Remark	<ol style="list-style-type: none"> <li>The mark "v " means that this configuration is chosen for testing</li> <li>The mark "- " means that this bandwidth is not supported.</li> <li>The device is investigated from 30MHz to 10 times of fundamental signal for radiated spurious emission test under different RB size/offset and modulations in exploratory test. Subsequently, only the worst case emissions are reported.</li> <li>Wider operating range bandwidth covers narrower one when the power is higher or the same.</li> <li>All the radiated test were performed with adapter 1.</li> </ol>																



Test Items	Band	Bandwidth (MHz)					Modulation				RB #			Test Channel		
		3+5	5+3	5+10	10+5	10+10	QPSK	16QAM	64QAM	256QAM	1	Half	Full	L	M	H
Max. Output Power	5_CA	v	v	v	v	v	v	v	v	v	v	v	v	v	v	v
26dB and 99% Bandwidth	5_CA	v	v	v	v	v	v	v	v	v			v		v	
Conducted Band Edge	5_CA	v	v	v	v	v	v	v	v	v	v		v	v		v
Conducted Spurious Emission	5_CA	v	v	v	v	v	v	v	v	v	v		v		v	
E.R.P.	5_CA	v	v	v	v	v	v	v	v	v	Max Power					
Radiated Spurious Emission	5_CA	Worst Case											v	v	v	
Remark	<ol style="list-style-type: none"> <li>The mark "v" means that this configuration is chosen for testing</li> <li>The mark "-" means that this bandwidth is not supported.</li> <li>The device is investigated from 30MHz to 10 times of fundamental signal for radiated spurious emission test under different RB size/offset and modulations in exploratory test. Subsequently, only the worst case emissions are reported.</li> <li>All the radiated test were performed with adapter 1.</li> </ol>															



Test Items	Band	Bandwidth (MHz)						Modulation				RB #			Test Channel			
		5+5	5+10	10+5	5+15	15+5	10+10	QPSK	16QAM	64QAM	256QAM	1	Half	Full	L	M	H	
Max. Output Power	66B_CA	v	v	v	v	v	v	v	v	v	v	v	v	v	v	v	v	v
26dB and 99% Bandwidth	66B_CA	v	v	v	v	v	v	v	v	v	v	v			v		v	
Conducted Band Edge	66B_CA	v	v	v	v	v	v	v	v	v	v	v	v		v	v		v
Conducted Spurious Emission	66B_CA	v	v	v	v	v	v	v	v					v		v	v	v
E.I.R.P.	66B_CA	v	v	v	v	v	v	v	v	v	v	v	Max Power					
Radiated Spurious Emission	66B_CA	Worst Case													v	v	v	
Remark	<ol style="list-style-type: none"> <li>The mark "v" means that this configuration is chosen for testing</li> <li>The mark "-" means that this bandwidth is not supported.</li> <li>The device is investigated from 30MHz to 10 times of fundamental signal for radiated spurious emission test under different RB size/offset and modulations in exploratory test. Subsequently, only the worst case emissions are reported.</li> <li>All the radiated test were performed with adapter 1.</li> </ol>																	

Test Items	Band	Bandwidth (MHz)										Modulation				RB #			Test Channel			
		10+15	15+10	10+20	20+10	15+15	15+20	20+15	20+5	5+20	20+20	QPSK	16QAM	64QAM	256QAM	1	Half	Full	L	M	H	
Max. Output Power	66C_CA	v	v	v	v	v	v	v	v	v	v	v	v	v	v	v	v	v	v	v	v	
26dB and 99% Bandwidth	66C_CA	v	v	v	v	v	v	v	v	v	v	v	v	v	v			v		v		
Conducted Band Edge	66C_CA	v	v	v	v	v	v	v	v	v	v	v	v	v	v	v		v	v		v	
Conducted Spurious Emission	66C_CA	v	v	v	v	v	v	v	v	v	v	v					v			v	v	v
E.I.R.P.	66C_CA	v	v	v	v	v	v	v	v	v	v	v	v	v	v	Max Power						
Radiated Spurious Emission	66C_CA	Worst Case																		v	v	v
Remark	<ol style="list-style-type: none"> <li>The mark "v" means that this configuration is chosen for testing</li> <li>The mark "-" means that this bandwidth is not supported.</li> <li>The device is investigated from 30MHz to 10 times of fundamental signal for radiated spurious emission test under different RB size/offset and modulations in exploratory test. Subsequently, only the worst case emissions are reported.</li> <li>All the radiated test were performed with adapter 1.</li> </ol>																					

## 2.2 Connection Diagram of Test System

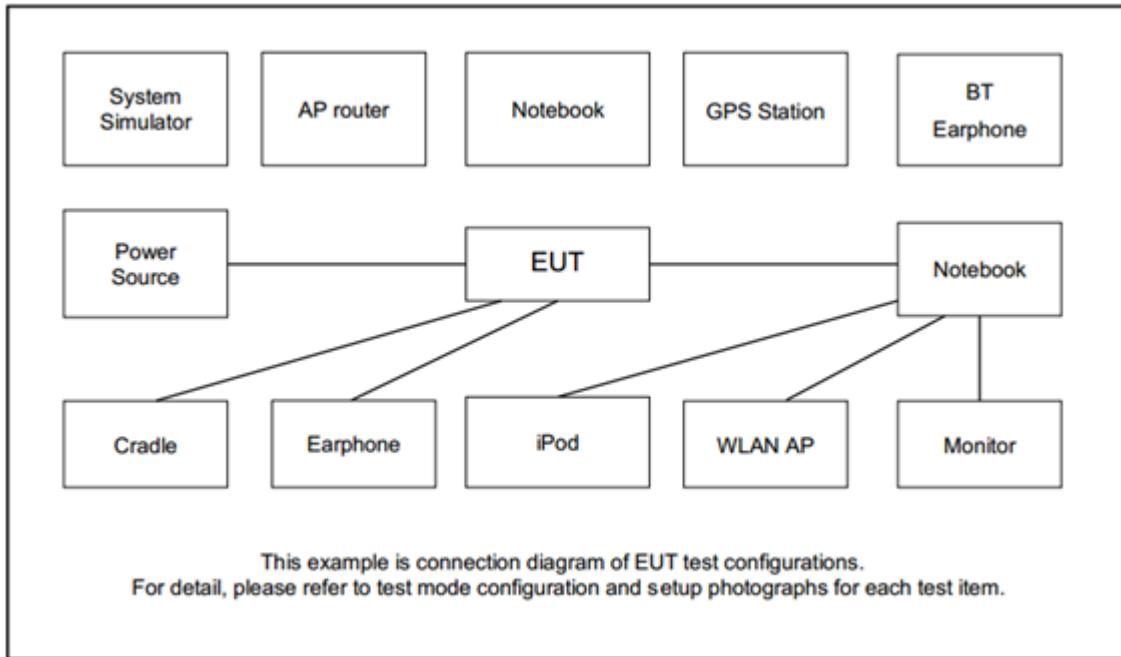

## 2.3 Support Unit used in test configuration and system

Item	Equipment	Brand Name	Model No.	FCC ID	Data Cable	Power Cord
1.	System Simulator	Anritsu	MT8821C	N/A	N/A	Unshielded, 1.8 m
2.	5G Wireless Test Platform	Keysight	MT8000A	N/A	N/A	Unshielded, 1.8m

## 2.4 Measurement Results Explanation Example

### For all conducted test items:

The offset level is set in the spectrum analyzer to compensate the RF cable loss and attenuator factor between EUT conducted output port and spectrum analyzer. With the offset compensation, the spectrum analyzer reading level is exactly the EUT RF output level.

The spectrum analyzer offset is derived from RF cable loss and attenuator factor.

*Offset = RF cable loss + attenuator factor.*

Following shows an offset computation example with cable loss 4.2 dB and 10dB attenuator.

Example :

$$\begin{aligned} \text{Offset(dB)} &= \text{RF cable loss(dB)} + \text{attenuator factor(dB)} \\ &= 4.2 + 10 = 14.2 \text{ (dB)} \end{aligned}$$



### 2.5 Frequency List of Low/Middle/High Channels

LTE Band 2 Channel and Frequency List				
BW [MHz]	Channel/Frequency(MHz)	Lowest	Middle	Highest
20	Channel	18700	18900	19100
	Frequency	1860	1880	1900
15	Channel	18675	18900	19125
	Frequency	1857.5	1880	1902.5
10	Channel	18650	18900	19150
	Frequency	1855	1880	1905
5	Channel	18625	18900	19175
	Frequency	1852.5	1880	1907.5
3	Channel	18615	18900	19185
	Frequency	1851.5	1880	1908.5
1.4	Channel	18607	18900	19193
	Frequency	1850.7	1880	1909.3

LTE Band 4 Channel and Frequency List				
BW [MHz]	Channel/Frequency(MHz)	Lowest	Middle	Highest
20	Channel	20050	20175	20300
	Frequency	1720	1732.5	1745
15	Channel	20025	20175	20325
	Frequency	1717.5	1732.5	1747.5
10	Channel	20000	20175	20350
	Frequency	1715	1732.5	1750
5	Channel	19975	20175	20375
	Frequency	1712.5	1732.5	1752.5
3	Channel	19965	20175	20385
	Frequency	1711.5	1732.5	1753.5
1.4	Channel	19957	20175	20393
	Frequency	1710.7	1732.5	1754.3



LTE Band 5 Channel and Frequency List				
BW [MHz]	Channel/Frequency(MHz)	Lowest	Middle	Highest
10	Channel	20450	20525	20600
	Frequency	829	836.5	844
5	Channel	20425	20525	20625
	Frequency	826.5	836.5	846.5
3	Channel	20415	20525	20635
	Frequency	825.5	836.5	847.5
1.4	Channel	20407	20525	20643
	Frequency	824.7	836.5	848.3

LTE Band 13 Channel and Frequency List				
BW [MHz]	Channel/Frequency(MHz)	Lowest	Middle	Highest
10	Channel	-	23230	-
	Frequency	-	782	-
5	Channel	23205	23230	23255
	Frequency	779.5	782	784.5

LTE Band 66 Channel and Frequency List				
BW [MHz]	Channel/Frequency(MHz)	Lowest	Middle	Highest
20	Channel	132072	132322	132572
	Frequency	1720	1745	1770
15	Channel	132047	132322	132597
	Frequency	1717.5	1745	1772.5
10	Channel	132022	132322	132622
	Frequency	1715	1745	1775
5	Channel	131997	132322	132647
	Frequency	1712.5	1745	1777.5
3	Channel	131987	132322	132657
	Frequency	1711.5	1745	1778.5
1.4	Channel	131979	132322	132665
	Frequency	1710.7	1745	1779.3



LTE Band 5 Channel and Frequency List					
BW [MHz]	Channel/Frequency(MHz)		Lowest	Middle	Highest
5 + 10	PCC	Channel	20428	20478	20528
		Frequency	826.8	831.8	836.8
	SCC	Channel	20500	20550	20600
		Frequency	834.0	839.0	844.0
10 + 5	PCC	Channel	20450	20500	20550
		Frequency	829.0	834.0	839.0
	SCC	Channel	20522	20572	20622
		Frequency	836.2	841.2	846.2
10 + 10	PCC	Channel	20450	20476	20501
		Frequency	829.0	831.6	834.1
	SCC	Channel	20549	20575	20600
		Frequency	838.9	841.5	844.0



LTE Band 6B Channel and Frequency List					
BW [MHz]	Channel/Frequency(MHz)		Lowest	Middle	Highest
5 + 5	PCC	Channel	131997	132398	132599
		Frequency	1712.5	1752.6	1772.7
	SCC	Channel	132045	133346	132647
		Frequency	1717.3	1757.4	1777.5
5 + 10	PCC	Channel	132000	132375	132550
		Frequency	1712.8	1750.3	1767.8
	SCC	Channel	132072	133347	132622
		Frequency	1720.0	1757.5	1775.0
10 + 5	PCC	Channel	132022	132397	132572
		Frequency	1715.0	1752.5	1770.0
	SCC	Channel	132094	133369	132644
		Frequency	1722.2	1759.7	1777.2
5 + 15	PCC	Channel	132002	132353	132504
		Frequency	1713.0	1748.1	1763.2
	SCC	Channel	132095	133346	132597
		Frequency	1722.3	1757.4	1772.5
15 + 5	PCC	Channel	132047	132398	132549
		Frequency	1717.5	1752.6	1767.7
	SCC	Channel	132140	133391	132642
		Frequency	1726.8	1761.9	1777.0
10 + 10	PCC	Channel	132022	132373	135523
		Frequency	1715.0	1750.1	1765.1
	SCC	Channel	132121	133372	132622
		Frequency	1724.9	1760.0	1775.0





LTE Band 66C Channel and Frequency List					
BW [MHz]	Channel/Frequency(MHz)		Lowest	Middle	Highest
10 + 15	PCC	Channel	132025	132351	132477
		Frequency	1715.3	1747.9	1760.5
	SCC	Channel	132145	133371	132597
		Frequency	1727.3	1759.9	1772.5
15 + 10	PCC	Channel	132047	132373	132499
		Frequency	1717.5	1750.1	1762.7
	SCC	Channel	132167	133393	132619
		Frequency	1729.5	1761.1	1774.7
10 + 20	PCC	Channel	132027	132328	132428
		Frequency	1715.5	1745.6	1755.6
	SCC	Channel	131171	133372	132572
		Frequency	1729.9	1760.0	1770.0
20 + 10	PCC	Channel	132072	132373	132473
		Frequency	1720.0	1750.1	1760.1
	SCC	Channel	132216	133417	132617
		Frequency	1734.4	1764.5	1774.5
15 + 15	PCC	Channel	132047	132347	132447
		Frequency	1717.5	1747.5	1757.5
	SCC	Channel	132197	133397	132597
		Frequency	1732.5	1762.5	1772.5
15 + 20	PCC	Channel	132050	132325	132401
		Frequency	1717.8	1745.3	1752.9
	SCC	Channel	132221	133396	132572
		Frequency	1734.9	1762.4	1770.0
20 + 15	PCC	Channel	132072	132348	132423
		Frequency	1720.0	1747.6	1755.1
	SCC	Channel	132243	133419	132594
		Frequency	1737.1	1764.7	1772.2
20 + 5	PCC	Channel	132072	132397	132522
		Frequency	1720.0	1752.5	1765.0
	SCC	Channel	132189	133414	132639
		Frequency	1731.7	1764.2	1776.7



<b>LTE Band 66C Channel and Frequency List</b>					
5 + 20	PCC	Channel	132005	132330	132455
		Frequency	1713.3	1745.8	1758.3
	SCC	Channel	132122	132447	132572
		Frequency	1725.0	1757.5	1770.0
20 + 20	PCC	Channel	132072	132323	132374
		Frequency	1720.0	1745.1	1750.2
	SCC	Channel	132270	133421	132572
		Frequency	1739.8	1764.9	1770.0

### 3 Conducted Test Items

#### 3.1 Measuring Instruments

See list of measuring instruments of this test report.

##### 3.1.1 Test Setup

##### 3.1.2 Conducted Output Power



##### 3.1.3 Peak-to-Average Ratio, Occupied Bandwidth ,Conducted Band-Edge and Conducted Spurious Emission

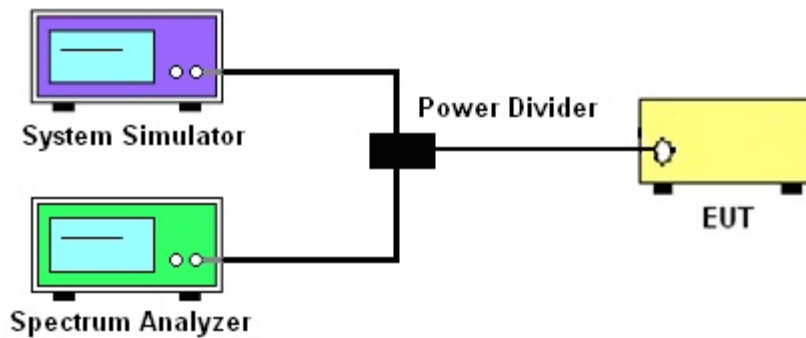

##### 3.1.4 Frequency Stability

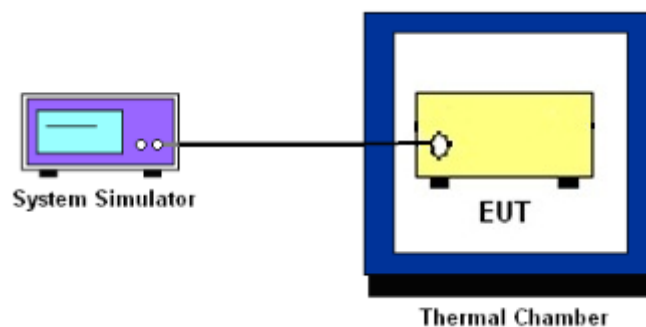

##### 3.1.5 Test Result of Conducted Test

Please refer to Appendix A.



## 3.2 Conducted Output Power and ERP/EIRP

### 3.2.1 Description of the Conducted Output Power Measurement and ERP/EIRP Measurement

A system simulator was used to establish communication with the EUT. Its parameters were set to force the EUT transmitting at maximum output power. The measured power in the radio frequency on the transmitter output terminals shall be reported.

The ERP of mobile transmitters must not exceed 7 Watts for LTE Band 5

The ERP of mobile transmitters must not exceed 3 Watts for LTE Band 13

The EIRP of mobile transmitters must not exceed 2 Watts for LTE Band 2

The EIRP of mobile transmitters must not exceed 1 Watts for LTE Band 4 and Band 66

According to KDB 412172 D01 Power Approach,

$EIRP = P_T + G_T - L_C$ ,  $ERP = EIRP - 2.15$ , where

$P_T$  = transmitter output power in dBm

$G_T$  = gain of the transmitting antenna in dBi

$L_C$  = signal attenuation in the connecting cable between the transmitter and antenna in dB

### 3.2.2 Test Procedures

1. The transmitter output port was connected to the system simulator.
2. Set EUT at maximum power through the system simulator.
3. Select lowest, middle, and highest channels for each band and different modulation.
4. Measure and record the power level from the system simulator.



### **3.3 Peak-to-Average Ratio**

#### **3.3.1 Description of the PAR Measurement**

Power Complementary Cumulative Distribution Function (CCDF) curves provide a means for characterizing the power peaks of a digitally modulated signal on a statistical basis. A CCDF curve depicts the probability of the peak signal amplitude exceeding the average power level. Most contemporary measurement instrumentation include the capability to produce CCDF curves for an input signal provided that the instrument's resolution bandwidth can be set wide enough to accommodate the entire input signal bandwidth. In measuring transmissions in this band using an average power technique, the peak-to-average ratio (PAR) of the transmission may not exceed 13 dB.

#### **3.3.2 Test Procedures**

The testing follows ANSI C63.26-2015 Section 5.2.6

1. The EUT was connected to spectrum and system simulator via a power divider.
2. Set the CCDF (Complementary Cumulative Distribution Function) option in spectrum analyzer.
3. The highest RF powers were measured and recorded the maximum PAPR level associated with a probability of 0.1 %.
4. Record the deviation as Peak to Average Ratio.



## 3.4 Occupied Bandwidth

### 3.4.1 Description of Occupied Bandwidth Measurement

The occupied bandwidth is the width of a frequency band such that, below the lower and above the upper frequency limits, the mean powers emitted are each equal to a specified percentage 0.5% of the total mean transmitted power.

The 26 dB emission bandwidth is defined as the frequency range between two points, one above and one below the carrier frequency, at which the spectral density of the emission is attenuated 26 dB below the maximum in-band spectral density of the modulated signal. Spectral density (power per unit bandwidth) is to be measured with a detector of resolution bandwidth equal to approximately 1.0% of the emission bandwidth.

### 3.4.2 Test Procedures

The testing follows ANSI C63.26-2015 Section 5.4.3 (26dB) and Section 5.4.4 (99OB)

1. The EUT was connected to spectrum analyzer and system simulator via a power divider.
2. The spectrum analyzer center frequency is set to the nominal EUT channel center frequency. The span range for the spectrum analyzer shall be between two and five times the anticipated OBW.
3. The nominal resolution bandwidth (RBW) shall be in the range of 1 to 5 % of the anticipated OBW, and the VBW shall be at least 3 times the RBW.
4. Set the detection mode to peak, and the trace mode to max hold.
5. Determine the reference value: Set the EUT to transmit a modulated signal. Allow the trace to stabilize. Set the spectrum analyzer marker to the highest level of the displayed trace.  
(this is the reference value)
6. Determine the “-26 dB down amplitude” as equal to (Reference Value – X).
7. Place two markers, one at the lowest and the other at the highest frequency of the envelope of the spectral display such that each marker is at or slightly below the “-X dB down amplitude” determined in step 6. If a marker is below this “-X dB down amplitude” value it shall be placed as close as possible to this value. The OBW is the positive frequency difference between the two markers.
8. Use the 99 % power bandwidth function of the spectrum analyzer and report the measured bandwidth.



### 3.5 Conducted Band Edge

#### 3.5.1 Description of Conducted Band Edge Measurement

22.917(a)

For operations in the 824 – 849 MHz band, the FCC limit is  $43 + 10\log_{10}(P[\text{Watts}])$  dB below the transmitter power  $P(\text{Watts})$  in a 100kHz bandwidth. However, in the 1MHz bands immediately outside and adjacent to the licensee's frequency block, a resolution bandwidth of at least one percent of the emission bandwidth of the fundamental emission of the transmitter may be employed.

24.238 (a)

For operations in the 1850-1910 and 1930-1990 MHz band, the FCC limit is  $43 + 10\log_{10}(P[\text{Watts}])$  dB below the transmitter power  $P(\text{Watts})$  in a 1MHz bandwidth. However, in the 1 MHz bands immediately outside and adjacent to the frequency block a resolution bandwidth of at least one percent of the emission bandwidth of the fundamental emission of the transmitter may be employed.

27.53 (c)

For operations in the 776-788 MHz band, the FCC limit is  $43 + 10\log_{10}(P[\text{Watts}])$  dB below the transmitter power  $P(\text{Watts})$  in a 100 kHz bandwidth. However, in the 100 kHz bands immediately outside and adjacent to the frequency block, a resolution bandwidth of at least 30 kHz may be employed. In addition, the power of any unwanted emissions in any 6.25 kHz bandwidth for all frequencies between 763-775 MHz and 793-806 MHz shall be attenuated below the transmitter power,  $P$  (dBW), by at least  $65 + 10 \log_{10} p(\text{watts})$ , dB, for mobile and portable equipment.

27.53 (h)

For operations in the 1710 – 1755 MHz band, 1755-1780 MHz, the FCC limit is  $43 + 10\log_{10}(P[\text{Watts}])$  dB below the transmitter power  $P(\text{Watts})$  in a 1 MHz bandwidth. However, in the 1MHz bands immediately outside and adjacent to the licensee's frequency block, a resolution bandwidth of at least one percent of the emission bandwidth of the fundamental emission of the transmitter may be employed.



### **3.5.2 Test Procedures**

The testing follows FCC KDB 971168 D01 v03r01 Section 6.1.

1. The EUT was connected to spectrum analyzer and system simulator via a power divider.
2. The band edges of low and high channels for the highest RF powers were measured.
3. Set RBW  $\geq$  1% EBW in the 1MHz band immediately outside and adjacent to the band edge.
4. Beyond the 1 MHz band from the band edge, RBW=1MHz was used.
5. Set spectrum analyzer with RMS detector.
6. The RF fundamental frequency should be excluded against the limit line in the operating frequency band.
7. Checked that all the results comply with the emission limit line.

The limit line is derived from  $43 + 10\log(P)$ dB below the transmitter power P(Watts)





## 3.6 Conducted Spurious Emission

### 3.6.1 Description of Conducted Spurious Emission Measurement

The power of any emission outside of the authorized operating frequency ranges must be lower than the transmitter power (P) by a factor of at least  $43 + 10 \log (P)$  dB.

It is measured by means of a calibrated spectrum analyzer and scanned from 30 MHz up to a frequency including its 10<sup>th</sup> harmonic.

### 3.6.2 Test Procedures

The testing follows FCC KDB 971168 D01 v03r01 Section 6.1.

1. The EUT was connected to spectrum analyzer and system simulator via a power divider.
2. The RF output of EUT was connected to the spectrum analyzer by RF cable and attenuator. The path loss was compensated to the results for each measurement.
3. The middle channel for the highest RF power within the transmitting frequency was measured.
4. The conducted spurious emission for the whole frequency range was taken.
5. Make the measurement with the spectrum analyzer's RBW = 1MHz, VBW = 3MHz.
6. Set spectrum analyzer with RMS detector.
7. Taking the record of maximum spurious emission.
8. The RF fundamental frequency should be excluded against the limit line in the operating frequency band.
9. The limit line is derived from  $43 + 10\log(P)$ dB below the transmitter power P(Watts)



### 3.7 Frequency Stability

#### 3.7.1 Description of Frequency Stability Measurement

22.355

The frequency stability shall be measured by variation of ambient temperature and variation of primary supply voltage to ensure that the fundamental emission stays within the authorized frequency block. The frequency stability of the transmitter shall be maintained within  $\pm 0.00025\%$  ( $\pm 2.5\text{ppm}$ ) of the center frequency.

24.235 & 27.54

The frequency stability shall be sufficient to ensure that the fundamental emission stays within the authorized frequency block.

#### 3.7.2 Test Procedures for Temperature Variation

The testing follows FCC KDB 971168 D01 v03r01 Section 9.0.

1. The EUT was set up in the thermal chamber and connected with the system simulator.
2. With power OFF, the temperature was decreased to  $-30^{\circ}\text{C}$  and the EUT was stabilized before testing. Power was applied and the maximum change in frequency was recorded within one minute.
3. With power OFF, the temperature was raised in  $10^{\circ}\text{C}$  step up to  $50^{\circ}\text{C}$ . The EUT was stabilized at each step for at least half an hour. Power was applied and the maximum frequency change was recorded within one minute.

#### 3.7.3 Test Procedures for Voltage Variation

The testing follows FCC KDB 971168 D01 v03r01 Section 9.0.

1. The EUT was placed in a temperature chamber at  $20\pm 5^{\circ}\text{C}$  and connected with the system simulator.
2. The power supply voltage to the EUT was varied from 85% to 115% of the nominal value measured at the input to the EUT.
3. The variation in frequency was measured for the worst case.

## 4 Radiated Test Items

### 4.1 Measuring Instruments

See list of measuring instruments of this test report.

#### 4.1.1 Test Setup

For radiated test below 30MHz



For radiated test from 30MHz to 1GHz



For radiated test above 1GHz

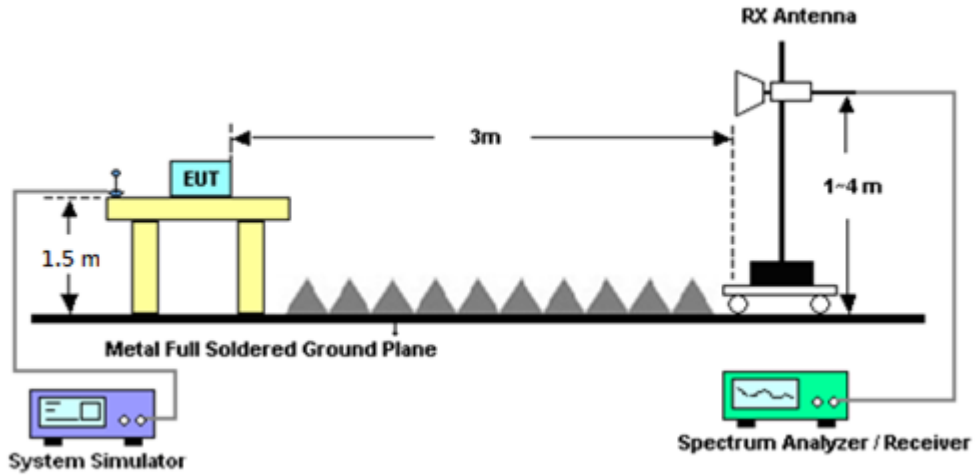

#### 4.1.2 Test Result of Radiated Test

Please refer to Appendix B.

**Note:**

The low frequency, which started from 9 kHz to 30MHz, was pre-scanned and the result which was 20dB lower than the limit line was not reported.

There is a comparison data of both open-field test site and alternative test site - semi-Anechoic chamber according to 414788 D01 Radiated Test Site v01r01, and the result came out very similar.



## 4.2 Radiated Spurious Emission Measurement

### 4.2.1 Description of Radiated Spurious Emission Measurement

The radiated spurious emission was measured by substitution method according to ANSI / TIA-603-E. The power of any emission outside of the authorized operating frequency ranges must be attenuated below the transmitter power (P) by a factor of at least  $43 + 10 \log (P)$  dB.

For LTE Band 13

For operations in the 746-758 MHz, 775-788 MHz, and 805-806 MHz bands, emissions in the band 1559-1610 MHz shall be limited to  $-70$  dBW/MHz equivalent isotropically radiated power (EIRP) for wideband signals, and  $-80$  dBW EIRP for discrete emissions of less than 700 Hz bandwidth.

The spectrum is scanned from 30 MHz up to a frequency including its 10th harmonic.

### 4.2.2 Test Procedures

The testing follows FCC KDB 971168 D01 v03r01 Section 7 and ANSI / TIA-603-E Section 2.2.12.

1. The EUT was placed on a turntable with 0.8 meter for frequency below 1GHz and 1.5 meter for frequency above 1GHz respectively above ground.
2. The EUT was set 3 meters from the receiving antenna, which was mounted on the antenna tower.
3. The table was rotated 360 degrees to determine the position of the highest spurious emission.
4. The height of the receiving antenna is varied between one meter and four meters to search the maximum spurious emission for both horizontal and vertical polarizations.
5. Make the measurement with the spectrum analyzer's RBW = 1MHz, VBW = 3MHz, taking the record of maximum spurious emission.
6. A horn antenna was substituted in place of the EUT and was driven by a signal generator.
7. Tune the output power of signal generator to the same emission level with EUT maximum spurious emission.
8. Taking the record of output power at antenna port.
9. Repeat step 7 to step 8 for another polarization.
10. The RF fundamental frequency should be excluded against the limit line in the operating frequency band.

The limit line is derived from  $43 + 10\log(P)$ dB below the transmitter power P(Watts)

$EIRP \text{ (dBm)} = S.G. \text{ Power} - Tx \text{ Cable Loss} + Tx \text{ Antenna Gain}$

$ERP \text{ (dBm)} = EIRP - 2.15$



## 5 List of Measuring Equipment

Instrument	Brand Name	Model No.	Serial No.	Characteristics	Calibration Date	Test Date	Due Date	Remark
Loop Antenna	Rohde & Schwarz	HFH2-Z2	100488	9 kHz~30 MHz	Jul. 14, 2020	Mar. 12, 2021~ Mar. 31, 2021	Jul. 13, 2021	Radiation (03CH13-HY)
Bilog Antenna	TESEQ	CBL 6111D&00800 N1D01N-06	40103&07	30MHz to 1GHz	Apr. 29, 2020	Mar. 12, 2021~ Mar. 31, 2021	Apr. 28, 2021	Radiation (03CH13-HY)
Bilog Antenna	TESEQ	CBL 6111D&00800 N1D01N-06	35419 & 03	30MHz to 1GHz	Apr. 29, 2020	Mar. 12, 2021~ Mar. 31, 2021	Apr. 28, 2021	Radiation (03CH13-HY)
Horn Antenna	SCHWARZBE CK	BBHA 9120 D	9120D-1212	1GHz ~ 18GHz	May 20, 2020	Mar. 12, 2021~ Mar. 31, 2021	May 19, 2021	Radiation (03CH13-HY)
Horn Antenna	SCHWARZBE CK	BBHA 9120 D	9120D-1241	1GHz ~ 18GHz	Jul. 15, 2020	Mar. 12, 2021~ Mar. 31, 2021	Jul. 14, 2021	Radiation (03CH13-HY)
SHF-EHF Horn Antenna	SCHWARZBE CK	BBHA 9170	BBHA917058 4	18GHz- 40GHz	Dec. 11, 2020	Mar. 12, 2021~ Mar. 31, 2021	Dec. 10, 2021	Radiation (03CH13-HY)
SHF-EHF Horn Antenna	SCHWARZBE CK	BBHA 9170	BBHA917098 0	18GHz~40GHz	Jan. 11, 2021	Mar. 12, 2021~ Mar. 31, 2021	Jan. 10, 2022	Radiation (03CH13-HY)
Amplifier	Sonoma-Instru ment	310 N	187282	9KHz~1GHz	Dec. 16, 2020	Mar. 12, 2021~ Mar. 31, 2021	Dec. 15, 2021	Radiation (03CH13-HY)
Preamplifier	MITEQ	AMF-7D-0010 1800-30-10P	1590074	1GHz~18GHz	May 19, 2020	Mar. 12, 2021~ Mar. 31, 2021	May 18, 2021	Radiation (03CH13-HY)
Preamplifier	Keysight	83017A	MY53270147	1GHz~26.5GHz	Oct. 28, 2020	Mar. 12, 2021~ Mar. 31, 2021	Oct. 27, 2021	Radiation (03CH13-HY)
Preamplifier	EMEC	EM18G40G	060715	18GHz ~ 40GHz	Dec. 11, 2020	Mar. 12, 2021~ Mar. 31, 2021	Dec. 10, 2021	Radiation (03CH13-HY)
Signal Generator	Anritsu	MG3694C	163401	0.1Hz~40GHz	Jan. 31, 2021	Mar. 12, 2021~ Mar. 31, 2021	Jan. 30, 2022	Radiation (03CH13-HY)
Spectrum Analyzer	Keysight	N9010A	MY55370526	10Hz~44GHz	Mar. 20, 2020	Mar. 12, 2021~ Mar. 31, 2021	Mar. 19, 2021	Radiation (03CH13-HY)
Spectrum Analyzer	Keysight	N9010A	MY55370526	10Hz~44GHz	Mar. 18, 2021	Mar. 12, 2021~ Mar. 31, 2021	Mar. 17, 2022	Radiation (03CH13-HY)
Antenna Mast	EMEC	AM-BS-4500-B	N/A	1m~4m	N/A	Mar. 12, 2021~ Mar. 31, 2021	N/A	Radiation (03CH13-HY)
Turn Table	EMEC	TT2000	N/A	0~360 Degree	N/A	Mar. 12, 2021~ Mar. 31, 2021	N/A	Radiation (03CH13-HY)
Software	Audix	E3 6.2009-8-24	RK-000992	N/A	N/A	Mar. 12, 2021~ Mar. 31, 2021	N/A	Radiation (03CH13-HY)
RF Cable	HUBER + SUHNER	SUCOFLEX 126E	0030/126E	30M-18G	Feb. 10, 2021	Mar. 12, 2021~ Mar. 31, 2021	Feb. 09, 2022	Radiation (03CH13-HY)
RF Cable	HUBER + SUHNER	SUCOFLEX 104	804793/4	30M-18G	Feb. 10, 2021	Mar. 12, 2021~ Mar. 31, 2021	Feb. 09, 2022	Radiation (03CH13-HY)
RF Cable	HUBER + SUHNER	SUCOFLEX 102	505134/2	30M~40GHz	Feb. 22, 2021	Mar. 12, 2021~ Mar. 31, 2021	Feb. 21, 2022	Radiation (03CH13-HY)
RF Cable	HUBER + SUHNER	SUCOFLEX 102	MY4274/2	30M~40GHz	Mar. 11, 2021	Mar. 12, 2021~ Mar. 31, 2021	Mar. 10, 2022	Radiation (03CH13-HY)
RF Cable	HUBER + SUHNER	SUCOFLEX 104	MY24961/4	30M-18G	Feb. 10, 2021	Mar. 12, 2021~ Mar. 31, 2021	Feb. 09, 2022	Radiation (03CH13-HY)
RF Cable	HUBER + SUHNER	SUCOFLEX 104	MY9837/4PE	9kHz~30MHz	Mar. 11, 2021	Mar. 12, 2021~ Mar. 31, 2021	Mar. 10, 2022	Radiation (03CH13-HY)
Filter	Wainwright	WHKX12-1080 -1200-15000-6 OSS	SN3	1.2GHz High Pass Filter	Jul. 02, 2020	Mar. 12, 2021~ Mar. 31, 2021	Jul. 01, 2021	Radiation (03CH13-HY)
Filter	Wainwright	WHKX12-2700 -3000-18000-6 OSS	SN2	3GHz High Pass Filter	Jul. 13, 2020	Mar. 12, 2021~ Mar. 31, 2021	Jul. 12, 2021	Radiation (03CH13-HY)



Instrument	Brand Name	Model No.	Serial No.	Characteristics	Calibration Date	Test Date	Due Date	Remark
Base Station (Measure)	Anritsu	MT8821C	62620025341	N/A	Oct. 05, 2020	Mar. 07, 2021~ Mar. 30, 2021	Oct. 04, 2021	Conducted (TH05-HY)
Spectrum Analyzer	Rohde & Schwarz	FSV40	101397	10Hz~40GHz	Nov. 27, 2020	Mar. 07, 2021~ Mar. 30, 2021	Nov. 26, 2021	Conducted (TH05-HY)
Thermal Chamber	ESPEC	SU-241	92003713	-40°C~90°C	Aug. 05, 2020	Mar. 07, 2021~ Mar. 30, 2021	Aug. 04, 2021	Conducted (TH05-HY)
Programmable Power Supply	GW Instek	GPP-2323	GES906037	0V~64V : 0A~6A	Dec. 15, 2020	Mar. 07, 2021~ Mar. 30, 2021	Dec. 14, 2021	Conducted (TH05-HY)
5G Wireless Test Platform	Keysight	E7515B	MY59321826	FR1 + FR2	Mar. 23, 2021	Mar. 07, 2021~ Mar. 30, 2021	Mar. 22, 2022	Conducted (TH05-HY)



## 6 Uncertainty of Evaluation

### Uncertainty of Radiated Emission Measurement (30 MHz ~ 1000 MHz)

Measuring Uncertainty for a Level of Confidence of 95% ( $U = 2Uc(y)$ )	3.10
---	------

### Uncertainty of Radiated Emission Measurement (1 GHz ~ 18 GHz)

Measuring Uncertainty for a Level of Confidence of 95% ( $U = 2Uc(y)$ )	3.12
---	------

### Uncertainty of Radiated Emission Measurement (18 GHz ~ 40 GHz)

Measuring Uncertainty for a Level of Confidence of 95% ( $U = 2Uc(y)$ )	3.77
---	------





## Appendix A. Test Results of Conducted Test

### Conducted Output Power(Average power & ERP/EIRP)

LTE Band 2 Maximum Average Power [dBm] (GT - LC = 3.4 dB)								
BW [MHz]	RB Size	RB Offset	Mod	Lowest	Middle	Highest	EIRP (dBm)	EIRP (W)
20	1	0	QPSK	25.35	25.47	25.11	28.87	0.7709
20	1	49		25.27	25.43	24.03		
20	1	99		24.70	24.97	24.86		
20	50	0		24.44	24.34	23.62		
20	50	24		24.46	24.66	23.70		
20	50	50		23.81	24.68	24.06		
20	100	0		24.16	24.48	23.72		
20	1	0	16-QAM	24.69	24.31	24.48	28.31	0.6776
20	1	49		24.54	24.86	23.52		
20	1	99		24.01	24.91	24.38		
20	50	0		23.44	23.52	22.88		
20	50	24		23.54	23.67	22.78		
20	50	50		23.14	23.69	23.25		
20	100	0		23.32	23.57	23.04		
20	1	0	64-QAM	22.66	22.34	22.84	26.63	0.4603
20	1	49		22.70	22.95	21.65		
20	1	99		22.18	23.23	22.64		
20	50	0		21.93	21.50	21.07		
20	50	24		21.67	22.02	21.12		
20	50	50		21.21	22.11	21.35		
20	100	0		21.42	21.67	21.13		
20	1	0	256-QAM	20.33	20.36	20.29	23.78	0.2388
20	1	49		20.24	20.22	20.08		
20	1	99		20.31	20.25	20.12		
20	50	0		20.19	20.20	20.19		
20	50	24		20.19	20.30	20.27		
20	50	50		20.30	20.35	20.38		
20	100	0		20.18	20.30	20.18		
Limit	EIRP < 2W			Result			Pass	



LTE Band 2 Maximum Average Power [dBm] (GT - LC = 3.4 dB)								
BW [MHz]	RB Size	RB Offset	Mod	Lowest	Middle	Highest	EIRP (dBm)	EIRP (W)
15	1	0	QPSK	25.30	25.47	25.07	28.87	0.7709
15	1	37		25.26	25.34	24.05		
15	1	74		24.61	24.96	24.77		
15	36	0		24.39	24.32	23.62		
15	36	20		24.42	24.62	23.62		
15	36	39		23.77	24.68	24.02		
15	75	0		24.11	24.42	23.67		
15	1	0	16-QAM	24.69	24.31	24.42	28.22	0.6637
15	1	37		24.47	24.79	23.51		
15	1	74		23.94	24.82	24.30		
15	36	0		23.40	23.51	22.83		
15	36	20		23.53	23.57	22.69		
15	36	39		23.06	23.62	23.21		
15	75	0		23.30	23.48	23.04		
15	1	0	64-QAM	22.66	22.28	22.74	26.61	0.4581
15	1	37		22.63	22.90	22.55		
15	1	74		22.18	23.21	22.55		
15	36	0		21.87	21.44	21.03		
15	36	20		21.64	22.02	21.02		
15	36	39		21.12	22.11	21.28		
15	75	0		21.37	21.66	21.08		
15	1	0	256-QAM	20.14	20.29	20.19	23.7	0.2344
15	1	37		20.05	20.21	20.04		
15	1	74		20.13	20.23	19.93		
15	36	0		20.11	20.09	20.17		
15	36	20		20.19	20.30	20.26		
15	36	39		20.16	20.17	20.21		
15	75	0		19.98	20.17	19.99		
Limit	EIRP < 2W			Result			Pass	



LTE Band 2 Maximum Average Power [dBm] (GT - LC = 3.4 dB)								
BW [MHz]	RB Size	RB Offset	Mod	Lowest	Middle	Highest	EIRP (dBm)	EIRP (W)
10	1	0	QPSK	25.33	25.37	25.11	28.78	0.7551
10	1	25		25.25	25.38	24.05		
10	1	49		24.62	24.87	24.78		
10	25	0		24.44	24.28	23.62		
10	25	12		24.43	24.66	23.66		
10	25	25		23.71	24.60	24.01		
10	50	0		24.14	24.40	23.62		
10	1	0	16-QAM	24.60	24.29	24.41	28.28	0.6730
10	1	25		24.45	24.81	23.47		
10	1	49		24.00	24.88	24.35		
10	25	0		23.34	23.42	22.82		
10	25	12		23.47	23.63	22.77		
10	25	25		23.13	23.66	23.16		
10	50	0		23.23	23.54	23.04		
10	1	0	64-QAM	22.58	22.24	22.80	26.6	0.4571
10	1	25		22.68	22.86	22.05		
10	1	49		22.08	23.20	22.55		
10	25	0		21.87	21.50	21.03		
10	25	12		21.57	21.94	21.02		
10	25	25		21.16	22.02	21.25		
10	50	0		21.39	21.63	21.09		
10	1	0	256-QAM	20.26	20.26	20.18	23.67	0.2328
10	1	25		20.14	20.10	20.01		
10	1	49		20.13	20.08	20.09		
10	25	0		20.15	20.10	20.18		
10	25	12		20.04	20.11	20.21		
10	25	25		20.22	20.25	20.27		
10	50	0		19.99	20.11	20.03		
Limit	EIRP < 2W			Result			Pass	



LTE Band 2 Maximum Average Power [dBm] (GT - LC = 3.4 dB)								
BW [MHz]	RB Size	RB Offset	Mod	Lowest	Middle	Highest	EIRP (dBm)	EIRP (W)
5	1	0	QPSK	25.30	25.44	25.08	28.84	0.7656
5	1	12		25.21	25.42	24.05		
5	1	24		24.68	24.96	24.81		
5	12	0		24.40	24.31	23.60		
5	12	7		24.46	24.63	23.68		
5	12	13		23.75	24.61	24.03		
5	25	0		24.13	24.47	23.66		
5	1	0	16-QAM	24.59	24.29	24.48	28.27	0.6714
5	1	12		24.52	24.77	23.49		
5	1	24		23.94	24.87	24.38		
5	12	0		23.39	23.42	22.84		
5	12	7		23.46	23.67	22.70		
5	12	13		23.13	23.60	23.24		
5	25	0		23.30	23.47	22.95		
5	1	0	64-QAM	22.56	22.27	22.75	26.53	0.4498
5	1	12		22.68	22.87	22.21		
5	1	24		22.13	23.13	22.63		
5	12	0		21.84	21.45	21.00		
5	12	7		21.66	21.96	21.03		
5	12	13		21.14	22.01	21.28		
5	25	0		21.34	21.66	21.06		
5	1	0	256-QAM	20.19	20.18	20.16	23.67	0.2328
5	1	12		20.10	20.16	20.00		
5	1	24		20.17	20.06	20.01		
5	12	0		20.00	20.14	20.08		
5	12	7		20.04	20.18	20.19		
5	12	13		20.10	20.27	20.22		
5	25	0		20.03	20.12	20.14		
Limit	EIRP < 2W			Result			Pass	



LTE Band 2 Maximum Average Power [dBm] (GT - LC = 3.4 dB)								
BW [MHz]	RB Size	RB Offset	Mod	Lowest	Middle	Highest	EIRP (dBm)	EIRP (W)
3	1	0	QPSK	25.31	25.43	25.09	28.83	0.7638
3	1	8		25.17	25.36	24.02		
3	1	14		24.60	24.91	24.82		
3	8	0		24.38	24.34	23.55		
3	8	4		24.44	24.56	23.69		
3	8	7		23.81	24.59	24.00		
3	15	0		24.15	24.47	23.69		
3	1	0	16-QAM	24.65	24.24	24.39	28.26	0.6699
3	1	8		24.54	24.86	23.46		
3	1	14		23.97	24.86	24.36		
3	8	0		23.42	23.49	22.84		
3	8	4		23.52	23.57	22.70		
3	8	7		23.08	23.62	23.20		
3	15	0		23.29	23.54	23.00		
3	1	0	64-QAM	22.63	22.25	22.79	26.59	0.4560
3	1	8		22.69	22.91	22.15		
3	1	14		22.13	23.19	22.63		
3	8	0		21.84	21.41	21.30		
3	8	4		21.58	21.93	21.08		
3	8	7		21.14	22.09	21.28		
3	15	0		21.34	21.61	21.11		
3	1	0	256-QAM	20.20	20.25	20.29	23.69	0.2339
3	1	8		20.04	20.11	20.06		
3	1	14		20.19	20.10	19.97		
3	8	0		20.18	20.02	20.07		
3	8	4		20.02	20.22	20.10		
3	8	7		20.21	20.23	20.25		
3	15	0		20.18	20.13	20.04		
Limit	EIRP < 2W			Result			Pass	



LTE Band 2 Maximum Average Power [dBm] (GT - LC = 3.4 dB)								
BW [MHz]	RB Size	RB Offset	Mod	Lowest	Middle	Highest	EIRP (dBm)	EIRP (W)
1.4	1	0	QPSK	25.32	25.45	25.05	28.85	0.7674
1.4	1	3		25.24	25.42	24.04		
1.4	1	5		24.66	24.96	24.84		
1.4	3	0		25.33	25.41	25.04		
1.4	3	1		25.23	25.38	24.00		
1.4	3	3		24.66	24.88	24.86		
1.4	6	0		24.40	24.30	23.60		
1.4	1	0	16-QAM	24.43	24.63	23.61	28.26	0.6699
1.4	1	3		23.72	24.60	23.96		
1.4	1	5		24.16	24.48	23.66		
1.4	3	0		24.63	24.30	24.38		
1.4	3	1		24.50	24.82	23.48		
1.4	3	3		23.99	24.86	24.35		
1.4	6	0		23.39	23.44	22.78		
1.4	1	0	64-QAM	23.53	23.57	22.68	27.04	0.5058
1.4	1	3		23.14	23.64	23.18		
1.4	1	5		23.27	23.54	22.95		
1.4	3	0		22.62	22.29	22.81		
1.4	3	1		22.62	22.93	22.13		
1.4	3	3		22.12	23.19	22.64		
1.4	6	0		21.87	21.41	21.03		
1.4	1	0	256-QAM	20.22	20.32	20.24	23.78	0.2388
1.4	1	3		20.20	20.22	19.98		
1.4	1	5		20.11	20.22	19.93		
1.4	3	0		20.18	20.14	20.16		
1.4	3	1		20.05	20.19	20.22		
1.4	3	3		20.14	20.29	20.38		
1.4	6	0		20.02	20.13	19.99		
Limit	EIRP < 2W			Result			Pass	



LTE Band 4 Maximum Average Power [dBm] (GT - LC = 3.6 dB)								
BW [MHz]	RB Size	RB Offset	Mod	Lowest	Middle	Highest	EIRP (dBm)	EIRP (W)
20	1	0	QPSK	25.09	25.13	24.50	28.73	0.7464
20	1	49		24.90	24.98	25.04		
20	1	99		25.01	24.96	25.04		
20	50	0		24.13	24.20	24.21		
20	50	24		24.18	24.11	24.24		
20	50	50		24.10	23.97	24.17		
20	100	0		24.12	24.18	24.20		
20	1	0	16-QAM	24.40	24.53	23.85	28.13	0.6501
20	1	49		24.30	24.38	24.38		
20	1	99		24.36	24.16	24.39		
20	50	0		23.14	23.19	23.22		
20	50	24		23.17	23.17	23.25		
20	50	50		23.11	23.18	23.18		
20	100	0		23.15	23.18	23.21		
20	1	0	64-QAM	22.40	23.32	22.01	26.93	0.4932
20	1	49		23.12	22.37	23.24		
20	1	99		23.21	22.13	23.33		
20	50	0		22.18	22.24	21.73		
20	50	24		22.21	21.53	22.25		
20	50	50		22.15	21.25	22.19		
20	100	0		22.21	21.91	22.10		
20	1	0	256-QAM	20.13	19.98	19.68	23.73	0.2360
20	1	49		20.06	19.83	19.61		
20	1	99		20.06	19.94	19.71		
20	50	0		20.09	19.86	19.53		
20	50	24		20.09	19.84	19.57		
20	50	50		19.97	19.87	19.63		
20	100	0		20.10	19.88	19.59		
Limit	EIRP < 1W			Result			Pass	



LTE Band 4 Maximum Average Power [dBm] (GT - LC = 3.6 dB)								
BW [MHz]	RB Size	RB Offset	Mod	Lowest	Middle	Highest	EIRP (dBm)	EIRP (W)
15	1	0	QPSK	25.05	25.03	24.44	28.65	0.7328
15	1	37		24.88	24.90	24.99		
15	1	74		24.95	24.90	24.94		
15	36	0		24.09	24.16	24.11		
15	36	20		24.17	24.06	24.22		
15	36	39		24.06	23.91	24.15		
15	75	0		24.12	24.16	24.18		
15	1	0	16-QAM	24.37	24.52	23.84	28.12	0.6486
15	1	37		24.27	24.33	24.33		
15	1	74		24.31	24.11	24.34		
15	36	0		23.11	23.13	23.19		
15	36	20		23.10	23.13	23.18		
15	36	39		23.10	23.16	23.08		
15	75	0		23.13	23.18	23.13		
15	1	0	64-QAM	22.35	23.23	22.00	26.87	0.4864
15	1	37		23.07	22.33	23.17		
15	1	74		23.19	22.06	23.27		
15	36	0		22.12	22.22	21.64		
15	36	20		22.19	21.49	22.19		
15	36	39		22.09	21.18	22.13		
15	75	0		22.14	21.85	22.02		
15	1	0	256-QAM	19.97	19.90	19.56	23.68	0.2333
15	1	37		20.03	19.68	19.58		
15	1	74		19.94	19.77	19.64		
15	36	0		19.98	19.79	19.44		
15	36	20		20.08	19.79	19.49		
15	36	39		19.95	19.83	19.58		
15	75	0		20.05	19.79	19.41		
Limit	EIRP < 1W			Result			Pass	





LTE Band 4 Maximum Average Power [dBm] (GT - LC = 3.6 dB)								
BW [MHz]	RB Size	RB Offset	Mod	Lowest	Middle	Highest	EIRP (dBm)	EIRP (W)
10	1	0	QPSK	25.09	25.09	24.50	28.69	0.7396
10	1	25		24.86	24.97	24.95		
10	1	49		24.94	24.95	24.95		
10	25	0		24.07	24.17	24.21		
10	25	12		24.14	24.07	24.24		
10	25	25		24.06	23.96	24.16		
10	50	0		24.02	24.17	24.19		
10	1	0	16-QAM	24.31	24.48	23.75	28.08	0.6427
10	1	25		24.23	24.38	24.31		
10	1	49		24.30	24.13	24.36		
10	25	0		23.11	23.17	23.21		
10	25	12		23.15	23.13	23.22		
10	25	25		23.10	23.17	23.14		
10	50	0		23.11	23.12	23.20		
10	1	0	64-QAM	22.35	23.26	22.00	26.88	0.4875
10	1	25		23.12	22.32	23.22		
10	1	49		23.13	22.11	23.28		
10	25	0		22.16	22.23	21.68		
10	25	12		22.21	21.47	22.20		
10	25	25		22.11	21.21	22.09		
10	50	0		22.13	21.84	22.04		
10	1	0	256-QAM	20.02	19.97	19.68	23.67	0.2328
10	1	25		19.96	19.83	19.57		
10	1	49		19.86	19.85	19.68		
10	25	0		20.07	19.78	19.34		
10	25	12		19.94	19.81	19.55		
10	25	25		19.97	19.73	19.62		
10	50	0		19.96	19.68	19.44		
Limit	EIRP < 1W			Result			Pass	



LTE Band 4 Maximum Average Power [dBm] (GT - LC = 3.6 dB)								
BW [MHz]	RB Size	RB Offset	Mod	Lowest	Middle	Highest	EIRP (dBm)	EIRP (W)
5	1	0	QPSK	25.05	25.09	24.46	28.69	0.7396
5	1	12		24.81	24.94	25.00		
5	1	24		24.98	24.92	24.99		
5	12	0		24.10	24.12	24.19		
5	12	7		24.15	24.06	24.23		
5	12	13		24.06	23.92	24.13		
5	25	0		24.12	24.11	24.15		
5	1	0	16-QAM	24.32	24.47	23.81	28.07	0.6412
5	1	12		24.25	24.36	24.32		
5	1	24		24.33	24.08	24.37		
5	12	0		23.06	23.12	23.18		
5	12	7		23.17	23.15	23.20		
5	12	13		23.06	23.12	23.11		
5	25	0		23.06	23.09	23.18		
5	1	0	64-QAM	22.34	23.24	22.01	26.91	0.4909
5	1	12		23.09	22.36	23.18		
5	1	24		23.16	22.07	23.31		
5	12	0		22.13	22.16	21.63		
5	12	7		22.20	21.50	22.23		
5	12	13		22.09	21.17	22.13		
5	25	0		22.11	21.89	22.04		
5	1	0	256-QAM	20.00	19.93	19.66	23.65	0.2317
5	1	12		20.01	19.69	19.59		
5	1	24		20.05	19.83	19.63		
5	12	0		20.05	19.69	19.43		
5	12	7		19.97	19.64	19.41		
5	12	13		19.95	19.67	19.45		
5	25	0		19.91	19.84	19.47		
Limit	EIRP < 1W			Result			Pass	



LTE Band 4 Maximum Average Power [dBm] (GT - LC = 3.6 dB)								
BW [MHz]	RB Size	RB Offset	Mod	Lowest	Middle	Highest	EIRP (dBm)	EIRP (W)
3	1	0	QPSK	24.99	25.03	24.50	28.64	0.7311
3	1	8		24.87	24.88	25.04		
3	1	14		24.99	24.95	24.95		
3	8	0		24.11	24.16	24.11		
3	8	4		24.12	24.03	24.23		
3	8	7		24.00	23.93	24.16		
3	15	0		24.08	24.14	24.11		
3	1	0	16-QAM	24.34	24.52	23.77	28.12	0.6486
3	1	8		24.25	24.34	24.32		
3	1	14		24.34	24.14	24.32		
3	8	0		23.09	23.16	23.22		
3	8	4		23.12	23.14	23.18		
3	8	7		23.07	23.10	23.18		
3	15	0		23.10	23.15	23.12		
3	1	0	64-QAM	22.37	23.24	22.13	26.84	0.4831
3	1	8		23.06	22.35	23.18		
3	1	14		23.15	22.04	23.23		
3	8	0		22.17	22.24	21.68		
3	8	4		22.20	21.52	22.17		
3	8	7		22.12	21.22	22.11		
3	15	0		22.17	21.87	22.10		
3	1	0	256-QAM	20.13	19.83	19.61	23.73	0.2360
3	1	8		19.99	19.66	19.45		
3	1	14		20.01	19.75	19.54		
3	8	0		20.07	19.74	19.36		
3	8	4		19.93	19.75	19.53		
3	8	7		19.86	19.81	19.47		
3	15	0		20.00	19.86	19.58		
Limit	EIRP < 1W			Result			Pass	



LTE Band 4 Maximum Average Power [dBm] (GT - LC = 3.6 dB)								
BW [MHz]	RB Size	RB Offset	Mod	Lowest	Middle	Highest	EIRP (dBm)	EIRP (W)
1.4	1	0	QPSK	25.02	25.10	24.48	28.70	0.7413
1.4	1	3		24.83	24.94	24.94		
1.4	1	5		24.91	24.93	24.94		
1.4	3	0		25.05	25.05	24.43		
1.4	3	1		24.89	24.91	25.04		
1.4	3	3		24.96	24.91	24.94		
1.4	6	0		24.05	24.20	24.12		
1.4	1	0	16-QAM	24.12	24.11	24.16	28.13	0.6501
1.4	1	3		24.01	23.89	24.14		
1.4	1	5		24.07	24.16	24.11		
1.4	3	0		24.30	24.53	23.81		
1.4	3	1		24.25	24.30	24.31		
1.4	3	3		24.30	24.11	24.31		
1.4	6	0		23.09	23.14	23.17		
1.4	1	0	64-QAM	23.15	23.07	23.17	26.93	0.4932
1.4	1	3		23.06	23.18	23.17		
1.4	1	5		23.12	23.11	23.16		
1.4	3	0		22.35	23.25	22.33		
1.4	3	1		23.03	22.31	23.16		
1.4	3	3		23.13	22.13	23.33		
1.4	6	0		22.09	22.20	21.71		
1.4	1	0	256-QAM	19.94	19.96	19.64	23.67	0.2328
1.4	1	3		20.01	19.74	19.54		
1.4	1	5		19.89	19.92	19.56		
1.4	3	0		20.07	19.67	19.45		
1.4	3	1		19.92	19.73	19.57		
1.4	3	3		19.77	19.83	19.61		
1.4	6	0		19.93	19.87	19.39		
Limit	EIRP < 1W			Result			Pass	



LTE Band 5 Maximum Average Power [dBm] (GT - LC = 0.4 dB)								
BW [MHz]	RB Size	RB Offset	Mod	Lowest	Middle	Highest	ERP (dBm)	ERP (W)
10	1	0	QPSK	24.46	24.50	24.47	22.75	0.1884
10	1	25		24.41	24.44	23.43		
10	1	49		24.01	24.46	23.01		
10	25	0		23.53	23.53	23.44		
10	25	12		23.64	23.58	22.84		
10	25	25		23.58	23.62	22.33		
10	50	0		23.63	23.57	22.99		
10	1	0	16-QAM	23.86	23.86	23.84	22.11	0.1626
10	1	25		23.81	23.78	22.90		
10	1	49		23.21	23.81	22.23		
10	25	0		22.56	22.53	22.53		
10	25	12		22.63	22.61	21.95		
10	25	25		22.60	22.63	21.47		
10	50	0		22.63	22.60	21.93		
10	1	0	64-QAM	22.40	21.95	22.36	20.65	0.1161
10	1	25		21.97	21.84	21.09		
10	1	49		21.05	22.01	21.06		
10	25	0		20.89	20.64	20.63		
10	25	12		20.79	20.77	20.33		
10	25	25		20.64	20.92	20.53		
10	50	0		20.79	20.68	20.09		
10	1	0	256-QAM	19.54	19.48	19.58	18.05	0.0638
10	1	25		19.57	19.49	19.53		
10	1	49		19.76	19.62	19.80		
10	25	0		19.57	19.55	19.57		
10	25	12		19.47	19.51	19.53		
10	25	25		19.53	19.48	19.62		
10	50	0		19.46	19.44	19.58		
Limit	ERP < 7W			Result			Pass	



LTE Band 5 Maximum Average Power [dBm] (GT - LC = 0.4 dB)								
BW [MHz]	RB Size	RB Offset	Mod	Lowest	Middle	Highest	ERP (dBm)	ERP (W)
5	1	0	QPSK	24.39	24.46	24.39	22.71	0.1866
5	1	12		24.34	24.34	23.43		
5	1	24		24.01	24.37	23.13		
5	12	0		23.46	23.47	23.43		
5	12	7		23.60	23.51	22.75		
5	12	13		23.58	23.59	22.25		
5	25	0		23.63	23.53	22.96		
5	1	0	16-QAM	23.79	23.76	23.77	22.04	0.1600
5	1	12		23.74	23.68	22.83		
5	1	24		23.19	23.73	22.16		
5	12	0		22.54	22.47	22.51		
5	12	7		22.60	22.51	21.93		
5	12	13		22.54	22.57	21.41		
5	25	0		22.54	22.56	21.88		
5	1	0	64-QAM	22.30	21.94	22.29	20.55	0.1135
5	1	12		21.93	21.77	21.18		
5	1	24		21.02	21.99	21.03		
5	12	0		20.87	20.56	20.61		
5	12	7		20.69	20.75	20.24		
5	12	13		20.56	20.86	20.53		
5	25	0		20.74	20.64	20.09		
5	1	0	256-QAM	19.52	19.37	19.42	17.94	0.0622
5	1	12		19.52	19.42	19.34		
5	1	24		19.62	19.57	19.69		
5	12	0		19.54	19.42	19.42		
5	12	7		19.32	19.49	19.51		
5	12	13		19.43	19.32	19.58		
5	25	0		19.41	19.36	19.46		
Limit	ERP < 7W			Result			Pass	



LTE Band 5 Maximum Average Power [dBm] (GT - LC = 0.4 dB)								
BW [MHz]	RB Size	RB Offset	Mod	Lowest	Middle	Highest	ERP (dBm)	ERP (W)
3	1	0	QPSK	24.43	24.41	24.41	22.68	0.1854
3	1	8		24.34	24.35	23.38		
3	1	14		23.91	24.36	23.00		
3	8	0		23.43	23.48	23.43		
3	8	4		23.62	23.49	22.84		
3	8	7		23.49	23.58	22.29		
3	15	0		23.63	23.54	22.93		
3	1	0	16-QAM	23.78	23.80	23.74	22.05	0.1603
3	1	8		23.75	23.71	22.89		
3	1	14		23.15	23.79	22.18		
3	8	0		22.55	22.49	22.51		
3	8	4		22.62	22.51	21.89		
3	8	7		22.52	22.61	21.44		
3	15	0		22.55	22.54	21.88		
3	1	0	64-QAM	22.32	21.89	22.32	20.57	0.1140
3	1	8		21.95	21.77	21.12		
3	1	14		21.16	21.96	21.05		
3	8	0		20.86	20.59	20.53		
3	8	4		20.75	20.73	20.31		
3	8	7		20.58	20.90	20.50		
3	15	0		20.73	20.58	20.02		
3	1	0	256-QAM	19.45	19.40	19.57	17.9	0.0617
3	1	8		19.52	19.35	19.52		
3	1	14		19.64	19.58	19.65		
3	8	0		19.46	19.35	19.38		
3	8	4		19.29	19.37	19.33		
3	8	7		19.38	19.37	19.58		
3	15	0		19.38	19.29	19.44		
Limit	ERP < 7W			Result			Pass	



LTE Band 5 Maximum Average Power [dBm] (GT - LC = 0.4 dB)								
BW [MHz]	RB Size	RB Offset	Mod	Lowest	Middle	Highest	ERP (dBm)	ERP (W)
1.4	1	0	QPSK	24.42	24.44	24.47	22.72	0.1871
1.4	1	3		24.31	24.37	23.41		
1.4	1	5		24.01	24.39	23.11		
1.4	3	0		24.36	24.41	24.43		
1.4	3	1		24.36	24.37	23.40		
1.4	3	3		23.94	24.45	23.18		
1.4	6	0		23.49	23.53	23.38		
1.4	1	0	16-QAM	23.55	23.50	22.84	22.09	0.1618
1.4	1	3		23.56	23.58	22.32		
1.4	1	5		23.53	23.48	22.99		
1.4	3	0		23.78	23.84	23.82		
1.4	3	1		23.72	23.71	22.84		
1.4	3	3		23.15	23.71	22.14		
1.4	6	0		22.54	22.45	22.47		
1.4	1	0	64-QAM	22.53	22.51	21.87	20.84	0.1213
1.4	1	3		22.51	22.59	21.44		
1.4	1	5		22.54	22.51	21.86		
1.4	3	0		22.34	21.95	22.35		
1.4	3	1		21.93	21.77	21.08		
1.4	3	3		21.01	21.94	21.05		
1.4	6	0		20.85	20.60	20.58		
1.4	1	0	256-QAM	19.47	19.35	19.39	17.99	0.0630
1.4	1	3		19.45	19.29	19.33		
1.4	1	5		19.74	19.58	19.69		
1.4	3	0		19.47	19.37	19.53		
1.4	3	1		19.33	19.47	19.45		
1.4	3	3		19.40	19.33	19.50		
1.4	6	0		19.39	19.40	19.43		
Limit	ERP < 7W			Result			Pass	





LTE Band 13 Maximum Average Power [dBm] (GT - LC = -0.2 dB)								
BW [MHz]	RB Size	RB Offset	Mod	Lowest	Middle	Highest	ERP (dBm)	ERP (W)
10	1	0	QPSK		23.47		21.12	0.1294
10	1	25			23.41			
10	1	49			23.29			
10	25	0			22.42			
10	25	12			22.59			
10	25	25			22.30			
10	50	0			22.31			
10	1	0	16-QAM		22.63		20.28	0.1067
10	1	25			22.56			
10	1	49			22.48			
10	25	0			21.42			
10	25	12			21.63			
10	25	25			21.37			
10	50	0			21.43			
10	1	0	64-QAM		21.32		19.27	0.0845
10	1	25			21.46			
10	1	49			21.62			
10	25	0			20.27			
10	25	12			20.60			
10	25	25			20.47			
10	50	0			20.52			
10	1	0	256-QAM		19.95		17.6	0.0575
10	1	25			19.76			
10	1	49			19.70			
10	25	0			19.78			
10	25	12			19.71			
10	25	25			19.69			
10	50	0			19.78			
Limit	ERP < 3W			Result			Pass	



LTE Band 13 Maximum Average Power [dBm] (GT - LC = -0.2 dB)								
BW [MHz]	RB Size	RB Offset	Mod	Lowest	Middle	Highest	ERP (dBm)	ERP (W)
5	1	0	QPSK	23.42	23.42	23.40	21.07	0.1279
5	1	12		23.33	23.35	23.35		
5	1	24		23.22	23.20	23.28		
5	12	0		22.42	22.42	22.32		
5	12	7		22.51	22.54	22.59		
5	12	13		22.28	22.20	22.27		
5	25	0		22.30	22.26	22.21		
5	1	0	16-QAM	22.57	22.63	22.56	20.28	0.1067
5	1	12		22.46	22.51	22.53		
5	1	24		22.48	22.42	22.47		
5	12	0		21.39	21.33	21.37		
5	12	7		21.55	21.59	21.61		
5	12	13		21.33	21.33	21.34		
5	25	0		21.38	21.36	21.33		
5	1	0	64-QAM	21.25	21.32	21.28	19.26	0.0843
5	1	12		21.45	21.40	21.46		
5	1	24		21.52	21.56	21.61		
5	12	0		20.18	20.19	20.18		
5	12	7		20.55	20.53	20.50		
5	12	13		20.39	20.47	20.43		
5	25	0		20.42	20.51	20.43		
5	1	0	256-QAM	20.04	19.95	20.13	17.78	0.0600
5	1	12		19.86	19.76	19.89		
5	1	24		19.89	19.70	19.63		
5	12	0		19.60	19.78	19.76		
5	12	7		19.89	19.71	19.72		
5	12	13		19.75	19.69	19.80		
5	25	0		19.81	19.78	19.96		
Limit	ERP < 3W			Result			Pass	



LTE Band 66 Maximum Average Power [dBm] (GT - LC = 3.8 dB)								
BW [MHz]	RB Size	RB Offset	Mod	Lowest	Middle	Highest	EIRP (dBm)	EIRP (W)
20	1	0	QPSK	25.00	25.06	25.35	29.15	0.8222
20	1	49		25.08	24.96	24.57		
20	1	99		25.12	25.13	25.13		
20	50	0		24.20	23.63	23.74		
20	50	24		24.29	24.30	23.75		
20	50	50		24.23	24.25	24.18		
20	100	0		24.25	24.18	23.55		
20	1	0	16-QAM	24.53	23.33	24.75	28.55	0.7161
20	1	49		24.44	24.44	23.33		
20	1	99		24.42	24.47	24.50		
20	50	0		23.22	22.91	23.15		
20	50	24		23.30	23.33	23.04		
20	50	50		23.28	23.28	23.32		
20	100	0		23.26	23.28	23.25		
20	1	0	64-QAM	22.14	22.28	23.45	27.25	0.5309
20	1	49		23.34	22.83	22.20		
20	1	99		22.74	23.42	23.04		
20	50	0		22.22	21.19	21.40		
20	50	24		22.32	21.95	21.10		
20	50	50		22.27	22.30	21.49		
20	100	0		22.19	21.66	21.49		
20	1	0	256-QAM	19.81	19.49	20.01	24.56	0.2858
20	1	49		20.03	19.79	20.41		
20	1	99		20.44	20.16	20.76		
20	50	0		20.21	19.89	20.36		
20	50	24		20.22	19.98	20.40		
20	50	50		20.26	19.95	20.53		
20	100	0		20.15	19.93	20.54		
Limit	EIRP < 1W			Result			Pass	



LTE Band 66 Maximum Average Power [dBm] (GT - LC = 3.8 dB)								
BW [MHz]	RB Size	RB Offset	Mod	Lowest	Middle	Highest	EIRP (dBm)	EIRP (W)
15	1	0	QPSK	24.91	25.03	25.30	29.10	0.8128
15	1	37		25.08	24.96	24.53		
15	1	74		25.06	25.08	25.08		
15	36	0		24.16	23.54	23.64		
15	36	20		24.27	24.22	23.75		
15	36	39		24.18	24.25	24.17		
15	75	0		24.21	24.09	23.46		
15	1	0	16-QAM	24.46	23.26	24.68	28.48	0.7047
15	1	37		24.39	24.41	23.28		
15	1	74		24.33	24.42	24.49		
15	36	0		23.22	22.90	23.10		
15	36	20		23.20	23.29	22.98		
15	36	39		23.18	23.22	23.28		
15	75	0		23.25	23.19	23.19		
15	1	0	64-QAM	22.12	22.19	23.44	27.24	0.5297
15	1	37		23.24	22.79	22.20		
15	1	74		22.73	23.35	22.98		
15	36	0		22.12	21.18	21.31		
15	36	20		22.29	21.91	21.10		
15	36	39		22.18	22.29	21.48		
15	75	0		22.09	21.63	21.45		
15	1	0	256-QAM	19.80	19.32	19.83	24.47	0.2799
15	1	37		20.01	19.76	20.26		
15	1	74		20.37	20.03	20.67		
15	36	0		20.17	19.70	20.36		
15	36	20		20.03	19.92	20.31		
15	36	39		20.15	19.76	20.43		
15	75	0		20.01	19.76	20.48		
Limit	EIRP < 1W			Result			Pass	



LTE Band 66 Maximum Average Power [dBm] (GT - LC = 3.8 dB)								
BW [MHz]	RB Size	RB Offset	Mod	Lowest	Middle	Highest	EIRP (dBm)	EIRP (W)
10	1	0	QPSK	24.91	25.02	25.31	29.11	0.8147
10	1	25		25.07	24.87	24.57		
10	1	49		25.02	25.12	25.11		
10	25	0		24.14	23.60	23.68		
10	25	12		24.21	24.24	23.73		
10	25	25		24.14	24.16	24.14		
10	50	0		24.21	24.17	23.51		
10	1	0	16-QAM	24.45	23.32	24.68	28.48	0.7047
10	1	25		24.37	24.44	23.32		
10	1	49		24.40	24.45	24.42		
10	25	0		23.22	22.87	23.06		
10	25	12		23.23	23.25	22.97		
10	25	25		23.18	23.19	23.30		
10	50	0		23.17	23.22	23.23		
10	1	0	64-QAM	22.06	22.25	23.41	27.21	0.5260
10	1	25		23.28	22.82	22.14		
10	1	49		22.71	23.41	23.02		
10	25	0		22.19	21.13	21.40		
10	25	12		22.25	21.85	21.08		
10	25	25		22.24	22.29	21.42		
10	50	0		22.15	21.56	21.48		
10	1	0	256-QAM	19.77	19.32	19.91	24.48	0.2805
10	1	25		19.91	19.74	20.27		
10	1	49		20.27	20.12	20.68		
10	25	0		20.13	19.70	20.20		
10	25	12		20.05	19.90	20.20		
10	25	25		20.25	19.78	20.46		
10	50	0		20.14	19.92	20.43		
Limit	EIRP < 1W			Result			Pass	



LTE Band 66 Maximum Average Power [dBm] (GT - LC = 3.8 dB)								
BW [MHz]	RB Size	RB Offset	Mod	Lowest	Middle	Highest	EIRP (dBm)	EIRP (W)
5	1	0	QPSK	24.94	25.02	25.32	29.12	0.8166
5	1	12		25.08	24.94	24.53		
5	1	24		25.08	25.10	25.09		
5	12	0		24.11	23.55	23.67		
5	12	7		24.22	24.22	23.66		
5	12	13		24.16	24.21	24.08		
5	25	0		24.15	24.09	23.47		
5	1	0	16-QAM	24.43	23.32	24.75	28.55	0.7161
5	1	12		24.40	24.34	23.33		
5	1	24		24.34	24.40	24.41		
5	12	0		23.14	22.87	23.11		
5	12	7		23.22	23.27	22.97		
5	12	13		23.18	23.26	23.25		
5	25	0		23.26	23.18	23.18		
5	1	0	64-QAM	22.04	22.25	23.36	27.16	0.5200
5	1	12		23.24	22.79	22.14		
5	1	24		22.69	23.34	22.96		
5	12	0		22.19	21.09	21.35		
5	12	7		22.32	21.90	21.00		
5	12	13		22.21	22.29	21.49		
5	25	0		22.10	21.56	21.48		
5	1	0	256-QAM	19.72	19.41	19.81	24.46	0.2793
5	1	12		19.96	19.76	20.33		
5	1	24		20.38	20.08	20.66		
5	12	0		20.13	19.79	20.34		
5	12	7		20.16	19.92	20.35		
5	12	13		20.15	19.85	20.43		
5	25	0		20.12	19.92	20.52		
Limit	EIRP < 1W			Result			Pass	



LTE Band 66 Maximum Average Power [dBm] (GT - LC = 3.8 dB)								
BW [MHz]	RB Size	RB Offset	Mod	Lowest	Middle	Highest	EIRP (dBm)	EIRP (W)
3	1	0	QPSK	24.98	25.04	25.31	29.11	0.8147
3	1	8		25.02	24.90	24.51		
3	1	14		25.05	25.08	25.03		
3	8	0		24.20	23.59	23.67		
3	8	4		24.27	24.28	23.74		
3	8	7		24.16	24.16	24.16		
3	15	0		24.25	24.18	23.48		
3	1	0	16-QAM	24.47	23.32	24.70	28.50	0.7079
3	1	8		24.44	24.40	23.27		
3	1	14		24.34	24.44	24.44		
3	8	0		23.12	22.89	23.05		
3	8	4		23.23	23.31	22.96		
3	8	7		23.28	23.26	23.30		
3	15	0		23.19	23.27	23.22		
3	1	0	64-QAM	22.11	22.24	23.44	27.24	0.5297
3	1	8		23.30	22.73	22.13		
3	1	14		22.66	23.33	22.97		
3	8	0		22.14	21.10	21.32		
3	8	4		22.27	21.89	21.05		
3	8	7		22.25	22.26	21.47		
3	15	0		22.10	21.57	21.46		
3	1	0	256-QAM	19.61	19.39	19.96	24.56	0.2858
3	1	8		19.83	19.70	20.35		
3	1	14		20.33	20.15	20.76		
3	8	0		20.17	19.75	20.20		
3	8	4		20.22	19.89	20.40		
3	8	7		20.14	19.93	20.38		
3	15	0		20.04	19.77	20.53		
Limit	EIRP < 1W			Result			Pass	



LTE Band 66 Maximum Average Power [dBm] (GT - LC = 3.8 dB)								
BW [MHz]	RB Size	RB Offset	Mod	Lowest	Middle	Highest	EIRP (dBm)	EIRP (W)
1.4	1	0	QPSK	25.00	25.05	25.26	29.08	0.8091
1.4	1	3		25.01	24.88	24.53		
1.4	1	5		25.11	25.10	25.08		
1.4	3	0		24.93	24.98	25.28		
1.4	3	1		25.00	24.89	24.47		
1.4	3	3		25.05	25.06	25.13		
1.4	6	0		24.16	23.54	23.74		
1.4	1	0	16-QAM	24.22	24.26	23.73	28.50	0.7079
1.4	1	3		24.13	24.24	24.16		
1.4	1	5		24.25	24.09	23.48		
1.4	3	0		24.50	23.25	24.70		
1.4	3	1		24.37	24.36	23.27		
1.4	3	3		24.40	24.37	24.41		
1.4	6	0		23.21	22.85	23.08		
1.4	1	0	64-QAM	23.22	23.23	22.96	27.24	0.5297
1.4	1	3		23.20	23.24	23.32		
1.4	1	5		23.22	23.19	23.21		
1.4	3	0		22.06	22.24	23.44		
1.4	3	1		23.32	22.77	22.12		
1.4	3	3		22.74	23.42	22.94		
1.4	6	0		22.14	21.13	21.40		
1.4	1	0	256-QAM	19.79	19.43	19.93	24.40	0.2754
1.4	1	3		19.91	19.72	20.23		
1.4	1	5		20.38	20.09	20.60		
1.4	3	0		20.20	19.69	20.18		
1.4	3	1		20.13	19.98	20.21		
1.4	3	3		20.11	19.93	20.38		
1.4	6	0		19.99	19.83	20.37		
Limit	EIRP < 1W			Result			Pass	





LTE Band 5B_CA Maximum Average Power [dBm] (GT - LC = 0.4 dB)										
BW [MHz]	PCC		SCC		Mod	Lowest	Middle	Highest	ERP (dBm)	ERP (W)
	RB Size	RB Offset	RB Size	RB Offset						
10+10	50	0	50	0	QPSK	22.55	22.14	21.99	23.20	0.2089
10+10	1	0	1	49		12.00	12.04	12.32		
10+10	1	49	1	0		24.22	24.38	24.95		
10+10	50	0	50	0	16-QAM	21.61	21.37	21.57	22.30	0.1698
10+10	1	0	1	49		12.47	12.52	12.83		
10+10	1	49	1	0		23.64	23.68	24.05		
10+10	50	0	50	0	64-QAM	20.71	20.41	20.58	19.35	0.0861
10+10	1	0	1	49		12.37	12.33	12.64		
10+10	1	49	1	0		20.64	20.63	21.10		
10+10	50	0	50	0	256-QAM	19.84	19.47	19.72	18.59	0.0723
10+10	1	0	1	49		11.04	11.37	11.44		
10+10	1	49	1	0		19.38	20.04	20.34		
10+5	50	0	25	0	QPSK	22.66	22.63	21.97	23.19	0.2084
10+5	1	0	1	24		12.55	12.84	12.37		
10+5	1	49	1	0		24.09	24.94	24.06		
10+5	50	0	25	0	16-QAM	21.95	21.85	21.61	22.62	0.1828
10+5	1	0	1	24		13.05	13.30	12.92		
10+5	1	49	1	0		23.38	24.37	23.08		
10+5	50	0	25	0	64-QAM	21.02	20.90	20.60	19.62	0.0916
10+5	1	0	1	24		12.86	13.04	12.75		
10+5	1	49	1	0		20.42	21.37	20.13		
10+5	50	0	25	0	256-QAM	20.03	20.00	19.80	18.64	0.0731
10+5	1	0	1	24		11.60	12.06	12.12		
10+5	1	49	1	0		19.12	20.39	19.03		
5+10	25	0	50	0	QPSK	22.69	22.84	22.19	22.77	0.1892
5+10	1	0	1	49		10.92	12.80	12.34		
5+10	1	24	1	0		24.52	24.45	24.44		
5+10	25	0	50	0	16-QAM	21.87	21.91	21.55	22.21	0.1663
5+10	1	0	1	49		11.43	13.34	12.88		
5+10	1	24	1	0		23.91	23.81	23.96		
5+10	25	0	50	0	64-QAM	20.87	20.95	20.52	19.33	0.0857
5+10	1	0	1	49		11.22	13.11	12.70		
5+10	1	24	1	0		20.99	20.76	21.08		
5+10	25	0	50	0	256-QAM	20.12	19.87	19.92	18.58	0.0721
5+10	1	0	1	49		11.61	12.06	12.22		
5+10	1	24	1	0		19.70	20.00	20.33		
Limit	ERP < 7W				Result				Pass	



LTE Band 5B_CA Maximum Average Power [dBm] (GT - LC = 0.4 dB)										
BW [MHz]	PCC		SCC		Mod	Lowest	Middle	Highest	ERP (dBm)	ERP (W)
	RB Size	RB Offset	RB Size	RB Offset						
5+3	25	0	15	0	QPSK	22.58	22.55	21.42	20.83	0.1211
5+3	1	0	1	14		10.39	11.10	11.18		
5+3	1	24	1	0		22.26	22.33	20.65		
5+3	25	0	15	0	16-QAM	21.56	21.63	20.62	20.03	0.1007
5+3	1	0	1	14		10.91	11.68	11.75		
5+3	1	24	1	0		21.61	21.78	20.11		
5+3	25	0	15	0	64-QAM	20.58	20.61	19.85	18.86	0.0769
5+3	1	0	1	14		10.82	11.45	11.58		
5+3	1	24	1	0		20.49	20.48	19.03		
5+3	25	0	15	0	256-QAM	19.41	19.62	18.80	17.87	0.0612
5+3	1	0	1	14		9.66	10.35	10.41		
5+3	1	24	1	0		19.30	19.45	17.92		
3+5	15	0	25	0	QPSK	22.94	22.54	21.86	21.19	0.1315
3+5	1	0	1	24		10.48	12.18	12.07		
3+5	1	14	1	0		22.70	22.87	21.44		
3+5	15	0	25	0	16-QAM	21.88	21.65	21.00	20.60	0.1148
3+5	1	0	1	24		11.01	12.70	12.54		
3+5	1	14	1	0		22.18	22.35	20.83		
3+5	15	0	25	0	64-QAM	20.90	20.72	20.11	19.50	0.0891
3+5	1	0	1	24		11.04	12.51	12.41		
3+5	1	14	1	0		21.07	21.25	19.68		
3+5	15	0	25	0	256-QAM	19.85	19.71	18.90	18.48	0.0705
3+5	1	0	1	24		9.92	11.41	11.30		
3+5	1	14	1	0		19.92	20.23	18.66		
Limit	ERP < 7W					Result			Pass	



LTE Band 66B_CA Maximum Average Power [dBm] (GT - LC = 3.8 dB)										
BW [MHz]	PCC		SCC		Mod	Lowest	Middle	Highest	EIRP (dBm)	EIRP (W)
	RB Size	RB Offset	RB Size	RB Offset						
10+10	50	0	50	0	QPSK	23.57	23.49	22.38	29.40	0.8710
10+10	1	0	1	49		15.01	15.08	15.16		
10+10	1	49	1	0		25.41	25.60	23.43		
10+10	50	0	50	0	16-QAM	22.63	22.51	21.95	28.86	0.7691
10+10	1	0	1	49		15.54	15.52	15.53		
10+10	1	49	1	0		24.91	25.06	22.96		
10+10	50	0	50	0	64-QAM	22.13	22.61	21.08	27.42	0.5521
10+10	1	0	1	49		15.29	15.46	15.49		
10+10	1	49	1	0		23.02	23.62	20.14		
10+10	50	0	50	0	256-QAM	20.51	20.70	20.28	24.51	0.2825
10+10	1	0	1	49		15.26	15.12	15.35		
10+10	1	49	1	0		20.71	20.67	19.71		
15+5	75	0	25	0	QPSK	23.70	23.76	22.49	29.30	0.8511
15+5	1	0	1	24		15.10	15.19	14.82		
15+5	1	74	1	0		25.50	25.19	24.85		
15+5	75	0	25	0	16-QAM	22.71	22.80	21.95	28.89	0.7745
15+5	1	0	1	24		15.59	15.72	15.32		
15+5	1	74	1	0		25.09	24.55	24.20		
15+5	75	0	25	0	64-QAM	21.95	22.10	21.17	26.76	0.4742
15+5	1	0	1	24		15.47	15.48	15.36		
15+5	1	74	1	0		22.96	21.68	21.33		
15+5	75	0	25	0	256-QAM	20.29	20.31	20.31	24.33	0.2710
15+5	1	0	1	24		15.00	14.95	14.98		
15+5	1	74	1	0		20.52	20.53	20.27		
5+15	25	0	75	0	QPSK	23.31	23.32	23.24	28.89	0.7745
5+15	1	0	1	74		15.11	14.82	14.86		
5+15	1	24	1	0		25.04	25.09	25.06		
5+15	25	0	75	0	16-QAM	22.43	22.35	22.42	28.71	0.7430
5+15	1	0	1	74		15.60	15.33	15.28		
5+15	1	24	1	0		24.91	24.60	24.57		
5+15	25	0	75	0	64-QAM	21.63	22.36	22.15	27.22	0.5272
5+15	1	0	1	74		15.56	15.14	15.16		
5+15	1	24	1	0		22.46	23.42	21.65		
5+15	25	0	75	0	256-QAM	20.33	20.25	20.32	24.22	0.2642
5+15	1	0	1	74		15.03	14.95	15.01		
5+15	1	24	1	0		20.34	20.39	20.42		
Limit	EIRP < 1W					Result			Pass	



LTE Band 66B_CA Maximum Average Power [dBm] (GT - LC = 3.8 dB)										
BW [MHz]	PCC		SCC		Mod	Lowest	Middle	Highest	EIRP (dBm)	EIRP (W)
	RB Size	RB Offset	RB Size	RB Offset						
10+5	50	0	25	0	QPSK	23.19	23.63	23.16	28.85	0.7674
10+5	1	0	1	24		15.16	15.55	15.18		
10+5	1	49	1	0		24.94	25.05	24.33		
10+5	50	0	25	0	16-QAM	22.25	22.67	22.25	28.40	0.6918
10+5	1	0	1	24		15.63	16.03	15.54		
10+5	1	49	1	0		24.57	24.60	23.90		
10+5	50	0	25	0	64-QAM	22.04	22.68	21.41	27.32	0.5395
10+5	1	0	1	24		15.38	15.90	15.45		
10+5	1	49	1	0		23.02	23.52	21.06		
10+5	50	0	25	0	256-QAM	20.27	20.29	20.34	24.27	0.2673
10+5	1	0	1	24		15.42	15.32	15.56		
10+5	1	49	1	0		20.35	20.47	20.37		
5+10	25	0	50	0	QPSK	23.17	23.65	22.55	29.11	0.8147
5+10	1	0	1	49		15.13	15.63	15.64		
5+10	1	24	1	0		25.00	25.31	23.93		
5+10	25	0	50	0	16-QAM	22.21	22.70	21.93	28.48	0.7047
5+10	1	0	1	49		15.58	16.06	16.24		
5+10	1	24	1	0		24.54	24.68	23.29		
5+10	25	0	50	0	64-QAM	21.80	22.63	21.00	26.95	0.4955
5+10	1	0	1	49		15.49	16.00	16.00		
5+10	1	24	1	0		21.97	23.15	20.33		
5+10	25	0	50	0	256-QAM	20.39	20.59	20.11	24.46	0.2793
5+10	1	0	1	49		15.62	15.76	15.95		
5+10	1	24	1	0		20.66	20.52	19.42		
5+5	25	0	25	0	QPSK	22.68	23.17	22.53	28.97	0.7889
5+5	1	0	1	24		15.16	14.99	15.54		
5+5	1	24	1	0		24.93	25.17	24.94		
5+5	25	0	25	0	16-QAM	21.70	22.24	21.45	28.50	0.7079
5+5	1	0	1	24		15.46	14.98	15.54		
5+5	1	24	1	0		24.53	24.70	24.36		
5+5	25	0	25	0	64-QAM	20.91	22.15	20.48	26.94	0.4943
5+5	1	0	1	24		15.39	15.00	15.48		
5+5	1	24	1	0		21.73	23.14	21.74		
5+5	25	0	25	0	256-QAM	19.93	20.26	19.59	24.35	0.2723
5+5	1	0	1	24		15.23	15.01	15.49		
5+5	1	24	1	0		20.55	20.41	19.95		
Limit	EIRP < 1W					Result			Pass	



LTE Band 66C_CA Maximum Average Power [dBm] (GT - LC = 3.8 dB)										
BW [MHz]	PCC		SCC		Mod	Lowest	Middle	Highest	EIRP (dBm)	EIRP (W)
	RB Size	RB Offset	RB Size	RB Offset						
20+20	100	0	100	0	QPSK	22.76	23.55	22.96	29.60	0.9120
20+20	1	0	1	99		17.20	15.58	15.85		
20+20	1	99	1	0		25.05	25.80	24.63		
20+20	100	0	100	0	16-QAM	22.20	22.48	22.34	29.21	0.8337
20+20	1	0	1	99		17.58	16.06	16.38		
20+20	1	99	1	0		24.43	25.41	24.40		
20+20	100	0	100	0	64-QAM	21.62	21.42	21.37	26.73	0.4710
20+20	1	0	1	99		17.36	16.04	16.15		
20+20	1	99	1	0		21.95	22.93	22.00		
20+20	100	0	100	0	256-QAM	20.46	20.24	20.28	24.90	0.3090
20+20	1	0	1	99		16.40	14.97	14.81		
20+20	1	99	1	0		20.33	21.04	21.10		
20+15	100	0	75	0	QPSK	22.66	23.81	23.38	29.20	0.8318
20+15	1	0	1	74		17.10	16.21	16.06		
20+15	1	74	1	0		24.75	24.77	25.40		
20+15	100	0	75	0	16-QAM	22.27	22.92	22.62	28.64	0.7311
20+15	1	0	1	74		17.70	16.56	16.39		
20+15	1	74	1	0		24.32	24.40	24.84		
20+15	100	0	75	0	64-QAM	21.41	22.08	21.76	26.19	0.4159
20+15	1	0	1	74		17.26	16.43	16.21		
20+15	1	74	1	0		21.69	21.68	22.39		
20+15	100	0	75	0	256-QAM	20.34	20.78	20.60	24.58	0.2871
20+15	1	0	1	74		16.50	15.41	14.96		
20+15	1	74	1	0		20.59	20.66	20.31		
15+20	75	0	100	0	QPSK	23.11	23.60	23.35	29.51	0.8933
15+20	1	0	1	99		16.30	16.19	17.23		
15+20	1	74	1	0		25.39	25.71	24.80		
15+20	75	0	100	0	16-QAM	22.28	22.52	22.64	29.42	0.8750
15+20	1	0	1	99		16.59	16.54	17.58		
15+20	1	74	1	0		24.66	25.62	24.25		
15+20	75	0	100	0	64-QAM	21.40	21.47	21.67	26.76	0.4742
15+20	1	0	1	99		16.50	16.39	17.38		
15+20	1	74	1	0		22.35	22.96	21.78		
15+20	75	0	100	0	256-QAM	20.21	20.55	20.81	25.05	0.3199
15+20	1	0	1	99		14.97	14.81	16.07		
15+20	1	74	1	0		21.09	21.25	20.91		
Limit	EIRP < 1W					Result			Pass	



LTE Band 66C_CA Maximum Average Power [dBm] (GT - LC = 3.8 dB)										
BW [MHz]	PCC		SCC		Mod	Lowest	Middle	Highest	EIRP (dBm)	EIRP (W)
	RB Size	RB Offset	RB Size	RB Offset						
20+10	100	0	50	0	QPSK	22.47	23.43	22.23	29.03	0.7998
20+10	1	0	1	49		16.34	16.67	17.45		
20+10	1	99	1	0		24.71	25.23	23.10		
20+10	100	0	50	0	16-QAM	21.85	22.45	22.02	28.27	0.6714
20+10	1	0	1	49		16.65	17.05	17.97		
20+10	1	99	1	0		24.06	24.47	22.41		
20+10	100	0	50	0	64-QAM	20.94	21.58	20.93	25.77	0.3776
20+10	1	0	1	49		16.49	16.73	17.79		
20+10	1	99	1	0		21.45	21.97	19.37		
20+10	100	0	50	0	256-QAM	19.90	20.51	19.95	24.80	0.3020
20+10	1	0	1	49		14.98	15.26	16.65		
20+10	1	99	1	0		20.48	21.00	18.17		
10+20	50	0	100	0	QPSK	23.70	23.86	23.25	29.50	0.8913
10+20	1	0	1	99		16.63	16.68	17.63		
10+20	1	49	1	0		25.68	25.70	24.81		
10+20	50	0	100	0	16-QAM	22.47	22.65	22.44	28.93	0.7816
10+20	1	0	1	99		16.88	17.00	18.13		
10+20	1	49	1	0		25.09	25.13	24.16		
10+20	50	0	100	0	64-QAM	21.73	21.60	21.59	26.42	0.4385
10+20	1	0	1	99		16.72	16.87	17.73		
10+20	1	49	1	0		22.36	22.62	21.55		
10+20	50	0	100	0	256-QAM	20.51	20.66	20.55	25.08	0.3221
10+20	1	0	1	99		15.26	15.33	16.73		
10+20	1	49	1	0		21.23	21.28	20.56		
20+5	100	0	25	0	QPSK	22.51	22.56	22.83	28.30	0.6761
20+5	1	0	1	24		16.44	17.15	17.20		
20+5	1	99	1	0		24.50	23.81	23.58		
20+5	100	0	25	0	16-QAM	21.54	21.44	22.15	27.74	0.5943
20+5	1	0	1	24		16.65	17.48	17.96		
20+5	1	99	1	0		23.94	23.06	22.78		
20+5	100	0	25	0	64-QAM	21.01	20.39	21.24	25.23	0.3334
20+5	1	0	1	24		16.53	17.22	16.87		
20+5	1	99	1	0		21.43	20.25	19.65		
20+5	100	0	25	0	256-QAM	19.91	19.36	20.18	24.26	0.2667
20+5	1	0	1	24		15.05	15.77	16.68		
20+5	1	99	1	0		20.46	19.03	18.33		
Limit	EIRP < 1W					Result			Pass	



LTE Band 66C_CA Maximum Average Power [dBm] (GT - LC = 3.8 dB)										
BW [MHz]	PCC		SCC		Mod	Lowest	Middle	Highest	EIRP (dBm)	EIRP (W)
	RB Size	RB Offset	RB Size	RB Offset						
5+20	25	0	100	0	QPSK	23.49	23.53	23.55	29.40	0.8710
5+20	1	0	1	99		16.40	17.00	16.87		
5+20	1	24	1	0		25.60	25.41	25.26		
5+20	25	0	100	0	16-QAM	22.35	22.66	22.67	28.97	0.7889
5+20	1	0	1	99		16.66	17.76	17.66		
5+20	1	24	1	0		25.06	25.17	24.47		
5+20	25	0	100	0	64-QAM	21.17	22.04	21.84	26.47	0.4436
5+20	1	0	1	99		16.53	17.21	17.23		
5+20	1	24	1	0		22.20	22.67	21.85		
5+20	25	0	100	0	256-QAM	20.15	20.55	20.68	24.92	0.3105
5+20	1	0	1	99		15.12	17.26	17.12		
5+20	1	24	1	0		21.12	20.92	20.76		
Limit	EIRP < 1W				Result			Pass		



LTE Band 66C_CA Maximum Average Power [dBm] (GT - LC = 3.8 dB)										
BW [MHz]	PCC		SCC		Mod	Lowest	Middle	Highest	EIRP (dBm)	EIRP (W)
	RB Size	RB Offset	RB Size	RB Offset						
15+10	75	0	50	0	QPSK	23.71	23.66	22.55	29.20	0.8318
15+10	1	0	1	49		17.12	17.16	17.16		
15+10	1	74	1	0		25.40	25.30	23.48		
15+10	75	0	50	0	16-QAM	22.71	22.91	21.97	28.95	0.7852
15+10	1	0	1	49		17.72	17.54	17.91		
15+10	1	74	1	0		25.06	25.15	22.66		
15+10	75	0	50	0	64-QAM	21.75	22.30	21.04	27.13	0.5164
15+10	1	0	1	49		17.48	17.15	17.36		
15+10	1	74	1	0		22.47	23.33	19.73		
15+10	75	0	50	0	256-QAM	20.72	20.71	19.93	24.56	0.2858
15+10	1	0	1	49		16.81	17.18	17.26		
15+10	1	74	1	0		20.73	20.76	18.57		
10+15	50	0	75	0	QPSK	23.60	23.60	22.90	29.10	0.8128
10+15	1	0	1	74		16.35	16.95	16.67		
10+15	1	49	1	0		25.21	25.30	23.73		
10+15	50	0	75	0	16-QAM	22.32	22.66	22.40	28.74	0.7482
10+15	1	0	1	74		16.80	17.42	17.28		
10+15	1	49	1	0		24.94	24.73	23.13		
10+15	50	0	75	0	64-QAM	21.43	22.20	21.53	26.00	0.3981
10+15	1	0	1	74		16.54	17.23	17.32		
10+15	1	49	1	0		22.10	21.98	20.34		
10+15	50	0	75	0	256-QAM	20.52	20.66	20.49	24.80	0.3020
10+15	1	0	1	74		15.22	16.86	17.20		
10+15	1	49	1	0		21.00	20.92	19.20		
15+15	75	0	75	0	QPSK	23.58	23.62	22.64	29.05	0.8035
15+15	1	0	1	74		17.00	16.98	16.93		
15+15	1	74	1	0		25.22	25.25	22.68		
15+15	75	0	75	0	16-QAM	22.60	22.60	22.44	28.87	0.7709
15+15	1	0	1	74		17.73	17.69	17.61		
15+15	1	74	1	0		24.97	25.07	22.41		
15+15	75	0	75	0	64-QAM	21.88	22.03	21.58	26.63	0.4603
15+15	1	0	1	74		17.05	17.20	17.49		
15+15	1	74	1	0		22.48	22.83	21.48		
15+15	75	0	75	0	256-QAM	20.58	20.65	20.57	24.46	0.2793
15+15	1	0	1	74		16.47	16.85	17.26		
15+15	1	74	1	0		20.66	20.63	20.58		
Limit	EIRP < 1W					Result			Pass	





## LTE Band 2

### Peak-to-Average Ratio

Mode	LTE Band 2 / 20MHz				
Mod.	QPSK	16QAM	64QAM	256QAM	Limit: 13dB
RB Size	Full RB	Full RB	Full RB	Full RB	Result
Middle CH	4.90	5.94	6.61	6.64	PASS

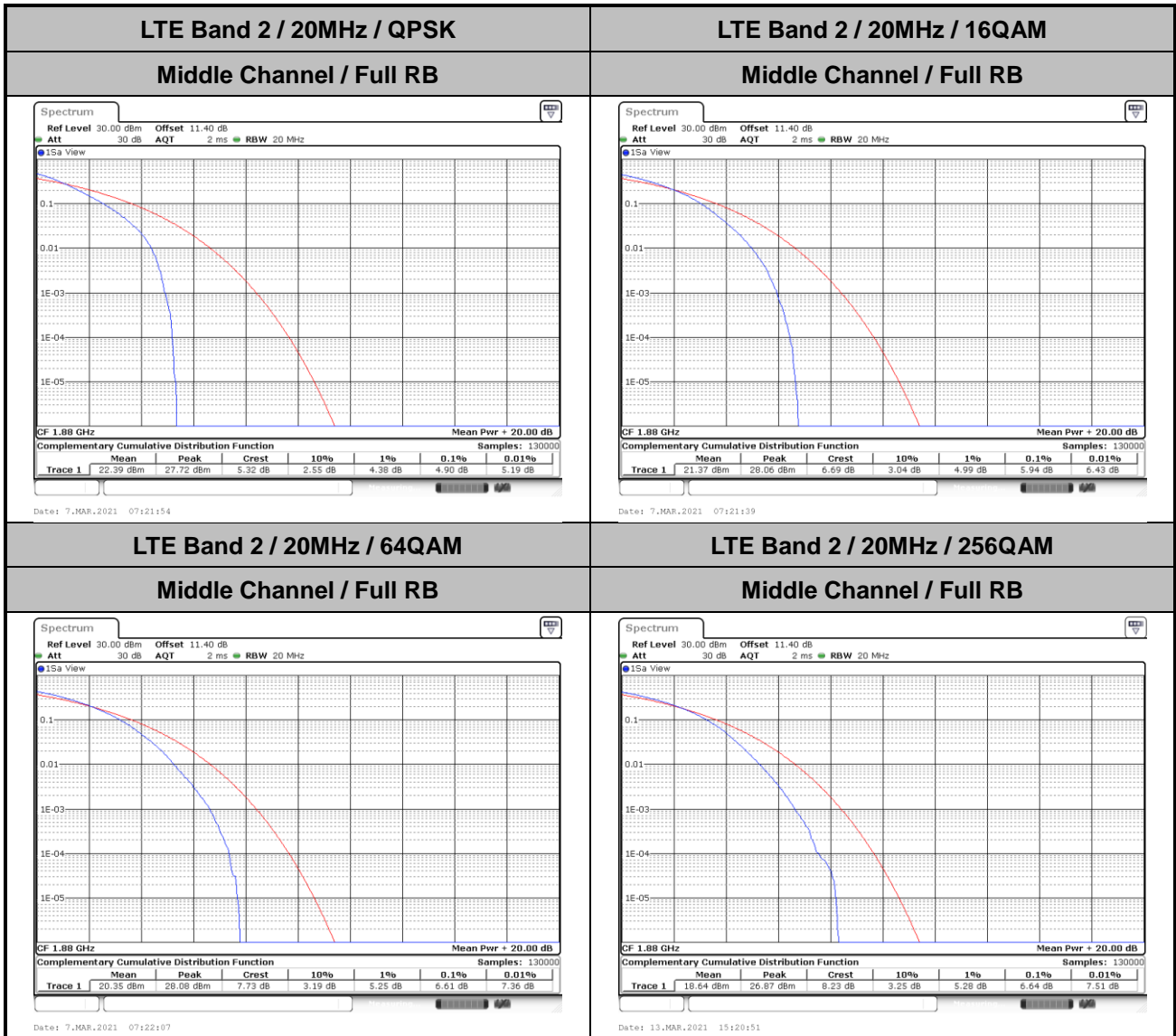



**26dB Bandwidth**

Mode	LTE Band 2 : 26dB BW(MHz)											
BW	1.4MHz		3MHz		5MHz		10MHz		15MHz		20MHz	
Mod.	QPSK	16QAM	QPSK	16QAM	QPSK	16QAM	QPSK	16QAM	QPSK	16QAM	QPSK	16QAM
Middle CH	1.24	1.22	3.03	3.05	4.95	4.87	9.75	9.73	14.51	14.72	19.06	19.10
Mode	LTE Band 2 : 26dB BW(MHz)											
BW	1.4MHz		3MHz		5MHz		10MHz		15MHz		20MHz	
Mod.	64QAM	256 QAM	64QAM	256 QAM	64QAM	256 QAM	64QAM	256 QAM	64QAM	256 QAM	64QAM	256 QAM
Middle CH	1.20	1.20	3.04	3.06	4.82	4.88	9.77	9.79	14.45	14.30	18.94	18.70



LTE Band 2

Middle Channel / 1.4MHz / QPSK

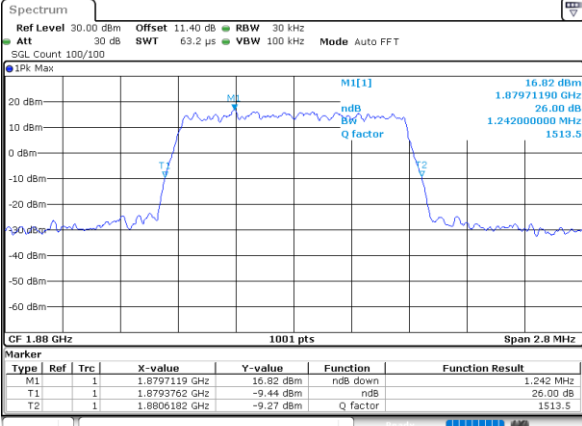

Date: 7.MAR.2021 06:43:12

Middle Channel / 1.4MHz / 16QAM

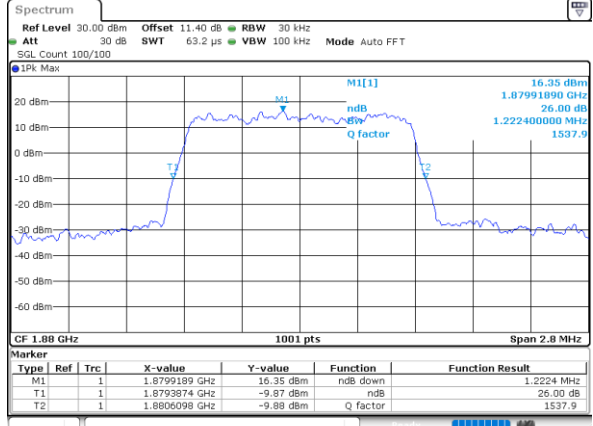

Date: 7.MAR.2021 06:43:24

Middle Channel / 3MHz / QPSK

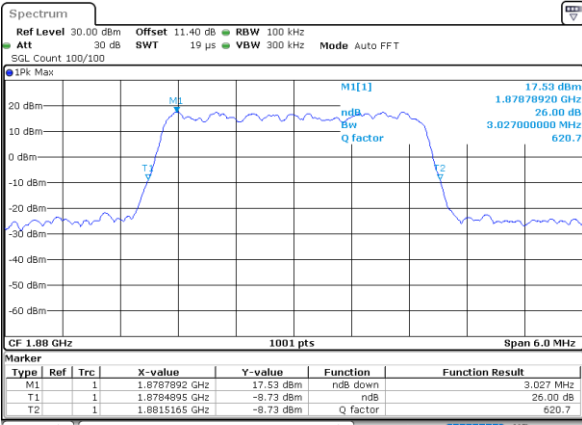

Date: 7.MAR.2021 06:48:43

Middle Channel / 3MHz / 16QAM

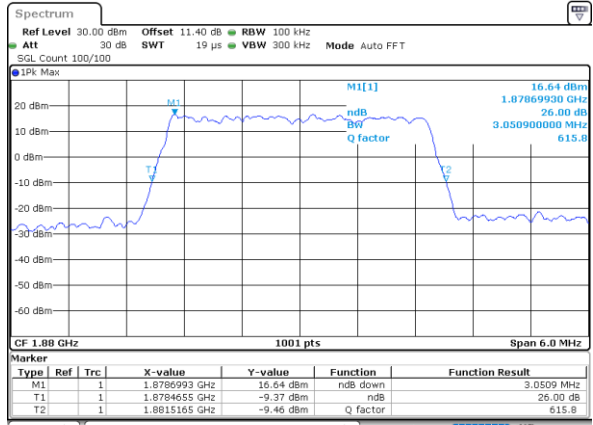

Date: 7.MAR.2021 06:48:55

Middle Channel / 5MHz / QPSK

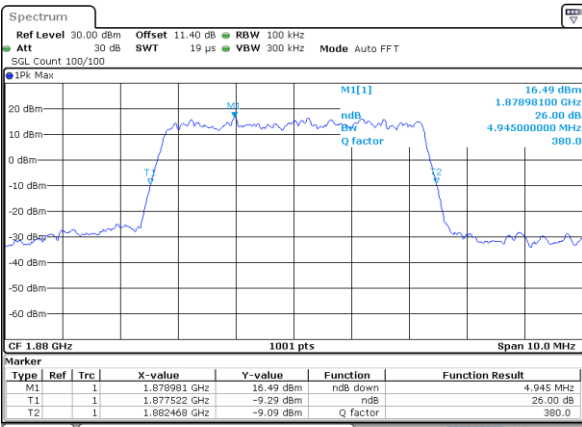

Date: 7.MAR.2021 06:54:13

Middle Channel / 5MHz / 16QAM

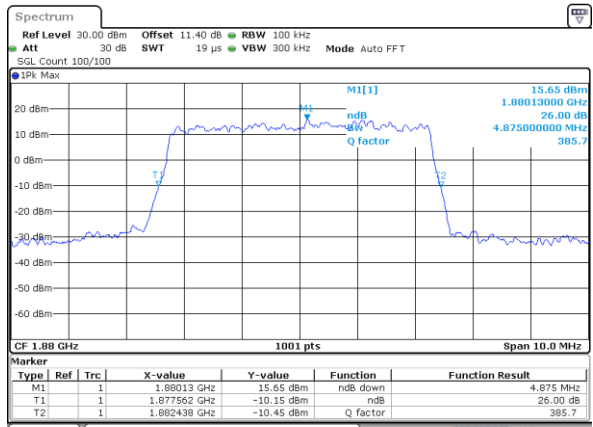

Date: 7.MAR.2021 06:54:24



LTE Band 2

Middle Channel / 10MHz / QPSK

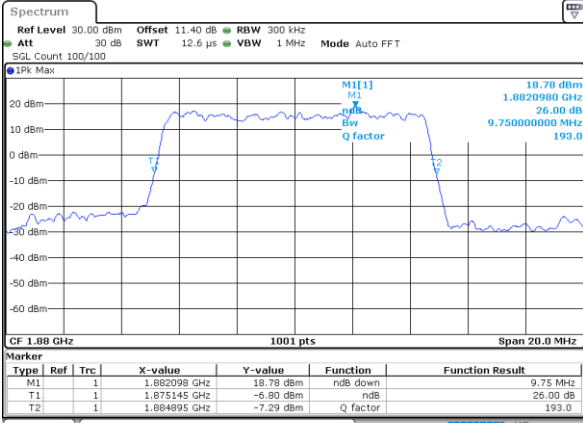

Date: 7.MAR.2021 06:59:41

Middle Channel / 10MHz / 16QAM

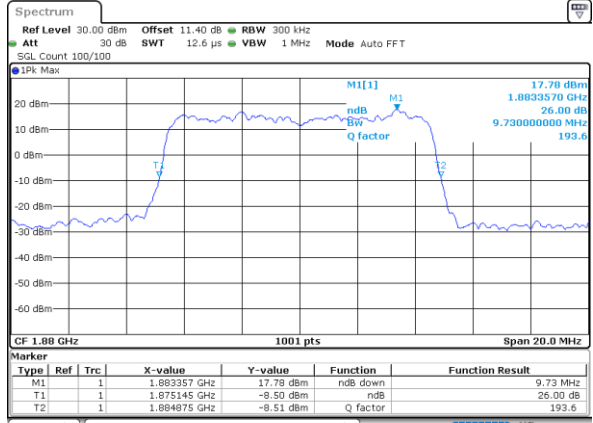

Date: 7.MAR.2021 06:59:53

Middle Channel / 15MHz / QPSK

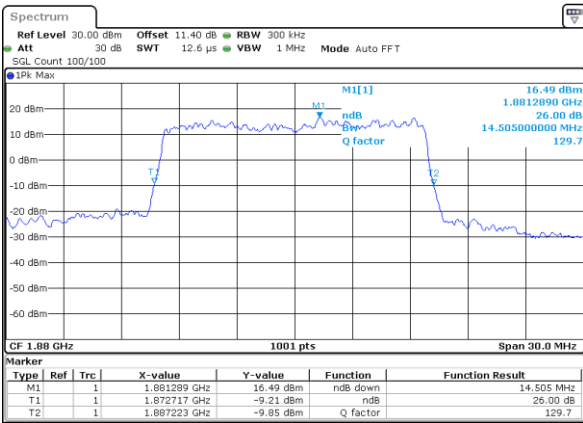

Date: 7.MAR.2021 07:05:12

Middle Channel / 15MHz / 16QAM

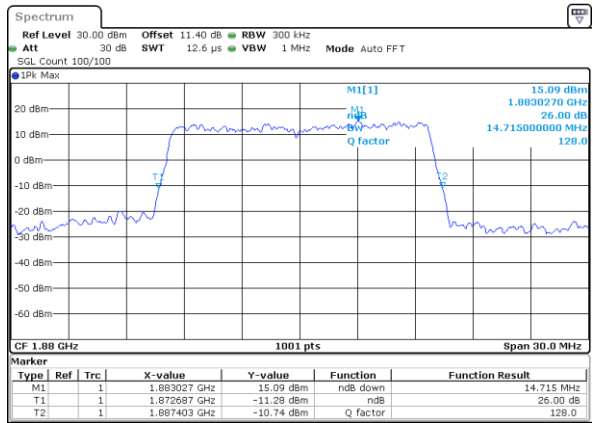

Date: 7.MAR.2021 07:05:24

Middle Channel / 20MHz / QPSK

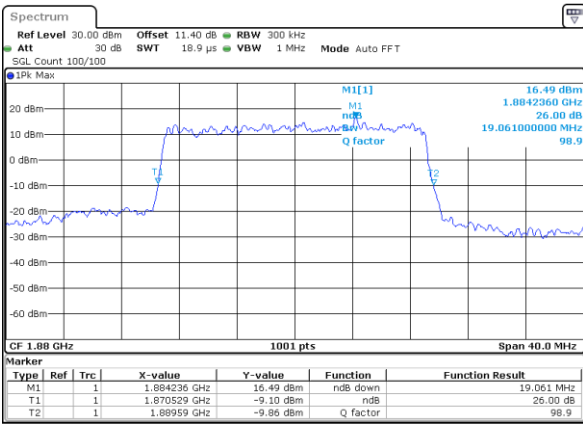

Date: 7.MAR.2021 07:10:44

Middle Channel / 20MHz / 16QAM

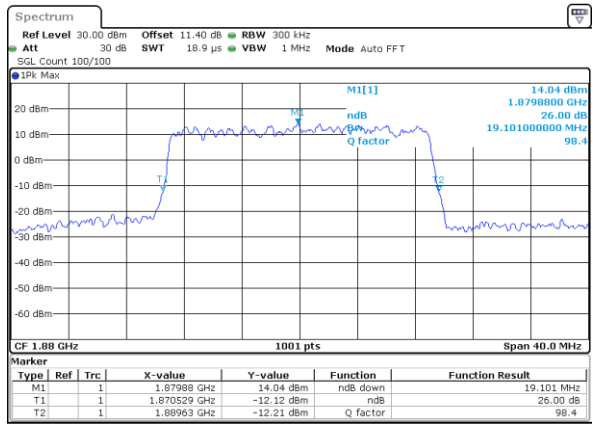

Date: 7.MAR.2021 07:10:55



LTE Band 2

Middle Channel / 1.4MHz / 64QAM

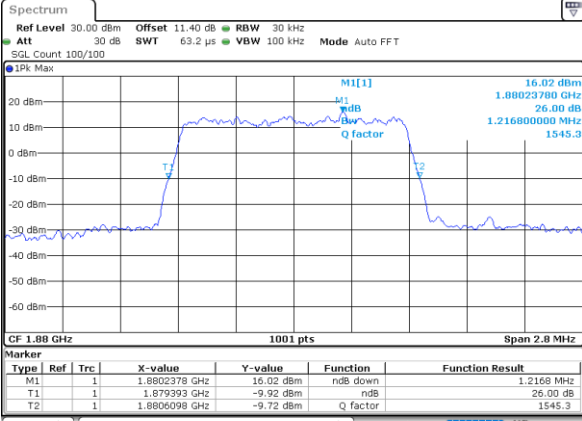

Date: 7.MAR.2021 06:40:04

Middle Channel / 3MHz / 64QAM

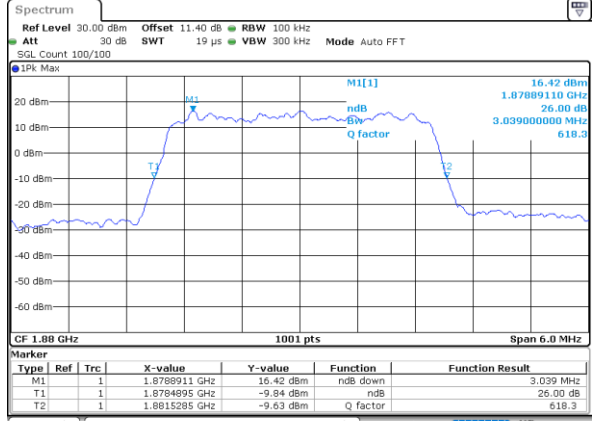

Date: 7.MAR.2021 07:14:39

Middle Channel / 5MHz / 64QAM

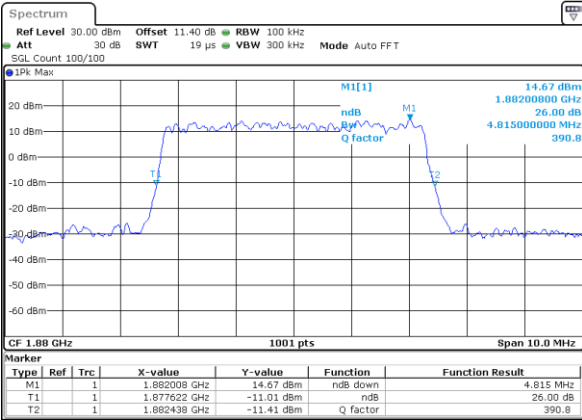

Date: 7.MAR.2021 07:16:12

Middle Channel / 10MHz / 64QAM

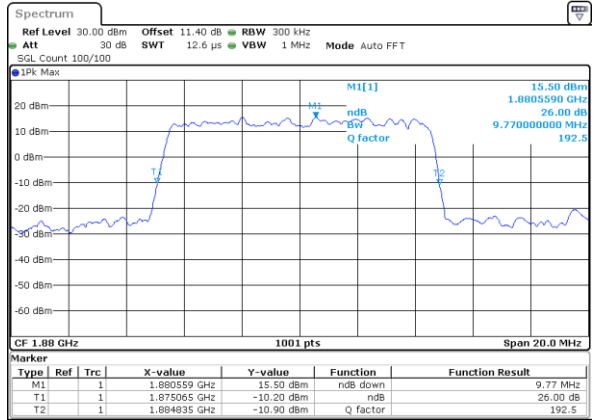

Date: 7.MAR.2021 07:17:46

Middle Channel / 15MHz / 64QAM

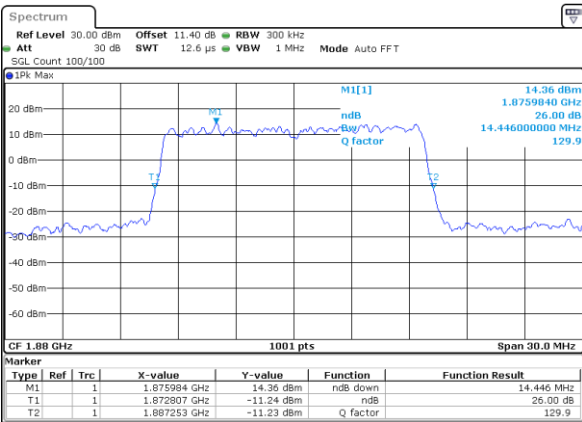

Date: 7.MAR.2021 07:19:19

Middle Channel / 20MHz / 64QAM

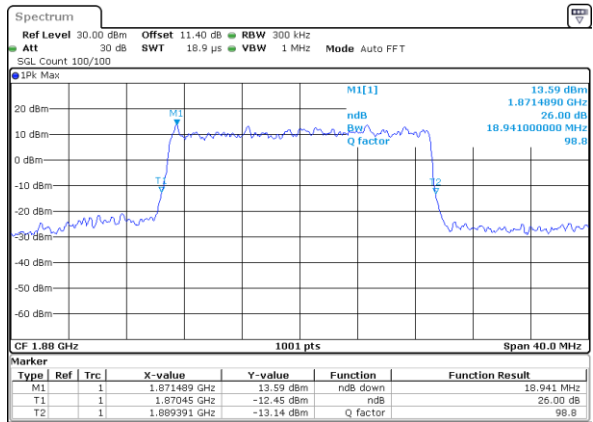

Date: 7.MAR.2021 07:20:53



LTE Band 2

Middle Channel / 1.4MHz / 256QAM

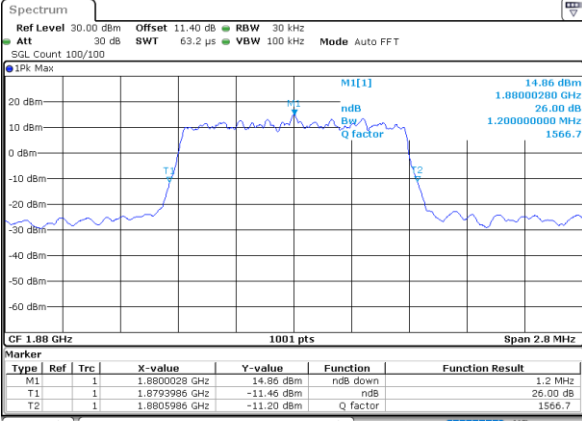

Date: 13.MAR.2021 15:06:52

Middle Channel / 3MHz / 256QAM

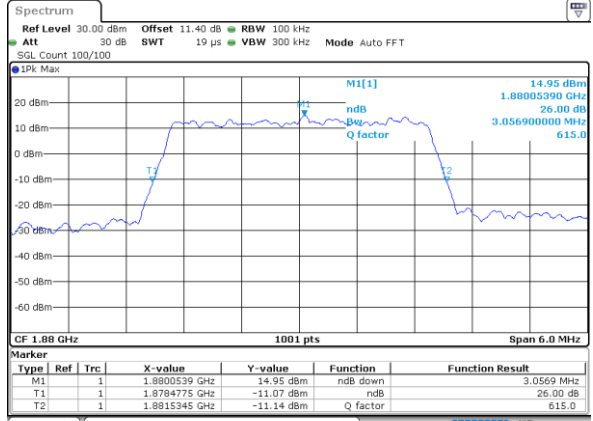

Date: 13.MAR.2021 15:10:25

Middle Channel / 5MHz / 256QAM

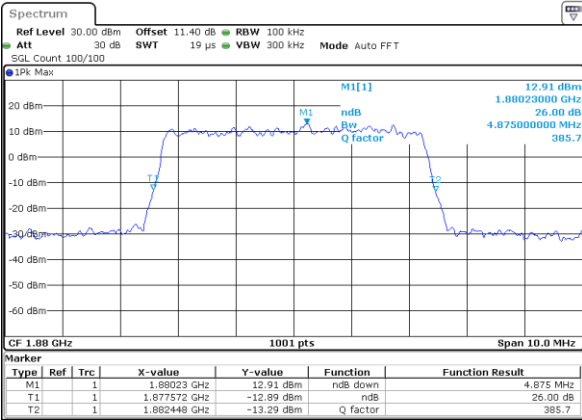

Date: 13.MAR.2021 15:12:26

Middle Channel / 10MHz / 256QAM

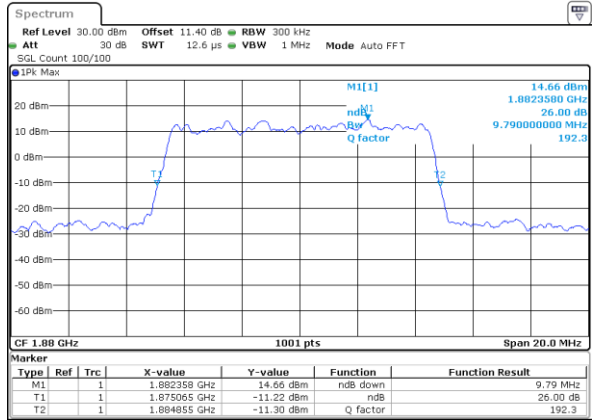

Date: 13.MAR.2021 15:14:52

Middle Channel / 15MHz / 256QAM

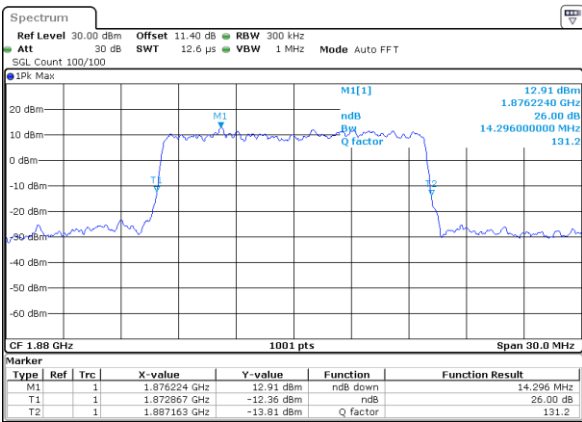

Date: 13.MAR.2021 15:17:23

Middle Channel / 20MHz / 256QAM

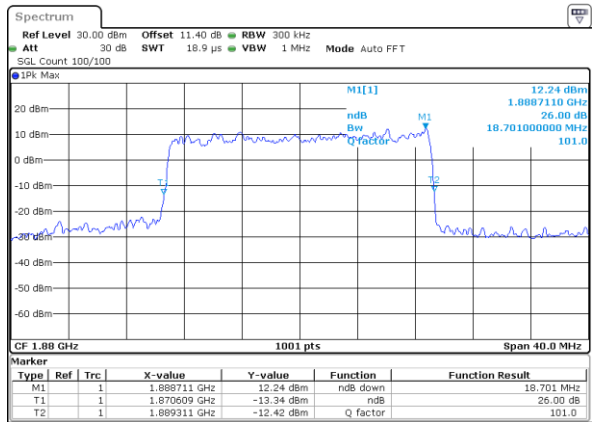

Date: 13.MAR.2021 15:20:43



**Occupied Bandwidth**

Mode	LTE Band 2 : 99%OBW(MHz)											
BW	1.4MHz		3MHz		5MHz		10MHz		15MHz		20MHz	
Mod.	QPSK	16QAM	QPSK	16QAM	QPSK	16QAM	QPSK	16QAM	QPSK	16QAM	QPSK	16QAM
Middle CH	1.09	1.09	2.72	2.72	4.49	4.50	8.99	8.99	13.43	13.46	17.90	17.90
Mode	LTE Band 2 : 99%OBW(MHz)											
BW	1.4MHz		3MHz		5MHz		10MHz		15MHz		20MHz	
Mod.	64QAM	256 QAM	64QAM	256 QAM	64QAM	256 QAM	64QAM	256 QAM	64QAM	256 QAM	64QAM	256 QAM
Middle CH	1.09	1.09	2.73	2.73	4.50	4.47	8.97	9.01	13.43	13.40	17.90	17.90





LTE Band 2

Middle Channel / 1.4MHz / QPSK

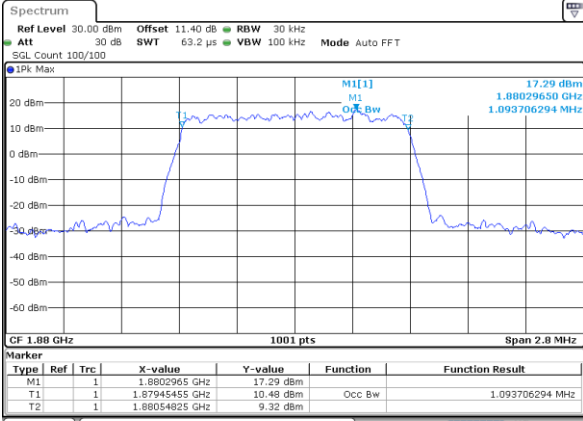

Date: 7.MAR.2021 06:42:49

Middle Channel / 1.4MHz / 16QAM

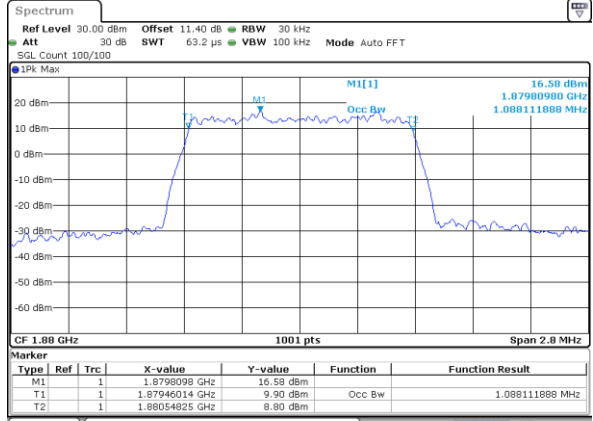

Date: 7.MAR.2021 06:43:01

Middle Channel / 3MHz / QPSK

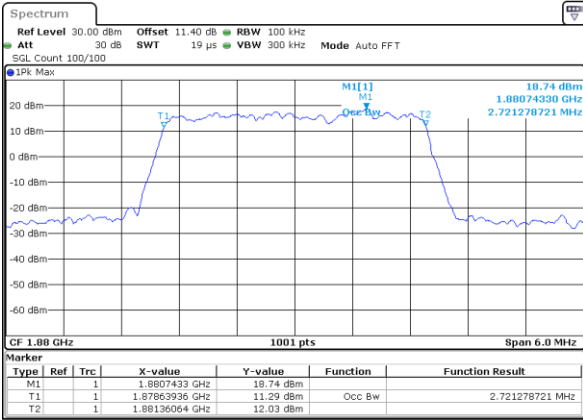

Date: 7.MAR.2021 06:48:20

Middle Channel / 3MHz / 16QAM

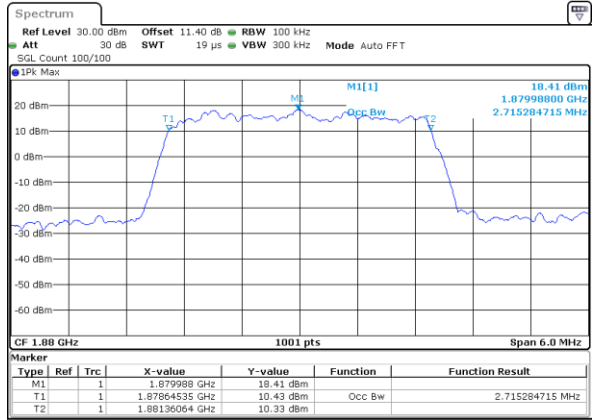

Date: 7.MAR.2021 06:48:32

Middle Channel / 5MHz / QPSK

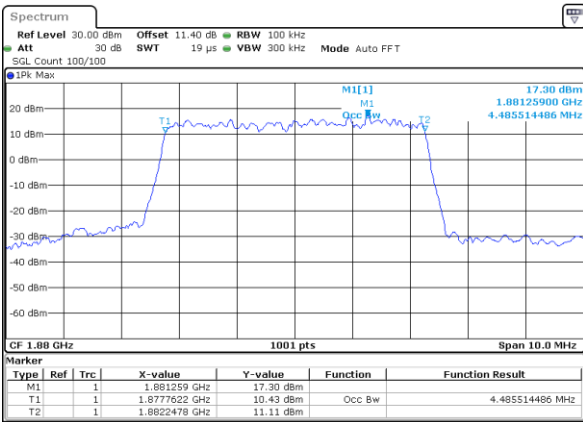

Date: 7.MAR.2021 06:53:49

Middle Channel / 5MHz / 16QAM

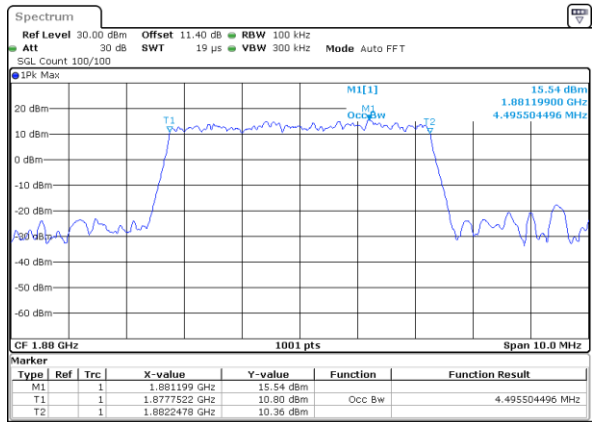

Date: 7.MAR.2021 06:54:01



LTE Band 2

Middle Channel / 10MHz / QPSK

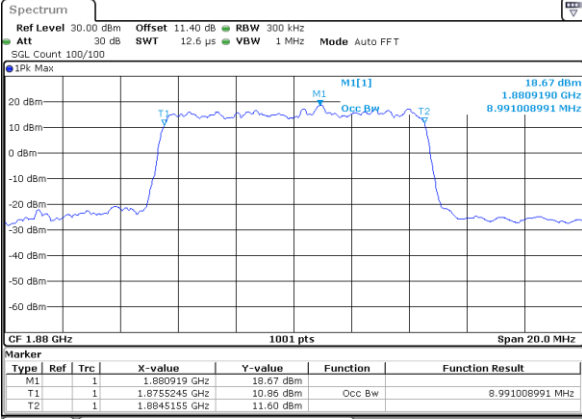

Date: 7.MAR.2021 06:59:18

Middle Channel / 10MHz / 16QAM

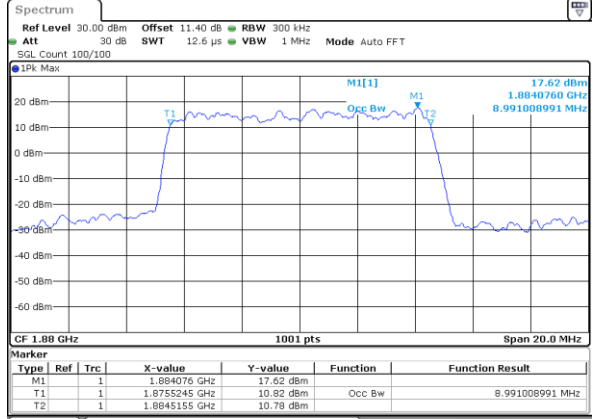

Date: 7.MAR.2021 06:59:30

Middle Channel / 15MHz / QPSK

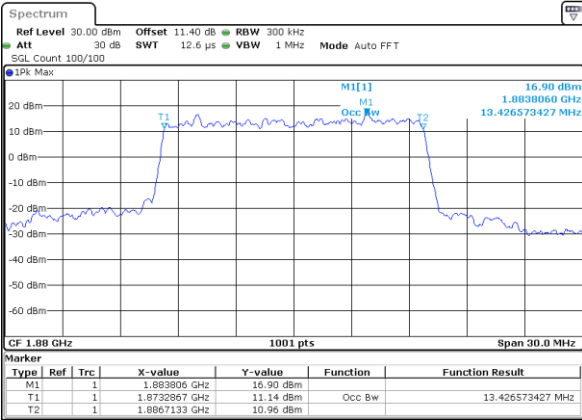

Date: 7.MAR.2021 07:04:48

Middle Channel / 15MHz / 16QAM

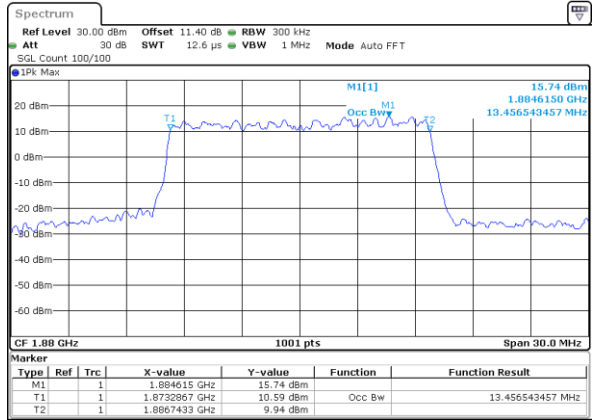

Date: 7.MAR.2021 07:05:00

Middle Channel / 20MHz / QPSK

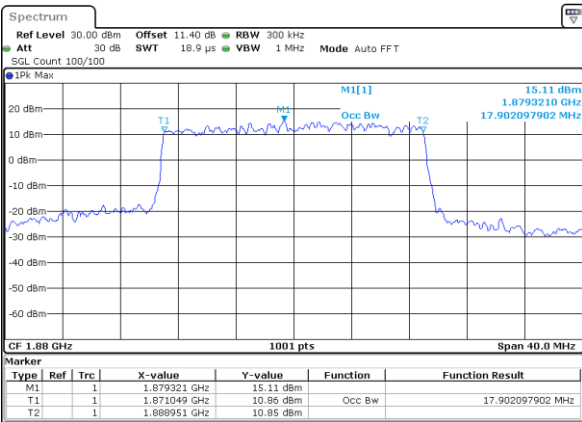

Date: 7.MAR.2021 07:10:21

Middle Channel / 20MHz / 16QAM

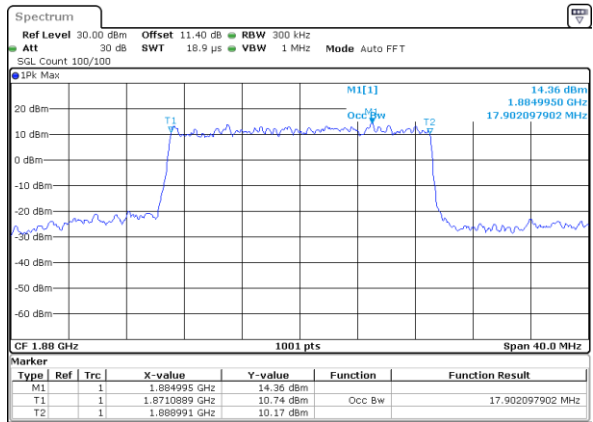

Date: 7.MAR.2021 07:10:32



LTE Band 2

Middle Channel / 1.4MHz / 64QAM

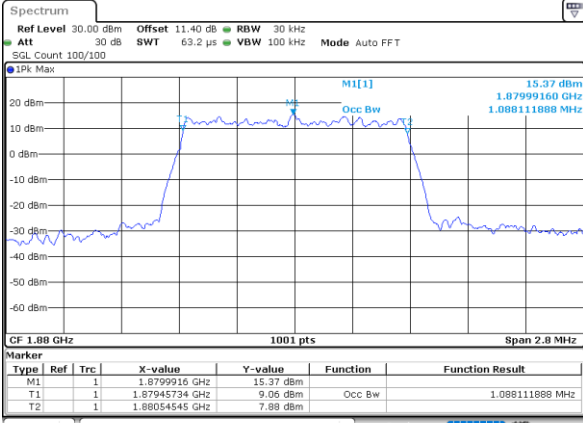

Date: 7.MAR.2021 06:39:53

Middle Channel / 3MHz / 64QAM

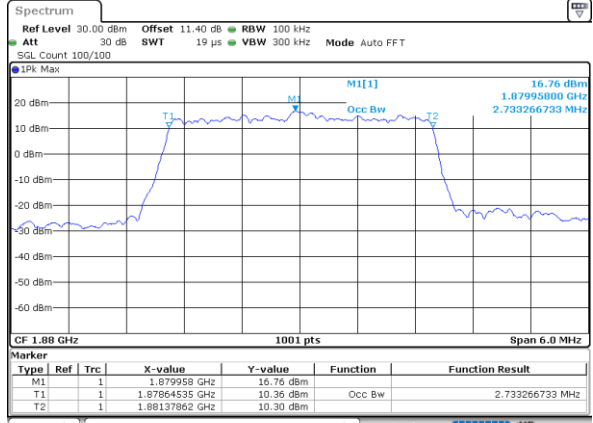

Date: 7.MAR.2021 07:14:27

Middle Channel / 5MHz / 64QAM

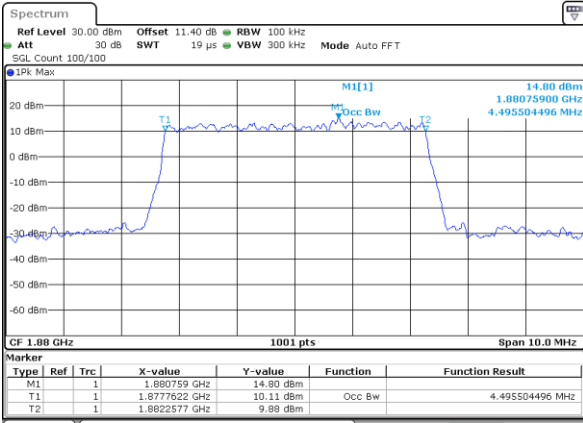

Date: 7.MAR.2021 07:16:00

Middle Channel / 10MHz / 64QAM

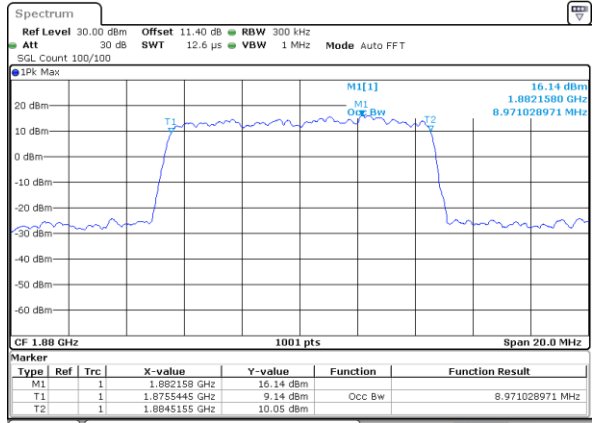

Date: 7.MAR.2021 07:17:35

Middle Channel / 15MHz / 64QAM

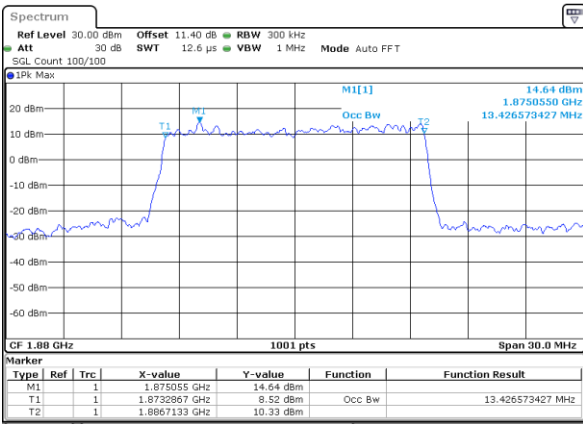

Date: 7.MAR.2021 07:19:08

Middle Channel / 20MHz / 64QAM

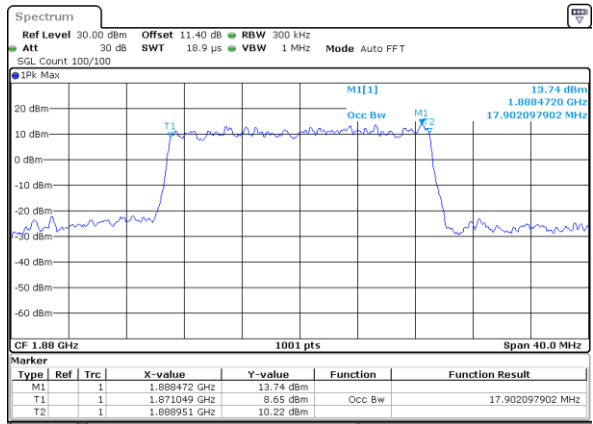

Date: 7.MAR.2021 07:20:41



LTE Band 2

Middle Channel / 1.4MHz / 256QAM

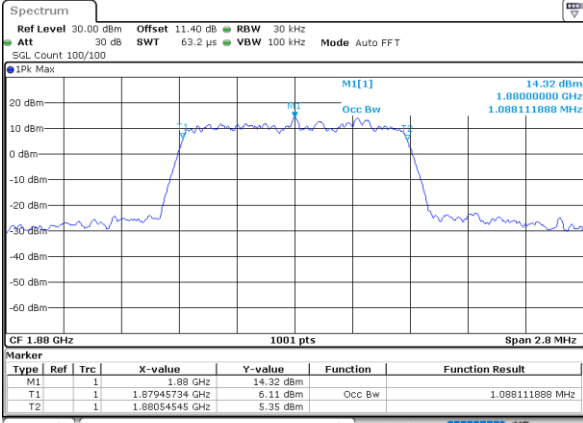

Date: 13.MAR.2021 15:06:44

Middle Channel / 3MHz / 256QAM

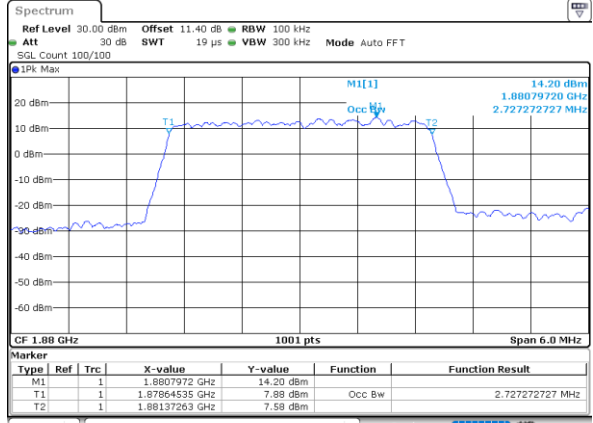

Date: 13.MAR.2021 15:10:18

Middle Channel / 5MHz / 256QAM

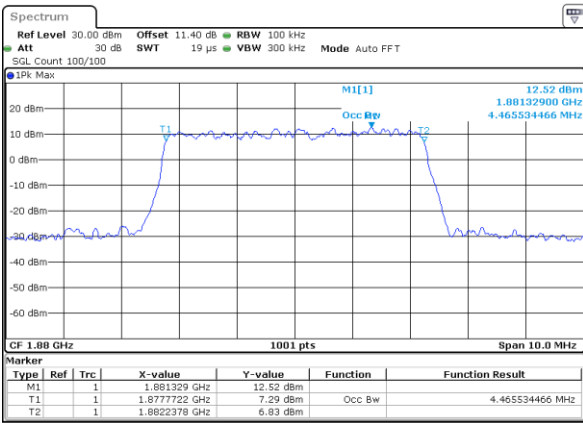

Date: 13.MAR.2021 15:12:19

Middle Channel / 10MHz / 256QAM

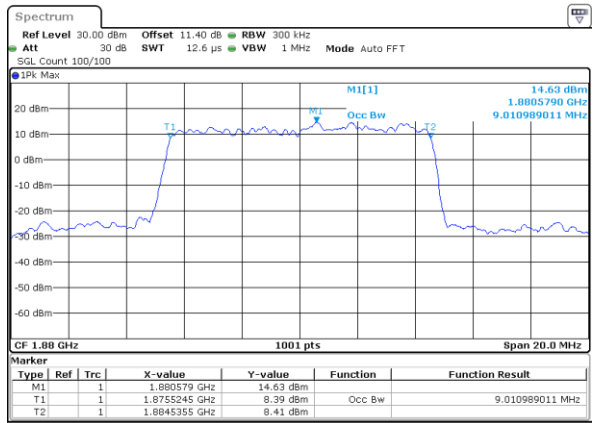

Date: 13.MAR.2021 15:14:44

Middle Channel / 15MHz / 256QAM

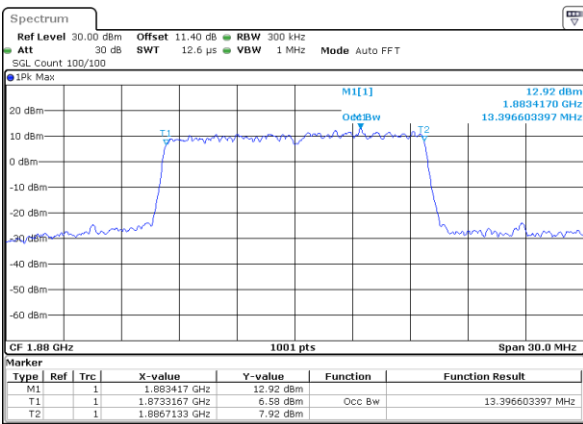

Date: 13.MAR.2021 15:17:16

Middle Channel / 20MHz / 256QAM

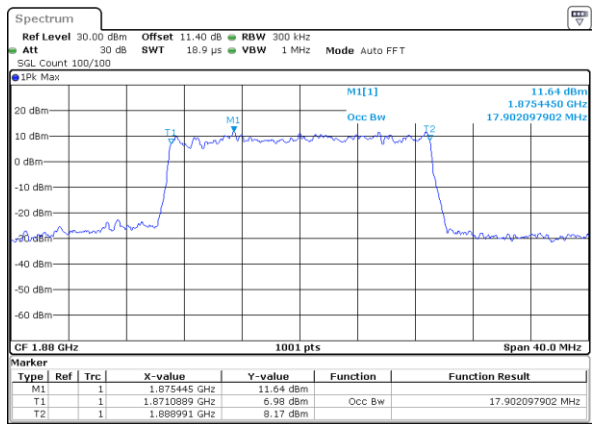

Date: 13.MAR.2021 15:20:35



# Conducted Band Edge

## LTE Band 2 / 1.4MHz / QPSK

### Lowest Band Edge / 1RB

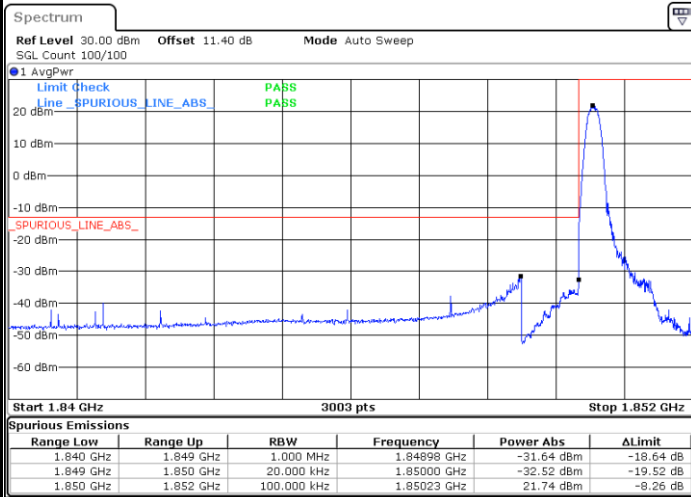

Date: 7.MAR.2021 06:40:55

### Highest Band Edge / 1RB

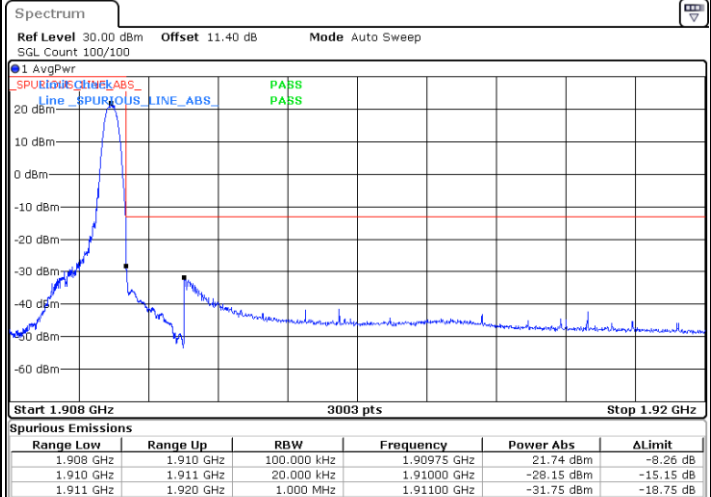

Date: 7.MAR.2021 06:44:27

### Lowest Band Edge / Full RB

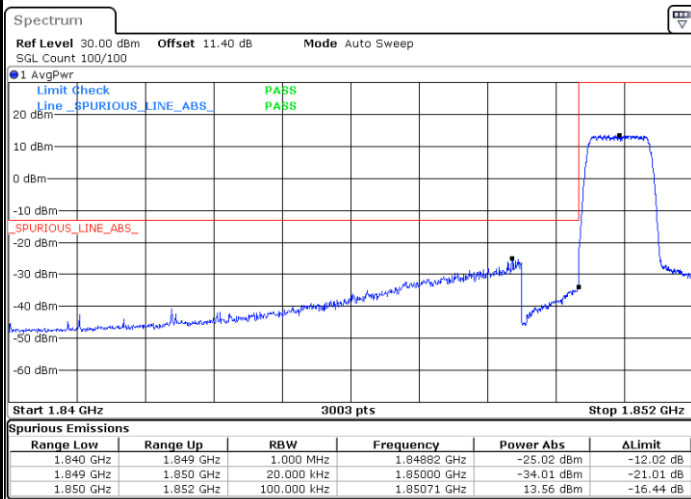

Date: 7.MAR.2021 06:41:30

### Highest Band Edge / Full RB

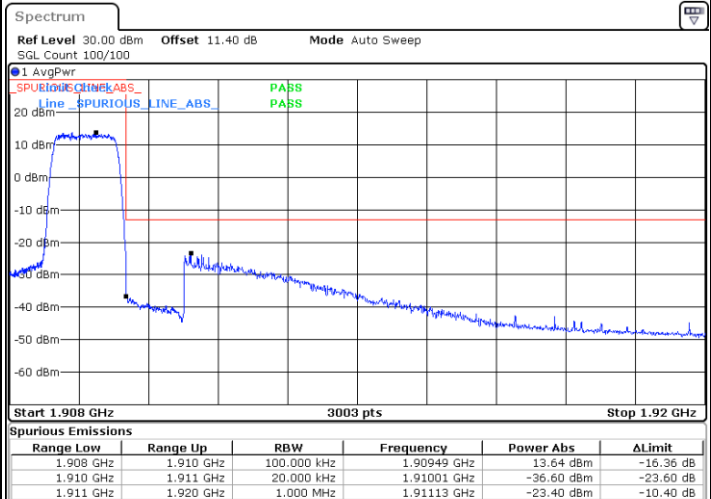

Date: 7.MAR.2021 06:45:02



LTE Band 2 / 1.4MHz / 16QAM

Lowest Band Edge / 1 RB

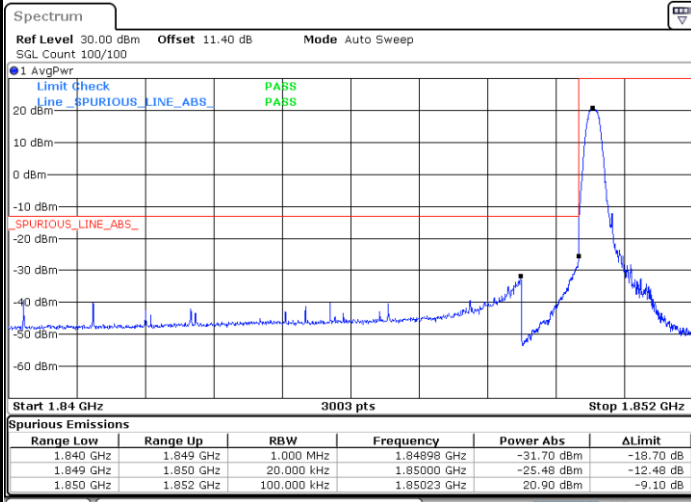

Date: 7.MAR.2021 06:41:12

Highest Band Edge / 1 RB

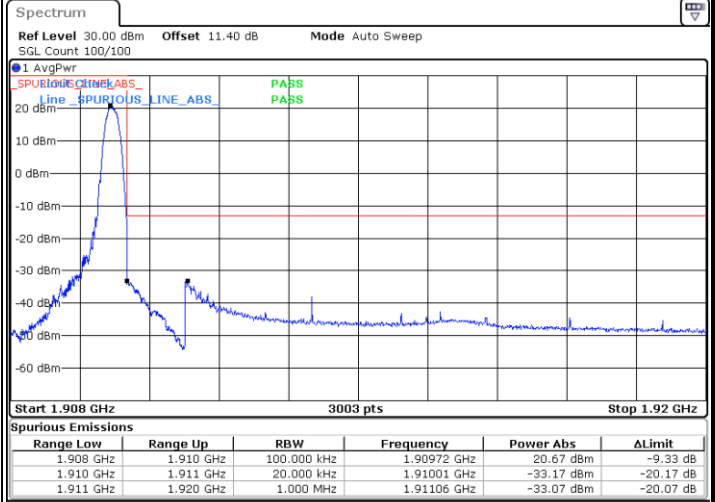

Date: 7.MAR.2021 06:44:44

Lowest Band Edge / Full RB

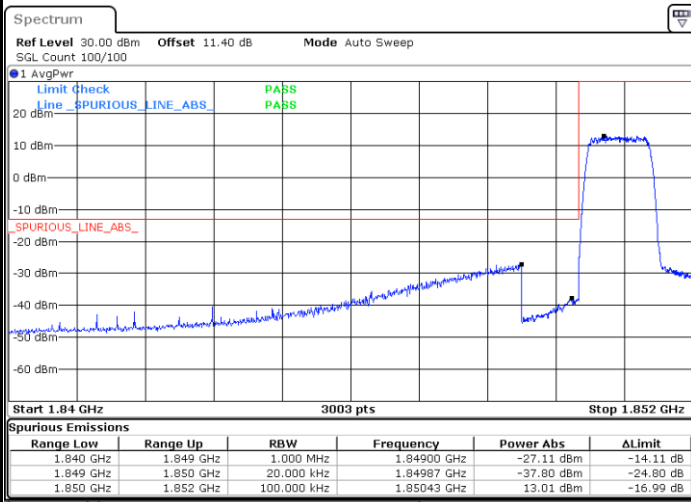

Date: 7.MAR.2021 06:41:47

Highest Band Edge / Full RB

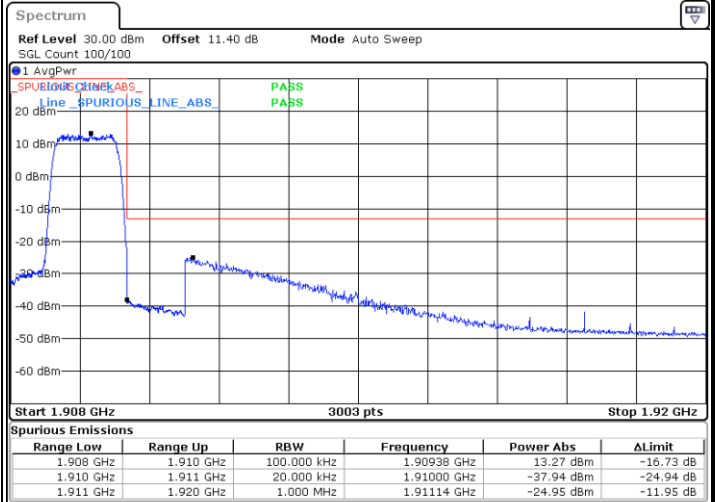

Date: 7.MAR.2021 06:45:19



LTE Band 2 / 1.4MHz / 64QAM

Lowest Band Edge / 1 RB

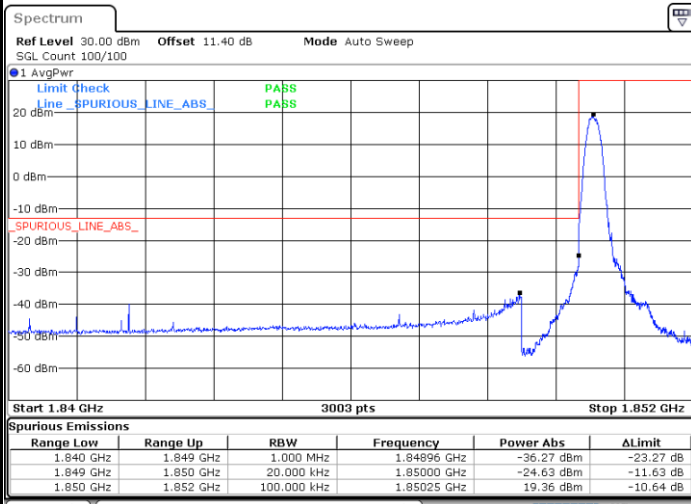

Date: 7.MAR.2021 06:39:21

Highest Band Edge / 1 RB

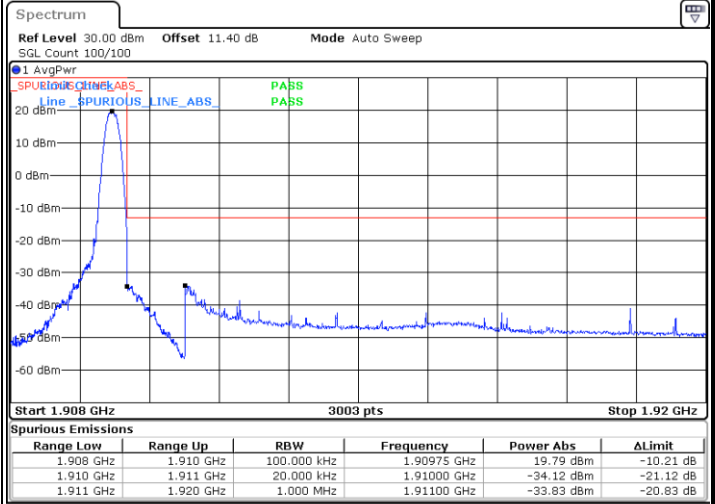

Date: 7.MAR.2021 06:40:20

Lowest Band Edge / Full RB

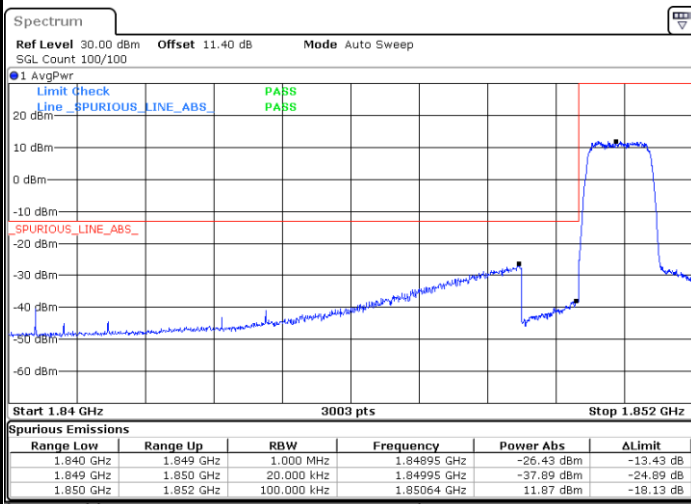

Date: 7.MAR.2021 06:39:39

Highest Band Edge / Full RB

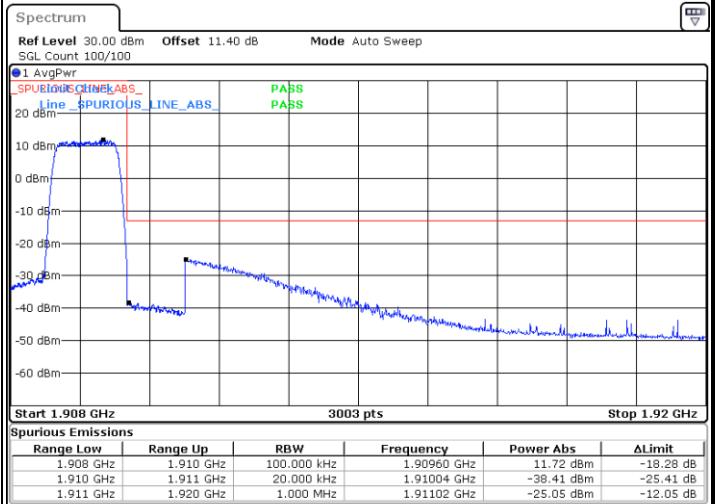

Date: 7.MAR.2021 06:40:37



LTE Band 2 / 1.4MHz / 256QAM

Lowest Band Edge / 1 RB

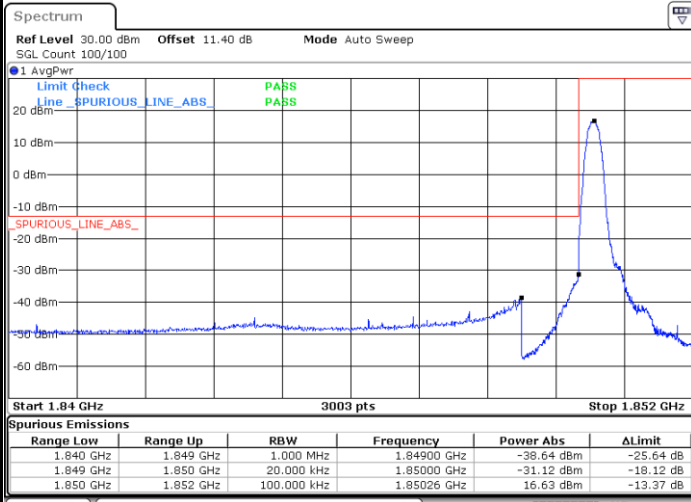

Date: 13.MAR.2021 15:06:04

Highest Band Edge / 1 RB

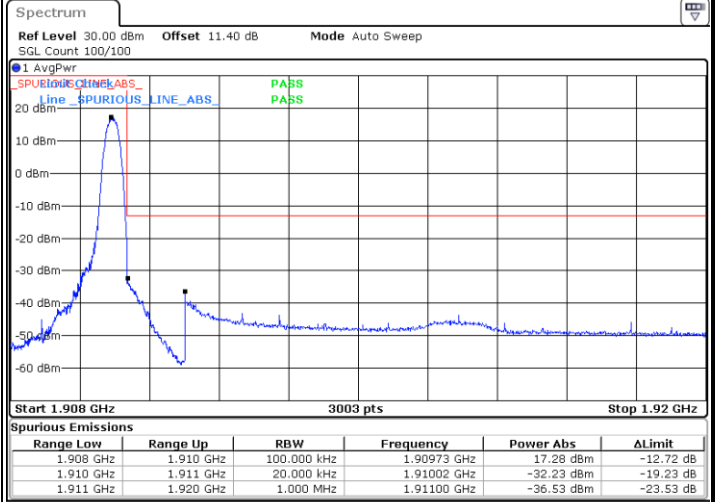

Date: 13.MAR.2021 15:07:45

Lowest Band Edge / Full RB

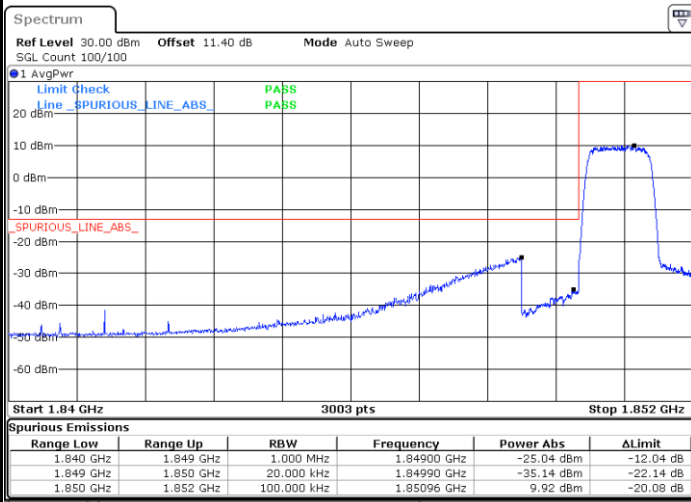

Date: 13.MAR.2021 15:06:21

Highest Band Edge / Full RB

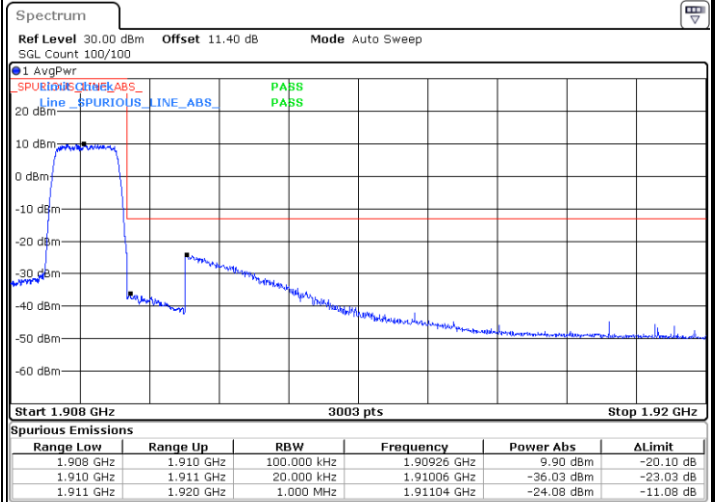

Date: 13.MAR.2021 15:07:25





LTE Band 2 / 3MHz / QPSK

Lowest Band Edge / 1RB

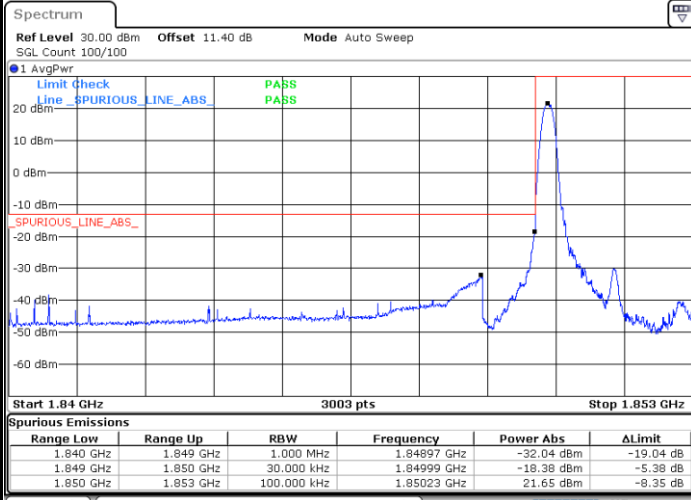

Date: 7.MAR.2021 06:46:25

Highest Band Edge / 1 RB

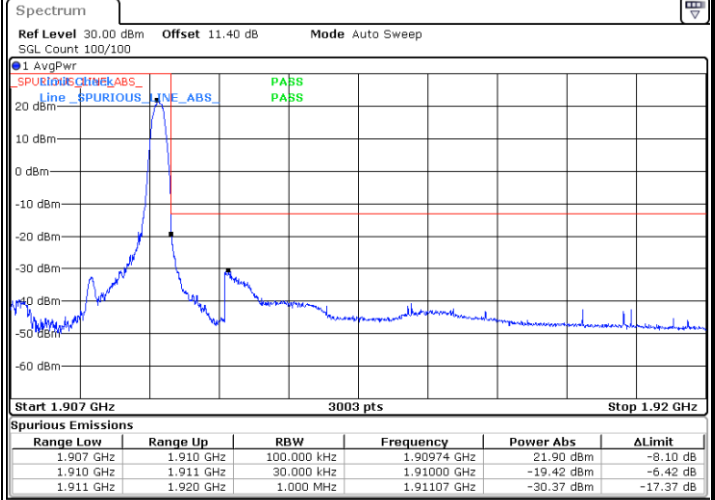

Date: 7.MAR.2021 06:49:57

Lowest Band Edge / Full RB

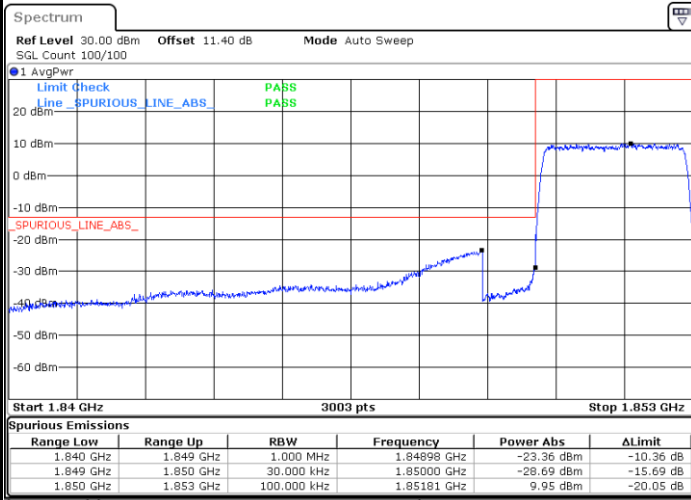

Date: 7.MAR.2021 06:46:59

Highest Band Edge / Full RB

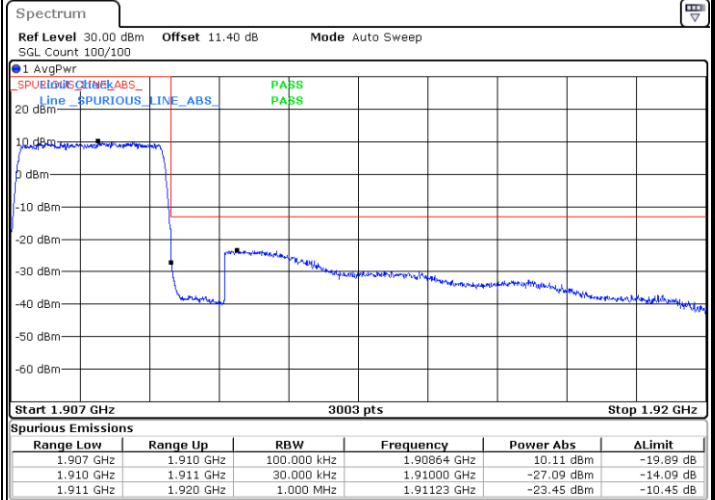

Date: 7.MAR.2021 06:50:32



LTE Band 2 / 3MHz / 16QAM

Lowest Band Edge / 1 RB

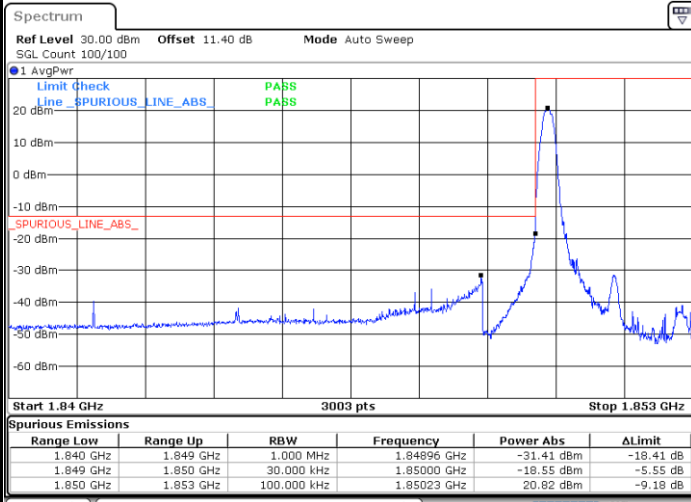

Date: 7.MAR.2021 06:46:42

Highest Band Edge / 1 RB

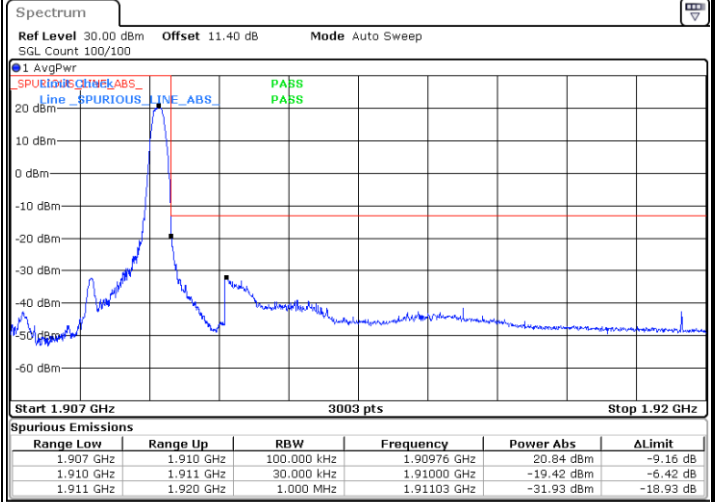

Date: 7.MAR.2021 06:50:14

Lowest Band Edge / Full RB

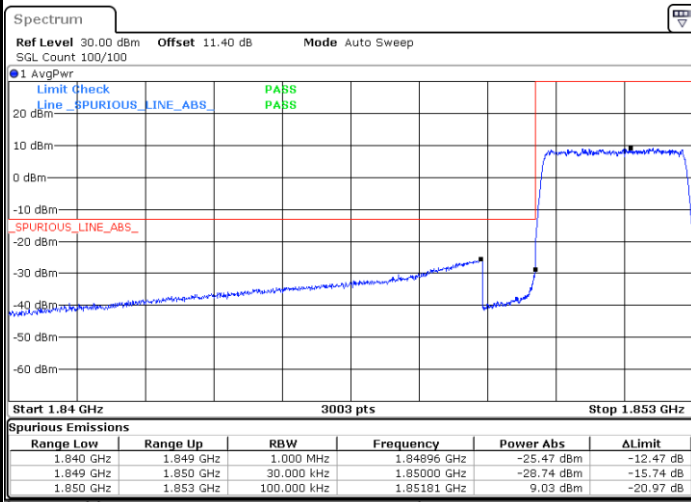

Date: 7.MAR.2021 06:47:17

Highest Band Edge / Full RB

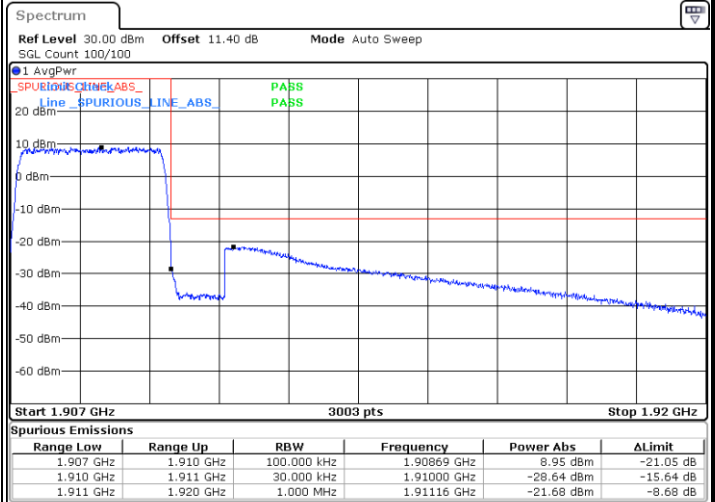

Date: 7.MAR.2021 06:50:49



LTE Band 2 / 3MHz / 64QAM

Lowest Band Edge / 1 RB

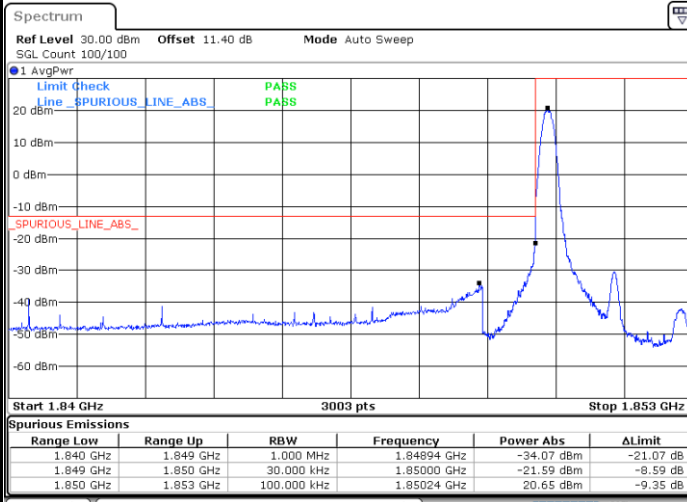

Date: 7.MAR.2021 07:13:56

Highest Band Edge / 1 RB

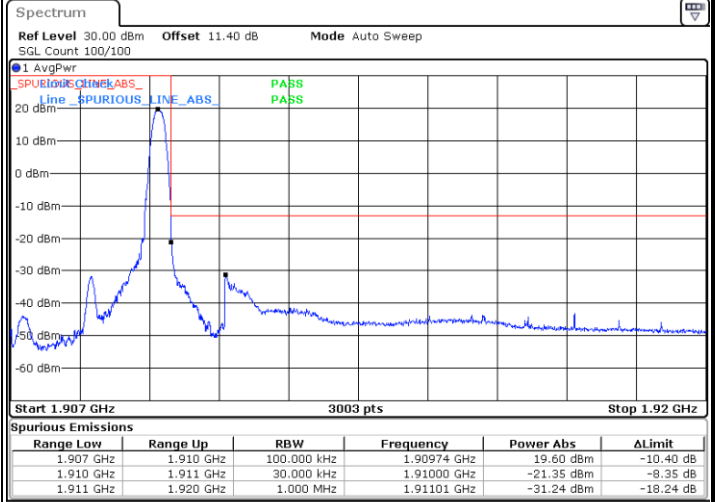

Date: 7.MAR.2021 07:14:54

Lowest Band Edge / Full RB

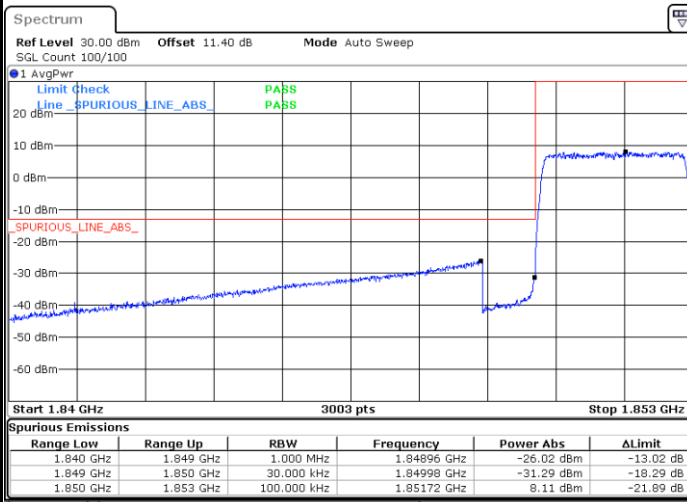

Date: 7.MAR.2021 07:14:13

Highest Band Edge / Full RB

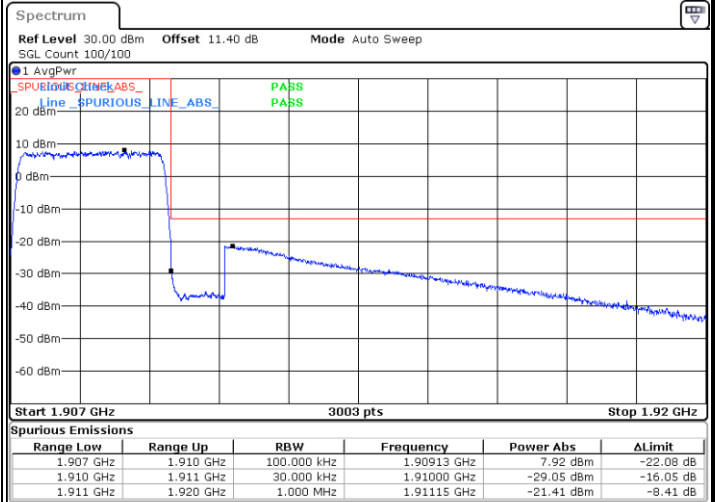

Date: 7.MAR.2021 07:15:12



LTE Band 2 / 3MHz / 256QAM

Lowest Band Edge / 1 RB

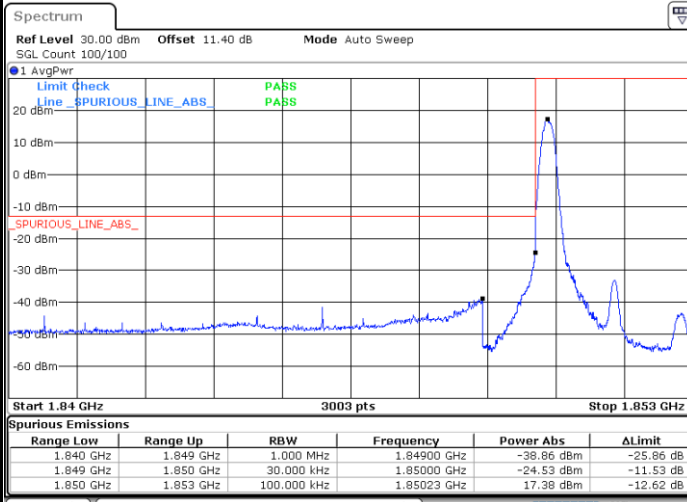

Date: 13.MAR.2021 15:09:35

Highest Band Edge / 1 RB

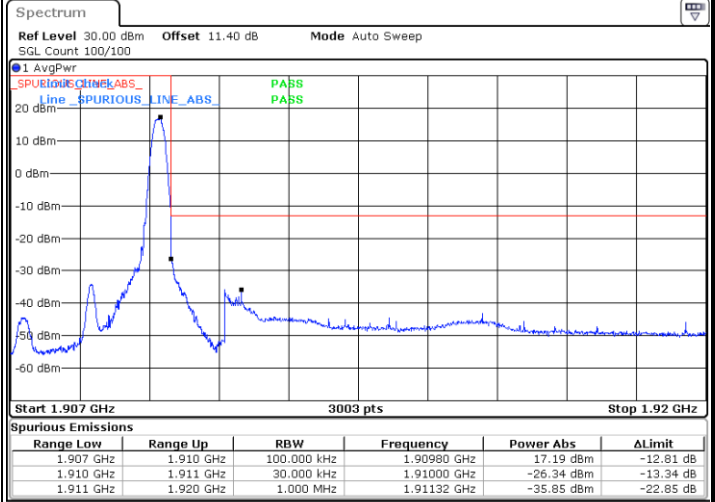

Date: 13.MAR.2021 15:11:07

Lowest Band Edge / Full RB

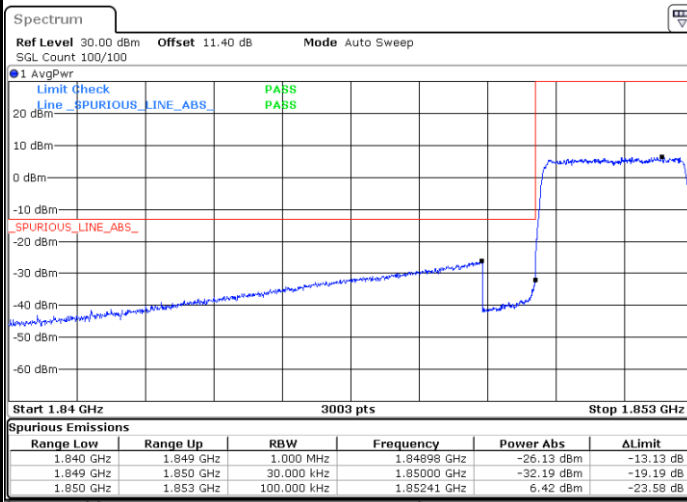

Date: 13.MAR.2021 15:08:54

Highest Band Edge / Full RB

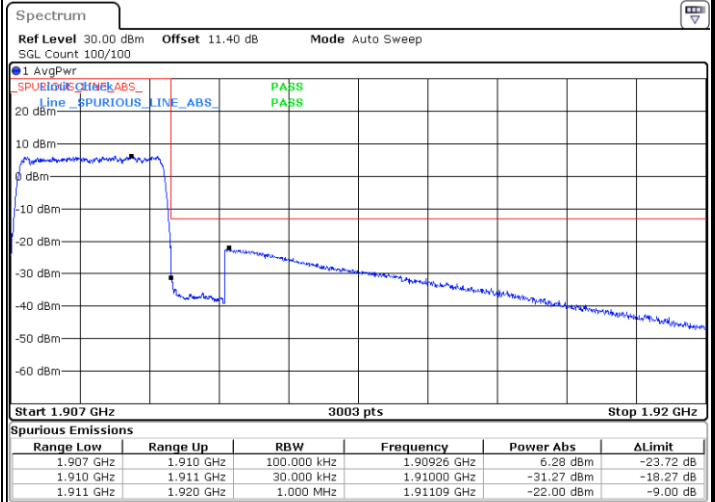

Date: 13.MAR.2021 15:10:51



LTE Band 2 / 5MHz / QPSK

Lowest Band Edge / 1 RB

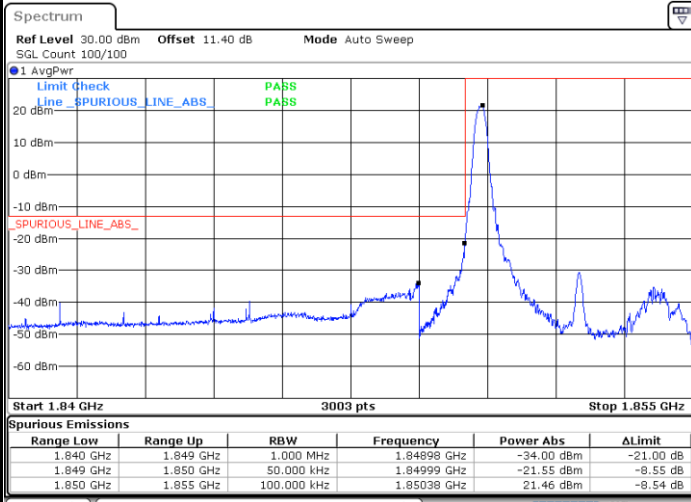

Date: 7.MAR.2021 06:51:55

Highest Band Edge / 1 RB

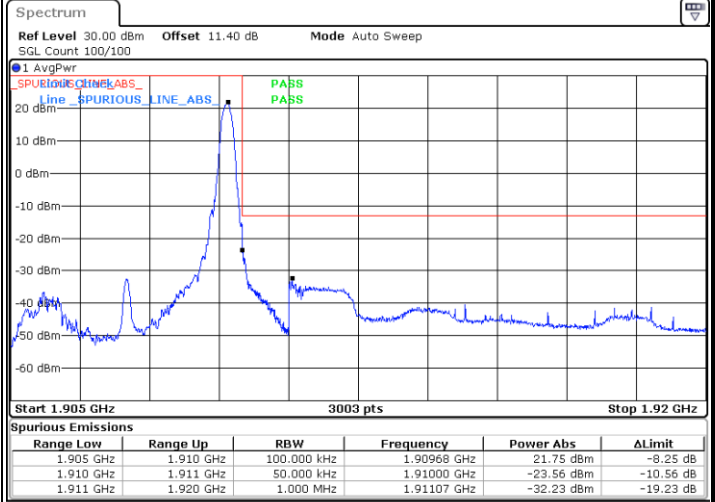

Date: 7.MAR.2021 06:55:27

Lowest Band Edge / Full RB

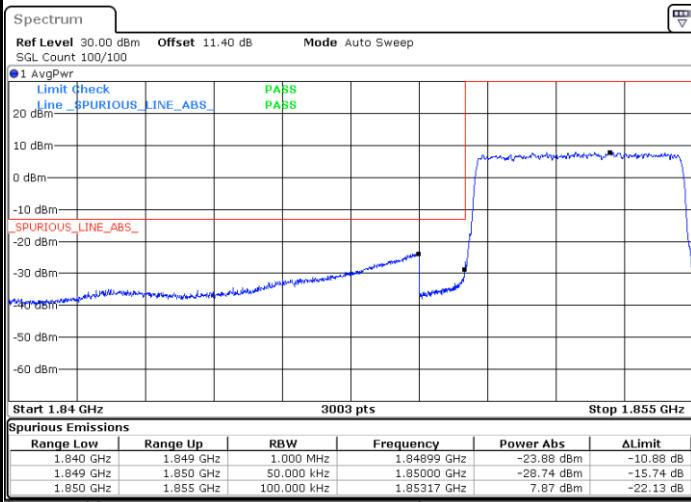

Date: 7.MAR.2021 06:52:30

Highest Band Edge / Full RB

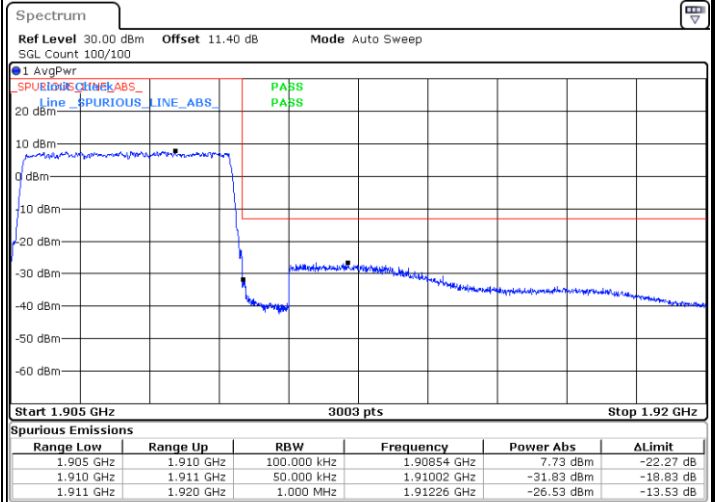

Date: 7.MAR.2021 06:56:02



LTE Band 2 / 5MHz / 16QAM

Lowest Band Edge / 1RB

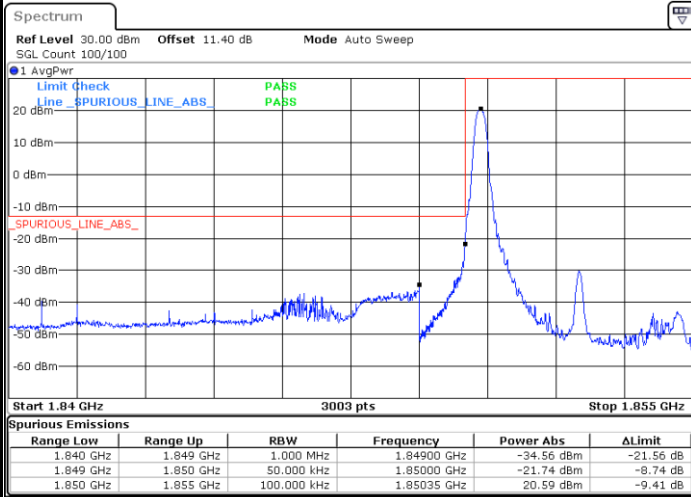

Date: 7.MAR.2021 06:52:13

Highest Band Edge / 1 RB

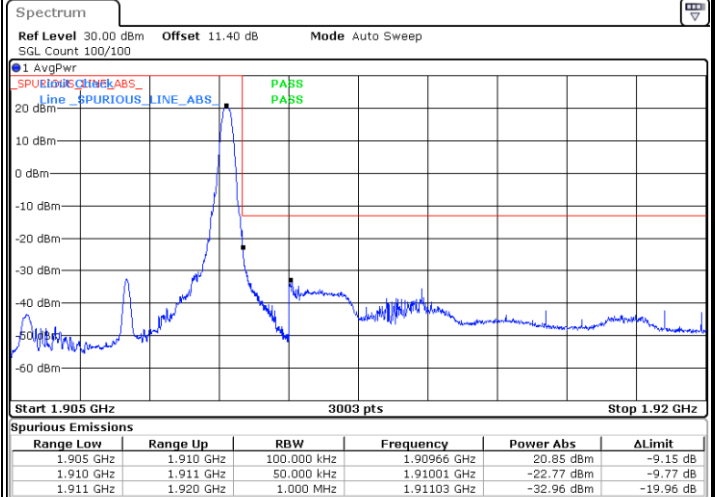

Date: 7.MAR.2021 06:55:44

Lowest Band Edge / Full RB

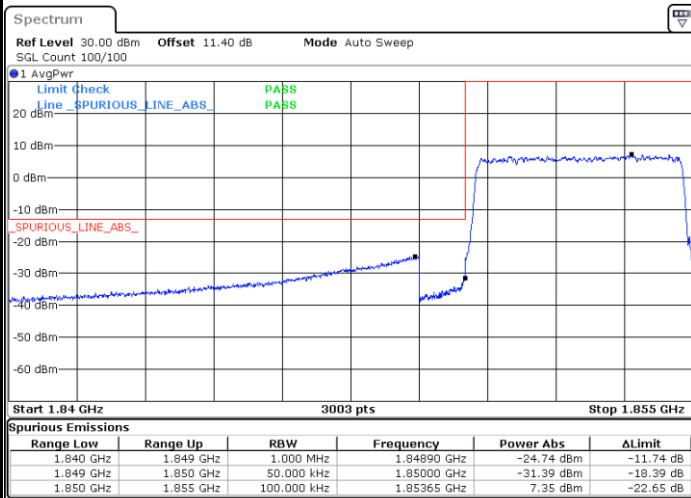

Date: 7.MAR.2021 06:52:48

Highest Band Edge / Full RB

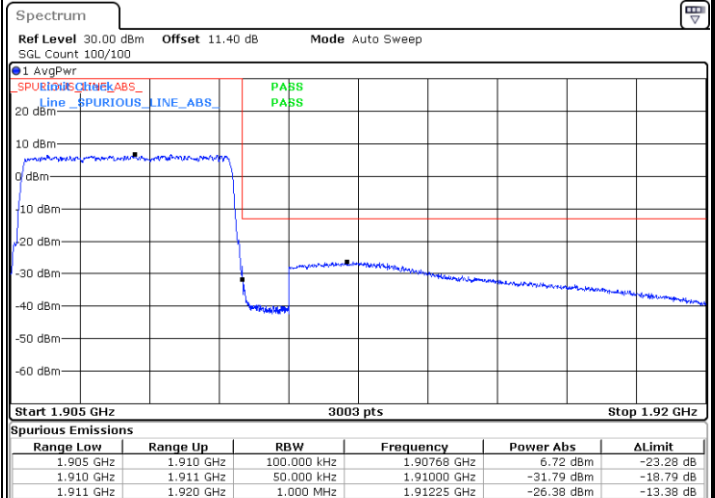

Date: 7.MAR.2021 06:56:19



LTE Band 2 / 5MHz / 64QAM

Lowest Band Edge / 1RB

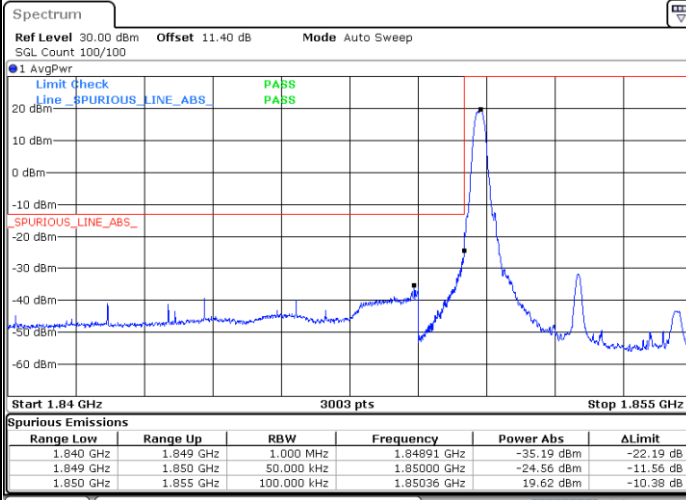

Date: 7.MAR.2021 07:15:29

Highest Band Edge / 1 RB

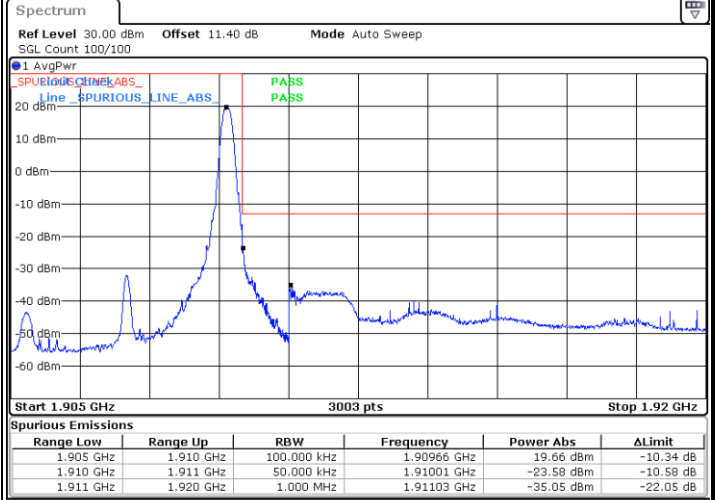

Date: 7.MAR.2021 07:16:28

Lowest Band Edge / Full RB

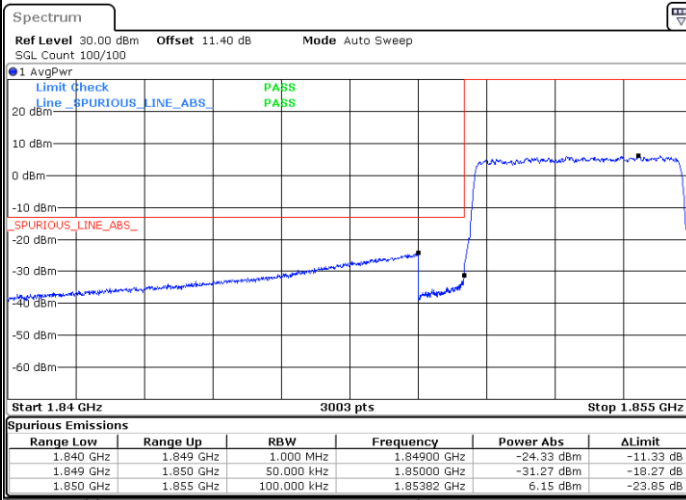

Date: 7.MAR.2021 07:15:47

Highest Band Edge / Full RB

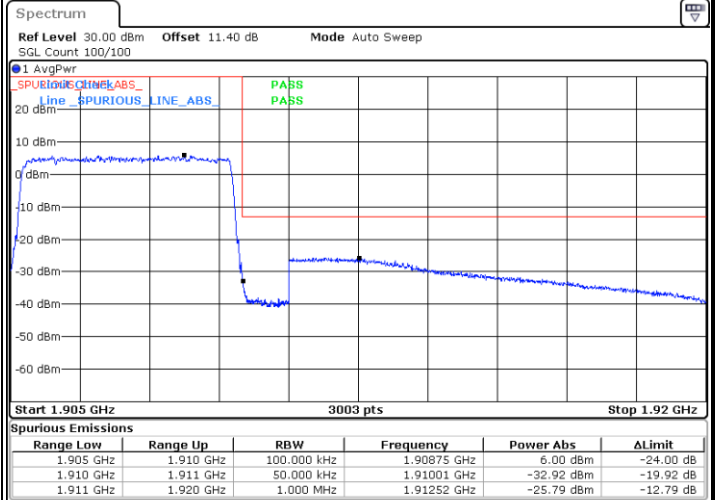

Date: 7.MAR.2021 07:16:45



LTE Band 2 / 5MHz / 256QAM

Lowest Band Edge / 1RB

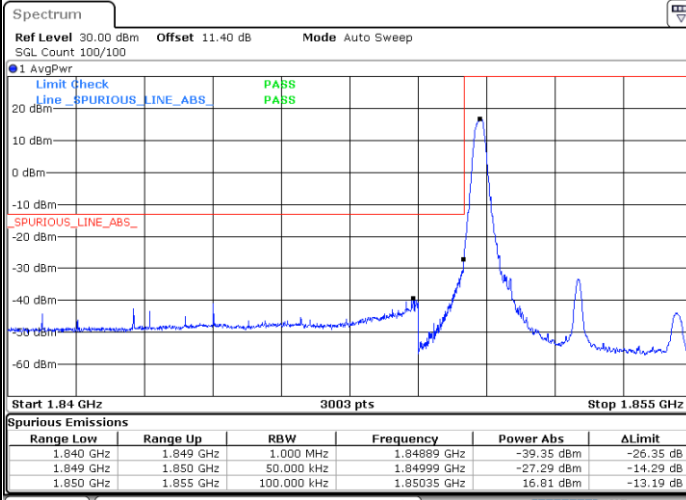

Date: 13.MAR.2021 15:05:05

Highest Band Edge / 1 RB

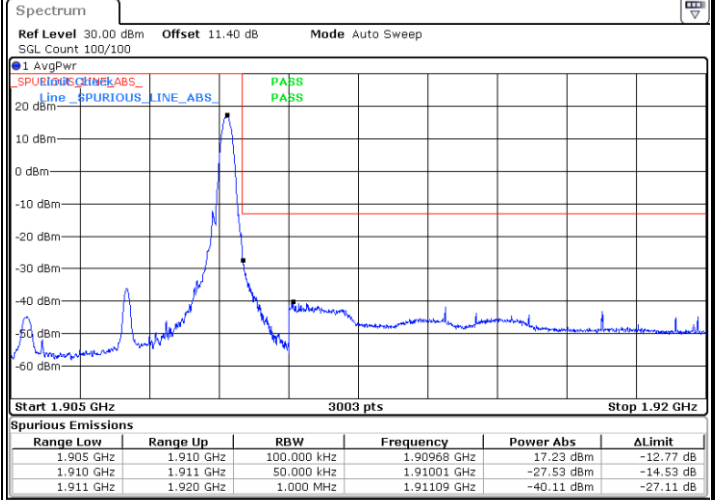

Date: 13.MAR.2021 15:13:18

Lowest Band Edge / Full RB

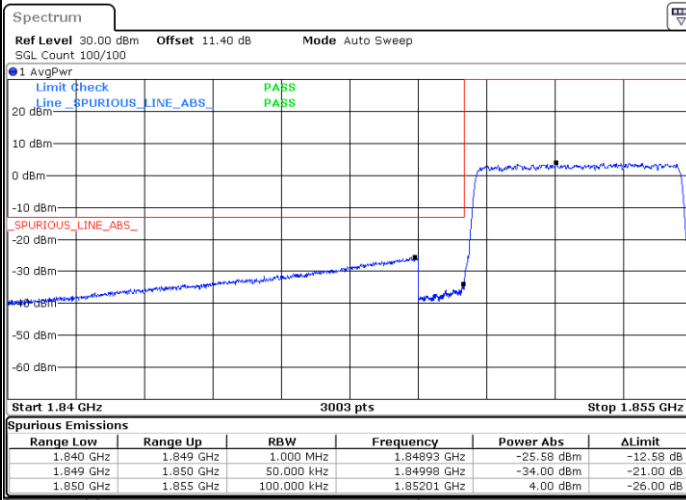

Date: 13.MAR.2021 15:04:43

Highest Band Edge / Full RB



Date: 13.MAR.2021 15:12:57