

802.11be_80MHz_Chain1_5290MHz

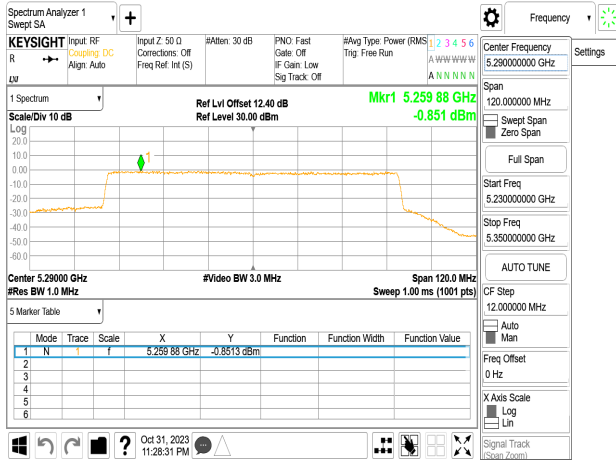

802.11be_80MHz_Chain1_5690MHz_UNII 2C

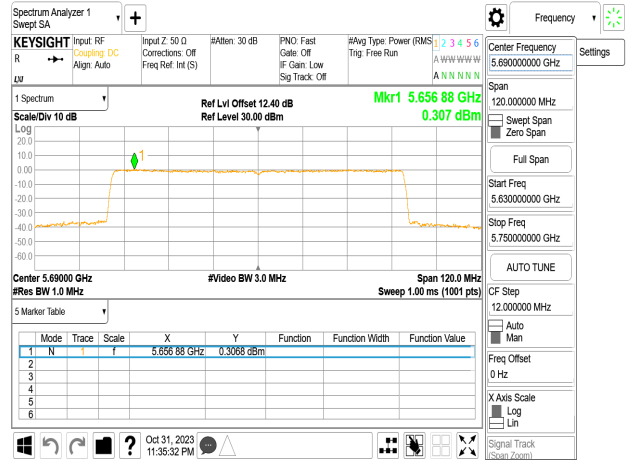

802.11be_80MHz_Chain1_5530MHz



802.11be_80MHz_Chain1_5690MHz_UNII 3

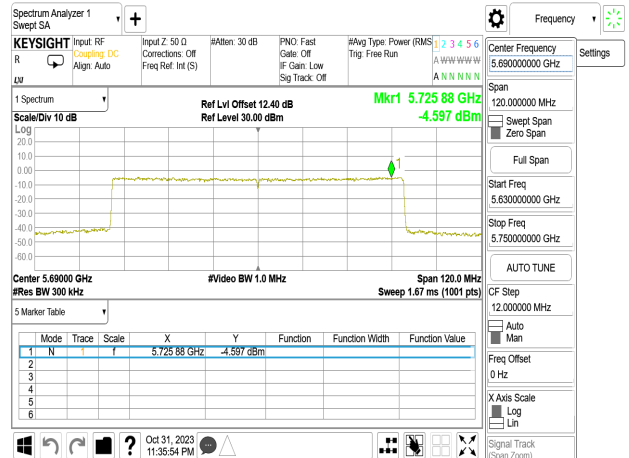

802.11be_80MHz_Chain1_5610MHz

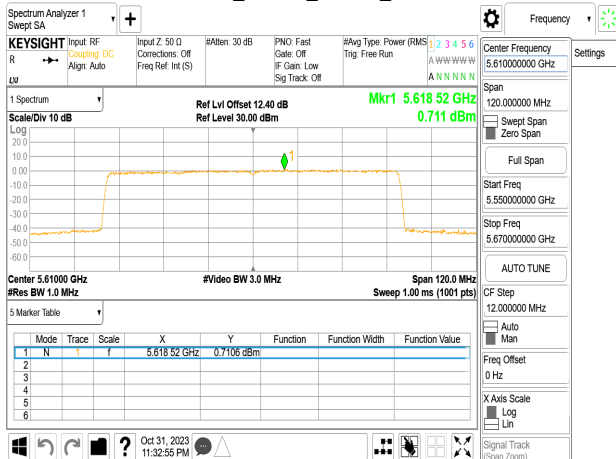

802.11be_80MHz_Chain1_5775MHz

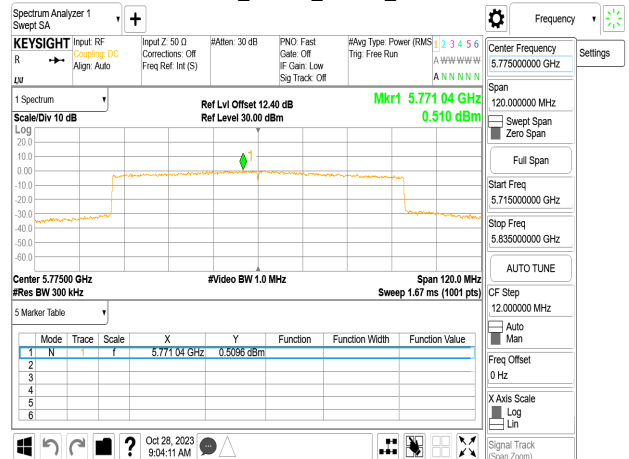

Unless otherwise stated the results shown in this test report refer only to the sample(s) tested and such sample(s) are retained for 90 days only.

除非另有說明，此報告結果僅對測試之樣品負責，同時此樣品僅保留90天。本報告未經本公司書面許可，不可部份複製。

This document is issued by the Company subject to its General Conditions of Service printed overleaf, available on request or accessible at <http://www.sgs.com.tw/Terms-and-Conditions>, and for electronic format documents, subject to Terms and Conditions for Electronic Documents at <http://www.sgs.com.tw/Terms-and-Conditions>. Attention is drawn to the limitation of liability, indemnification and jurisdiction issues defined therein. Any holder of this document is advised that information contained hereon reflects the Company's findings at the time of its intervention only and within the limits of Client's instructions, if any. The Company's sole responsibility is to its Client and this document does not exonerate parties to a transaction from exercising all their rights and obligations under the transaction documents. This document cannot be reproduced except in full, without prior written approval of the Company. Any unauthorized alteration, forgery or falsification of the content or appearance of this document is unlawful and offenders may be prosecuted to the fullest extent of the law.

802.11be_80MHz_Chain2_5210MHz

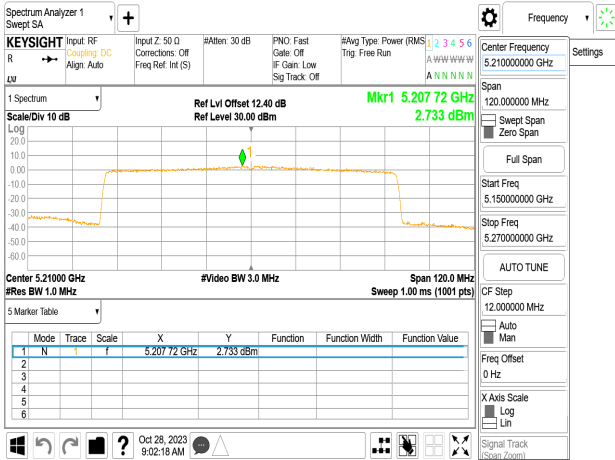

802.11be_80MHz_Chain2_5610MHz

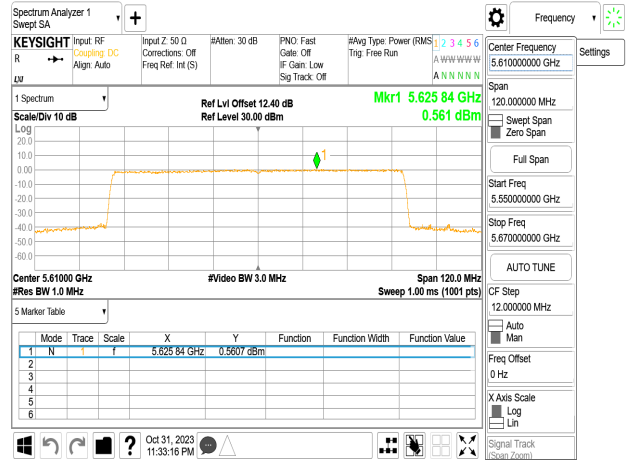

802.11be_80MHz_Chain2_5290MHz

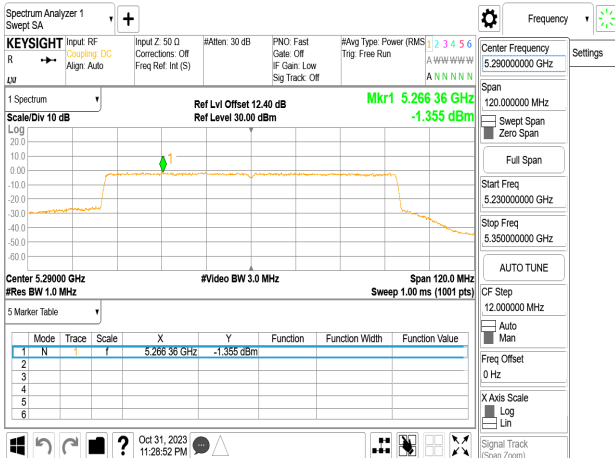

802.11be_80MHz_Chain2_5690MHz_UNII 2C

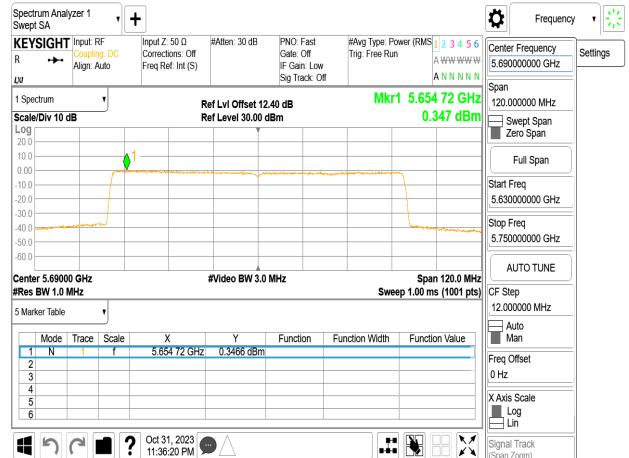

802.11be_80MHz_Chain2_5530MHz



802.11be_80MHz_Chain2_5690MHz_UNII 3



Unless otherwise stated the results shown in this test report refer only to the sample(s) tested and such sample(s) are retained for 90 days only.

除非另有說明，此報告結果僅對測試之樣品負責，同時此樣品僅保留90天。本報告未經本公司書面許可，不可部份複製。

This document is issued by the Company subject to its General Conditions of Service printed overleaf, available on request or accessible at <http://www.sgs.com.tw/Terms-and-Conditions>, and for electronic format documents, subject to Terms and Conditions for Electronic Documents at <http://www.sgs.com.tw/Terms-and-Conditions>. Attention is drawn to the limitation of liability, indemnification and jurisdiction issues defined therein. Any holder of this document is advised that information contained hereon reflects the Company's findings at the time of its intervention only and within the limits of Client's instructions, if any. The Company's sole responsibility is to its Client and this document does not exonerate parties to a transaction from exercising all their rights and obligations under the transaction documents. This document cannot be reproduced except in full, without prior written approval of the Company. Any unauthorized alteration, forgery or falsification of the content or appearance of this document is unlawful and offenders may be prosecuted to the fullest extent of the law.

802.11be_80MHz_Chain2_5775MHz

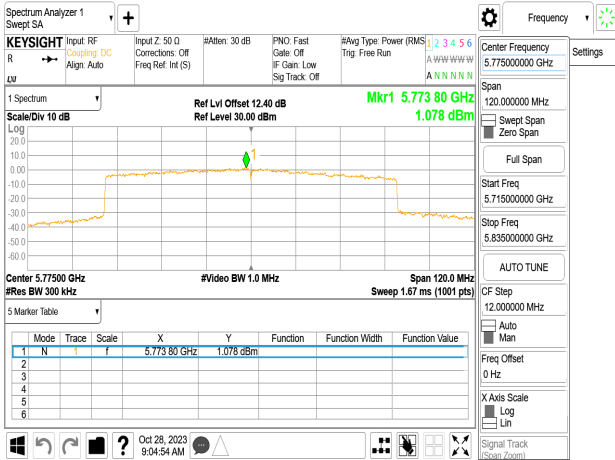

802.11be_80MHz_Chain3_5530MHz

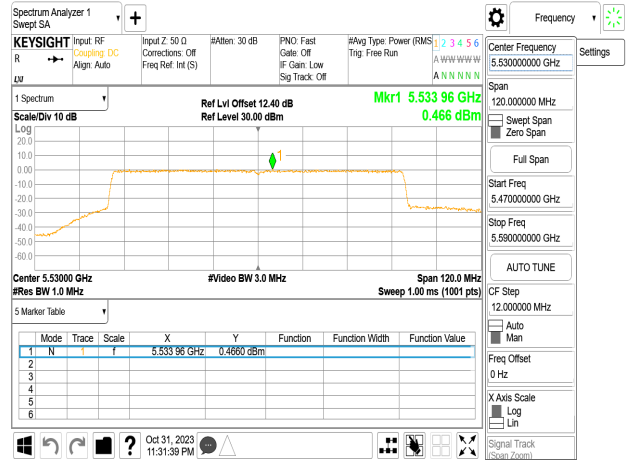

802.11be_80MHz_Chain3_5210MHz

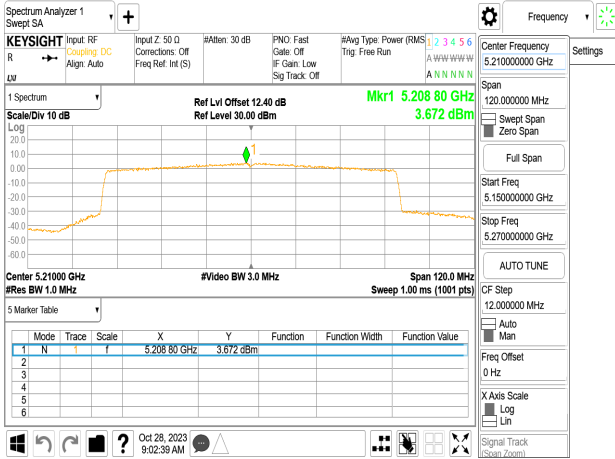

802.11be_80MHz_Chain3_5610MHz

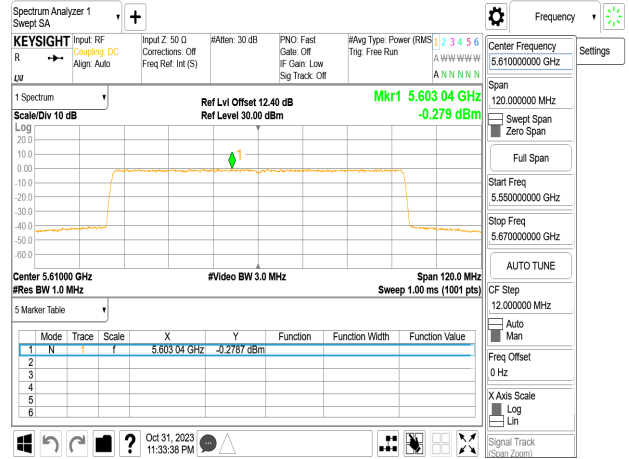

802.11be_80MHz_Chain3_5290MHz



802.11be_80MHz_Chain3_5690MHz_UNII 2C

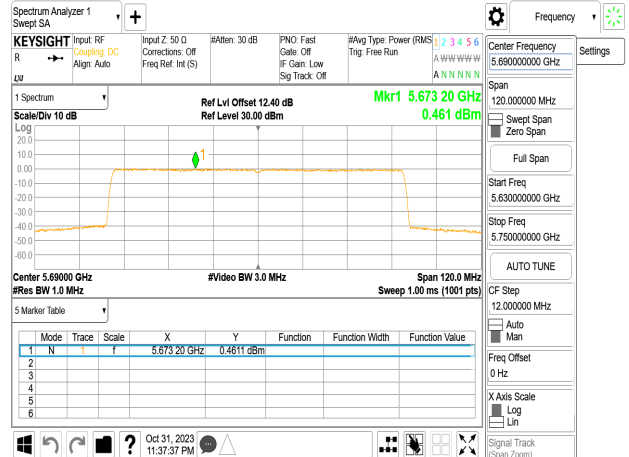

Unless otherwise stated the results shown in this test report refer only to the sample(s) tested and such sample(s) are retained for 90 days only.

除非另有說明，此報告結果僅對測試之樣品負責，同時此樣品僅保留90天。本報告未經本公司書面許可，不可部份複製。

This document is issued by the Company subject to its General Conditions of Service printed overleaf, available on request or accessible at <http://www.sgs.com.tw/Terms-and-Conditions>, and for electronic format documents, subject to Terms and Conditions for Electronic Documents at <http://www.sgs.com.tw/Terms-and-Conditions>. Attention is drawn to the limitation of liability, indemnification and jurisdiction issues defined therein. Any holder of this document is advised that information contained hereon reflects the Company's findings at the time of its intervention only and within the limits of Client's instructions, if any. The Company's sole responsibility is to its Client and this document does not exonerate parties to a transaction from exercising all their rights and obligations under the transaction documents. This document cannot be reproduced except in full, without prior written approval of the Company. Any unauthorized alteration, forgery or falsification of the content or appearance of this document is unlawful and offenders may be prosecuted to the fullest extent of the law.

802.11be_80MHz_Chain3_5690MHz_UNII 3

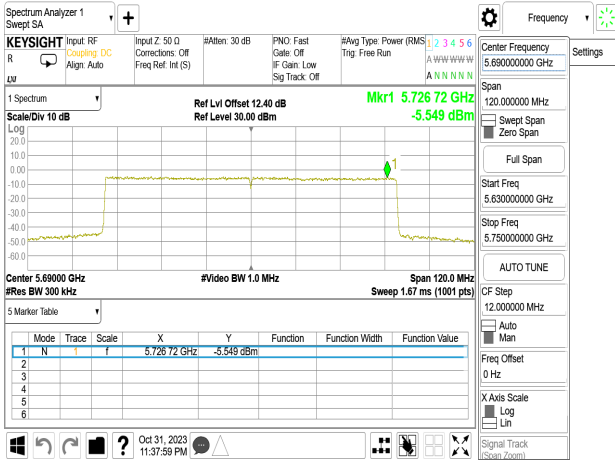

802.11be_160MHz_Chain0_5570MHz



802.11be_80MHz_Chain3_5775MHz

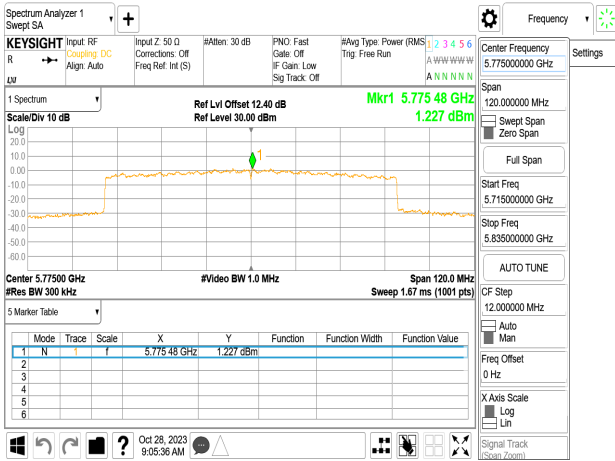

802.11be_160MHz_Chain1_5250MHz

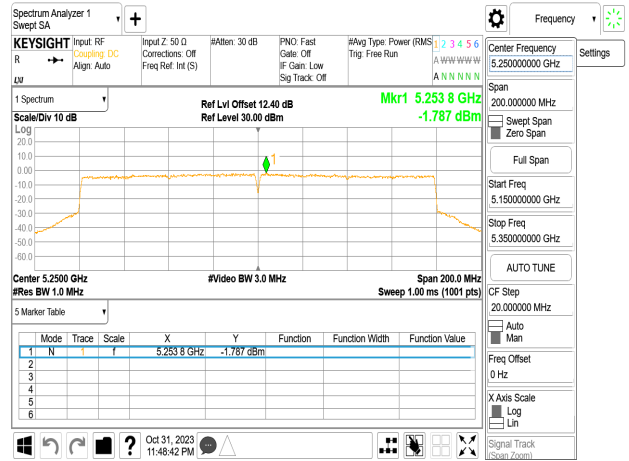

802.11be_160MHz_Chain0_5250MHz



802.11be_160MHz_Chain1_5570MHz

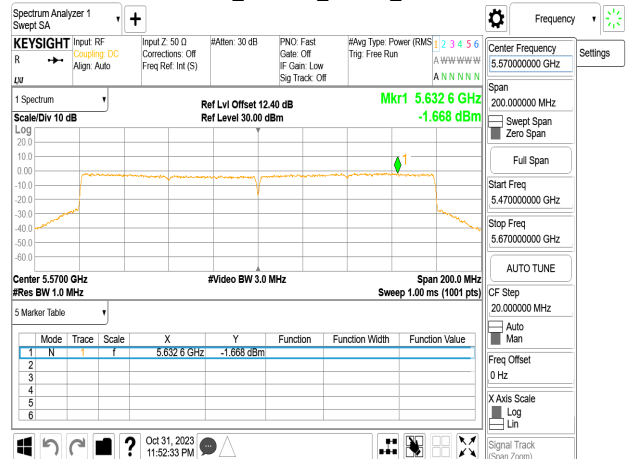

Unless otherwise stated the results shown in this test report refer only to the sample(s) tested and such sample(s) are retained for 90 days only.

除非另有說明，此報告結果僅對測試之樣品負責，同時此樣品僅保留90天。本報告未經本公司書面許可，不可部份複製。

This document is issued by the Company subject to its General Conditions of Service printed overleaf, available on request or accessible at <http://www.sgs.com.tw/Terms-and-Conditions>, and for electronic format documents, subject to Terms and Conditions for Electronic Documents at <http://www.sgs.com.tw/Terms-and-Conditions>. Attention is drawn to the limitation of liability, indemnification and jurisdiction issues defined therein. Any holder of this document is advised that information contained hereon reflects the Company's findings at the time of its intervention only and within the limits of Client's instructions, if any. The Company's sole responsibility is to its Client and this document does not exonerate parties to a transaction from exercising all their rights and obligations under the transaction documents. This document cannot be reproduced except in full, without prior written approval of the Company. Any unauthorized alteration, forgery or falsification of the content or appearance of this document is unlawful and offenders may be prosecuted to the fullest extent of the law.

802.11be_160MHz_Chain2_5250MHz

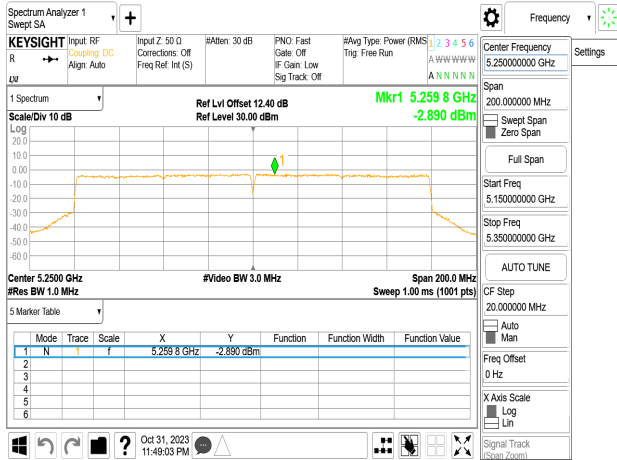

802.11be_160MHz_Chain3_5570MHz

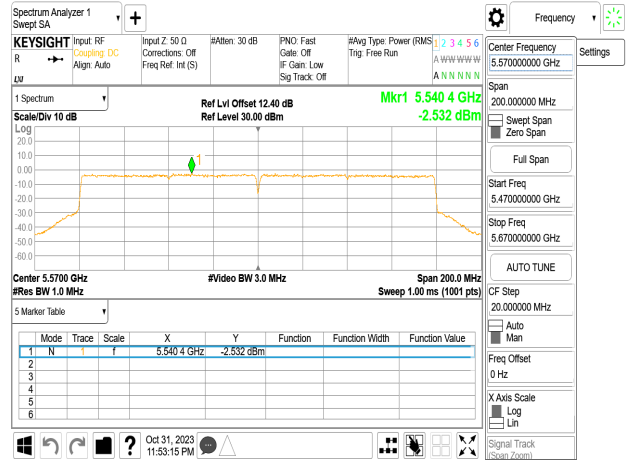

802.11be_160MHz_Chain2_5570MHz

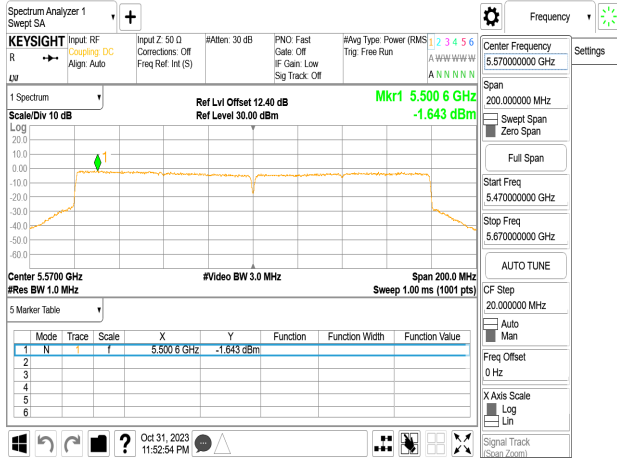

802.11be_160MHz_Chain3_5250MHz

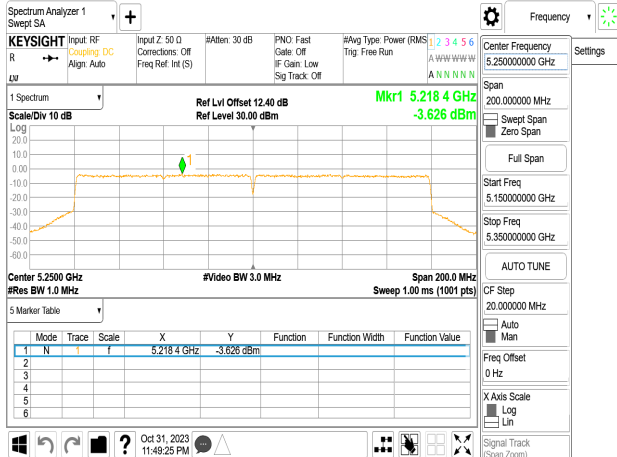

Unless otherwise stated the results shown in this test report refer only to the sample(s) tested and such sample(s) are retained for 90 days only.

除非另有說明，此報告結果僅對測試之樣品負責，同時此樣品僅保留90天。本報告未經本公司書面許可，不可部份複製。

This document is issued by the Company subject to its General Conditions of Service printed overleaf, available on request or accessible at <http://www.sgs.com.tw/Terms-and-Conditions>, and for electronic format documents, subject to Terms and Conditions for Electronic Documents at <http://www.sgs.com.tw/Terms-and-Conditions>. Attention is drawn to the limitation of liability, indemnification and jurisdiction issues defined therein. Any holder of this document is advised that information contained hereon reflects the Company's findings at the time of its intervention only and within the limits of Client's instructions, if any. The Company's sole responsibility is to its Client and this document does not exonerate parties to a transaction from exercising all their rights and obligations under the transaction documents. This document cannot be reproduced except in full, without prior written approval of the Company. Any unauthorized alteration, forgery or falsification of the content or appearance of this document is unlawful and offenders may be prosecuted to the fullest extent of the law.

11 UNDESIRABLE RADIATED EMISSION MEASUREMENT

11.1 Standard Applicable

$EIRP = (E^*d)^2 / 30$, where E is the field strength in V/m, d is the measurement distance (3m), $EIRP$ is the equivalent isotropically radiated power in Watts.

11.1.1 5150~5850 MHz

Applicable to	Operation Freq. (MHz)	EIRP		Field Strength @ 3m (dB μ V/m)
		Freq. (MHz)	Limits (dBm/MHz)	
15.407(b)(1) RSS-247 §6.2.1.2	5150~5250	f \leq 5150 f \geq 5350	PK: -27	PK: 68.2
15.407(b)(2) RSS-247 §6.2.2.2	5250~5350			
15.407(b)(3) RSS-247 §6.2.3.2	5475~5725			
15.407(b)(4)(i) RSS-247 §6.2.4.3	5725~5850	at 75 MHz or more above or below the band edge	PK:-27	PK: 68.2
		increasing linearly from 75~25MHz above or below the band edge	PK:-27~10	PK: 68.2~105.2
		increasing linearly from 25~5MHz above or below the band edge	PK:10~15.6	PK: 105.2~110.8
		increasing linearly from 5~0 MHz above or below the band edge	PK: 15.6~27	PK:110.8~122.2

11.1.2 Spurious Emission

Unwanted spurious emissions which fall in the restricted bands must comply with the radiated emission limits specified as below table:

Frequency (MHz)	Field strength (microvolts/meter)	Distance (meters)
0.009-0.490	2400/F(kHz)	300
0.490-1.705	24000/F(kHz)	30
1.705-30	30	30
30-88	100	3
88-216	150	3
216-960	200	3
Above 960	500	3

Note:

- The lower limit shall apply at the transition frequencies.

Unless otherwise stated the results shown in this test report refer only to the sample(s) tested and such sample(s) are retained for 90 days only.

除非另有說明，此報告結果僅對測試之樣品負責，同時此樣品僅保留90天。本報告未經本公司書面許可，不可部份複製。

This document is issued by the Company subject to its General Conditions of Service printed overleaf, available on request or accessible at <http://www.sgs.com.tw/Terms-and-Conditions>, and for electronic format documents, subject to Terms and Conditions for Electronic Documents at <http://www.sgs.com.tw/Terms-and-Conditions>. Attention is drawn to the limitation of liability, indemnification and jurisdiction issues defined therein. Any holder of this document is advised that information contained hereon reflects the Company's findings at the time of its intervention only and within the limits of Client's instructions, if any. The Company's sole responsibility is to its Client and this document does not exonerate parties to a transaction from exercising all their rights and obligations under the transaction documents. This document cannot be reproduced except in full, without prior written approval of the Company. Any unauthorized alteration, forgery or falsification of the content or appearance of this document is unlawful and offenders may be prosecuted to the fullest extent of the law.

11.2 Test Setup

(A) Radiated Emission Test Set-Up, Frequency Below 30MHz.

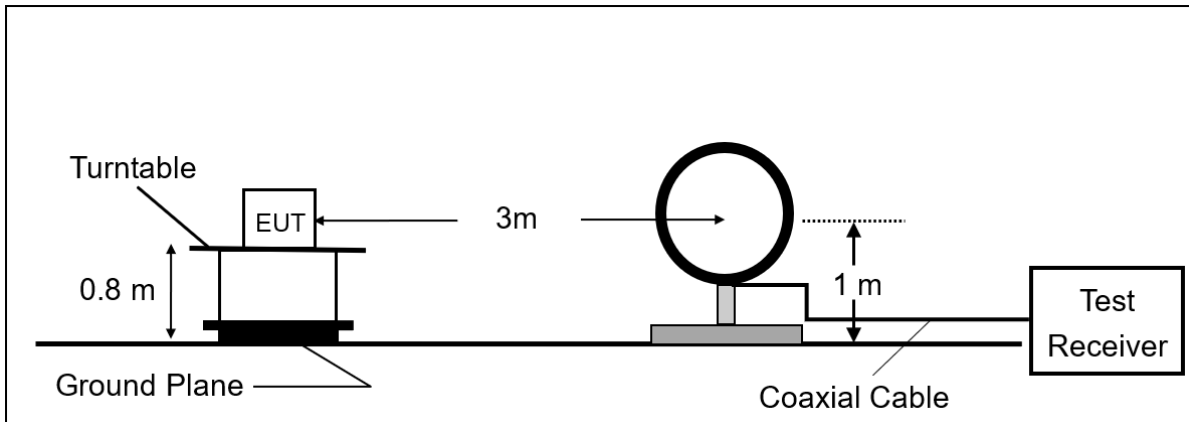

(B) Radiated Emission Test Set-Up, Frequency From 30MHz to 1000MHz

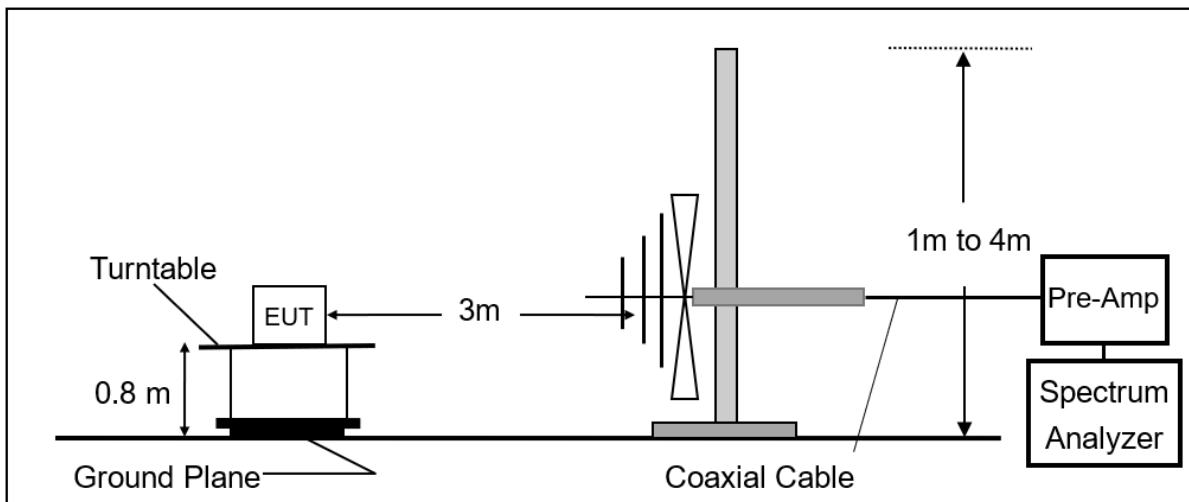

(C) Radiated Emission Test Set-Up, Frequency Above 1GHz

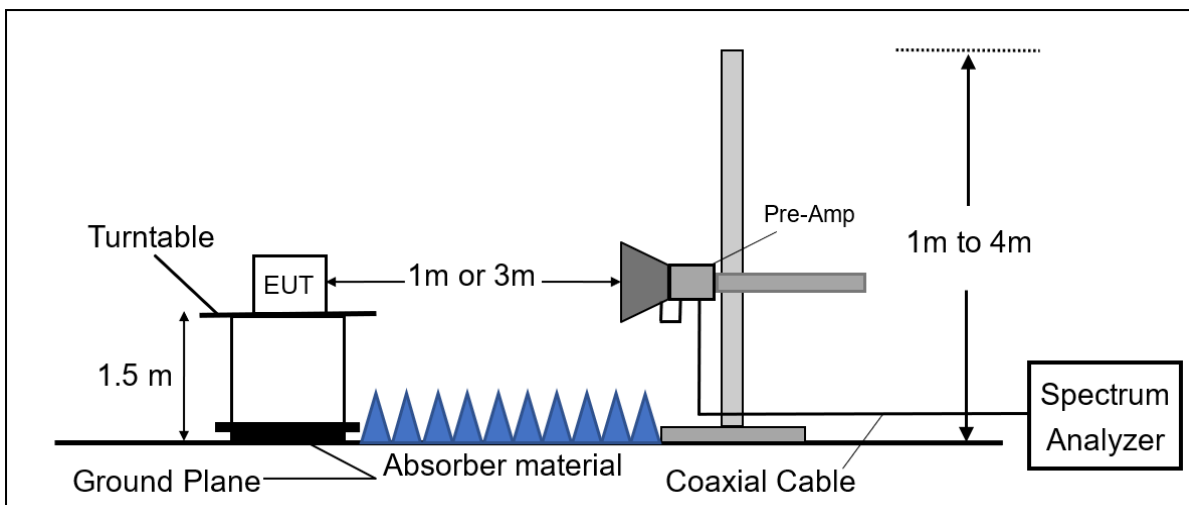

Unless otherwise stated the results shown in this test report refer only to the sample(s) tested and such sample(s) are retained for 90 days only.

除非另有說明，此報告結果僅對測試之樣品負責，同時此樣品僅保留90天。本報告未經本公司書面許可，不可部份複製。

This document is issued by the Company subject to its General Conditions of Service printed overleaf, available on request or accessible at <http://www.sgs.com.tw/Terms-and-Conditions> and for electronic format documents, subject to Terms and Conditions for Electronic Documents at <http://www.sgs.com.tw/Terms-and-Conditions>. Attention is drawn to the limitation of liability, indemnification and jurisdiction issues defined therein. Any holder of this document is advised that information contained herein reflects the Company's findings at the time of its intervention only and within the limits of Client's instructions, if any. The Company's sole responsibility is to its Client and this document does not exonerate parties to a transaction from exercising all their rights and obligations under the transaction documents. This document cannot be reproduced except in full, without prior written approval of the Company. Any unauthorized alteration, forgery or falsification of the content or appearance of this document is unlawful and offenders may be prosecuted to the fullest extent of the law.

11.3 Measurement Procedure

1. The testing follows FCC KDB 789033 D02.
2. The EUT was placed on a turn table with 0.8m for frequency < 1GHz and 1.5m for frequency > 1GHz above ground plane.
3. The turn table shall rotate 360 degrees to determine the position of maximum emission level.
4. EUT is set 3m away from the receiving antenna which varied from 1m to 4m to find out the highest emissions.
5. Set the spectrum analyzer as RBW=100 kHz and VBW=300 kHz for Peak Detector (PK) at frequency between 30MHz and 1 GHz
6. Use receiver mode as RBW=120 kHz for Quasi-peak (QP) at frequency between 30MHz and 1 GHz.
7. Set the spectrum analyzer as RBW=1 MHz, VBW=3 MHz for Maximum Emission Measurements at frequency above 1 GHz.
8. Set the spectrum analyzer as RBW=1 MHz, VBW=10 Hz (Duty cycle > 98%) or VBW ≥ 1/T (Duty cycle < 98%) for Average Emission Measurements at frequency above 1 GHz.
9. When measurement procedures for electric field radiated emissions above 1 GHz the EUT measurement is to be made “while keeping the antenna in the ‘cone of radiation’ from that area and pointed at the area both in azimuth and elevation, with polarization oriented for maximum response.” is still within the 3dB illumination BW of the measurement antenna.
10. Maximum procedure was performed on the six highest emissions to ensure EUT compliance.
11. And also, each emission was to be maximized by changing the polarization of receiving antenna both horizontal and vertical.
12. Repeat above procedures until all frequency measured were complete.

11.4 Field Strength Calculation

The field strength is calculated by adding the Antenna Factor and Cable Factor and subtracting the Amplifier Gain and Duty Cycle Correction Factor (if any) from the measured reading. The basic equation with a sample calculation is as follows:

$$FS = RA + AF + CL - AG$$

Where *FS = Field Strength*

CL = Cable Attenuation Factor (Cable Loss)

RA = Reading Amplitude

AG = Amplifier Gain

AF = Antenna Factor

*The limit of the emission level is expressed in dBuV/m, which converts 20*log(uV/m)*

Actual FS(dBμV/m) = SPA. Reading level(dBμV) + Factor(dB)

Factor(dB) = Antenna Factor(dBμV/m) + Cable Loss(dB) – Pre_Amplifier Gain(dB)

Unless otherwise stated the results shown in this test report refer only to the sample(s) tested and such sample(s) are retained for 90 days only.

除非另有說明，此報告結果僅對測試之樣品負責，同時此樣品僅保留90天。本報告未經本公司書面許可，不可部份複製。

This document is issued by the Company subject to its General Conditions of Service printed overleaf, available on request or accessible at <http://www.sgs.com.tw/Terms-and-Conditions> and for electronic format documents, subject to Terms and Conditions for Electronic Documents at <http://www.sgs.com.tw/Terms-and-Conditions>. Attention is drawn to the limitation of liability, indemnification and jurisdiction issues defined therein. Any holder of this document is advised that information contained hereon reflects the Company's findings at the time of its intervention only and within the limits of Client's instructions, if any. The Company's sole responsibility is to its Client and this document does not exonerate parties to a transaction from exercising all their rights and obligations under the transaction documents. This document cannot be reproduced except in full, without prior written approval of the Company. Any unauthorized alteration, forgery or falsification of the content or appearance of this document is unlawful and offenders may be prosecuted to the fullest extent of the law.

11.5 Test Results of Radiated Spurious Emissions from 9 kHz to 30 MHz

The low frequency, which started from 9 kHz to 30MHz, was pre-scanned and the result which was 20dB lower than the limit per 15.31(o) was not reported.

Pre-scan was done at frequency 5.47 GHz and 5.85 GHz for bandedge measurement of straddle channels 138, 142 and 144 which was 20dB lower than the limit per 15.31(o) was not reported.

Unless otherwise stated the results shown in this test report refer only to the sample(s) tested and such sample(s) are retained for 90 days only.

除非另有說明，此報告結果僅對測試之樣品負責，同時此樣品僅保留90天。本報告未經本公司書面許可，不可部份複製。

This document is issued by the Company subject to its General Conditions of Service printed overleaf, available on request or accessible at <http://www.sgs.com.tw/Terms-and-Conditions> and for electronic format documents, subject to Terms and Conditions for Electronic Documents at <http://www.sgs.com.tw/Terms-and-Conditions>. Attention is drawn to the limitation of liability, indemnification and jurisdiction issues defined therein. Any holder of this document is advised that information contained hereon reflects the Company's findings at the time of its intervention only and within the limits of Client's instructions, if any. The Company's sole responsibility is to its Client and this document does not exonerate parties to a transaction from exercising all their rights and obligations under the transaction documents. This document cannot be reproduced except in full, without prior written approval of the Company. Any unauthorized alteration, forgery or falsification of the content or appearance of this document is unlawful and offenders may be prosecuted to the fullest extent of the law.

11.6 Radiated Spurious Emission Measurement Result

11.6.1 Spurious Emission

Mode: CDD

Report Number	:TERF2308001923E2	Test Site	:SAC G Chamber
Operation Mode	:802.11a	Test Date	:2023-10-26
Test Frequency	:5220 MHz	Temp./Humi.	:23.6°C/57%
Test Mode	:Tx	Antenna Pol.	:Vertical
EUT Pol	:E2 Plane	Engineer	:Temo Chen

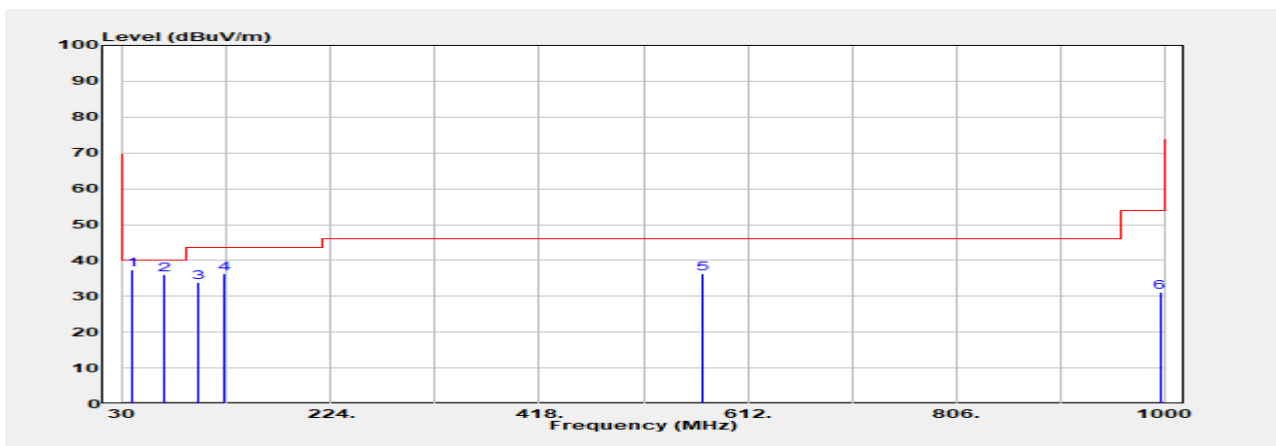

Freq. MHz	Detector Mode PK/QP/AVG	Spectrum Reading Level dB μ V	Factor dB	Actual FS dB μ V/m	Limit @3m dB μ V/m	Margin dB
38.730	QP	51.10	-13.59	37.51	40.00	-2.49
68.800	QP	50.80	-14.80	36.00	40.00	-4.00
100.810	Peak	51.18	-17.22	33.96	43.50	-9.54
125.060	Peak	51.17	-14.99	36.18	43.50	-7.32
570.290	Peak	42.25	-5.90	36.35	46.00	-9.65
996.120	Peak	30.59	0.59	31.18	54.00	-22.82

Unless otherwise stated the results shown in this test report refer only to the sample(s) tested and such sample(s) are retained for 90 days only.

除非另有說明，此報告結果僅對測試之樣品負責，同時此樣品僅保留90天。本報告未經本公司書面許可，不可部份複製。

This document is issued by the Company subject to its General Conditions of Service printed overleaf, available on request or accessible at <http://www.sgs.com.tw/Terms-and-Conditions> and for electronic format documents, subject to Terms and Conditions for Electronic Documents at <http://www.sgs.com.tw/Terms-and-Conditions>. Attention is drawn to the limitation of liability, indemnification and jurisdiction issues defined therein. Any holder of this document is advised that information contained hereon reflects the Company's findings at the time of its intervention only and within the limits of Client's instructions, if any. The Company's sole responsibility is to its Client and this document does not exonerate parties to a transaction from exercising all their rights and obligations under the transaction documents. This document cannot be reproduced except in full, without prior written approval of the Company. Any unauthorized alteration, forgery or falsification of the content or appearance of this document is unlawful and offenders may be prosecuted to the fullest extent of the law.

Report Number :TERF2308001923E2
 Operation Mode :802.11a
 Test Frequency :5220 MHz
 Test Mode :Tx
 EUT Pol :E2 Plane

Test Site :SAC G Chamber
 Test Date :2023-10-26
 Temp./Humi. :23.6°C/57%
 Antenna Pol. :Horizontal
 Engineer :Temo Chen

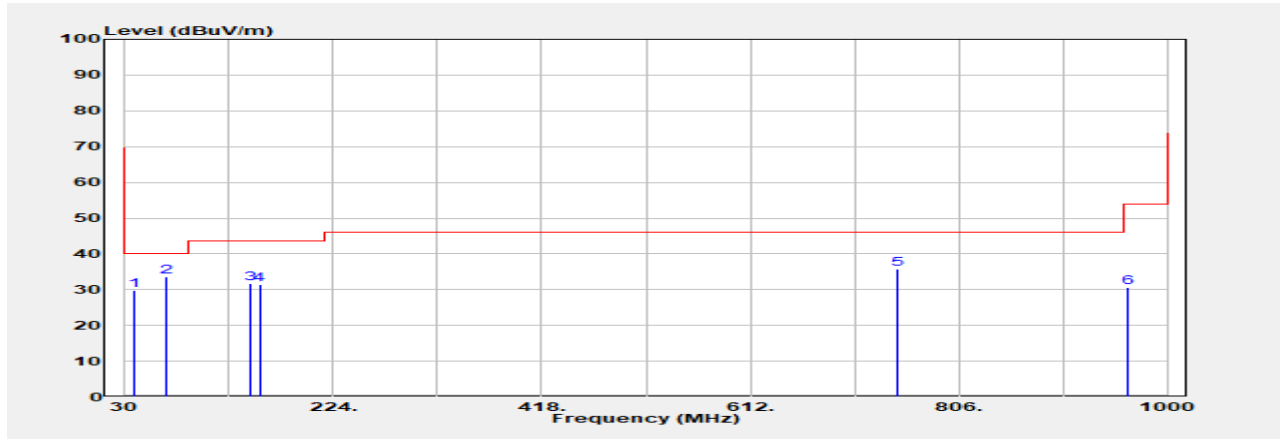

Freq. MHz	Detector Mode PK/QP/AVG	Spectrum Reading Level dBμV	Factor dB	Actual FS dBμV/m	Limit @3m dBμV/m	Margin dB
38.730	Peak	43.41	-13.59	29.82	40.00	-10.18
68.800	Peak	48.48	-14.80	33.68	40.00	-6.32
147.370	Peak	44.55	-12.78	31.77	43.50	-11.73
155.130	Peak	44.03	-12.49	31.53	43.50	-11.97
749.740	Peak	37.84	-2.06	35.78	46.00	-10.22
964.110	Peak	29.78	0.88	30.66	54.00	-23.34

Unless otherwise stated the results shown in this test report refer only to the sample(s) tested and such sample(s) are retained for 90 days only.

除非另有說明，此報告結果僅對測試之樣品負責，同時此樣品僅保留90天。本報告未經本公司書面許可，不可部份複製。

This document is issued by the Company subject to its General Conditions of Service printed overleaf, available on request or accessible at <http://www.sgs.com.tw/Terms-and-Conditions> and for electronic format documents, subject to Terms and Conditions for Electronic Documents at <http://www.sgs.com.tw/Terms-and-Conditions>. Attention is drawn to the limitation of liability, indemnification and jurisdiction issues defined therein. Any holder of this document is advised that information contained hereon reflects the Company's findings at the time of its intervention only and within the limits of Client's instructions, if any. The Company's sole responsibility is to its Client and this document does not exonerate parties to a transaction from exercising all their rights and obligations under the transaction documents. This document cannot be reproduced except in full, without prior written approval of the Company. Any unauthorized alteration, forgery or falsification of the content or appearance of this document is unlawful and offenders may be prosecuted to the fullest extent of the law.

Report Number :TERF2308001923E2
 Operation Mode :802.11a
 Test Frequency :5300 MHz
 Test Mode :Tx
 EUT Pol :E2 Plane

Test Site :SAC G Chamber
 Test Date :2023-10-26
 Temp./Humi. :23.6°C/57%
 Antenna Pol. :Vertical
 Engineer :Temo Chen

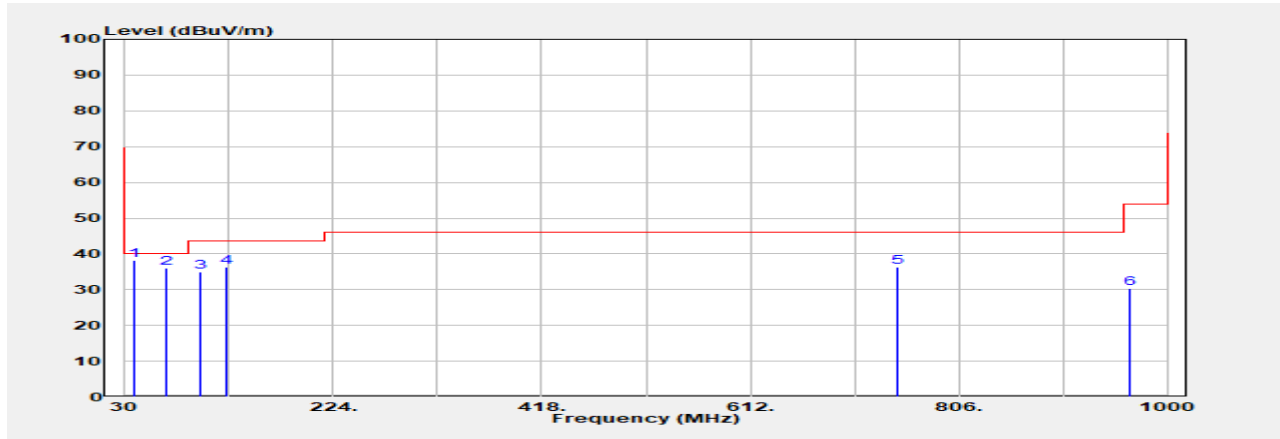

Freq. MHz	Detector Mode PK/QP/AVG	Spectrum Reading Level dB μ V	Factor dB	Actual FS dB μ V/m	Limit @3m dB μ V/m	Margin dB
38.730	QP	51.80	-13.59	38.21	40.00	-1.79
68.800	QP	50.90	-14.80	36.10	40.00	-3.90
100.810	Peak	52.17	-17.22	34.95	43.50	-8.55
125.060	Peak	51.25	-14.99	36.26	43.50	-7.24
749.740	Peak	38.46	-2.06	36.40	46.00	-9.61
966.050	Peak	29.48	0.89	30.37	54.00	-23.63

Unless otherwise stated the results shown in this test report refer only to the sample(s) tested and such sample(s) are retained for 90 days only.

除非另有說明，此報告結果僅對測試之樣品負責，同時此樣品僅保留90天。本報告未經本公司書面許可，不可部份複製。

This document is issued by the Company subject to its General Conditions of Service printed overleaf, available on request or accessible at <http://www.sgs.com.tw/Terms-and-Conditions> and for electronic format documents, subject to Terms and Conditions for Electronic Documents at <http://www.sgs.com.tw/Terms-and-Conditions>. Attention is drawn to the limitation of liability, indemnification and jurisdiction issues defined therein. Any holder of this document is advised that information contained hereon reflects the Company's findings at the time of its intervention only and within the limits of Client's instructions, if any. The Company's sole responsibility is to its Client and this document does not exonerate parties to a transaction from exercising all their rights and obligations under the transaction documents. This document cannot be reproduced except in full, without prior written approval of the Company. Any unauthorized alteration, forgery or falsification of the content or appearance of this document is unlawful and offenders may be prosecuted to the fullest extent of the law.

Report Number :TERF2308001923E2
 Operation Mode :802.11a
 Test Frequency :5300 MHz
 Test Mode :Tx
 EUT Pol :E2 Plane

Test Site :SAC G Chamber
 Test Date :2023-10-26
 Temp./Humi. :23.6°C/57%
 Antenna Pol. :Horizontal
 Engineer :Temo Chen

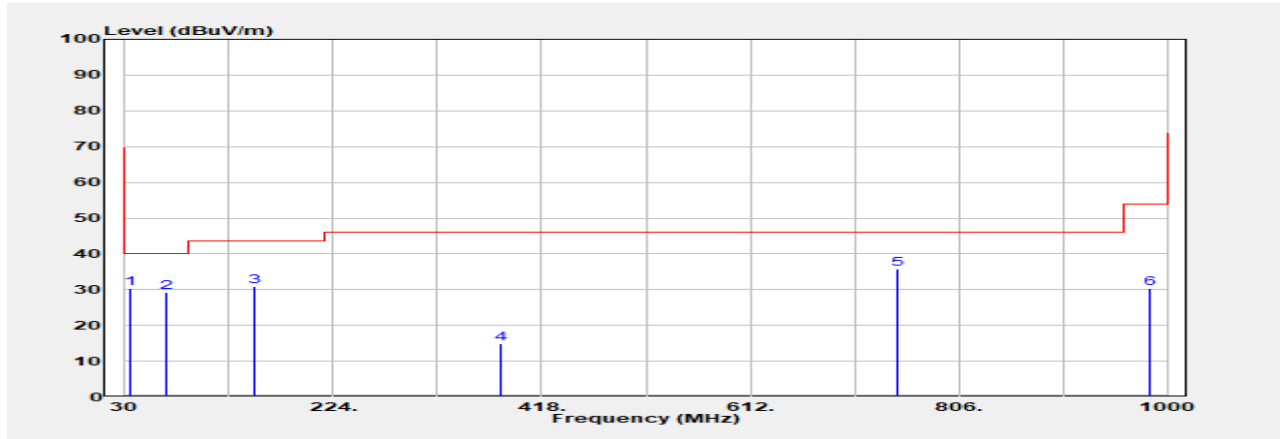

Freq. MHz	Detector Mode PK/QP/AVG	Spectrum Reading Level dB μ V	Factor dB	Actual FS dB μ V/m	Limit @3m dB μ V/m	Margin dB
34.850	Peak	44.43	-14.03	30.39	40.00	-9.61
68.800	QP	44.20	-14.80	29.40	40.00	-10.60
151.250	Peak	43.58	-12.71	30.87	43.50	-12.63
380.170	QP	24.70	-9.74	14.96	46.00	-31.04
749.740	Peak	37.78	-2.06	35.72	46.00	-10.28
984.480	Peak	29.67	0.80	30.47	54.00	-23.53

Unless otherwise stated the results shown in this test report refer only to the sample(s) tested and such sample(s) are retained for 90 days only.

除非另有說明，此報告結果僅對測試之樣品負責，同時此樣品僅保留90天。本報告未經本公司書面許可，不可部份複製。

This document is issued by the Company subject to its General Conditions of Service printed overleaf, available on request or accessible at <http://www.sgs.com.tw/Terms-and-Conditions> and for electronic format documents, subject to Terms and Conditions for Electronic Documents at <http://www.sgs.com.tw/Terms-and-Conditions>. Attention is drawn to the limitation of liability, indemnification and jurisdiction issues defined therein. Any holder of this document is advised that information contained hereon reflects the Company's findings at the time of its intervention only and within the limits of Client's instructions, if any. The Company's sole responsibility is to its Client and this document does not exonerate parties to a transaction from exercising all their rights and obligations under the transaction documents. This document cannot be reproduced except in full, without prior written approval of the Company. Any unauthorized alteration, forgery or falsification of the content or appearance of this document is unlawful and offenders may be prosecuted to the fullest extent of the law.

Report Number :TERF2308001923E2
 Operation Mode :802.11a
 Test Frequency :5580 MHz
 Test Mode :Tx
 EUT Pol :E2 Plane

Test Site :SAC G Chamber
 Test Date :2023-10-26
 Temp./Humi. :23.6°C/57%
 Antenna Pol. :Vertical
 Engineer :Temo Chen

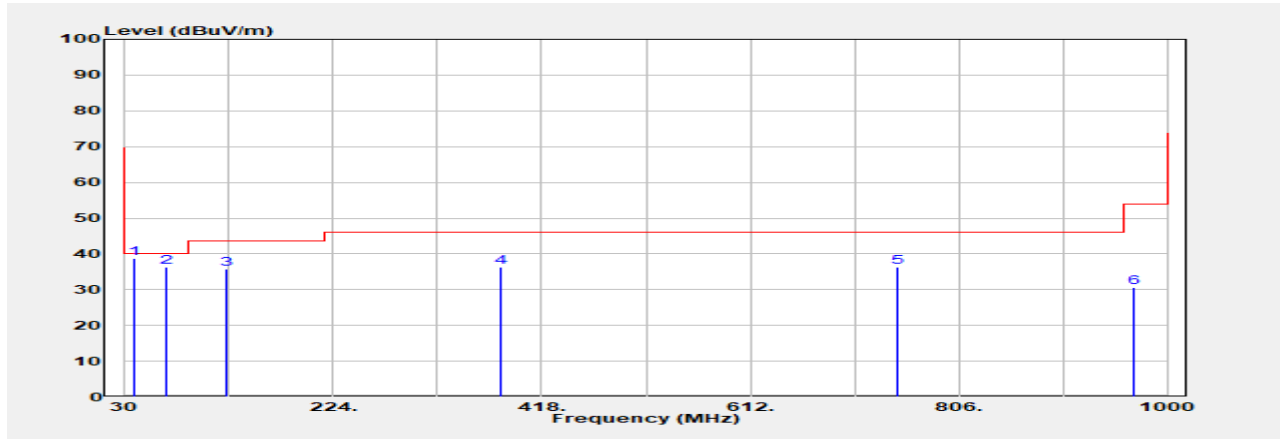

Freq. MHz	Detector Mode PK/QP/AVG	Spectrum Reading Level dBμV	Factor dB	Actual FS dBμV/m	Limit @3m dBμV/m	Margin dB
38.730	QP	52.30	-13.59	38.71	40.00	-1.29
68.800	QP	51.10	-14.80	36.30	40.00	-3.70
125.060	Peak	50.86	-14.99	35.87	43.50	-7.63
380.170	Peak	46.03	-9.74	36.30	46.00	-9.70
749.740	Peak	38.29	-2.06	36.23	46.00	-9.77
968.960	Peak	29.65	0.91	30.56	54.00	-23.44

Unless otherwise stated the results shown in this test report refer only to the sample(s) tested and such sample(s) are retained for 90 days only.

除非另有說明，此報告結果僅對測試之樣品負責，同時此樣品僅保留90天。本報告未經本公司書面許可，不可部份複製。

This document is issued by the Company subject to its General Conditions of Service printed overleaf, available on request or accessible at <http://www.sgs.com.tw/Terms-and-Conditions> and for electronic format documents, subject to Terms and Conditions for Electronic Documents at <http://www.sgs.com.tw/Terms-and-Conditions>. Attention is drawn to the limitation of liability, indemnification and jurisdiction issues defined therein. Any holder of this document is advised that information contained hereon reflects the Company's findings at the time of its intervention only and within the limits of Client's instructions, if any. The Company's sole responsibility is to its Client and this document does not exonerate parties to a transaction from exercising all their rights and obligations under the transaction documents. This document cannot be reproduced except in full, without prior written approval of the Company. Any unauthorized alteration, forgery or falsification of the content or appearance of this document is unlawful and offenders may be prosecuted to the fullest extent of the law.

Report Number :TERF2308001923E2
 Operation Mode :802.11a
 Test Frequency :5580 MHz
 Test Mode :Tx
 EUT Pol :E2 Plane

Test Site :SAC G Chamber
 Test Date :2023-10-26
 Temp./Humi. :23.6°C/57%
 Antenna Pol. :Horizontal
 Engineer :Temo Chen

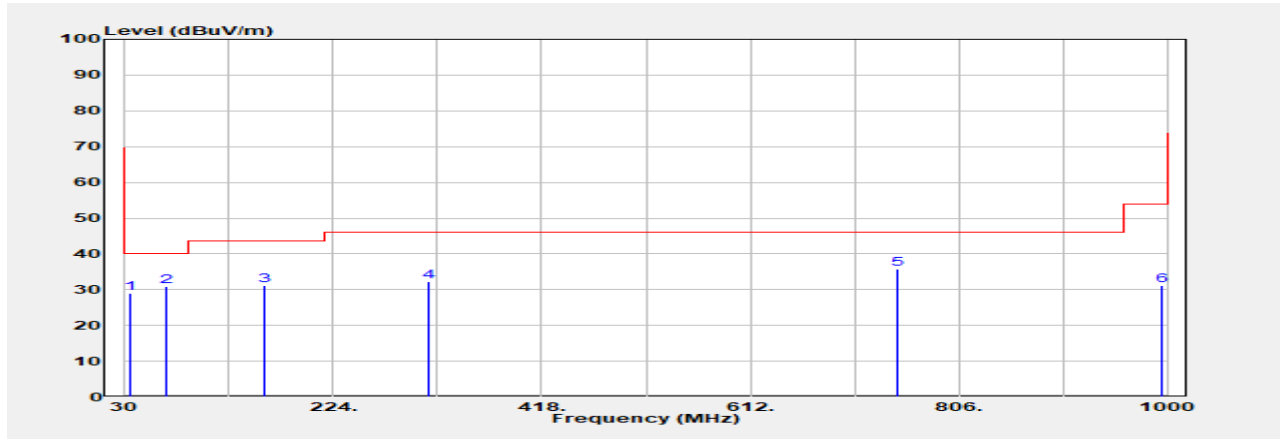

Freq. MHz	Detector Mode PK/QP/AVG	Spectrum Reading Level dBUV	Factor dB	Actual FS dBUV/m	Limit @3m dBUV/m	Margin dB
34.850	Peak	43.08	-14.03	29.05	40.00	-10.95
68.800	QP	45.60	-14.80	30.80	40.00	-9.20
159.010	Peak	43.80	-12.52	31.28	43.50	-12.22
312.270	Peak	44.12	-11.75	32.37	46.00	-13.63
749.740	Peak	37.93	-2.06	35.87	46.00	-10.13
995.150	Peak	30.62	0.62	31.24	54.00	-22.76

Unless otherwise stated the results shown in this test report refer only to the sample(s) tested and such sample(s) are retained for 90 days only.

除非另有說明，此報告結果僅對測試之樣品負責，同時此樣品僅保留90天。本報告未經本公司書面許可，不可部份複製。

This document is issued by the Company subject to its General Conditions of Service printed overleaf, available on request or accessible at <http://www.sgs.com.tw/Terms-and-Conditions> and for electronic format documents, subject to Terms and Conditions for Electronic Documents at <http://www.sgs.com.tw/Terms-and-Conditions>. Attention is drawn to the limitation of liability, indemnification and jurisdiction issues defined therein. Any holder of this document is advised that information contained hereon reflects the Company's findings at the time of its intervention only and within the limits of Client's instructions, if any. The Company's sole responsibility is to its Client and this document does not exonerate parties to a transaction from exercising all their rights and obligations under the transaction documents. This document cannot be reproduced except in full, without prior written approval of the Company. Any unauthorized alteration, forgery or falsification of the content or appearance of this document is unlawful and offenders may be prosecuted to the fullest extent of the law.

Report Number :TERF2308001923E2
 Operation Mode :802.11a
 Test Frequency :5785 MHz
 Test Mode :Tx
 EUT Pol :E2 Plane

Test Site :SAC G Chamber
 Test Date :2023-10-26
 Temp./Humi. :23.6°C/57%
 Antenna Pol. :Vertical
 Engineer :Temo Chen

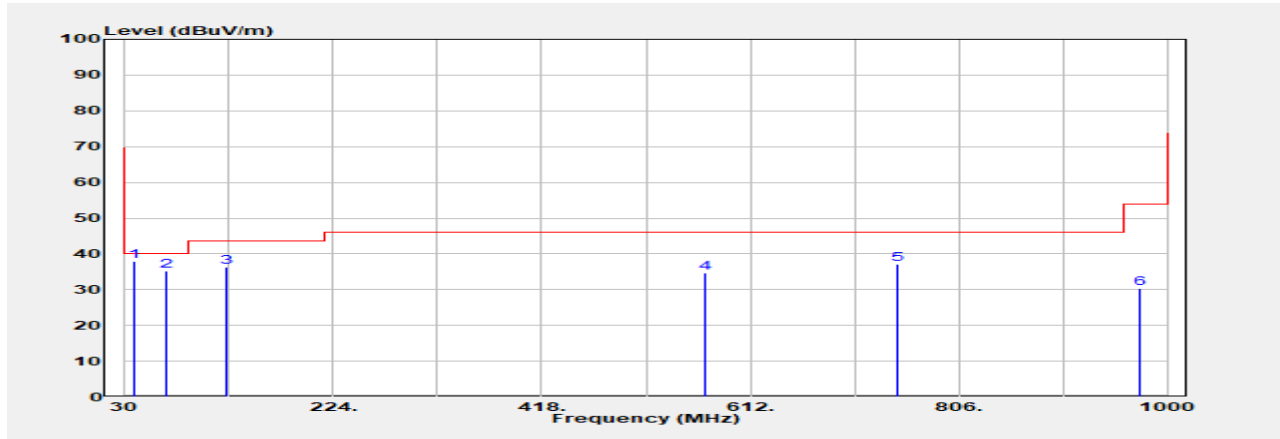

Freq. MHz	Detector Mode PK/QP/AVG	Spectrum Reading Level dB μ V	Factor dB	Actual FS dB μ V/m	Limit @3m dB μ V/m	Margin dB
38.730	QP	51.50	-13.59	37.91	40.00	-2.09
68.800	QP	49.90	-14.80	35.10	40.00	-4.90
125.060	Peak	51.24	-14.99	36.24	43.50	-7.26
570.290	Peak	40.52	-5.90	34.62	46.00	-11.38
749.740	Peak	39.22	-2.06	37.16	46.00	-8.84
973.810	Peak	29.55	0.92	30.46	54.00	-23.54

Unless otherwise stated the results shown in this test report refer only to the sample(s) tested and such sample(s) are retained for 90 days only.

除非另有說明，此報告結果僅對測試之樣品負責，同時此樣品僅保留90天。本報告未經本公司書面許可，不可部份複製。

This document is issued by the Company subject to its General Conditions of Service printed overleaf, available on request or accessible at <http://www.sgs.com.tw/Terms-and-Conditions> and for electronic format documents, subject to Terms and Conditions for Electronic Documents at <http://www.sgs.com.tw/Terms-and-Conditions>. Attention is drawn to the limitation of liability, indemnification and jurisdiction issues defined therein. Any holder of this document is advised that information contained hereon reflects the Company's findings at the time of its intervention only and within the limits of Client's instructions, if any. The Company's sole responsibility is to its Client and this document does not exonerate parties to a transaction from exercising all their rights and obligations under the transaction documents. This document cannot be reproduced except in full, without prior written approval of the Company. Any unauthorized alteration, forgery or falsification of the content or appearance of this document is unlawful and offenders may be prosecuted to the fullest extent of the law.

Report Number :TERF2308001923E2
 Operation Mode :802.11a
 Test Frequency :5785 MHz
 Test Mode :Tx
 EUT Pol :E2 Plane

Test Site :SAC G Chamber
 Test Date :2023-10-26
 Temp./Humi. :23.6°C/57%
 Antenna Pol. :Horizontal
 Engineer :Temo Chen

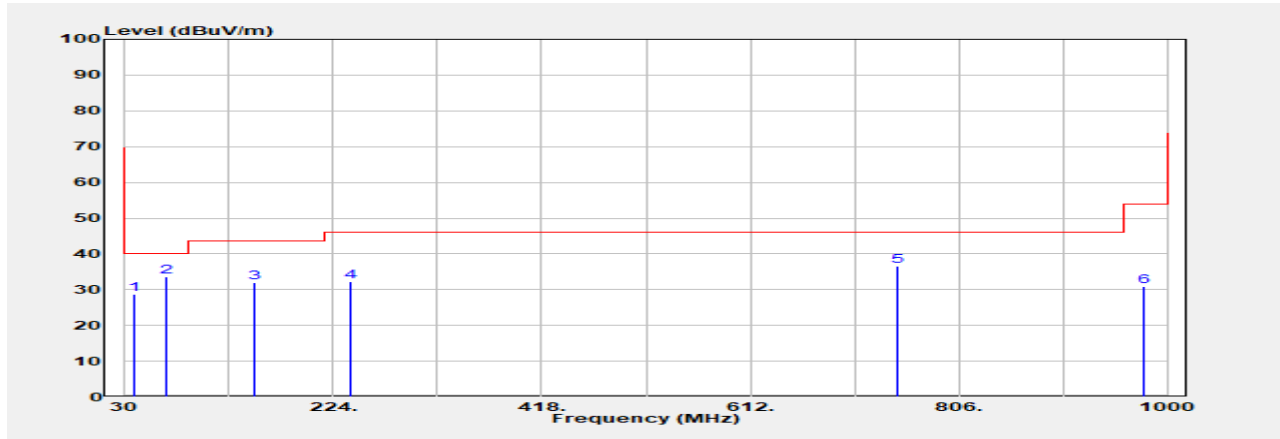

Freq. MHz	Detector Mode PK/QP/AVG	Spectrum Reading Level dBμV	Factor dB	Actual FS dBμV/m	Limit @3m dBμV/m	Margin dB
38.730	Peak	42.44	-13.59	28.85	40.00	-11.15
68.800	Peak	48.36	-14.80	33.56	40.00	-6.44
151.250	Peak	44.79	-12.71	32.08	43.50	-11.42
240.490	Peak	46.32	-14.07	32.24	46.00	-13.76
749.740	Peak	38.54	-2.06	36.48	46.00	-9.52
977.690	Peak	30.15	0.86	31.01	54.00	-22.99

Unless otherwise stated the results shown in this test report refer only to the sample(s) tested and such sample(s) are retained for 90 days only.

除非另有說明，此報告結果僅對測試之樣品負責，同時此樣品僅保留90天。本報告未經本公司書面許可，不可部份複製。

This document is issued by the Company subject to its General Conditions of Service printed overleaf, available on request or accessible at <http://www.sgs.com.tw/Terms-and-Conditions> and for electronic format documents, subject to Terms and Conditions for Electronic Documents at <http://www.sgs.com.tw/Terms-and-Conditions>. Attention is drawn to the limitation of liability, indemnification and jurisdiction issues defined therein. Any holder of this document is advised that information contained hereon reflects the Company's findings at the time of its intervention only and within the limits of Client's instructions, if any. The Company's sole responsibility is to its Client and this document does not exonerate parties to a transaction from exercising all their rights and obligations under the transaction documents. This document cannot be reproduced except in full, without prior written approval of the Company. Any unauthorized alteration, forgery or falsification of the content or appearance of this document is unlawful and offenders may be prosecuted to the fullest extent of the law.

Report Number :TERF2308001923E2
 Operation Mode :802.11be160
 Test Frequency :5250 MHz
 Test Mode :Tx
 EUT Pol :E2 Plane

Test Site :SAC G Chamber
 Test Date :2023-10-26
 Temp./Humi. :23.6°C/57%
 Antenna Pol. :Vertical
 Engineer :Temo Chen

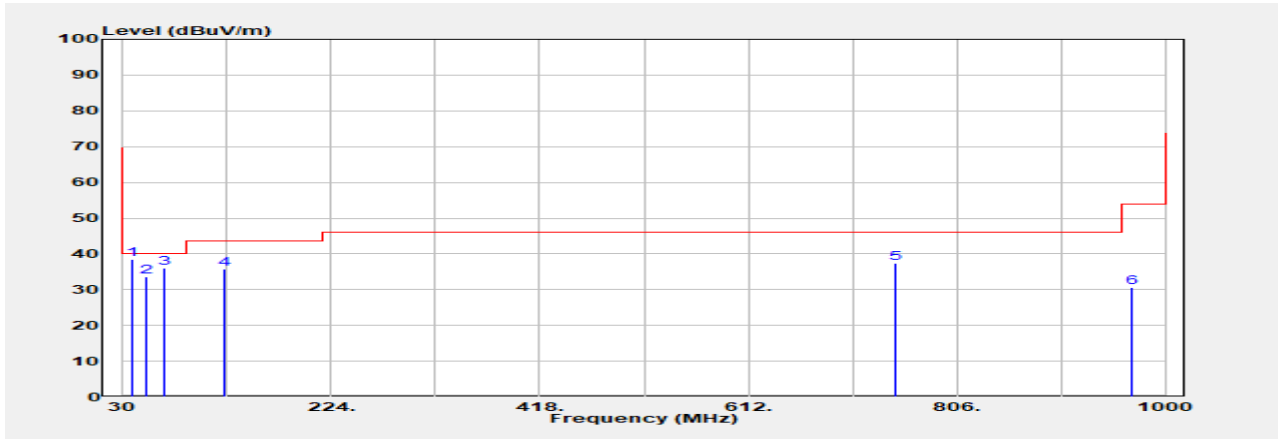

Freq. MHz	Detector Mode PK/QP/AVG	Spectrum Reading Level dBUV	Factor dB	Actual FS dBUV/m	Limit @3m dBUV/m	Margin dB
38.730	QP	52.10	-13.59	38.51	40.00	-1.49
51.340	QP	46.10	-12.37	33.73	40.00	-6.27
68.800	QP	50.80	-14.80	36.00	40.00	-4.00
125.060	Peak	50.68	-14.99	35.69	43.50	-7.81
749.740	Peak	39.40	-2.06	37.34	46.00	-8.66
969.930	Peak	29.60	0.92	30.53	54.00	-23.47

Unless otherwise stated the results shown in this test report refer only to the sample(s) tested and such sample(s) are retained for 90 days only.

除非另有說明，此報告結果僅對測試之樣品負責，同時此樣品僅保留90天。本報告未經本公司書面許可，不可部份複製。

This document is issued by the Company subject to its General Conditions of Service printed overleaf, available on request or accessible at <http://www.sgs.com.tw/Terms-and-Conditions> and for electronic format documents, subject to Terms and Conditions for Electronic Documents at <http://www.sgs.com.tw/Terms-and-Conditions>. Attention is drawn to the limitation of liability, indemnification and jurisdiction issues defined therein. Any holder of this document is advised that information contained hereon reflects the Company's findings at the time of its intervention only and within the limits of Client's instructions, if any. The Company's sole responsibility is to its Client and this document does not exonerate parties to a transaction from exercising all their rights and obligations under the transaction documents. This document cannot be reproduced except in full, without prior written approval of the Company. Any unauthorized alteration, forgery or falsification of the content or appearance of this document is unlawful and offenders may be prosecuted to the fullest extent of the law.

Report Number :TERF2308001923E2
 Operation Mode :802.11be160
 Test Frequency :5250 MHz
 Test Mode :Tx
 EUT Pol :E2 Plane

Test Site :SAC G Chamber
 Test Date :2023-10-26
 Temp./Humi. :23.6°C/57%
 Antenna Pol. :Horizontal
 Engineer :Temo Chen

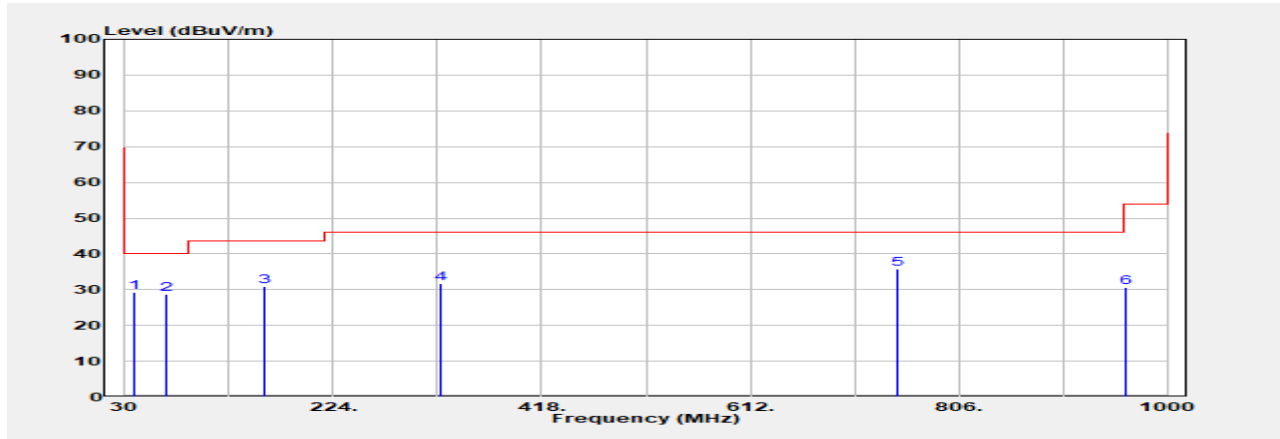

Freq. MHz	Detector Mode PK/QP/AVG	Spectrum Reading Level dB μ V	Factor dB	Actual FS dB μ V/m	Limit @3m dB μ V/m	Margin dB
38.730	Peak	42.88	-13.59	29.30	40.00	-10.70
67.830	QP	43.10	-14.39	28.71	40.00	-11.29
159.010	Peak	43.44	-12.52	30.91	43.50	-12.59
323.910	Peak	43.03	-11.37	31.66	46.00	-14.34
749.740	Peak	37.96	-2.06	35.90	46.00	-10.10
962.170	Peak	29.87	0.86	30.73	54.00	-23.27

Unless otherwise stated the results shown in this test report refer only to the sample(s) tested and such sample(s) are retained for 90 days only.

除非另有說明，此報告結果僅對測試之樣品負責，同時此樣品僅保留90天。本報告未經本公司書面許可，不可部份複製。

This document is issued by the Company subject to its General Conditions of Service printed overleaf, available on request or accessible at <http://www.sgs.com.tw/Terms-and-Conditions> and for electronic format documents, subject to Terms and Conditions for Electronic Documents at <http://www.sgs.com.tw/Terms-and-Conditions>. Attention is drawn to the limitation of liability, indemnification and jurisdiction issues defined therein. Any holder of this document is advised that information contained hereon reflects the Company's findings at the time of its intervention only and within the limits of Client's instructions, if any. The Company's sole responsibility is to its Client and this document does not exonerate parties to a transaction from exercising all their rights and obligations under the transaction documents. This document cannot be reproduced except in full, without prior written approval of the Company. Any unauthorized alteration, forgery or falsification of the content or appearance of this document is unlawful and offenders may be prosecuted to the fullest extent of the law.

Report Number :TERF2308001923E2
 Operation Mode :802.11be160
 Test Frequency :5570 MHz
 Test Mode :Tx
 EUT Pol :E2 Plane

Test Site :SAC G Chamber
 Test Date :2023-10-26
 Temp./Humi. :23.6°C/57%
 Antenna Pol. :Vertical
 Engineer :Temo Chen

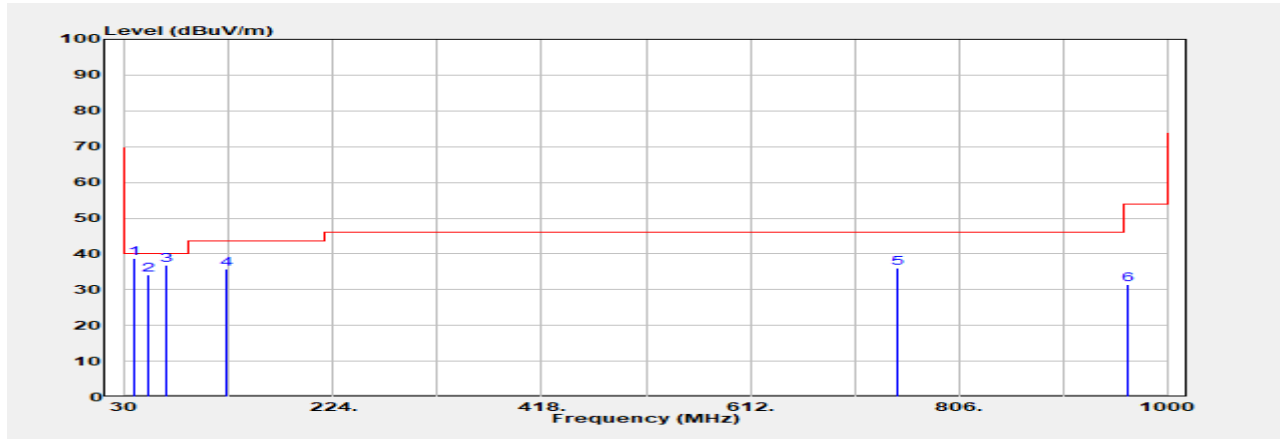

Freq. MHz	Detector Mode PK/QP/AVG	Spectrum Reading Level dB μ V	Factor dB	Actual FS dB μ V/m	Limit @3m dB μ V/m	Margin dB
38.730	QP	52.40	-13.59	38.81	40.00	-1.19
52.310	QP	46.70	-12.47	34.23	40.00	-5.77
68.800	QP	51.70	-14.80	36.90	40.00	-3.10
125.060	Peak	50.72	-14.99	35.73	43.50	-7.77
749.740	Peak	38.20	-2.06	36.13	46.00	-9.87
964.110	Peak	30.62	0.88	31.50	54.00	-22.50

Unless otherwise stated the results shown in this test report refer only to the sample(s) tested and such sample(s) are retained for 90 days only.

除非另有說明，此報告結果僅對測試之樣品負責，同時此樣品僅保留90天。本報告未經本公司書面許可，不可部份複製。

This document is issued by the Company subject to its General Conditions of Service printed overleaf, available on request or accessible at <http://www.sgs.com.tw/Terms-and-Conditions> and for electronic format documents, subject to Terms and Conditions for Electronic Documents at <http://www.sgs.com.tw/Terms-and-Conditions>. Attention is drawn to the limitation of liability, indemnification and jurisdiction issues defined therein. Any holder of this document is advised that information contained hereon reflects the Company's findings at the time of its intervention only and within the limits of Client's instructions, if any. The Company's sole responsibility is to its Client and this document does not exonerate parties to a transaction from exercising all their rights and obligations under the transaction documents. This document cannot be reproduced except in full, without prior written approval of the Company. Any unauthorized alteration, forgery or falsification of the content or appearance of this document is unlawful and offenders may be prosecuted to the fullest extent of the law.

Report Number :TERF2308001923E2
 Operation Mode :802.11be160
 Test Frequency :5570 MHz
 Test Mode :Tx
 EUT Pol :E2 Plane

Test Site :SAC G Chamber
 Test Date :2023-10-26
 Temp./Humi. :23.6°C/57%
 Antenna Pol. :Horizontal
 Engineer :Temo Chen

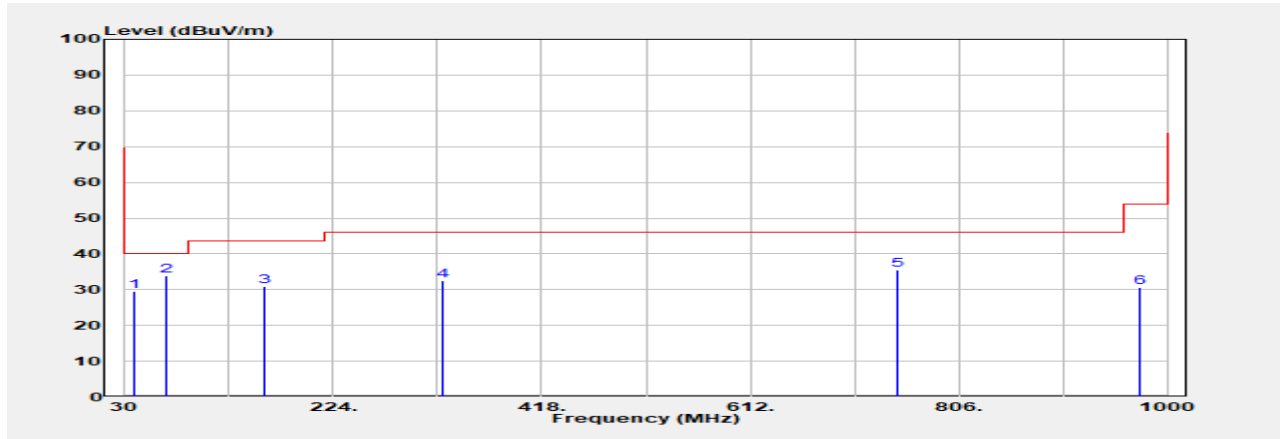

Freq. MHz	Detector Mode PK/QP/AVG	Spectrum Reading Level dB μ V	Factor dB	Actual FS dB μ V/m	Limit @3m dB μ V/m	Margin dB
38.730	Peak	43.01	-13.59	29.42	40.00	-10.58
68.800	Peak	48.65	-14.80	33.85	40.00	-6.15
159.010	Peak	43.34	-12.52	30.81	43.50	-12.69
325.850	Peak	43.72	-11.33	32.40	46.00	-13.60
749.740	Peak	37.56	-2.06	35.50	46.00	-10.50
973.810	Peak	29.81	0.92	30.73	54.00	-23.27

Unless otherwise stated the results shown in this test report refer only to the sample(s) tested and such sample(s) are retained for 90 days only.

除非另有說明，此報告結果僅對測試之樣品負責，同時此樣品僅保留90天。本報告未經本公司書面許可，不可部份複製。

This document is issued by the Company subject to its General Conditions of Service printed overleaf, available on request or accessible at <http://www.sgs.com.tw/Terms-and-Conditions> and for electronic format documents, subject to Terms and Conditions for Electronic Documents at <http://www.sgs.com.tw/Terms-and-Conditions>. Attention is drawn to the limitation of liability, indemnification and jurisdiction issues defined therein. Any holder of this document is advised that information contained hereon reflects the Company's findings at the time of its intervention only and within the limits of Client's instructions, if any. The Company's sole responsibility is to its Client and this document does not exonerate parties to a transaction from exercising all their rights and obligations under the transaction documents. This document cannot be reproduced except in full, without prior written approval of the Company. Any unauthorized alteration, forgery or falsification of the content or appearance of this document is unlawful and offenders may be prosecuted to the fullest extent of the law.

Report Number :TERF2308001923E2
 Operation Mode :802.11a
 Test Frequency :5180 MHz
 Test Mode :Tx
 EUT Pol :E2 Plane

Test Site :SAC G Chamber
 Test Date :2023-10-19
 Temp./Humi. :22.3°C/60%
 Antenna Pol. :Vertical
 Engineer :Temo Chen

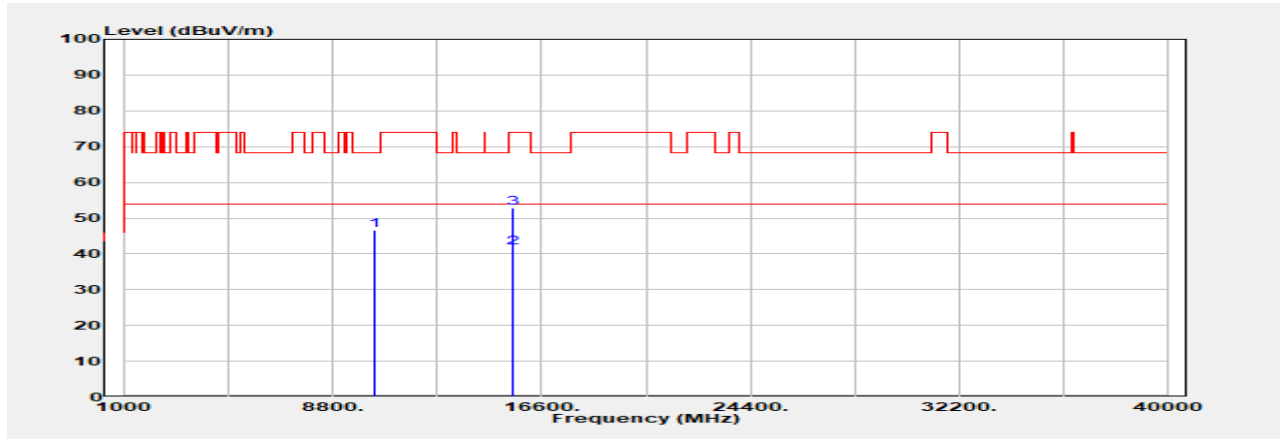

Freq. MHz	Detector Mode PK/QP/AVG	Spectrum Reading Level dBμV	Factor dB	Actual FS dBμV/m	Limit @3m dBμV/m	Margin dB
10360.000	Peak	37.30	9.38	46.68	68.20	-21.52
15540.000	Average	29.76	11.96	41.72	54.00	-12.28
15540.000	Peak	40.78	11.96	52.74	74.00	-21.26

Unless otherwise stated the results shown in this test report refer only to the sample(s) tested and such sample(s) are retained for 90 days only.

除非另有說明，此報告結果僅對測試之樣品負責，同時此樣品僅保留90天。本報告未經本公司書面許可，不可部份複製。

This document is issued by the Company subject to its General Conditions of Service printed overleaf, available on request or accessible at <http://www.sgs.com.tw/Terms-and-Conditions> and for electronic format documents, subject to Terms and Conditions for Electronic Documents at <http://www.sgs.com.tw/Terms-and-Conditions>. Attention is drawn to the limitation of liability, indemnification and jurisdiction issues defined therein. Any holder of this document is advised that information contained hereon reflects the Company's findings at the time of its intervention only and within the limits of Client's instructions, if any. The Company's sole responsibility is to its Client and this document does not exonerate parties to a transaction from exercising all their rights and obligations under the transaction documents. This document cannot be reproduced except in full, without prior written approval of the Company. Any unauthorized alteration, forgery or falsification of the content or appearance of this document is unlawful and offenders may be prosecuted to the fullest extent of the law.

Report Number :TERF2308001923E2
 Operation Mode :802.11a
 Test Frequency :5180 MHz
 Test Mode :Tx
 EUT Pol :E2 Plane

Test Site :SAC G Chamber
 Test Date :2023-10-19
 Temp./Humi. :22.3°C/60%
 Antenna Pol. :Horizontal
 Engineer :Temo Chen

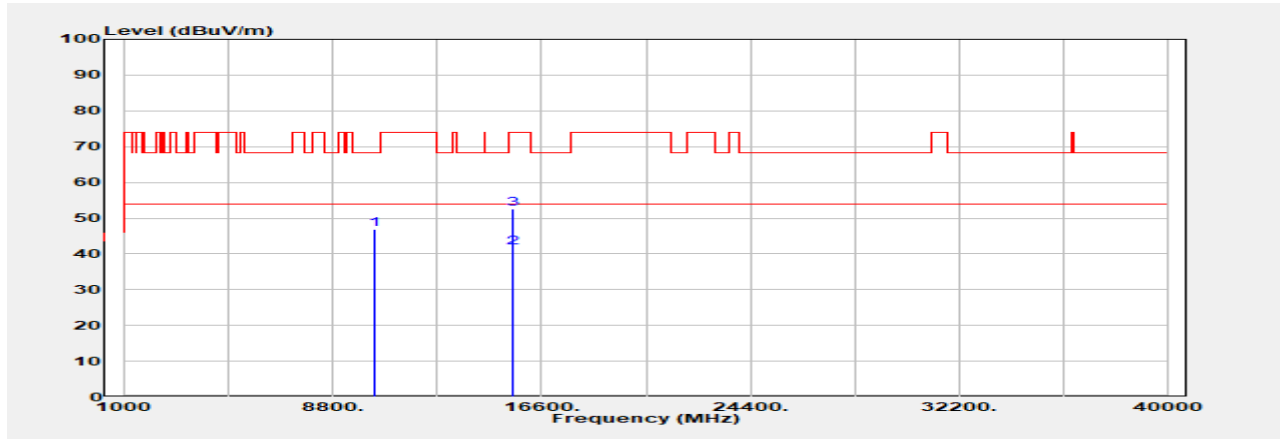

Freq. MHz	Detector Mode PK/QP/AVG	Spectrum Reading Level dB μ V	Factor dB	Actual FS dB μ V/m	Limit @3m dB μ V/m	Margin dB
10360.000	Peak	37.61	9.38	46.99	68.20	-21.21
15540.000	Average	29.72	11.96	41.68	54.00	-12.32
15540.000	Peak	40.62	11.96	52.58	74.00	-21.42

Unless otherwise stated the results shown in this test report refer only to the sample(s) tested and such sample(s) are retained for 90 days only.

除非另有說明，此報告結果僅對測試之樣品負責，同時此樣品僅保留90天。本報告未經本公司書面許可，不可部份複製。

This document is issued by the Company subject to its General Conditions of Service printed overleaf, available on request or accessible at <http://www.sgs.com.tw/Terms-and-Conditions> and for electronic format documents, subject to Terms and Conditions for Electronic Documents at <http://www.sgs.com.tw/Terms-and-Conditions>. Attention is drawn to the limitation of liability, indemnification and jurisdiction issues defined therein. Any holder of this document is advised that information contained hereon reflects the Company's findings at the time of its intervention only and within the limits of Client's instructions, if any. The Company's sole responsibility is to its Client and this document does not exonerate parties to a transaction from exercising all their rights and obligations under the transaction documents. This document cannot be reproduced except in full, without prior written approval of the Company. Any unauthorized alteration, forgery or falsification of the content or appearance of this document is unlawful and offenders may be prosecuted to the fullest extent of the law.

Report Number :TERF2308001923E2
 Operation Mode :802.11a
 Test Frequency :5220 MHz
 Test Mode :Tx
 EUT Pol :E2 Plane

Test Site :SAC G Chamber
 Test Date :2023-08-25
 Temp./Humi. :25.9°C/57%
 Antenna Pol. :Vertical
 Engineer :Temo Chen

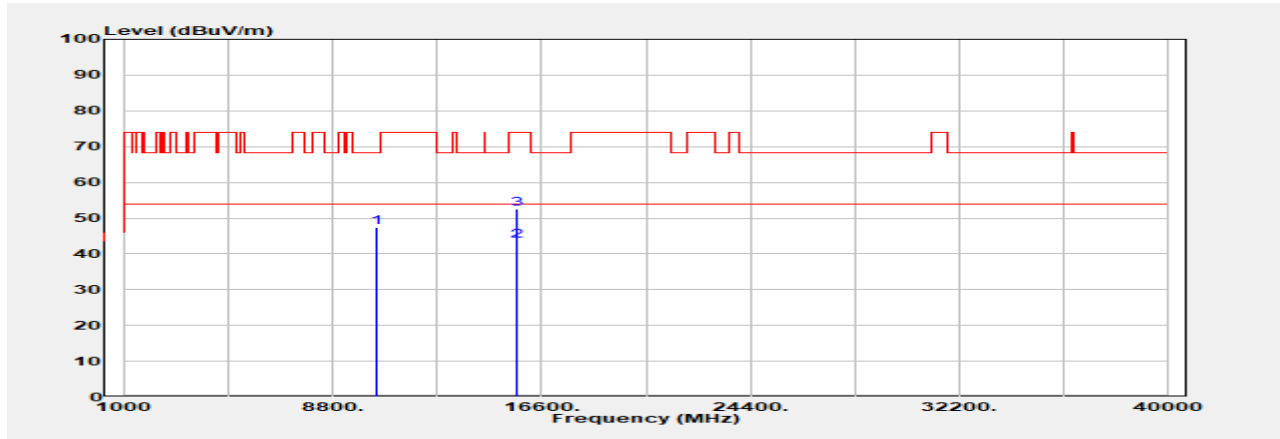

Freq. MHz	Detector Mode PK/QP/AVG	Spectrum Reading Level dB μ V	Factor dB	Actual FS dB μ V/m	Limit @3m dB μ V/m	Margin dB
10440.000	Peak	37.89	9.66	47.55	68.20	-20.65
15660.000	Average	31.44	12.32	43.76	54.00	-10.24
15660.000	Peak	40.36	12.32	52.68	74.00	-21.32

Unless otherwise stated the results shown in this test report refer only to the sample(s) tested and such sample(s) are retained for 90 days only.

除非另有說明，此報告結果僅對測試之樣品負責，同時此樣品僅保留90天。本報告未經本公司書面許可，不可部份複製。

This document is issued by the Company subject to its General Conditions of Service printed overleaf, available on request or accessible at <http://www.sgs.com.tw/Terms-and-Conditions> and for electronic format documents, subject to Terms and Conditions for Electronic Documents at <http://www.sgs.com.tw/Terms-and-Conditions>. Attention is drawn to the limitation of liability, indemnification and jurisdiction issues defined therein. Any holder of this document is advised that information contained hereon reflects the Company's findings at the time of its intervention only and within the limits of Client's instructions, if any. The Company's sole responsibility is to its Client and this document does not exonerate parties to a transaction from exercising all their rights and obligations under the transaction documents. This document cannot be reproduced except in full, without prior written approval of the Company. Any unauthorized alteration, forgery or falsification of the content or appearance of this document is unlawful and offenders may be prosecuted to the fullest extent of the law.

Report Number :TERF2308001923E2	Test Site :SAC G Chamber
Operation Mode :802.11a	Test Date :2023-08-25
Test Frequency :5220 MHz	Temp./Humi. :25.9°C/57%
Test Mode :Tx	Antenna Pol. :Horizontal
EUT Pol :E2 Plane	Engineer :Temo Chen

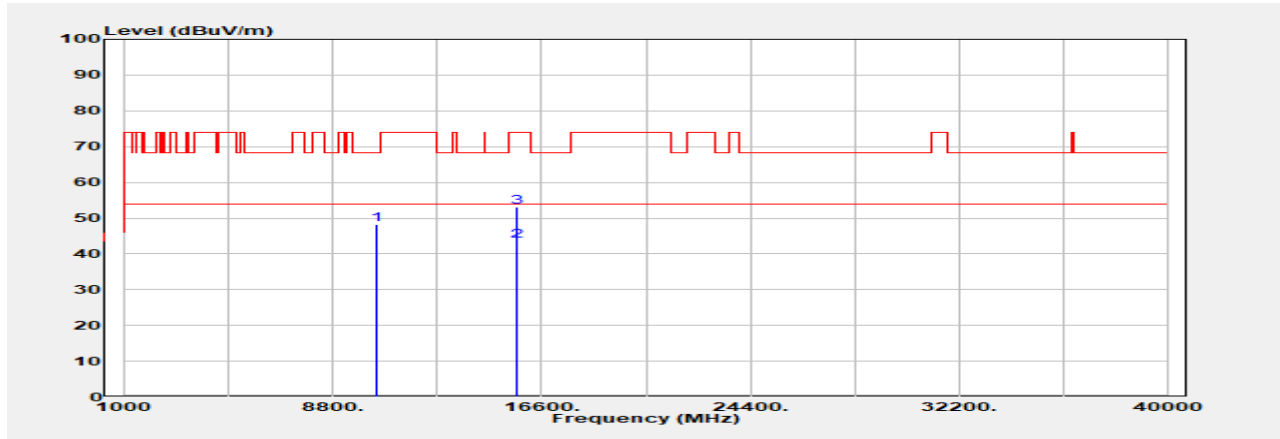

Freq. MHz	Detector Mode PK/QP/AVG	Spectrum Reading Level dB μ V	Factor dB	Actual FS dB μ V/m	Limit @3m dB μ V/m	Margin dB
10440.000	Peak	38.57	9.66	48.24	68.20	-19.96
15660.000	Average	31.21	12.32	43.53	54.00	-10.47
15660.000	Peak	40.83	12.32	53.15	74.00	-20.85

Unless otherwise stated the results shown in this test report refer only to the sample(s) tested and such sample(s) are retained for 90 days only.

除非另有說明，此報告結果僅對測試之樣品負責，同時此樣品僅保留90天。本報告未經本公司書面許可，不可部份複製。

This document is issued by the Company subject to its General Conditions of Service printed overleaf, available on request or accessible at <http://www.sgs.com.tw/Terms-and-Conditions> and for electronic format documents, subject to Terms and Conditions for Electronic Documents at <http://www.sgs.com.tw/Terms-and-Conditions>. Attention is drawn to the limitation of liability, indemnification and jurisdiction issues defined therein. Any holder of this document is advised that information contained hereon reflects the Company's findings at the time of its intervention only and within the limits of Client's instructions, if any. The Company's sole responsibility is to its Client and this document does not exonerate parties to a transaction from exercising all their rights and obligations under the transaction documents. This document cannot be reproduced except in full, without prior written approval of the Company. Any unauthorized alteration, forgery or falsification of the content or appearance of this document is unlawful and offenders may be prosecuted to the fullest extent of the law.

Report Number :TERF2308001923E2
 Operation Mode :802.11a
 Test Frequency :5240 MHz
 Test Mode :Tx
 EUT Pol :E2 Plane

Test Site :SAC G Chamber
 Test Date :2023-08-25
 Temp./Humi. :25.9°C/57%
 Antenna Pol. :Vertical
 Engineer :Temo Chen

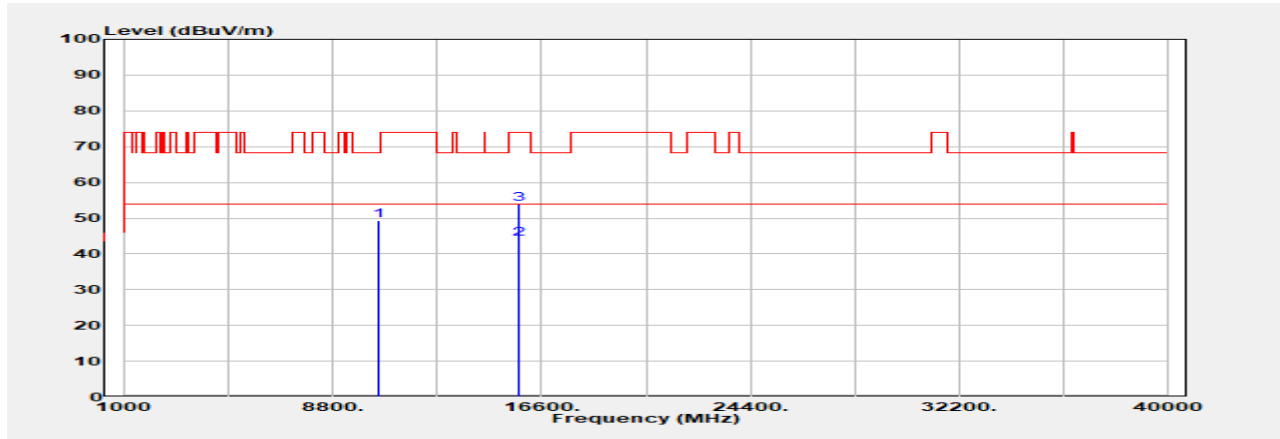

Freq. MHz	Detector Mode PK/QP/AVG	Spectrum Reading Level dB μ V	Factor dB	Actual FS dB μ V/m	Limit @3m dB μ V/m	Margin dB
10480.000	Peak	39.38	9.82	49.20	68.20	-19.00
15720.000	Average	31.58	12.56	44.14	54.00	-9.86
15720.000	Peak	41.33	12.56	53.89	74.00	-20.11

Unless otherwise stated the results shown in this test report refer only to the sample(s) tested and such sample(s) are retained for 90 days only.

除非另有說明，此報告結果僅對測試之樣品負責，同時此樣品僅保留90天。本報告未經本公司書面許可，不可部份複製。

This document is issued by the Company subject to its General Conditions of Service printed overleaf, available on request or accessible at <http://www.sgs.com.tw/Terms-and-Conditions> and for electronic format documents, subject to Terms and Conditions for Electronic Documents at <http://www.sgs.com.tw/Terms-and-Conditions>. Attention is drawn to the limitation of liability, indemnification and jurisdiction issues defined therein. Any holder of this document is advised that information contained hereon reflects the Company's findings at the time of its intervention only and within the limits of Client's instructions, if any. The Company's sole responsibility is to its Client and this document does not exonerate parties to a transaction from exercising all their rights and obligations under the transaction documents. This document cannot be reproduced except in full, without prior written approval of the Company. Any unauthorized alteration, forgery or falsification of the content or appearance of this document is unlawful and offenders may be prosecuted to the fullest extent of the law.

Report Number :TERF2308001923E2
 Operation Mode :802.11a
 Test Frequency :5240 MHz
 Test Mode :Tx
 EUT Pol :E2 Plane

Test Site :SAC G Chamber
 Test Date :2023-08-25
 Temp./Humi. :25.9°C/57%
 Antenna Pol. :Horizontal
 Engineer :Temo Chen

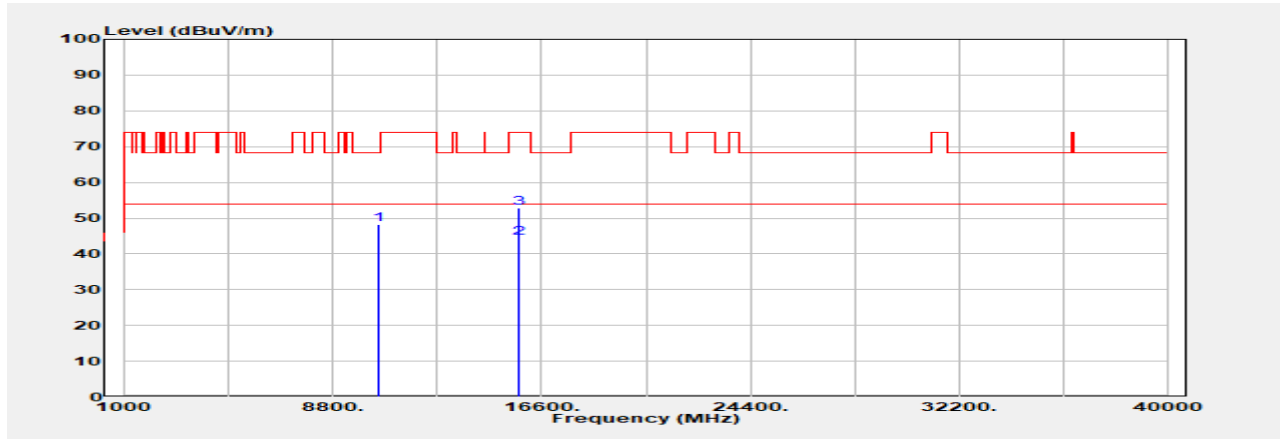

Freq. MHz	Detector Mode PK/QP/AVG	Spectrum Reading Level dB μ V	Factor dB	Actual FS dB μ V/m	Limit @3m dB μ V/m	Margin dB
10480.000	Peak	38.42	9.82	48.24	68.20	-19.96
15720.000	Average	31.77	12.56	44.33	54.00	-9.67
15720.000	Peak	40.16	12.56	52.72	74.00	-21.28

Unless otherwise stated the results shown in this test report refer only to the sample(s) tested and such sample(s) are retained for 90 days only.

除非另有說明，此報告結果僅對測試之樣品負責，同時此樣品僅保留90天。本報告未經本公司書面許可，不可部份複製。

This document is issued by the Company subject to its General Conditions of Service printed overleaf, available on request or accessible at <http://www.sgs.com.tw/Terms-and-Conditions> and for electronic format documents, subject to Terms and Conditions for Electronic Documents at <http://www.sgs.com.tw/Terms-and-Conditions>. Attention is drawn to the limitation of liability, indemnification and jurisdiction issues defined therein. Any holder of this document is advised that information contained hereon reflects the Company's findings at the time of its intervention only and within the limits of Client's instructions, if any. The Company's sole responsibility is to its Client and this document does not exonerate parties to a transaction from exercising all their rights and obligations under the transaction documents. This document cannot be reproduced except in full, without prior written approval of the Company. Any unauthorized alteration, forgery or falsification of the content or appearance of this document is unlawful and offenders may be prosecuted to the fullest extent of the law.

Report Number :TERF2308001923E2
 Operation Mode :802.11a
 Test Frequency :5260 MHz
 Test Mode :Tx
 EUT Pol :E2 Plane

Test Site :SAC G Chamber
 Test Date :2023-08-25
 Temp./Humi. :25.9°C/57%
 Antenna Pol. :Vertical
 Engineer :Temo Chen

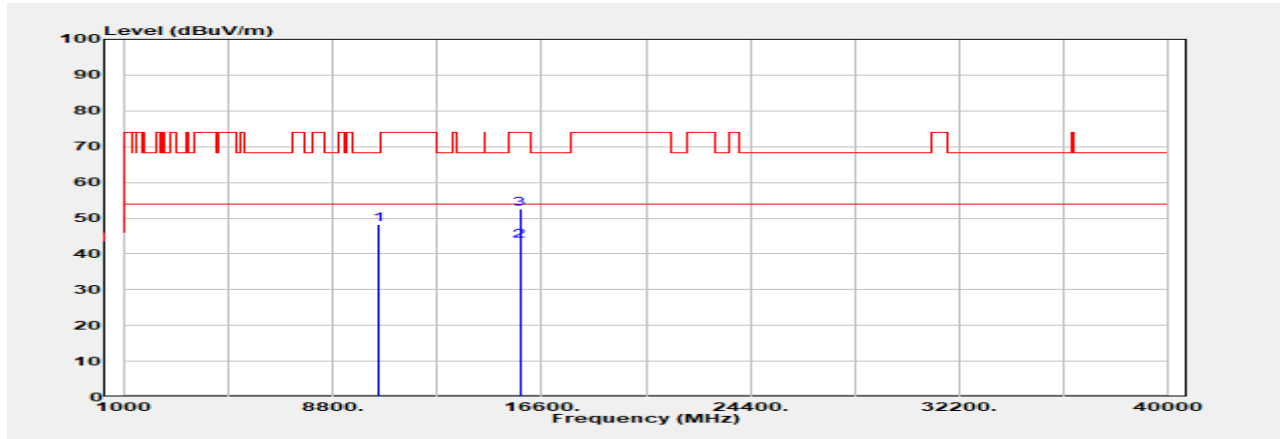

Freq. MHz	Detector Mode PK/QP/AVG	Spectrum Reading Level dB μ V	Factor dB	Actual FS dB μ V/m	Limit @3m dB μ V/m	Margin dB
10520.000	Peak	38.33	9.92	48.25	68.20	-19.95
15780.000	Average	31.22	12.44	43.66	54.00	-10.34
15780.000	Peak	40.18	12.44	52.62	74.00	-21.38

Unless otherwise stated the results shown in this test report refer only to the sample(s) tested and such sample(s) are retained for 90 days only.

除非另有說明，此報告結果僅對測試之樣品負責，同時此樣品僅保留90天。本報告未經本公司書面許可，不可部份複製。

This document is issued by the Company subject to its General Conditions of Service printed overleaf, available on request or accessible at <http://www.sgs.com.tw/Terms-and-Conditions> and for electronic format documents, subject to Terms and Conditions for Electronic Documents at <http://www.sgs.com.tw/Terms-and-Conditions>. Attention is drawn to the limitation of liability, indemnification and jurisdiction issues defined therein. Any holder of this document is advised that information contained hereon reflects the Company's findings at the time of its intervention only and within the limits of Client's instructions, if any. The Company's sole responsibility is to its Client and this document does not exonerate parties to a transaction from exercising all their rights and obligations under the transaction documents. This document cannot be reproduced except in full, without prior written approval of the Company. Any unauthorized alteration, forgery or falsification of the content or appearance of this document is unlawful and offenders may be prosecuted to the fullest extent of the law.

Report Number :TERF2308001923E2
 Operation Mode :802.11a
 Test Frequency :5260 MHz
 Test Mode :Tx
 EUT Pol :E2 Plane

Test Site :SAC G Chamber
 Test Date :2023-08-25
 Temp./Humi. :25.9°C/57%
 Antenna Pol. :Horizontal
 Engineer :Temo Chen

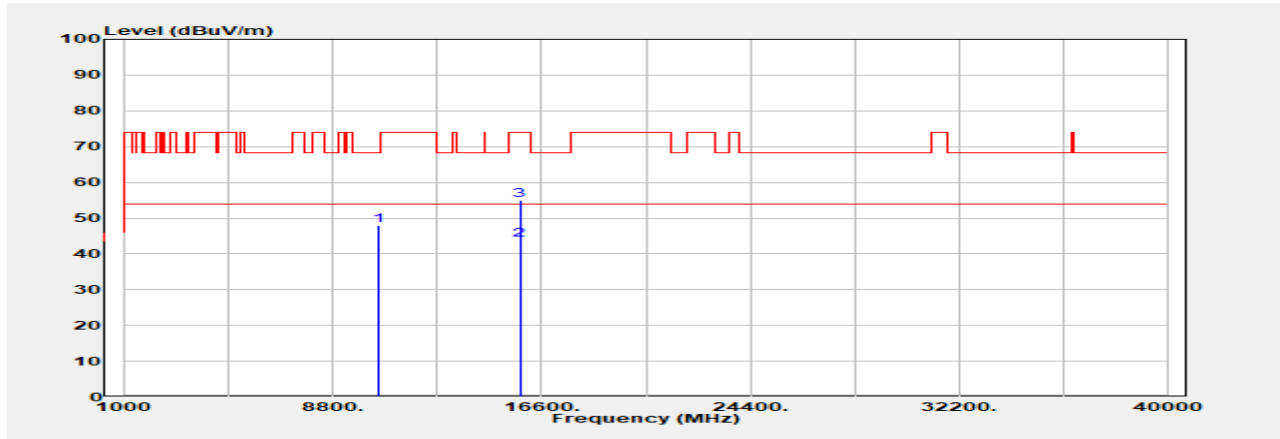

Freq. MHz	Detector Mode PK/QP/AVG	Spectrum Reading Level dB μ V	Factor dB	Actual FS dB μ V/m	Limit @3m dB μ V/m	Margin dB
10520.000	Peak	38.14	9.92	48.06	68.20	-20.14
15780.000	Average	31.41	12.44	43.85	54.00	-10.15
15780.000	Peak	42.44	12.44	54.88	74.00	-19.12

Unless otherwise stated the results shown in this test report refer only to the sample(s) tested and such sample(s) are retained for 90 days only.

除非另有說明，此報告結果僅對測試之樣品負責，同時此樣品僅保留90天。本報告未經本公司書面許可，不可部份複製。

This document is issued by the Company subject to its General Conditions of Service printed overleaf, available on request or accessible at <http://www.sgs.com.tw/Terms-and-Conditions> and for electronic format documents, subject to Terms and Conditions for Electronic Documents at <http://www.sgs.com.tw/Terms-and-Conditions>. Attention is drawn to the limitation of liability, indemnification and jurisdiction issues defined therein. Any holder of this document is advised that information contained hereon reflects the Company's findings at the time of its intervention only and within the limits of Client's instructions, if any. The Company's sole responsibility is to its Client and this document does not exonerate parties to a transaction from exercising all their rights and obligations under the transaction documents. This document cannot be reproduced except in full, without prior written approval of the Company. Any unauthorized alteration, forgery or falsification of the content or appearance of this document is unlawful and offenders may be prosecuted to the fullest extent of the law.

Report Number :TERF2308001923E2
 Operation Mode :802.11a
 Test Frequency :5300 MHz
 Test Mode :Tx
 EUT Pol :E2 Plane

Test Site :SAC G Chamber
 Test Date :2023-08-25
 Temp./Humi. :25.9°C/57%
 Antenna Pol. :Vertical
 Engineer :Temo Chen

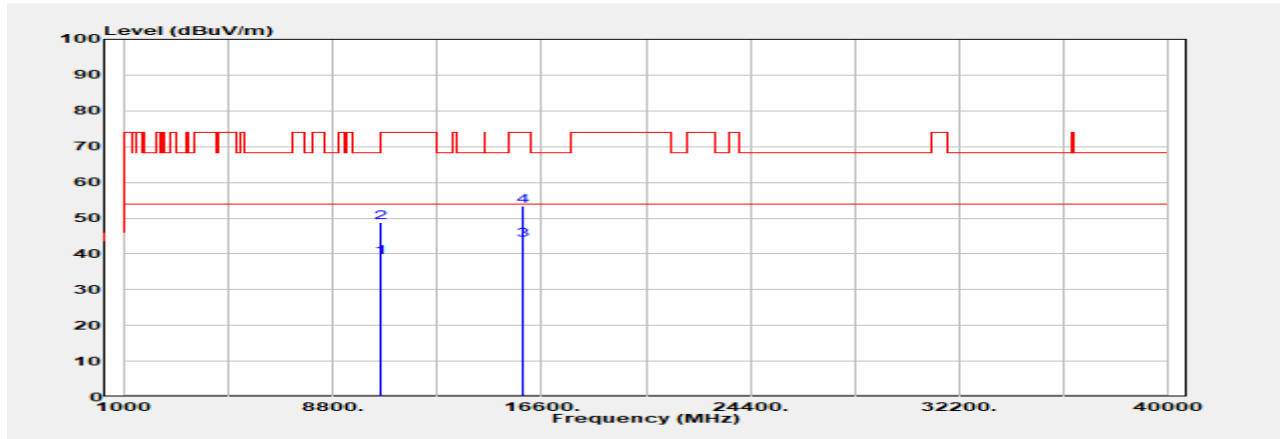

Freq. MHz	Detector Mode PK/QP/AVG	Spectrum Reading Level dB μ V	Factor dB	Actual FS dB μ V/m	Limit @3m dB μ V/m	Margin dB
10600.000	Average	29.11	10.00	39.11	54.00	-14.89
10600.000	Peak	38.82	10.00	48.82	74.00	-25.18
15900.000	Average	31.72	12.20	43.92	54.00	-10.08
15900.000	Peak	41.29	12.20	53.49	74.00	-20.51

Unless otherwise stated the results shown in this test report refer only to the sample(s) tested and such sample(s) are retained for 90 days only.

除非另有說明，此報告結果僅對測試之樣品負責，同時此樣品僅保留90天。本報告未經本公司書面許可，不可部份複製。

This document is issued by the Company subject to its General Conditions of Service printed overleaf, available on request or accessible at <http://www.sgs.com.tw/Terms-and-Conditions> and for electronic format documents, subject to Terms and Conditions for Electronic Documents at <http://www.sgs.com.tw/Terms-and-Conditions>. Attention is drawn to the limitation of liability, indemnification and jurisdiction issues defined therein. Any holder of this document is advised that information contained hereon reflects the Company's findings at the time of its intervention only and within the limits of Client's instructions, if any. The Company's sole responsibility is to its Client and this document does not exonerate parties to a transaction from exercising all their rights and obligations under the transaction documents. This document cannot be reproduced except in full, without prior written approval of the Company. Any unauthorized alteration, forgery or falsification of the content or appearance of this document is unlawful and offenders may be prosecuted to the fullest extent of the law.

Report Number :TERF2308001923E2
 Operation Mode :802.11a
 Test Frequency :5300 MHz
 Test Mode :Tx
 EUT Pol :E2 Plane

Test Site :SAC G Chamber
 Test Date :2023-08-25
 Temp./Humi. :25.9°C/57%
 Antenna Pol. :Horizontal
 Engineer :Temo Chen

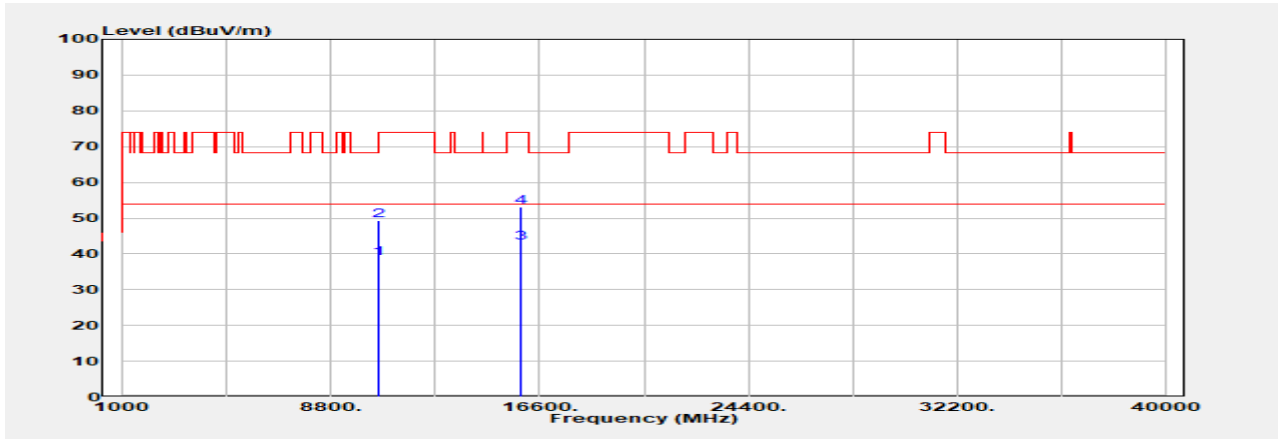

Freq. MHz	Detector Mode PK/QP/AVG	Spectrum Reading Level dB μ V	Factor dB	Actual FS dB μ V/m	Limit @3m dB μ V/m	Margin dB
10600.000	Average	28.77	10.00	38.77	54.00	-15.23
10600.000	Peak	39.42	10.00	49.42	74.00	-24.58
15900.000	Average	30.85	12.20	43.05	54.00	-10.95
15900.000	Peak	40.86	12.20	53.06	74.00	-20.94

Unless otherwise stated the results shown in this test report refer only to the sample(s) tested and such sample(s) are retained for 90 days only.

除非另有說明，此報告結果僅對測試之樣品負責，同時此樣品僅保留90天。本報告未經本公司書面許可，不可部份複製。

This document is issued by the Company subject to its General Conditions of Service printed overleaf, available on request or accessible at <http://www.sgs.com.tw/Terms-and-Conditions> and for electronic format documents, subject to Terms and Conditions for Electronic Documents at <http://www.sgs.com.tw/Terms-and-Conditions>. Attention is drawn to the limitation of liability, indemnification and jurisdiction issues defined therein. Any holder of this document is advised that information contained hereon reflects the Company's findings at the time of its intervention only and within the limits of Client's instructions, if any. The Company's sole responsibility is to its Client and this document does not exonerate parties to a transaction from exercising all their rights and obligations under the transaction documents. This document cannot be reproduced except in full, without prior written approval of the Company. Any unauthorized alteration, forgery or falsification of the content or appearance of this document is unlawful and offenders may be prosecuted to the fullest extent of the law.

Report Number :TERF2308001923E2
 Operation Mode :802.11a
 Test Frequency :5320 MHz
 Test Mode :Tx
 EUT Pol :E2 Plane

Test Site :SAC G Chamber
 Test Date :2023-08-25
 Temp./Humi. :25.9°C/57%
 Antenna Pol. :Vertical
 Engineer :Temo Chen

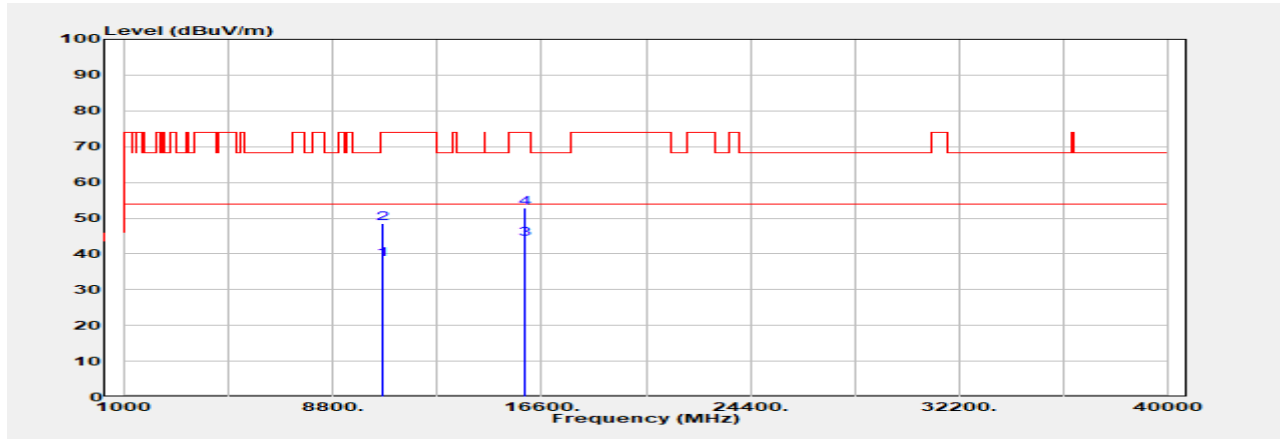

Freq. MHz	Detector Mode PK/QP/AVG	Spectrum Reading Level dB μ V	Factor dB	Actual FS dB μ V/m	Limit @3m dB μ V/m	Margin dB
10640.000	Average	28.75	9.72	38.47	54.00	-15.53
10640.000	Peak	38.76	9.72	48.48	74.00	-25.52
15960.000	Average	32.15	11.90	44.05	54.00	-9.95
15960.000	Peak	40.93	11.90	52.83	74.00	-21.17

Unless otherwise stated the results shown in this test report refer only to the sample(s) tested and such sample(s) are retained for 90 days only.

除非另有說明，此報告結果僅對測試之樣品負責，同時此樣品僅保留90天。本報告未經本公司書面許可，不可部份複製。

This document is issued by the Company subject to its General Conditions of Service printed overleaf, available on request or accessible at <http://www.sgs.com.tw/Terms-and-Conditions> and for electronic format documents, subject to Terms and Conditions for Electronic Documents at <http://www.sgs.com.tw/Terms-and-Conditions>. Attention is drawn to the limitation of liability, indemnification and jurisdiction issues defined therein. Any holder of this document is advised that information contained hereon reflects the Company's findings at the time of its intervention only and within the limits of Client's instructions, if any. The Company's sole responsibility is to its Client and this document does not exonerate parties to a transaction from exercising all their rights and obligations under the transaction documents. This document cannot be reproduced except in full, without prior written approval of the Company. Any unauthorized alteration, forgery or falsification of the content or appearance of this document is unlawful and offenders may be prosecuted to the fullest extent of the law.

Report Number :TERF2308001923E2
 Operation Mode :802.11a
 Test Frequency :5320 MHz
 Test Mode :Tx
 EUT Pol :E2 Plane

Test Site :SAC G Chamber
 Test Date :2023-08-25
 Temp./Humi. :25.9°C/57%
 Antenna Pol. :Horizontal
 Engineer :Temo Chen

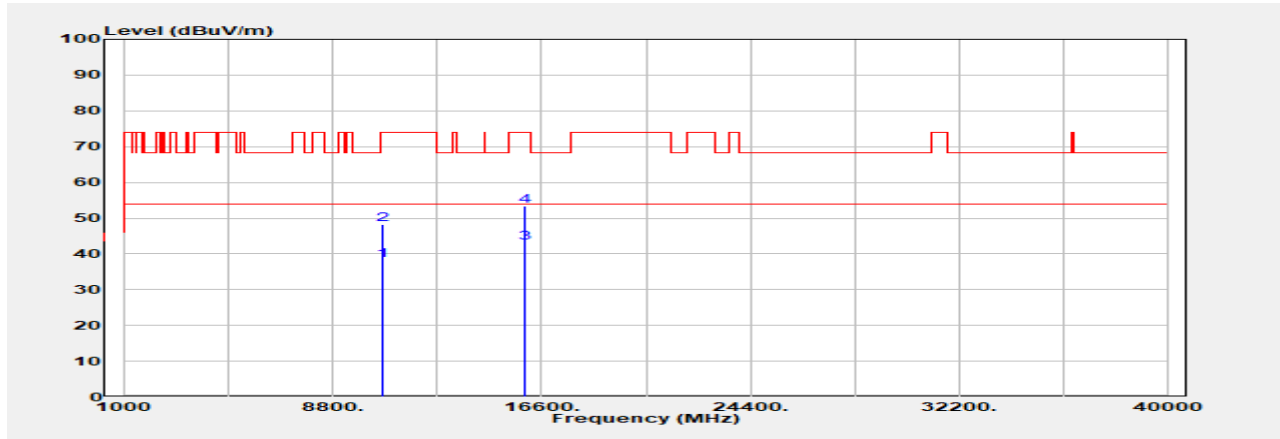

Freq. MHz	Detector Mode PK/QP/AVG	Spectrum Reading Level dB μ V	Factor dB	Actual FS dB μ V/m	Limit @3m dB μ V/m	Margin dB
10640.000	Average	28.43	9.72	38.15	54.00	-15.85
10640.000	Peak	38.63	9.72	48.35	74.00	-25.65
15960.000	Average	31.22	11.90	43.12	54.00	-10.88
15960.000	Peak	41.50	11.90	53.40	74.00	-20.60

Unless otherwise stated the results shown in this test report refer only to the sample(s) tested and such sample(s) are retained for 90 days only.

除非另有說明，此報告結果僅對測試之樣品負責，同時此樣品僅保留90天。本報告未經本公司書面許可，不可部份複製。

This document is issued by the Company subject to its General Conditions of Service printed overleaf, available on request or accessible at <http://www.sgs.com.tw/Terms-and-Conditions> and for electronic format documents, subject to Terms and Conditions for Electronic Documents at <http://www.sgs.com.tw/Terms-and-Conditions>. Attention is drawn to the limitation of liability, indemnification and jurisdiction issues defined therein. Any holder of this document is advised that information contained hereon reflects the Company's findings at the time of its intervention only and within the limits of Client's instructions, if any. The Company's sole responsibility is to its Client and this document does not exonerate parties to a transaction from exercising all their rights and obligations under the transaction documents. This document cannot be reproduced except in full, without prior written approval of the Company. Any unauthorized alteration, forgery or falsification of the content or appearance of this document is unlawful and offenders may be prosecuted to the fullest extent of the law.

Report Number :TERF2308001923E2
 Operation Mode :802.11a
 Test Frequency :5500 MHz
 Test Mode :Tx
 EUT Pol :E2 Plane

Test Site :SAC G Chamber
 Test Date :2023-08-25
 Temp./Humi. :25.9°C/57%
 Antenna Pol. :Vertical
 Engineer :Temo Chen

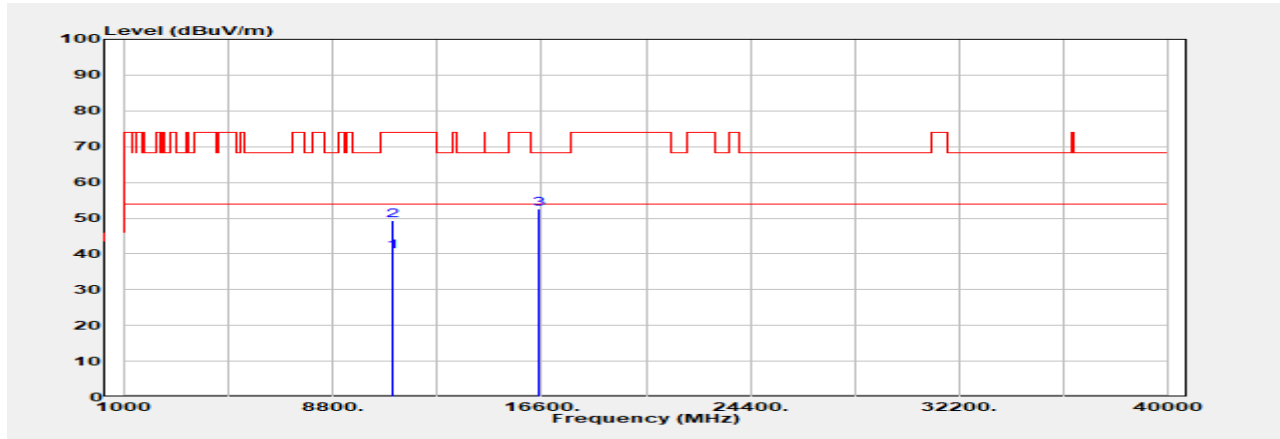

Freq. MHz	Detector Mode PK/QP/AVG	Spectrum Reading Level dBμV	Factor dB	Actual FS dBμV/m	Limit @3m dBμV/m	Margin dB
11000.000	Average	28.75	11.90	40.65	54.00	-13.35
11000.000	Peak	37.34	11.90	49.24	74.00	-24.76
16500.000	Peak	40.60	12.00	52.60	68.20	-15.60

Unless otherwise stated the results shown in this test report refer only to the sample(s) tested and such sample(s) are retained for 90 days only.

除非另有說明，此報告結果僅對測試之樣品負責，同時此樣品僅保留90天。本報告未經本公司書面許可，不可部份複製。

This document is issued by the Company subject to its General Conditions of Service printed overleaf, available on request or accessible at <http://www.sgs.com.tw/Terms-and-Conditions> and for electronic format documents, subject to Terms and Conditions for Electronic Documents at <http://www.sgs.com.tw/Terms-and-Conditions>. Attention is drawn to the limitation of liability, indemnification and jurisdiction issues defined therein. Any holder of this document is advised that information contained hereon reflects the Company's findings at the time of its intervention only and within the limits of Client's instructions, if any. The Company's sole responsibility is to its Client and this document does not exonerate parties to a transaction from exercising all their rights and obligations under the transaction documents. This document cannot be reproduced except in full, without prior written approval of the Company. Any unauthorized alteration, forgery or falsification of the content or appearance of this document is unlawful and offenders may be prosecuted to the fullest extent of the law.

Report Number :TERF2308001923E2
 Operation Mode :802.11a
 Test Frequency :5500 MHz
 Test Mode :Tx
 EUT Pol :E2 Plane

Test Site :SAC G Chamber
 Test Date :2023-08-25
 Temp./Humi. :25.9°C/57%
 Antenna Pol. :Horizontal
 Engineer :Temo Chen

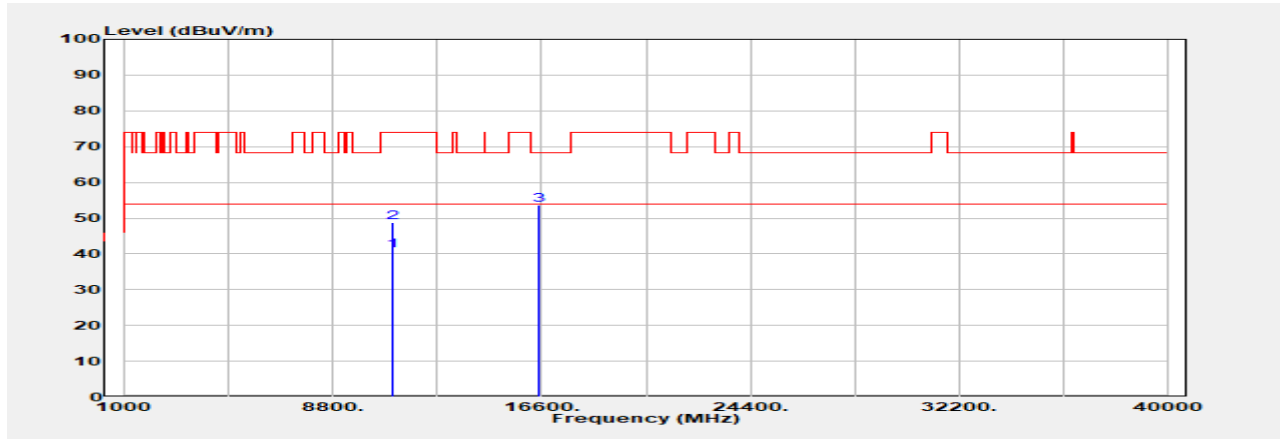

Freq. MHz	Detector Mode PK/QP/AVG	Spectrum Reading Level dB μ V	Factor dB	Actual FS dB μ V/m	Limit @3m dB μ V/m	Margin dB
11000.000	Average	28.99	11.90	40.89	54.00	-13.11
11000.000	Peak	36.78	11.90	48.68	74.00	-25.32
16500.000	Peak	41.68	12.00	53.68	68.20	-14.52

Unless otherwise stated the results shown in this test report refer only to the sample(s) tested and such sample(s) are retained for 90 days only.

除非另有說明，此報告結果僅對測試之樣品負責，同時此樣品僅保留90天。本報告未經本公司書面許可，不可部份複製。

This document is issued by the Company subject to its General Conditions of Service printed overleaf, available on request or accessible at <http://www.sgs.com.tw/Terms-and-Conditions> and for electronic format documents, subject to Terms and Conditions for Electronic Documents at <http://www.sgs.com.tw/Terms-and-Conditions>. Attention is drawn to the limitation of liability, indemnification and jurisdiction issues defined therein. Any holder of this document is advised that information contained hereon reflects the Company's findings at the time of its intervention only and within the limits of Client's instructions, if any. The Company's sole responsibility is to its Client and this document does not exonerate parties to a transaction from exercising all their rights and obligations under the transaction documents. This document cannot be reproduced except in full, without prior written approval of the Company. Any unauthorized alteration, forgery or falsification of the content or appearance of this document is unlawful and offenders may be prosecuted to the fullest extent of the law.

Report Number :TERF2308001923E2
 Operation Mode :802.11a
 Test Frequency :5580 MHz
 Test Mode :Tx
 EUT Pol :E2 Plane

Test Site :SAC G Chamber
 Test Date :2023-08-26
 Temp./Humi. :26.9°C/59%
 Antenna Pol. :Vertical
 Engineer :Temo Chen

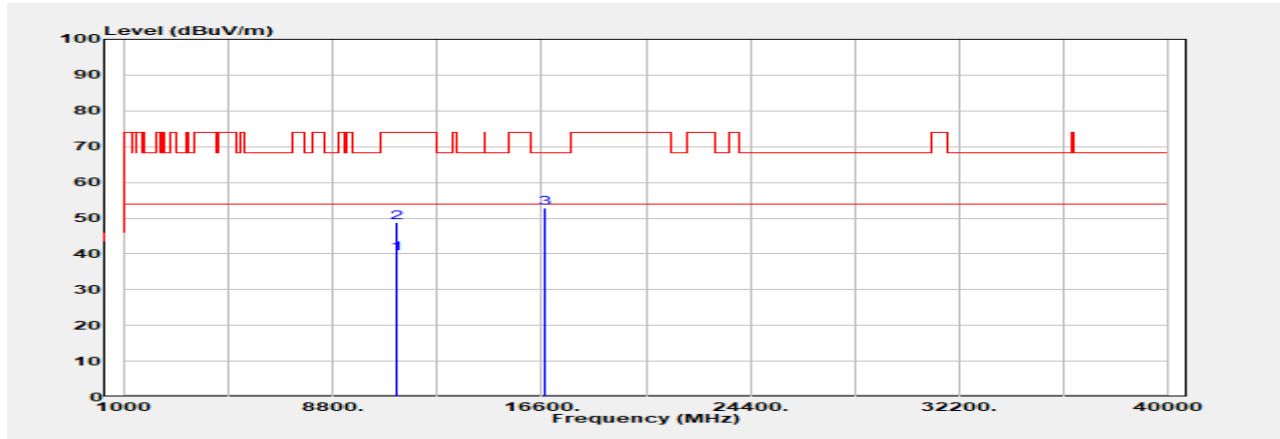

Freq. MHz	Detector Mode PK/QP/AVG	Spectrum Reading Level dB μ V	Factor dB	Actual FS dB μ V/m	Limit @3m dB μ V/m	Margin dB
11160.000	Average	30.13	9.88	40.01	54.00	-13.99
11160.000	Peak	38.83	9.88	48.71	74.00	-25.29
16740.000	Peak	41.14	11.66	52.80	68.20	-15.40

Unless otherwise stated the results shown in this test report refer only to the sample(s) tested and such sample(s) are retained for 90 days only.

除非另有說明，此報告結果僅對測試之樣品負責，同時此樣品僅保留90天。本報告未經本公司書面許可，不可部份複製。

This document is issued by the Company subject to its General Conditions of Service printed overleaf, available on request or accessible at <http://www.sgs.com.tw/Terms-and-Conditions> and for electronic format documents, subject to Terms and Conditions for Electronic Documents at <http://www.sgs.com.tw/Terms-and-Conditions>. Attention is drawn to the limitation of liability, indemnification and jurisdiction issues defined therein. Any holder of this document is advised that information contained hereon reflects the Company's findings at the time of its intervention only and within the limits of Client's instructions, if any. The Company's sole responsibility is to its Client and this document does not exonerate parties to a transaction from exercising all their rights and obligations under the transaction documents. This document cannot be reproduced except in full, without prior written approval of the Company. Any unauthorized alteration, forgery or falsification of the content or appearance of this document is unlawful and offenders may be prosecuted to the fullest extent of the law.

Report Number :TERF2308001923E2

Test Site :SAC G Chamber

Operation Mode :802.11a

Test Date :2023-08-26

Test Frequency :5580 MHz

Temp./Humi. :26.9°C/59%

Test Mode :Tx

Antenna Pol. :Horizontal

EUT Pol :E2 Plane

Engineer :Temo Chen

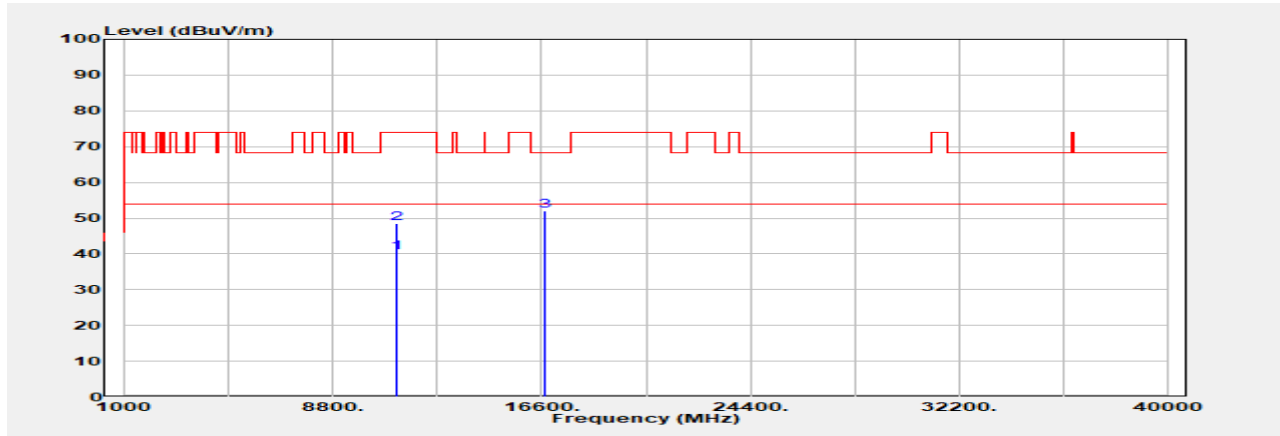

Freq. MHz	Detector Mode PK/QP/AVG	Spectrum Reading Level dBμV	Factor dB	Actual FS dBμV/m	Limit @3m dBμV/m	Margin dB
11160.000	Average	30.42	9.88	40.30	54.00	-13.70
11160.000	Peak	38.72	9.88	48.60	74.00	-25.40
16740.000	Peak	40.48	11.66	52.14	68.20	-16.06

Unless otherwise stated the results shown in this test report refer only to the sample(s) tested and such sample(s) are retained for 90 days only.

除非另有說明，此報告結果僅對測試之樣品負責，同時此樣品僅保留90天。本報告未經本公司書面許可，不可部份複製。

This document is issued by the Company subject to its General Conditions of Service printed overleaf, available on request or accessible at <http://www.sgs.com.tw/Terms-and-Conditions> and for electronic format documents, subject to Terms and Conditions for Electronic Documents at <http://www.sgs.com.tw/Terms-and-Conditions>. Attention is drawn to the limitation of liability, indemnification and jurisdiction issues defined therein. Any holder of this document is advised that information contained hereon reflects the Company's findings at the time of its intervention only and within the limits of Client's instructions, if any. The Company's sole responsibility is to its Client and this document does not exonerate parties to a transaction from exercising all their rights and obligations under the transaction documents. This document cannot be reproduced except in full, without prior written approval of the Company. Any unauthorized alteration, forgery or falsification of the content or appearance of this document is unlawful and offenders may be prosecuted to the fullest extent of the law.

Report Number :TERF2308001923E2

Test Site :SAC G Chamber

Operation Mode :802.11a

Test Date :2023-08-26

Test Frequency :5700 MHz

Temp./Humi. :26.9°C/59%

Test Mode :Tx

Antenna Pol. :Vertical

EUT Pol :E2 Plane

Engineer :Temo Chen

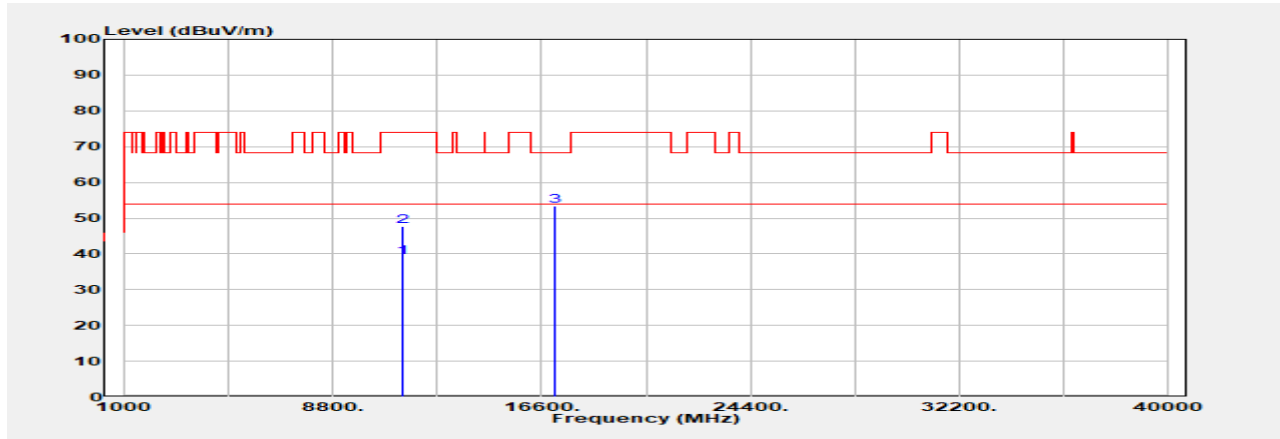

Freq. MHz	Detector Mode PK/QP/AVG	Spectrum Reading Level dB μ V	Factor dB	Actual FS dB μ V/m	Limit @3m dB μ V/m	Margin dB
11400.000	Average	29.11	9.80	38.91	54.00	-15.09
11400.000	Peak	37.94	9.80	47.74	74.00	-26.26
17100.000	Peak	41.19	12.20	53.39	68.20	-14.81

Unless otherwise stated the results shown in this test report refer only to the sample(s) tested and such sample(s) are retained for 90 days only.

除非另有說明，此報告結果僅對測試之樣品負責，同時此樣品僅保留90天。本報告未經本公司書面許可，不可部份複製。

This document is issued by the Company subject to its General Conditions of Service printed overleaf, available on request or accessible at <http://www.sgs.com.tw/Terms-and-Conditions> and for electronic format documents, subject to Terms and Conditions for Electronic Documents at <http://www.sgs.com.tw/Terms-and-Conditions>. Attention is drawn to the limitation of liability, indemnification and jurisdiction issues defined therein. Any holder of this document is advised that information contained hereon reflects the Company's findings at the time of its intervention only and within the limits of Client's instructions, if any. The Company's sole responsibility is to its Client and this document does not exonerate parties to a transaction from exercising all their rights and obligations under the transaction documents. This document cannot be reproduced except in full, without prior written approval of the Company. Any unauthorized alteration, forgery or falsification of the content or appearance of this document is unlawful and offenders may be prosecuted to the fullest extent of the law.

Report Number :TERF2308001923E2

Test Site :SAC G Chamber

Operation Mode :802.11a

Test Date :2023-08-26

Test Frequency :5700 MHz

Temp./Humi. :26.9°C/59%

Test Mode :Tx

Antenna Pol. :Horizontal

EUT Pol :E2 Plane

Engineer :Temo Chen

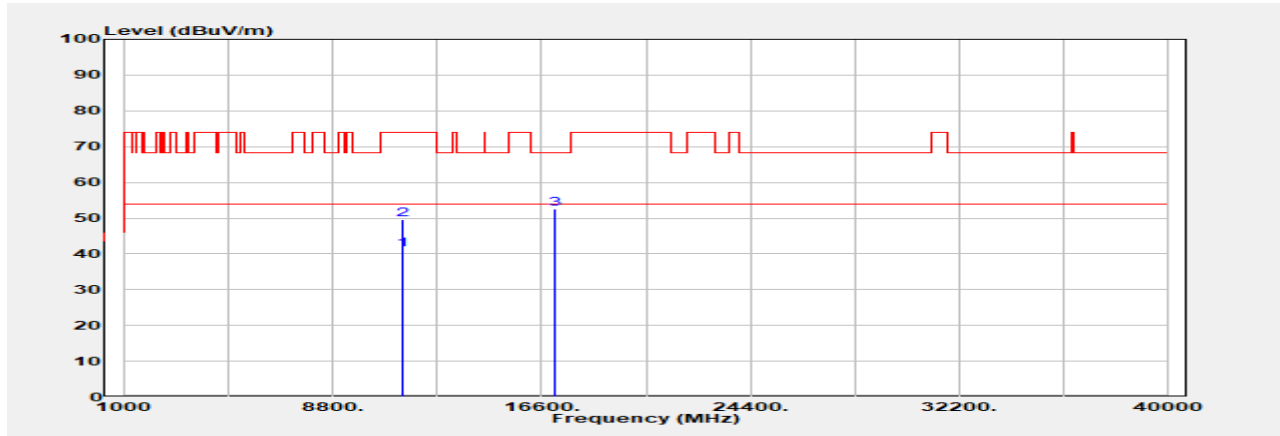

Freq. MHz	Detector Mode PK/QP/AVG	Spectrum Reading Level dBμV	Factor dB	Actual FS dBμV/m	Limit @3m dBμV/m	Margin dB
11400.000	Average	31.52	9.80	41.32	54.00	-12.68
11400.000	Peak	39.89	9.80	49.69	74.00	-24.31
17100.000	Peak	40.36	12.20	52.56	68.20	-15.64

Unless otherwise stated the results shown in this test report refer only to the sample(s) tested and such sample(s) are retained for 90 days only.

除非另有說明，此報告結果僅對測試之樣品負責，同時此樣品僅保留90天。本報告未經本公司書面許可，不可部份複製。

This document is issued by the Company subject to its General Conditions of Service printed overleaf, available on request or accessible at <http://www.sgs.com.tw/Terms-and-Conditions> and for electronic format documents, subject to Terms and Conditions for Electronic Documents at <http://www.sgs.com.tw/Terms-and-Conditions>. Attention is drawn to the limitation of liability, indemnification and jurisdiction issues defined therein. Any holder of this document is advised that information contained hereon reflects the Company's findings at the time of its intervention only and within the limits of Client's instructions, if any. The Company's sole responsibility is to its Client and this document does not exonerate parties to a transaction from exercising all their rights and obligations under the transaction documents. This document cannot be reproduced except in full, without prior written approval of the Company. Any unauthorized alteration, forgery or falsification of the content or appearance of this document is unlawful and offenders may be prosecuted to the fullest extent of the law.

Report Number :TERF2308001923E2

Test Site :SAC G Chamber

Operation Mode :802.11a

Test Date :2023-08-26

Test Frequency :5745 MHz

Temp./Humi. :26.9°C/59%

Test Mode :Tx

Antenna Pol. :Vertical

EUT Pol :E2 Plane

Engineer :Temo Chen

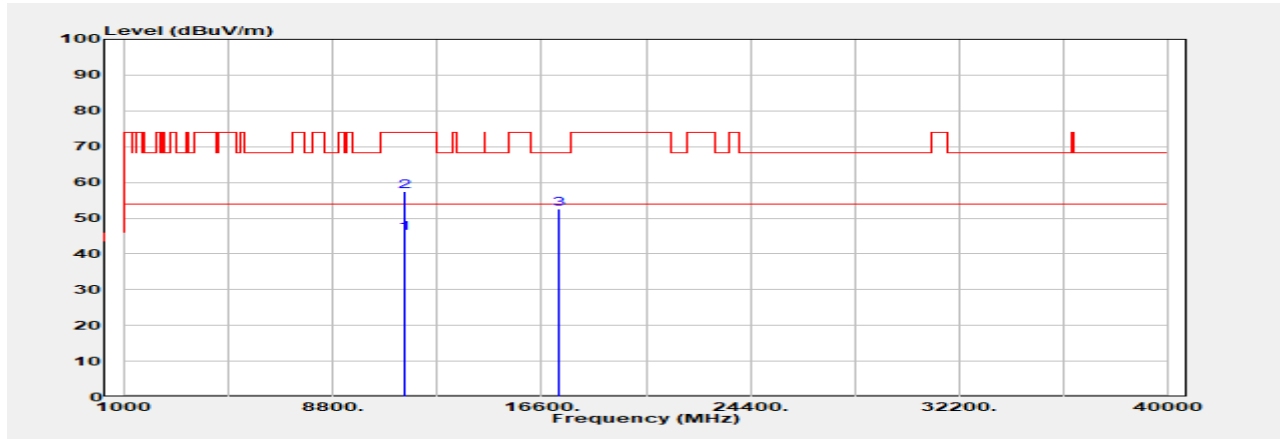

Freq. MHz	Detector Mode PK/QP/AVG	Spectrum Reading Level dBUV	Factor dB	Actual FS dBUV/m	Limit @3m dBUV/m	Margin dB
11490.000	Average	34.62	11.06	45.68	54.00	-8.32
11490.000	Peak	46.43	11.06	57.49	74.00	-16.51
17235.000	Peak	41.74	10.82	52.56	68.20	-15.64

Unless otherwise stated the results shown in this test report refer only to the sample(s) tested and such sample(s) are retained for 90 days only.

除非另有說明，此報告結果僅對測試之樣品負責，同時此樣品僅保留90天。本報告未經本公司書面許可，不可部份複製。

This document is issued by the Company subject to its General Conditions of Service printed overleaf, available on request or accessible at <http://www.sgs.com.tw/Terms-and-Conditions> and for electronic format documents, subject to Terms and Conditions for Electronic Documents at <http://www.sgs.com.tw/Terms-and-Conditions>. Attention is drawn to the limitation of liability, indemnification and jurisdiction issues defined therein. Any holder of this document is advised that information contained hereon reflects the Company's findings at the time of its intervention only and within the limits of Client's instructions, if any. The Company's sole responsibility is to its Client and this document does not exonerate parties to a transaction from exercising all their rights and obligations under the transaction documents. This document cannot be reproduced except in full, without prior written approval of the Company. Any unauthorized alteration, forgery or falsification of the content or appearance of this document is unlawful and offenders may be prosecuted to the fullest extent of the law.

Report Number :TERF2308001923E2

Test Site :SAC G Chamber

Operation Mode :802.11a

Test Date :2023-08-26

Test Frequency :5745 MHz

Temp./Humi. :26.9°C/59%

Test Mode :Tx

Antenna Pol. :Horizontal

EUT Pol :E2 Plane

Engineer :Temo Chen

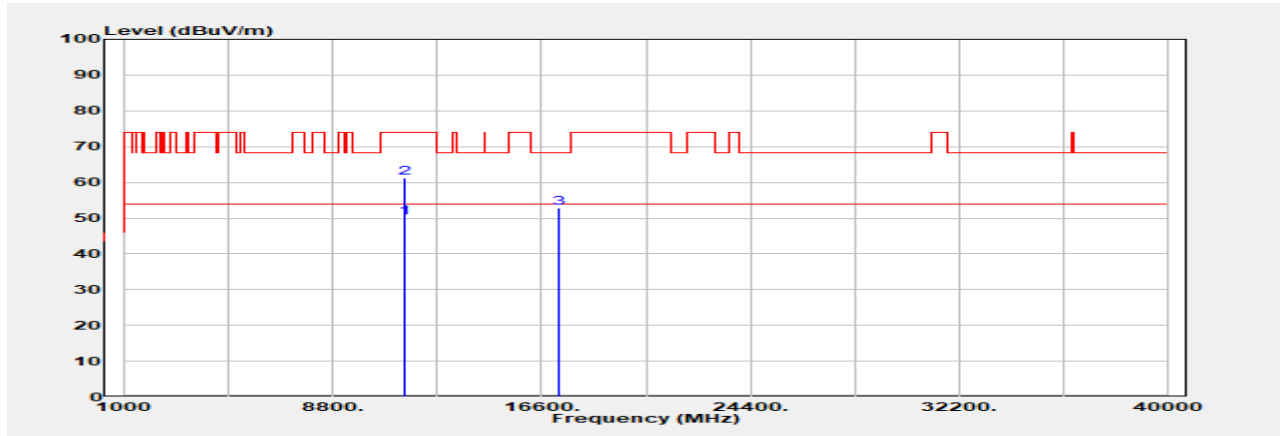

Freq. MHz	Detector Mode PK/QP/AVG	Spectrum Reading Level dBUV	Factor dB	Actual FS dBUV/m	Limit @3m dBUV/m	Margin dB
11490.000	Average	39.17	11.06	50.23	54.00	-3.77
11490.000	Peak	50.13	11.06	61.19	74.00	-12.81
17235.000	Peak	42.04	10.82	52.86	68.20	-15.34

Unless otherwise stated the results shown in this test report refer only to the sample(s) tested and such sample(s) are retained for 90 days only.

除非另有說明，此報告結果僅對測試之樣品負責，同時此樣品僅保留90天。本報告未經本公司書面許可，不可部份複製。

This document is issued by the Company subject to its General Conditions of Service printed overleaf, available on request or accessible at <http://www.sgs.com.tw/Terms-and-Conditions> and for electronic format documents, subject to Terms and Conditions for Electronic Documents at <http://www.sgs.com.tw/Terms-and-Conditions>. Attention is drawn to the limitation of liability, indemnification and jurisdiction issues defined therein. Any holder of this document is advised that information contained hereon reflects the Company's findings at the time of its intervention only and within the limits of Client's instructions, if any. The Company's sole responsibility is to its Client and this document does not exonerate parties to a transaction from exercising all their rights and obligations under the transaction documents. This document cannot be reproduced except in full, without prior written approval of the Company. Any unauthorized alteration, forgery or falsification of the content or appearance of this document is unlawful and offenders may be prosecuted to the fullest extent of the law.

Report Number :TERF2308001923E2

Test Site :SAC G Chamber

Operation Mode :802.11a

Test Date :2023-10-19

Test Frequency :5785 MHz

Temp./Humi. :22.3°C/60%

Test Mode :Tx

Antenna Pol. :Vertical

EUT Pol :E2 Plane

Engineer :Temo Chen

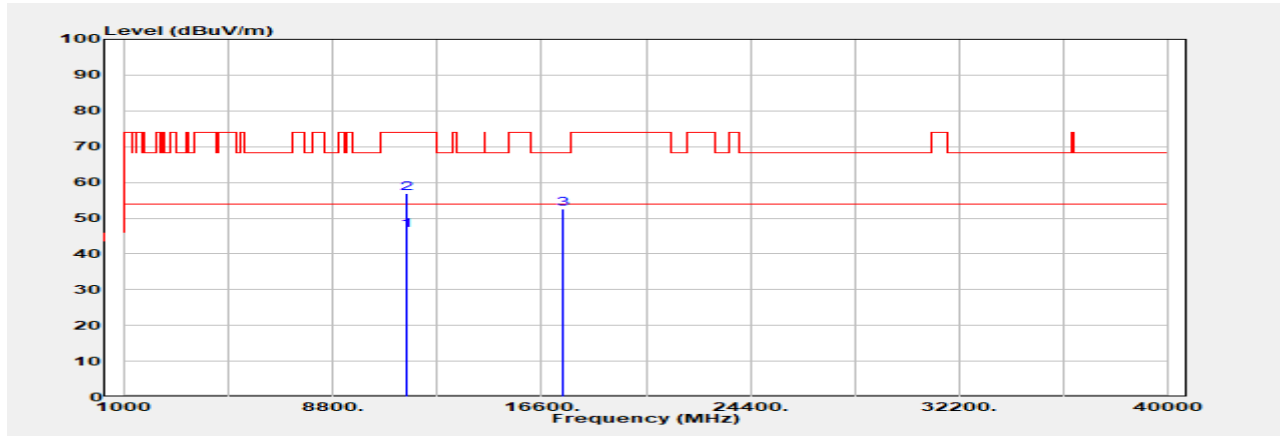

Freq. MHz	Detector Mode PK/QP/AVG	Spectrum Reading Level dBμV	Factor dB	Actual FS dBμV/m	Limit @3m dBμV/m	Margin dB
11570.000	Average	36.55	10.15	46.70	54.00	-7.30
11570.000	Peak	46.86	10.15	57.01	74.00	-16.99
17355.000	Peak	40.80	11.82	52.62	68.20	-15.58

Unless otherwise stated the results shown in this test report refer only to the sample(s) tested and such sample(s) are retained for 90 days only.

除非另有說明，此報告結果僅對測試之樣品負責，同時此樣品僅保留90天。本報告未經本公司書面許可，不可部份複製。

This document is issued by the Company subject to its General Conditions of Service printed overleaf, available on request or accessible at <http://www.sgs.com.tw/Terms-and-Conditions> and for electronic format documents, subject to Terms and Conditions for Electronic Documents at <http://www.sgs.com.tw/Terms-and-Conditions>. Attention is drawn to the limitation of liability, indemnification and jurisdiction issues defined therein. Any holder of this document is advised that information contained hereon reflects the Company's findings at the time of its intervention only and within the limits of Client's instructions, if any. The Company's sole responsibility is to its Client and this document does not exonerate parties to a transaction from exercising all their rights and obligations under the transaction documents. This document cannot be reproduced except in full, without prior written approval of the Company. Any unauthorized alteration, forgery or falsification of the content or appearance of this document is unlawful and offenders may be prosecuted to the fullest extent of the law.

Report Number :TERF2308001923E2

Test Site :SAC G Chamber

Operation Mode :802.11a

Test Date :2023-10-19

Test Frequency :5785 MHz

Temp./Humi. :22.3°C/60%

Test Mode :Tx

Antenna Pol. :Horizontal

EUT Pol :E2 Plane

Engineer :Temo Chen

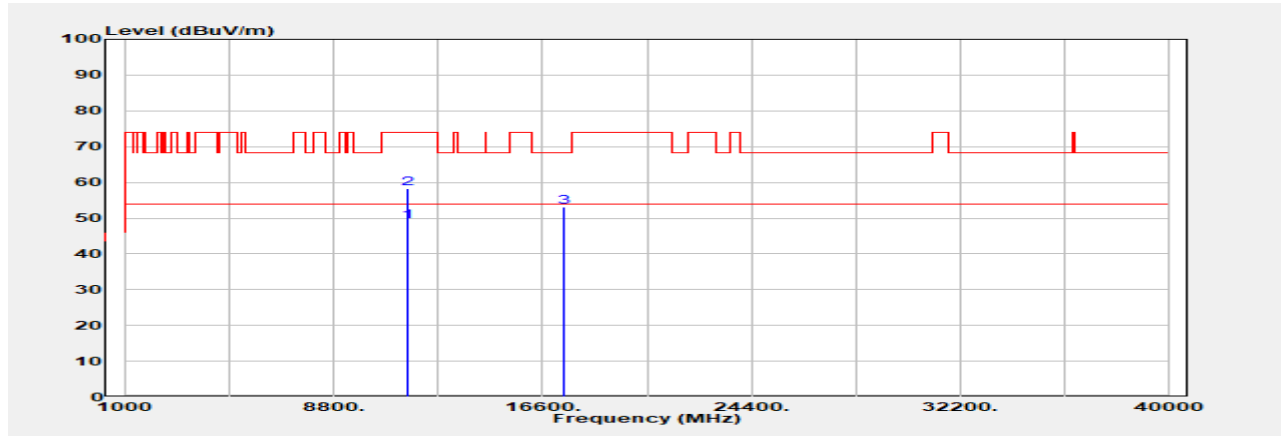

Freq. MHz	Detector Mode PK/QP/AVG	Spectrum Reading Level dB μ V	Factor dB	Actual FS dB μ V/m	Limit @3m dB μ V/m	Margin dB
11570.000	Average	38.81	10.15	48.96	54.00	-5.04
11570.000	Peak	48.16	10.15	58.31	74.00	-15.69
17355.000	Peak	41.39	11.82	53.21	68.20	-14.99

Unless otherwise stated the results shown in this test report refer only to the sample(s) tested and such sample(s) are retained for 90 days only.

除非另有說明，此報告結果僅對測試之樣品負責，同時此樣品僅保留90天。本報告未經本公司書面許可，不可部份複製。

This document is issued by the Company subject to its General Conditions of Service printed overleaf, available on request or accessible at <http://www.sgs.com.tw/Terms-and-Conditions> and for electronic format documents, subject to Terms and Conditions for Electronic Documents at <http://www.sgs.com.tw/Terms-and-Conditions>. Attention is drawn to the limitation of liability, indemnification and jurisdiction issues defined therein. Any holder of this document is advised that information contained hereon reflects the Company's findings at the time of its intervention only and within the limits of Client's instructions, if any. The Company's sole responsibility is to its Client and this document does not exonerate parties to a transaction from exercising all their rights and obligations under the transaction documents. This document cannot be reproduced except in full, without prior written approval of the Company. Any unauthorized alteration, forgery or falsification of the content or appearance of this document is unlawful and offenders may be prosecuted to the fullest extent of the law.

Report Number :TERF2308001923E2

Test Site :SAC G Chamber

Operation Mode :802.11a

Test Date :2023-08-26

Test Frequency :5825 MHz

Temp./Humi. :26.9°C/59%

Test Mode :Tx

Antenna Pol. :Vertical

EUT Pol :E2 Plane

Engineer :Temo Chen

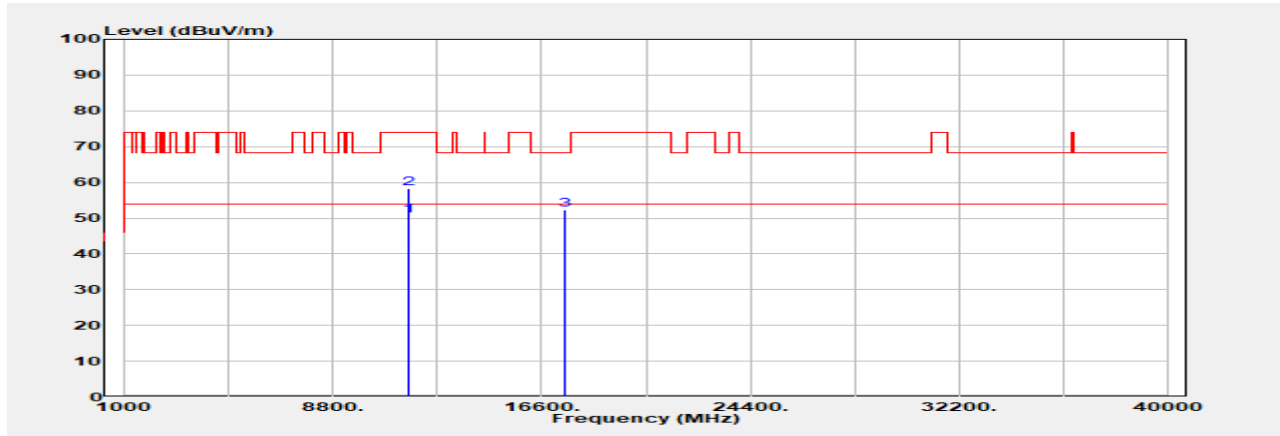

Freq. MHz	Detector Mode PK/QP/AVG	Spectrum Reading Level dBUV	Factor dB	Actual FS dBUV/m	Limit @3m dBUV/m	Margin dB
11650.000	Average	40.52	10.05	50.57	54.00	-3.43
11650.000	Peak	48.30	10.05	58.35	74.00	-15.65
17475.000	Peak	41.33	11.10	52.43	68.20	-15.77

Unless otherwise stated the results shown in this test report refer only to the sample(s) tested and such sample(s) are retained for 90 days only.

除非另有說明，此報告結果僅對測試之樣品負責，同時此樣品僅保留90天。本報告未經本公司書面許可，不可部份複製。

This document is issued by the Company subject to its General Conditions of Service printed overleaf, available on request or accessible at <http://www.sgs.com.tw/Terms-and-Conditions> and for electronic format documents, subject to Terms and Conditions for Electronic Documents at <http://www.sgs.com.tw/Terms-and-Conditions>. Attention is drawn to the limitation of liability, indemnification and jurisdiction issues defined therein. Any holder of this document is advised that information contained hereon reflects the Company's findings at the time of its intervention only and within the limits of Client's instructions, if any. The Company's sole responsibility is to its Client and this document does not exonerate parties to a transaction from exercising all their rights and obligations under the transaction documents. This document cannot be reproduced except in full, without prior written approval of the Company. Any unauthorized alteration, forgery or falsification of the content or appearance of this document is unlawful and offenders may be prosecuted to the fullest extent of the law.

Report Number :TERF2308001923E2

Test Site :SAC G Chamber

Operation Mode :802.11a

Test Date :2023-08-26

Test Frequency :5825 MHz

Temp./Humi. :26.9°C/59%

Test Mode :Tx

Antenna Pol. :Horizontal

EUT Pol :E2 Plane

Engineer :Temo Chen

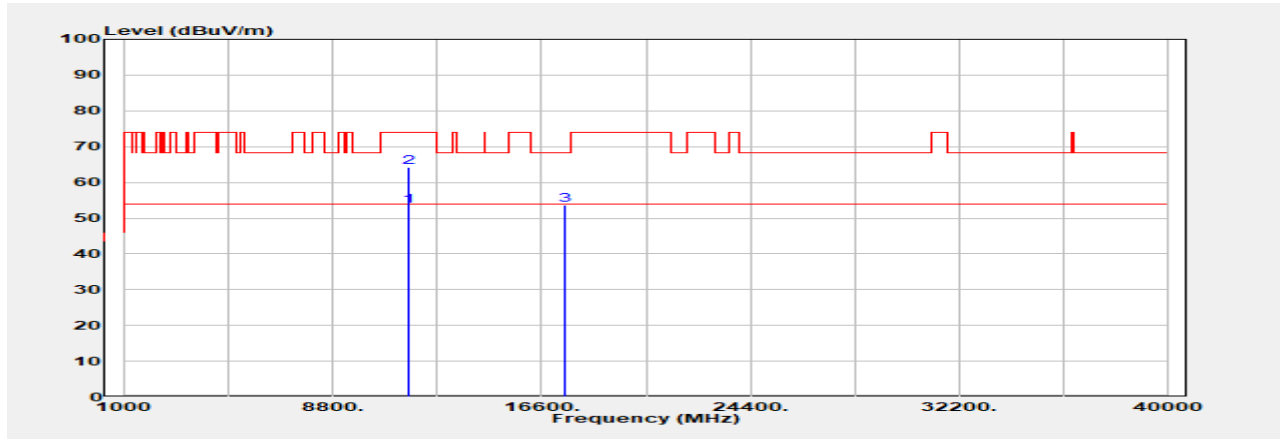

Freq. MHz	Detector Mode PK/QP/AVG	Spectrum Reading Level dB μ V	Factor dB	Actual FS dB μ V/m	Limit @3m dB μ V/m	Margin dB
11650.000	Average	43.35	10.05	53.40	54.00	-0.60
11650.000	Peak	54.19	10.05	64.24	74.00	-9.76
17475.000	Peak	42.46	11.10	53.56	68.20	-14.64

Unless otherwise stated the results shown in this test report refer only to the sample(s) tested and such sample(s) are retained for 90 days only.

除非另有說明，此報告結果僅對測試之樣品負責，同時此樣品僅保留90天。本報告未經本公司書面許可，不可部份複製。

This document is issued by the Company subject to its General Conditions of Service printed overleaf, available on request or accessible at <http://www.sgs.com.tw/Terms-and-Conditions> and for electronic format documents, subject to Terms and Conditions for Electronic Documents at <http://www.sgs.com.tw/Terms-and-Conditions>. Attention is drawn to the limitation of liability, indemnification and jurisdiction issues defined therein. Any holder of this document is advised that information contained hereon reflects the Company's findings at the time of its intervention only and within the limits of Client's instructions, if any. The Company's sole responsibility is to its Client and this document does not exonerate parties to a transaction from exercising all their rights and obligations under the transaction documents. This document cannot be reproduced except in full, without prior written approval of the Company. Any unauthorized alteration, forgery or falsification of the content or appearance of this document is unlawful and offenders may be prosecuted to the fullest extent of the law.

Report Number :TERF2308001923E2
 Operation Mode :802.11n20
 Test Frequency :5180 MHz
 Test Mode :Tx
 EUT Pol :E2 Plane

Test Site :SAC G Chamber
 Test Date :2023-10-19
 Temp./Humi. :22.3°C/60%
 Antenna Pol. :Vertical
 Engineer :Temo Chen

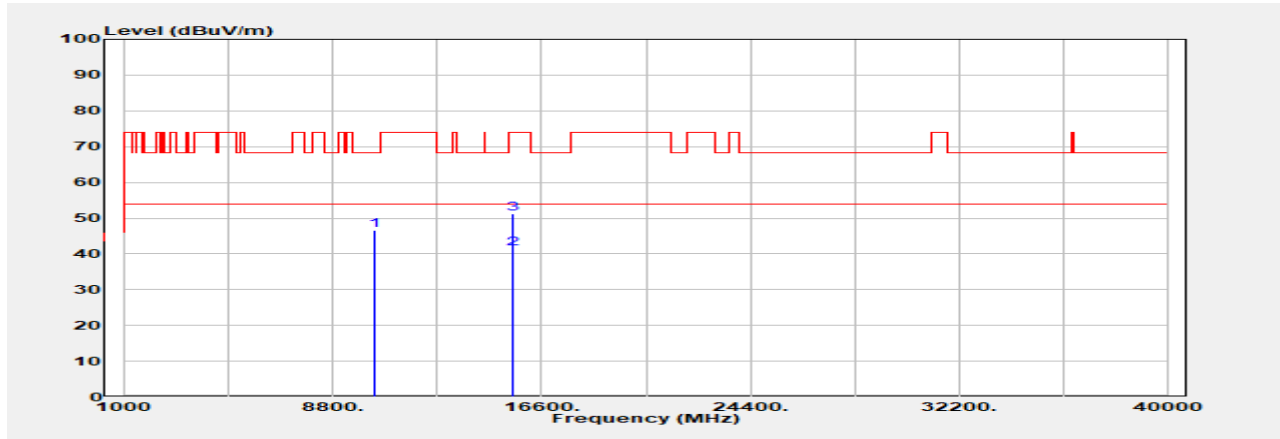

Freq. MHz	Detector Mode PK/QP/AVG	Spectrum Reading Level dB μ V	Factor dB	Actual FS dB μ V/m	Limit @3m dB μ V/m	Margin dB
10360.000	Peak	37.31	9.38	46.69	68.20	-21.51
15540.000	Average	29.46	11.96	41.42	54.00	-12.58
15540.000	Peak	39.34	11.96	51.30	74.00	-22.70

Unless otherwise stated the results shown in this test report refer only to the sample(s) tested and such sample(s) are retained for 90 days only.

除非另有說明，此報告結果僅對測試之樣品負責，同時此樣品僅保留90天。本報告未經本公司書面許可，不可部份複製。

This document is issued by the Company subject to its General Conditions of Service printed overleaf, available on request or accessible at <http://www.sgs.com.tw/Terms-and-Conditions> and for electronic format documents, subject to Terms and Conditions for Electronic Documents at <http://www.sgs.com.tw/Terms-and-Conditions>. Attention is drawn to the limitation of liability, indemnification and jurisdiction issues defined therein. Any holder of this document is advised that information contained hereon reflects the Company's findings at the time of its intervention only and within the limits of Client's instructions, if any. The Company's sole responsibility is to its Client and this document does not exonerate parties to a transaction from exercising all their rights and obligations under the transaction documents. This document cannot be reproduced except in full, without prior written approval of the Company. Any unauthorized alteration, forgery or falsification of the content or appearance of this document is unlawful and offenders may be prosecuted to the fullest extent of the law.

Report Number :TERF2308001923E2
 Operation Mode :802.11n20
 Test Frequency :5180 MHz
 Test Mode :Tx
 EUT Pol :E2 Plane

Test Site :SAC G Chamber
 Test Date :2023-10-19
 Temp./Humi. :22.3°C/60%
 Antenna Pol. :Horizontal
 Engineer :Temo Chen

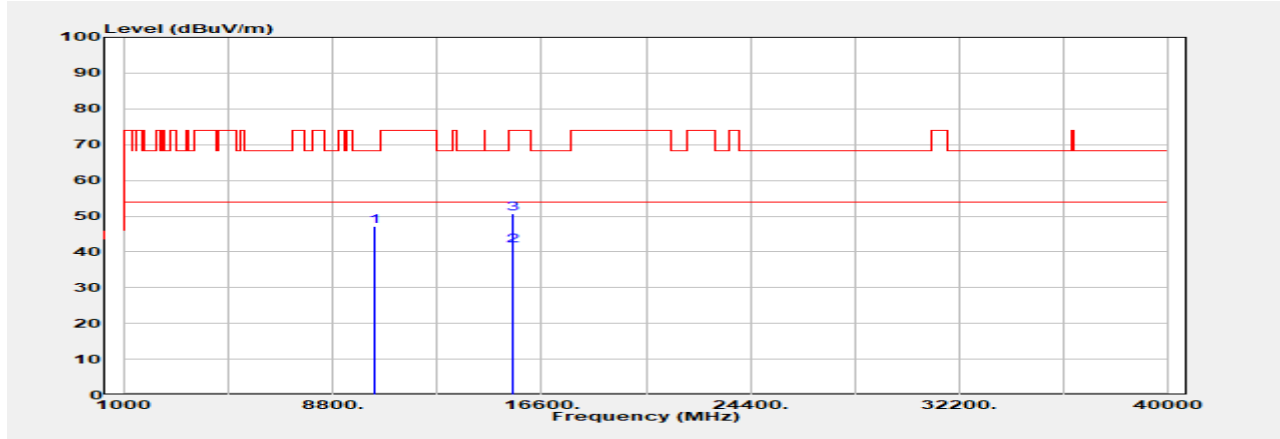

Freq. MHz	Detector Mode PK/QP/AVG	Spectrum Reading Level dB μ V	Factor dB	Actual FS dB μ V/m	Limit @3m dB μ V/m	Margin dB
10360.000	Peak	37.91	9.38	47.29	68.20	-20.91
15540.000	Average	29.88	11.96	41.84	54.00	-12.16
15540.000	Peak	38.71	11.96	50.67	74.00	-23.33

Unless otherwise stated the results shown in this test report refer only to the sample(s) tested and such sample(s) are retained for 90 days only.

除非另有說明，此報告結果僅對測試之樣品負責，同時此樣品僅保留90天。本報告未經本公司書面許可，不可部份複製。

This document is issued by the Company subject to its General Conditions of Service printed overleaf, available on request or accessible at <http://www.sgs.com.tw/Terms-and-Conditions> and for electronic format documents, subject to Terms and Conditions for Electronic Documents at <http://www.sgs.com.tw/Terms-and-Conditions>. Attention is drawn to the limitation of liability, indemnification and jurisdiction issues defined therein. Any holder of this document is advised that information contained hereon reflects the Company's findings at the time of its intervention only and within the limits of Client's instructions, if any. The Company's sole responsibility is to its Client and this document does not exonerate parties to a transaction from exercising all their rights and obligations under the transaction documents. This document cannot be reproduced except in full, without prior written approval of the Company. Any unauthorized alteration, forgery or falsification of the content or appearance of this document is unlawful and offenders may be prosecuted to the fullest extent of the law.

Report Number :TERF2308001923E2
 Operation Mode :802.11n20
 Test Frequency :5220 MHz
 Test Mode :Tx
 EUT Pol :E2 Plane

Test Site :SAC G Chamber
 Test Date :2023-08-26
 Temp./Humi. :26.9°C/59%
 Antenna Pol. :Vertical
 Engineer :Temo Chen

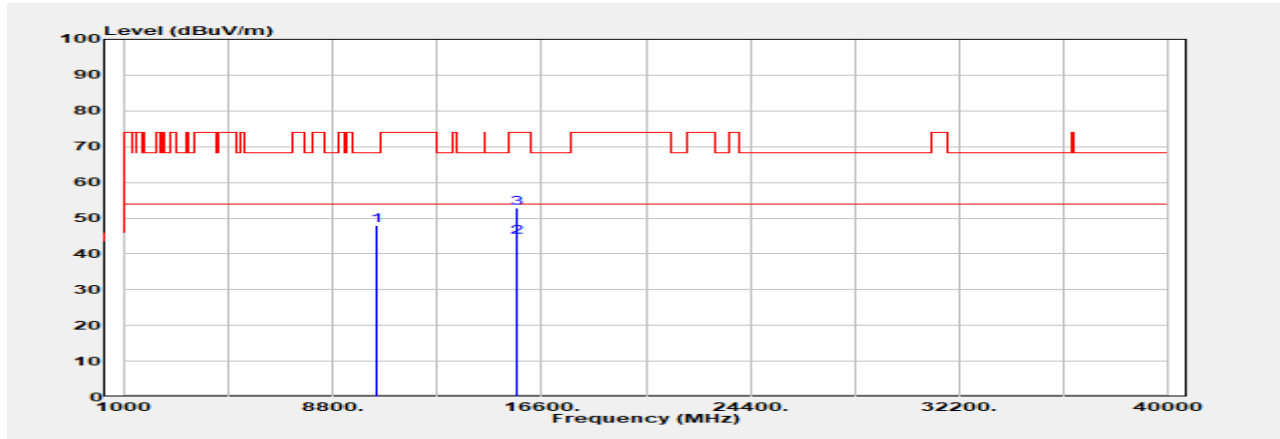

Freq. MHz	Detector Mode PK/QP/AVG	Spectrum Reading Level dB μ V	Factor dB	Actual FS dB μ V/m	Limit @3m dB μ V/m	Margin dB
10440.000	Peak	38.24	9.66	47.90	68.20	-20.30
15660.000	Average	32.42	12.32	44.74	54.00	-9.26
15660.000	Peak	40.62	12.32	52.94	74.00	-21.06

Unless otherwise stated the results shown in this test report refer only to the sample(s) tested and such sample(s) are retained for 90 days only.

除非另有說明，此報告結果僅對測試之樣品負責，同時此樣品僅保留90天。本報告未經本公司書面許可，不可部份複製。

This document is issued by the Company subject to its General Conditions of Service printed overleaf, available on request or accessible at <http://www.sgs.com.tw/Terms-and-Conditions> and for electronic format documents, subject to Terms and Conditions for Electronic Documents at <http://www.sgs.com.tw/Terms-and-Conditions>. Attention is drawn to the limitation of liability, indemnification and jurisdiction issues defined therein. Any holder of this document is advised that information contained hereon reflects the Company's findings at the time of its intervention only and within the limits of Client's instructions, if any. The Company's sole responsibility is to its Client and this document does not exonerate parties to a transaction from exercising all their rights and obligations under the transaction documents. This document cannot be reproduced except in full, without prior written approval of the Company. Any unauthorized alteration, forgery or falsification of the content or appearance of this document is unlawful and offenders may be prosecuted to the fullest extent of the law.

Report Number :TERF2308001923E2
 Operation Mode :802.11n20
 Test Frequency :5220 MHz
 Test Mode :Tx
 EUT Pol :E2 Plane

Test Site :SAC G Chamber
 Test Date :2023-08-26
 Temp./Humi. :26.9°C/59%
 Antenna Pol. :Horizontal
 Engineer :Temo Chen

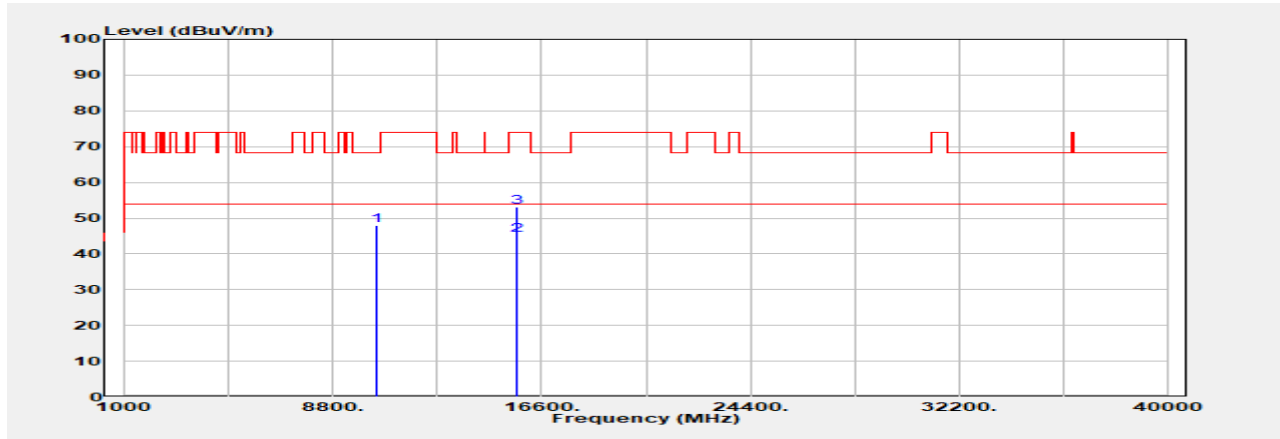

Freq. MHz	Detector Mode PK/QP/AVG	Spectrum Reading Level dBμV	Factor dB	Actual FS dBμV/m	Limit @3m dBμV/m	Margin dB
10440.000	Peak	38.35	9.66	48.01	68.20	-20.19
15660.000	Average	32.81	12.32	45.13	54.00	-8.87
15660.000	Peak	40.77	12.32	53.09	74.00	-20.91

Unless otherwise stated the results shown in this test report refer only to the sample(s) tested and such sample(s) are retained for 90 days only.

除非另有說明，此報告結果僅對測試之樣品負責，同時此樣品僅保留90天。本報告未經本公司書面許可，不可部份複製。

This document is issued by the Company subject to its General Conditions of Service printed overleaf, available on request or accessible at <http://www.sgs.com.tw/Terms-and-Conditions> and for electronic format documents, subject to Terms and Conditions for Electronic Documents at <http://www.sgs.com.tw/Terms-and-Conditions>. Attention is drawn to the limitation of liability, indemnification and jurisdiction issues defined therein. Any holder of this document is advised that information contained hereon reflects the Company's findings at the time of its intervention only and within the limits of Client's instructions, if any. The Company's sole responsibility is to its Client and this document does not exonerate parties to a transaction from exercising all their rights and obligations under the transaction documents. This document cannot be reproduced except in full, without prior written approval of the Company. Any unauthorized alteration, forgery or falsification of the content or appearance of this document is unlawful and offenders may be prosecuted to the fullest extent of the law.

Report Number :TERF2308001923E2
 Operation Mode :802.11n20
 Test Frequency :5240 MHz
 Test Mode :Tx
 EUT Pol :E2 Plane

Test Site :SAC G Chamber
 Test Date :2023-08-26
 Temp./Humi. :26.9°C/59%
 Antenna Pol. :Vertical
 Engineer :Temo Chen

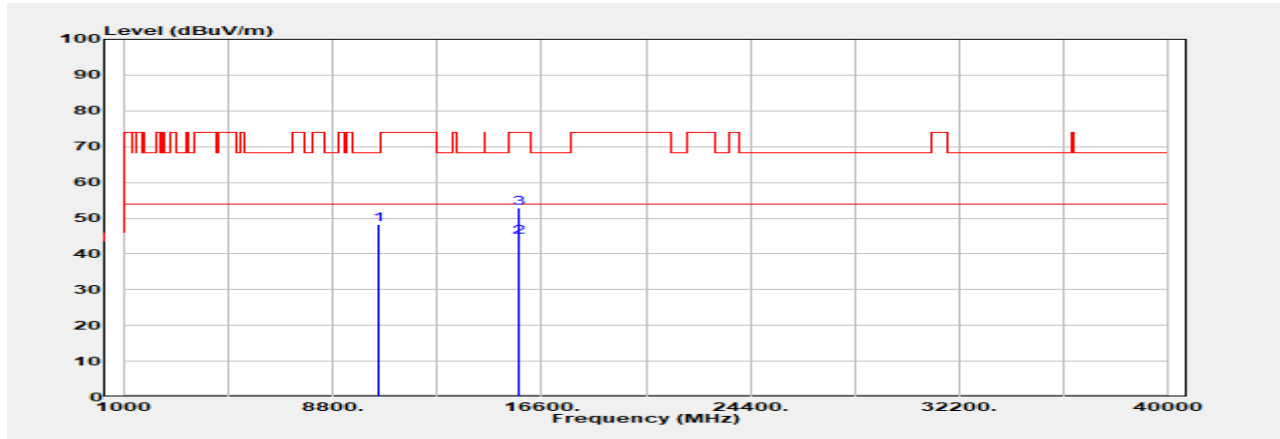

Freq. MHz	Detector Mode PK/QP/AVG	Spectrum Reading Level dBμV	Factor dB	Actual FS dBμV/m	Limit @3m dBμV/m	Margin dB
10480.000	Peak	38.33	9.82	48.16	68.20	-20.04
15720.000	Average	32.16	12.56	44.72	54.00	-9.28
15720.000	Peak	40.34	12.56	52.90	74.00	-21.10

Unless otherwise stated the results shown in this test report refer only to the sample(s) tested and such sample(s) are retained for 90 days only.

除非另有說明，此報告結果僅對測試之樣品負責，同時此樣品僅保留90天。本報告未經本公司書面許可，不可部份複製。

This document is issued by the Company subject to its General Conditions of Service printed overleaf, available on request or accessible at <http://www.sgs.com.tw/Terms-and-Conditions> and for electronic format documents, subject to Terms and Conditions for Electronic Documents at <http://www.sgs.com.tw/Terms-and-Conditions>. Attention is drawn to the limitation of liability, indemnification and jurisdiction issues defined therein. Any holder of this document is advised that information contained hereon reflects the Company's findings at the time of its intervention only and within the limits of Client's instructions, if any. The Company's sole responsibility is to its Client and this document does not exonerate parties to a transaction from exercising all their rights and obligations under the transaction documents. This document cannot be reproduced except in full, without prior written approval of the Company. Any unauthorized alteration, forgery or falsification of the content or appearance of this document is unlawful and offenders may be prosecuted to the fullest extent of the law.

Report Number :TERF2308001923E2
 Operation Mode :802.11n20
 Test Frequency :5240 MHz
 Test Mode :Tx
 EUT Pol :E2 Plane

Test Site :SAC G Chamber
 Test Date :2023-08-26
 Temp./Humi. :26.9°C/59%
 Antenna Pol. :Horizontal
 Engineer :Temo Chen

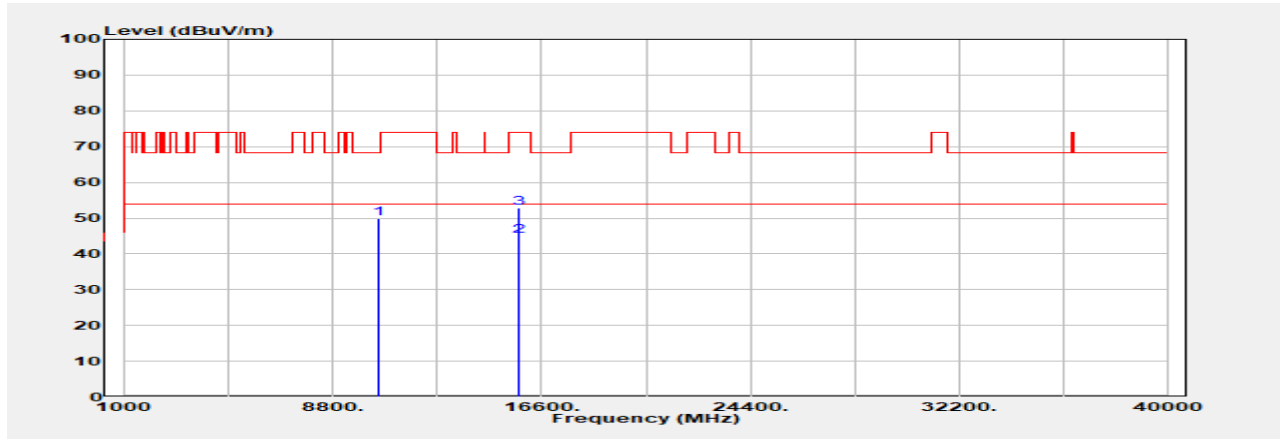

Freq. MHz	Detector Mode PK/QP/AVG	Spectrum Reading Level dBμV	Factor dB	Actual FS dBμV/m	Limit @3m dBμV/m	Margin dB
10480.000	Peak	40.06	9.82	49.88	68.20	-18.32
15720.000	Average	32.33	12.56	44.89	54.00	-9.11
15720.000	Peak	40.18	12.56	52.74	74.00	-21.26

Unless otherwise stated the results shown in this test report refer only to the sample(s) tested and such sample(s) are retained for 90 days only.

除非另有說明，此報告結果僅對測試之樣品負責，同時此樣品僅保留90天。本報告未經本公司書面許可，不可部份複製。

This document is issued by the Company subject to its General Conditions of Service printed overleaf, available on request or accessible at <http://www.sgs.com.tw/Terms-and-Conditions> and for electronic format documents, subject to Terms and Conditions for Electronic Documents at <http://www.sgs.com.tw/Terms-and-Conditions>. Attention is drawn to the limitation of liability, indemnification and jurisdiction issues defined therein. Any holder of this document is advised that information contained hereon reflects the Company's findings at the time of its intervention only and within the limits of Client's instructions, if any. The Company's sole responsibility is to its Client and this document does not exonerate parties to a transaction from exercising all their rights and obligations under the transaction documents. This document cannot be reproduced except in full, without prior written approval of the Company. Any unauthorized alteration, forgery or falsification of the content or appearance of this document is unlawful and offenders may be prosecuted to the fullest extent of the law.

Report Number :TERF2308001923E2
 Operation Mode :802.11n20
 Test Frequency :5260 MHz
 Test Mode :Tx
 EUT Pol :E2 Plane

Test Site :SAC G Chamber
 Test Date :2023-08-26
 Temp./Humi. :26.9°C/59%
 Antenna Pol. :Vertical
 Engineer :Temo Chen

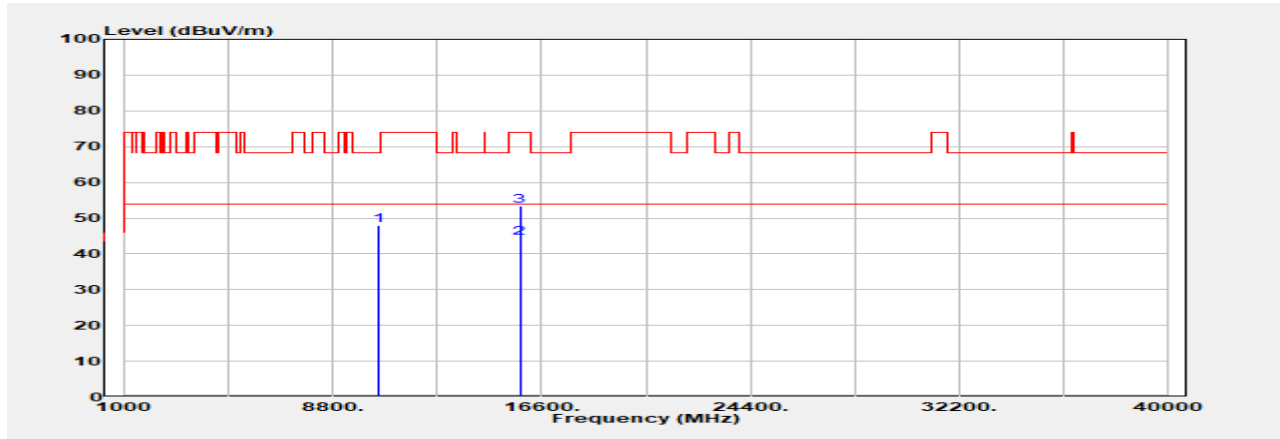

Freq. MHz	Detector Mode PK/QP/AVG	Spectrum Reading Level dB μ V	Factor dB	Actual FS dB μ V/m	Limit @3m dB μ V/m	Margin dB
10520.000	Peak	37.98	9.92	47.90	68.20	-20.30
15780.000	Average	32.12	12.44	44.56	54.00	-9.44
15780.000	Peak	40.94	12.44	53.38	74.00	-20.62

Unless otherwise stated the results shown in this test report refer only to the sample(s) tested and such sample(s) are retained for 90 days only.

除非另有說明，此報告結果僅對測試之樣品負責，同時此樣品僅保留90天。本報告未經本公司書面許可，不可部份複製。

This document is issued by the Company subject to its General Conditions of Service printed overleaf, available on request or accessible at <http://www.sgs.com.tw/Terms-and-Conditions> and for electronic format documents, subject to Terms and Conditions for Electronic Documents at <http://www.sgs.com.tw/Terms-and-Conditions>. Attention is drawn to the limitation of liability, indemnification and jurisdiction issues defined therein. Any holder of this document is advised that information contained hereon reflects the Company's findings at the time of its intervention only and within the limits of Client's instructions, if any. The Company's sole responsibility is to its Client and this document does not exonerate parties to a transaction from exercising all their rights and obligations under the transaction documents. This document cannot be reproduced except in full, without prior written approval of the Company. Any unauthorized alteration, forgery or falsification of the content or appearance of this document is unlawful and offenders may be prosecuted to the fullest extent of the law.

Report Number :TERF2308001923E2
 Operation Mode :802.11n20
 Test Frequency :5260 MHz
 Test Mode :Tx
 EUT Pol :E2 Plane

Test Site :SAC G Chamber
 Test Date :2023-08-26
 Temp./Humi. :26.9°C/59%
 Antenna Pol. :Horizontal
 Engineer :Temo Chen

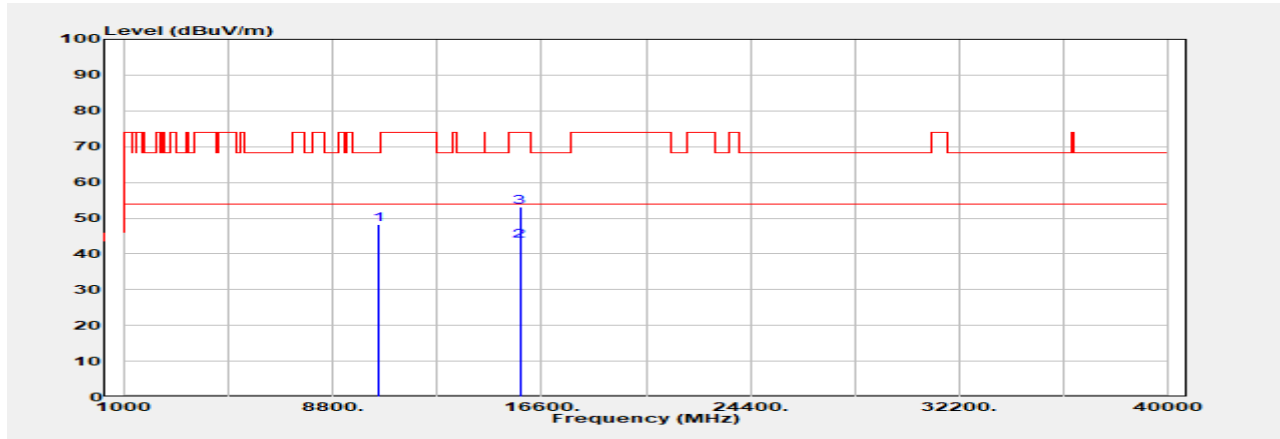

Freq. MHz	Detector Mode PK/QP/AVG	Spectrum Reading Level dB μ V	Factor dB	Actual FS dB μ V/m	Limit @3m dB μ V/m	Margin dB
10520.000	Peak	38.26	9.92	48.18	68.20	-20.02
15780.000	Average	31.25	12.44	43.69	54.00	-10.31
15780.000	Peak	40.64	12.44	53.08	74.00	-20.92

Unless otherwise stated the results shown in this test report refer only to the sample(s) tested and such sample(s) are retained for 90 days only.

除非另有說明，此報告結果僅對測試之樣品負責，同時此樣品僅保留90天。本報告未經本公司書面許可，不可部份複製。

This document is issued by the Company subject to its General Conditions of Service printed overleaf, available on request or accessible at <http://www.sgs.com.tw/Terms-and-Conditions> and for electronic format documents, subject to Terms and Conditions for Electronic Documents at <http://www.sgs.com.tw/Terms-and-Conditions>. Attention is drawn to the limitation of liability, indemnification and jurisdiction issues defined therein. Any holder of this document is advised that information contained hereon reflects the Company's findings at the time of its intervention only and within the limits of Client's instructions, if any. The Company's sole responsibility is to its Client and this document does not exonerate parties to a transaction from exercising all their rights and obligations under the transaction documents. This document cannot be reproduced except in full, without prior written approval of the Company. Any unauthorized alteration, forgery or falsification of the content or appearance of this document is unlawful and offenders may be prosecuted to the fullest extent of the law.

Report Number :TERF2308001923E2
 Operation Mode :802.11n20
 Test Frequency :5300 MHz
 Test Mode :Tx
 EUT Pol :E2 Plane

Test Site :SAC G Chamber
 Test Date :2023-08-26
 Temp./Humi. :26.9°C/59%
 Antenna Pol. :Vertical
 Engineer :Temo Chen

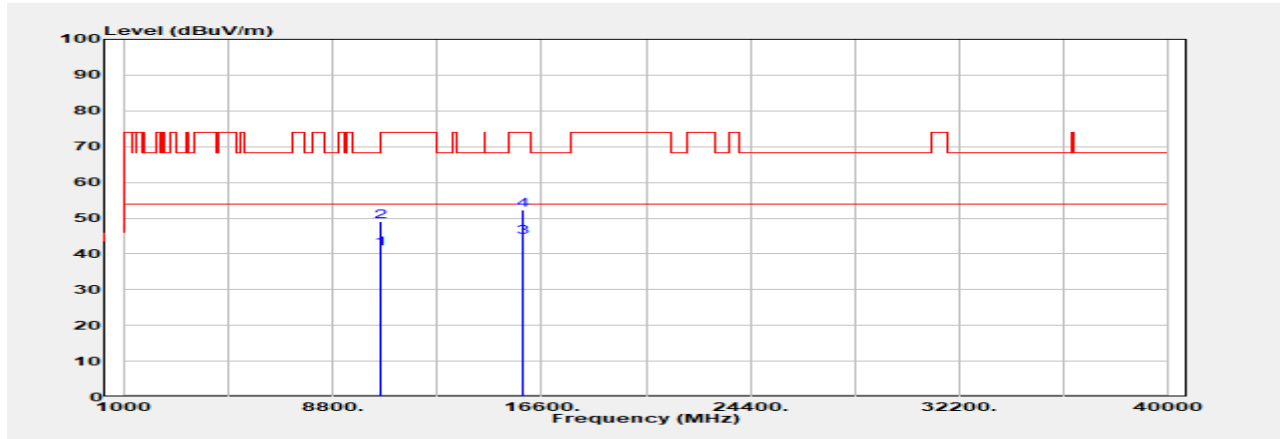

Freq. MHz	Detector Mode PK/QP/AVG	Spectrum Reading Level dB μ V	Factor dB	Actual FS dB μ V/m	Limit @3m dB μ V/m	Margin dB
10600.000	Average	31.43	10.00	41.43	54.00	-12.57
10600.000	Peak	39.11	10.00	49.11	74.00	-24.89
15900.000	Average	32.50	12.20	44.70	54.00	-9.30
15900.000	Peak	40.14	12.20	52.34	74.00	-21.66

Unless otherwise stated the results shown in this test report refer only to the sample(s) tested and such sample(s) are retained for 90 days only.

除非另有說明，此報告結果僅對測試之樣品負責，同時此樣品僅保留90天。本報告未經本公司書面許可，不可部份複製。

This document is issued by the Company subject to its General Conditions of Service printed overleaf, available on request or accessible at <http://www.sgs.com.tw/Terms-and-Conditions> and for electronic format documents, subject to Terms and Conditions for Electronic Documents at <http://www.sgs.com.tw/Terms-and-Conditions>. Attention is drawn to the limitation of liability, indemnification and jurisdiction issues defined therein. Any holder of this document is advised that information contained hereon reflects the Company's findings at the time of its intervention only and within the limits of Client's instructions, if any. The Company's sole responsibility is to its Client and this document does not exonerate parties to a transaction from exercising all their rights and obligations under the transaction documents. This document cannot be reproduced except in full, without prior written approval of the Company. Any unauthorized alteration, forgery or falsification of the content or appearance of this document is unlawful and offenders may be prosecuted to the fullest extent of the law.

Report Number :TERF2308001923E2
 Operation Mode :802.11n20
 Test Frequency :5300 MHz
 Test Mode :Tx
 EUT Pol :E2 Plane

Test Site :SAC G Chamber
 Test Date :2023-08-26
 Temp./Humi. :26.9°C/59%
 Antenna Pol. :Horizontal
 Engineer :Temo Chen

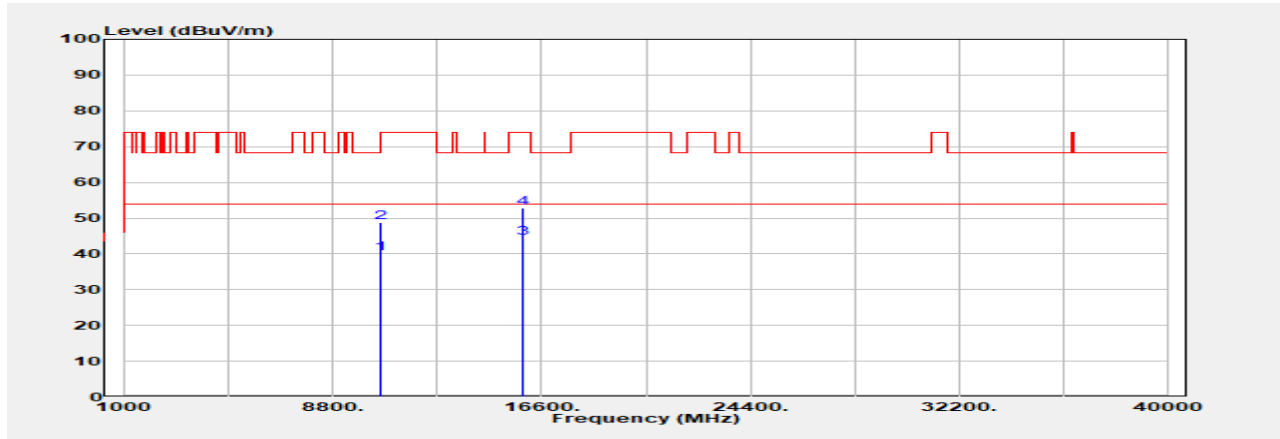

Freq. MHz	Detector Mode PK/QP/AVG	Spectrum Reading Level dB μ V	Factor dB	Actual FS dB μ V/m	Limit @3m dB μ V/m	Margin dB
10600.000	Average	30.12	10.00	40.12	54.00	-13.88
10600.000	Peak	38.66	10.00	48.66	74.00	-25.34
15900.000	Average	32.11	12.20	44.31	54.00	-9.69
15900.000	Peak	40.66	12.20	52.86	74.00	-21.14

Unless otherwise stated the results shown in this test report refer only to the sample(s) tested and such sample(s) are retained for 90 days only.

除非另有說明，此報告結果僅對測試之樣品負責，同時此樣品僅保留90天。本報告未經本公司書面許可，不可部份複製。

This document is issued by the Company subject to its General Conditions of Service printed overleaf, available on request or accessible at <http://www.sgs.com.tw/Terms-and-Conditions> and for electronic format documents, subject to Terms and Conditions for Electronic Documents at <http://www.sgs.com.tw/Terms-and-Conditions>. Attention is drawn to the limitation of liability, indemnification and jurisdiction issues defined therein. Any holder of this document is advised that information contained hereon reflects the Company's findings at the time of its intervention only and within the limits of Client's instructions, if any. The Company's sole responsibility is to its Client and this document does not exonerate parties to a transaction from exercising all their rights and obligations under the transaction documents. This document cannot be reproduced except in full, without prior written approval of the Company. Any unauthorized alteration, forgery or falsification of the content or appearance of this document is unlawful and offenders may be prosecuted to the fullest extent of the law.

Report Number :TERF2308001923E2
 Operation Mode :802.11n20
 Test Frequency :5320 MHz
 Test Mode :Tx
 EUT Pol :E2 Plane

Test Site :SAC G Chamber
 Test Date :2023-08-26
 Temp./Humi. :26.9°C/59%
 Antenna Pol. :Vertical
 Engineer :Temo Chen

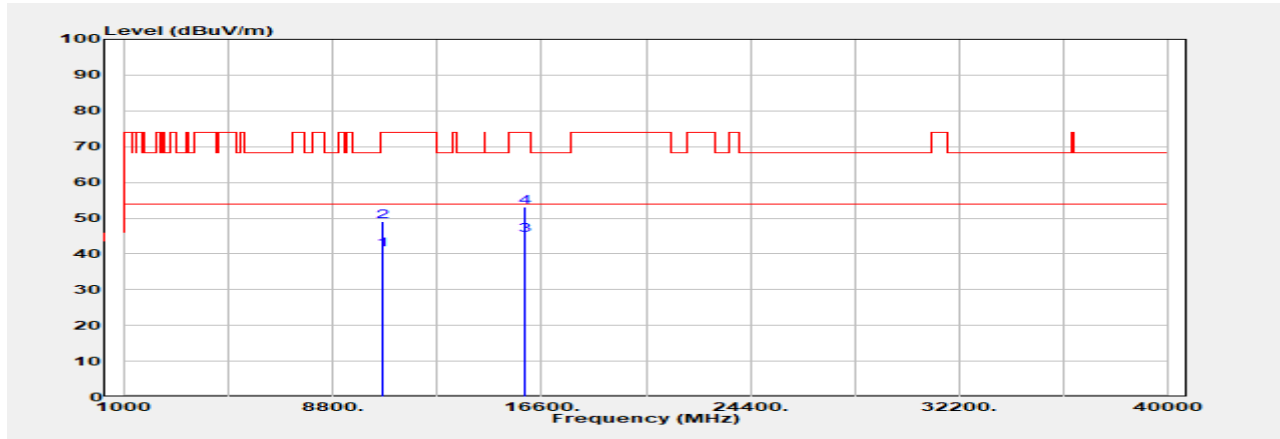

Freq. MHz	Detector Mode PK/QP/AVG	Spectrum Reading Level dB μ V	Factor dB	Actual FS dB μ V/m	Limit @3m dB μ V/m	Margin dB
10640.000	Average	31.46	9.72	41.18	54.00	-12.82
10640.000	Peak	39.32	9.72	49.04	74.00	-24.96
15960.000	Average	33.25	11.90	45.15	54.00	-8.85
15960.000	Peak	41.15	11.90	53.05	74.00	-20.95

Unless otherwise stated the results shown in this test report refer only to the sample(s) tested and such sample(s) are retained for 90 days only.

除非另有說明，此報告結果僅對測試之樣品負責，同時此樣品僅保留90天。本報告未經本公司書面許可，不可部份複製。

This document is issued by the Company subject to its General Conditions of Service printed overleaf, available on request or accessible at <http://www.sgs.com.tw/Terms-and-Conditions> and for electronic format documents, subject to Terms and Conditions for Electronic Documents at <http://www.sgs.com.tw/Terms-and-Conditions>. Attention is drawn to the limitation of liability, indemnification and jurisdiction issues defined therein. Any holder of this document is advised that information contained hereon reflects the Company's findings at the time of its intervention only and within the limits of Client's instructions, if any. The Company's sole responsibility is to its Client and this document does not exonerate parties to a transaction from exercising all their rights and obligations under the transaction documents. This document cannot be reproduced except in full, without prior written approval of the Company. Any unauthorized alteration, forgery or falsification of the content or appearance of this document is unlawful and offenders may be prosecuted to the fullest extent of the law.

Report Number :TERF2308001923E2
 Operation Mode :802.11n20
 Test Frequency :5320 MHz
 Test Mode :Tx
 EUT Pol :E2 Plane

Test Site :SAC G Chamber
 Test Date :2023-08-26
 Temp./Humi. :26.9°C/59%
 Antenna Pol. :Horizontal
 Engineer :Temo Chen

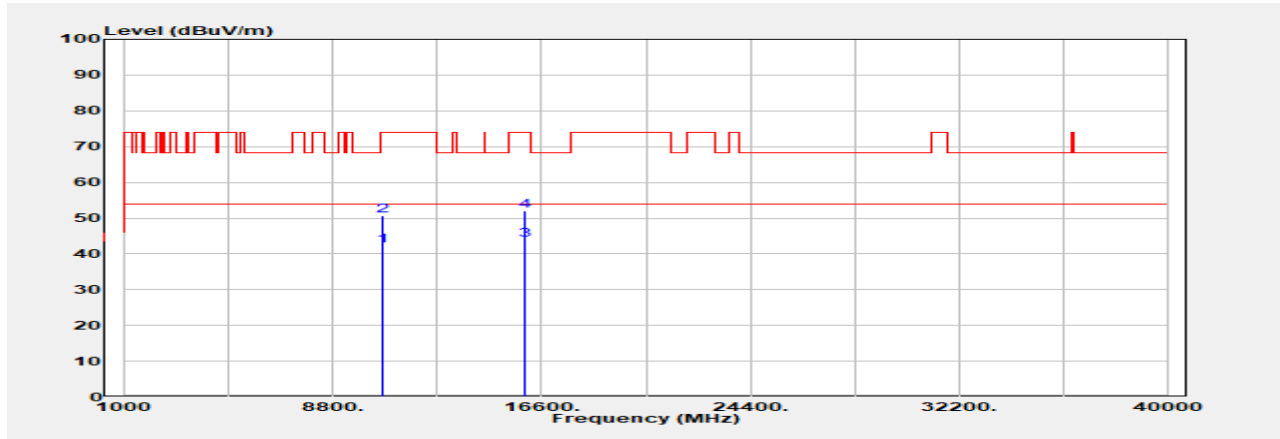

Freq. MHz	Detector Mode PK/QP/AVG	Spectrum Reading Level dB μ V	Factor dB	Actual FS dB μ V/m	Limit @3m dB μ V/m	Margin dB
10640.000	Average	32.57	9.72	42.29	54.00	-11.71
10640.000	Peak	40.84	9.72	50.56	74.00	-23.44
15960.000	Average	32.05	11.90	43.95	54.00	-10.05
15960.000	Peak	40.11	11.90	52.01	74.00	-21.99

Unless otherwise stated the results shown in this test report refer only to the sample(s) tested and such sample(s) are retained for 90 days only.

除非另有說明，此報告結果僅對測試之樣品負責，同時此樣品僅保留90天。本報告未經本公司書面許可，不可部份複製。

This document is issued by the Company subject to its General Conditions of Service printed overleaf, available on request or accessible at <http://www.sgs.com.tw/Terms-and-Conditions> and for electronic format documents, subject to Terms and Conditions for Electronic Documents at <http://www.sgs.com.tw/Terms-and-Conditions>. Attention is drawn to the limitation of liability, indemnification and jurisdiction issues defined therein. Any holder of this document is advised that information contained hereon reflects the Company's findings at the time of its intervention only and within the limits of Client's instructions, if any. The Company's sole responsibility is to its Client and this document does not exonerate parties to a transaction from exercising all their rights and obligations under the transaction documents. This document cannot be reproduced except in full, without prior written approval of the Company. Any unauthorized alteration, forgery or falsification of the content or appearance of this document is unlawful and offenders may be prosecuted to the fullest extent of the law.

Report Number :TERF2308001923E2
 Operation Mode :802.11n20
 Test Frequency :5500 MHz
 Test Mode :Tx
 EUT Pol :E2 Plane

Test Site :SAC G Chamber
 Test Date :2023-08-26
 Temp./Humi. :26.9°C/59%
 Antenna Pol. :Vertical
 Engineer :Temo Chen

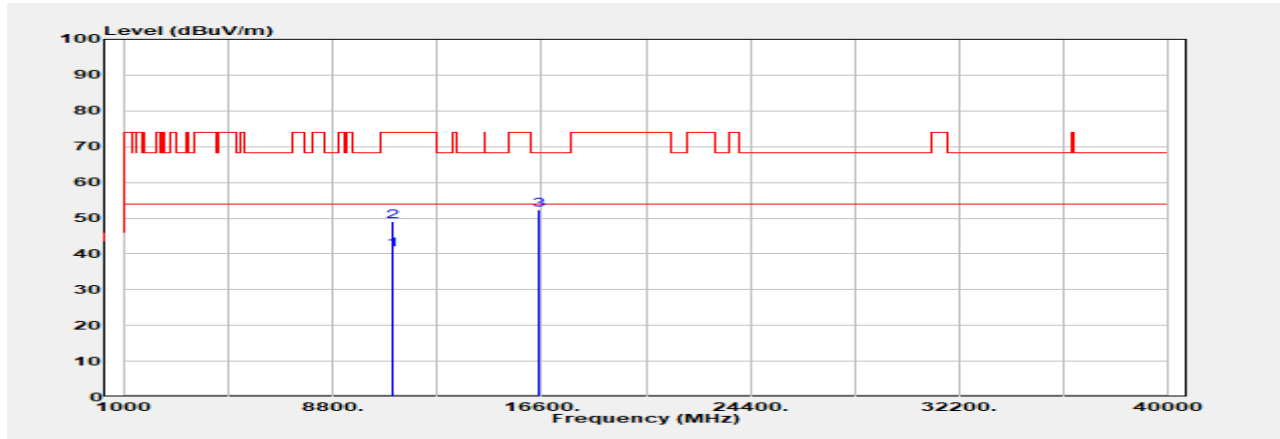

Freq. MHz	Detector Mode PK/QP/AVG	Spectrum Reading Level dB μ V	Factor dB	Actual FS dB μ V/m	Limit @3m dB μ V/m	Margin dB
11000.000	Average	29.34	11.90	41.24	54.00	-12.76
11000.000	Peak	37.16	11.90	49.06	74.00	-24.94
16500.000	Peak	40.29	12.00	52.29	68.20	-15.91

Unless otherwise stated the results shown in this test report refer only to the sample(s) tested and such sample(s) are retained for 90 days only.

除非另有說明，此報告結果僅對測試之樣品負責，同時此樣品僅保留90天。本報告未經本公司書面許可，不可部份複製。

This document is issued by the Company subject to its General Conditions of Service printed overleaf, available on request or accessible at <http://www.sgs.com.tw/Terms-and-Conditions> and for electronic format documents, subject to Terms and Conditions for Electronic Documents at <http://www.sgs.com.tw/Terms-and-Conditions>. Attention is drawn to the limitation of liability, indemnification and jurisdiction issues defined therein. Any holder of this document is advised that information contained hereon reflects the Company's findings at the time of its intervention only and within the limits of Client's instructions, if any. The Company's sole responsibility is to its Client and this document does not exonerate parties to a transaction from exercising all their rights and obligations under the transaction documents. This document cannot be reproduced except in full, without prior written approval of the Company. Any unauthorized alteration, forgery or falsification of the content or appearance of this document is unlawful and offenders may be prosecuted to the fullest extent of the law.

Report Number :TERF2308001923E2

Test Site :SAC G Chamber

Operation Mode :802.11n20

Test Date :2023-08-26

Test Frequency :5500 MHz

Temp./Humi. :26.9°C/59%

Test Mode :Tx

Antenna Pol. :Horizontal

EUT Pol :E2 Plane

Engineer :Temo Chen

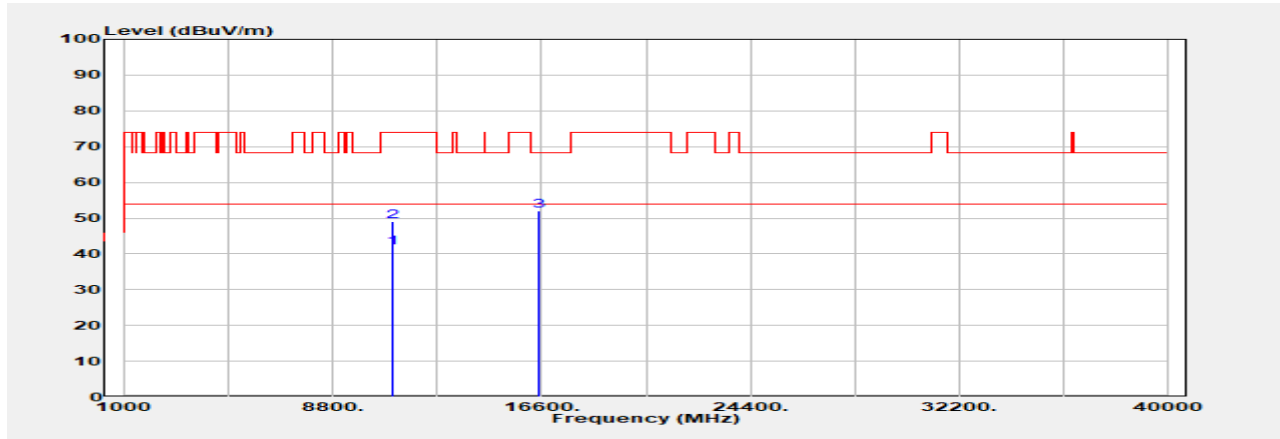

Freq. MHz	Detector Mode PK/QP/AVG	Spectrum Reading Level dBμV	Factor dB	Actual FS dBμV/m	Limit @3m dBμV/m	Margin dB
11000.000	Average	29.85	11.90	41.75	54.00	-12.25
11000.000	Peak	37.16	11.90	49.06	74.00	-24.94
16500.000	Peak	40.05	12.00	52.05	68.20	-16.15

Unless otherwise stated the results shown in this test report refer only to the sample(s) tested and such sample(s) are retained for 90 days only.

除非另有說明，此報告結果僅對測試之樣品負責，同時此樣品僅保留90天。本報告未經本公司書面許可，不可部份複製。

This document is issued by the Company subject to its General Conditions of Service printed overleaf, available on request or accessible at <http://www.sgs.com.tw/Terms-and-Conditions> and for electronic format documents, subject to Terms and Conditions for Electronic Documents at <http://www.sgs.com.tw/Terms-and-Conditions>. Attention is drawn to the limitation of liability, indemnification and jurisdiction issues defined therein. Any holder of this document is advised that information contained hereon reflects the Company's findings at the time of its intervention only and within the limits of Client's instructions, if any. The Company's sole responsibility is to its Client and this document does not exonerate parties to a transaction from exercising all their rights and obligations under the transaction documents. This document cannot be reproduced except in full, without prior written approval of the Company. Any unauthorized alteration, forgery or falsification of the content or appearance of this document is unlawful and offenders may be prosecuted to the fullest extent of the law.

Report Number :TERF2308001923E2
 Operation Mode :802.11n20
 Test Frequency :5580 MHz
 Test Mode :Tx
 EUT Pol :E2 Plane

Test Site :SAC G Chamber
 Test Date :2023-08-26
 Temp./Humi. :26.9°C/59%
 Antenna Pol. :Vertical
 Engineer :Temo Chen

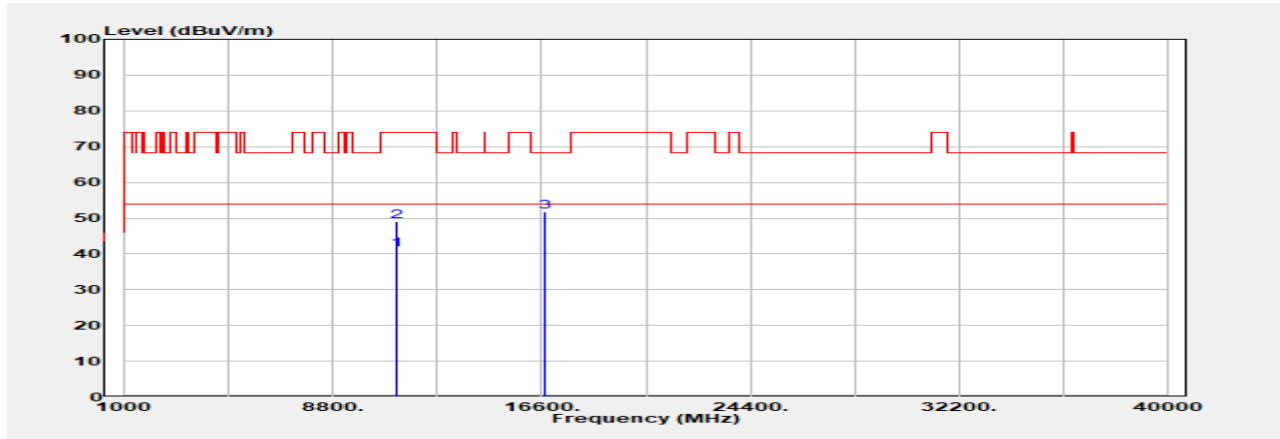

Freq. MHz	Detector Mode PK/QP/AVG	Spectrum Reading Level dBμV	Factor dB	Actual FS dBμV/m	Limit @3m dBμV/m	Margin dB
11160.000	Average	31.25	9.88	41.13	54.00	-12.87
11160.000	Peak	39.14	9.88	49.02	74.00	-24.98
16740.000	Peak	40.21	11.66	51.87	68.20	-16.33

Unless otherwise stated the results shown in this test report refer only to the sample(s) tested and such sample(s) are retained for 90 days only.

除非另有說明，此報告結果僅對測試之樣品負責，同時此樣品僅保留90天。本報告未經本公司書面許可，不可部份複製。

This document is issued by the Company subject to its General Conditions of Service printed overleaf, available on request or accessible at <http://www.sgs.com.tw/Terms-and-Conditions> and for electronic format documents, subject to Terms and Conditions for Electronic Documents at <http://www.sgs.com.tw/Terms-and-Conditions>. Attention is drawn to the limitation of liability, indemnification and jurisdiction issues defined therein. Any holder of this document is advised that information contained hereon reflects the Company's findings at the time of its intervention only and within the limits of Client's instructions, if any. The Company's sole responsibility is to its Client and this document does not exonerate parties to a transaction from exercising all their rights and obligations under the transaction documents. This document cannot be reproduced except in full, without prior written approval of the Company. Any unauthorized alteration, forgery or falsification of the content or appearance of this document is unlawful and offenders may be prosecuted to the fullest extent of the law.

Report Number :TERF2308001923E2
 Operation Mode :802.11n20
 Test Frequency :5580 MHz
 Test Mode :Tx
 EUT Pol :E2 Plane

Test Site :SAC G Chamber
 Test Date :2023-08-26
 Temp./Humi. :26.9°C/59%
 Antenna Pol. :Horizontal
 Engineer :Temo Chen

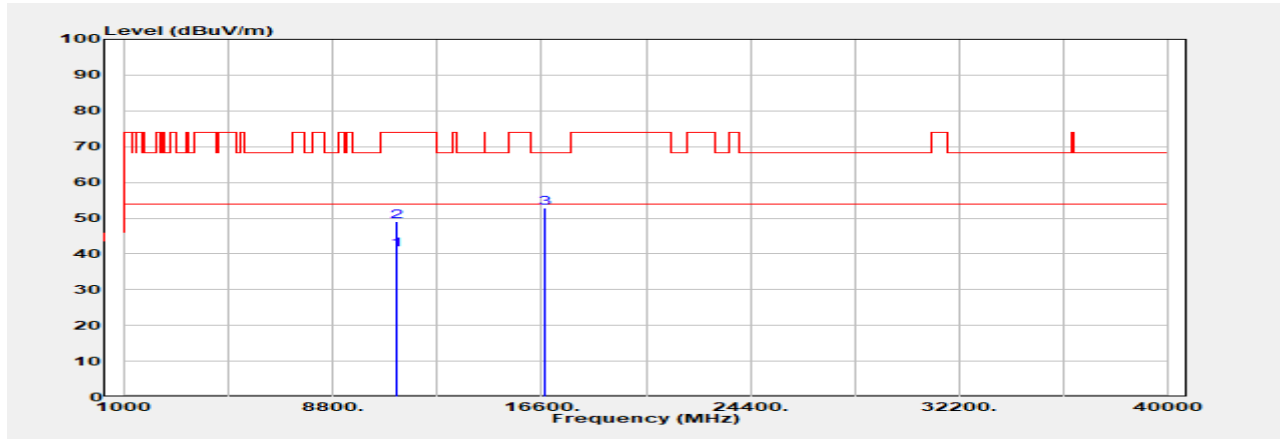

Freq. MHz	Detector Mode PK/QP/AVG	Spectrum Reading Level dBμV	Factor dB	Actual FS dBμV/m	Limit @3m dBμV/m	Margin dB
11160.000	Average	31.20	9.88	41.08	54.00	-12.92
11160.000	Peak	39.09	9.88	48.97	74.00	-25.03
16740.000	Peak	41.27	11.66	52.93	68.20	-15.27

Unless otherwise stated the results shown in this test report refer only to the sample(s) tested and such sample(s) are retained for 90 days only.

除非另有說明，此報告結果僅對測試之樣品負責，同時此樣品僅保留90天。本報告未經本公司書面許可，不可部份複製。

This document is issued by the Company subject to its General Conditions of Service printed overleaf, available on request or accessible at <http://www.sgs.com.tw/Terms-and-Conditions> and for electronic format documents, subject to Terms and Conditions for Electronic Documents at <http://www.sgs.com.tw/Terms-and-Conditions>. Attention is drawn to the limitation of liability, indemnification and jurisdiction issues defined therein. Any holder of this document is advised that information contained hereon reflects the Company's findings at the time of its intervention only and within the limits of Client's instructions, if any. The Company's sole responsibility is to its Client and this document does not exonerate parties to a transaction from exercising all their rights and obligations under the transaction documents. This document cannot be reproduced except in full, without prior written approval of the Company. Any unauthorized alteration, forgery or falsification of the content or appearance of this document is unlawful and offenders may be prosecuted to the fullest extent of the law.

Report Number :TERF2308001923E2

Test Site :SAC G Chamber

Operation Mode :802.11n20

Test Date :2023-08-26

Test Frequency :5700 MHz

Temp./Humi. :26.9°C/59%

Test Mode :Tx

Antenna Pol. :Vertical

EUT Pol :E2 Plane

Engineer :Temo Chen

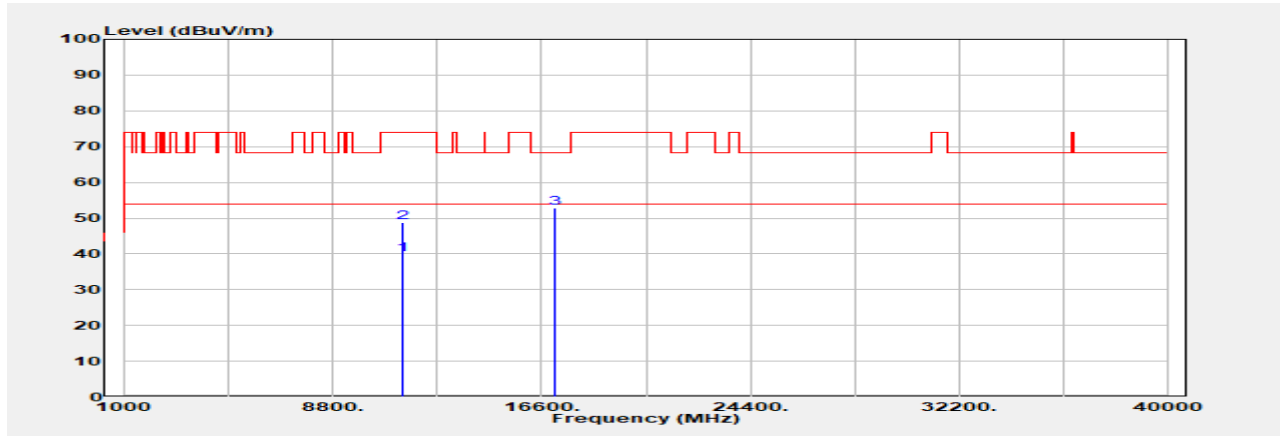

Freq. MHz	Detector Mode PK/QP/AVG	Spectrum Reading Level dB μ V	Factor dB	Actual FS dB μ V/m	Limit @3m dB μ V/m	Margin dB
11400.000	Average	30.12	9.80	39.92	54.00	-14.08
11400.000	Peak	38.95	9.80	48.75	74.00	-25.25
17100.000	Peak	40.57	12.20	52.77	68.20	-15.43

Unless otherwise stated the results shown in this test report refer only to the sample(s) tested and such sample(s) are retained for 90 days only.

除非另有說明，此報告結果僅對測試之樣品負責，同時此樣品僅保留90天。本報告未經本公司書面許可，不可部份複製。

This document is issued by the Company subject to its General Conditions of Service printed overleaf, available on request or accessible at <http://www.sgs.com.tw/Terms-and-Conditions> and for electronic format documents, subject to Terms and Conditions for Electronic Documents at <http://www.sgs.com.tw/Terms-and-Conditions>. Attention is drawn to the limitation of liability, indemnification and jurisdiction issues defined therein. Any holder of this document is advised that information contained hereon reflects the Company's findings at the time of its intervention only and within the limits of Client's instructions, if any. The Company's sole responsibility is to its Client and this document does not exonerate parties to a transaction from exercising all their rights and obligations under the transaction documents. This document cannot be reproduced except in full, without prior written approval of the Company. Any unauthorized alteration, forgery or falsification of the content or appearance of this document is unlawful and offenders may be prosecuted to the fullest extent of the law.

Report Number :TERF2308001923E2

Test Site :SAC G Chamber

Operation Mode :802.11n20

Test Date :2023-08-26

Test Frequency :5700 MHz

Temp./Humi. :26.9°C/59%

Test Mode :Tx

Antenna Pol. :Horizontal

EUT Pol :E2 Plane

Engineer :Temo Chen

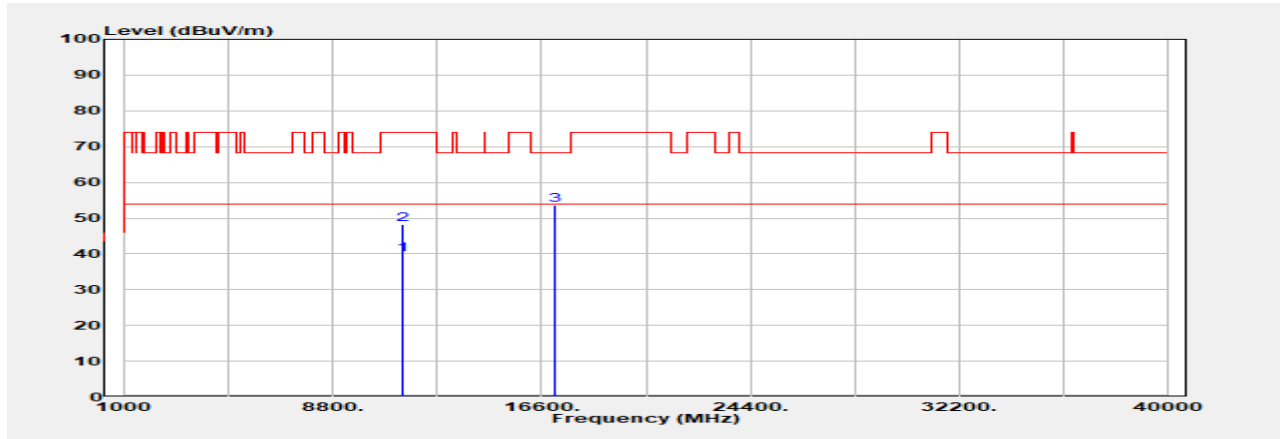

Freq. MHz	Detector Mode PK/QP/AVG	Spectrum Reading Level dB μ V	Factor dB	Actual FS dB μ V/m	Limit @3m dB μ V/m	Margin dB
11400.000	Average	30.02	9.80	39.82	54.00	-14.18
11400.000	Peak	38.56	9.80	48.36	74.00	-25.64
17100.000	Peak	41.45	12.20	53.65	68.20	-14.55

Unless otherwise stated the results shown in this test report refer only to the sample(s) tested and such sample(s) are retained for 90 days only.

除非另有說明，此報告結果僅對測試之樣品負責，同時此樣品僅保留90天。本報告未經本公司書面許可，不可部份複製。

This document is issued by the Company subject to its General Conditions of Service printed overleaf, available on request or accessible at <http://www.sgs.com.tw/Terms-and-Conditions> and for electronic format documents, subject to Terms and Conditions for Electronic Documents at <http://www.sgs.com.tw/Terms-and-Conditions>. Attention is drawn to the limitation of liability, indemnification and jurisdiction issues defined therein. Any holder of this document is advised that information contained hereon reflects the Company's findings at the time of its intervention only and within the limits of Client's instructions, if any. The Company's sole responsibility is to its Client and this document does not exonerate parties to a transaction from exercising all their rights and obligations under the transaction documents. This document cannot be reproduced except in full, without prior written approval of the Company. Any unauthorized alteration, forgery or falsification of the content or appearance of this document is unlawful and offenders may be prosecuted to the fullest extent of the law.

Report Number :TERF2308001923E2

Test Site :SAC G Chamber

Operation Mode :802.11n20

Test Date :2023-08-26

Test Frequency :5745 MHz

Temp./Humi. :26.9°C/59%

Test Mode :Tx

Antenna Pol. :Vertical

EUT Pol :E2 Plane

Engineer :Temo Chen

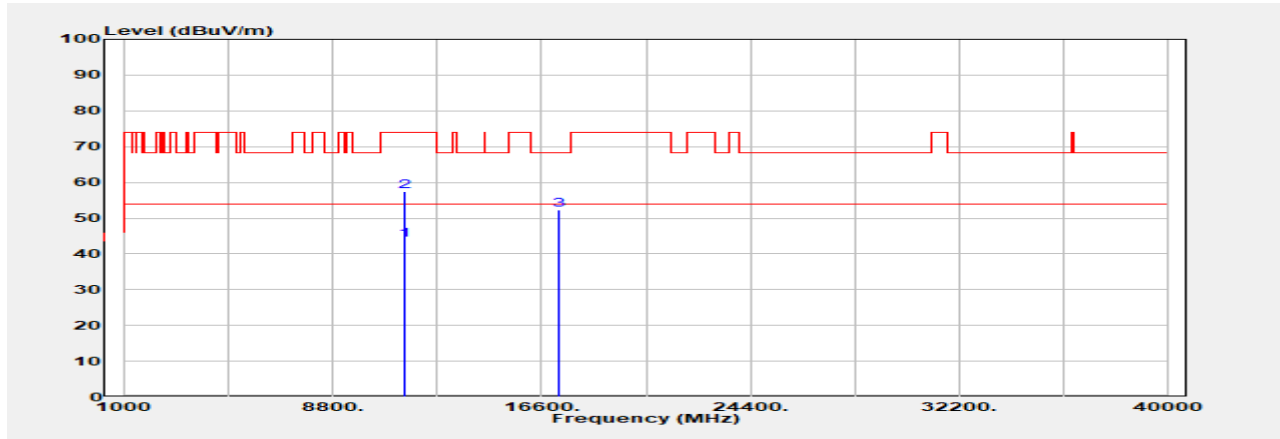

Freq. MHz	Detector Mode PK/QP/AVG	Spectrum Reading Level dBUV	Factor dB	Actual FS dBUV/m	Limit @3m dBUV/m	Margin dB
11490.000	Average	32.84	11.06	43.90	54.00	-10.10
11490.000	Peak	46.29	11.06	57.35	74.00	-16.65
17235.000	Peak	41.58	10.82	52.40	68.20	-15.80

Unless otherwise stated the results shown in this test report refer only to the sample(s) tested and such sample(s) are retained for 90 days only.

除非另有說明，此報告結果僅對測試之樣品負責，同時此樣品僅保留90天。本報告未經本公司書面許可，不可部份複製。

This document is issued by the Company subject to its General Conditions of Service printed overleaf, available on request or accessible at <http://www.sgs.com.tw/Terms-and-Conditions> and for electronic format documents, subject to Terms and Conditions for Electronic Documents at <http://www.sgs.com.tw/Terms-and-Conditions>. Attention is drawn to the limitation of liability, indemnification and jurisdiction issues defined therein. Any holder of this document is advised that information contained hereon reflects the Company's findings at the time of its intervention only and within the limits of Client's instructions, if any. The Company's sole responsibility is to its Client and this document does not exonerate parties to a transaction from exercising all their rights and obligations under the transaction documents. This document cannot be reproduced except in full, without prior written approval of the Company. Any unauthorized alteration, forgery or falsification of the content or appearance of this document is unlawful and offenders may be prosecuted to the fullest extent of the law.

Report Number :TERF2308001923E2

Test Site :SAC G Chamber

Operation Mode :802.11n20

Test Date :2023-08-26

Test Frequency :5745 MHz

Temp./Humi. :26.9°C/59%

Test Mode :Tx

Antenna Pol. :Horizontal

EUT Pol :E2 Plane

Engineer :Temo Chen

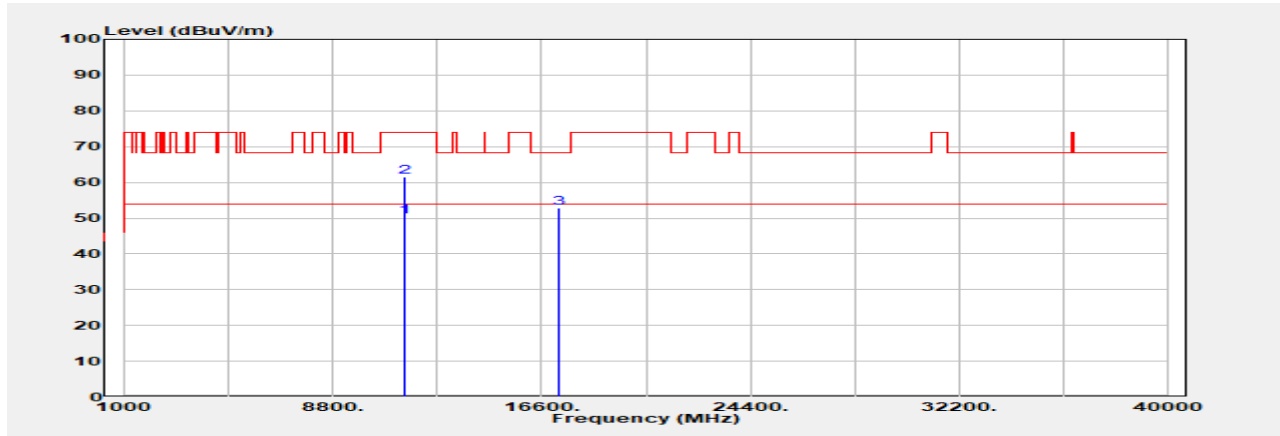

Freq. MHz	Detector Mode PK/QP/AVG	Spectrum Reading Level dB μ V	Factor dB	Actual FS dB μ V/m	Limit @3m dB μ V/m	Margin dB
11490.000	Average	39.33	11.06	50.39	54.00	-3.61
11490.000	Peak	50.57	11.06	61.63	74.00	-12.37
17235.000	Peak	41.92	10.82	52.74	68.20	-15.46

Unless otherwise stated the results shown in this test report refer only to the sample(s) tested and such sample(s) are retained for 90 days only.

除非另有說明，此報告結果僅對測試之樣品負責，同時此樣品僅保留90天。本報告未經本公司書面許可，不可部份複製。

This document is issued by the Company subject to its General Conditions of Service printed overleaf, available on request or accessible at <http://www.sgs.com.tw/Terms-and-Conditions> and for electronic format documents, subject to Terms and Conditions for Electronic Documents at <http://www.sgs.com.tw/Terms-and-Conditions>. Attention is drawn to the limitation of liability, indemnification and jurisdiction issues defined therein. Any holder of this document is advised that information contained hereon reflects the Company's findings at the time of its intervention only and within the limits of Client's instructions, if any. The Company's sole responsibility is to its Client and this document does not exonerate parties to a transaction from exercising all their rights and obligations under the transaction documents. This document cannot be reproduced except in full, without prior written approval of the Company. Any unauthorized alteration, forgery or falsification of the content or appearance of this document is unlawful and offenders may be prosecuted to the fullest extent of the law.

Report Number :TERF2308001923E2

Test Site :SAC G Chamber

Operation Mode :802.11n20

Test Date :2023-10-19

Test Frequency :5785 MHz

Temp./Humi. :22.3°C/60%

Test Mode :Tx

Antenna Pol. :Vertical

EUT Pol :E2 Plane

Engineer :Temo Chen

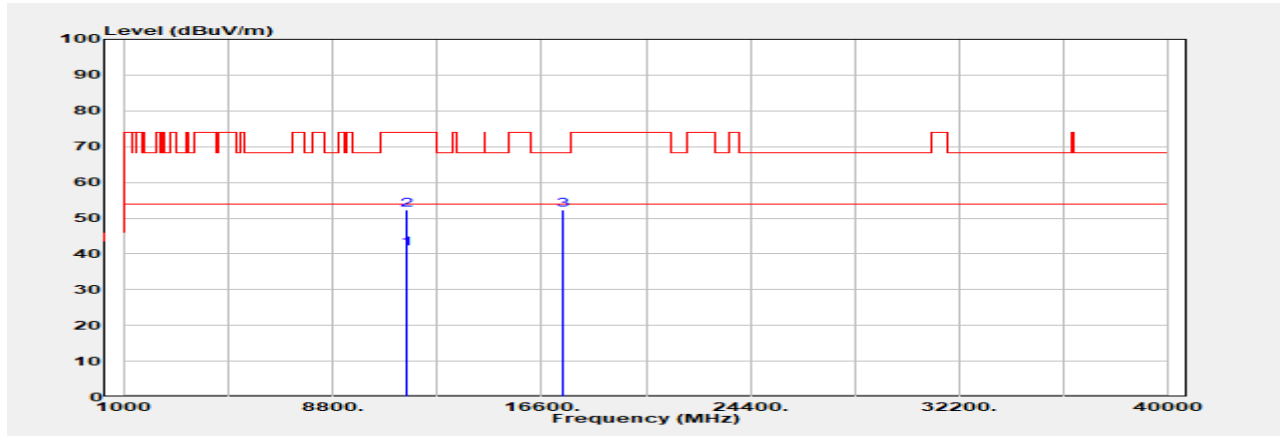

Freq. MHz	Detector Mode PK/QP/AVG	Spectrum Reading Level dB μ V	Factor dB	Actual FS dB μ V/m	Limit @3m dB μ V/m	Margin dB
11570.000	Average	31.28	10.15	41.43	54.00	-12.57
11570.000	Peak	42.11	10.15	52.26	74.00	-21.74
17355.000	Peak	40.54	11.82	52.36	68.20	-15.84

Unless otherwise stated the results shown in this test report refer only to the sample(s) tested and such sample(s) are retained for 90 days only.

除非另有說明，此報告結果僅對測試之樣品負責，同時此樣品僅保留90天。本報告未經本公司書面許可，不可部份複製。

This document is issued by the Company subject to its General Conditions of Service printed overleaf, available on request or accessible at <http://www.sgs.com.tw/Terms-and-Conditions> and for electronic format documents, subject to Terms and Conditions for Electronic Documents at <http://www.sgs.com.tw/Terms-and-Conditions>. Attention is drawn to the limitation of liability, indemnification and jurisdiction issues defined therein. Any holder of this document is advised that information contained hereon reflects the Company's findings at the time of its intervention only and within the limits of Client's instructions, if any. The Company's sole responsibility is to its Client and this document does not exonerate parties to a transaction from exercising all their rights and obligations under the transaction documents. This document cannot be reproduced except in full, without prior written approval of the Company. Any unauthorized alteration, forgery or falsification of the content or appearance of this document is unlawful and offenders may be prosecuted to the fullest extent of the law.

Report Number :TERF2308001923E2

Test Site :SAC G Chamber

Operation Mode :802.11n20

Test Date :2023-10-19

Test Frequency :5785 MHz

Temp./Humi. :22.3°C/60%

Test Mode :Tx

Antenna Pol. :Horizontal

EUT Pol :E2 Plane

Engineer :Temo Chen

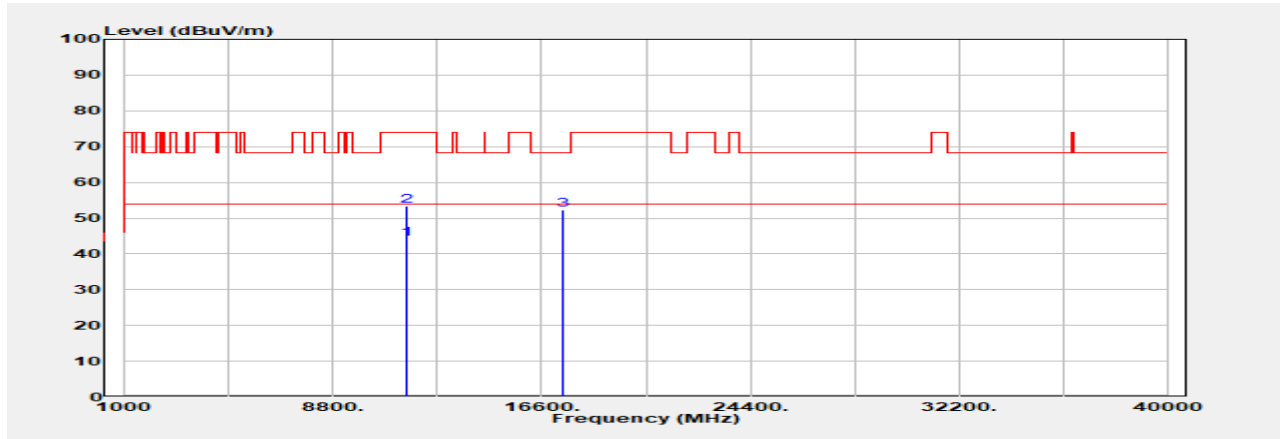

Freq. MHz	Detector Mode PK/QP/AVG	Spectrum Reading Level dBUV	Factor dB	Actual FS dBUV/m	Limit @3m dBUV/m	Margin dB
11570.000	Average	34.03	10.15	44.17	54.00	-9.83
11570.000	Peak	43.12	10.15	53.27	74.00	-20.73
17355.000	Peak	40.58	11.82	52.40	68.20	-15.80

Unless otherwise stated the results shown in this test report refer only to the sample(s) tested and such sample(s) are retained for 90 days only.

除非另有說明，此報告結果僅對測試之樣品負責，同時此樣品僅保留90天。本報告未經本公司書面許可，不可部份複製。

This document is issued by the Company subject to its General Conditions of Service printed overleaf, available on request or accessible at <http://www.sgs.com.tw/Terms-and-Conditions> and for electronic format documents, subject to Terms and Conditions for Electronic Documents at <http://www.sgs.com.tw/Terms-and-Conditions>. Attention is drawn to the limitation of liability, indemnification and jurisdiction issues defined therein. Any holder of this document is advised that information contained hereon reflects the Company's findings at the time of its intervention only and within the limits of Client's instructions, if any. The Company's sole responsibility is to its Client and this document does not exonerate parties to a transaction from exercising all their rights and obligations under the transaction documents. This document cannot be reproduced except in full, without prior written approval of the Company. Any unauthorized alteration, forgery or falsification of the content or appearance of this document is unlawful and offenders may be prosecuted to the fullest extent of the law.

Report Number :TERF2308001923E2

Test Site :SAC G Chamber

Operation Mode :802.11n20

Test Date :2023-10-19

Test Frequency :5825 MHz

Temp./Humi. :22.3°C/60%

Test Mode :Tx

Antenna Pol. :Vertical

EUT Pol :E2 Plane

Engineer :Temo Chen

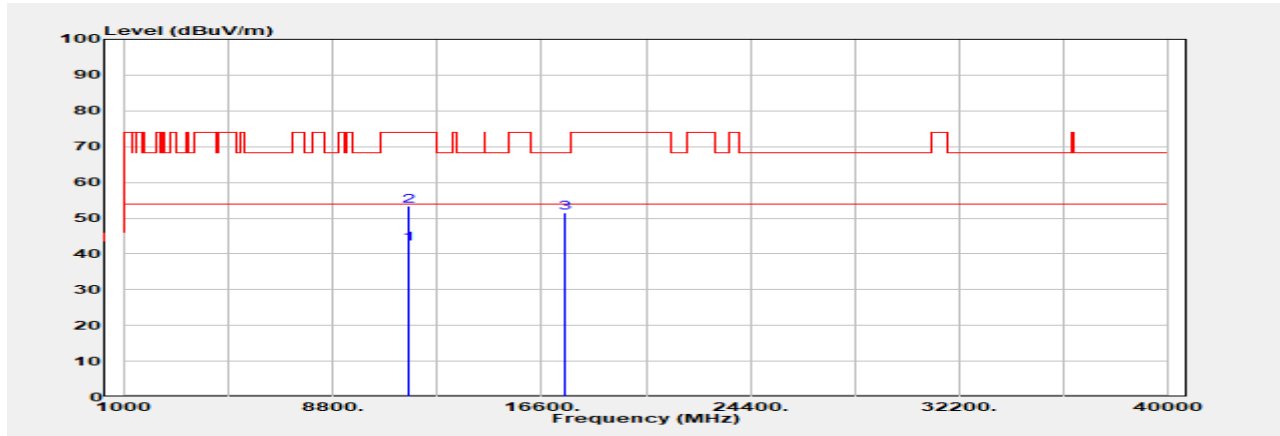

Freq. MHz	Detector Mode PK/QP/AVG	Spectrum Reading Level dBμV	Factor dB	Actual FS dBμV/m	Limit @3m dBμV/m	Margin dB
11650.000	Average	32.63	10.05	42.68	54.00	-11.32
11650.000	Peak	43.21	10.05	53.26	74.00	-20.74
17475.000	Peak	40.46	11.10	51.56	68.20	-16.64

Unless otherwise stated the results shown in this test report refer only to the sample(s) tested and such sample(s) are retained for 90 days only.

除非另有說明，此報告結果僅對測試之樣品負責，同時此樣品僅保留90天。本報告未經本公司書面許可，不可部份複製。

This document is issued by the Company subject to its General Conditions of Service printed overleaf, available on request or accessible at <http://www.sgs.com.tw/Terms-and-Conditions> and for electronic format documents, subject to Terms and Conditions for Electronic Documents at <http://www.sgs.com.tw/Terms-and-Conditions>. Attention is drawn to the limitation of liability, indemnification and jurisdiction issues defined therein. Any holder of this document is advised that information contained hereon reflects the Company's findings at the time of its intervention only and within the limits of Client's instructions, if any. The Company's sole responsibility is to its Client and this document does not exonerate parties to a transaction from exercising all their rights and obligations under the transaction documents. This document cannot be reproduced except in full, without prior written approval of the Company. Any unauthorized alteration, forgery or falsification of the content or appearance of this document is unlawful and offenders may be prosecuted to the fullest extent of the law.

Report Number :TERF2308001923E2

Test Site :SAC G Chamber

Operation Mode :802.11n20

Test Date :2023-10-19

Test Frequency :5825 MHz

Temp./Humi. :22.3°C/60%

Test Mode :Tx

Antenna Pol. :Horizontal

EUT Pol :E2 Plane

Engineer :Temo Chen

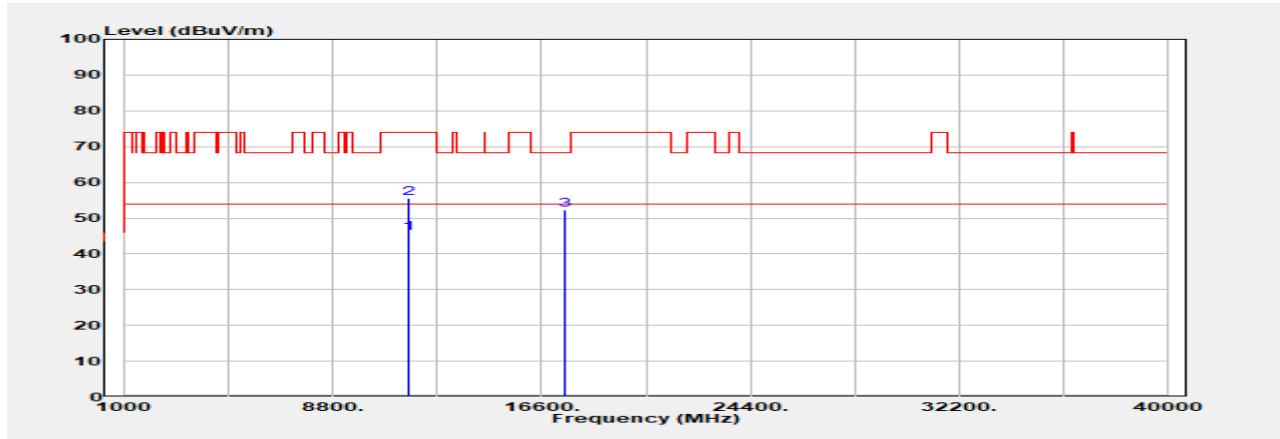

Freq. MHz	Detector Mode PK/QP/AVG	Spectrum Reading Level dBUV	Factor dB	Actual FS dBUV/m	Limit @3m dBUV/m	Margin dB
11650.000	Average	35.76	10.05	45.81	54.00	-8.19
11650.000	Peak	45.40	10.05	55.45	74.00	-18.55
17475.000	Peak	41.24	11.10	52.34	68.20	-15.86

Unless otherwise stated the results shown in this test report refer only to the sample(s) tested and such sample(s) are retained for 90 days only.

除非另有說明，此報告結果僅對測試之樣品負責，同時此樣品僅保留90天。本報告未經本公司書面許可，不可部份複製。

This document is issued by the Company subject to its General Conditions of Service printed overleaf, available on request or accessible at <http://www.sgs.com.tw/Terms-and-Conditions> and for electronic format documents, subject to Terms and Conditions for Electronic Documents at <http://www.sgs.com.tw/Terms-and-Conditions>. Attention is drawn to the limitation of liability, indemnification and jurisdiction issues defined therein. Any holder of this document is advised that information contained hereon reflects the Company's findings at the time of its intervention only and within the limits of Client's instructions, if any. The Company's sole responsibility is to its Client and this document does not exonerate parties to a transaction from exercising all their rights and obligations under the transaction documents. This document cannot be reproduced except in full, without prior written approval of the Company. Any unauthorized alteration, forgery or falsification of the content or appearance of this document is unlawful and offenders may be prosecuted to the fullest extent of the law.

Report Number :TERF2308001923E2
 Operation Mode :802.11n40
 Test Frequency :5190 MHz
 Test Mode :Tx
 EUT Pol :E2 Plane

Test Site :SAC G Chamber
 Test Date :2023-10-19
 Temp./Humi. :22.3°C/60%
 Antenna Pol. :Vertical
 Engineer :Temo Chen

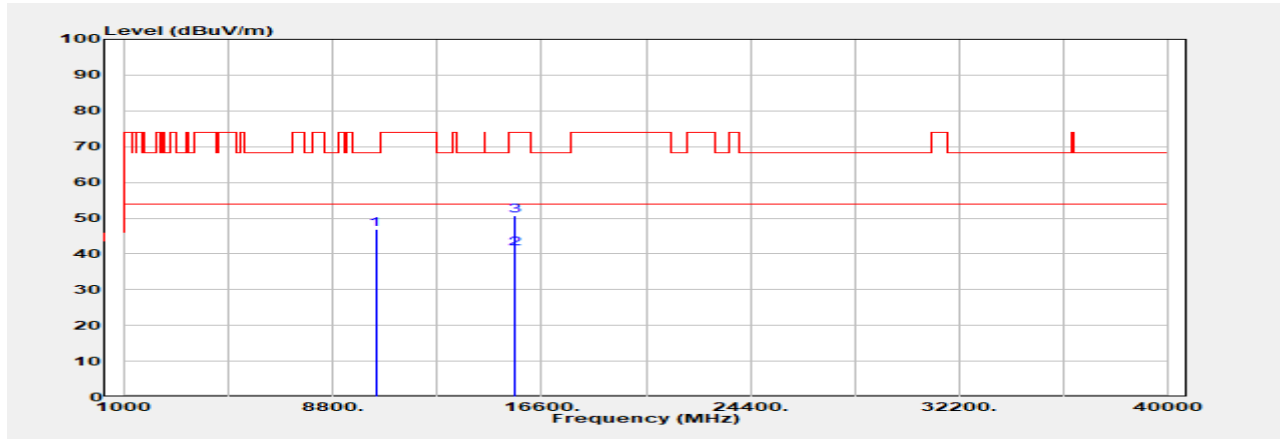

Freq. MHz	Detector Mode PK/QP/AVG	Spectrum Reading Level dB μ V	Factor dB	Actual FS dB μ V/m	Limit @3m dB μ V/m	Margin dB
10380.000	Peak	37.57	9.44	47.01	68.20	-21.19
15570.000	Average	29.41	11.93	41.34	54.00	-12.66
15570.000	Peak	38.75	11.93	50.68	74.00	-23.32

Unless otherwise stated the results shown in this test report refer only to the sample(s) tested and such sample(s) are retained for 90 days only.

除非另有說明，此報告結果僅對測試之樣品負責，同時此樣品僅保留90天。本報告未經本公司書面許可，不可部份複製。

This document is issued by the Company subject to its General Conditions of Service printed overleaf, available on request or accessible at <http://www.sgs.com.tw/Terms-and-Conditions> and for electronic format documents, subject to Terms and Conditions for Electronic Documents at <http://www.sgs.com.tw/Terms-and-Conditions>. Attention is drawn to the limitation of liability, indemnification and jurisdiction issues defined therein. Any holder of this document is advised that information contained hereon reflects the Company's findings at the time of its intervention only and within the limits of Client's instructions, if any. The Company's sole responsibility is to its Client and this document does not exonerate parties to a transaction from exercising all their rights and obligations under the transaction documents. This document cannot be reproduced except in full, without prior written approval of the Company. Any unauthorized alteration, forgery or falsification of the content or appearance of this document is unlawful and offenders may be prosecuted to the fullest extent of the law.

Report Number :TERF2308001923E2
 Operation Mode :802.11n40
 Test Frequency :5190 MHz
 Test Mode :Tx
 EUT Pol :E2 Plane

Test Site :SAC G Chamber
 Test Date :2023-10-19
 Temp./Humi. :22.3°C/60%
 Antenna Pol. :Horizontal
 Engineer :Temo Chen

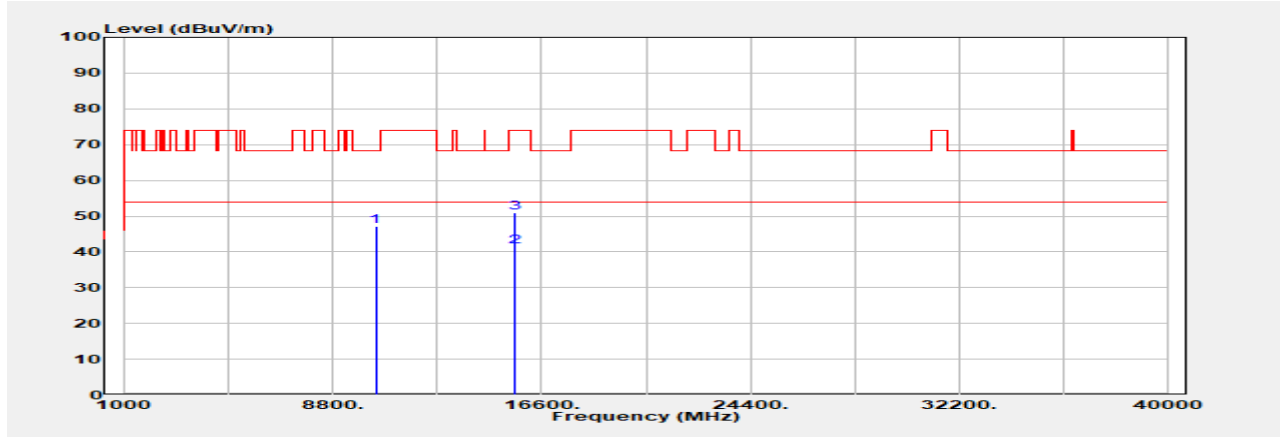

Freq. MHz	Detector Mode PK/QP/AVG	Spectrum Reading Level dB μ V	Factor dB	Actual FS dB μ V/m	Limit @3m dB μ V/m	Margin dB
10380.000	Peak	37.70	9.44	47.14	68.20	-21.06
15570.000	Average	29.47	11.93	41.40	54.00	-12.60
15570.000	Peak	39.06	11.93	50.99	74.00	-23.01

Unless otherwise stated the results shown in this test report refer only to the sample(s) tested and such sample(s) are retained for 90 days only.

除非另有說明，此報告結果僅對測試之樣品負責，同時此樣品僅保留90天。本報告未經本公司書面許可，不可部份複製。

This document is issued by the Company subject to its General Conditions of Service printed overleaf, available on request or accessible at <http://www.sgs.com.tw/Terms-and-Conditions> and for electronic format documents, subject to Terms and Conditions for Electronic Documents at <http://www.sgs.com.tw/Terms-and-Conditions>. Attention is drawn to the limitation of liability, indemnification and jurisdiction issues defined therein. Any holder of this document is advised that information contained hereon reflects the Company's findings at the time of its intervention only and within the limits of Client's instructions, if any. The Company's sole responsibility is to its Client and this document does not exonerate parties to a transaction from exercising all their rights and obligations under the transaction documents. This document cannot be reproduced except in full, without prior written approval of the Company. Any unauthorized alteration, forgery or falsification of the content or appearance of this document is unlawful and offenders may be prosecuted to the fullest extent of the law.

Report Number :TERF2308001923E2
 Operation Mode :802.11n40
 Test Frequency :5230 MHz
 Test Mode :Tx
 EUT Pol :E2 Plane

Test Site :SAC G Chamber
 Test Date :2023-08-26
 Temp./Humi. :26.9°C/59%
 Antenna Pol. :Vertical
 Engineer :Temo Chen

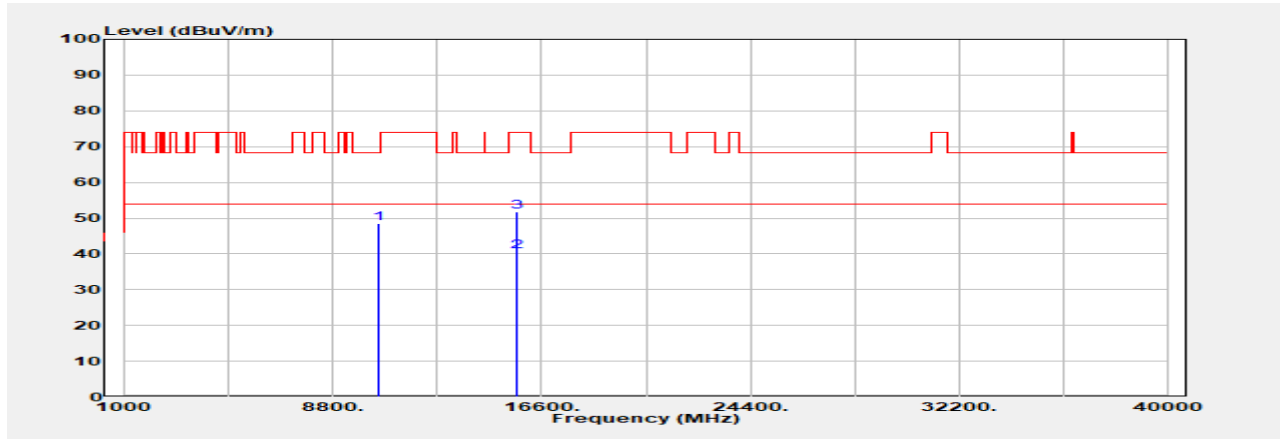

Freq. MHz	Detector Mode PK/QP/AVG	Spectrum Reading Level dBμV	Factor dB	Actual FS dBμV/m	Limit @3m dBμV/m	Margin dB
10460.000	Peak	38.81	9.74	48.55	68.20	-19.65
15690.000	Average	28.12	12.53	40.65	54.00	-13.35
15690.000	Peak	39.20	12.53	51.73	74.00	-22.27

Unless otherwise stated the results shown in this test report refer only to the sample(s) tested and such sample(s) are retained for 90 days only.

除非另有說明，此報告結果僅對測試之樣品負責，同時此樣品僅保留90天。本報告未經本公司書面許可，不可部份複製。

This document is issued by the Company subject to its General Conditions of Service printed overleaf, available on request or accessible at <http://www.sgs.com.tw/Terms-and-Conditions> and for electronic format documents, subject to Terms and Conditions for Electronic Documents at <http://www.sgs.com.tw/Terms-and-Conditions>. Attention is drawn to the limitation of liability, indemnification and jurisdiction issues defined therein. Any holder of this document is advised that information contained hereon reflects the Company's findings at the time of its intervention only and within the limits of Client's instructions, if any. The Company's sole responsibility is to its Client and this document does not exonerate parties to a transaction from exercising all their rights and obligations under the transaction documents. This document cannot be reproduced except in full, without prior written approval of the Company. Any unauthorized alteration, forgery or falsification of the content or appearance of this document is unlawful and offenders may be prosecuted to the fullest extent of the law.

Report Number :TERF2308001923E2
 Operation Mode :802.11n40
 Test Frequency :5230 MHz
 Test Mode :Tx
 EUT Pol :E2 Plane

Test Site :SAC G Chamber
 Test Date :2023-08-26
 Temp./Humi. :26.9°C/59%
 Antenna Pol. :Horizontal
 Engineer :Temo Chen

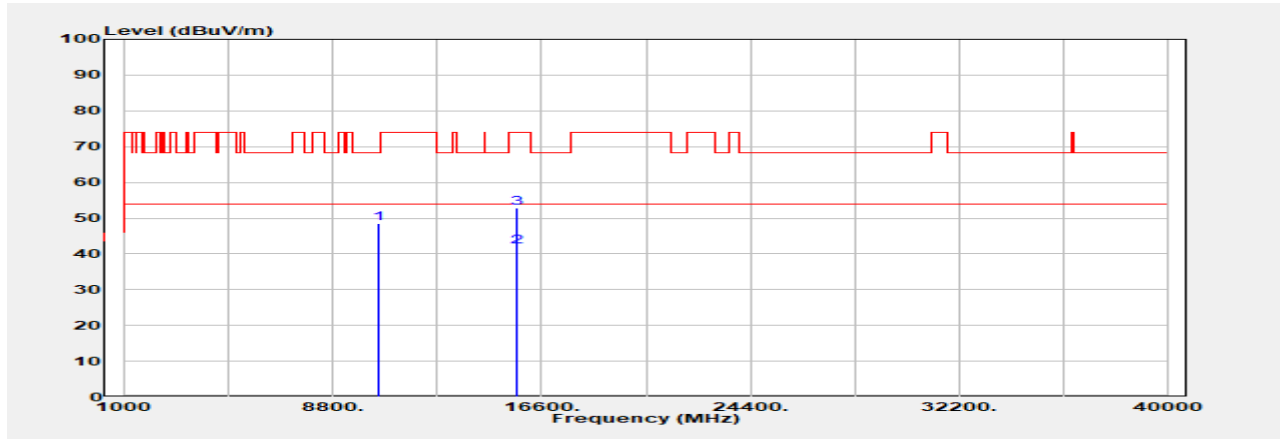

Freq. MHz	Detector Mode PK/QP/AVG	Spectrum Reading Level dB μ V	Factor dB	Actual FS dB μ V/m	Limit @3m dB μ V/m	Margin dB
10460.000	Peak	38.82	9.74	48.56	68.20	-19.64
15690.000	Average	29.45	12.53	41.98	54.00	-12.02
15690.000	Peak	40.34	12.53	52.87	74.00	-21.13

Unless otherwise stated the results shown in this test report refer only to the sample(s) tested and such sample(s) are retained for 90 days only.

除非另有說明，此報告結果僅對測試之樣品負責，同時此樣品僅保留90天。本報告未經本公司書面許可，不可部份複製。

This document is issued by the Company subject to its General Conditions of Service printed overleaf, available on request or accessible at <http://www.sgs.com.tw/Terms-and-Conditions> and for electronic format documents, subject to Terms and Conditions for Electronic Documents at <http://www.sgs.com.tw/Terms-and-Conditions>. Attention is drawn to the limitation of liability, indemnification and jurisdiction issues defined therein. Any holder of this document is advised that information contained hereon reflects the Company's findings at the time of its intervention only and within the limits of Client's instructions, if any. The Company's sole responsibility is to its Client and this document does not exonerate parties to a transaction from exercising all their rights and obligations under the transaction documents. This document cannot be reproduced except in full, without prior written approval of the Company. Any unauthorized alteration, forgery or falsification of the content or appearance of this document is unlawful and offenders may be prosecuted to the fullest extent of the law.

Report Number :TERF2308001923E2
 Operation Mode :802.11n40
 Test Frequency :5270 MHz
 Test Mode :Tx
 EUT Pol :E2 Plane

Test Site :SAC G Chamber
 Test Date :2023-08-26
 Temp./Humi. :26.9°C/59%
 Antenna Pol. :Vertical
 Engineer :Temo Chen

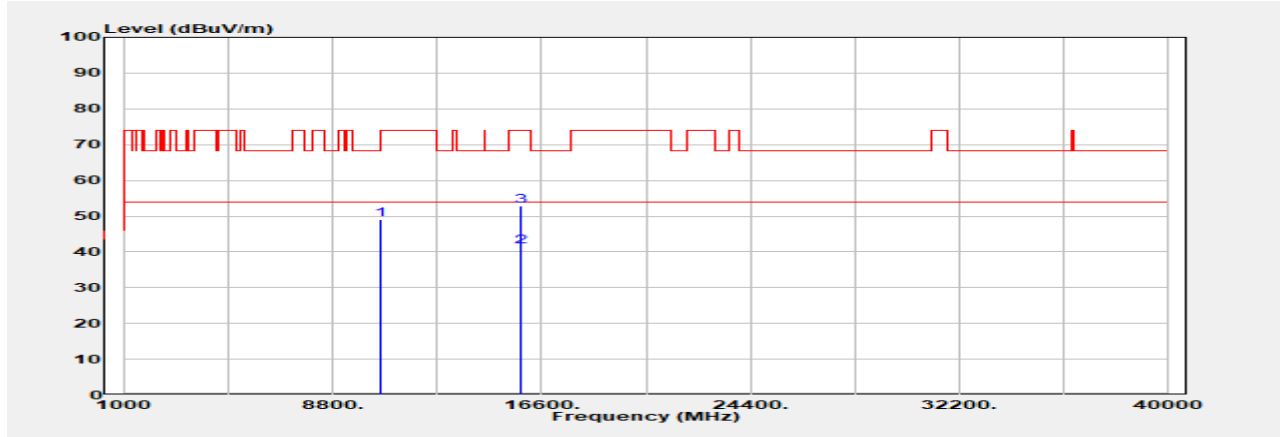

Freq. MHz	Detector Mode PK/QP/AVG	Spectrum Reading Level dB μ V	Factor dB	Actual FS dB μ V/m	Limit @3m dB μ V/m	Margin dB
10540.000	Peak	38.98	9.94	48.92	68.20	-19.28
15810.000	Average	29.21	12.38	41.59	54.00	-12.41
15810.000	Peak	40.44	12.38	52.82	74.00	-21.18

Unless otherwise stated the results shown in this test report refer only to the sample(s) tested and such sample(s) are retained for 90 days only.

除非另有說明，此報告結果僅對測試之樣品負責，同時此樣品僅保留90天。本報告未經本公司書面許可，不可部份複製。

This document is issued by the Company subject to its General Conditions of Service printed overleaf, available on request or accessible at <http://www.sgs.com.tw/Terms-and-Conditions> and for electronic format documents, subject to Terms and Conditions for Electronic Documents at <http://www.sgs.com.tw/Terms-and-Conditions>. Attention is drawn to the limitation of liability, indemnification and jurisdiction issues defined therein. Any holder of this document is advised that information contained hereon reflects the Company's findings at the time of its intervention only and within the limits of Client's instructions, if any. The Company's sole responsibility is to its Client and this document does not exonerate parties to a transaction from exercising all their rights and obligations under the transaction documents. This document cannot be reproduced except in full, without prior written approval of the Company. Any unauthorized alteration, forgery or falsification of the content or appearance of this document is unlawful and offenders may be prosecuted to the fullest extent of the law.

Report Number :TERF2308001923E2
 Operation Mode :802.11n40
 Test Frequency :5270 MHz
 Test Mode :Tx
 EUT Pol :E2 Plane

Test Site :SAC G Chamber
 Test Date :2023-08-26
 Temp./Humi. :26.9°C/59%
 Antenna Pol. :Horizontal
 Engineer :Temo Chen

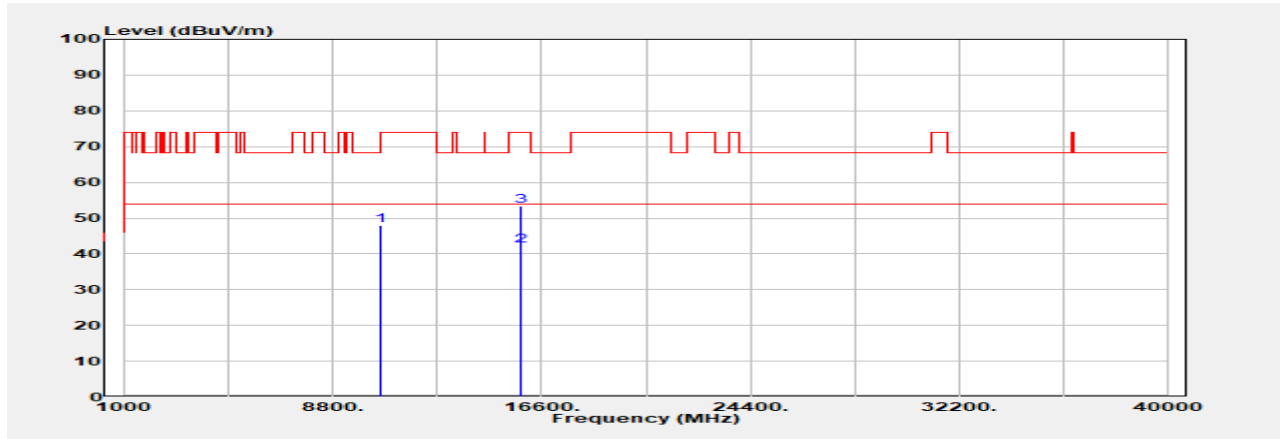

Freq. MHz	Detector Mode PK/QP/AVG	Spectrum Reading Level dB μ V	Factor dB	Actual FS dB μ V/m	Limit @3m dB μ V/m	Margin dB
10540.000	Peak	38.08	9.94	48.02	68.20	-20.18
15810.000	Average	30.01	12.38	42.39	54.00	-11.61
15810.000	Peak	41.07	12.38	53.45	74.00	-20.55

Unless otherwise stated the results shown in this test report refer only to the sample(s) tested and such sample(s) are retained for 90 days only.

除非另有說明，此報告結果僅對測試之樣品負責，同時此樣品僅保留90天。本報告未經本公司書面許可，不可部份複製。

This document is issued by the Company subject to its General Conditions of Service printed overleaf, available on request or accessible at <http://www.sgs.com.tw/Terms-and-Conditions> and for electronic format documents, subject to Terms and Conditions for Electronic Documents at <http://www.sgs.com.tw/Terms-and-Conditions>. Attention is drawn to the limitation of liability, indemnification and jurisdiction issues defined therein. Any holder of this document is advised that information contained hereon reflects the Company's findings at the time of its intervention only and within the limits of Client's instructions, if any. The Company's sole responsibility is to its Client and this document does not exonerate parties to a transaction from exercising all their rights and obligations under the transaction documents. This document cannot be reproduced except in full, without prior written approval of the Company. Any unauthorized alteration, forgery or falsification of the content or appearance of this document is unlawful and offenders may be prosecuted to the fullest extent of the law.

Report Number :TERF2308001923E2
 Operation Mode :802.11n40
 Test Frequency :5310 MHz
 Test Mode :Tx
 EUT Pol :E2 Plane

Test Site :SAC G Chamber
 Test Date :2023-10-19
 Temp./Humi. :22.3°C/60%
 Antenna Pol. :Vertical
 Engineer :Temo Chen

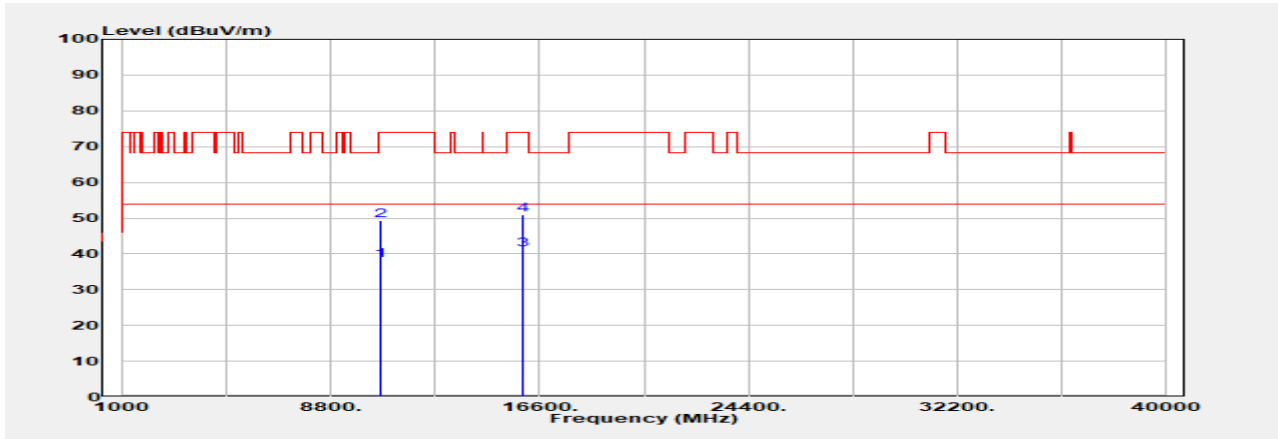

Freq. MHz	Detector Mode PK/QP/AVG	Spectrum Reading Level dB μ V	Factor dB	Actual FS dB μ V/m	Limit @3m dB μ V/m	Margin dB
10620.000	Average	28.43	9.86	38.29	54.00	-15.71
10620.000	Peak	39.33	9.86	49.19	74.00	-24.81
15930.000	Average	29.27	12.05	41.32	54.00	-12.68
15930.000	Peak	38.80	12.05	50.84	74.00	-23.16

Unless otherwise stated the results shown in this test report refer only to the sample(s) tested and such sample(s) are retained for 90 days only.

除非另有說明，此報告結果僅對測試之樣品負責，同時此樣品僅保留90天。本報告未經本公司書面許可，不可部份複製。

This document is issued by the Company subject to its General Conditions of Service printed overleaf, available on request or accessible at <http://www.sgs.com.tw/Terms-and-Conditions> and for electronic format documents, subject to Terms and Conditions for Electronic Documents at <http://www.sgs.com.tw/Terms-and-Conditions>. Attention is drawn to the limitation of liability, indemnification and jurisdiction issues defined therein. Any holder of this document is advised that information contained hereon reflects the Company's findings at the time of its intervention only and within the limits of Client's instructions, if any. The Company's sole responsibility is to its Client and this document does not exonerate parties to a transaction from exercising all their rights and obligations under the transaction documents. This document cannot be reproduced except in full, without prior written approval of the Company. Any unauthorized alteration, forgery or falsification of the content or appearance of this document is unlawful and offenders may be prosecuted to the fullest extent of the law.

Report Number :TERF2308001923E2
 Operation Mode :802.11n40
 Test Frequency :5310 MHz
 Test Mode :Tx
 EUT Pol :E2 Plane

Test Site :SAC G Chamber
 Test Date :2023-10-19
 Temp./Humi. :22.3°C/60%
 Antenna Pol. :Horizontal
 Engineer :Temo Chen

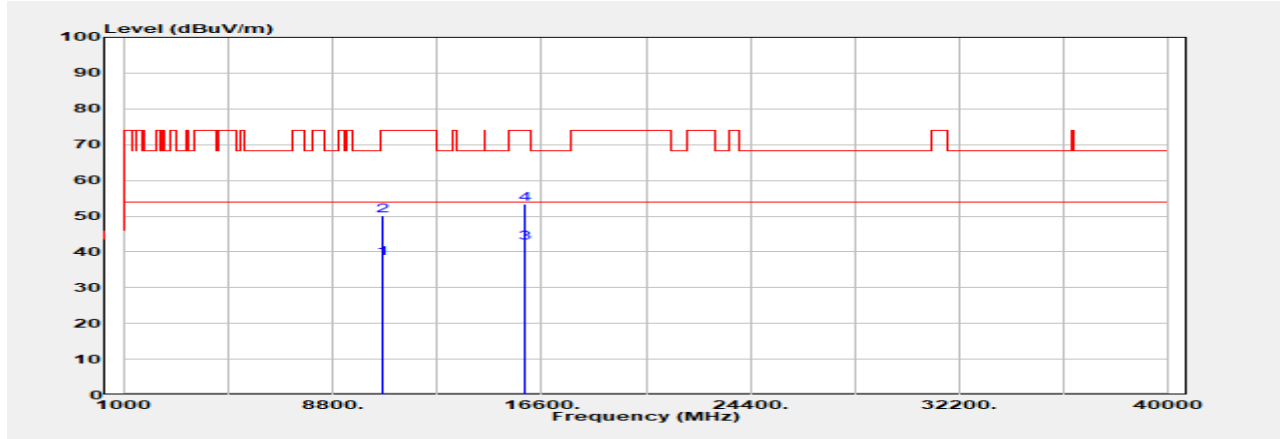

Freq. MHz	Detector Mode PK/QP/AVG	Spectrum Reading Level dB μ V	Factor dB	Actual FS dB μ V/m	Limit @3m dB μ V/m	Margin dB
10620.000	Average	28.38	9.86	38.24	54.00	-15.76
10620.000	Peak	40.15	9.86	50.01	74.00	-23.99
15930.000	Average	30.44	12.05	42.49	54.00	-11.51
15930.000	Peak	41.42	12.05	53.47	74.00	-20.53

Unless otherwise stated the results shown in this test report refer only to the sample(s) tested and such sample(s) are retained for 90 days only.

除非另有說明，此報告結果僅對測試之樣品負責，同時此樣品僅保留90天。本報告未經本公司書面許可，不可部份複製。

This document is issued by the Company subject to its General Conditions of Service printed overleaf, available on request or accessible at <http://www.sgs.com.tw/Terms-and-Conditions> and for electronic format documents, subject to Terms and Conditions for Electronic Documents at <http://www.sgs.com.tw/Terms-and-Conditions>. Attention is drawn to the limitation of liability, indemnification and jurisdiction issues defined therein. Any holder of this document is advised that information contained hereon reflects the Company's findings at the time of its intervention only and within the limits of Client's instructions, if any. The Company's sole responsibility is to its Client and this document does not exonerate parties to a transaction from exercising all their rights and obligations under the transaction documents. This document cannot be reproduced except in full, without prior written approval of the Company. Any unauthorized alteration, forgery or falsification of the content or appearance of this document is unlawful and offenders may be prosecuted to the fullest extent of the law.

Report Number :TERF2308001923E2
 Operation Mode :802.11n40
 Test Frequency :5510 MHz
 Test Mode :Tx
 EUT Pol :E2 Plane

Test Site :SAC G Chamber
 Test Date :2023-08-26
 Temp./Humi. :26.9°C/59%
 Antenna Pol. :Vertical
 Engineer :Temo Chen

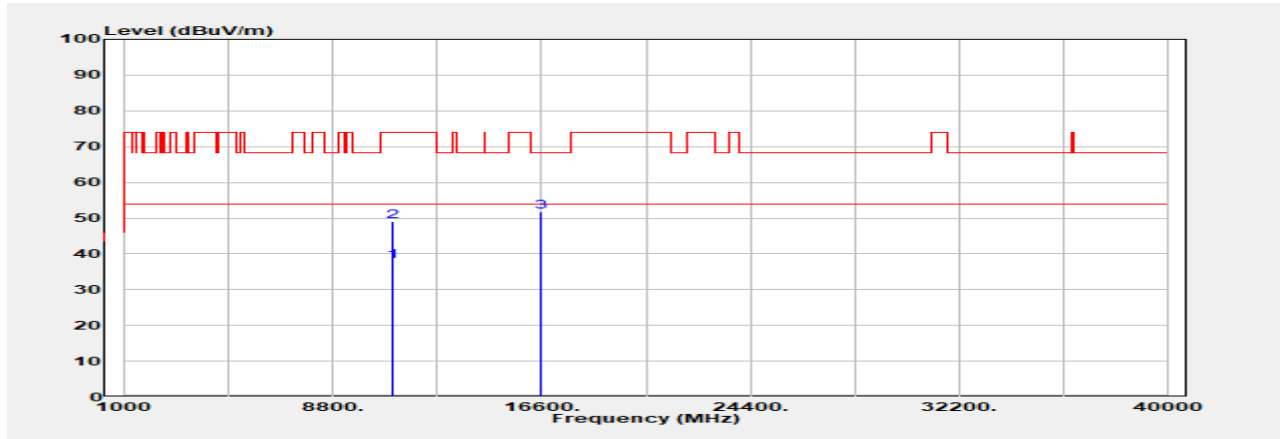

Freq. MHz	Detector Mode PK/QP/AVG	Spectrum Reading Level dB μ V	Factor dB	Actual FS dB μ V/m	Limit @3m dB μ V/m	Margin dB
11020.000	Average	26.57	11.46	38.03	54.00	-15.97
11020.000	Peak	37.67	11.46	49.13	74.00	-24.87
16530.000	Peak	39.69	11.94	51.63	68.20	-16.57

Unless otherwise stated the results shown in this test report refer only to the sample(s) tested and such sample(s) are retained for 90 days only.

除非另有說明，此報告結果僅對測試之樣品負責，同時此樣品僅保留90天。本報告未經本公司書面許可，不可部份複製。

This document is issued by the Company subject to its General Conditions of Service printed overleaf, available on request or accessible at <http://www.sgs.com.tw/Terms-and-Conditions> and for electronic format documents, subject to Terms and Conditions for Electronic Documents at <http://www.sgs.com.tw/Terms-and-Conditions>. Attention is drawn to the limitation of liability, indemnification and jurisdiction issues defined therein. Any holder of this document is advised that information contained hereon reflects the Company's findings at the time of its intervention only and within the limits of Client's instructions, if any. The Company's sole responsibility is to its Client and this document does not exonerate parties to a transaction from exercising all their rights and obligations under the transaction documents. This document cannot be reproduced except in full, without prior written approval of the Company. Any unauthorized alteration, forgery or falsification of the content or appearance of this document is unlawful and offenders may be prosecuted to the fullest extent of the law.

Report Number :TERF2308001923E2
 Operation Mode :802.11n40
 Test Frequency :5510 MHz
 Test Mode :Tx
 EUT Pol :E2 Plane

Test Site :SAC G Chamber
 Test Date :2023-08-26
 Temp./Humi. :26.9°C/59%
 Antenna Pol. :Horizontal
 Engineer :Temo Chen

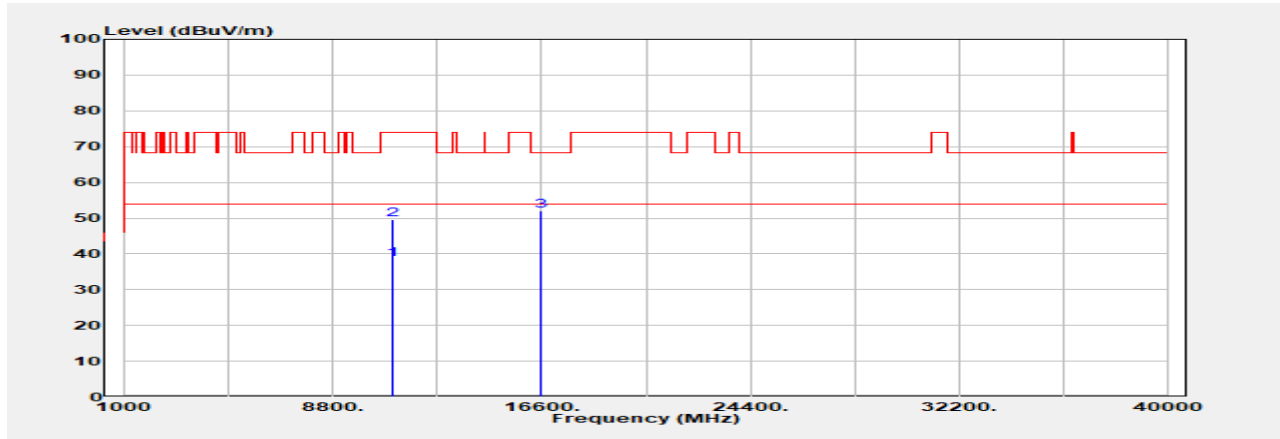

Freq. MHz	Detector Mode PK/QP/AVG	Spectrum Reading Level dBμV	Factor dB	Actual FS dBμV/m	Limit @3m dBμV/m	Margin dB
11020.000	Average	27.13	11.46	38.59	54.00	-15.41
11020.000	Peak	38.09	11.46	49.55	74.00	-24.45
16530.000	Peak	39.96	11.94	51.90	68.20	-16.30

Unless otherwise stated the results shown in this test report refer only to the sample(s) tested and such sample(s) are retained for 90 days only.

除非另有說明，此報告結果僅對測試之樣品負責，同時此樣品僅保留90天。本報告未經本公司書面許可，不可部份複製。

This document is issued by the Company subject to its General Conditions of Service printed overleaf, available on request or accessible at <http://www.sgs.com.tw/Terms-and-Conditions> and for electronic format documents, subject to Terms and Conditions for Electronic Documents at <http://www.sgs.com.tw/Terms-and-Conditions>. Attention is drawn to the limitation of liability, indemnification and jurisdiction issues defined therein. Any holder of this document is advised that information contained hereon reflects the Company's findings at the time of its intervention only and within the limits of Client's instructions, if any. The Company's sole responsibility is to its Client and this document does not exonerate parties to a transaction from exercising all their rights and obligations under the transaction documents. This document cannot be reproduced except in full, without prior written approval of the Company. Any unauthorized alteration, forgery or falsification of the content or appearance of this document is unlawful and offenders may be prosecuted to the fullest extent of the law.

Report Number :TERF2308001923E2
 Operation Mode :802.11n40
 Test Frequency :5550 MHz
 Test Mode :Tx
 EUT Pol :E2 Plane

Test Site :SAC G Chamber
 Test Date :2023-08-26
 Temp./Humi. :26.9°C/59%
 Antenna Pol. :Vertical
 Engineer :Temo Chen

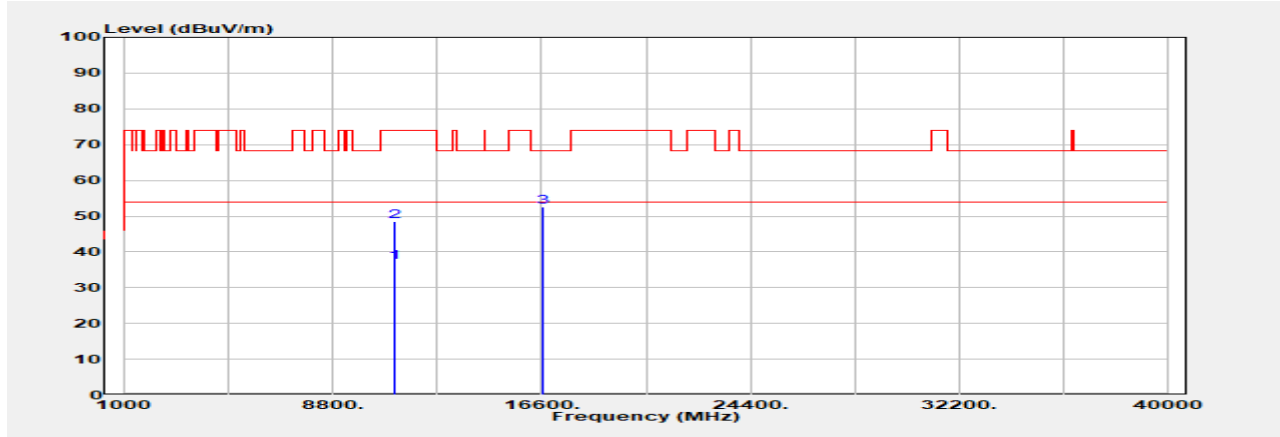

Freq. MHz	Detector Mode PK/QP/AVG	Spectrum Reading Level dB μ V	Factor dB	Actual FS dB μ V/m	Limit @3m dB μ V/m	Margin dB
11100.000	Average	27.46	9.70	37.16	54.00	-16.84
11100.000	Peak	38.74	9.70	48.44	74.00	-25.56
16650.000	Peak	40.73	11.75	52.48	68.20	-15.72

Unless otherwise stated the results shown in this test report refer only to the sample(s) tested and such sample(s) are retained for 90 days only.

除非另有說明，此報告結果僅對測試之樣品負責，同時此樣品僅保留90天。本報告未經本公司書面許可，不可部份複製。

This document is issued by the Company subject to its General Conditions of Service printed overleaf, available on request or accessible at <http://www.sgs.com.tw/Terms-and-Conditions> and for electronic format documents, subject to Terms and Conditions for Electronic Documents at <http://www.sgs.com.tw/Terms-and-Conditions>. Attention is drawn to the limitation of liability, indemnification and jurisdiction issues defined therein. Any holder of this document is advised that information contained hereon reflects the Company's findings at the time of its intervention only and within the limits of Client's instructions, if any. The Company's sole responsibility is to its Client and this document does not exonerate parties to a transaction from exercising all their rights and obligations under the transaction documents. This document cannot be reproduced except in full, without prior written approval of the Company. Any unauthorized alteration, forgery or falsification of the content or appearance of this document is unlawful and offenders may be prosecuted to the fullest extent of the law.

Report Number :TERF2308001923E2
 Operation Mode :802.11n40
 Test Frequency :5550 MHz
 Test Mode :Tx
 EUT Pol :E2 Plane

Test Site :SAC G Chamber
 Test Date :2023-08-26
 Temp./Humi. :26.9°C/59%
 Antenna Pol. :Horizontal
 Engineer :Temo Chen

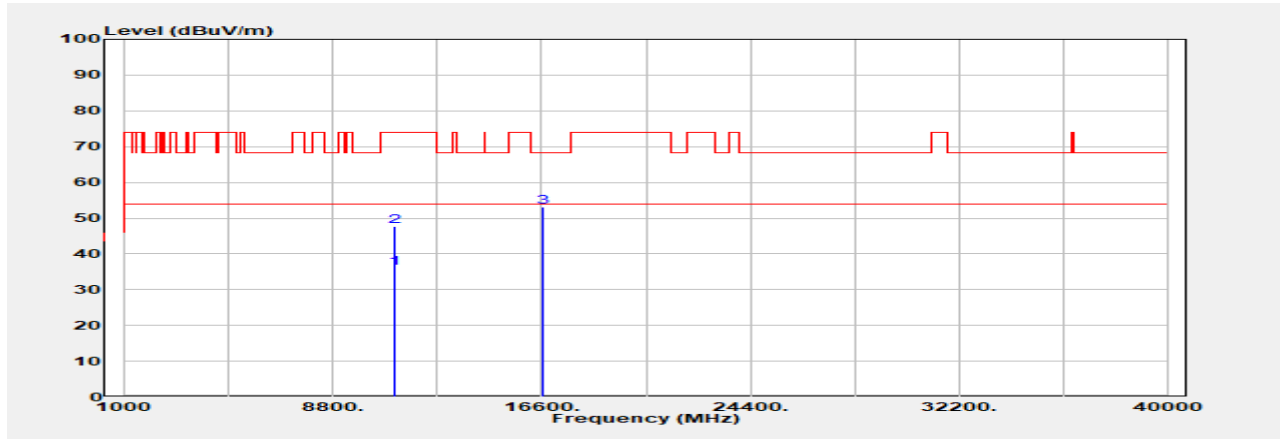

Freq. MHz	Detector Mode PK/QP/AVG	Spectrum Reading Level dB μ V	Factor dB	Actual FS dB μ V/m	Limit @3m dB μ V/m	Margin dB
11100.000	Average	26.43	9.70	36.13	54.00	-17.87
11100.000	Peak	37.92	9.70	47.62	74.00	-26.38
16650.000	Peak	41.36	11.75	53.11	68.20	-15.09

Unless otherwise stated the results shown in this test report refer only to the sample(s) tested and such sample(s) are retained for 90 days only.

除非另有說明，此報告結果僅對測試之樣品負責，同時此樣品僅保留90天。本報告未經本公司書面許可，不可部份複製。

This document is issued by the Company subject to its General Conditions of Service printed overleaf, available on request or accessible at <http://www.sgs.com.tw/Terms-and-Conditions> and for electronic format documents, subject to Terms and Conditions for Electronic Documents at <http://www.sgs.com.tw/Terms-and-Conditions>. Attention is drawn to the limitation of liability, indemnification and jurisdiction issues defined therein. Any holder of this document is advised that information contained hereon reflects the Company's findings at the time of its intervention only and within the limits of Client's instructions, if any. The Company's sole responsibility is to its Client and this document does not exonerate parties to a transaction from exercising all their rights and obligations under the transaction documents. This document cannot be reproduced except in full, without prior written approval of the Company. Any unauthorized alteration, forgery or falsification of the content or appearance of this document is unlawful and offenders may be prosecuted to the fullest extent of the law.

Report Number :TERF2308001923E2
 Operation Mode :802.11n40
 Test Frequency :5670 MHz
 Test Mode :Tx
 EUT Pol :E2 Plane

Test Site :SAC G Chamber
 Test Date :2023-08-26
 Temp./Humi. :26.9°C/59%
 Antenna Pol. :Vertical
 Engineer :Temo Chen

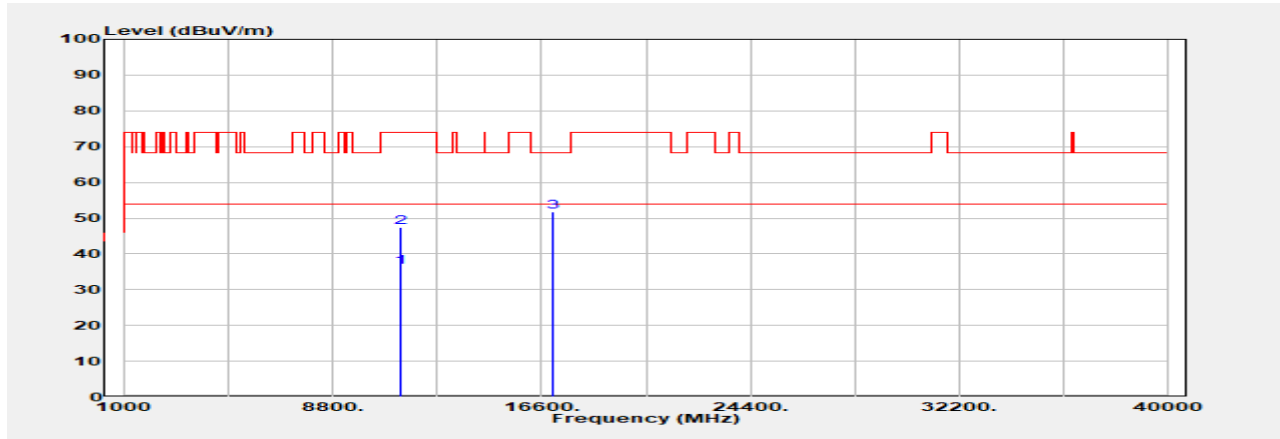

Freq. MHz	Detector Mode PK/QP/AVG	Spectrum Reading Level dB μ V	Factor dB	Actual FS dB μ V/m	Limit @3m dB μ V/m	Margin dB
11340.000	Average	26.58	9.74	36.32	54.00	-17.68
11340.000	Peak	37.68	9.74	47.42	74.00	-26.58
17010.000	Peak	40.05	11.84	51.89	68.20	-16.31

Unless otherwise stated the results shown in this test report refer only to the sample(s) tested and such sample(s) are retained for 90 days only.

除非另有說明，此報告結果僅對測試之樣品負責，同時此樣品僅保留90天。本報告未經本公司書面許可，不可部份複製。

This document is issued by the Company subject to its General Conditions of Service printed overleaf, available on request or accessible at <http://www.sgs.com.tw/Terms-and-Conditions> and for electronic format documents, subject to Terms and Conditions for Electronic Documents at <http://www.sgs.com.tw/Terms-and-Conditions>. Attention is drawn to the limitation of liability, indemnification and jurisdiction issues defined therein. Any holder of this document is advised that information contained hereon reflects the Company's findings at the time of its intervention only and within the limits of Client's instructions, if any. The Company's sole responsibility is to its Client and this document does not exonerate parties to a transaction from exercising all their rights and obligations under the transaction documents. This document cannot be reproduced except in full, without prior written approval of the Company. Any unauthorized alteration, forgery or falsification of the content or appearance of this document is unlawful and offenders may be prosecuted to the fullest extent of the law.

Report Number :TERF2308001923E2
 Operation Mode :802.11n40
 Test Frequency :5670 MHz
 Test Mode :Tx
 EUT Pol :E2 Plane

Test Site :SAC G Chamber
 Test Date :2023-08-26
 Temp./Humi. :26.9°C/59%
 Antenna Pol. :Horizontal
 Engineer :Temo Chen

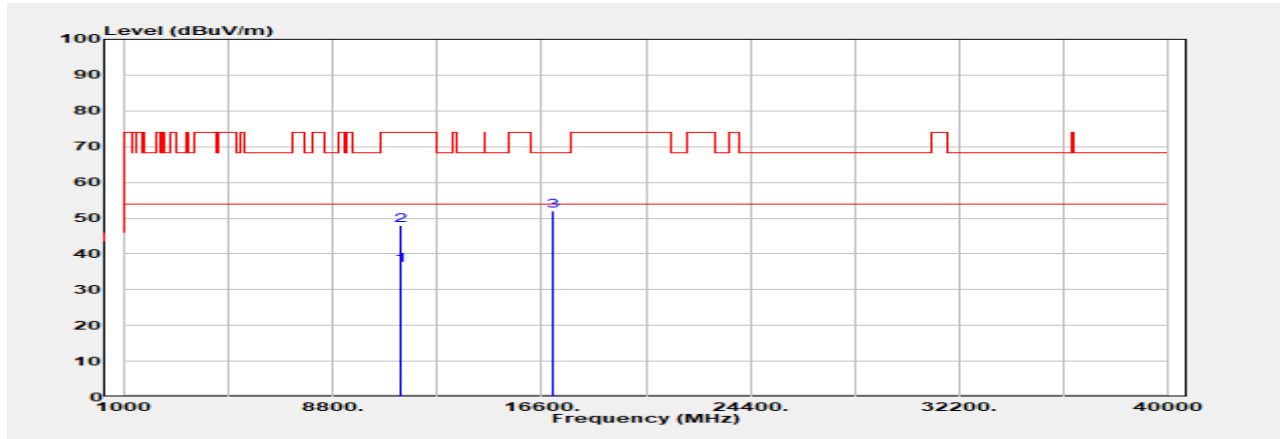

Freq. MHz	Detector Mode PK/QP/AVG	Spectrum Reading Level dBμV	Factor dB	Actual FS dBμV/m	Limit @3m dBμV/m	Margin dB
11340.000	Average	27.11	9.74	36.85	54.00	-17.15
11340.000	Peak	38.22	9.74	47.96	74.00	-26.04
17010.000	Peak	40.06	11.84	51.90	68.20	-16.30

Unless otherwise stated the results shown in this test report refer only to the sample(s) tested and such sample(s) are retained for 90 days only.

除非另有說明，此報告結果僅對測試之樣品負責，同時此樣品僅保留90天。本報告未經本公司書面許可，不可部份複製。

This document is issued by the Company subject to its General Conditions of Service printed overleaf, available on request or accessible at <http://www.sgs.com.tw/Terms-and-Conditions> and for electronic format documents, subject to Terms and Conditions for Electronic Documents at <http://www.sgs.com.tw/Terms-and-Conditions>. Attention is drawn to the limitation of liability, indemnification and jurisdiction issues defined therein. Any holder of this document is advised that information contained hereon reflects the Company's findings at the time of its intervention only and within the limits of Client's instructions, if any. The Company's sole responsibility is to its Client and this document does not exonerate parties to a transaction from exercising all their rights and obligations under the transaction documents. This document cannot be reproduced except in full, without prior written approval of the Company. Any unauthorized alteration, forgery or falsification of the content or appearance of this document is unlawful and offenders may be prosecuted to the fullest extent of the law.

Report Number :TERF2308001923E2

Test Site :SAC G Chamber

Operation Mode :802.11n40

Test Date :2023-10-19

Test Frequency :5755 MHz

Temp./Humi. :22.3°C/60%

Test Mode :Tx

Antenna Pol. :Vertical

EUT Pol :E2 Plane

Engineer :Temo Chen

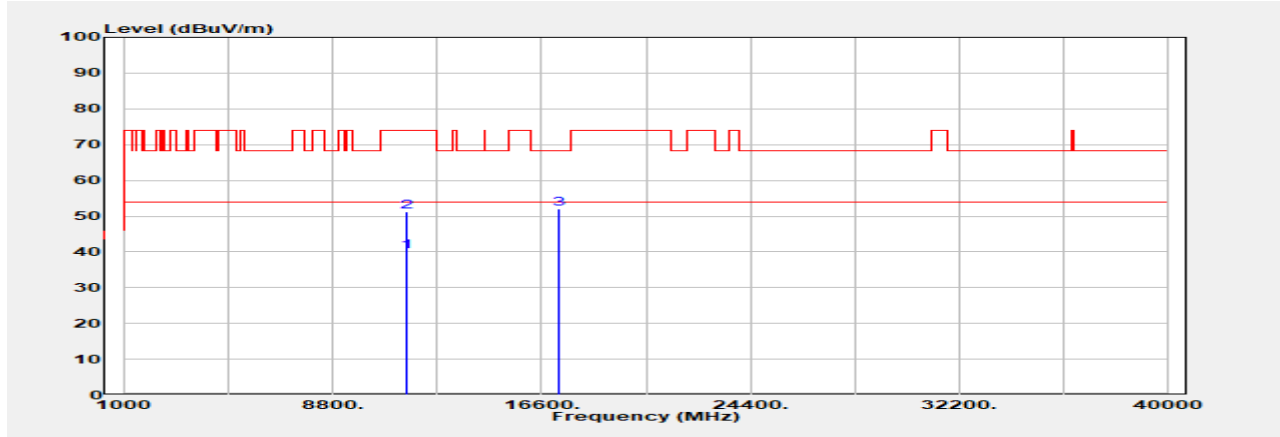

Freq. MHz	Detector Mode PK/QP/AVG	Spectrum Reading Level dB μ V	Factor dB	Actual FS dB μ V/m	Limit @3m dB μ V/m	Margin dB
11510.000	Average	29.06	11.05	40.11	54.00	-13.89
11510.000	Peak	40.08	11.05	51.13	74.00	-22.87
17265.000	Peak	40.76	11.18	51.94	68.20	-16.26

Unless otherwise stated the results shown in this test report refer only to the sample(s) tested and such sample(s) are retained for 90 days only.

除非另有說明，此報告結果僅對測試之樣品負責，同時此樣品僅保留90天。本報告未經本公司書面許可，不可部份複製。

This document is issued by the Company subject to its General Conditions of Service printed overleaf, available on request or accessible at <http://www.sgs.com.tw/Terms-and-Conditions> and for electronic format documents, subject to Terms and Conditions for Electronic Documents at <http://www.sgs.com.tw/Terms-and-Conditions>. Attention is drawn to the limitation of liability, indemnification and jurisdiction issues defined therein. Any holder of this document is advised that information contained hereon reflects the Company's findings at the time of its intervention only and within the limits of Client's instructions, if any. The Company's sole responsibility is to its Client and this document does not exonerate parties to a transaction from exercising all their rights and obligations under the transaction documents. This document cannot be reproduced except in full, without prior written approval of the Company. Any unauthorized alteration, forgery or falsification of the content or appearance of this document is unlawful and offenders may be prosecuted to the fullest extent of the law.

Report Number :TERF2308001923E2

Test Site :SAC G Chamber

Operation Mode :802.11n40

Test Date :2023-10-19

Test Frequency :5755 MHz

Temp./Humi. :22.3°C/60%

Test Mode :Tx

Antenna Pol. :Horizontal

EUT Pol :E2 Plane

Engineer :Temo Chen



Freq. MHz	Detector Mode PK/QP/AVG	Spectrum Reading Level dBμV	Factor dB	Actual FS dBμV/m	Limit @3m dBμV/m	Margin dB
11510.000	Average	29.43	11.05	40.48	54.00	-13.52
11510.000	Peak	40.11	11.05	51.16	74.00	-22.84
17265.000	Peak	40.89	11.18	52.07	68.20	-16.13

Unless otherwise stated the results shown in this test report refer only to the sample(s) tested and such sample(s) are retained for 90 days only.

除非另有說明，此報告結果僅對測試之樣品負責，同時此樣品僅保留90天。本報告未經本公司書面許可，不可部份複製。

This document is issued by the Company subject to its General Conditions of Service printed overleaf, available on request or accessible at <http://www.sgs.com.tw/Terms-and-Conditions> and for electronic format documents, subject to Terms and Conditions for Electronic Documents at <http://www.sgs.com.tw/Terms-and-Conditions>. Attention is drawn to the limitation of liability, indemnification and jurisdiction issues defined therein. Any holder of this document is advised that information contained hereon reflects the Company's findings at the time of its intervention only and within the limits of Client's instructions, if any. The Company's sole responsibility is to its Client and this document does not exonerate parties to a transaction from exercising all their rights and obligations under the transaction documents. This document cannot be reproduced except in full, without prior written approval of the Company. Any unauthorized alteration, forgery or falsification of the content or appearance of this document is unlawful and offenders may be prosecuted to the fullest extent of the law.

Report Number :TERF2308001923E2

Test Site :SAC G Chamber

Operation Mode :802.11n40

Test Date :2023-08-26

Test Frequency :5795 MHz

Temp./Humi. :26.9°C/59%

Test Mode :Tx

Antenna Pol. :Vertical

EUT Pol :E2 Plane

Engineer :Temo Chen

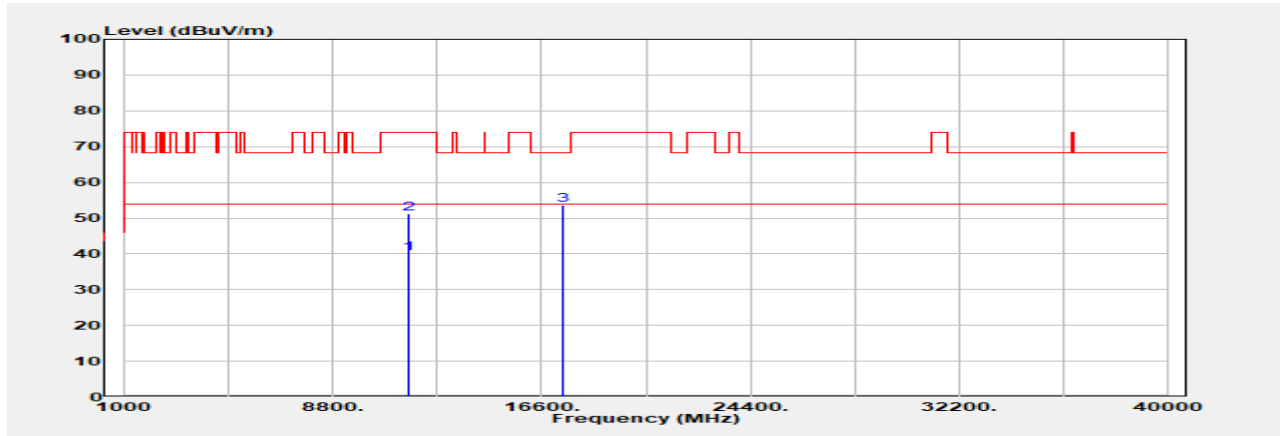

Freq. MHz	Detector Mode PK/QP/AVG	Spectrum Reading Level dBμV	Factor dB	Actual FS dBμV/m	Limit @3m dBμV/m	Margin dB
11590.000	Average	30.28	9.85	40.13	54.00	-13.87
11590.000	Peak	41.50	9.85	51.35	74.00	-22.65
17385.000	Peak	41.80	11.94	53.74	68.20	-14.46

Unless otherwise stated the results shown in this test report refer only to the sample(s) tested and such sample(s) are retained for 90 days only.

除非另有說明，此報告結果僅對測試之樣品負責，同時此樣品僅保留90天。本報告未經本公司書面許可，不可部份複製。

This document is issued by the Company subject to its General Conditions of Service printed overleaf, available on request or accessible at <http://www.sgs.com.tw/Terms-and-Conditions> and for electronic format documents, subject to Terms and Conditions for Electronic Documents at <http://www.sgs.com.tw/Terms-and-Conditions>. Attention is drawn to the limitation of liability, indemnification and jurisdiction issues defined therein. Any holder of this document is advised that information contained hereon reflects the Company's findings at the time of its intervention only and within the limits of Client's instructions, if any. The Company's sole responsibility is to its Client and this document does not exonerate parties to a transaction from exercising all their rights and obligations under the transaction documents. This document cannot be reproduced except in full, without prior written approval of the Company. Any unauthorized alteration, forgery or falsification of the content or appearance of this document is unlawful and offenders may be prosecuted to the fullest extent of the law.

Report Number :TERF2308001923E2

Test Site :SAC G Chamber

Operation Mode :802.11n40

Test Date :2023-08-26

Test Frequency :5795 MHz

Temp./Humi. :26.9°C/59%

Test Mode :Tx

Antenna Pol. :Horizontal

EUT Pol :E2 Plane

Engineer :Temo Chen

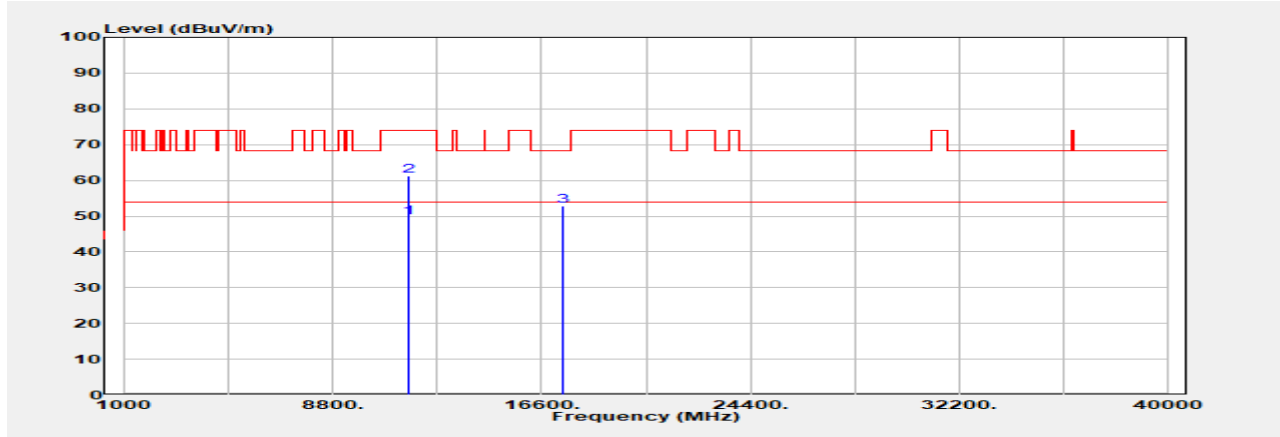

Freq. MHz	Detector Mode PK/QP/AVG	Spectrum Reading Level dB μ V	Factor dB	Actual FS dB μ V/m	Limit @3m dB μ V/m	Margin dB
11590.000	Average	39.69	9.85	49.54	54.00	-4.46
11590.000	Peak	51.39	9.85	61.24	74.00	-12.76
17385.000	Peak	40.87	11.94	52.81	68.20	-15.39

Unless otherwise stated the results shown in this test report refer only to the sample(s) tested and such sample(s) are retained for 90 days only.

除非另有說明，此報告結果僅對測試之樣品負責，同時此樣品僅保留90天。本報告未經本公司書面許可，不可部份複製。

This document is issued by the Company subject to its General Conditions of Service printed overleaf, available on request or accessible at <http://www.sgs.com.tw/Terms-and-Conditions> and for electronic format documents, subject to Terms and Conditions for Electronic Documents at <http://www.sgs.com.tw/Terms-and-Conditions>. Attention is drawn to the limitation of liability, indemnification and jurisdiction issues defined therein. Any holder of this document is advised that information contained hereon reflects the Company's findings at the time of its intervention only and within the limits of Client's instructions, if any. The Company's sole responsibility is to its Client and this document does not exonerate parties to a transaction from exercising all their rights and obligations under the transaction documents. This document cannot be reproduced except in full, without prior written approval of the Company. Any unauthorized alteration, forgery or falsification of the content or appearance of this document is unlawful and offenders may be prosecuted to the fullest extent of the law.

Report Number :TERF2308001923E2
 Operation Mode :802.11ac80
 Test Frequency :5210 MHz
 Test Mode :Tx
 EUT Pol :E2 Plane

Test Site :SAC G Chamber
 Test Date :2023-10-20
 Temp./Humi. :21.3°C/68%
 Antenna Pol. :Vertical
 Engineer :Temo Chen

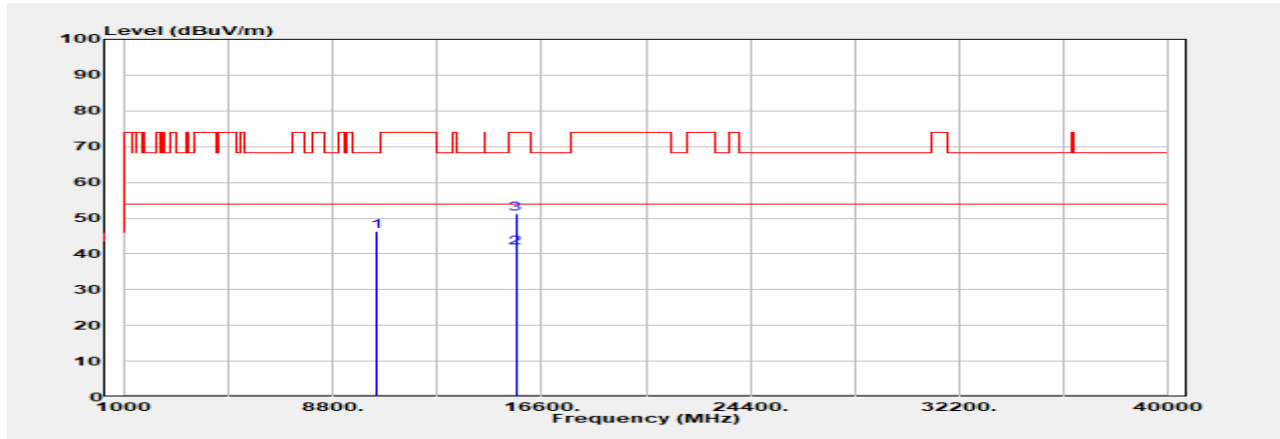

Freq. MHz	Detector Mode PK/QP/AVG	Spectrum Reading Level dB μ V	Factor dB	Actual FS dB μ V/m	Limit @3m dB μ V/m	Margin dB
10420.000	Peak	36.89	9.58	46.47	68.20	-21.73
15630.000	Average	29.54	12.11	41.65	54.00	-12.35
15630.000	Peak	39.09	12.11	51.21	74.00	-22.79

Unless otherwise stated the results shown in this test report refer only to the sample(s) tested and such sample(s) are retained for 90 days only.

除非另有說明，此報告結果僅對測試之樣品負責，同時此樣品僅保留90天。本報告未經本公司書面許可，不可部份複製。

This document is issued by the Company subject to its General Conditions of Service printed overleaf, available on request or accessible at <http://www.sgs.com.tw/Terms-and-Conditions> and for electronic format documents, subject to Terms and Conditions for Electronic Documents at <http://www.sgs.com.tw/Terms-and-Conditions>. Attention is drawn to the limitation of liability, indemnification and jurisdiction issues defined therein. Any holder of this document is advised that information contained hereon reflects the Company's findings at the time of its intervention only and within the limits of Client's instructions, if any. The Company's sole responsibility is to its Client and this document does not exonerate parties to a transaction from exercising all their rights and obligations under the transaction documents. This document cannot be reproduced except in full, without prior written approval of the Company. Any unauthorized alteration, forgery or falsification of the content or appearance of this document is unlawful and offenders may be prosecuted to the fullest extent of the law.

Report Number :TERF2308001923E2
 Operation Mode :802.11ac80
 Test Frequency :5210 MHz
 Test Mode :Tx
 EUT Pol :E2 Plane

Test Site :SAC G Chamber
 Test Date :2023-10-20
 Temp./Humi. :21.3°C/68%
 Antenna Pol. :Horizontal
 Engineer :Temo Chen

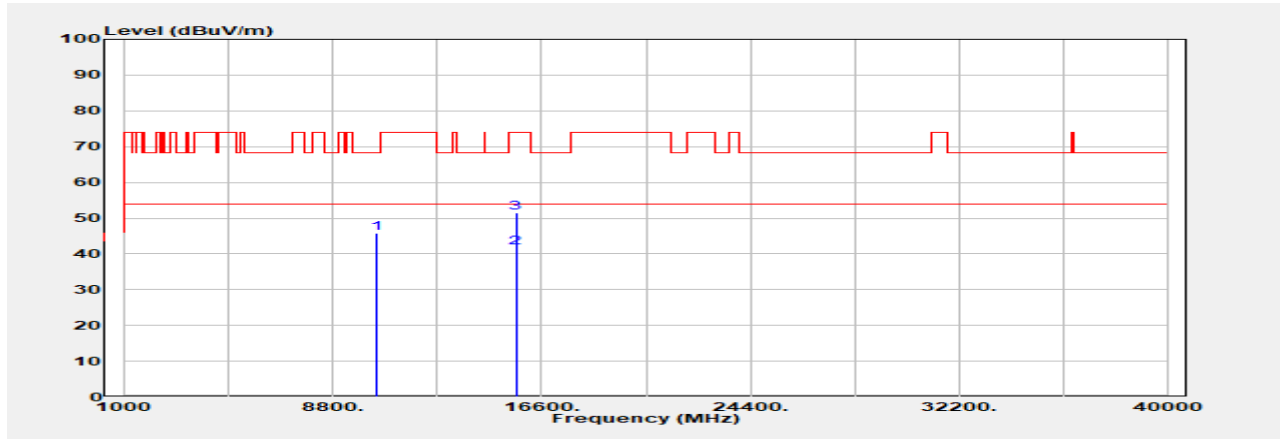

Freq. MHz	Detector Mode PK/QP/AVG	Spectrum Reading Level dB μ V	Factor dB	Actual FS dB μ V/m	Limit @3m dB μ V/m	Margin dB
10420.000	Peak	36.16	9.58	45.74	68.20	-22.46
15630.000	Average	29.67	12.11	41.78	54.00	-12.22
15630.000	Peak	39.25	12.11	51.36	74.00	-22.64

Unless otherwise stated the results shown in this test report refer only to the sample(s) tested and such sample(s) are retained for 90 days only.

除非另有說明，此報告結果僅對測試之樣品負責，同時此樣品僅保留90天。本報告未經本公司書面許可，不可部份複製。

This document is issued by the Company subject to its General Conditions of Service printed overleaf, available on request or accessible at <http://www.sgs.com.tw/Terms-and-Conditions> and for electronic format documents, subject to Terms and Conditions for Electronic Documents at <http://www.sgs.com.tw/Terms-and-Conditions>. Attention is drawn to the limitation of liability, indemnification and jurisdiction issues defined therein. Any holder of this document is advised that information contained hereon reflects the Company's findings at the time of its intervention only and within the limits of Client's instructions, if any. The Company's sole responsibility is to its Client and this document does not exonerate parties to a transaction from exercising all their rights and obligations under the transaction documents. This document cannot be reproduced except in full, without prior written approval of the Company. Any unauthorized alteration, forgery or falsification of the content or appearance of this document is unlawful and offenders may be prosecuted to the fullest extent of the law.

Report Number :TERF2308001923E2
 Operation Mode :802.11ac80
 Test Frequency :5290 MHz
 Test Mode :Tx
 EUT Pol :E2 Plane

Test Site :SAC G Chamber
 Test Date :2023-10-20
 Temp./Humi. :21.3°C/68%
 Antenna Pol. :Vertical
 Engineer :Temo Chen

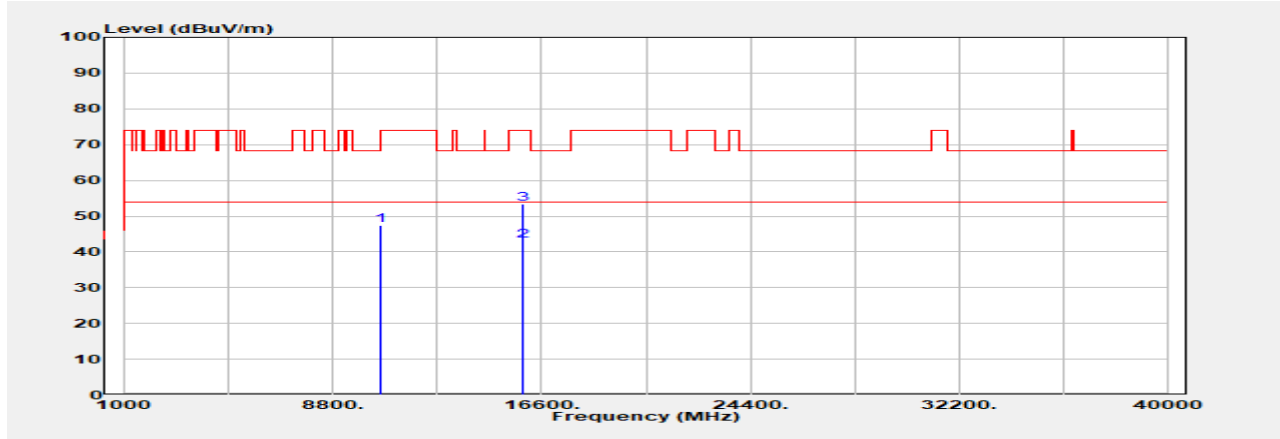

Freq. MHz	Detector Mode PK/QP/AVG	Spectrum Reading Level dBμV	Factor dB	Actual FS dBμV/m	Limit @3m dBμV/m	Margin dB
10580.000	Peak	37.53	9.98	47.51	68.20	-20.69
15870.000	Average	30.92	12.26	43.18	54.00	-10.82
15870.000	Peak	41.16	12.26	53.42	74.00	-20.58

Unless otherwise stated the results shown in this test report refer only to the sample(s) tested and such sample(s) are retained for 90 days only.

除非另有說明，此報告結果僅對測試之樣品負責，同時此樣品僅保留90天。本報告未經本公司書面許可，不可部份複製。

This document is issued by the Company subject to its General Conditions of Service printed overleaf, available on request or accessible at <http://www.sgs.com.tw/Terms-and-Conditions> and for electronic format documents, subject to Terms and Conditions for Electronic Documents at <http://www.sgs.com.tw/Terms-and-Conditions>. Attention is drawn to the limitation of liability, indemnification and jurisdiction issues defined therein. Any holder of this document is advised that information contained hereon reflects the Company's findings at the time of its intervention only and within the limits of Client's instructions, if any. The Company's sole responsibility is to its Client and this document does not exonerate parties to a transaction from exercising all their rights and obligations under the transaction documents. This document cannot be reproduced except in full, without prior written approval of the Company. Any unauthorized alteration, forgery or falsification of the content or appearance of this document is unlawful and offenders may be prosecuted to the fullest extent of the law.

Report Number :TERF2308001923E2
 Operation Mode :802.11ac80
 Test Frequency :5290 MHz
 Test Mode :Tx
 EUT Pol :E2 Plane

Test Site :SAC G Chamber
 Test Date :2023-10-20
 Temp./Humi. :21.3°C/68%
 Antenna Pol. :Horizontal
 Engineer :Temo Chen

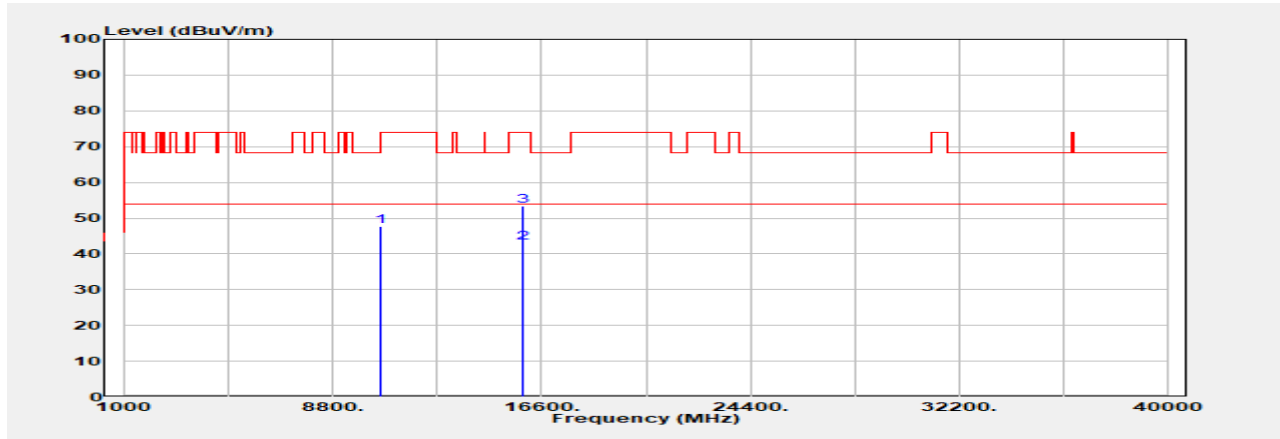

Freq. MHz	Detector Mode PK/QP/AVG	Spectrum Reading Level dBμV	Factor dB	Actual FS dBμV/m	Limit @3m dBμV/m	Margin dB
10580.000	Peak	37.61	9.98	47.59	68.20	-20.61
15870.000	Average	30.92	12.26	43.18	54.00	-10.82
15870.000	Peak	41.05	12.26	53.31	74.00	-20.69

Unless otherwise stated the results shown in this test report refer only to the sample(s) tested and such sample(s) are retained for 90 days only.

除非另有說明，此報告結果僅對測試之樣品負責，同時此樣品僅保留90天。本報告未經本公司書面許可，不可部份複製。

This document is issued by the Company subject to its General Conditions of Service printed overleaf, available on request or accessible at <http://www.sgs.com.tw/Terms-and-Conditions> and for electronic format documents, subject to Terms and Conditions for Electronic Documents at <http://www.sgs.com.tw/Terms-and-Conditions>. Attention is drawn to the limitation of liability, indemnification and jurisdiction issues defined therein. Any holder of this document is advised that information contained hereon reflects the Company's findings at the time of its intervention only and within the limits of Client's instructions, if any. The Company's sole responsibility is to its Client and this document does not exonerate parties to a transaction from exercising all their rights and obligations under the transaction documents. This document cannot be reproduced except in full, without prior written approval of the Company. Any unauthorized alteration, forgery or falsification of the content or appearance of this document is unlawful and offenders may be prosecuted to the fullest extent of the law.

Report Number :TERF2308001923E2
 Operation Mode :802.11ac80
 Test Frequency :5530 MHz
 Test Mode :Tx
 EUT Pol :E2 Plane

Test Site :SAC G Chamber
 Test Date :2023-10-20
 Temp./Humi. :21.3°C/68%
 Antenna Pol. :Vertical
 Engineer :Temo Chen

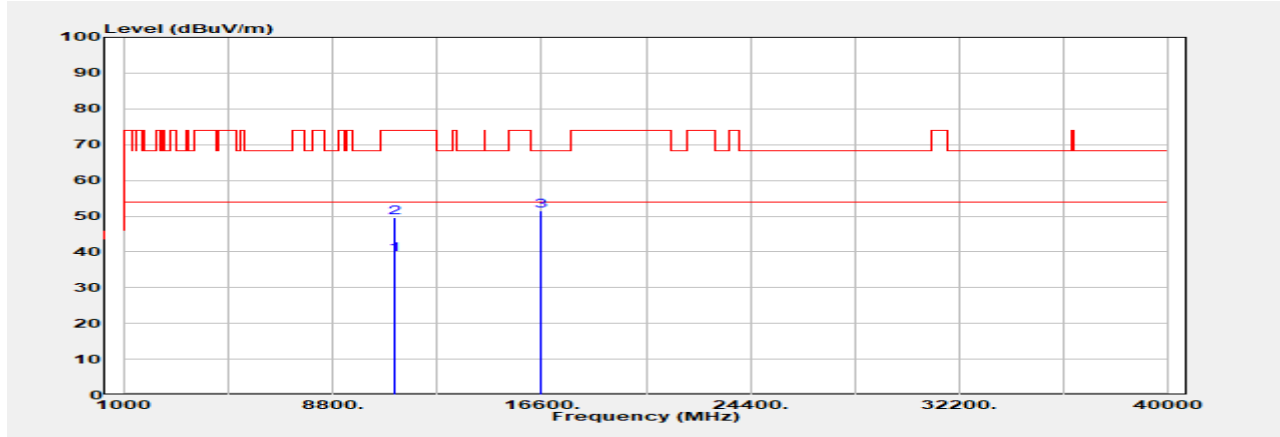

Freq. MHz	Detector Mode PK/QP/AVG	Spectrum Reading Level dBμV	Factor dB	Actual FS dBμV/m	Limit @3m dBμV/m	Margin dB
11060.000	Average	28.65	10.58	39.23	54.00	-14.77
11060.000	Peak	39.09	10.58	49.67	74.00	-24.33
16590.000	Peak	39.67	11.82	51.49	68.20	-16.71

Unless otherwise stated the results shown in this test report refer only to the sample(s) tested and such sample(s) are retained for 90 days only.

除非另有說明，此報告結果僅對測試之樣品負責，同時此樣品僅保留90天。本報告未經本公司書面許可，不可部份複製。

This document is issued by the Company subject to its General Conditions of Service printed overleaf, available on request or accessible at <http://www.sgs.com.tw/Terms-and-Conditions> and for electronic format documents, subject to Terms and Conditions for Electronic Documents at <http://www.sgs.com.tw/Terms-and-Conditions>. Attention is drawn to the limitation of liability, indemnification and jurisdiction issues defined therein. Any holder of this document is advised that information contained hereon reflects the Company's findings at the time of its intervention only and within the limits of Client's instructions, if any. The Company's sole responsibility is to its Client and this document does not exonerate parties to a transaction from exercising all their rights and obligations under the transaction documents. This document cannot be reproduced except in full, without prior written approval of the Company. Any unauthorized alteration, forgery or falsification of the content or appearance of this document is unlawful and offenders may be prosecuted to the fullest extent of the law.

Report Number :TERF2308001923E2
 Operation Mode :802.11ac80
 Test Frequency :5530 MHz
 Test Mode :Tx
 EUT Pol :E2 Plane

Test Site :SAC G Chamber
 Test Date :2023-10-20
 Temp./Humi. :21.3°C/68%
 Antenna Pol. :Horizontal
 Engineer :Temo Chen

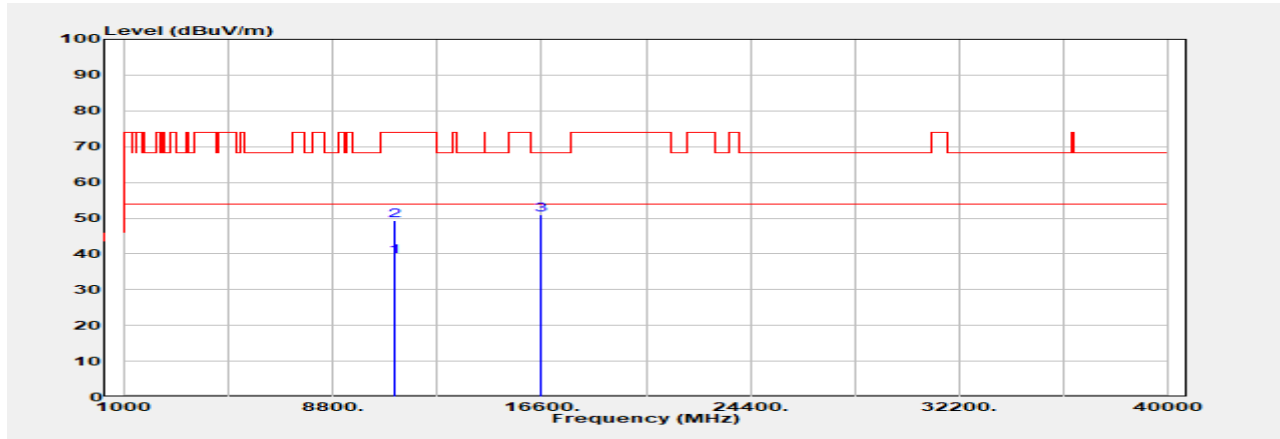

Freq. MHz	Detector Mode PK/QP/AVG	Spectrum Reading Level dBμV	Factor dB	Actual FS dBμV/m	Limit @3m dBμV/m	Margin dB
11060.000	Average	28.74	10.58	39.32	54.00	-14.68
11060.000	Peak	38.62	10.58	49.20	74.00	-24.80
16590.000	Peak	39.17	11.82	50.99	68.20	-17.21

Unless otherwise stated the results shown in this test report refer only to the sample(s) tested and such sample(s) are retained for 90 days only.

除非另有說明，此報告結果僅對測試之樣品負責，同時此樣品僅保留90天。本報告未經本公司書面許可，不可部份複製。

This document is issued by the Company subject to its General Conditions of Service printed overleaf, available on request or accessible at <http://www.sgs.com.tw/Terms-and-Conditions> and for electronic format documents, subject to Terms and Conditions for Electronic Documents at <http://www.sgs.com.tw/Terms-and-Conditions>. Attention is drawn to the limitation of liability, indemnification and jurisdiction issues defined therein. Any holder of this document is advised that information contained hereon reflects the Company's findings at the time of its intervention only and within the limits of Client's instructions, if any. The Company's sole responsibility is to its Client and this document does not exonerate parties to a transaction from exercising all their rights and obligations under the transaction documents. This document cannot be reproduced except in full, without prior written approval of the Company. Any unauthorized alteration, forgery or falsification of the content or appearance of this document is unlawful and offenders may be prosecuted to the fullest extent of the law.

Report Number :TERF2308001923E2

Test Site :SAC G Chamber

Operation Mode :802.11ac80

Test Date :2023-08-26

Test Frequency :5610 MHz

Temp./Humi. :26.9°C/59%

Test Mode :Tx

Antenna Pol. :Vertical

EUT Pol :E2 Plane

Engineer :Temo Chen

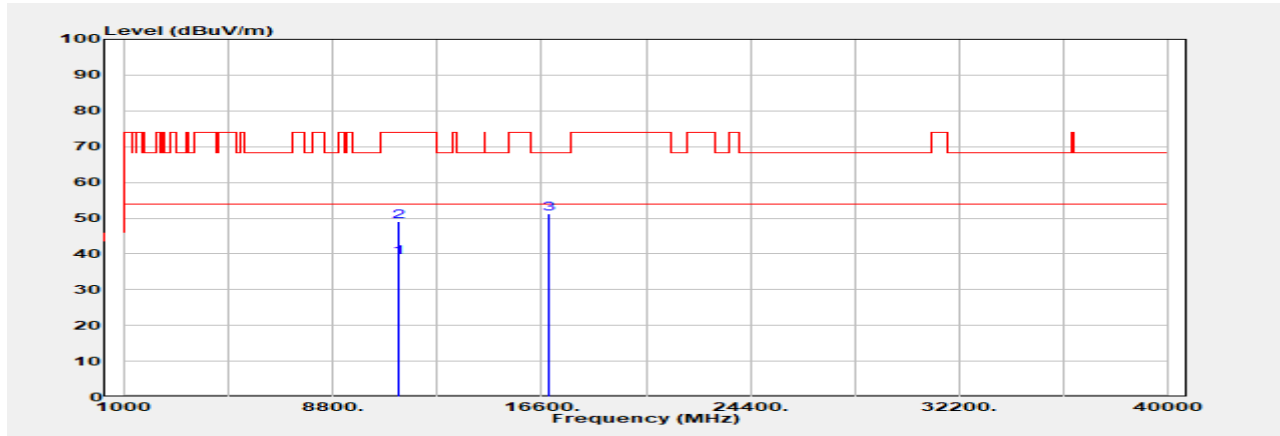

Freq. MHz	Detector Mode PK/QP/AVG	Spectrum Reading Level dBμV	Factor dB	Actual FS dBμV/m	Limit @3m dBμV/m	Margin dB
11220.000	Average	29.03	9.94	38.97	54.00	-15.03
11220.000	Peak	39.08	9.94	49.02	74.00	-24.98
16830.000	Peak	40.06	11.27	51.33	68.20	-16.87

Unless otherwise stated the results shown in this test report refer only to the sample(s) tested and such sample(s) are retained for 90 days only.

除非另有說明，此報告結果僅對測試之樣品負責，同時此樣品僅保留90天。本報告未經本公司書面許可，不可部份複製。

This document is issued by the Company subject to its General Conditions of Service printed overleaf, available on request or accessible at <http://www.sgs.com.tw/Terms-and-Conditions> and for electronic format documents, subject to Terms and Conditions for Electronic Documents at <http://www.sgs.com.tw/Terms-and-Conditions>. Attention is drawn to the limitation of liability, indemnification and jurisdiction issues defined therein. Any holder of this document is advised that information contained hereon reflects the Company's findings at the time of its intervention only and within the limits of Client's instructions, if any. The Company's sole responsibility is to its Client and this document does not exonerate parties to a transaction from exercising all their rights and obligations under the transaction documents. This document cannot be reproduced except in full, without prior written approval of the Company. Any unauthorized alteration, forgery or falsification of the content or appearance of this document is unlawful and offenders may be prosecuted to the fullest extent of the law.

Report Number :TERF2308001923E2
 Operation Mode :802.11ac80
 Test Frequency :5610 MHz
 Test Mode :Tx
 EUT Pol :E2 Plane

Test Site :SAC G Chamber
 Test Date :2023-08-26
 Temp./Humi. :26.9°C/59%
 Antenna Pol. :Horizontal
 Engineer :Temo Chen

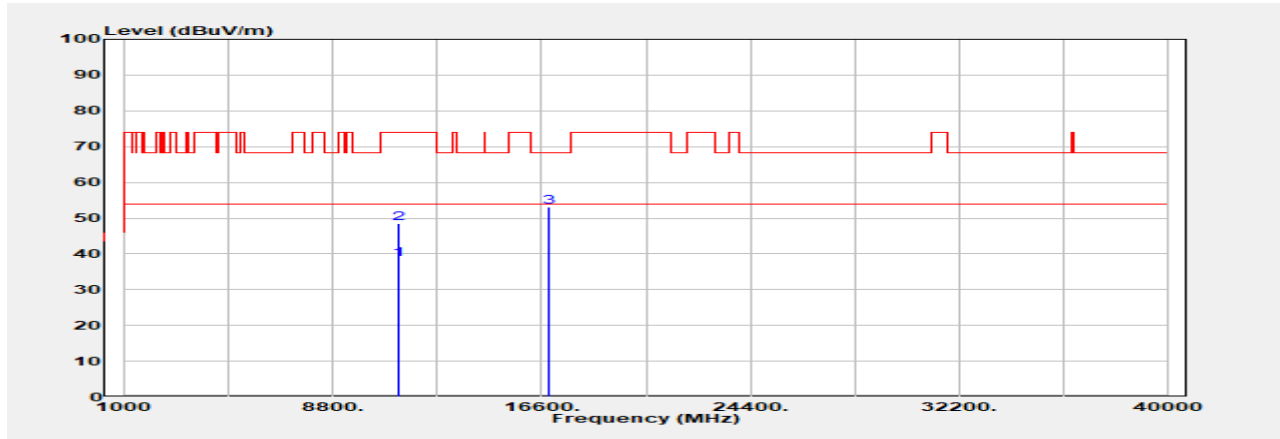

Freq. MHz	Detector Mode PK/QP/AVG	Spectrum Reading Level dBμV	Factor dB	Actual FS dBμV/m	Limit @3m dBμV/m	Margin dB
11220.000	Average	28.43	9.94	38.37	54.00	-15.63
11220.000	Peak	38.52	9.94	48.46	74.00	-25.54
16830.000	Peak	41.94	11.27	53.21	68.20	-14.99

Unless otherwise stated the results shown in this test report refer only to the sample(s) tested and such sample(s) are retained for 90 days only.

除非另有說明，此報告結果僅對測試之樣品負責，同時此樣品僅保留90天。本報告未經本公司書面許可，不可部份複製。

This document is issued by the Company subject to its General Conditions of Service printed overleaf, available on request or accessible at <http://www.sgs.com.tw/Terms-and-Conditions> and for electronic format documents, subject to Terms and Conditions for Electronic Documents at <http://www.sgs.com.tw/Terms-and-Conditions>. Attention is drawn to the limitation of liability, indemnification and jurisdiction issues defined therein. Any holder of this document is advised that information contained hereon reflects the Company's findings at the time of its intervention only and within the limits of Client's instructions, if any. The Company's sole responsibility is to its Client and this document does not exonerate parties to a transaction from exercising all their rights and obligations under the transaction documents. This document cannot be reproduced except in full, without prior written approval of the Company. Any unauthorized alteration, forgery or falsification of the content or appearance of this document is unlawful and offenders may be prosecuted to the fullest extent of the law.

Report Number :TERF2308001923E2

Test Site :SAC G Chamber

Operation Mode :802.11ac80

Test Date :2023-10-20

Test Frequency :5775 MHz

Temp./Humi. :21.3°C/68%

Test Mode :Tx

Antenna Pol. :Vertical

EUT Pol :E2 Plane

Engineer :Temo Chen

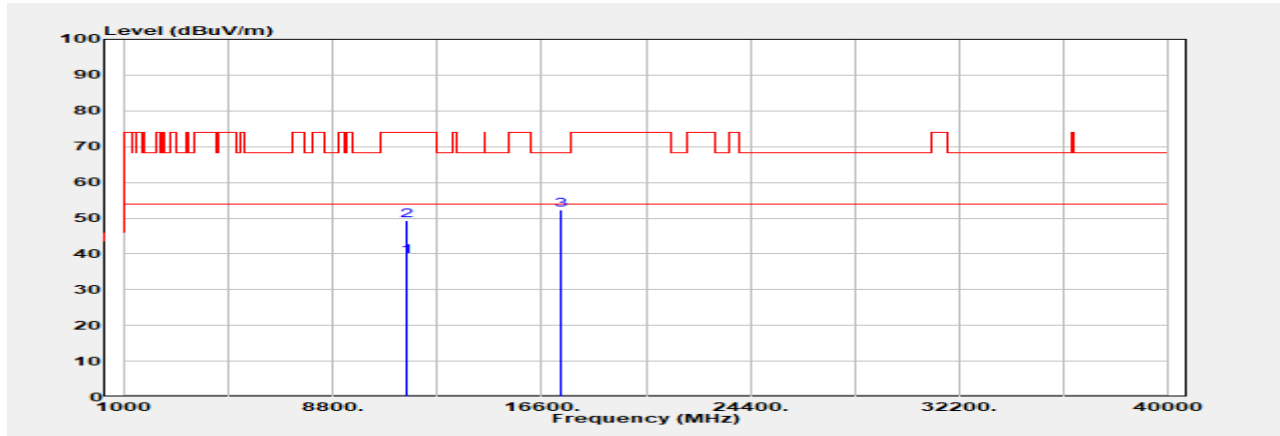

Freq. MHz	Detector Mode PK/QP/AVG	Spectrum Reading Level dBμV	Factor dB	Actual FS dBμV/m	Limit @3m dBμV/m	Margin dB
11550.000	Average	28.87	10.45	39.32	54.00	-14.68
11550.000	Peak	38.91	10.45	49.36	74.00	-24.64
17325.000	Peak	40.68	11.70	52.38	68.20	-15.82

Unless otherwise stated the results shown in this test report refer only to the sample(s) tested and such sample(s) are retained for 90 days only.

除非另有說明，此報告結果僅對測試之樣品負責，同時此樣品僅保留90天。本報告未經本公司書面許可，不可部份複製。

This document is issued by the Company subject to its General Conditions of Service printed overleaf, available on request or accessible at <http://www.sgs.com.tw/Terms-and-Conditions> and for electronic format documents, subject to Terms and Conditions for Electronic Documents at <http://www.sgs.com.tw/Terms-and-Conditions>. Attention is drawn to the limitation of liability, indemnification and jurisdiction issues defined therein. Any holder of this document is advised that information contained hereon reflects the Company's findings at the time of its intervention only and within the limits of Client's instructions, if any. The Company's sole responsibility is to its Client and this document does not exonerate parties to a transaction from exercising all their rights and obligations under the transaction documents. This document cannot be reproduced except in full, without prior written approval of the Company. Any unauthorized alteration, forgery or falsification of the content or appearance of this document is unlawful and offenders may be prosecuted to the fullest extent of the law.

Report Number :TERF2308001923E2

Test Site :SAC G Chamber

Operation Mode :802.11ac80

Test Date :2023-10-20

Test Frequency :5775 MHz

Temp./Humi. :21.3°C/68%

Test Mode :Tx

Antenna Pol. :Horizontal

EUT Pol :E2 Plane

Engineer :Temo Chen

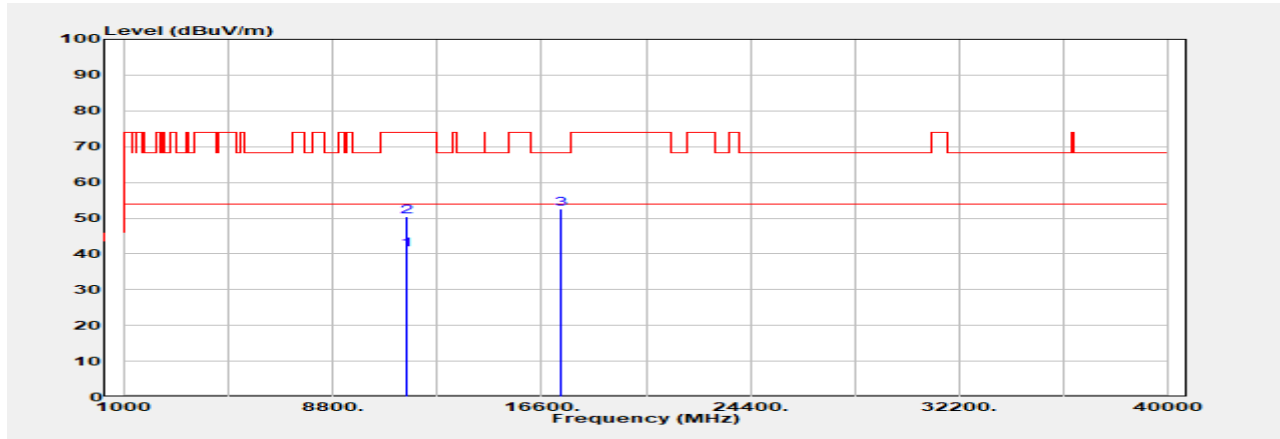

Freq. MHz	Detector Mode PK/QP/AVG	Spectrum Reading Level dBμV	Factor dB	Actual FS dBμV/m	Limit @3m dBμV/m	Margin dB
11550.000	Average	30.68	10.45	41.13	54.00	-12.87
11550.000	Peak	39.86	10.45	50.31	74.00	-23.69
17325.000	Peak	40.78	11.70	52.48	68.20	-15.72

Unless otherwise stated the results shown in this test report refer only to the sample(s) tested and such sample(s) are retained for 90 days only.

除非另有說明，此報告結果僅對測試之樣品負責，同時此樣品僅保留90天。本報告未經本公司書面許可，不可部份複製。

This document is issued by the Company subject to its General Conditions of Service printed overleaf, available on request or accessible at <http://www.sgs.com.tw/Terms-and-Conditions> and for electronic format documents, subject to Terms and Conditions for Electronic Documents at <http://www.sgs.com.tw/Terms-and-Conditions>. Attention is drawn to the limitation of liability, indemnification and jurisdiction issues defined therein. Any holder of this document is advised that information contained hereon reflects the Company's findings at the time of its intervention only and within the limits of Client's instructions, if any. The Company's sole responsibility is to its Client and this document does not exonerate parties to a transaction from exercising all their rights and obligations under the transaction documents. This document cannot be reproduced except in full, without prior written approval of the Company. Any unauthorized alteration, forgery or falsification of the content or appearance of this document is unlawful and offenders may be prosecuted to the fullest extent of the law.

Report Number :TERF2308001923E2
 Operation Mode :802.11ac160
 Test Frequency :5250 MHz
 Test Mode :Tx
 EUT Pol :E2 Plane

Test Site :SAC G Chamber
 Test Date :2023-10-20
 Temp./Humi. :21.3°C/68%
 Antenna Pol. :Vertical
 Engineer :Temo Chen

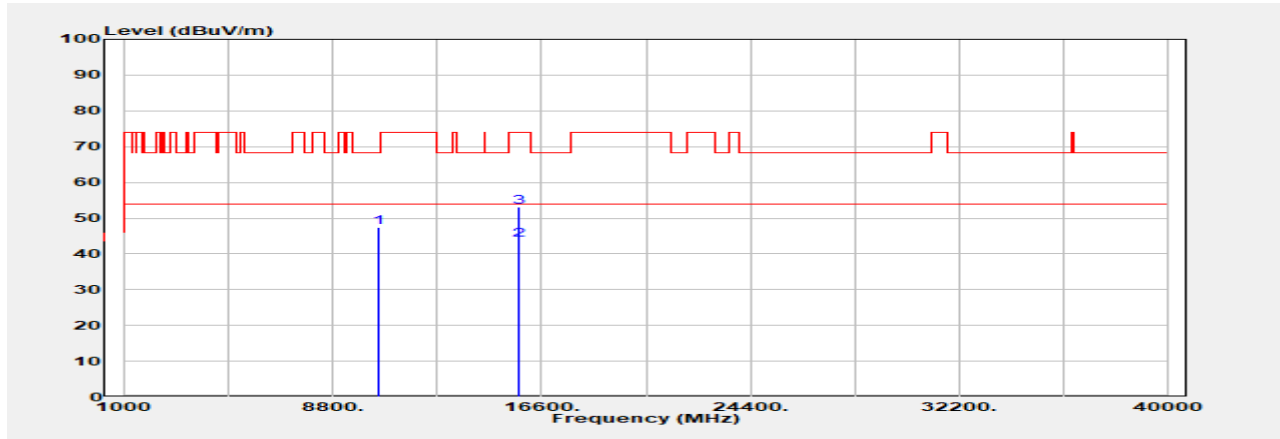

Freq. MHz	Detector Mode PK/QP/AVG	Spectrum Reading Level dB μ V	Factor dB	Actual FS dB μ V/m	Limit @3m dB μ V/m	Margin dB
10500.000	Peak	37.65	9.90	47.55	68.20	-20.65
15750.000	Average	31.37	12.50	43.87	54.00	-10.13
15750.000	Peak	40.56	12.50	53.06	74.00	-20.94

Unless otherwise stated the results shown in this test report refer only to the sample(s) tested and such sample(s) are retained for 90 days only.

除非另有說明，此報告結果僅對測試之樣品負責，同時此樣品僅保留90天。本報告未經本公司書面許可，不可部份複製。

This document is issued by the Company subject to its General Conditions of Service printed overleaf, available on request or accessible at <http://www.sgs.com.tw/Terms-and-Conditions> and for electronic format documents, subject to Terms and Conditions for Electronic Documents at <http://www.sgs.com.tw/Terms-and-Conditions>. Attention is drawn to the limitation of liability, indemnification and jurisdiction issues defined therein. Any holder of this document is advised that information contained hereon reflects the Company's findings at the time of its intervention only and within the limits of Client's instructions, if any. The Company's sole responsibility is to its Client and this document does not exonerate parties to a transaction from exercising all their rights and obligations under the transaction documents. This document cannot be reproduced except in full, without prior written approval of the Company. Any unauthorized alteration, forgery or falsification of the content or appearance of this document is unlawful and offenders may be prosecuted to the fullest extent of the law.

Report Number :TERF2308001923E2
 Operation Mode :802.11ac160
 Test Frequency :5250 MHz
 Test Mode :Tx
 EUT Pol :E2 Plane

Test Site :SAC G Chamber
 Test Date :2023-10-20
 Temp./Humi. :21.3°C/68%
 Antenna Pol. :Horizontal
 Engineer :Temo Chen

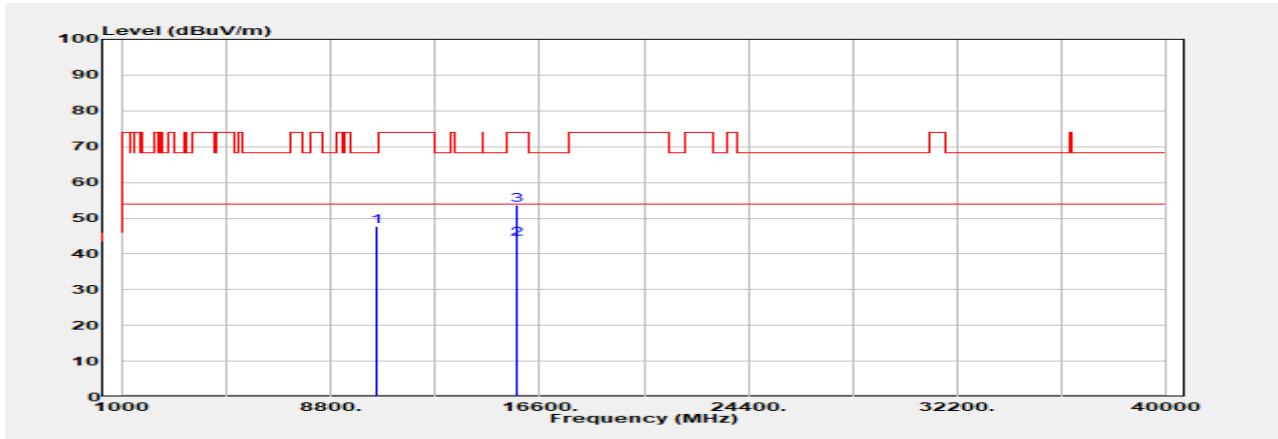

Freq. MHz	Detector Mode PK/QP/AVG	Spectrum Reading Level dB μ V	Factor dB	Actual FS dB μ V/m	Limit @3m dB μ V/m	Margin dB
10500.000	Peak	37.83	9.90	47.73	68.20	-20.47
15750.000	Average	31.54	12.50	44.04	54.00	-9.96
15750.000	Peak	41.10	12.50	53.60	74.00	-20.40

Unless otherwise stated the results shown in this test report refer only to the sample(s) tested and such sample(s) are retained for 90 days only.

除非另有說明，此報告結果僅對測試之樣品負責，同時此樣品僅保留90天。本報告未經本公司書面許可，不可部份複製。

This document is issued by the Company subject to its General Conditions of Service printed overleaf, available on request or accessible at <http://www.sgs.com.tw/Terms-and-Conditions> and for electronic format documents, subject to Terms and Conditions for Electronic Documents at <http://www.sgs.com.tw/Terms-and-Conditions>. Attention is drawn to the limitation of liability, indemnification and jurisdiction issues defined therein. Any holder of this document is advised that information contained hereon reflects the Company's findings at the time of its intervention only and within the limits of Client's instructions, if any. The Company's sole responsibility is to its Client and this document does not exonerate parties to a transaction from exercising all their rights and obligations under the transaction documents. This document cannot be reproduced except in full, without prior written approval of the Company. Any unauthorized alteration, forgery or falsification of the content or appearance of this document is unlawful and offenders may be prosecuted to the fullest extent of the law.

Report Number :TERF2308001923E2
 Operation Mode :802.11ac160
 Test Frequency :5570 MHz
 Test Mode :Tx
 EUT Pol :E2 Plane

Test Site :SAC G Chamber
 Test Date :2023-10-20
 Temp./Humi. :21.3°C/68%
 Antenna Pol. :Vertical
 Engineer :Temo Chen

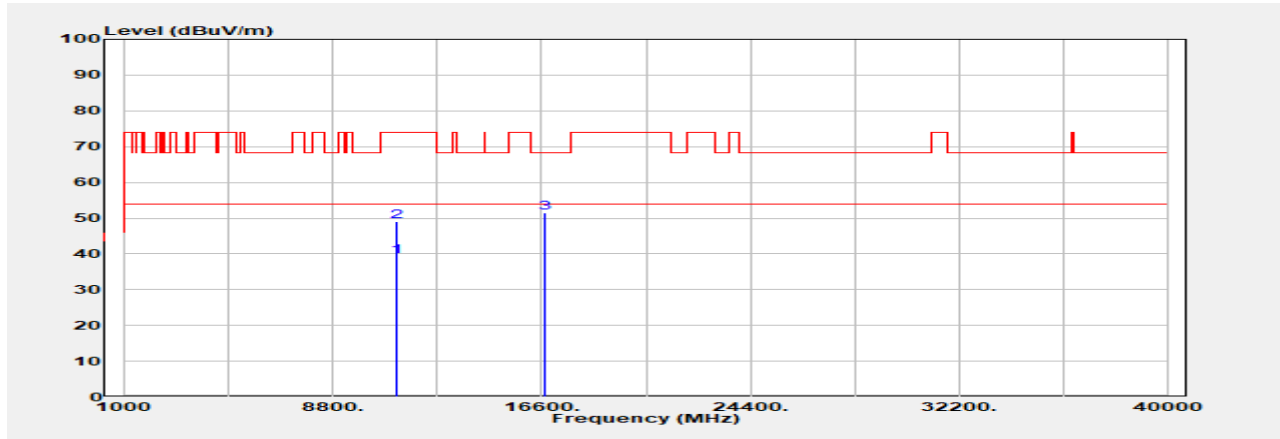

Freq. MHz	Detector Mode PK/QP/AVG	Spectrum Reading Level dBμV	Factor dB	Actual FS dBμV/m	Limit @3m dBμV/m	Margin dB
11140.000	Average	29.38	9.82	39.20	54.00	-14.80
11140.000	Peak	39.34	9.82	49.16	74.00	-24.84
16710.000	Peak	39.83	11.69	51.52	68.20	-16.68

Unless otherwise stated the results shown in this test report refer only to the sample(s) tested and such sample(s) are retained for 90 days only.

除非另有說明，此報告結果僅對測試之樣品負責，同時此樣品僅保留90天。本報告未經本公司書面許可，不可部份複製。

This document is issued by the Company subject to its General Conditions of Service printed overleaf, available on request or accessible at <http://www.sgs.com.tw/Terms-and-Conditions> and for electronic format documents, subject to Terms and Conditions for Electronic Documents at <http://www.sgs.com.tw/Terms-and-Conditions>. Attention is drawn to the limitation of liability, indemnification and jurisdiction issues defined therein. Any holder of this document is advised that information contained hereon reflects the Company's findings at the time of its intervention only and within the limits of Client's instructions, if any. The Company's sole responsibility is to its Client and this document does not exonerate parties to a transaction from exercising all their rights and obligations under the transaction documents. This document cannot be reproduced except in full, without prior written approval of the Company. Any unauthorized alteration, forgery or falsification of the content or appearance of this document is unlawful and offenders may be prosecuted to the fullest extent of the law.

Report Number :TERF2308001923E2
 Operation Mode :802.11ac160
 Test Frequency :5570 MHz
 Test Mode :Tx
 EUT Pol :E2 Plane

Test Site :SAC G Chamber
 Test Date :2023-10-20
 Temp./Humi. :21.3°C/68%
 Antenna Pol. :Horizontal
 Engineer :Temo Chen

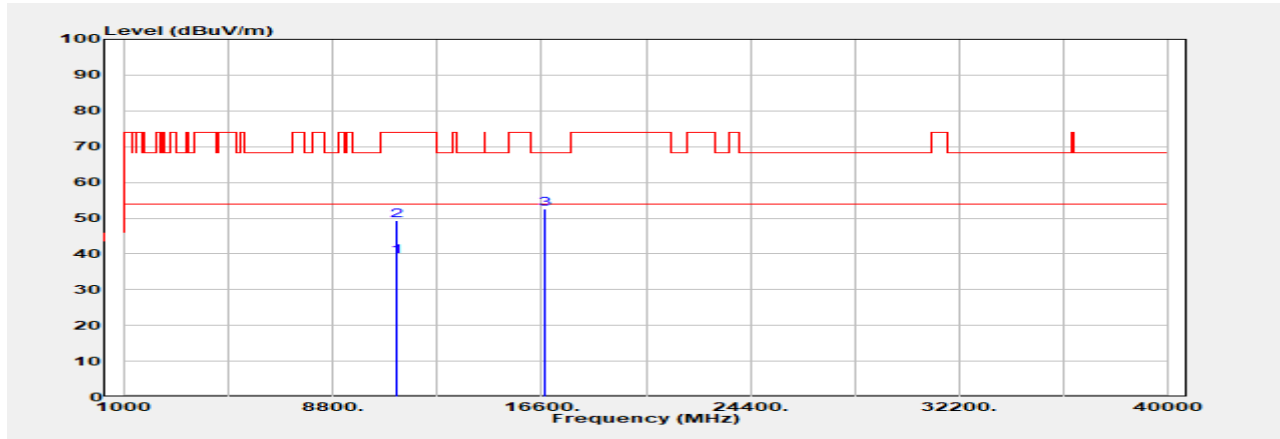

Freq. MHz	Detector Mode PK/QP/AVG	Spectrum Reading Level dB μ V	Factor dB	Actual FS dB μ V/m	Limit @3m dB μ V/m	Margin dB
11140.000	Average	29.49	9.82	39.31	54.00	-14.69
11140.000	Peak	39.38	9.82	49.20	74.00	-24.80
16710.000	Peak	40.77	11.69	52.46	68.20	-15.74

Unless otherwise stated the results shown in this test report refer only to the sample(s) tested and such sample(s) are retained for 90 days only.

除非另有說明，此報告結果僅對測試之樣品負責，同時此樣品僅保留90天。本報告未經本公司書面許可，不可部份複製。

This document is issued by the Company subject to its General Conditions of Service printed overleaf, available on request or accessible at <http://www.sgs.com.tw/Terms-and-Conditions> and for electronic format documents, subject to Terms and Conditions for Electronic Documents at <http://www.sgs.com.tw/Terms-and-Conditions>. Attention is drawn to the limitation of liability, indemnification and jurisdiction issues defined therein. Any holder of this document is advised that information contained hereon reflects the Company's findings at the time of its intervention only and within the limits of Client's instructions, if any. The Company's sole responsibility is to its Client and this document does not exonerate parties to a transaction from exercising all their rights and obligations under the transaction documents. This document cannot be reproduced except in full, without prior written approval of the Company. Any unauthorized alteration, forgery or falsification of the content or appearance of this document is unlawful and offenders may be prosecuted to the fullest extent of the law.

Report Number :TERF2308001923E2
 Operation Mode :802.11be20
 Test Frequency :5180 MHz
 Test Mode :Tx
 EUT Pol :E2 Plane

Test Site :SAC G Chamber
 Test Date :2023-10-20
 Temp./Humi. :21.3°C/68%
 Antenna Pol. :Vertical
 Engineer :Temo Chen

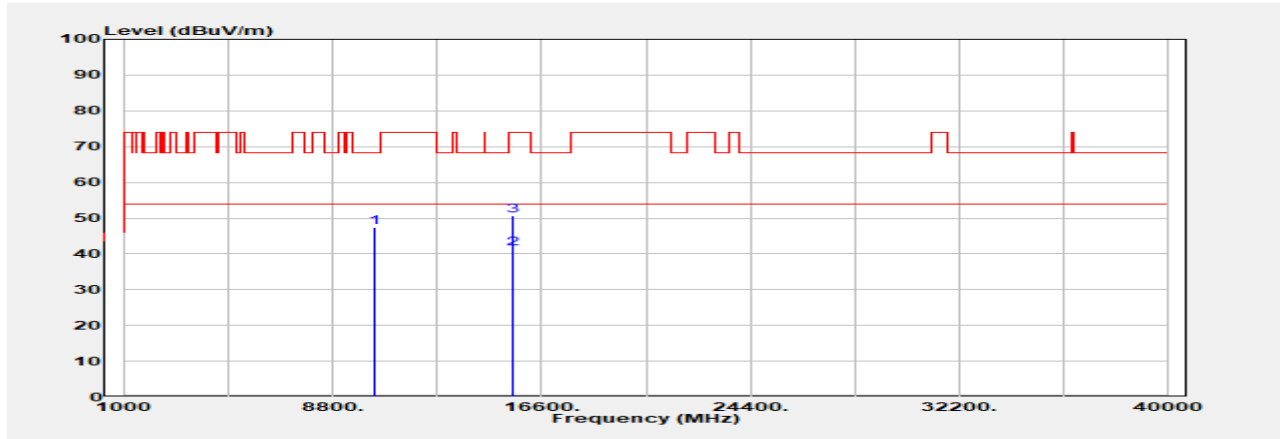

Freq. MHz	Detector Mode PK/QP/AVG	Spectrum Reading Level dB μ V	Factor dB	Actual FS dB μ V/m	Limit @3m dB μ V/m	Margin dB
10360.000	Peak	37.95	9.38	47.33	68.20	-20.87
15540.000	Average	29.48	11.96	41.44	54.00	-12.56
15540.000	Peak	38.80	11.96	50.76	74.00	-23.24

Unless otherwise stated the results shown in this test report refer only to the sample(s) tested and such sample(s) are retained for 90 days only.

除非另有說明，此報告結果僅對測試之樣品負責，同時此樣品僅保留90天。本報告未經本公司書面許可，不可部份複製。

This document is issued by the Company subject to its General Conditions of Service printed overleaf, available on request or accessible at <http://www.sgs.com.tw/Terms-and-Conditions> and for electronic format documents, subject to Terms and Conditions for Electronic Documents at <http://www.sgs.com.tw/Terms-and-Conditions>. Attention is drawn to the limitation of liability, indemnification and jurisdiction issues defined therein. Any holder of this document is advised that information contained hereon reflects the Company's findings at the time of its intervention only and within the limits of Client's instructions, if any. The Company's sole responsibility is to its Client and this document does not exonerate parties to a transaction from exercising all their rights and obligations under the transaction documents. This document cannot be reproduced except in full, without prior written approval of the Company. Any unauthorized alteration, forgery or falsification of the content or appearance of this document is unlawful and offenders may be prosecuted to the fullest extent of the law.

Report Number :TERF2308001923E2
 Operation Mode :802.11be20
 Test Frequency :5180 MHz
 Test Mode :Tx
 EUT Pol :E2 Plane

Test Site :SAC G Chamber
 Test Date :2023-10-20
 Temp./Humi. :21.3°C/68%
 Antenna Pol. :Horizontal
 Engineer :Temo Chen

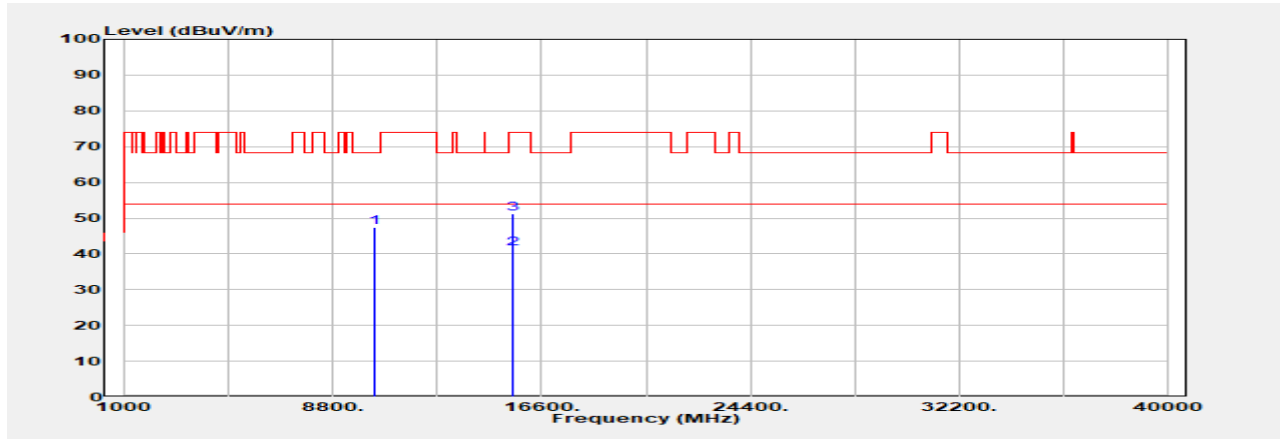

Freq. MHz	Detector Mode PK/QP/AVG	Spectrum Reading Level dB μ V	Factor dB	Actual FS dB μ V/m	Limit @3m dB μ V/m	Margin dB
10360.000	Peak	37.97	9.38	47.35	68.20	-20.85
15540.000	Average	29.44	11.96	41.40	54.00	-12.60
15540.000	Peak	39.29	11.96	51.25	74.00	-22.75

Unless otherwise stated the results shown in this test report refer only to the sample(s) tested and such sample(s) are retained for 90 days only.

除非另有說明，此報告結果僅對測試之樣品負責，同時此樣品僅保留90天。本報告未經本公司書面許可，不可部份複製。

This document is issued by the Company subject to its General Conditions of Service printed overleaf, available on request or accessible at <http://www.sgs.com.tw/Terms-and-Conditions> and for electronic format documents, subject to Terms and Conditions for Electronic Documents at <http://www.sgs.com.tw/Terms-and-Conditions>. Attention is drawn to the limitation of liability, indemnification and jurisdiction issues defined therein. Any holder of this document is advised that information contained hereon reflects the Company's findings at the time of its intervention only and within the limits of Client's instructions, if any. The Company's sole responsibility is to its Client and this document does not exonerate parties to a transaction from exercising all their rights and obligations under the transaction documents. This document cannot be reproduced except in full, without prior written approval of the Company. Any unauthorized alteration, forgery or falsification of the content or appearance of this document is unlawful and offenders may be prosecuted to the fullest extent of the law.

Report Number :TERF2308001923E2

Test Site :SAC G Chamber

Operation Mode :802.11be20

Test Date :2023-08-25

Test Frequency :5220 MHz

Temp./Humi. :25.9°C/57%

Test Mode :Tx

Antenna Pol. :Vertical

EUT Pol :E2 Plane

Engineer :Temo Chen

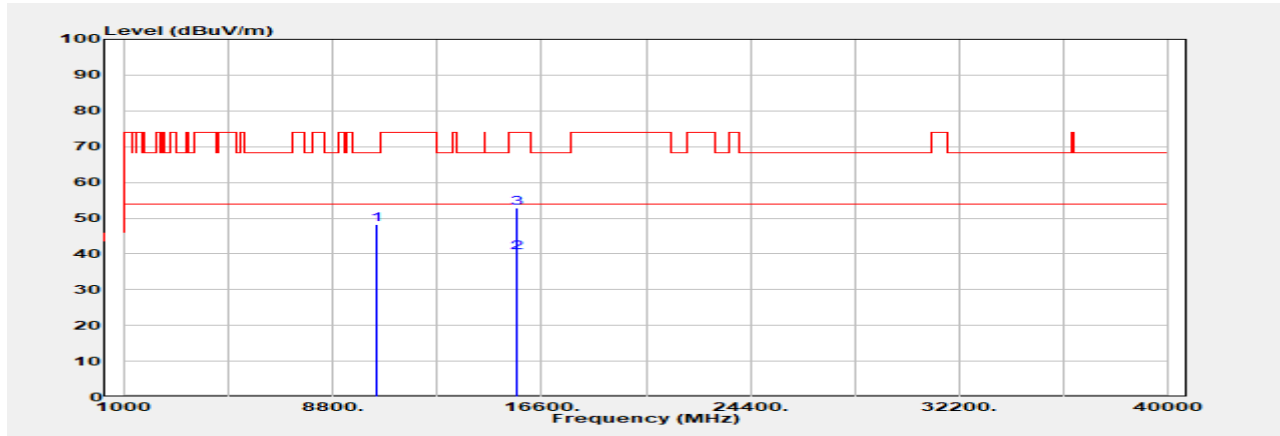

Freq. MHz	Detector Mode PK/QP/AVG	Spectrum Reading Level dB μ V	Factor dB	Actual FS dB μ V/m	Limit @3m dB μ V/m	Margin dB
10440.000	Peak	38.66	9.66	48.32	68.20	-19.88
15660.000	Average	28.15	12.32	40.47	54.00	-13.53
15660.000	Peak	40.52	12.32	52.84	74.00	-21.16

Unless otherwise stated the results shown in this test report refer only to the sample(s) tested and such sample(s) are retained for 90 days only.

除非另有說明，此報告結果僅對測試之樣品負責，同時此樣品僅保留90天。本報告未經本公司書面許可，不可部份複製。

This document is issued by the Company subject to its General Conditions of Service printed overleaf, available on request or accessible at <http://www.sgs.com.tw/Terms-and-Conditions> and for electronic format documents, subject to Terms and Conditions for Electronic Documents at <http://www.sgs.com.tw/Terms-and-Conditions>. Attention is drawn to the limitation of liability, indemnification and jurisdiction issues defined therein. Any holder of this document is advised that information contained hereon reflects the Company's findings at the time of its intervention only and within the limits of Client's instructions, if any. The Company's sole responsibility is to its Client and this document does not exonerate parties to a transaction from exercising all their rights and obligations under the transaction documents. This document cannot be reproduced except in full, without prior written approval of the Company. Any unauthorized alteration, forgery or falsification of the content or appearance of this document is unlawful and offenders may be prosecuted to the fullest extent of the law.

Report Number :TERF2308001923E2

Test Site :SAC G Chamber

Operation Mode :802.11be20

Test Date :2023-08-25

Test Frequency :5220 MHz

Temp./Humi. :25.9°C/57%

Test Mode :Tx

Antenna Pol. :Horizontal

EUT Pol :E2 Plane

Engineer :Temo Chen

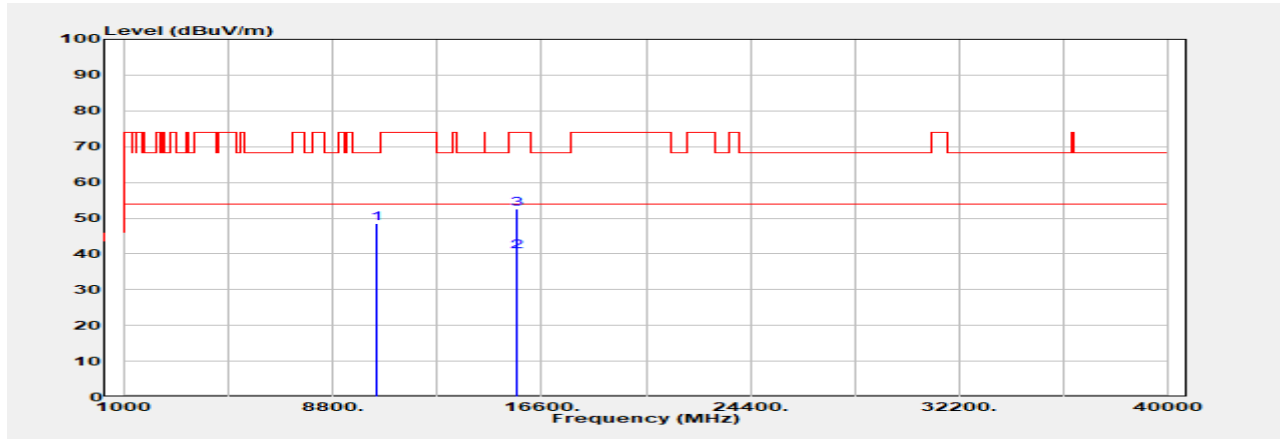

Freq. MHz	Detector Mode PK/QP/AVG	Spectrum Reading Level dBμV	Factor dB	Actual FS dBμV/m	Limit @3m dBμV/m	Margin dB
10440.000	Peak	38.75	9.66	48.41	68.20	-19.79
15660.000	Average	28.25	12.32	40.57	54.00	-13.43
15660.000	Peak	40.36	12.32	52.68	74.00	-21.32

Unless otherwise stated the results shown in this test report refer only to the sample(s) tested and such sample(s) are retained for 90 days only.

除非另有說明，此報告結果僅對測試之樣品負責，同時此樣品僅保留90天。本報告未經本公司書面許可，不可部份複製。

This document is issued by the Company subject to its General Conditions of Service printed overleaf, available on request or accessible at <http://www.sgs.com.tw/Terms-and-Conditions> and for electronic format documents, subject to Terms and Conditions for Electronic Documents at <http://www.sgs.com.tw/Terms-and-Conditions>. Attention is drawn to the limitation of liability, indemnification and jurisdiction issues defined therein. Any holder of this document is advised that information contained hereon reflects the Company's findings at the time of its intervention only and within the limits of Client's instructions, if any. The Company's sole responsibility is to its Client and this document does not exonerate parties to a transaction from exercising all their rights and obligations under the transaction documents. This document cannot be reproduced except in full, without prior written approval of the Company. Any unauthorized alteration, forgery or falsification of the content or appearance of this document is unlawful and offenders may be prosecuted to the fullest extent of the law.

Report Number :TERF2308001923E2
 Operation Mode :802.11be20
 Test Frequency :5240 MHz
 Test Mode :Tx
 EUT Pol :E2 Plane

Test Site :SAC G Chamber
 Test Date :2023-08-25
 Temp./Humi. :25.9°C/57%
 Antenna Pol. :Vertical
 Engineer :Temo Chen

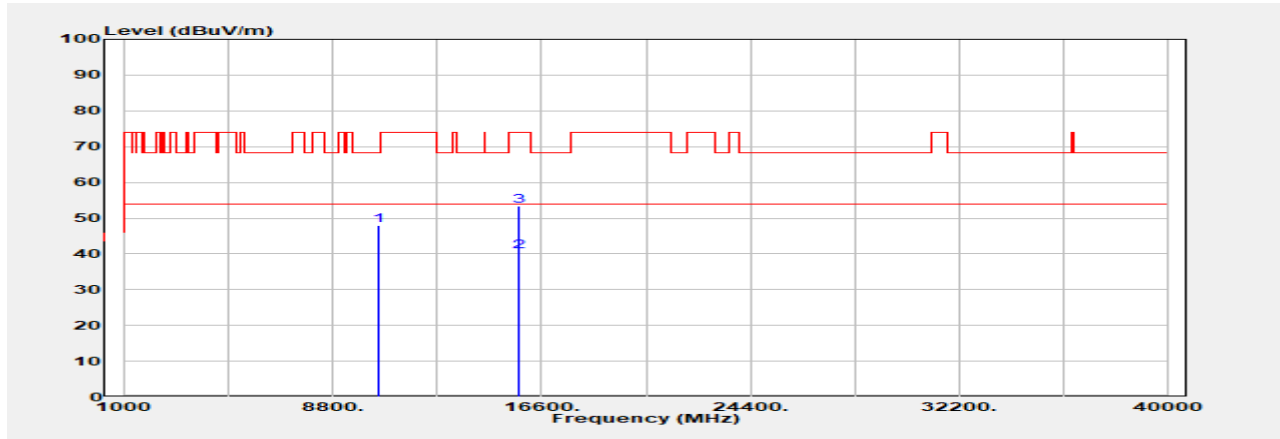

Freq. MHz	Detector Mode PK/QP/AVG	Spectrum Reading Level dB μ V	Factor dB	Actual FS dB μ V/m	Limit @3m dB μ V/m	Margin dB
10480.000	Peak	38.26	9.82	48.08	68.20	-20.12
15720.000	Average	28.13	12.56	40.69	54.00	-13.31
15720.000	Peak	40.77	12.56	53.33	74.00	-20.67

Unless otherwise stated the results shown in this test report refer only to the sample(s) tested and such sample(s) are retained for 90 days only.

除非另有說明，此報告結果僅對測試之樣品負責，同時此樣品僅保留90天。本報告未經本公司書面許可，不可部份複製。

This document is issued by the Company subject to its General Conditions of Service printed overleaf, available on request or accessible at <http://www.sgs.com.tw/Terms-and-Conditions> and for electronic format documents, subject to Terms and Conditions for Electronic Documents at <http://www.sgs.com.tw/Terms-and-Conditions>. Attention is drawn to the limitation of liability, indemnification and jurisdiction issues defined therein. Any holder of this document is advised that information contained hereon reflects the Company's findings at the time of its intervention only and within the limits of Client's instructions, if any. The Company's sole responsibility is to its Client and this document does not exonerate parties to a transaction from exercising all their rights and obligations under the transaction documents. This document cannot be reproduced except in full, without prior written approval of the Company. Any unauthorized alteration, forgery or falsification of the content or appearance of this document is unlawful and offenders may be prosecuted to the fullest extent of the law.

Report Number :TERF2308001923E2
 Operation Mode :802.11be20
 Test Frequency :5240 MHz
 Test Mode :Tx
 EUT Pol :E2 Plane

Test Site :SAC G Chamber
 Test Date :2023-08-25
 Temp./Humi. :25.9°C/57%
 Antenna Pol. :Horizontal
 Engineer :Temo Chen

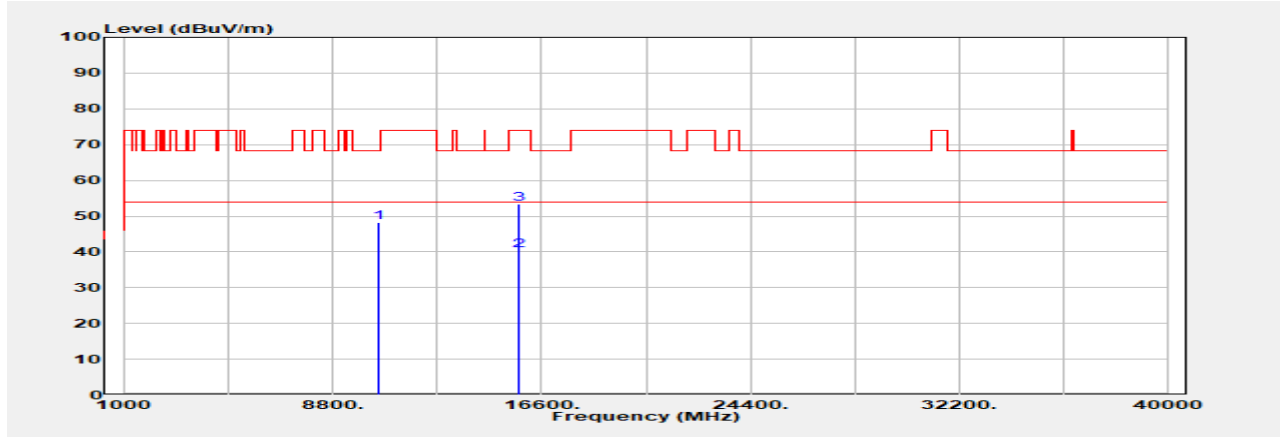

Freq. MHz	Detector Mode PK/QP/AVG	Spectrum Reading Level dB μ V	Factor dB	Actual FS dB μ V/m	Limit @3m dB μ V/m	Margin dB
10480.000	Peak	38.44	9.82	48.26	68.20	-19.94
15720.000	Average	27.95	12.56	40.51	54.00	-13.49
15720.000	Peak	40.72	12.56	53.28	74.00	-20.72

Unless otherwise stated the results shown in this test report refer only to the sample(s) tested and such sample(s) are retained for 90 days only.

除非另有說明，此報告結果僅對測試之樣品負責，同時此樣品僅保留90天。本報告未經本公司書面許可，不可部份複製。

This document is issued by the Company subject to its General Conditions of Service printed overleaf, available on request or accessible at <http://www.sgs.com.tw/Terms-and-Conditions> and for electronic format documents, subject to Terms and Conditions for Electronic Documents at <http://www.sgs.com.tw/Terms-and-Conditions>. Attention is drawn to the limitation of liability, indemnification and jurisdiction issues defined therein. Any holder of this document is advised that information contained hereon reflects the Company's findings at the time of its intervention only and within the limits of Client's instructions, if any. The Company's sole responsibility is to its Client and this document does not exonerate parties to a transaction from exercising all their rights and obligations under the transaction documents. This document cannot be reproduced except in full, without prior written approval of the Company. Any unauthorized alteration, forgery or falsification of the content or appearance of this document is unlawful and offenders may be prosecuted to the fullest extent of the law.

Report Number :TERF2308001923E2

Test Site :SAC G Chamber

Operation Mode :802.11be20

Test Date :2023-08-25

Test Frequency :5260 MHz

Temp./Humi. :25.9°C/57%

Test Mode :Tx

Antenna Pol. :Vertical

EUT Pol :E2 Plane

Engineer :Temo Chen

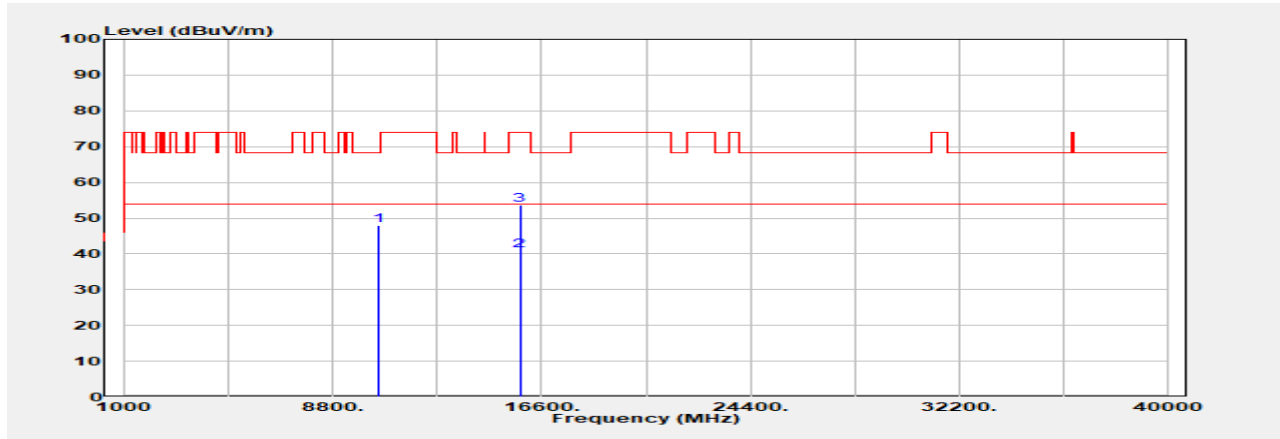

Freq. MHz	Detector Mode PK/QP/AVG	Spectrum Reading Level dB μ V	Factor dB	Actual FS dB μ V/m	Limit @3m dB μ V/m	Margin dB
10520.000	Peak	38.02	9.92	47.94	68.20	-20.26
15780.000	Average	28.44	12.44	40.88	54.00	-13.12
15780.000	Peak	41.28	12.44	53.72	74.00	-20.28

Unless otherwise stated the results shown in this test report refer only to the sample(s) tested and such sample(s) are retained for 90 days only.

除非另有說明，此報告結果僅對測試之樣品負責，同時此樣品僅保留90天。本報告未經本公司書面許可，不可部份複製。

This document is issued by the Company subject to its General Conditions of Service printed overleaf, available on request or accessible at <http://www.sgs.com.tw/Terms-and-Conditions> and for electronic format documents, subject to Terms and Conditions for Electronic Documents at <http://www.sgs.com.tw/Terms-and-Conditions>. Attention is drawn to the limitation of liability, indemnification and jurisdiction issues defined therein. Any holder of this document is advised that information contained hereon reflects the Company's findings at the time of its intervention only and within the limits of Client's instructions, if any. The Company's sole responsibility is to its Client and this document does not exonerate parties to a transaction from exercising all their rights and obligations under the transaction documents. This document cannot be reproduced except in full, without prior written approval of the Company. Any unauthorized alteration, forgery or falsification of the content or appearance of this document is unlawful and offenders may be prosecuted to the fullest extent of the law.

Report Number :TERF2308001923E2
 Operation Mode :802.11be20
 Test Frequency :5260 MHz
 Test Mode :Tx
 EUT Pol :E2 Plane

Test Site :SAC G Chamber
 Test Date :2023-08-25
 Temp./Humi. :25.9°C/57%
 Antenna Pol. :Horizontal
 Engineer :Temo Chen

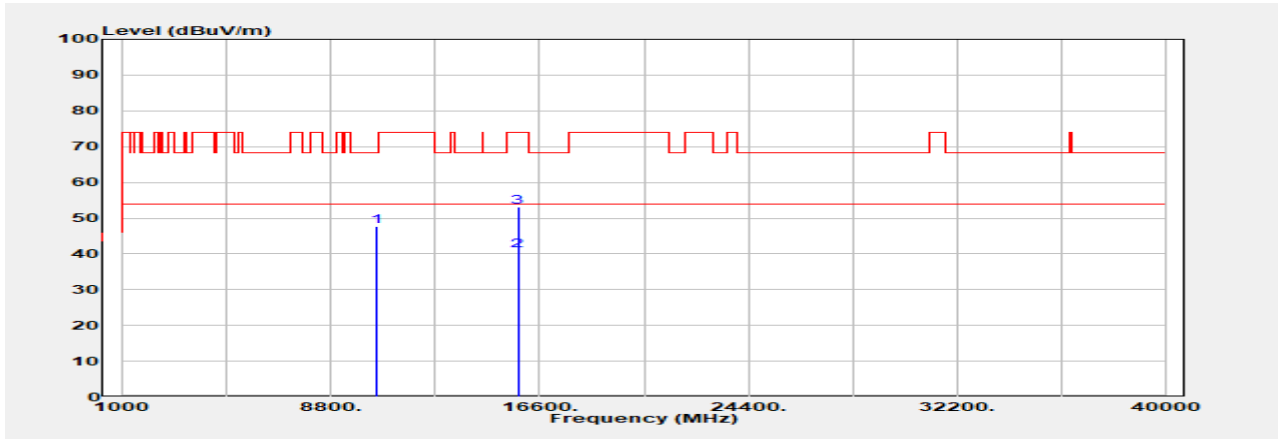

Freq. MHz	Detector Mode PK/QP/AVG	Spectrum Reading Level dB μ V	Factor dB	Actual FS dB μ V/m	Limit @3m dB μ V/m	Margin dB
10520.000	Peak	37.74	9.92	47.66	68.20	-20.54
15780.000	Average	28.57	12.44	41.01	54.00	-12.99
15780.000	Peak	40.81	12.44	53.25	74.00	-20.75

Unless otherwise stated the results shown in this test report refer only to the sample(s) tested and such sample(s) are retained for 90 days only.

除非另有說明，此報告結果僅對測試之樣品負責，同時此樣品僅保留90天。本報告未經本公司書面許可，不可部份複製。

This document is issued by the Company subject to its General Conditions of Service printed overleaf, available on request or accessible at <http://www.sgs.com.tw/Terms-and-Conditions> and for electronic format documents, subject to Terms and Conditions for Electronic Documents at <http://www.sgs.com.tw/Terms-and-Conditions>. Attention is drawn to the limitation of liability, indemnification and jurisdiction issues defined therein. Any holder of this document is advised that information contained hereon reflects the Company's findings at the time of its intervention only and within the limits of Client's instructions, if any. The Company's sole responsibility is to its Client and this document does not exonerate parties to a transaction from exercising all their rights and obligations under the transaction documents. This document cannot be reproduced except in full, without prior written approval of the Company. Any unauthorized alteration, forgery or falsification of the content or appearance of this document is unlawful and offenders may be prosecuted to the fullest extent of the law.

Report Number :TERF2308001923E2
 Operation Mode :802.11be20
 Test Frequency :5300 MHz
 Test Mode :Tx
 EUT Pol :E2 Plane

Test Site :SAC G Chamber
 Test Date :2023-08-25
 Temp./Humi. :25.9°C/57%
 Antenna Pol. :Vertical
 Engineer :Temo Chen

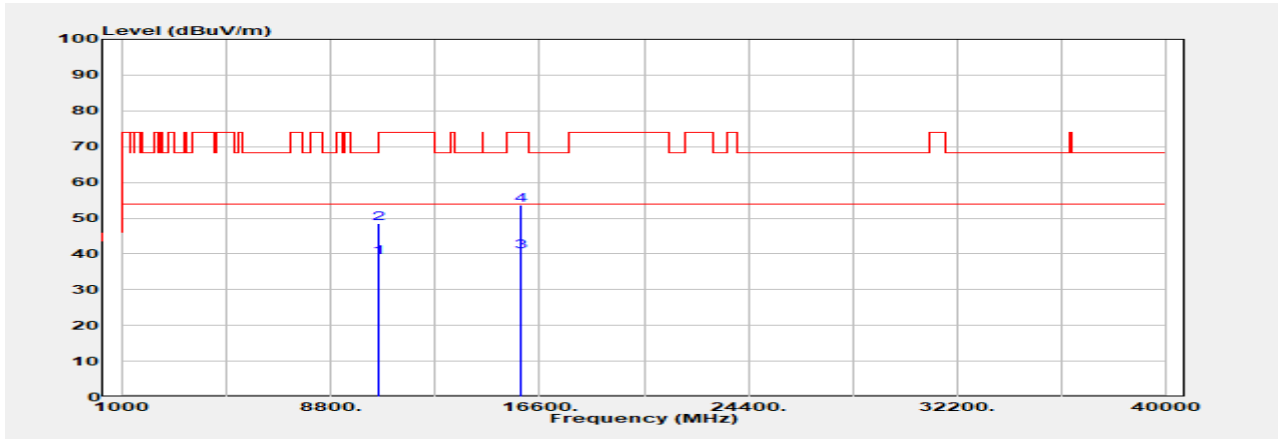

Freq. MHz	Detector Mode PK/QP/AVG	Spectrum Reading Level dB μ V	Factor dB	Actual FS dB μ V/m	Limit @3m dB μ V/m	Margin dB
10600.000	Average	28.96	10.00	38.96	54.00	-15.04
10600.000	Peak	38.62	10.00	48.62	74.00	-25.38
15900.000	Average	28.32	12.20	40.52	54.00	-13.48
15900.000	Peak	41.53	12.20	53.73	74.00	-20.27

Unless otherwise stated the results shown in this test report refer only to the sample(s) tested and such sample(s) are retained for 90 days only.

除非另有說明，此報告結果僅對測試之樣品負責，同時此樣品僅保留90天。本報告未經本公司書面許可，不可部份複製。

This document is issued by the Company subject to its General Conditions of Service printed overleaf, available on request or accessible at <http://www.sgs.com.tw/Terms-and-Conditions> and for electronic format documents, subject to Terms and Conditions for Electronic Documents at <http://www.sgs.com.tw/Terms-and-Conditions>. Attention is drawn to the limitation of liability, indemnification and jurisdiction issues defined therein. Any holder of this document is advised that information contained hereon reflects the Company's findings at the time of its intervention only and within the limits of Client's instructions, if any. The Company's sole responsibility is to its Client and this document does not exonerate parties to a transaction from exercising all their rights and obligations under the transaction documents. This document cannot be reproduced except in full, without prior written approval of the Company. Any unauthorized alteration, forgery or falsification of the content or appearance of this document is unlawful and offenders may be prosecuted to the fullest extent of the law.

Report Number :TERF2308001923E2
 Operation Mode :802.11be20
 Test Frequency :5300 MHz
 Test Mode :Tx
 EUT Pol :E2 Plane

Test Site :SAC G Chamber
 Test Date :2023-08-25
 Temp./Humi. :25.9°C/57%
 Antenna Pol. :Horizontal
 Engineer :Temo Chen

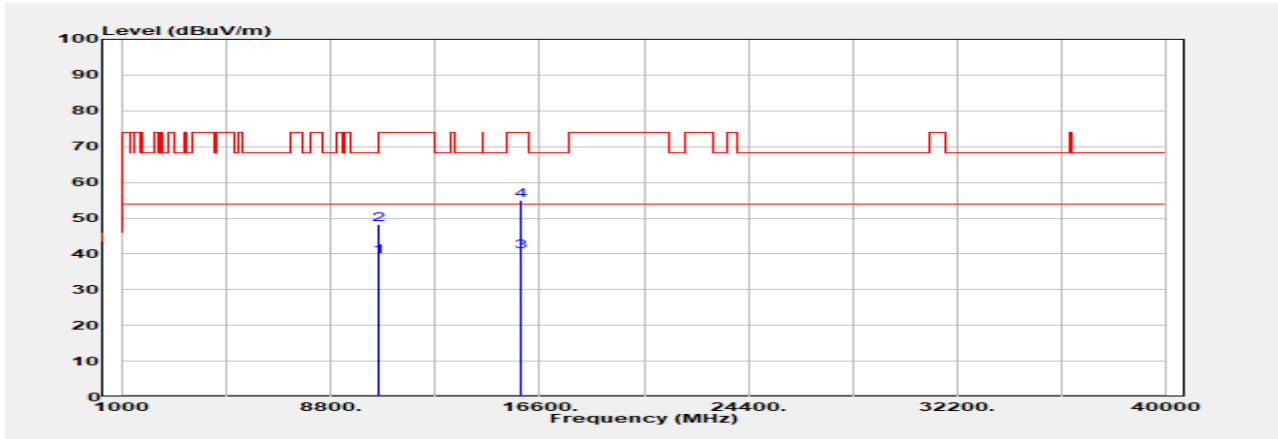

Freq. MHz	Detector Mode PK/QP/AVG	Spectrum Reading Level dB μ V	Factor dB	Actual FS dB μ V/m	Limit @3m dB μ V/m	Margin dB
10600.000	Average	29.31	10.00	39.31	54.00	-14.69
10600.000	Peak	38.32	10.00	48.32	74.00	-25.68
15900.000	Average	28.44	12.20	40.64	54.00	-13.36
15900.000	Peak	42.73	12.20	54.93	74.00	-19.07

Unless otherwise stated the results shown in this test report refer only to the sample(s) tested and such sample(s) are retained for 90 days only.

除非另有說明，此報告結果僅對測試之樣品負責，同時此樣品僅保留90天。本報告未經本公司書面許可，不可部份複製。

This document is issued by the Company subject to its General Conditions of Service printed overleaf, available on request or accessible at <http://www.sgs.com.tw/Terms-and-Conditions> and for electronic format documents, subject to Terms and Conditions for Electronic Documents at <http://www.sgs.com.tw/Terms-and-Conditions>. Attention is drawn to the limitation of liability, indemnification and jurisdiction issues defined therein. Any holder of this document is advised that information contained hereon reflects the Company's findings at the time of its intervention only and within the limits of Client's instructions, if any. The Company's sole responsibility is to its Client and this document does not exonerate parties to a transaction from exercising all their rights and obligations under the transaction documents. This document cannot be reproduced except in full, without prior written approval of the Company. Any unauthorized alteration, forgery or falsification of the content or appearance of this document is unlawful and offenders may be prosecuted to the fullest extent of the law.

Report Number :TERF2308001923E2
 Operation Mode :802.11be20
 Test Frequency :5320 MHz
 Test Mode :Tx
 EUT Pol :E2 Plane

Test Site :SAC G Chamber
 Test Date :2023-08-25
 Temp./Humi. :25.9°C/57%
 Antenna Pol. :Vertical
 Engineer :Temo Chen

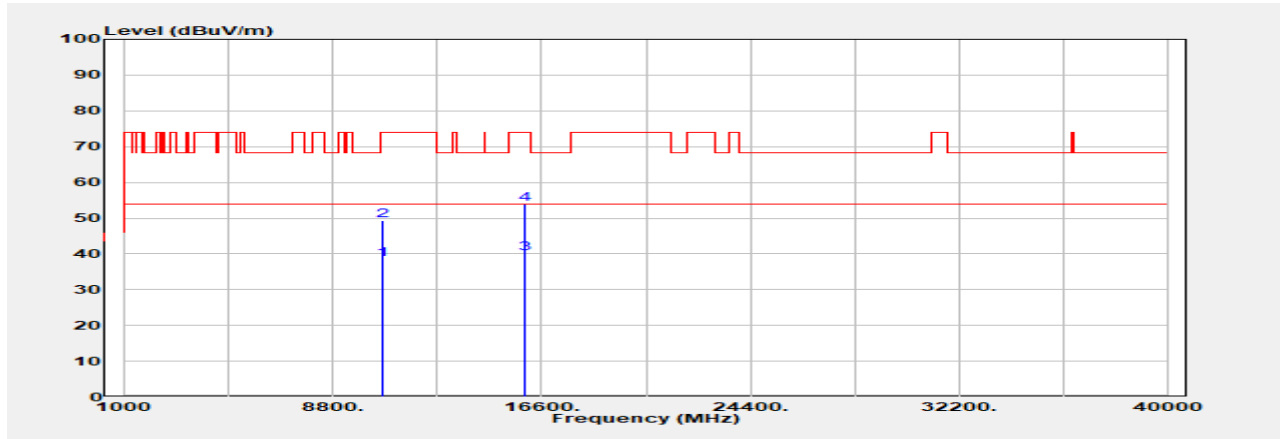

Freq. MHz	Detector Mode PK/QP/AVG	Spectrum Reading Level dB μ V	Factor dB	Actual FS dB μ V/m	Limit @3m dB μ V/m	Margin dB
10640.000	Average	28.67	9.72	38.39	54.00	-15.61
10640.000	Peak	39.49	9.72	49.21	74.00	-24.79
15960.000	Average	28.22	11.90	40.12	54.00	-13.88
15960.000	Peak	41.92	11.90	53.82	74.00	-20.18

Unless otherwise stated the results shown in this test report refer only to the sample(s) tested and such sample(s) are retained for 90 days only.

除非另有說明，此報告結果僅對測試之樣品負責，同時此樣品僅保留90天。本報告未經本公司書面許可，不可部份複製。

This document is issued by the Company subject to its General Conditions of Service printed overleaf, available on request or accessible at <http://www.sgs.com.tw/Terms-and-Conditions> and for electronic format documents, subject to Terms and Conditions for Electronic Documents at <http://www.sgs.com.tw/Terms-and-Conditions>. Attention is drawn to the limitation of liability, indemnification and jurisdiction issues defined therein. Any holder of this document is advised that information contained hereon reflects the Company's findings at the time of its intervention only and within the limits of Client's instructions, if any. The Company's sole responsibility is to its Client and this document does not exonerate parties to a transaction from exercising all their rights and obligations under the transaction documents. This document cannot be reproduced except in full, without prior written approval of the Company. Any unauthorized alteration, forgery or falsification of the content or appearance of this document is unlawful and offenders may be prosecuted to the fullest extent of the law.

Report Number :TERF2308001923E2
 Operation Mode :802.11be20
 Test Frequency :5320 MHz
 Test Mode :Tx
 EUT Pol :E2 Plane

Test Site :SAC G Chamber
 Test Date :2023-08-25
 Temp./Humi. :25.9°C/57%
 Antenna Pol. :Horizontal
 Engineer :Temo Chen

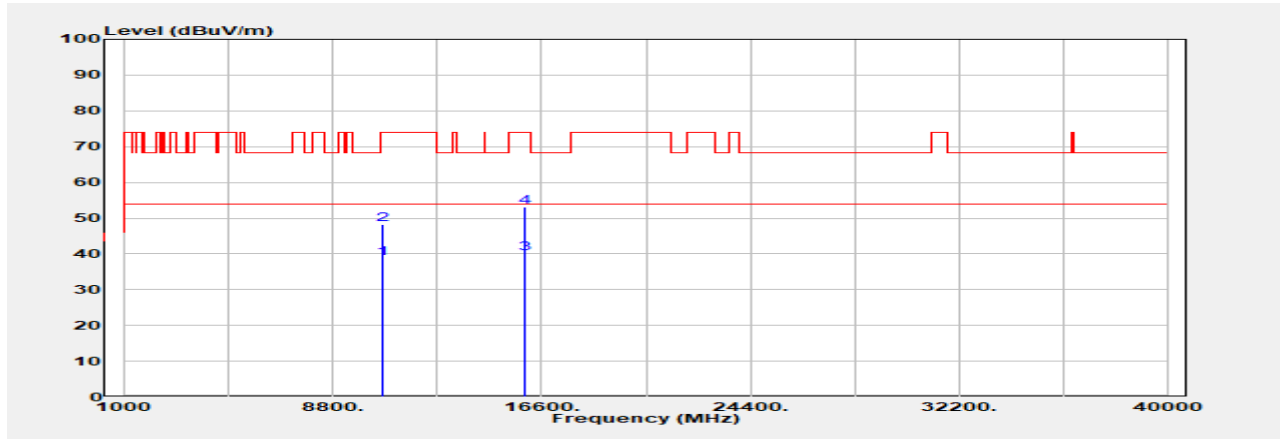

Freq. MHz	Detector Mode PK/QP/AVG	Spectrum Reading Level dB μ V	Factor dB	Actual FS dB μ V/m	Limit @3m dB μ V/m	Margin dB
10640.000	Average	28.93	9.72	38.65	54.00	-15.35
10640.000	Peak	38.53	9.72	48.25	74.00	-25.75
15960.000	Average	28.24	11.90	40.14	54.00	-13.86
15960.000	Peak	41.17	11.90	53.07	74.00	-20.93

Unless otherwise stated the results shown in this test report refer only to the sample(s) tested and such sample(s) are retained for 90 days only.

除非另有說明，此報告結果僅對測試之樣品負責，同時此樣品僅保留90天。本報告未經本公司書面許可，不可部份複製。

This document is issued by the Company subject to its General Conditions of Service printed overleaf, available on request or accessible at <http://www.sgs.com.tw/Terms-and-Conditions> and for electronic format documents, subject to Terms and Conditions for Electronic Documents at <http://www.sgs.com.tw/Terms-and-Conditions>. Attention is drawn to the limitation of liability, indemnification and jurisdiction issues defined therein. Any holder of this document is advised that information contained hereon reflects the Company's findings at the time of its intervention only and within the limits of Client's instructions, if any. The Company's sole responsibility is to its Client and this document does not exonerate parties to a transaction from exercising all their rights and obligations under the transaction documents. This document cannot be reproduced except in full, without prior written approval of the Company. Any unauthorized alteration, forgery or falsification of the content or appearance of this document is unlawful and offenders may be prosecuted to the fullest extent of the law.

Report Number :TERF2308001923E2
 Operation Mode :802.11be20
 Test Frequency :5500 MHz
 Test Mode :Tx
 EUT Pol :E2 Plane

Test Site :SAC G Chamber
 Test Date :2023-08-25
 Temp./Humi. :25.9°C/57%
 Antenna Pol. :Vertical
 Engineer :Temo Chen



Freq. MHz	Detector Mode PK/QP/AVG	Spectrum Reading Level dB μ V	Factor dB	Actual FS dB μ V/m	Limit @3m dB μ V/m	Margin dB
11000.000	Average	29.18	11.90	41.08	54.00	-12.92
11000.000	Peak	37.22	11.90	49.12	74.00	-24.88
16500.000	Peak	42.02	12.00	54.02	68.20	-14.18

Unless otherwise stated the results shown in this test report refer only to the sample(s) tested and such sample(s) are retained for 90 days only.

除非另有說明，此報告結果僅對測試之樣品負責，同時此樣品僅保留90天。本報告未經本公司書面許可，不可部份複製。

This document is issued by the Company subject to its General Conditions of Service printed overleaf, available on request or accessible at <http://www.sgs.com.tw/Terms-and-Conditions> and for electronic format documents, subject to Terms and Conditions for Electronic Documents at <http://www.sgs.com.tw/Terms-and-Conditions>. Attention is drawn to the limitation of liability, indemnification and jurisdiction issues defined therein. Any holder of this document is advised that information contained hereon reflects the Company's findings at the time of its intervention only and within the limits of Client's instructions, if any. The Company's sole responsibility is to its Client and this document does not exonerate parties to a transaction from exercising all their rights and obligations under the transaction documents. This document cannot be reproduced except in full, without prior written approval of the Company. Any unauthorized alteration, forgery or falsification of the content or appearance of this document is unlawful and offenders may be prosecuted to the fullest extent of the law.

Report Number :TERF2308001923E2
 Operation Mode :802.11be20
 Test Frequency :5500 MHz
 Test Mode :Tx
 EUT Pol :E2 Plane

Test Site :SAC G Chamber
 Test Date :2023-08-25
 Temp./Humi. :25.9°C/57%
 Antenna Pol. :Horizontal
 Engineer :Temo Chen

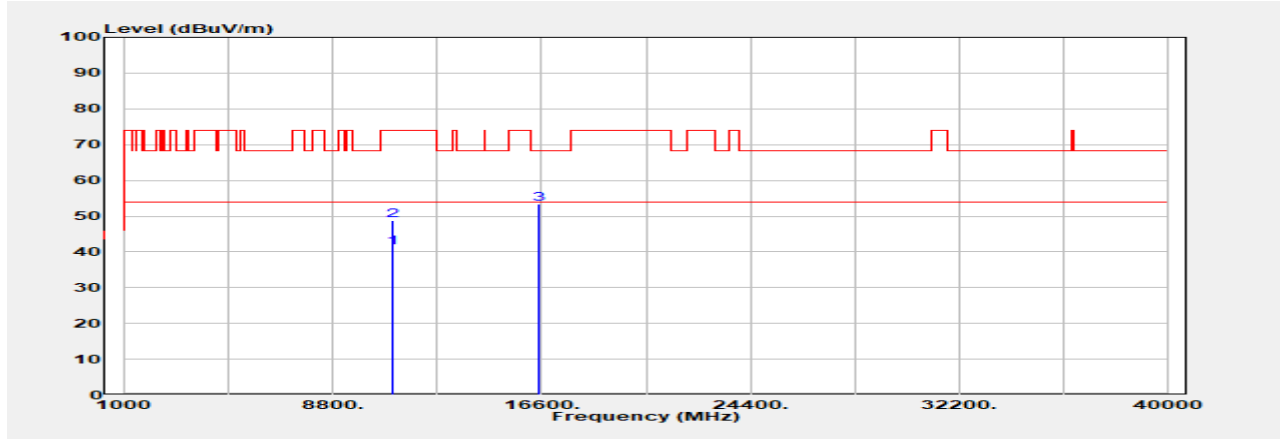

Freq. MHz	Detector Mode PK/QP/AVG	Spectrum Reading Level dB μ V	Factor dB	Actual FS dB μ V/m	Limit @3m dB μ V/m	Margin dB
11000.000	Average	29.39	11.90	41.29	54.00	-12.71
11000.000	Peak	36.97	11.90	48.87	74.00	-25.13
16500.000	Peak	41.33	12.00	53.33	68.20	-14.87

Unless otherwise stated the results shown in this test report refer only to the sample(s) tested and such sample(s) are retained for 90 days only.

除非另有說明，此報告結果僅對測試之樣品負責，同時此樣品僅保留90天。本報告未經本公司書面許可，不可部份複製。

This document is issued by the Company subject to its General Conditions of Service printed overleaf, available on request or accessible at <http://www.sgs.com.tw/Terms-and-Conditions> and for electronic format documents, subject to Terms and Conditions for Electronic Documents at <http://www.sgs.com.tw/Terms-and-Conditions>. Attention is drawn to the limitation of liability, indemnification and jurisdiction issues defined therein. Any holder of this document is advised that information contained hereon reflects the Company's findings at the time of its intervention only and within the limits of Client's instructions, if any. The Company's sole responsibility is to its Client and this document does not exonerate parties to a transaction from exercising all their rights and obligations under the transaction documents. This document cannot be reproduced except in full, without prior written approval of the Company. Any unauthorized alteration, forgery or falsification of the content or appearance of this document is unlawful and offenders may be prosecuted to the fullest extent of the law.

Report Number :TERF2308001923E2
 Operation Mode :802.11be20
 Test Frequency :5580 MHz
 Test Mode :Tx
 EUT Pol :E2 Plane

Test Site :SAC G Chamber
 Test Date :2023-08-25
 Temp./Humi. :25.9°C/57%
 Antenna Pol. :Vertical
 Engineer :Temo Chen

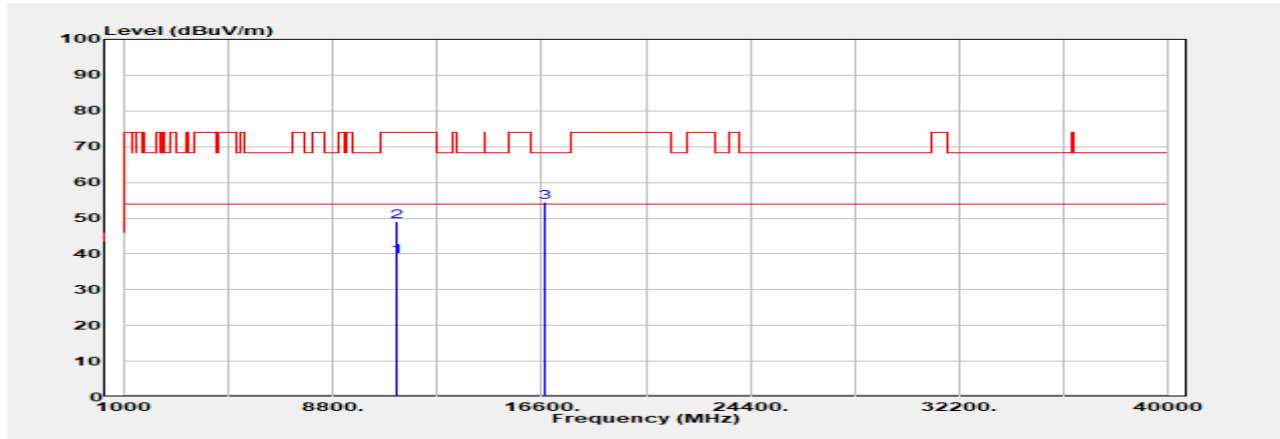

Freq. MHz	Detector Mode PK/QP/AVG	Spectrum Reading Level dB μ V	Factor dB	Actual FS dB μ V/m	Limit @3m dB μ V/m	Margin dB
11160.000	Average	29.47	9.88	39.35	54.00	-14.65
11160.000	Peak	39.21	9.88	49.09	74.00	-24.91
16740.000	Peak	42.81	11.66	54.47	68.20	-13.73

Unless otherwise stated the results shown in this test report refer only to the sample(s) tested and such sample(s) are retained for 90 days only.

除非另有說明，此報告結果僅對測試之樣品負責，同時此樣品僅保留90天。本報告未經本公司書面許可，不可部份複製。

This document is issued by the Company subject to its General Conditions of Service printed overleaf, available on request or accessible at <http://www.sgs.com.tw/Terms-and-Conditions> and for electronic format documents, subject to Terms and Conditions for Electronic Documents at <http://www.sgs.com.tw/Terms-and-Conditions>. Attention is drawn to the limitation of liability, indemnification and jurisdiction issues defined therein. Any holder of this document is advised that information contained hereon reflects the Company's findings at the time of its intervention only and within the limits of Client's instructions, if any. The Company's sole responsibility is to its Client and this document does not exonerate parties to a transaction from exercising all their rights and obligations under the transaction documents. This document cannot be reproduced except in full, without prior written approval of the Company. Any unauthorized alteration, forgery or falsification of the content or appearance of this document is unlawful and offenders may be prosecuted to the fullest extent of the law.

Report Number :TERF2308001923E2
 Operation Mode :802.11be20
 Test Frequency :5580 MHz
 Test Mode :Tx
 EUT Pol :E2 Plane

Test Site :SAC G Chamber
 Test Date :2023-08-25
 Temp./Humi. :25.9°C/57%
 Antenna Pol. :Horizontal
 Engineer :Temo Chen

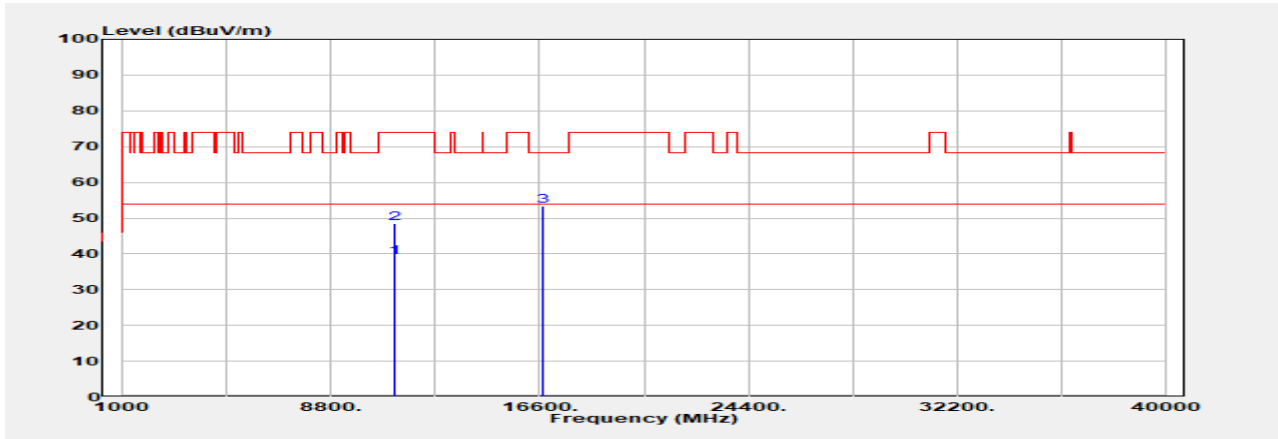

Freq. MHz	Detector Mode PK/QP/AVG	Spectrum Reading Level dB μ V	Factor dB	Actual FS dB μ V/m	Limit @3m dB μ V/m	Margin dB
11160.000	Average	29.13	9.88	39.01	54.00	-14.99
11160.000	Peak	38.75	9.88	48.63	74.00	-25.37
16740.000	Peak	41.60	11.66	53.26	68.20	-14.94

Unless otherwise stated the results shown in this test report refer only to the sample(s) tested and such sample(s) are retained for 90 days only.

除非另有說明，此報告結果僅對測試之樣品負責，同時此樣品僅保留90天。本報告未經本公司書面許可，不可部份複製。

This document is issued by the Company subject to its General Conditions of Service printed overleaf, available on request or accessible at <http://www.sgs.com.tw/Terms-and-Conditions> and for electronic format documents, subject to Terms and Conditions for Electronic Documents at <http://www.sgs.com.tw/Terms-and-Conditions>. Attention is drawn to the limitation of liability, indemnification and jurisdiction issues defined therein. Any holder of this document is advised that information contained hereon reflects the Company's findings at the time of its intervention only and within the limits of Client's instructions, if any. The Company's sole responsibility is to its Client and this document does not exonerate parties to a transaction from exercising all their rights and obligations under the transaction documents. This document cannot be reproduced except in full, without prior written approval of the Company. Any unauthorized alteration, forgery or falsification of the content or appearance of this document is unlawful and offenders may be prosecuted to the fullest extent of the law.

Report Number :TERF2308001923E2

Test Site :SAC G Chamber

Operation Mode :802.11be20

Test Date :2023-08-25

Test Frequency :5700 MHz

Temp./Humi. :25.9°C/57%

Test Mode :Tx

Antenna Pol. :Vertical

EUT Pol :E2 Plane

Engineer :Temo Chen

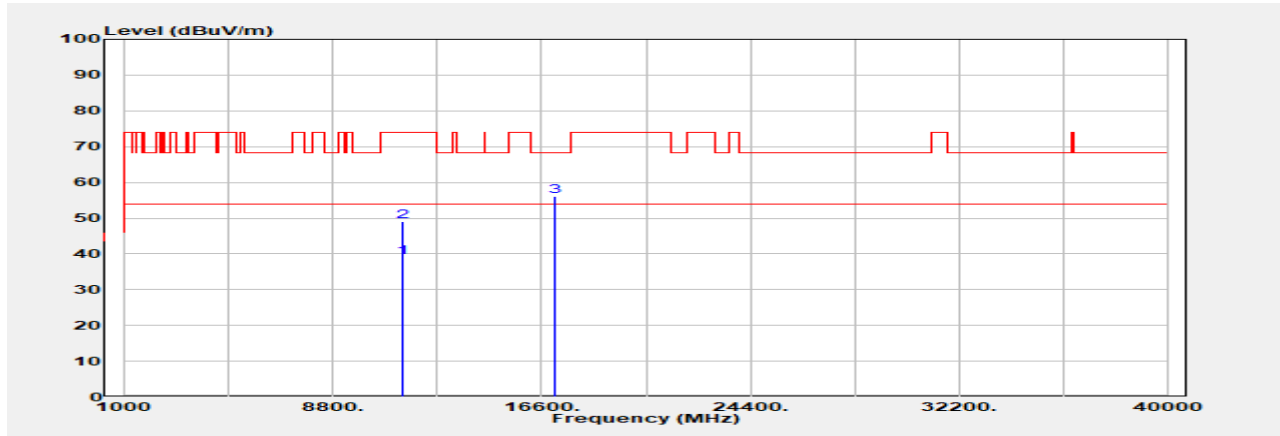

Freq. MHz	Detector Mode PK/QP/AVG	Spectrum Reading Level dB μ V	Factor dB	Actual FS dB μ V/m	Limit @3m dB μ V/m	Margin dB
11400.000	Average	29.32	9.80	39.12	54.00	-14.88
11400.000	Peak	39.18	9.80	48.98	74.00	-25.02
17100.000	Peak	43.79	12.20	55.99	68.20	-12.21

Unless otherwise stated the results shown in this test report refer only to the sample(s) tested and such sample(s) are retained for 90 days only.

除非另有說明，此報告結果僅對測試之樣品負責，同時此樣品僅保留90天。本報告未經本公司書面許可，不可部份複製。

This document is issued by the Company subject to its General Conditions of Service printed overleaf, available on request or accessible at <http://www.sgs.com.tw/Terms-and-Conditions> and for electronic format documents, subject to Terms and Conditions for Electronic Documents at <http://www.sgs.com.tw/Terms-and-Conditions>. Attention is drawn to the limitation of liability, indemnification and jurisdiction issues defined therein. Any holder of this document is advised that information contained hereon reflects the Company's findings at the time of its intervention only and within the limits of Client's instructions, if any. The Company's sole responsibility is to its Client and this document does not exonerate parties to a transaction from exercising all their rights and obligations under the transaction documents. This document cannot be reproduced except in full, without prior written approval of the Company. Any unauthorized alteration, forgery or falsification of the content or appearance of this document is unlawful and offenders may be prosecuted to the fullest extent of the law.

Report Number :TERF2308001923E2
 Operation Mode :802.11be20
 Test Frequency :5700 MHz
 Test Mode :Tx
 EUT Pol :E2 Plane

Test Site :SAC G Chamber
 Test Date :2023-08-25
 Temp./Humi. :25.9°C/57%
 Antenna Pol. :Horizontal
 Engineer :Temo Chen

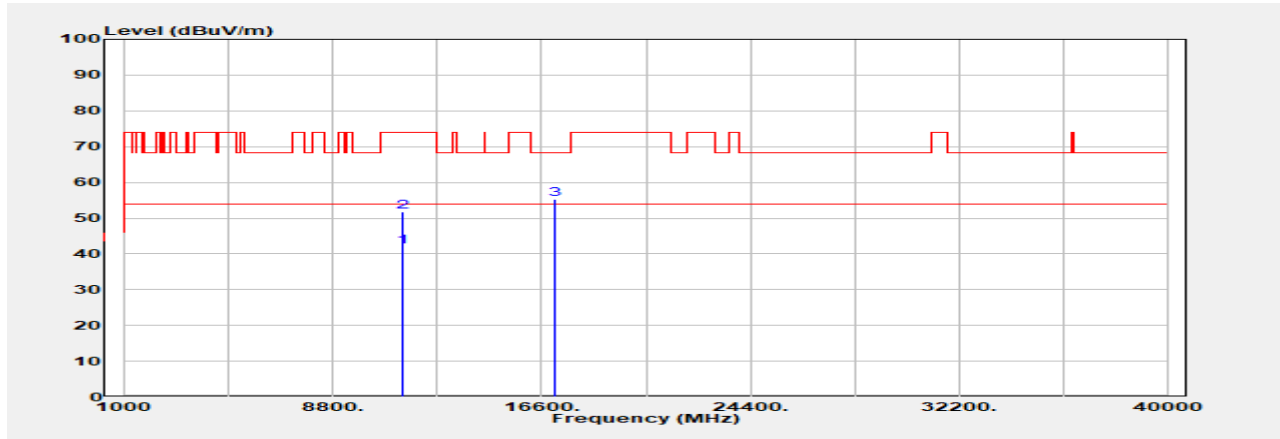

Freq. MHz	Detector Mode PK/QP/AVG	Spectrum Reading Level dB μ V	Factor dB	Actual FS dB μ V/m	Limit @3m dB μ V/m	Margin dB
11400.000	Average	32.12	9.80	41.92	54.00	-12.08
11400.000	Peak	41.95	9.80	51.75	74.00	-22.25
17100.000	Peak	43.09	12.20	55.29	68.20	-12.91

Unless otherwise stated the results shown in this test report refer only to the sample(s) tested and such sample(s) are retained for 90 days only.

除非另有說明，此報告結果僅對測試之樣品負責，同時此樣品僅保留90天。本報告未經本公司書面許可，不可部份複製。

This document is issued by the Company subject to its General Conditions of Service printed overleaf, available on request or accessible at <http://www.sgs.com.tw/Terms-and-Conditions> and for electronic format documents, subject to Terms and Conditions for Electronic Documents at <http://www.sgs.com.tw/Terms-and-Conditions>. Attention is drawn to the limitation of liability, indemnification and jurisdiction issues defined therein. Any holder of this document is advised that information contained hereon reflects the Company's findings at the time of its intervention only and within the limits of Client's instructions, if any. The Company's sole responsibility is to its Client and this document does not exonerate parties to a transaction from exercising all their rights and obligations under the transaction documents. This document cannot be reproduced except in full, without prior written approval of the Company. Any unauthorized alteration, forgery or falsification of the content or appearance of this document is unlawful and offenders may be prosecuted to the fullest extent of the law.

Report Number :TERF2308001923E2

Test Site :SAC G Chamber

Operation Mode :802.11be20

Test Date :2023-08-25

Test Frequency :5745 MHz

Temp./Humi. :25.9°C/57%

Test Mode :Tx

Antenna Pol. :Vertical

EUT Pol :E2 Plane

Engineer :Temo Chen

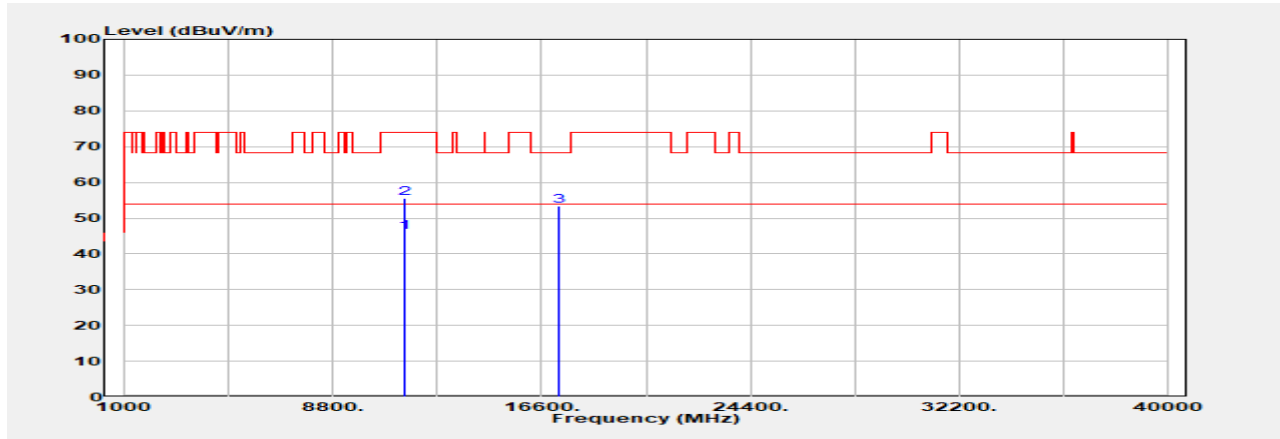

Freq. MHz	Detector Mode PK/QP/AVG	Spectrum Reading Level dBμV	Factor dB	Actual FS dBμV/m	Limit @3m dBμV/m	Margin dB
11490.000	Average	35.01	11.06	46.07	54.00	-7.93
11490.000	Peak	44.51	11.06	55.57	74.00	-18.43
17235.000	Peak	42.59	10.82	53.41	68.20	-14.79

Unless otherwise stated the results shown in this test report refer only to the sample(s) tested and such sample(s) are retained for 90 days only.

除非另有說明，此報告結果僅對測試之樣品負責，同時此樣品僅保留90天。本報告未經本公司書面許可，不可部份複製。

This document is issued by the Company subject to its General Conditions of Service printed overleaf, available on request or accessible at <http://www.sgs.com.tw/Terms-and-Conditions> and for electronic format documents, subject to Terms and Conditions for Electronic Documents at <http://www.sgs.com.tw/Terms-and-Conditions>. Attention is drawn to the limitation of liability, indemnification and jurisdiction issues defined therein. Any holder of this document is advised that information contained hereon reflects the Company's findings at the time of its intervention only and within the limits of Client's instructions, if any. The Company's sole responsibility is to its Client and this document does not exonerate parties to a transaction from exercising all their rights and obligations under the transaction documents. This document cannot be reproduced except in full, without prior written approval of the Company. Any unauthorized alteration, forgery or falsification of the content or appearance of this document is unlawful and offenders may be prosecuted to the fullest extent of the law.

Report Number :TERF2308001923E2

Test Site :SAC G Chamber

Operation Mode :802.11be20

Test Date :2023-08-25

Test Frequency :5745 MHz

Temp./Humi. :25.9°C/57%

Test Mode :Tx

Antenna Pol. :Horizontal

EUT Pol :E2 Plane

Engineer :Temo Chen

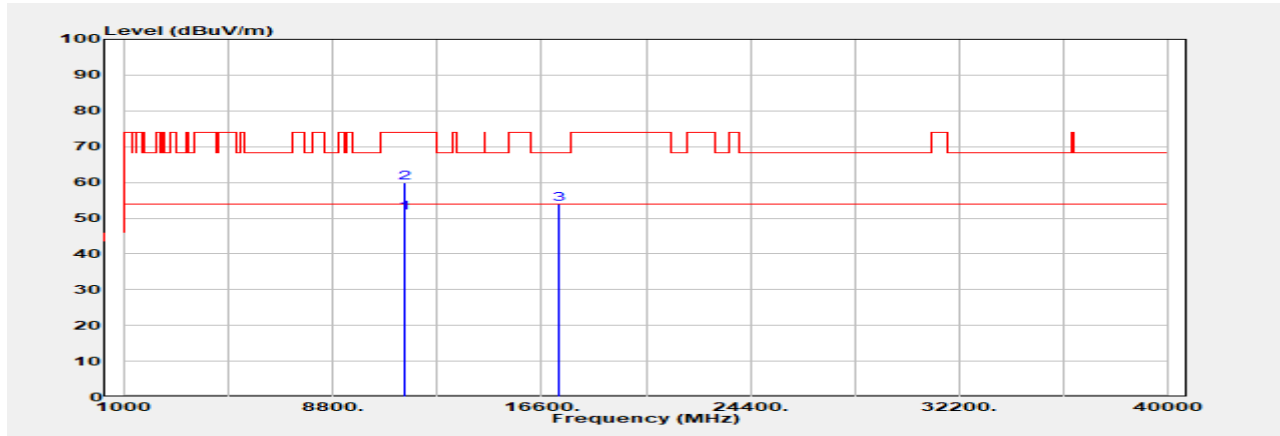

Freq. MHz	Detector Mode PK/QP/AVG	Spectrum Reading Level dB μ V	Factor dB	Actual FS dB μ V/m	Limit @3m dB μ V/m	Margin dB
11490.000	Average	40.48	11.06	51.54	54.00	-2.46
11490.000	Peak	48.93	11.06	59.99	74.00	-14.01
17235.000	Peak	43.19	10.82	54.01	68.20	-14.19

Unless otherwise stated the results shown in this test report refer only to the sample(s) tested and such sample(s) are retained for 90 days only.

除非另有說明，此報告結果僅對測試之樣品負責，同時此樣品僅保留90天。本報告未經本公司書面許可，不可部份複製。

This document is issued by the Company subject to its General Conditions of Service printed overleaf, available on request or accessible at <http://www.sgs.com.tw/Terms-and-Conditions> and for electronic format documents, subject to Terms and Conditions for Electronic Documents at <http://www.sgs.com.tw/Terms-and-Conditions>. Attention is drawn to the limitation of liability, indemnification and jurisdiction issues defined therein. Any holder of this document is advised that information contained hereon reflects the Company's findings at the time of its intervention only and within the limits of Client's instructions, if any. The Company's sole responsibility is to its Client and this document does not exonerate parties to a transaction from exercising all their rights and obligations under the transaction documents. This document cannot be reproduced except in full, without prior written approval of the Company. Any unauthorized alteration, forgery or falsification of the content or appearance of this document is unlawful and offenders may be prosecuted to the fullest extent of the law.

Report Number :TERF2308001923E2

Test Site :SAC G Chamber

Operation Mode :802.11be20

Test Date :2023-10-20

Test Frequency :5785 MHz

Temp./Humi. :21.3°C/68%

Test Mode :Tx

Antenna Pol. :Vertical

EUT Pol :E2 Plane

Engineer :Temo Chen

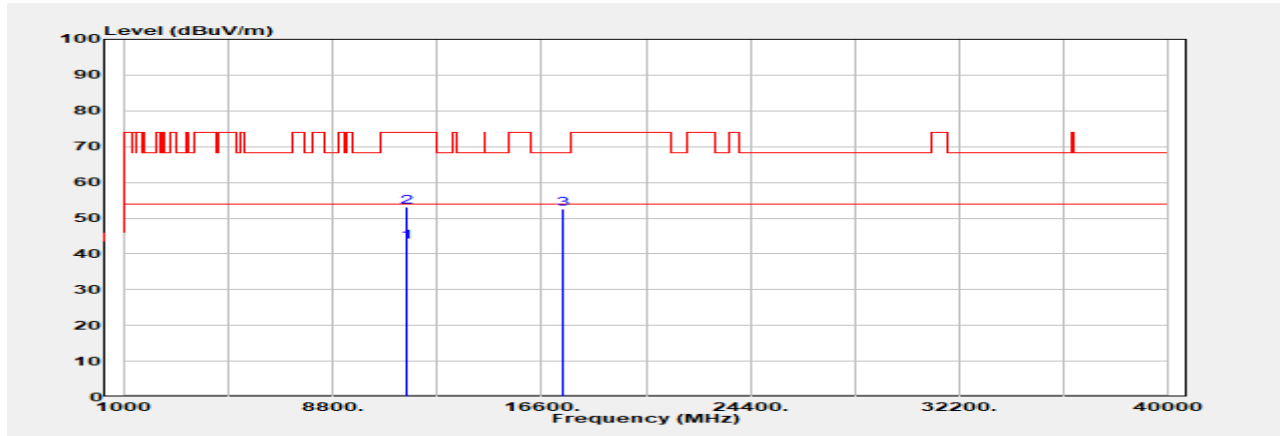

Freq. MHz	Detector Mode PK/QP/AVG	Spectrum Reading Level dB μ V	Factor dB	Actual FS dB μ V/m	Limit @3m dB μ V/m	Margin dB
11570.000	Average	33.33	10.15	43.48	54.00	-10.52
11570.000	Peak	42.88	10.15	53.03	74.00	-20.97
17355.000	Peak	40.71	11.82	52.53	68.20	-15.67

Unless otherwise stated the results shown in this test report refer only to the sample(s) tested and such sample(s) are retained for 90 days only.

除非另有說明，此報告結果僅對測試之樣品負責，同時此樣品僅保留90天。本報告未經本公司書面許可，不可部份複製。

This document is issued by the Company subject to its General Conditions of Service printed overleaf, available on request or accessible at <http://www.sgs.com.tw/Terms-and-Conditions> and for electronic format documents, subject to Terms and Conditions for Electronic Documents at <http://www.sgs.com.tw/Terms-and-Conditions>. Attention is drawn to the limitation of liability, indemnification and jurisdiction issues defined therein. Any holder of this document is advised that information contained hereon reflects the Company's findings at the time of its intervention only and within the limits of Client's instructions, if any. The Company's sole responsibility is to its Client and this document does not exonerate parties to a transaction from exercising all their rights and obligations under the transaction documents. This document cannot be reproduced except in full, without prior written approval of the Company. Any unauthorized alteration, forgery or falsification of the content or appearance of this document is unlawful and offenders may be prosecuted to the fullest extent of the law.

Report Number :TERF2308001923E2	Test Site :SAC G Chamber
Operation Mode :802.11be20	Test Date :2023-10-20
Test Frequency :5785 MHz	Temp./Humi. :21.3°C/68%
Test Mode :Tx	Antenna Pol. :Horizontal
EUT Pol :E2 Plane	Engineer :Temo Chen

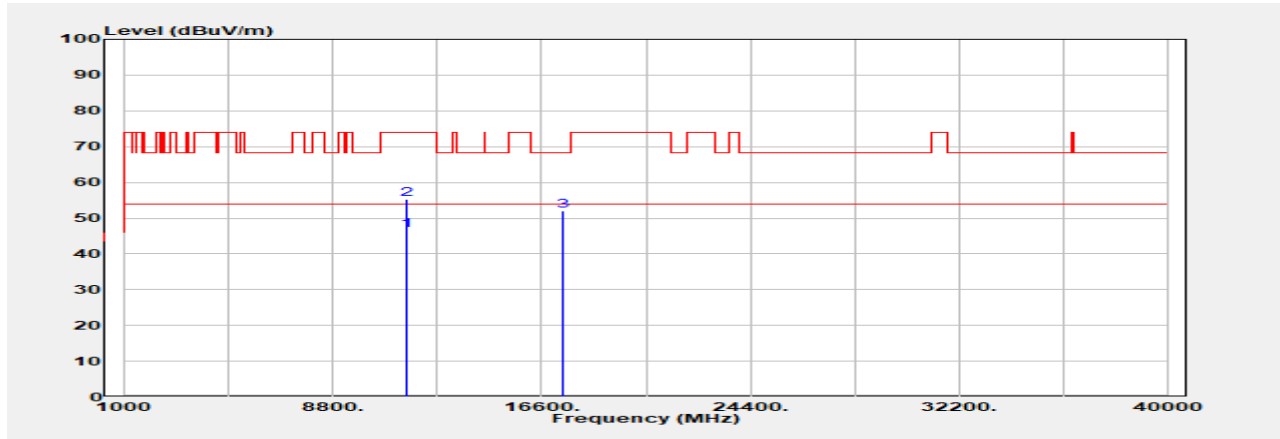

Freq. MHz	Detector Mode PK/QP/AVG	Spectrum Reading Level dB μ V	Factor dB	Actual FS dB μ V/m	Limit @3m dB μ V/m	Margin dB
11570.000	Average	36.42	10.15	46.57	54.00	-7.43
11570.000	Peak	45.25	10.15	55.39	74.00	-18.61
17355.000	Peak	40.32	11.82	52.14	68.20	-16.06

Unless otherwise stated the results shown in this test report refer only to the sample(s) tested and such sample(s) are retained for 90 days only.

除非另有說明，此報告結果僅對測試之樣品負責，同時此樣品僅保留90天。本報告未經本公司書面許可，不可部份複製。

This document is issued by the Company subject to its General Conditions of Service printed overleaf, available on request or accessible at <http://www.sgs.com.tw/Terms-and-Conditions> and for electronic format documents, subject to Terms and Conditions for Electronic Documents at <http://www.sgs.com.tw/Terms-and-Conditions>. Attention is drawn to the limitation of liability, indemnification and jurisdiction issues defined therein. Any holder of this document is advised that information contained hereon reflects the Company's findings at the time of its intervention only and within the limits of Client's instructions, if any. The Company's sole responsibility is to its Client and this document does not exonerate parties to a transaction from exercising all their rights and obligations under the transaction documents. This document cannot be reproduced except in full, without prior written approval of the Company. Any unauthorized alteration, forgery or falsification of the content or appearance of this document is unlawful and offenders may be prosecuted to the fullest extent of the law.

Report Number :TERF2308001923E2

Test Site :SAC G Chamber

Operation Mode :802.11be20

Test Date :2023-10-20

Test Frequency :5825 MHz

Temp./Humi. :21.3°C/68%

Test Mode :Tx

Antenna Pol. :Vertical

EUT Pol :E2 Plane

Engineer :Temo Chen

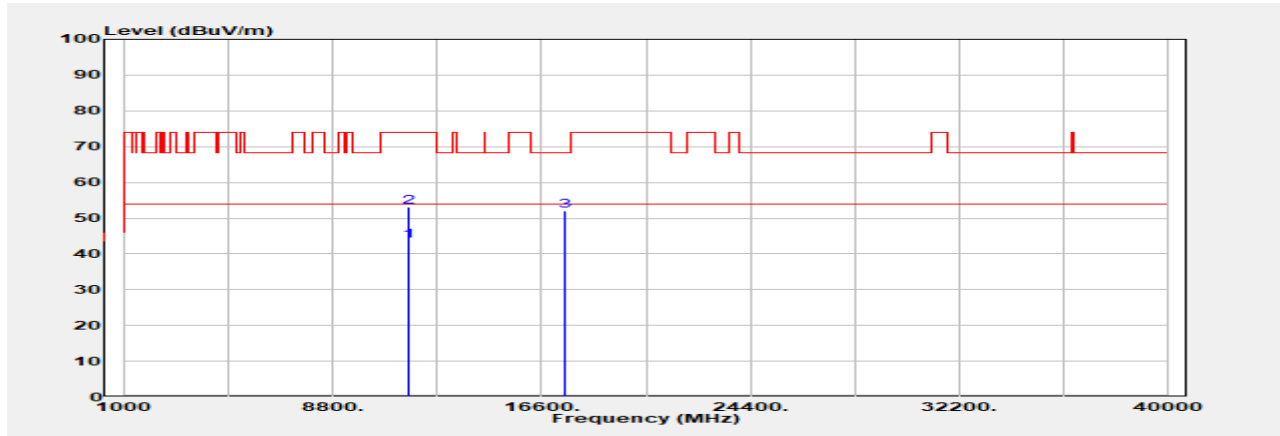

Freq. MHz	Detector Mode PK/QP/AVG	Spectrum Reading Level dB μ V	Factor dB	Actual FS dB μ V/m	Limit @3m dB μ V/m	Margin dB
11650.000	Average	33.45	10.05	43.50	54.00	-10.50
11650.000	Peak	43.11	10.05	53.16	74.00	-20.84
17475.000	Peak	41.04	11.10	52.14	68.20	-16.06

Unless otherwise stated the results shown in this test report refer only to the sample(s) tested and such sample(s) are retained for 90 days only.

除非另有說明，此報告結果僅對測試之樣品負責，同時此樣品僅保留90天。本報告未經本公司書面許可，不可部份複製。

This document is issued by the Company subject to its General Conditions of Service printed overleaf, available on request or accessible at <http://www.sgs.com.tw/Terms-and-Conditions> and for electronic format documents, subject to Terms and Conditions for Electronic Documents at <http://www.sgs.com.tw/Terms-and-Conditions>. Attention is drawn to the limitation of liability, indemnification and jurisdiction issues defined therein. Any holder of this document is advised that information contained hereon reflects the Company's findings at the time of its intervention only and within the limits of Client's instructions, if any. The Company's sole responsibility is to its Client and this document does not exonerate parties to a transaction from exercising all their rights and obligations under the transaction documents. This document cannot be reproduced except in full, without prior written approval of the Company. Any unauthorized alteration, forgery or falsification of the content or appearance of this document is unlawful and offenders may be prosecuted to the fullest extent of the law.

Report Number	:TERF2308001923E2	Test Site	:SAC G Chamber
Operation Mode	:802.11be20	Test Date	:2023-10-20
Test Frequency	:5825 MHz	Temp./Humi.	:21.3°C/68%
Test Mode	:Tx	Antenna Pol.	:Horizontal
EUT Pol	:E2 Plane	Engineer	:Temo Chen

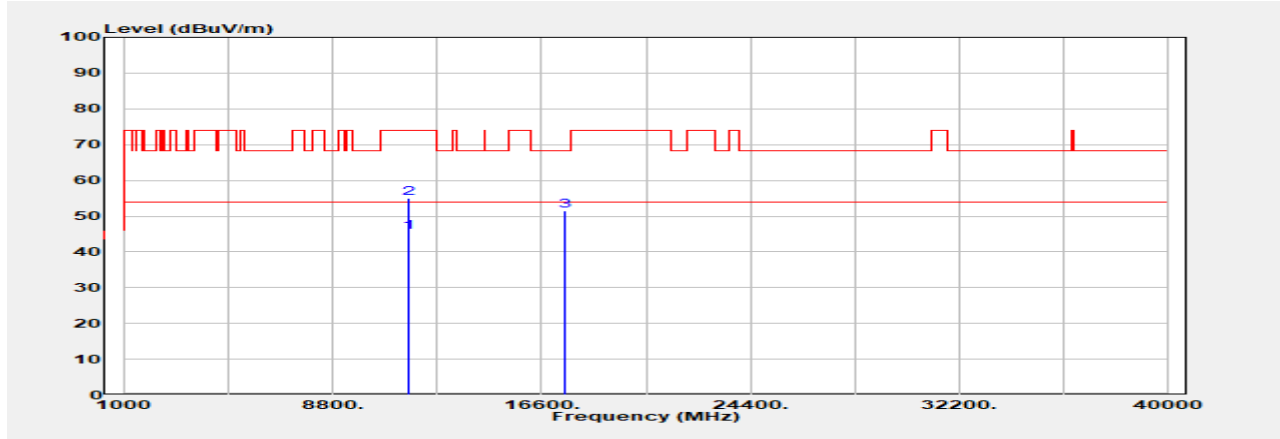

Freq. MHz	Detector Mode PK/QP/AVG	Spectrum Reading Level dB μ V	Factor dB	Actual FS dB μ V/m	Limit @3m dB μ V/m	Margin dB
11650.000	Average	35.45	10.05	45.50	54.00	-8.50
11650.000	Peak	44.83	10.05	54.88	74.00	-19.12
17475.000	Peak	40.31	11.10	51.41	68.20	-16.79

Unless otherwise stated the results shown in this test report refer only to the sample(s) tested and such sample(s) are retained for 90 days only.

除非另有說明，此報告結果僅對測試之樣品負責，同時此樣品僅保留90天。本報告未經本公司書面許可，不可部份複製。

This document is issued by the Company subject to its General Conditions of Service printed overleaf, available on request or accessible at <http://www.sgs.com.tw/Terms-and-Conditions> and for electronic format documents, subject to Terms and Conditions for Electronic Documents at <http://www.sgs.com.tw/Terms-and-Conditions>. Attention is drawn to the limitation of liability, indemnification and jurisdiction issues defined therein. Any holder of this document is advised that information contained hereon reflects the Company's findings at the time of its intervention only and within the limits of Client's instructions, if any. The Company's sole responsibility is to its Client and this document does not exonerate parties to a transaction from exercising all their rights and obligations under the transaction documents. This document cannot be reproduced except in full, without prior written approval of the Company. Any unauthorized alteration, forgery or falsification of the content or appearance of this document is unlawful and offenders may be prosecuted to the fullest extent of the law.

Report Number :TERF2308001923E2
 Operation Mode :802.11be40
 Test Frequency :5190 MHz
 Test Mode :Tx
 EUT Pol :E2 Plane

Test Site :SAC G Chamber
 Test Date :2023-10-20
 Temp./Humi. :21.3°C/68%
 Antenna Pol. :Vertical
 Engineer :Temo Chen

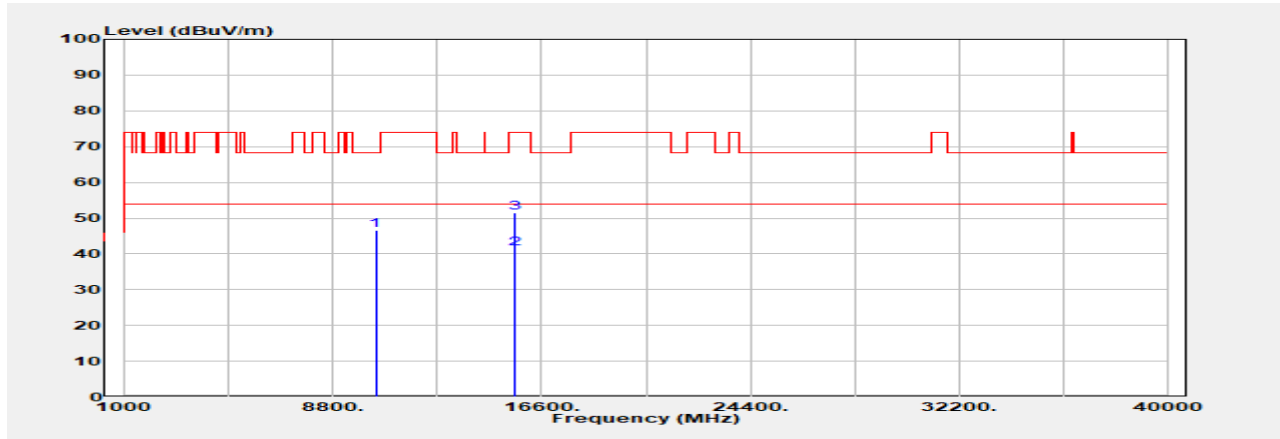

Freq. MHz	Detector Mode PK/QP/AVG	Spectrum Reading Level dBμV	Factor dB	Actual FS dBμV/m	Limit @3m dBμV/m	Margin dB
10380.000	Peak	37.10	9.44	46.54	68.20	-21.66
15570.000	Average	29.44	11.93	41.37	54.00	-12.63
15570.000	Peak	39.59	11.93	51.52	74.00	-22.48

Unless otherwise stated the results shown in this test report refer only to the sample(s) tested and such sample(s) are retained for 90 days only.

除非另有說明，此報告結果僅對測試之樣品負責，同時此樣品僅保留90天。本報告未經本公司書面許可，不可部份複製。

This document is issued by the Company subject to its General Conditions of Service printed overleaf, available on request or accessible at <http://www.sgs.com.tw/Terms-and-Conditions> and for electronic format documents, subject to Terms and Conditions for Electronic Documents at <http://www.sgs.com.tw/Terms-and-Conditions>. Attention is drawn to the limitation of liability, indemnification and jurisdiction issues defined therein. Any holder of this document is advised that information contained hereon reflects the Company's findings at the time of its intervention only and within the limits of Client's instructions, if any. The Company's sole responsibility is to its Client and this document does not exonerate parties to a transaction from exercising all their rights and obligations under the transaction documents. This document cannot be reproduced except in full, without prior written approval of the Company. Any unauthorized alteration, forgery or falsification of the content or appearance of this document is unlawful and offenders may be prosecuted to the fullest extent of the law.

Report Number :TERF2308001923E2
 Operation Mode :802.11be40
 Test Frequency :5190 MHz
 Test Mode :Tx
 EUT Pol :E2 Plane

Test Site :SAC G Chamber
 Test Date :2023-10-20
 Temp./Humi. :21.3°C/68%
 Antenna Pol. :Horizontal
 Engineer :Temo Chen

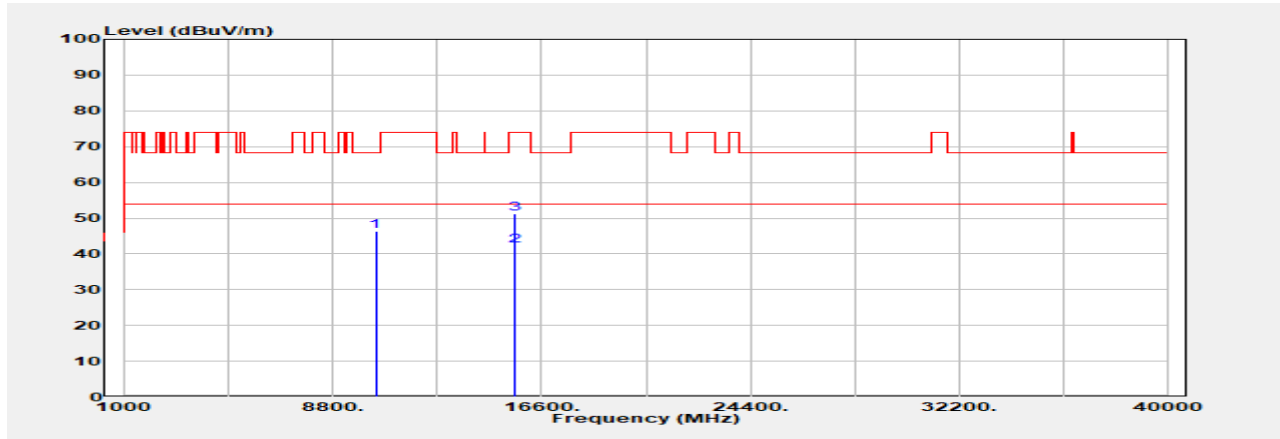

Freq. MHz	Detector Mode PK/QP/AVG	Spectrum Reading Level dBμV	Factor dB	Actual FS dBμV/m	Limit @3m dBμV/m	Margin dB
10380.000	Peak	36.82	9.44	46.26	68.20	-21.94
15570.000	Average	30.45	11.93	42.38	54.00	-11.62
15570.000	Peak	39.34	11.93	51.27	74.00	-22.73

Unless otherwise stated the results shown in this test report refer only to the sample(s) tested and such sample(s) are retained for 90 days only.

除非另有說明，此報告結果僅對測試之樣品負責，同時此樣品僅保留90天。本報告未經本公司書面許可，不可部份複製。

This document is issued by the Company subject to its General Conditions of Service printed overleaf, available on request or accessible at <http://www.sgs.com.tw/Terms-and-Conditions> and for electronic format documents, subject to Terms and Conditions for Electronic Documents at <http://www.sgs.com.tw/Terms-and-Conditions>. Attention is drawn to the limitation of liability, indemnification and jurisdiction issues defined therein. Any holder of this document is advised that information contained hereon reflects the Company's findings at the time of its intervention only and within the limits of Client's instructions, if any. The Company's sole responsibility is to its Client and this document does not exonerate parties to a transaction from exercising all their rights and obligations under the transaction documents. This document cannot be reproduced except in full, without prior written approval of the Company. Any unauthorized alteration, forgery or falsification of the content or appearance of this document is unlawful and offenders may be prosecuted to the fullest extent of the law.

Report Number :TERF2308001923E2	Test Site :SAC G Chamber
Operation Mode :802.11be40	Test Date :2023-08-25
Test Frequency :5230 MHz	Temp./Humi. :25.9°C/57%
Test Mode :Tx	Antenna Pol. :Vertical
EUT Pol :E2 Plane	Engineer :Temo Chen

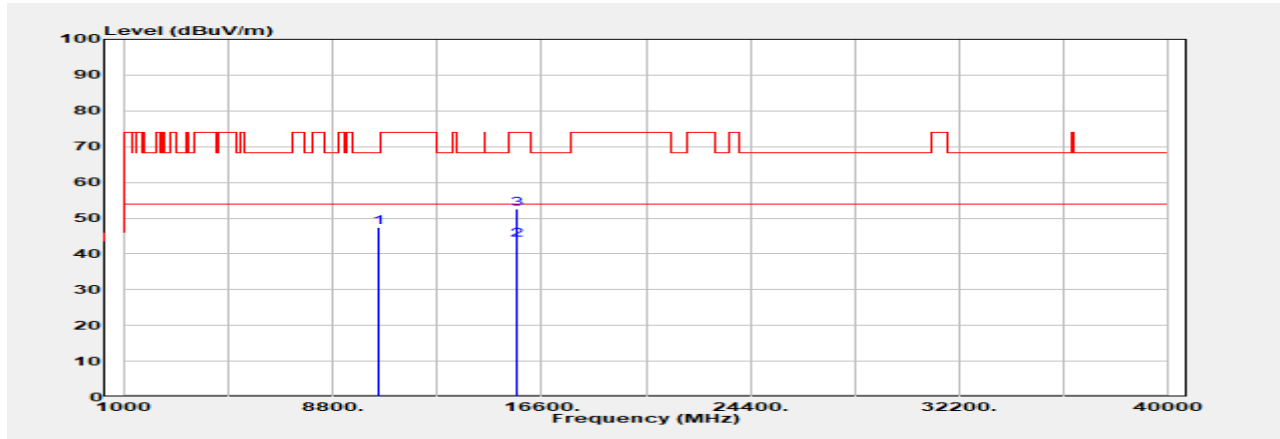

Freq. MHz	Detector Mode PK/QP/AVG	Spectrum Reading Level dB μ V	Factor dB	Actual FS dB μ V/m	Limit @3m dB μ V/m	Margin dB
10460.000	Peak	37.60	9.74	47.34	68.20	-20.86
15690.000	Average	31.40	12.53	43.93	54.00	-10.07
15690.000	Peak	39.95	12.53	52.48	74.00	-21.52

Unless otherwise stated the results shown in this test report refer only to the sample(s) tested and such sample(s) are retained for 90 days only.

除非另有說明，此報告結果僅對測試之樣品負責，同時此樣品僅保留90天。本報告未經本公司書面許可，不可部份複製。

This document is issued by the Company subject to its General Conditions of Service printed overleaf, available on request or accessible at <http://www.sgs.com.tw/Terms-and-Conditions> and for electronic format documents, subject to Terms and Conditions for Electronic Documents at <http://www.sgs.com.tw/Terms-and-Conditions>. Attention is drawn to the limitation of liability, indemnification and jurisdiction issues defined therein. Any holder of this document is advised that information contained hereon reflects the Company's findings at the time of its intervention only and within the limits of Client's instructions, if any. The Company's sole responsibility is to its Client and this document does not exonerate parties to a transaction from exercising all their rights and obligations under the transaction documents. This document cannot be reproduced except in full, without prior written approval of the Company. Any unauthorized alteration, forgery or falsification of the content or appearance of this document is unlawful and offenders may be prosecuted to the fullest extent of the law.

Report Number :TERF2308001923E2
 Operation Mode :802.11be40
 Test Frequency :5230 MHz
 Test Mode :Tx
 EUT Pol :E2 Plane

Test Site :SAC G Chamber
 Test Date :2023-08-25
 Temp./Humi. :25.9°C/57%
 Antenna Pol. :Horizontal
 Engineer :Temo Chen

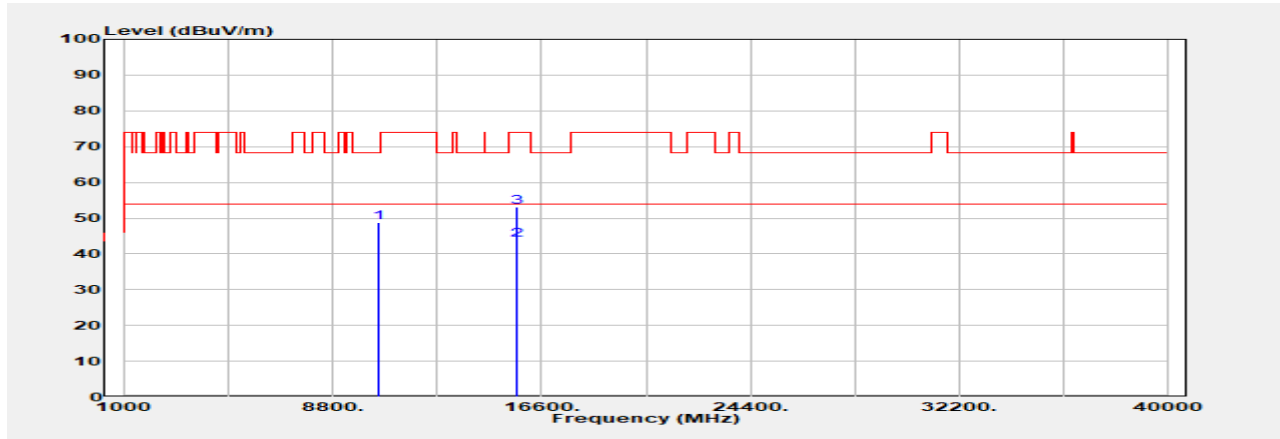

Freq. MHz	Detector Mode PK/QP/AVG	Spectrum Reading Level dB μ V	Factor dB	Actual FS dB μ V/m	Limit @3m dB μ V/m	Margin dB
10460.000	Peak	39.02	9.74	48.76	68.20	-19.44
15690.000	Average	31.50	12.53	44.03	54.00	-9.97
15690.000	Peak	40.65	12.53	53.18	74.00	-20.82

Unless otherwise stated the results shown in this test report refer only to the sample(s) tested and such sample(s) are retained for 90 days only.

除非另有說明，此報告結果僅對測試之樣品負責，同時此樣品僅保留90天。本報告未經本公司書面許可，不可部份複製。

This document is issued by the Company subject to its General Conditions of Service printed overleaf, available on request or accessible at <http://www.sgs.com.tw/Terms-and-Conditions> and for electronic format documents, subject to Terms and Conditions for Electronic Documents at <http://www.sgs.com.tw/Terms-and-Conditions>. Attention is drawn to the limitation of liability, indemnification and jurisdiction issues defined therein. Any holder of this document is advised that information contained hereon reflects the Company's findings at the time of its intervention only and within the limits of Client's instructions, if any. The Company's sole responsibility is to its Client and this document does not exonerate parties to a transaction from exercising all their rights and obligations under the transaction documents. This document cannot be reproduced except in full, without prior written approval of the Company. Any unauthorized alteration, forgery or falsification of the content or appearance of this document is unlawful and offenders may be prosecuted to the fullest extent of the law.

Report Number :TERF2308001923E2	Test Site :SAC G Chamber
Operation Mode :802.11be40	Test Date :2023-08-25
Test Frequency :5270 MHz	Temp./Humi. :25.9°C/57%
Test Mode :Tx	Antenna Pol. :Vertical
EUT Pol :E2 Plane	Engineer :Temo Chen

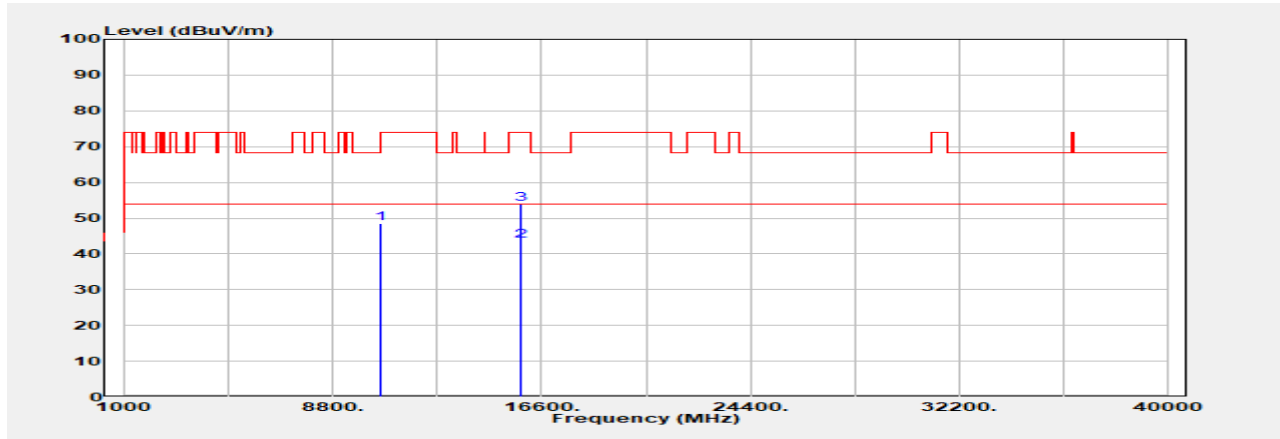

Freq. MHz	Detector Mode PK/QP/AVG	Spectrum Reading Level dB μ V	Factor dB	Actual FS dB μ V/m	Limit @3m dB μ V/m	Margin dB
10540.000	Peak	38.57	9.94	48.51	68.20	-19.69
15810.000	Average	31.20	12.38	43.58	54.00	-10.42
15810.000	Peak	41.65	12.38	54.03	74.00	-19.97

Unless otherwise stated the results shown in this test report refer only to the sample(s) tested and such sample(s) are retained for 90 days only.

除非另有說明，此報告結果僅對測試之樣品負責，同時此樣品僅保留90天。本報告未經本公司書面許可，不可部份複製。

This document is issued by the Company subject to its General Conditions of Service printed overleaf, available on request or accessible at <http://www.sgs.com.tw/Terms-and-Conditions> and for electronic format documents, subject to Terms and Conditions for Electronic Documents at <http://www.sgs.com.tw/Terms-and-Conditions>. Attention is drawn to the limitation of liability, indemnification and jurisdiction issues defined therein. Any holder of this document is advised that information contained hereon reflects the Company's findings at the time of its intervention only and within the limits of Client's instructions, if any. The Company's sole responsibility is to its Client and this document does not exonerate parties to a transaction from exercising all their rights and obligations under the transaction documents. This document cannot be reproduced except in full, without prior written approval of the Company. Any unauthorized alteration, forgery or falsification of the content or appearance of this document is unlawful and offenders may be prosecuted to the fullest extent of the law.

Report Number :TERF2308001923E2
 Operation Mode :802.11be40
 Test Frequency :5270 MHz
 Test Mode :Tx
 EUT Pol :E2 Plane

Test Site :SAC G Chamber
 Test Date :2023-08-25
 Temp./Humi. :25.9°C/57%
 Antenna Pol. :Horizontal
 Engineer :Temo Chen

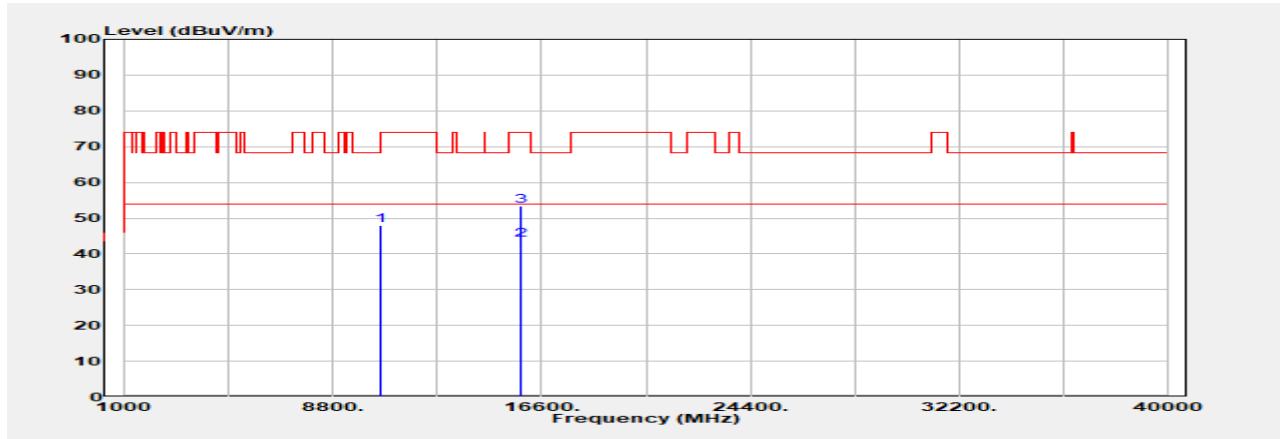

Freq. MHz	Detector Mode PK/QP/AVG	Spectrum Reading Level dBμV	Factor dB	Actual FS dBμV/m	Limit @3m dBμV/m	Margin dB
10540.000	Peak	38.09	9.94	48.03	68.20	-20.17
15810.000	Average	31.57	12.38	43.95	54.00	-10.05
15810.000	Peak	41.06	12.38	53.44	74.00	-20.56

Unless otherwise stated the results shown in this test report refer only to the sample(s) tested and such sample(s) are retained for 90 days only.

除非另有說明，此報告結果僅對測試之樣品負責，同時此樣品僅保留90天。本報告未經本公司書面許可，不可部份複製。

This document is issued by the Company subject to its General Conditions of Service printed overleaf, available on request or accessible at <http://www.sgs.com.tw/Terms-and-Conditions> and for electronic format documents, subject to Terms and Conditions for Electronic Documents at <http://www.sgs.com.tw/Terms-and-Conditions>. Attention is drawn to the limitation of liability, indemnification and jurisdiction issues defined therein. Any holder of this document is advised that information contained hereon reflects the Company's findings at the time of its intervention only and within the limits of Client's instructions, if any. The Company's sole responsibility is to its Client and this document does not exonerate parties to a transaction from exercising all their rights and obligations under the transaction documents. This document cannot be reproduced except in full, without prior written approval of the Company. Any unauthorized alteration, forgery or falsification of the content or appearance of this document is unlawful and offenders may be prosecuted to the fullest extent of the law.

Report Number :TERF2308001923E2
 Operation Mode :802.11be40
 Test Frequency :5310 MHz
 Test Mode :Tx
 EUT Pol :E2 Plane

Test Site :SAC G Chamber
 Test Date :2023-10-20
 Temp./Humi. :21.3°C/68%
 Antenna Pol. :Vertical
 Engineer :Temo Chen

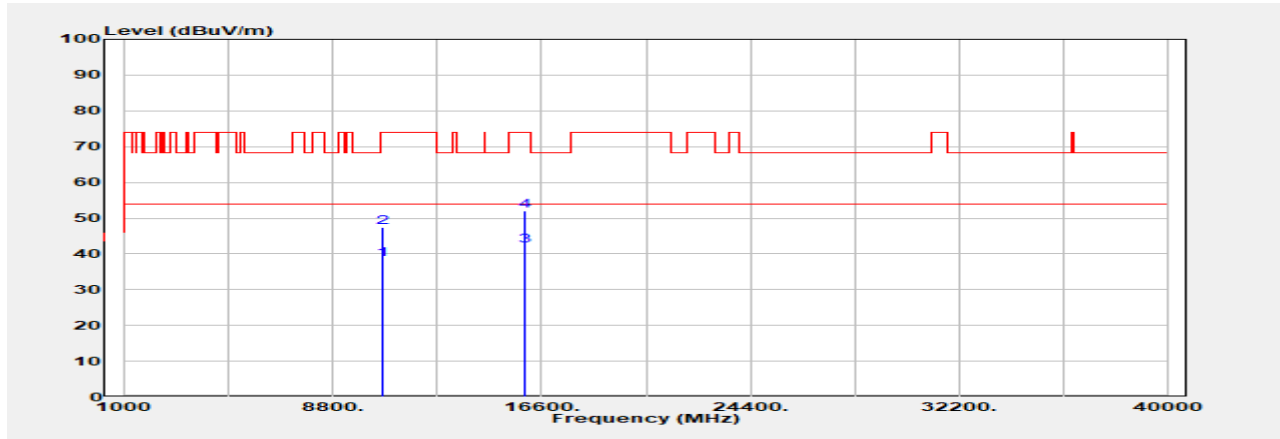

Freq. MHz	Detector Mode PK/QP/AVG	Spectrum Reading Level dBμV	Factor dB	Actual FS dBμV/m	Limit @3m dBμV/m	Margin dB
10620.000	Average	28.64	9.86	38.50	54.00	-15.50
10620.000	Peak	37.69	9.86	47.55	74.00	-26.45
15930.000	Average	30.14	12.05	42.19	54.00	-11.81
15930.000	Peak	40.03	12.05	52.08	74.00	-21.92

Unless otherwise stated the results shown in this test report refer only to the sample(s) tested and such sample(s) are retained for 90 days only.

除非另有說明，此報告結果僅對測試之樣品負責，同時此樣品僅保留90天。本報告未經本公司書面許可，不可部份複製。

This document is issued by the Company subject to its General Conditions of Service printed overleaf, available on request or accessible at <http://www.sgs.com.tw/Terms-and-Conditions> and for electronic format documents, subject to Terms and Conditions for Electronic Documents at <http://www.sgs.com.tw/Terms-and-Conditions>. Attention is drawn to the limitation of liability, indemnification and jurisdiction issues defined therein. Any holder of this document is advised that information contained hereon reflects the Company's findings at the time of its intervention only and within the limits of Client's instructions, if any. The Company's sole responsibility is to its Client and this document does not exonerate parties to a transaction from exercising all their rights and obligations under the transaction documents. This document cannot be reproduced except in full, without prior written approval of the Company. Any unauthorized alteration, forgery or falsification of the content or appearance of this document is unlawful and offenders may be prosecuted to the fullest extent of the law.

Report Number :TERF2308001923E2
 Operation Mode :802.11be40
 Test Frequency :5310 MHz
 Test Mode :Tx
 EUT Pol :E2 Plane

Test Site :SAC G Chamber
 Test Date :2023-10-20
 Temp./Humi. :21.3°C/68%
 Antenna Pol. :Horizontal
 Engineer :Temo Chen

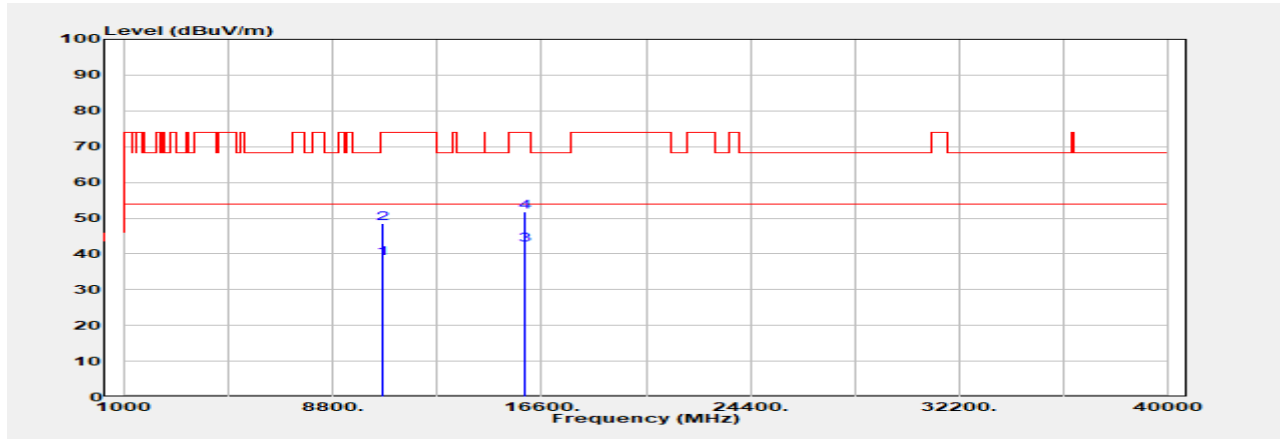

Freq. MHz	Detector Mode PK/QP/AVG	Spectrum Reading Level dBμV	Factor dB	Actual FS dBμV/m	Limit @3m dBμV/m	Margin dB
10620.000	Average	28.76	9.86	38.62	54.00	-15.38
10620.000	Peak	38.77	9.86	48.63	74.00	-25.37
15930.000	Average	30.58	12.05	42.63	54.00	-11.37
15930.000	Peak	39.69	12.05	51.74	74.00	-22.26

Unless otherwise stated the results shown in this test report refer only to the sample(s) tested and such sample(s) are retained for 90 days only.

除非另有說明，此報告結果僅對測試之樣品負責，同時此樣品僅保留90天。本報告未經本公司書面許可，不可部份複製。

This document is issued by the Company subject to its General Conditions of Service printed overleaf, available on request or accessible at <http://www.sgs.com.tw/Terms-and-Conditions> and for electronic format documents, subject to Terms and Conditions for Electronic Documents at <http://www.sgs.com.tw/Terms-and-Conditions>. Attention is drawn to the limitation of liability, indemnification and jurisdiction issues defined therein. Any holder of this document is advised that information contained hereon reflects the Company's findings at the time of its intervention only and within the limits of Client's instructions, if any. The Company's sole responsibility is to its Client and this document does not exonerate parties to a transaction from exercising all their rights and obligations under the transaction documents. This document cannot be reproduced except in full, without prior written approval of the Company. Any unauthorized alteration, forgery or falsification of the content or appearance of this document is unlawful and offenders may be prosecuted to the fullest extent of the law.

Report Number :TERF2308001923E2
 Operation Mode :802.11be40
 Test Frequency :5510 MHz
 Test Mode :Tx
 EUT Pol :E2 Plane

Test Site :SAC G Chamber
 Test Date :2023-08-25
 Temp./Humi. :25.9°C/57%
 Antenna Pol. :Vertical
 Engineer :Temo Chen

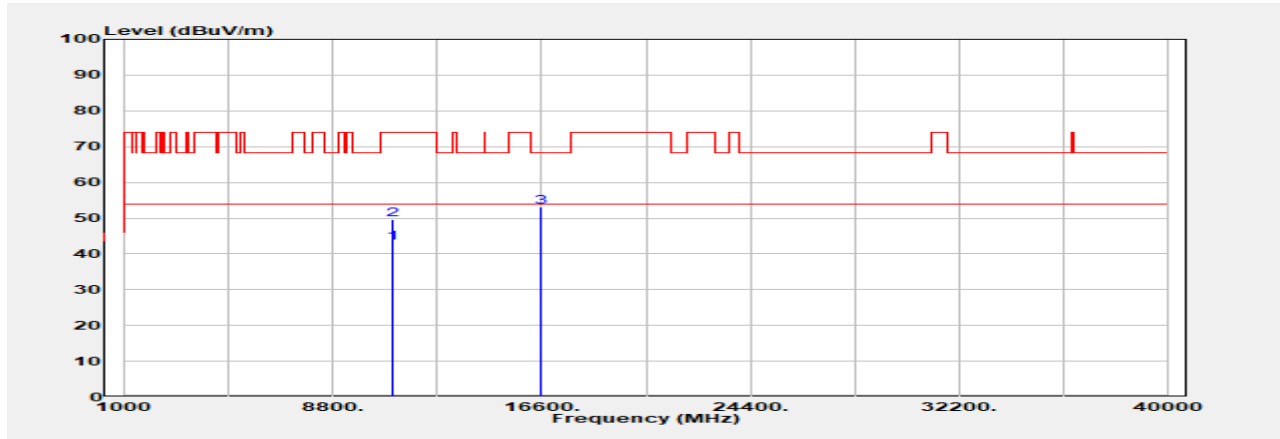

Freq. MHz	Detector Mode PK/QP/AVG	Spectrum Reading Level dBμV	Factor dB	Actual FS dBμV/m	Limit @3m dBμV/m	Margin dB
11020.000	Average	31.57	11.46	43.03	54.00	-10.97
11020.000	Peak	38.04	11.46	49.50	74.00	-24.50
16530.000	Peak	41.07	11.94	53.01	68.20	-15.19

Unless otherwise stated the results shown in this test report refer only to the sample(s) tested and such sample(s) are retained for 90 days only.

除非另有說明，此報告結果僅對測試之樣品負責，同時此樣品僅保留90天。本報告未經本公司書面許可，不可部份複製。

This document is issued by the Company subject to its General Conditions of Service printed overleaf, available on request or accessible at <http://www.sgs.com.tw/Terms-and-Conditions> and for electronic format documents, subject to Terms and Conditions for Electronic Documents at <http://www.sgs.com.tw/Terms-and-Conditions>. Attention is drawn to the limitation of liability, indemnification and jurisdiction issues defined therein. Any holder of this document is advised that information contained hereon reflects the Company's findings at the time of its intervention only and within the limits of Client's instructions, if any. The Company's sole responsibility is to its Client and this document does not exonerate parties to a transaction from exercising all their rights and obligations under the transaction documents. This document cannot be reproduced except in full, without prior written approval of the Company. Any unauthorized alteration, forgery or falsification of the content or appearance of this document is unlawful and offenders may be prosecuted to the fullest extent of the law.

Report Number :TERF2308001923E2
 Operation Mode :802.11be40
 Test Frequency :5510 MHz
 Test Mode :Tx
 EUT Pol :E2 Plane

Test Site :SAC G Chamber
 Test Date :2023-08-25
 Temp./Humi. :25.9°C/57%
 Antenna Pol. :Horizontal
 Engineer :Temo Chen

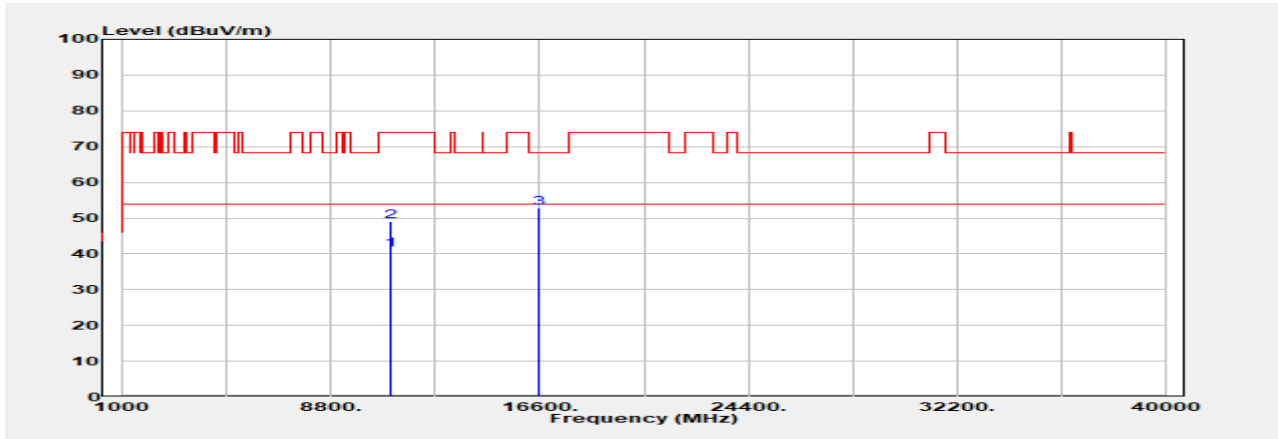

Freq. MHz	Detector Mode PK/QP/AVG	Spectrum Reading Level dB μ V	Factor dB	Actual FS dB μ V/m	Limit @3m dB μ V/m	Margin dB
11020.000	Average	29.81	11.46	41.27	54.00	-12.73
11020.000	Peak	37.71	11.46	49.17	74.00	-24.83
16530.000	Peak	40.90	11.94	52.84	68.20	-15.36

Unless otherwise stated the results shown in this test report refer only to the sample(s) tested and such sample(s) are retained for 90 days only.

除非另有說明，此報告結果僅對測試之樣品負責，同時此樣品僅保留90天。本報告未經本公司書面許可，不可部份複製。

This document is issued by the Company subject to its General Conditions of Service printed overleaf, available on request or accessible at <http://www.sgs.com.tw/Terms-and-Conditions> and for electronic format documents, subject to Terms and Conditions for Electronic Documents at <http://www.sgs.com.tw/Terms-and-Conditions>. Attention is drawn to the limitation of liability, indemnification and jurisdiction issues defined therein. Any holder of this document is advised that information contained hereon reflects the Company's findings at the time of its intervention only and within the limits of Client's instructions, if any. The Company's sole responsibility is to its Client and this document does not exonerate parties to a transaction from exercising all their rights and obligations under the transaction documents. This document cannot be reproduced except in full, without prior written approval of the Company. Any unauthorized alteration, forgery or falsification of the content or appearance of this document is unlawful and offenders may be prosecuted to the fullest extent of the law.

Report Number :TERF2308001923E2
 Operation Mode :802.11be40
 Test Frequency :5550 MHz
 Test Mode :Tx
 EUT Pol :E2 Plane

Test Site :SAC G Chamber
 Test Date :2023-08-25
 Temp./Humi. :25.9°C/57%
 Antenna Pol. :Vertical
 Engineer :Temo Chen

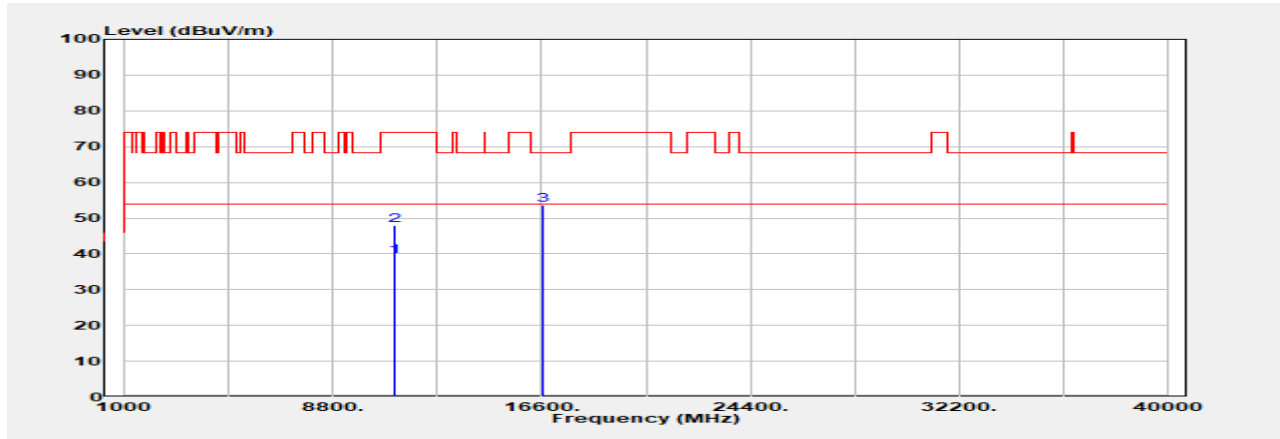

Freq. MHz	Detector Mode PK/QP/AVG	Spectrum Reading Level dBμV	Factor dB	Actual FS dBμV/m	Limit @3m dBμV/m	Margin dB
11100.000	Average	29.55	9.70	39.25	54.00	-14.75
11100.000	Peak	38.29	9.70	47.99	74.00	-26.01
16650.000	Peak	41.93	11.75	53.68	68.20	-14.52

Unless otherwise stated the results shown in this test report refer only to the sample(s) tested and such sample(s) are retained for 90 days only.

除非另有說明，此報告結果僅對測試之樣品負責，同時此樣品僅保留90天。本報告未經本公司書面許可，不可部份複製。

This document is issued by the Company subject to its General Conditions of Service printed overleaf, available on request or accessible at <http://www.sgs.com.tw/Terms-and-Conditions> and for electronic format documents, subject to Terms and Conditions for Electronic Documents at <http://www.sgs.com.tw/Terms-and-Conditions>. Attention is drawn to the limitation of liability, indemnification and jurisdiction issues defined therein. Any holder of this document is advised that information contained hereon reflects the Company's findings at the time of its intervention only and within the limits of Client's instructions, if any. The Company's sole responsibility is to its Client and this document does not exonerate parties to a transaction from exercising all their rights and obligations under the transaction documents. This document cannot be reproduced except in full, without prior written approval of the Company. Any unauthorized alteration, forgery or falsification of the content or appearance of this document is unlawful and offenders may be prosecuted to the fullest extent of the law.

Report Number :TERF2308001923E2
 Operation Mode :802.11be40
 Test Frequency :5550 MHz
 Test Mode :Tx
 EUT Pol :E2 Plane

Test Site :SAC G Chamber
 Test Date :2023-08-25
 Temp./Humi. :25.9°C/57%
 Antenna Pol. :Horizontal
 Engineer :Temo Chen

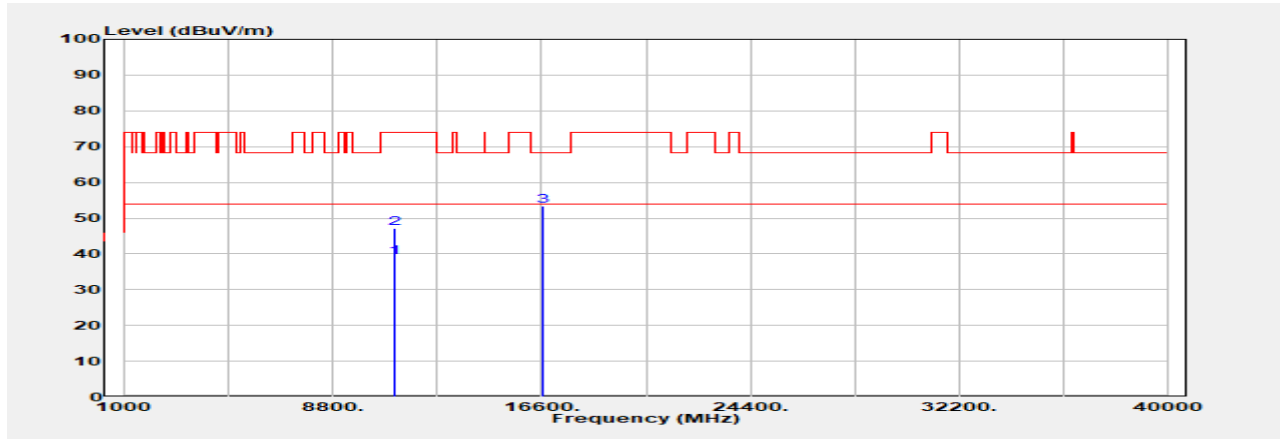

Freq. MHz	Detector Mode PK/QP/AVG	Spectrum Reading Level dBμV	Factor dB	Actual FS dBμV/m	Limit @3m dBμV/m	Margin dB
11100.000	Average	29.37	9.70	39.07	54.00	-14.93
11100.000	Peak	37.43	9.70	47.13	74.00	-26.87
16650.000	Peak	41.74	11.75	53.49	68.20	-14.71

Unless otherwise stated the results shown in this test report refer only to the sample(s) tested and such sample(s) are retained for 90 days only.

除非另有說明，此報告結果僅對測試之樣品負責，同時此樣品僅保留90天。本報告未經本公司書面許可，不可部份複製。

This document is issued by the Company subject to its General Conditions of Service printed overleaf, available on request or accessible at <http://www.sgs.com.tw/Terms-and-Conditions> and for electronic format documents, subject to Terms and Conditions for Electronic Documents at <http://www.sgs.com.tw/Terms-and-Conditions>. Attention is drawn to the limitation of liability, indemnification and jurisdiction issues defined therein. Any holder of this document is advised that information contained hereon reflects the Company's findings at the time of its intervention only and within the limits of Client's instructions, if any. The Company's sole responsibility is to its Client and this document does not exonerate parties to a transaction from exercising all their rights and obligations under the transaction documents. This document cannot be reproduced except in full, without prior written approval of the Company. Any unauthorized alteration, forgery or falsification of the content or appearance of this document is unlawful and offenders may be prosecuted to the fullest extent of the law.

Report Number :TERF2308001923E2

Test Site :SAC G Chamber

Operation Mode :802.11be40

Test Date :2023-08-25

Test Frequency :5670 MHz

Temp./Humi. :25.9°C/57%

Test Mode :Tx

Antenna Pol. :Vertical

EUT Pol :E2 Plane

Engineer :Temo Chen

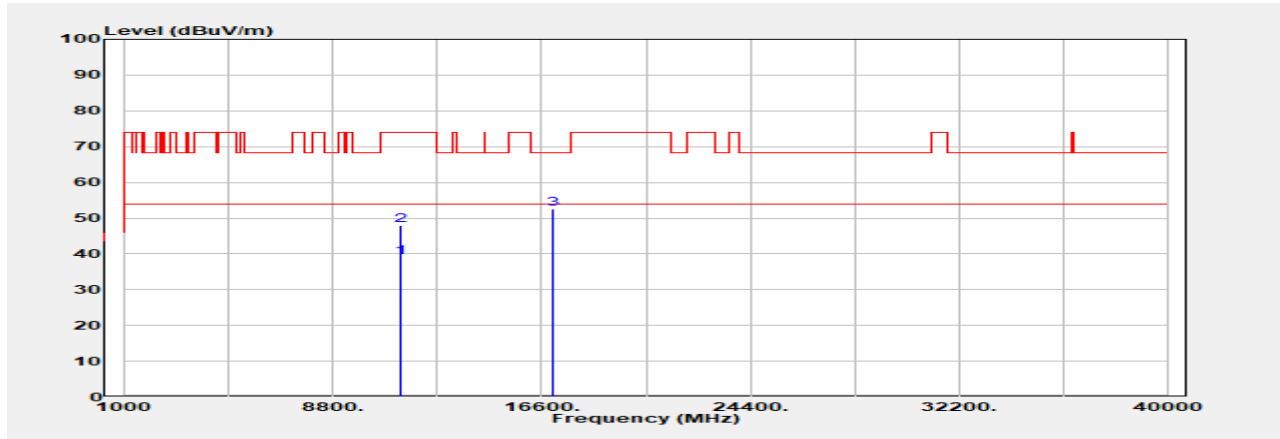

Freq. MHz	Detector Mode PK/QP/AVG	Spectrum Reading Level dBμV	Factor dB	Actual FS dBμV/m	Limit @3m dBμV/m	Margin dB
11340.000	Average	29.15	9.74	38.89	54.00	-15.11
11340.000	Peak	38.29	9.74	48.03	74.00	-25.97
17010.000	Peak	40.82	11.84	52.66	68.20	-15.54

Unless otherwise stated the results shown in this test report refer only to the sample(s) tested and such sample(s) are retained for 90 days only.

除非另有說明，此報告結果僅對測試之樣品負責，同時此樣品僅保留90天。本報告未經本公司書面許可，不可部份複製。

This document is issued by the Company subject to its General Conditions of Service printed overleaf, available on request or accessible at <http://www.sgs.com.tw/Terms-and-Conditions> and for electronic format documents, subject to Terms and Conditions for Electronic Documents at <http://www.sgs.com.tw/Terms-and-Conditions>. Attention is drawn to the limitation of liability, indemnification and jurisdiction issues defined therein. Any holder of this document is advised that information contained hereon reflects the Company's findings at the time of its intervention only and within the limits of Client's instructions, if any. The Company's sole responsibility is to its Client and this document does not exonerate parties to a transaction from exercising all their rights and obligations under the transaction documents. This document cannot be reproduced except in full, without prior written approval of the Company. Any unauthorized alteration, forgery or falsification of the content or appearance of this document is unlawful and offenders may be prosecuted to the fullest extent of the law.

Report Number :TERF2308001923E2

Test Site :SAC G Chamber

Operation Mode :802.11be40

Test Date :2023-08-25

Test Frequency :5670 MHz

Temp./Humi. :25.9°C/57%

Test Mode :Tx

Antenna Pol. :Horizontal

EUT Pol :E2 Plane

Engineer :Temo Chen



Freq. MHz	Detector Mode PK/QP/AVG	Spectrum Reading Level dB μ V	Factor dB	Actual FS dB μ V/m	Limit @3m dB μ V/m	Margin dB
11340.000	Average	29.67	9.74	39.41	54.00	-14.59
11340.000	Peak	38.25	9.74	47.99	74.00	-26.01
17010.000	Peak	40.54	11.84	52.38	68.20	-15.82

Unless otherwise stated the results shown in this test report refer only to the sample(s) tested and such sample(s) are retained for 90 days only.

除非另有說明，此報告結果僅對測試之樣品負責，同時此樣品僅保留90天。本報告未經本公司書面許可，不可部份複製。

This document is issued by the Company subject to its General Conditions of Service printed overleaf, available on request or accessible at <http://www.sgs.com.tw/Terms-and-Conditions> and for electronic format documents, subject to Terms and Conditions for Electronic Documents at <http://www.sgs.com.tw/Terms-and-Conditions>. Attention is drawn to the limitation of liability, indemnification and jurisdiction issues defined therein. Any holder of this document is advised that information contained hereon reflects the Company's findings at the time of its intervention only and within the limits of Client's instructions, if any. The Company's sole responsibility is to its Client and this document does not exonerate parties to a transaction from exercising all their rights and obligations under the transaction documents. This document cannot be reproduced except in full, without prior written approval of the Company. Any unauthorized alteration, forgery or falsification of the content or appearance of this document is unlawful and offenders may be prosecuted to the fullest extent of the law.

Report Number :TERF2308001923E2

Test Site :SAC G Chamber

Operation Mode :802.11be40

Test Date :2023-10-20

Test Frequency :5755 MHz

Temp./Humi. :21.3°C/68%

Test Mode :Tx

Antenna Pol. :Vertical

EUT Pol :E2 Plane

Engineer :Temo Chen

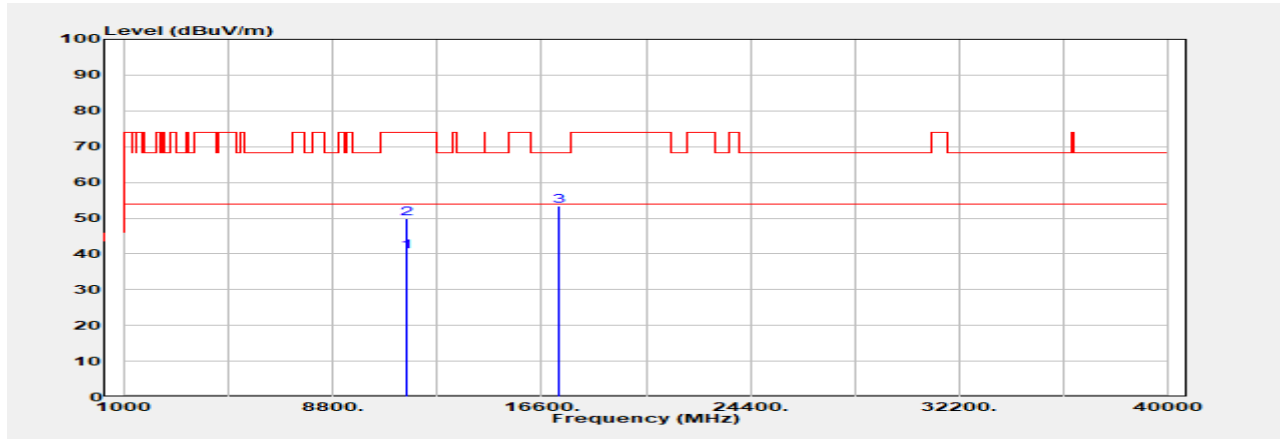

Freq. MHz	Detector Mode PK/QP/AVG	Spectrum Reading Level dB μ V	Factor dB	Actual FS dB μ V/m	Limit @3m dB μ V/m	Margin dB
11510.000	Average	29.56	11.05	40.61	54.00	-13.39
11510.000	Peak	38.78	11.05	49.83	74.00	-24.17
17265.000	Peak	42.21	11.18	53.39	68.20	-14.81

Unless otherwise stated the results shown in this test report refer only to the sample(s) tested and such sample(s) are retained for 90 days only.

除非另有說明，此報告結果僅對測試之樣品負責，同時此樣品僅保留90天。本報告未經本公司書面許可，不可部份複製。

This document is issued by the Company subject to its General Conditions of Service printed overleaf, available on request or accessible at <http://www.sgs.com.tw/Terms-and-Conditions> and for electronic format documents, subject to Terms and Conditions for Electronic Documents at <http://www.sgs.com.tw/Terms-and-Conditions>. Attention is drawn to the limitation of liability, indemnification and jurisdiction issues defined therein. Any holder of this document is advised that information contained hereon reflects the Company's findings at the time of its intervention only and within the limits of Client's instructions, if any. The Company's sole responsibility is to its Client and this document does not exonerate parties to a transaction from exercising all their rights and obligations under the transaction documents. This document cannot be reproduced except in full, without prior written approval of the Company. Any unauthorized alteration, forgery or falsification of the content or appearance of this document is unlawful and offenders may be prosecuted to the fullest extent of the law.

Report Number :TERF2308001923E2

Test Site :SAC G Chamber

Operation Mode :802.11be40

Test Date :2023-10-20

Test Frequency :5755 MHz

Temp./Humi. :21.3°C/68%

Test Mode :Tx

Antenna Pol. :Horizontal

EUT Pol :E2 Plane

Engineer :Temo Chen

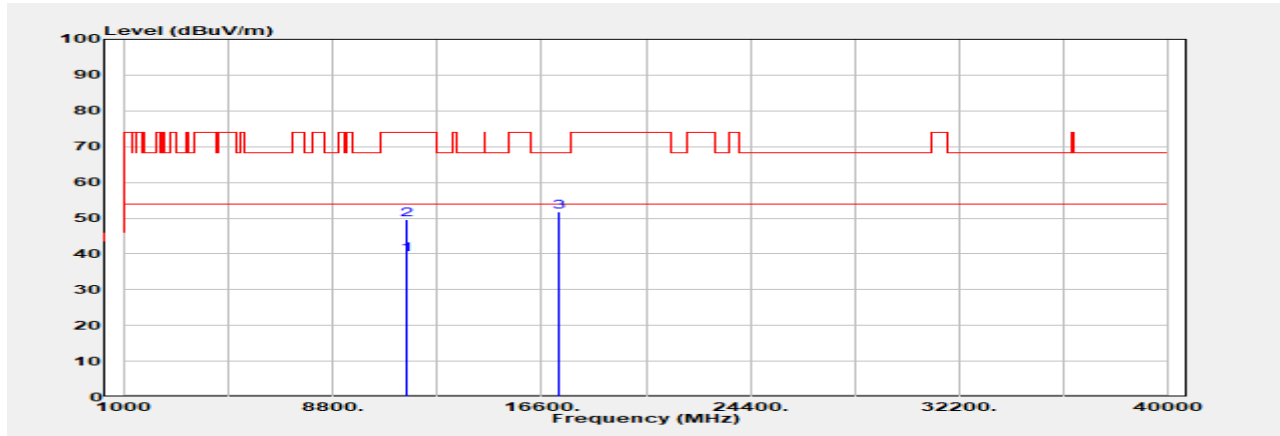

Freq. MHz	Detector Mode PK/QP/AVG	Spectrum Reading Level dBμV	Factor dB	Actual FS dBμV/m	Limit @3m dBμV/m	Margin dB
11510.000	Average	28.79	11.05	39.84	54.00	-14.16
11510.000	Peak	38.50	11.05	49.55	74.00	-24.45
17265.000	Peak	40.58	11.18	51.76	68.20	-16.44

Unless otherwise stated the results shown in this test report refer only to the sample(s) tested and such sample(s) are retained for 90 days only.

除非另有說明，此報告結果僅對測試之樣品負責，同時此樣品僅保留90天。本報告未經本公司書面許可，不可部份複製。

This document is issued by the Company subject to its General Conditions of Service printed overleaf, available on request or accessible at <http://www.sgs.com.tw/Terms-and-Conditions> and for electronic format documents, subject to Terms and Conditions for Electronic Documents at <http://www.sgs.com.tw/Terms-and-Conditions>. Attention is drawn to the limitation of liability, indemnification and jurisdiction issues defined therein. Any holder of this document is advised that information contained hereon reflects the Company's findings at the time of its intervention only and within the limits of Client's instructions, if any. The Company's sole responsibility is to its Client and this document does not exonerate parties to a transaction from exercising all their rights and obligations under the transaction documents. This document cannot be reproduced except in full, without prior written approval of the Company. Any unauthorized alteration, forgery or falsification of the content or appearance of this document is unlawful and offenders may be prosecuted to the fullest extent of the law.

Report Number :TERF2308001923E2
 Operation Mode :802.11be40
 Test Frequency :5795 MHz
 Test Mode :Tx
 EUT Pol :E2 Plane

Test Site :SAC G Chamber
 Test Date :2023-08-25
 Temp./Humi. :25.9°C/57%
 Antenna Pol. :Vertical
 Engineer :Temo Chen

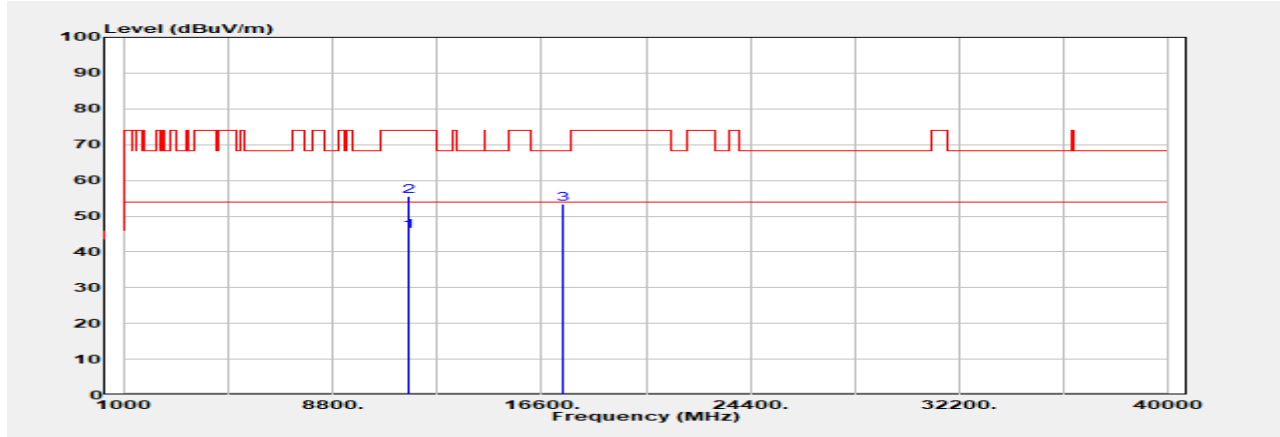

Freq. MHz	Detector Mode PK/QP/AVG	Spectrum Reading Level dB μ V	Factor dB	Actual FS dB μ V/m	Limit @3m dB μ V/m	Margin dB
11590.000	Average	35.91	9.85	45.76	54.00	-8.24
11590.000	Peak	45.63	9.85	55.48	74.00	-18.52
17385.000	Peak	41.50	11.94	53.44	68.20	-14.76

Unless otherwise stated the results shown in this test report refer only to the sample(s) tested and such sample(s) are retained for 90 days only.

除非另有說明，此報告結果僅對測試之樣品負責，同時此樣品僅保留90天。本報告未經本公司書面許可，不可部份複製。

This document is issued by the Company subject to its General Conditions of Service printed overleaf, available on request or accessible at <http://www.sgs.com.tw/Terms-and-Conditions> and for electronic format documents, subject to Terms and Conditions for Electronic Documents at <http://www.sgs.com.tw/Terms-and-Conditions>. Attention is drawn to the limitation of liability, indemnification and jurisdiction issues defined therein. Any holder of this document is advised that information contained hereon reflects the Company's findings at the time of its intervention only and within the limits of Client's instructions, if any. The Company's sole responsibility is to its Client and this document does not exonerate parties to a transaction from exercising all their rights and obligations under the transaction documents. This document cannot be reproduced except in full, without prior written approval of the Company. Any unauthorized alteration, forgery or falsification of the content or appearance of this document is unlawful and offenders may be prosecuted to the fullest extent of the law.

Report Number :TERF2308001923E2

Test Site :SAC G Chamber

Operation Mode :802.11be40

Test Date :2023-08-25

Test Frequency :5795 MHz

Temp./Humi. :25.9°C/57%

Test Mode :Tx

Antenna Pol. :Horizontal

EUT Pol :E2 Plane

Engineer :Temo Chen

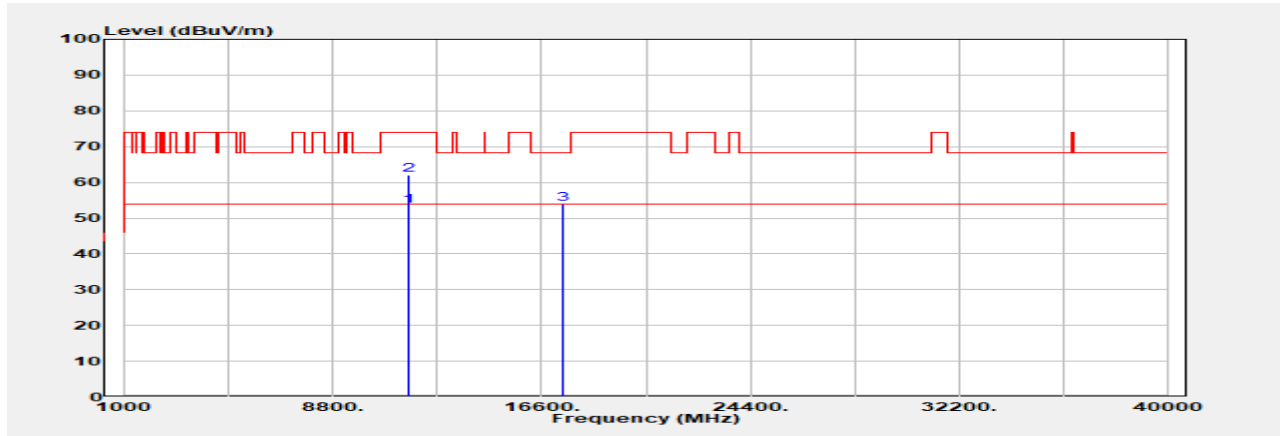

Freq. MHz	Detector Mode PK/QP/AVG	Spectrum Reading Level dBUV	Factor dB	Actual FS dBUV/m	Limit @3m dBUV/m	Margin dB
11590.000	Average	43.48	9.85	53.33	54.00	-0.67
11590.000	Peak	52.15	9.85	62.00	74.00	-12.00
17385.000	Peak	41.86	11.94	53.80	68.20	-14.40

Unless otherwise stated the results shown in this test report refer only to the sample(s) tested and such sample(s) are retained for 90 days only.

除非另有說明，此報告結果僅對測試之樣品負責，同時此樣品僅保留90天。本報告未經本公司書面許可，不可部份複製。

This document is issued by the Company subject to its General Conditions of Service printed overleaf, available on request or accessible at <http://www.sgs.com.tw/Terms-and-Conditions> and for electronic format documents, subject to Terms and Conditions for Electronic Documents at <http://www.sgs.com.tw/Terms-and-Conditions>. Attention is drawn to the limitation of liability, indemnification and jurisdiction issues defined therein. Any holder of this document is advised that information contained hereon reflects the Company's findings at the time of its intervention only and within the limits of Client's instructions, if any. The Company's sole responsibility is to its Client and this document does not exonerate parties to a transaction from exercising all their rights and obligations under the transaction documents. This document cannot be reproduced except in full, without prior written approval of the Company. Any unauthorized alteration, forgery or falsification of the content or appearance of this document is unlawful and offenders may be prosecuted to the fullest extent of the law.

Report Number :TERF2308001923E2
 Operation Mode :802.11be80
 Test Frequency :5210 MHz
 Test Mode :Tx
 EUT Pol :E2 Plane

Test Site :SAC G Chamber
 Test Date :2023-10-20
 Temp./Humi. :21.3°C/68%
 Antenna Pol. :Vertical
 Engineer :Temo Chen

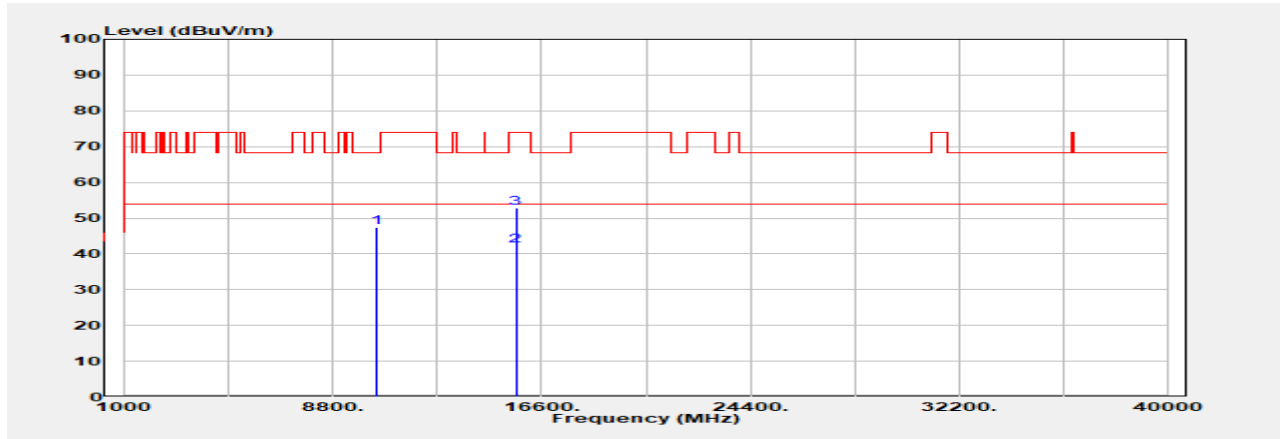

Freq. MHz	Detector Mode PK/QP/AVG	Spectrum Reading Level dB μ V	Factor dB	Actual FS dB μ V/m	Limit @3m dB μ V/m	Margin dB
10420.000	Peak	37.76	9.58	47.34	68.20	-20.86
15630.000	Average	30.10	12.11	42.21	54.00	-11.79
15630.000	Peak	40.74	12.11	52.85	74.00	-21.15

Unless otherwise stated the results shown in this test report refer only to the sample(s) tested and such sample(s) are retained for 90 days only.

除非另有說明，此報告結果僅對測試之樣品負責，同時此樣品僅保留90天。本報告未經本公司書面許可，不可部份複製。

This document is issued by the Company subject to its General Conditions of Service printed overleaf, available on request or accessible at <http://www.sgs.com.tw/Terms-and-Conditions> and for electronic format documents, subject to Terms and Conditions for Electronic Documents at <http://www.sgs.com.tw/Terms-and-Conditions>. Attention is drawn to the limitation of liability, indemnification and jurisdiction issues defined therein. Any holder of this document is advised that information contained hereon reflects the Company's findings at the time of its intervention only and within the limits of Client's instructions, if any. The Company's sole responsibility is to its Client and this document does not exonerate parties to a transaction from exercising all their rights and obligations under the transaction documents. This document cannot be reproduced except in full, without prior written approval of the Company. Any unauthorized alteration, forgery or falsification of the content or appearance of this document is unlawful and offenders may be prosecuted to the fullest extent of the law.

Report Number :TERF2308001923E2
 Operation Mode :802.11be80
 Test Frequency :5210 MHz
 Test Mode :Tx
 EUT Pol :E2 Plane

Test Site :SAC G Chamber
 Test Date :2023-10-20
 Temp./Humi. :21.3°C/68%
 Antenna Pol. :Horizontal
 Engineer :Temo Chen

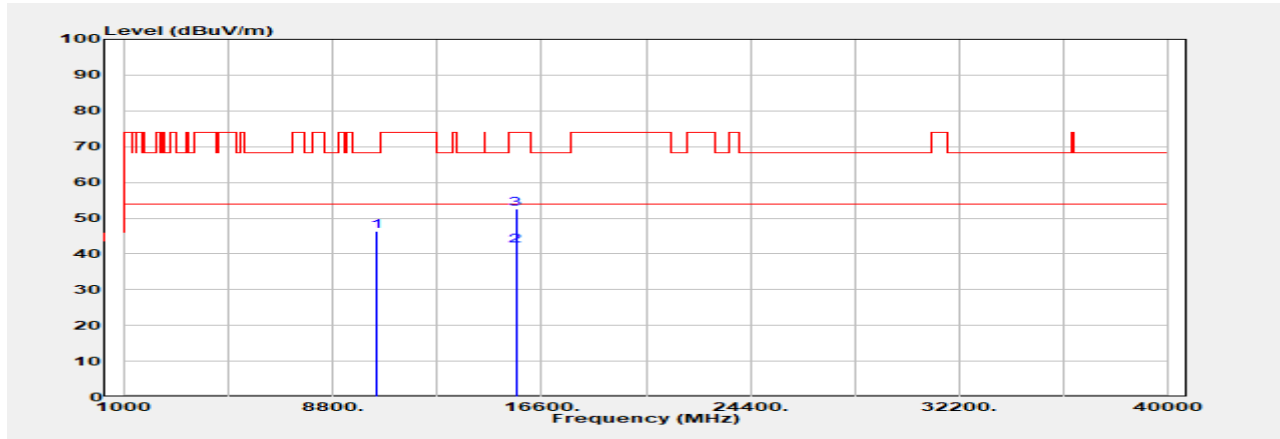

Freq. MHz	Detector Mode PK/QP/AVG	Spectrum Reading Level dB μ V	Factor dB	Actual FS dB μ V/m	Limit @3m dB μ V/m	Margin dB
10420.000	Peak	36.77	9.58	46.35	68.20	-21.85
15630.000	Average	30.19	12.11	42.30	54.00	-11.70
15630.000	Peak	40.47	12.11	52.58	74.00	-21.42

Unless otherwise stated the results shown in this test report refer only to the sample(s) tested and such sample(s) are retained for 90 days only.

除非另有說明，此報告結果僅對測試之樣品負責，同時此樣品僅保留90天。本報告未經本公司書面許可，不可部份複製。

This document is issued by the Company subject to its General Conditions of Service printed overleaf, available on request or accessible at <http://www.sgs.com.tw/Terms-and-Conditions> and for electronic format documents, subject to Terms and Conditions for Electronic Documents at <http://www.sgs.com.tw/Terms-and-Conditions>. Attention is drawn to the limitation of liability, indemnification and jurisdiction issues defined therein. Any holder of this document is advised that information contained hereon reflects the Company's findings at the time of its intervention only and within the limits of Client's instructions, if any. The Company's sole responsibility is to its Client and this document does not exonerate parties to a transaction from exercising all their rights and obligations under the transaction documents. This document cannot be reproduced except in full, without prior written approval of the Company. Any unauthorized alteration, forgery or falsification of the content or appearance of this document is unlawful and offenders may be prosecuted to the fullest extent of the law.

Report Number :TERF2308001923E2
 Operation Mode :802.11be80
 Test Frequency :5290 MHz
 Test Mode :Tx
 EUT Pol :E2 Plane

Test Site :SAC G Chamber
 Test Date :2023-10-20
 Temp./Humi. :21.3°C/68%
 Antenna Pol. :Vertical
 Engineer :Temo Chen

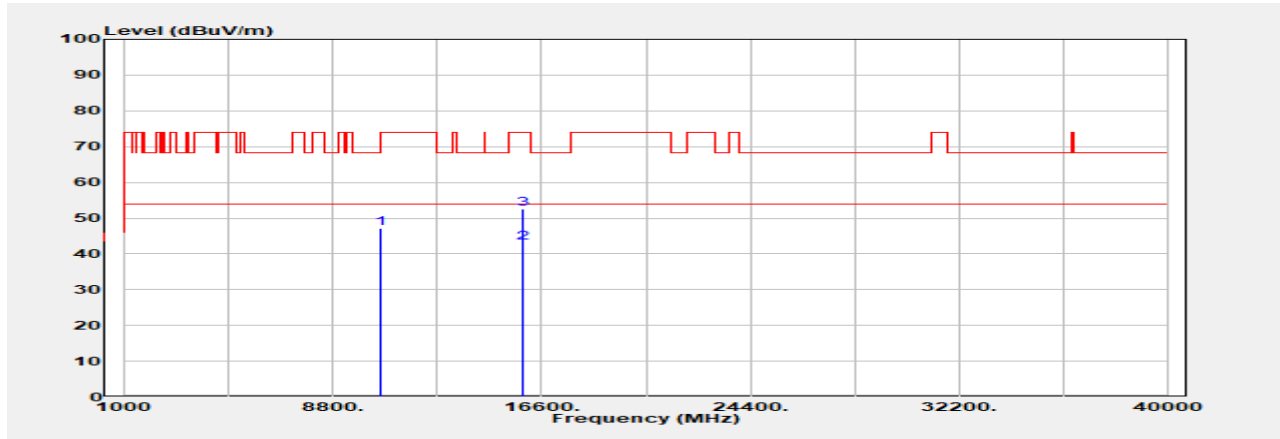

Freq. MHz	Detector Mode PK/QP/AVG	Spectrum Reading Level dBμV	Factor dB	Actual FS dBμV/m	Limit @3m dBμV/m	Margin dB
10580.000	Peak	37.26	9.98	47.24	68.20	-20.96
15870.000	Average	30.74	12.26	43.00	54.00	-11.00
15870.000	Peak	40.20	12.26	52.46	74.00	-21.54

Unless otherwise stated the results shown in this test report refer only to the sample(s) tested and such sample(s) are retained for 90 days only.

除非另有說明，此報告結果僅對測試之樣品負責，同時此樣品僅保留90天。本報告未經本公司書面許可，不可部份複製。

This document is issued by the Company subject to its General Conditions of Service printed overleaf, available on request or accessible at <http://www.sgs.com.tw/Terms-and-Conditions> and for electronic format documents, subject to Terms and Conditions for Electronic Documents at <http://www.sgs.com.tw/Terms-and-Conditions>. Attention is drawn to the limitation of liability, indemnification and jurisdiction issues defined therein. Any holder of this document is advised that information contained hereon reflects the Company's findings at the time of its intervention only and within the limits of Client's instructions, if any. The Company's sole responsibility is to its Client and this document does not exonerate parties to a transaction from exercising all their rights and obligations under the transaction documents. This document cannot be reproduced except in full, without prior written approval of the Company. Any unauthorized alteration, forgery or falsification of the content or appearance of this document is unlawful and offenders may be prosecuted to the fullest extent of the law.

Report Number :TERF2308001923E2
 Operation Mode :802.11be80
 Test Frequency :5290 MHz
 Test Mode :Tx
 EUT Pol :E2 Plane

Test Site :SAC G Chamber
 Test Date :2023-10-20
 Temp./Humi. :21.3°C/68%
 Antenna Pol. :Horizontal
 Engineer :Temo Chen

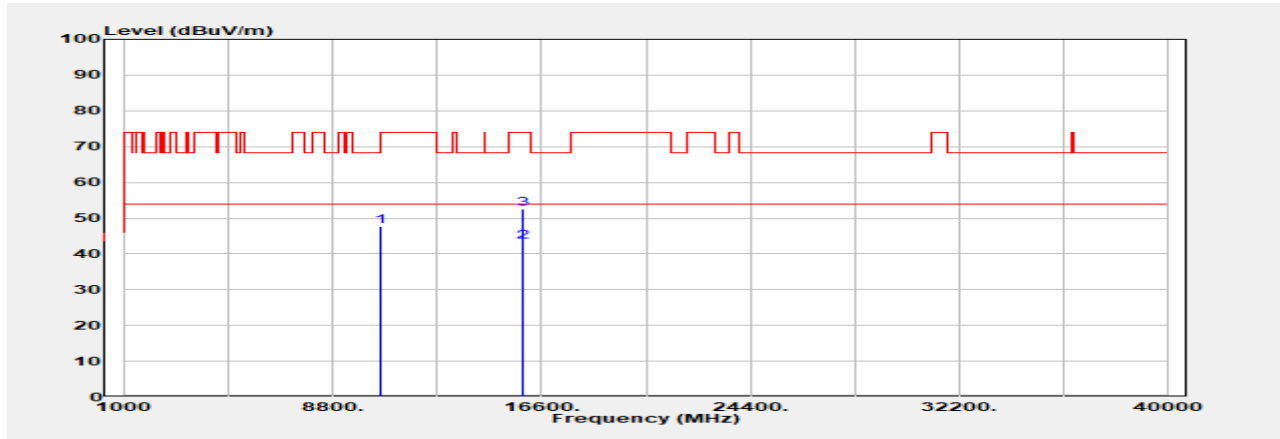

Freq. MHz	Detector Mode PK/QP/AVG	Spectrum Reading Level dB μ V	Factor dB	Actual FS dB μ V/m	Limit @3m dB μ V/m	Margin dB
10580.000	Peak	37.84	9.98	47.82	68.20	-20.38
15870.000	Average	31.22	12.26	43.48	54.00	-10.52
15870.000	Peak	40.18	12.26	52.44	74.00	-21.56

Unless otherwise stated the results shown in this test report refer only to the sample(s) tested and such sample(s) are retained for 90 days only.

除非另有說明，此報告結果僅對測試之樣品負責，同時此樣品僅保留90天。本報告未經本公司書面許可，不可部份複製。

This document is issued by the Company subject to its General Conditions of Service printed overleaf, available on request or accessible at <http://www.sgs.com.tw/Terms-and-Conditions> and for electronic format documents, subject to Terms and Conditions for Electronic Documents at <http://www.sgs.com.tw/Terms-and-Conditions>. Attention is drawn to the limitation of liability, indemnification and jurisdiction issues defined therein. Any holder of this document is advised that information contained hereon reflects the Company's findings at the time of its intervention only and within the limits of Client's instructions, if any. The Company's sole responsibility is to its Client and this document does not exonerate parties to a transaction from exercising all their rights and obligations under the transaction documents. This document cannot be reproduced except in full, without prior written approval of the Company. Any unauthorized alteration, forgery or falsification of the content or appearance of this document is unlawful and offenders may be prosecuted to the fullest extent of the law.

Report Number :TERF2308001923E2
 Operation Mode :802.11be80
 Test Frequency :5530 MHz
 Test Mode :Tx
 EUT Pol :E2 Plane

Test Site :SAC G Chamber
 Test Date :2023-10-20
 Temp./Humi. :21.3°C/68%
 Antenna Pol. :Vertical
 Engineer :Temo Chen

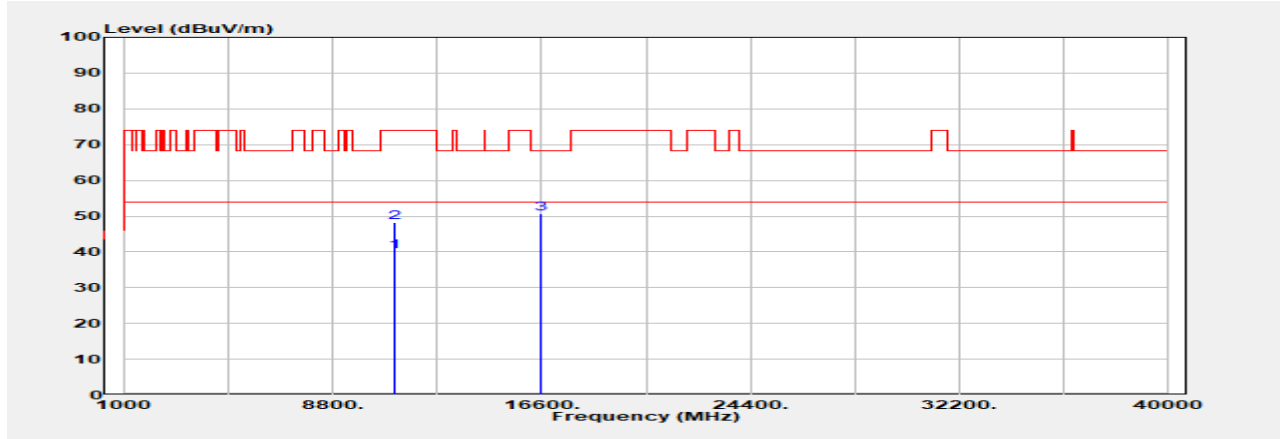

Freq. MHz	Detector Mode PK/QP/AVG	Spectrum Reading Level dBμV	Factor dB	Actual FS dBμV/m	Limit @3m dBμV/m	Margin dB
11060.000	Average	29.43	10.58	40.01	54.00	-13.99
11060.000	Peak	37.72	10.58	48.30	74.00	-25.70
16590.000	Peak	38.85	11.82	50.67	68.20	-17.53

Unless otherwise stated the results shown in this test report refer only to the sample(s) tested and such sample(s) are retained for 90 days only.

除非另有說明，此報告結果僅對測試之樣品負責，同時此樣品僅保留90天。本報告未經本公司書面許可，不可部份複製。

This document is issued by the Company subject to its General Conditions of Service printed overleaf, available on request or accessible at <http://www.sgs.com.tw/Terms-and-Conditions> and for electronic format documents, subject to Terms and Conditions for Electronic Documents at <http://www.sgs.com.tw/Terms-and-Conditions>. Attention is drawn to the limitation of liability, indemnification and jurisdiction issues defined therein. Any holder of this document is advised that information contained hereon reflects the Company's findings at the time of its intervention only and within the limits of Client's instructions, if any. The Company's sole responsibility is to its Client and this document does not exonerate parties to a transaction from exercising all their rights and obligations under the transaction documents. This document cannot be reproduced except in full, without prior written approval of the Company. Any unauthorized alteration, forgery or falsification of the content or appearance of this document is unlawful and offenders may be prosecuted to the fullest extent of the law.

Report Number :TERF2308001923E2
 Operation Mode :802.11be80
 Test Frequency :5530 MHz
 Test Mode :Tx
 EUT Pol :E2 Plane

Test Site :SAC G Chamber
 Test Date :2023-10-20
 Temp./Humi. :21.3°C/68%
 Antenna Pol. :Horizontal
 Engineer :Temo Chen

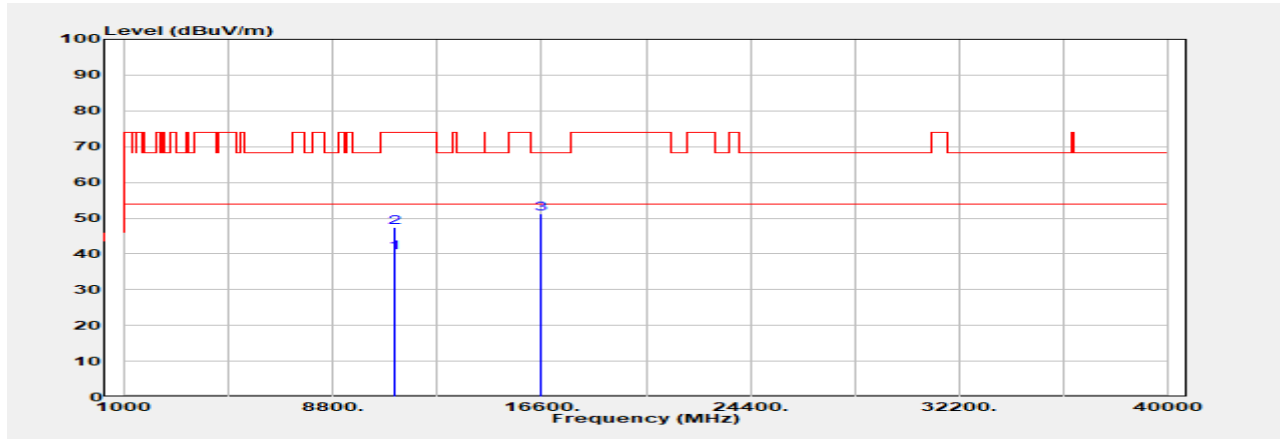

Freq. MHz	Detector Mode PK/QP/AVG	Spectrum Reading Level dB μ V	Factor dB	Actual FS dB μ V/m	Limit @3m dB μ V/m	Margin dB
11060.000	Average	29.69	10.58	40.27	54.00	-13.73
11060.000	Peak	36.76	10.58	47.33	74.00	-26.67
16590.000	Peak	39.49	11.82	51.31	68.20	-16.89

Unless otherwise stated the results shown in this test report refer only to the sample(s) tested and such sample(s) are retained for 90 days only.

除非另有說明，此報告結果僅對測試之樣品負責，同時此樣品僅保留90天。本報告未經本公司書面許可，不可部份複製。

This document is issued by the Company subject to its General Conditions of Service printed overleaf, available on request or accessible at <http://www.sgs.com.tw/Terms-and-Conditions> and for electronic format documents, subject to Terms and Conditions for Electronic Documents at <http://www.sgs.com.tw/Terms-and-Conditions>. Attention is drawn to the limitation of liability, indemnification and jurisdiction issues defined therein. Any holder of this document is advised that information contained hereon reflects the Company's findings at the time of its intervention only and within the limits of Client's instructions, if any. The Company's sole responsibility is to its Client and this document does not exonerate parties to a transaction from exercising all their rights and obligations under the transaction documents. This document cannot be reproduced except in full, without prior written approval of the Company. Any unauthorized alteration, forgery or falsification of the content or appearance of this document is unlawful and offenders may be prosecuted to the fullest extent of the law.

Report Number :TERF2308001923E2

Test Site :SAC G Chamber

Operation Mode :802.11be80

Test Date :2023-08-25

Test Frequency :5610 MHz

Temp./Humi. :25.9°C/57%

Test Mode :Tx

Antenna Pol. :Vertical

EUT Pol :E2 Plane

Engineer :Temo Chen

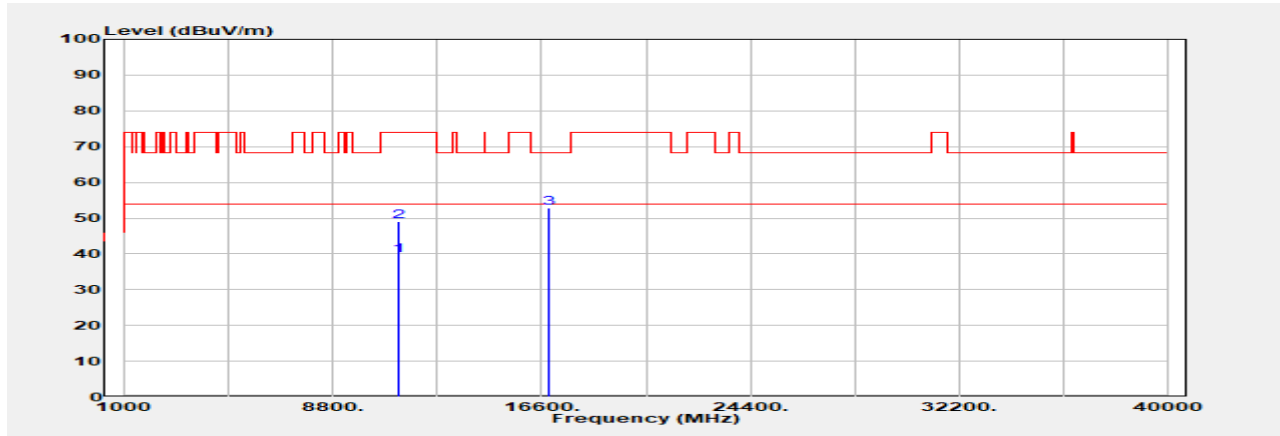

Freq. MHz	Detector Mode PK/QP/AVG	Spectrum Reading Level dBμV	Factor dB	Actual FS dBμV/m	Limit @3m dBμV/m	Margin dB
11220.000	Average	29.58	9.94	39.52	54.00	-14.48
11220.000	Peak	39.18	9.94	49.12	74.00	-24.88
16830.000	Peak	41.66	11.27	52.93	68.20	-15.27

Unless otherwise stated the results shown in this test report refer only to the sample(s) tested and such sample(s) are retained for 90 days only.

除非另有說明，此報告結果僅對測試之樣品負責，同時此樣品僅保留90天。本報告未經本公司書面許可，不可部份複製。

This document is issued by the Company subject to its General Conditions of Service printed overleaf, available on request or accessible at <http://www.sgs.com.tw/Terms-and-Conditions> and for electronic format documents, subject to Terms and Conditions for Electronic Documents at <http://www.sgs.com.tw/Terms-and-Conditions>. Attention is drawn to the limitation of liability, indemnification and jurisdiction issues defined therein. Any holder of this document is advised that information contained hereon reflects the Company's findings at the time of its intervention only and within the limits of Client's instructions, if any. The Company's sole responsibility is to its Client and this document does not exonerate parties to a transaction from exercising all their rights and obligations under the transaction documents. This document cannot be reproduced except in full, without prior written approval of the Company. Any unauthorized alteration, forgery or falsification of the content or appearance of this document is unlawful and offenders may be prosecuted to the fullest extent of the law.

Report Number :TERF2308001923E2
 Operation Mode :802.11be80
 Test Frequency :5610 MHz
 Test Mode :Tx
 EUT Pol :E2 Plane

Test Site :SAC G Chamber
 Test Date :2023-08-25
 Temp./Humi. :25.9°C/57%
 Antenna Pol. :Horizontal
 Engineer :Temo Chen

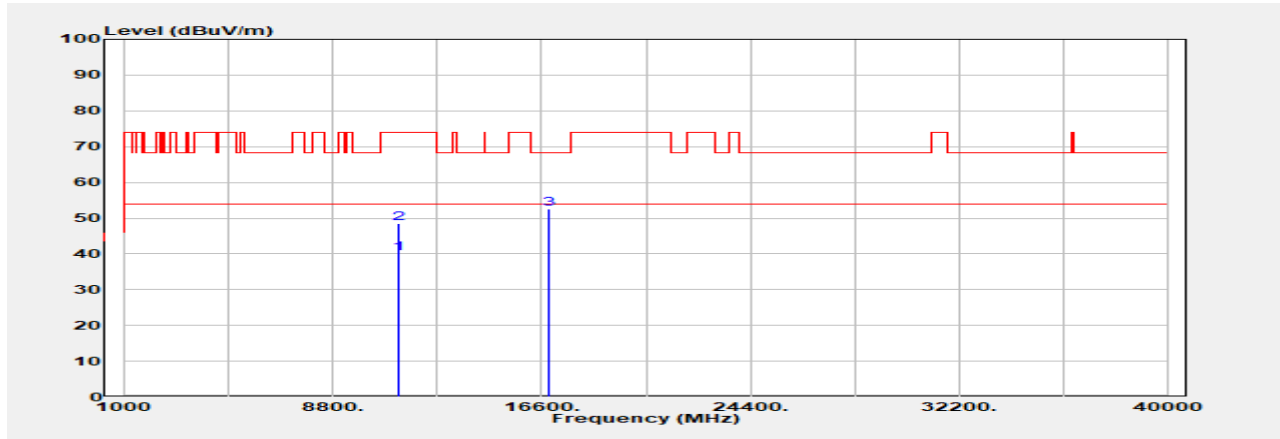

Freq. MHz	Detector Mode PK/QP/AVG	Spectrum Reading Level dB μ V	Factor dB	Actual FS dB μ V/m	Limit @3m dB μ V/m	Margin dB
11220.000	Average	30.22	9.94	40.16	54.00	-13.84
11220.000	Peak	38.51	9.94	48.45	74.00	-25.55
16830.000	Peak	41.22	11.27	52.49	68.20	-15.71

Unless otherwise stated the results shown in this test report refer only to the sample(s) tested and such sample(s) are retained for 90 days only.

除非另有說明，此報告結果僅對測試之樣品負責，同時此樣品僅保留90天。本報告未經本公司書面許可，不可部份複製。

This document is issued by the Company subject to its General Conditions of Service printed overleaf, available on request or accessible at <http://www.sgs.com.tw/Terms-and-Conditions> and for electronic format documents, subject to Terms and Conditions for Electronic Documents at <http://www.sgs.com.tw/Terms-and-Conditions>. Attention is drawn to the limitation of liability, indemnification and jurisdiction issues defined therein. Any holder of this document is advised that information contained hereon reflects the Company's findings at the time of its intervention only and within the limits of Client's instructions, if any. The Company's sole responsibility is to its Client and this document does not exonerate parties to a transaction from exercising all their rights and obligations under the transaction documents. This document cannot be reproduced except in full, without prior written approval of the Company. Any unauthorized alteration, forgery or falsification of the content or appearance of this document is unlawful and offenders may be prosecuted to the fullest extent of the law.

Report Number :TERF2308001923E2

Test Site :SAC G Chamber

Operation Mode :802.11be80

Test Date :2023-10-20

Test Frequency :5775 MHz

Temp./Humi. :21.3°C/68%

Test Mode :Tx

Antenna Pol. :Vertical

EUT Pol :E2 Plane

Engineer :Temo Chen



Freq. MHz	Detector Mode PK/QP/AVG	Spectrum Reading Level dB μ V	Factor dB	Actual FS dB μ V/m	Limit @3m dB μ V/m	Margin dB
11550.000	Average	30.10	10.45	40.55	54.00	-13.45
11550.000	Peak	39.02	10.45	49.47	74.00	-24.53
17325.000	Peak	40.69	11.70	52.39	68.20	-15.81

Unless otherwise stated the results shown in this test report refer only to the sample(s) tested and such sample(s) are retained for 90 days only.

除非另有說明，此報告結果僅對測試之樣品負責，同時此樣品僅保留90天。本報告未經本公司書面許可，不可部份複製。

This document is issued by the Company subject to its General Conditions of Service printed overleaf, available on request or accessible at <http://www.sgs.com.tw/Terms-and-Conditions> and for electronic format documents, subject to Terms and Conditions for Electronic Documents at <http://www.sgs.com.tw/Terms-and-Conditions>. Attention is drawn to the limitation of liability, indemnification and jurisdiction issues defined therein. Any holder of this document is advised that information contained hereon reflects the Company's findings at the time of its intervention only and within the limits of Client's instructions, if any. The Company's sole responsibility is to its Client and this document does not exonerate parties to a transaction from exercising all their rights and obligations under the transaction documents. This document cannot be reproduced except in full, without prior written approval of the Company. Any unauthorized alteration, forgery or falsification of the content or appearance of this document is unlawful and offenders may be prosecuted to the fullest extent of the law.

Report Number :TERF2308001923E2

Test Site :SAC G Chamber

Operation Mode :802.11be80

Test Date :2023-10-20

Test Frequency :5775 MHz

Temp./Humi. :21.3°C/68%

Test Mode :Tx

Antenna Pol. :Horizontal

EUT Pol :E2 Plane

Engineer :Temo Chen

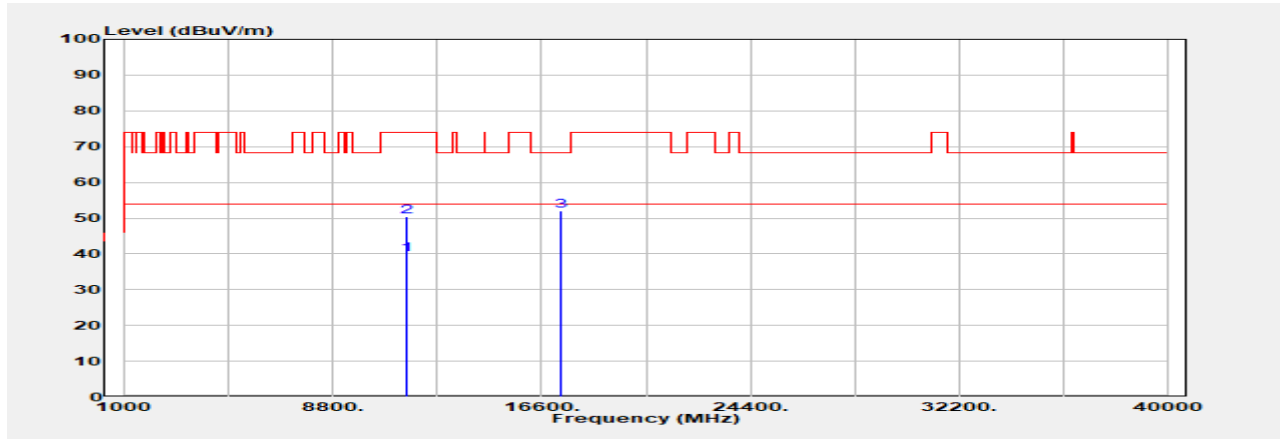

Freq. MHz	Detector Mode PK/QP/AVG	Spectrum Reading Level dB μ V	Factor dB	Actual FS dB μ V/m	Limit @3m dB μ V/m	Margin dB
11550.000	Average	29.29	10.45	39.74	54.00	-14.26
11550.000	Peak	39.91	10.45	50.36	74.00	-23.64
17325.000	Peak	40.42	11.70	52.12	68.20	-16.08

Unless otherwise stated the results shown in this test report refer only to the sample(s) tested and such sample(s) are retained for 90 days only.

除非另有說明，此報告結果僅對測試之樣品負責，同時此樣品僅保留90天。本報告未經本公司書面許可，不可部份複製。

This document is issued by the Company subject to its General Conditions of Service printed overleaf, available on request or accessible at <http://www.sgs.com.tw/Terms-and-Conditions> and for electronic format documents, subject to Terms and Conditions for Electronic Documents at <http://www.sgs.com.tw/Terms-and-Conditions>. Attention is drawn to the limitation of liability, indemnification and jurisdiction issues defined therein. Any holder of this document is advised that information contained hereon reflects the Company's findings at the time of its intervention only and within the limits of Client's instructions, if any. The Company's sole responsibility is to its Client and this document does not exonerate parties to a transaction from exercising all their rights and obligations under the transaction documents. This document cannot be reproduced except in full, without prior written approval of the Company. Any unauthorized alteration, forgery or falsification of the content or appearance of this document is unlawful and offenders may be prosecuted to the fullest extent of the law.

Report Number :TERF2308001923E2
 Operation Mode :802.11be160
 Test Frequency :5250 MHz
 Test Mode :Tx
 EUT Pol :E2 Plane

Test Site :SAC G Chamber
 Test Date :2023-10-20
 Temp./Humi. :21.3°C/68%
 Antenna Pol. :Vertical
 Engineer :Temo Chen

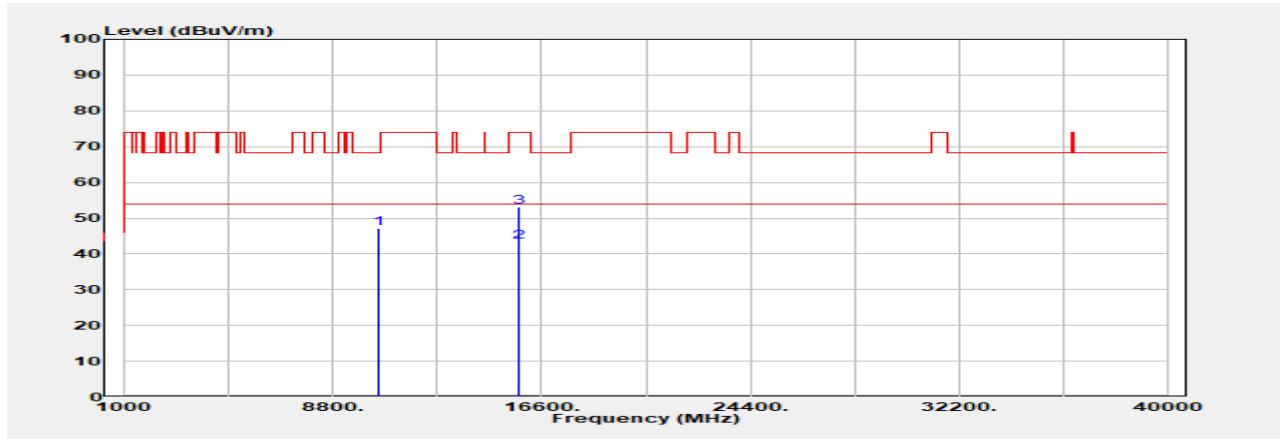

Freq. MHz	Detector Mode PK/QP/AVG	Spectrum Reading Level dB μ V	Factor dB	Actual FS dB μ V/m	Limit @3m dB μ V/m	Margin dB
10500.000	Peak	37.20	9.90	47.10	68.20	-21.10
15750.000	Average	30.74	12.50	43.24	54.00	-10.76
15750.000	Peak	40.61	12.50	53.11	74.00	-20.89

Unless otherwise stated the results shown in this test report refer only to the sample(s) tested and such sample(s) are retained for 90 days only.

除非另有說明，此報告結果僅對測試之樣品負責，同時此樣品僅保留90天。本報告未經本公司書面許可，不可部份複製。

This document is issued by the Company subject to its General Conditions of Service printed overleaf, available on request or accessible at <http://www.sgs.com.tw/Terms-and-Conditions> and for electronic format documents, subject to Terms and Conditions for Electronic Documents at <http://www.sgs.com.tw/Terms-and-Conditions>. Attention is drawn to the limitation of liability, indemnification and jurisdiction issues defined therein. Any holder of this document is advised that information contained hereon reflects the Company's findings at the time of its intervention only and within the limits of Client's instructions, if any. The Company's sole responsibility is to its Client and this document does not exonerate parties to a transaction from exercising all their rights and obligations under the transaction documents. This document cannot be reproduced except in full, without prior written approval of the Company. Any unauthorized alteration, forgery or falsification of the content or appearance of this document is unlawful and offenders may be prosecuted to the fullest extent of the law.

Report Number :TERF2308001923E2
 Operation Mode :802.11be160
 Test Frequency :5250 MHz
 Test Mode :Tx
 EUT Pol :E2 Plane

Test Site :SAC G Chamber
 Test Date :2023-10-20
 Temp./Humi. :21.3°C/68%
 Antenna Pol. :Horizontal
 Engineer :Temo Chen

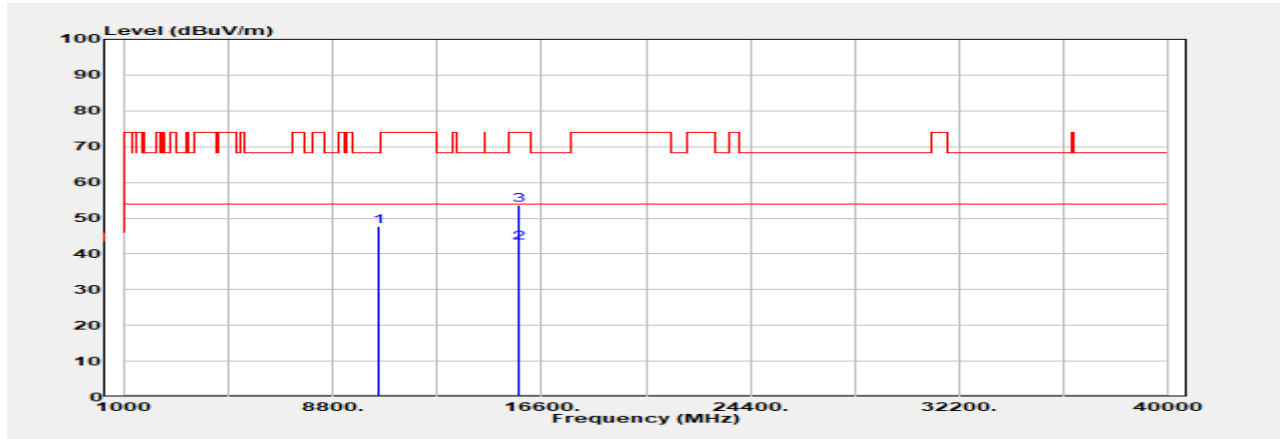

Freq. MHz	Detector Mode PK/QP/AVG	Spectrum Reading Level dB μ V	Factor dB	Actual FS dB μ V/m	Limit @3m dB μ V/m	Margin dB
10500.000	Peak	37.69	9.90	47.59	68.20	-20.61
15750.000	Average	30.64	12.50	43.14	54.00	-10.86
15750.000	Peak	41.12	12.50	53.62	74.00	-20.38

Unless otherwise stated the results shown in this test report refer only to the sample(s) tested and such sample(s) are retained for 90 days only.

除非另有說明，此報告結果僅對測試之樣品負責，同時此樣品僅保留90天。本報告未經本公司書面許可，不可部份複製。

This document is issued by the Company subject to its General Conditions of Service printed overleaf, available on request or accessible at <http://www.sgs.com.tw/Terms-and-Conditions> and for electronic format documents, subject to Terms and Conditions for Electronic Documents at <http://www.sgs.com.tw/Terms-and-Conditions>. Attention is drawn to the limitation of liability, indemnification and jurisdiction issues defined therein. Any holder of this document is advised that information contained hereon reflects the Company's findings at the time of its intervention only and within the limits of Client's instructions, if any. The Company's sole responsibility is to its Client and this document does not exonerate parties to a transaction from exercising all their rights and obligations under the transaction documents. This document cannot be reproduced except in full, without prior written approval of the Company. Any unauthorized alteration, forgery or falsification of the content or appearance of this document is unlawful and offenders may be prosecuted to the fullest extent of the law.

Report Number :TERF2308001923E2
 Operation Mode :802.11be160
 Test Frequency :5570 MHz
 Test Mode :Tx
 EUT Pol :E2 Plane

Test Site :SAC G Chamber
 Test Date :2023-10-20
 Temp./Humi. :21.3°C/68%
 Antenna Pol. :Vertical
 Engineer :Temo Chen

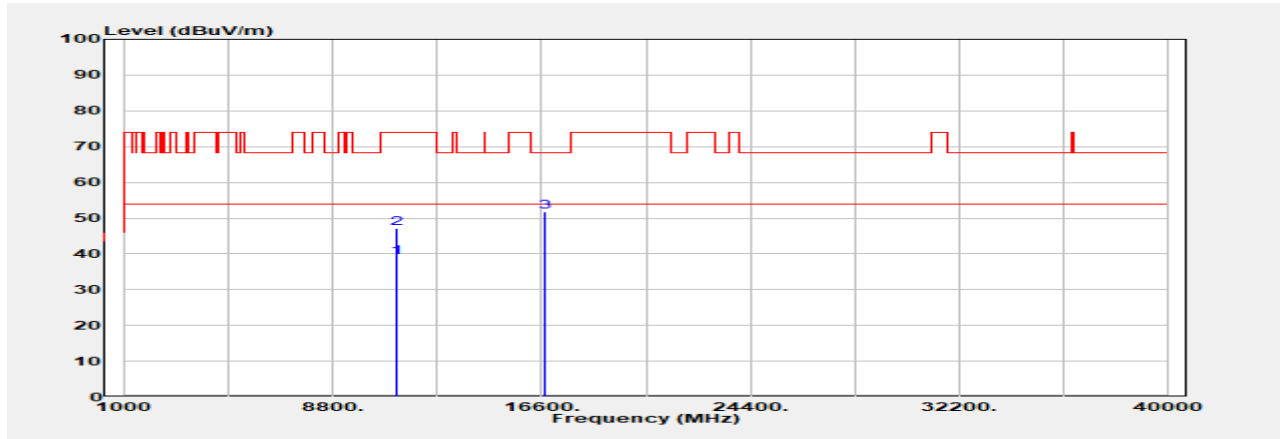

Freq. MHz	Detector Mode PK/QP/AVG	Spectrum Reading Level dB μ V	Factor dB	Actual FS dB μ V/m	Limit @3m dB μ V/m	Margin dB
11140.000	Average	29.23	9.82	39.05	54.00	-14.95
11140.000	Peak	37.42	9.82	47.24	74.00	-26.76
16710.000	Peak	40.08	11.69	51.77	68.20	-16.43

Unless otherwise stated the results shown in this test report refer only to the sample(s) tested and such sample(s) are retained for 90 days only.

除非另有說明，此報告結果僅對測試之樣品負責，同時此樣品僅保留90天。本報告未經本公司書面許可，不可部份複製。

This document is issued by the Company subject to its General Conditions of Service printed overleaf, available on request or accessible at <http://www.sgs.com.tw/Terms-and-Conditions> and for electronic format documents, subject to Terms and Conditions for Electronic Documents at <http://www.sgs.com.tw/Terms-and-Conditions>. Attention is drawn to the limitation of liability, indemnification and jurisdiction issues defined therein. Any holder of this document is advised that information contained hereon reflects the Company's findings at the time of its intervention only and within the limits of Client's instructions, if any. The Company's sole responsibility is to its Client and this document does not exonerate parties to a transaction from exercising all their rights and obligations under the transaction documents. This document cannot be reproduced except in full, without prior written approval of the Company. Any unauthorized alteration, forgery or falsification of the content or appearance of this document is unlawful and offenders may be prosecuted to the fullest extent of the law.

Report Number :TERF2308001923E2
 Operation Mode :802.11be160
 Test Frequency :5570 MHz
 Test Mode :Tx
 EUT Pol :E2 Plane

Test Site :SAC G Chamber
 Test Date :2023-10-20
 Temp./Humi. :21.3°C/68%
 Antenna Pol. :Horizontal
 Engineer :Temo Chen

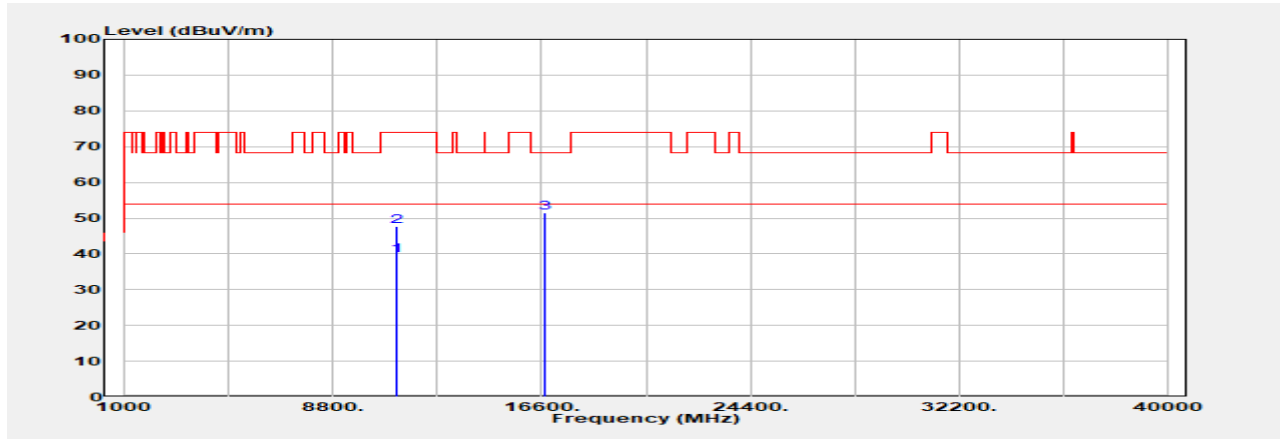

Freq. MHz	Detector Mode PK/QP/AVG	Spectrum Reading Level dB μ V	Factor dB	Actual FS dB μ V/m	Limit @3m dB μ V/m	Margin dB
11140.000	Average	29.88	9.82	39.70	54.00	-14.30
11140.000	Peak	37.80	9.82	47.62	74.00	-26.38
16710.000	Peak	39.84	11.69	51.53	68.20	-16.67

Unless otherwise stated the results shown in this test report refer only to the sample(s) tested and such sample(s) are retained for 90 days only.

除非另有說明，此報告結果僅對測試之樣品負責，同時此樣品僅保留90天。本報告未經本公司書面許可，不可部份複製。

This document is issued by the Company subject to its General Conditions of Service printed overleaf, available on request or accessible at <http://www.sgs.com.tw/Terms-and-Conditions> and for electronic format documents, subject to Terms and Conditions for Electronic Documents at <http://www.sgs.com.tw/Terms-and-Conditions>. Attention is drawn to the limitation of liability, indemnification and jurisdiction issues defined therein. Any holder of this document is advised that information contained hereon reflects the Company's findings at the time of its intervention only and within the limits of Client's instructions, if any. The Company's sole responsibility is to its Client and this document does not exonerate parties to a transaction from exercising all their rights and obligations under the transaction documents. This document cannot be reproduced except in full, without prior written approval of the Company. Any unauthorized alteration, forgery or falsification of the content or appearance of this document is unlawful and offenders may be prosecuted to the fullest extent of the law.

Mode: Beamforming

Report Number	:TERF2308001923E2	Test Site	:SAC G Chamber
Operation Mode	:802.11n20	Test Date	:2023-11-02
Test Frequency	:5220 MHz	Temp./Humi.	:22.6°C/55%
Test Mode	:Tx	Antenna Pol.	:Vertical
EUT Pol	:E2 Plane	Engineer	:Temo Chen

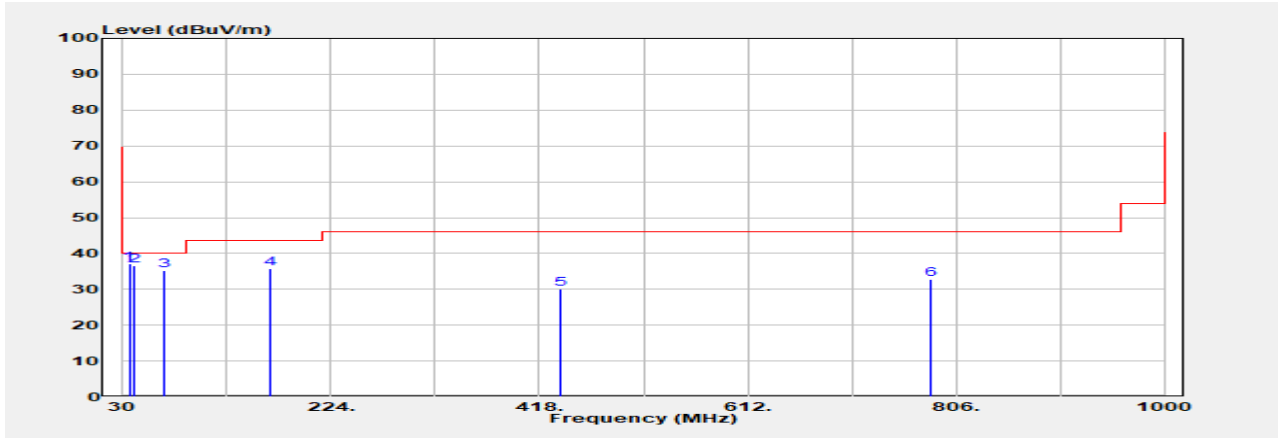

Freq. MHz	Detector Mode PK/QP/AVG	Spectrum Reading Level dBuV	Factor dB	Actual FS dBuV/m	Limit @3m dBuV/m	Margin dB
35.820	QP	51.37	-14.19	37.18	40.00	-2.82
39.700	QP	50.04	-13.47	36.57	40.00	-3.43
67.830	QP	49.67	-14.39	35.28	40.00	-4.72
167.740	Peak	48.95	-13.19	35.76	43.50	-7.74
437.400	Peak	38.52	-8.32	30.20	46.00	-15.80
781.750	Peak	34.58	-1.79	32.79	46.00	-13.21

Unless otherwise stated the results shown in this test report refer only to the sample(s) tested and such sample(s) are retained for 90 days only.

除非另有說明，此報告結果僅對測試之樣品負責，同時此樣品僅保留90天。本報告未經本公司書面許可，不可部份複製。

This document is issued by the Company subject to its General Conditions of Service printed overleaf, available on request or accessible at <http://www.sgs.com.tw/Terms-and-Conditions> and for electronic format documents, subject to Terms and Conditions for Electronic Documents at <http://www.sgs.com.tw/Terms-and-Conditions>. Attention is drawn to the limitation of liability, indemnification and jurisdiction issues defined therein. Any holder of this document is advised that information contained hereon reflects the Company's findings at the time of its intervention only and within the limits of Client's instructions, if any. The Company's sole responsibility is to its Client and this document does not exonerate parties to a transaction from exercising all their rights and obligations under the transaction documents. This document cannot be reproduced except in full, without prior written approval of the Company. Any unauthorized alteration, forgery or falsification of the content or appearance of this document is unlawful and offenders may be prosecuted to the fullest extent of the law.

Report Number	:TERF2308001923E2	Test Site	:SAC G Chamber
Operation Mode	:802.11n20	Test Date	:2023-11-02
Test Frequency	:5220 MHz	Temp./Humi.	:22.6°C/55%
Test Mode	:Tx	Antenna Pol.	:Horizontal
EUT Pol	:E2 Plane	Engineer	:Temo Chen

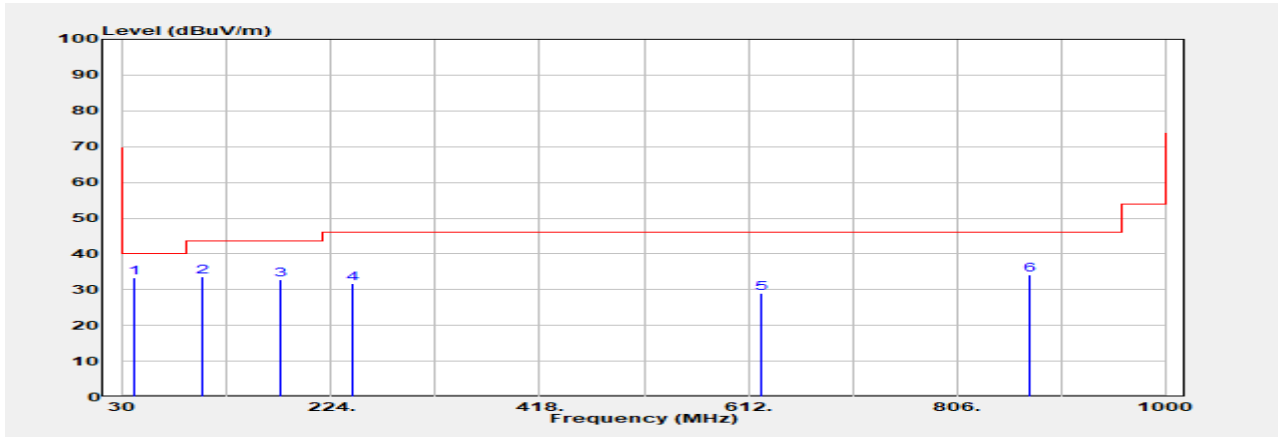

Freq. MHz	Detector Mode PK/QP/AVG	Spectrum Reading Level dBµV	Factor dB	Actual FS dBµV/m	Limit @3m dBµV/m	Margin dB
39.700	Peak	46.85	-13.47	33.38	40.00	-6.62
104.690	Peak	50.13	-16.66	33.47	43.50	-10.03
177.440	Peak	46.92	-14.14	32.78	43.50	-10.72
244.370	Peak	45.69	-13.95	31.74	46.00	-14.26
624.610	Peak	34.46	-5.41	29.06	46.00	-16.94
874.870	Peak	34.34	-0.11	34.23	46.00	-11.77

Unless otherwise stated the results shown in this test report refer only to the sample(s) tested and such sample(s) are retained for 90 days only.

除非另有說明，此報告結果僅對測試之樣品負責，同時此樣品僅保留90天。本報告未經本公司書面許可，不可部份複製。

This document is issued by the Company subject to its General Conditions of Service printed overleaf, available on request or accessible at <http://www.sgs.com.tw/Terms-and-Conditions> and for electronic format documents, subject to Terms and Conditions for Electronic Documents at <http://www.sgs.com.tw/Terms-and-Conditions>. Attention is drawn to the limitation of liability, indemnification and jurisdiction issues defined therein. Any holder of this document is advised that information contained hereon reflects the Company's findings at the time of its intervention only and within the limits of Client's instructions, if any. The Company's sole responsibility is to its Client and this document does not exonerate parties to a transaction from exercising all their rights and obligations under the transaction documents. This document cannot be reproduced except in full, without prior written approval of the Company. Any unauthorized alteration, forgery or falsification of the content or appearance of this document is unlawful and offenders may be prosecuted to the fullest extent of the law.

Report Number :TERF2308001923E2
 Operation Mode :802.11n20
 Test Frequency :5300 MHz
 Test Mode :Tx
 EUT Pol :E2 Plane

Test Site :SAC G Chamber
 Test Date :2023-11-02
 Temp./Humi. :22.6°C/55%
 Antenna Pol. :Vertical
 Engineer :Temo Chen

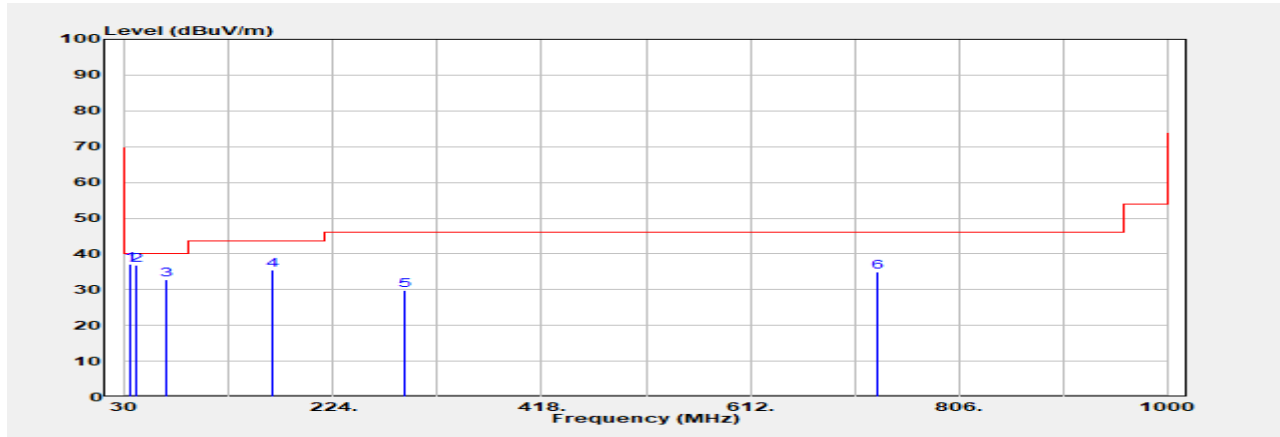

Freq. MHz	Detector Mode PK/QP/AVG	Spectrum Reading Level dBuV	Factor dB	Actual FS dBuV/m	Limit @3m dBuV/m	Margin dB
34.850	QP	51.10	-14.03	37.07	40.00	-2.93
39.700	QP	50.19	-13.47	36.72	40.00	-3.28
68.800	QP	47.59	-14.80	32.79	40.00	-7.21
166.770	Peak	48.62	-13.16	35.46	43.50	-8.04
290.930	Peak	41.99	-12.15	29.83	46.00	-16.17
730.340	Peak	37.97	-3.09	34.88	46.00	-11.12

Unless otherwise stated the results shown in this test report refer only to the sample(s) tested and such sample(s) are retained for 90 days only.

除非另有說明，此報告結果僅對測試之樣品負責，同時此樣品僅保留90天。本報告未經本公司書面許可，不可部份複製。

This document is issued by the Company subject to its General Conditions of Service printed overleaf, available on request or accessible at <http://www.sgs.com.tw/Terms-and-Conditions> and for electronic format documents, subject to Terms and Conditions for Electronic Documents at <http://www.sgs.com.tw/Terms-and-Conditions>. Attention is drawn to the limitation of liability, indemnification and jurisdiction issues defined therein. Any holder of this document is advised that information contained hereon reflects the Company's findings at the time of its intervention only and within the limits of Client's instructions, if any. The Company's sole responsibility is to its Client and this document does not exonerate parties to a transaction from exercising all their rights and obligations under the transaction documents. This document cannot be reproduced except in full, without prior written approval of the Company. Any unauthorized alteration, forgery or falsification of the content or appearance of this document is unlawful and offenders may be prosecuted to the fullest extent of the law.

Report Number :TERF2308001923E2
 Operation Mode :802.11n20
 Test Frequency :5300 MHz
 Test Mode :Tx
 EUT Pol :E2 Plane

Test Site :SAC G Chamber
 Test Date :2023-11-02
 Temp./Humi. :22.6°C/55%
 Antenna Pol. :Horizontal
 Engineer :Temo Chen

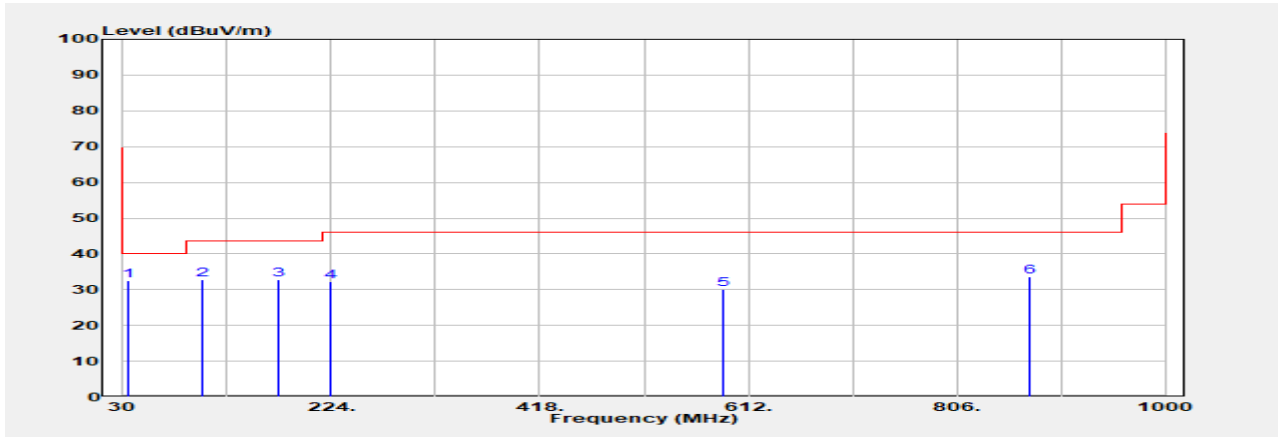

Freq. MHz	Detector Mode PK/QP/AVG	Spectrum Reading Level dBuV	Factor dB	Actual FS dBuV/m	Limit @3m dBuV/m	Margin dB
34.850	Peak	46.56	-14.03	32.53	40.00	-7.47
104.690	Peak	49.48	-16.66	32.82	43.50	-10.68
175.500	Peak	46.70	-13.85	32.84	43.50	-10.66
223.030	Peak	48.25	-15.99	32.26	46.00	-13.74
588.720	Peak	35.13	-5.07	30.06	46.00	-15.94
874.870	Peak	33.63	-0.11	33.52	46.00	-12.48

Unless otherwise stated the results shown in this test report refer only to the sample(s) tested and such sample(s) are retained for 90 days only.

除非另有說明，此報告結果僅對測試之樣品負責，同時此樣品僅保留90天。本報告未經本公司書面許可，不可部份複製。

This document is issued by the Company subject to its General Conditions of Service printed overleaf, available on request or accessible at <http://www.sgs.com.tw/Terms-and-Conditions> and for electronic format documents, subject to Terms and Conditions for Electronic Documents at <http://www.sgs.com.tw/Terms-and-Conditions>. Attention is drawn to the limitation of liability, indemnification and jurisdiction issues defined therein. Any holder of this document is advised that information contained hereon reflects the Company's findings at the time of its intervention only and within the limits of Client's instructions, if any. The Company's sole responsibility is to its Client and this document does not exonerate parties to a transaction from exercising all their rights and obligations under the transaction documents. This document cannot be reproduced except in full, without prior written approval of the Company. Any unauthorized alteration, forgery or falsification of the content or appearance of this document is unlawful and offenders may be prosecuted to the fullest extent of the law.

Report Number :TERF2308001923E2
 Operation Mode :802.11n20
 Test Frequency :5580 MHz
 Test Mode :Tx
 EUT Pol :E2 Plane

Test Site :SAC G Chamber
 Test Date :2023-11-02
 Temp./Humi. :22.6°C/55%
 Antenna Pol. :Vertical
 Engineer :Temo Chen

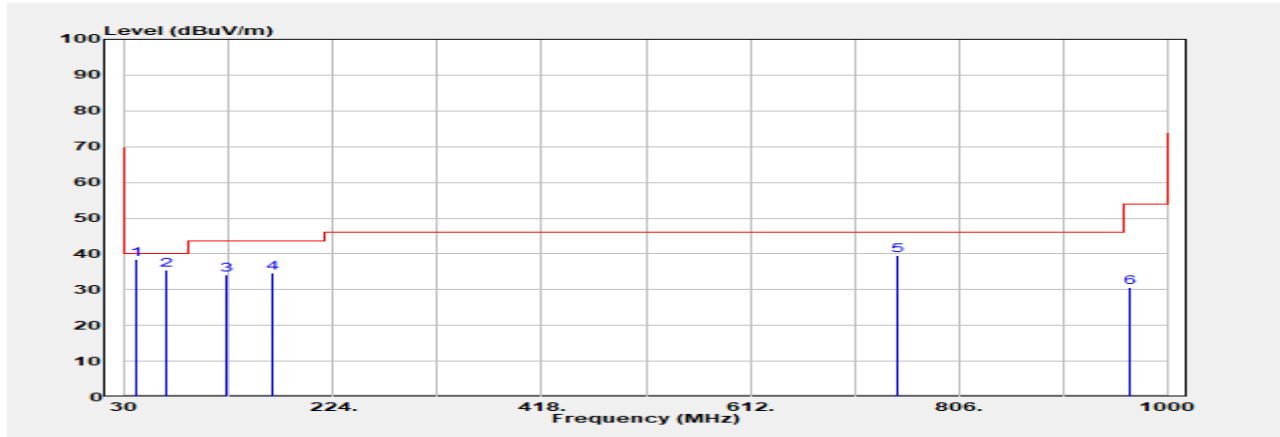

Freq. MHz	Detector Mode PK/QP/AVG	Spectrum Reading Level dBuV	Factor dB	Actual FS dBuV/m	Limit @3m dBuV/m	Margin dB
39.700	QP	51.95	-13.47	38.48	40.00	-1.52
67.830	QP	49.80	-14.39	35.42	40.00	-4.58
125.060	Peak	49.03	-14.99	34.03	43.50	-9.47
167.740	Peak	47.82	-13.19	34.63	43.50	-8.87
749.740	Peak	41.50	-2.06	39.44	46.00	-6.56
966.050	Peak	29.67	0.89	30.56	54.00	-23.44

Unless otherwise stated the results shown in this test report refer only to the sample(s) tested and such sample(s) are retained for 90 days only.

除非另有說明，此報告結果僅對測試之樣品負責，同時此樣品僅保留90天。本報告未經本公司書面許可，不可部份複製。

This document is issued by the Company subject to its General Conditions of Service printed overleaf, available on request or accessible at <http://www.sgs.com.tw/Terms-and-Conditions> and for electronic format documents, subject to Terms and Conditions for Electronic Documents at <http://www.sgs.com.tw/Terms-and-Conditions>. Attention is drawn to the limitation of liability, indemnification and jurisdiction issues defined therein. Any holder of this document is advised that information contained hereon reflects the Company's findings at the time of its intervention only and within the limits of Client's instructions, if any. The Company's sole responsibility is to its Client and this document does not exonerate parties to a transaction from exercising all their rights and obligations under the transaction documents. This document cannot be reproduced except in full, without prior written approval of the Company. Any unauthorized alteration, forgery or falsification of the content or appearance of this document is unlawful and offenders may be prosecuted to the fullest extent of the law.

Report Number	:TERF2308001923E2	Test Site	:SAC G Chamber
Operation Mode	:802.11n20	Test Date	:2023-11-02
Test Frequency	:5580 MHz	Temp./Humi.	:22.6°C/55%
Test Mode	:Tx	Antenna Pol.	:Horizontal
EUT Pol	:E2 Plane	Engineer	:Temo Chen

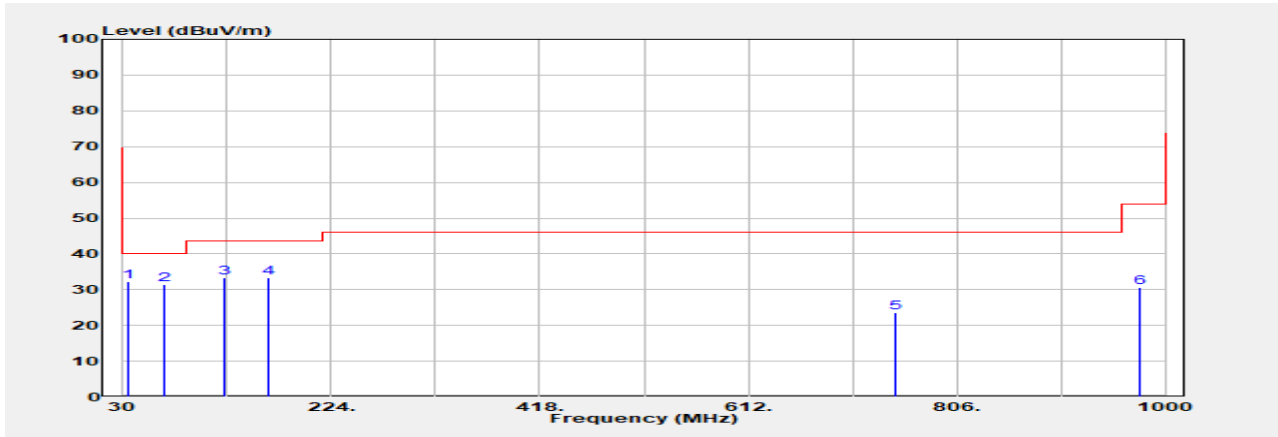

Freq. MHz	Detector Mode PK/QP/AVG	Spectrum Reading Level dBµV	Factor dB	Actual FS dBµV/m	Limit @3m dBµV/m	Margin dB
34.850	Peak	46.33	-14.03	32.30	40.00	-7.70
67.830	Peak	45.81	-14.39	31.43	40.00	-8.57
125.060	Peak	48.29	-14.99	33.30	43.50	-10.20
165.800	Peak	46.38	-13.05	33.33	43.50	-10.17
749.740	QP	25.67	-2.06	23.61	46.00	-22.39
976.720	Peak	29.66	0.88	30.54	54.00	-23.46

Unless otherwise stated the results shown in this test report refer only to the sample(s) tested and such sample(s) are retained for 90 days only.

除非另有說明，此報告結果僅對測試之樣品負責，同時此樣品僅保留90天。本報告未經本公司書面許可，不可部份複製。

This document is issued by the Company subject to its General Conditions of Service printed overleaf, available on request or accessible at <http://www.sgs.com.tw/Terms-and-Conditions> and for electronic format documents, subject to Terms and Conditions for Electronic Documents at <http://www.sgs.com.tw/Terms-and-Conditions>. Attention is drawn to the limitation of liability, indemnification and jurisdiction issues defined therein. Any holder of this document is advised that information contained hereon reflects the Company's findings at the time of its intervention only and within the limits of Client's instructions, if any. The Company's sole responsibility is to its Client and this document does not exonerate parties to a transaction from exercising all their rights and obligations under the transaction documents. This document cannot be reproduced except in full, without prior written approval of the Company. Any unauthorized alteration, forgery or falsification of the content or appearance of this document is unlawful and offenders may be prosecuted to the fullest extent of the law.

Report Number :TERF2308001923E2
 Operation Mode :802.11n20
 Test Frequency :5785 MHz
 Test Mode :Tx
 EUT Pol :E2 Plane

Test Site :SAC G Chamber
 Test Date :2023-11-02
 Temp./Humi. :22.6°C/55%
 Antenna Pol. :Vertical
 Engineer :Temo Chen

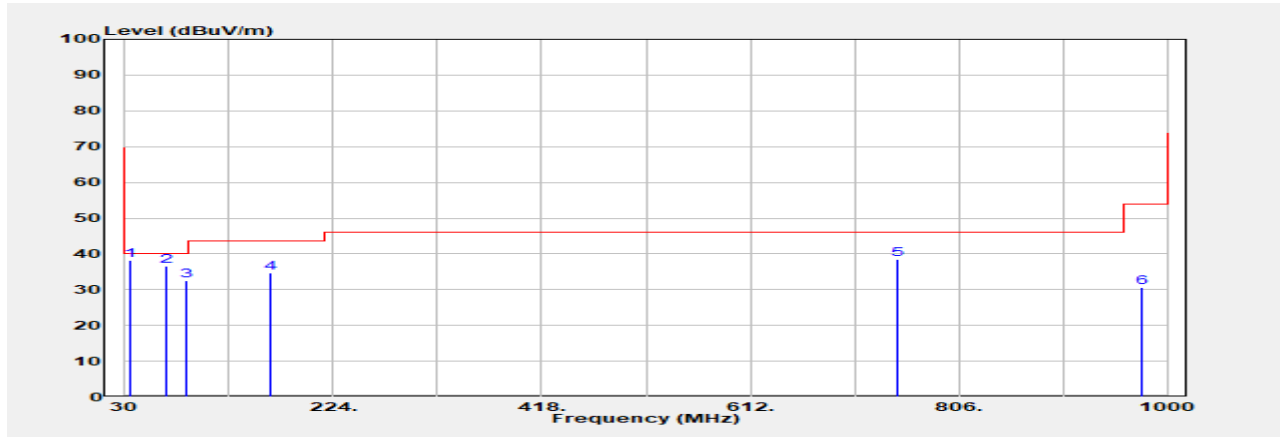

Freq. MHz	Detector Mode PK/QP/AVG	Spectrum Reading Level dBuV	Factor dB	Actual FS dBuV/m	Limit @3m dBuV/m	Margin dB
34.850	QP	52.23	-14.03	38.20	40.00	-1.80
67.830	QP	50.92	-14.39	36.53	40.00	-3.47
87.230	QP	51.00	-18.54	32.47	40.00	-7.53
165.800	Peak	47.75	-13.05	34.70	43.50	-8.80
749.740	Peak	40.66	-2.06	38.60	46.00	-7.40
976.720	Peak	29.67	0.88	30.55	54.00	-23.45

Unless otherwise stated the results shown in this test report refer only to the sample(s) tested and such sample(s) are retained for 90 days only.

除非另有說明，此報告結果僅對測試之樣品負責，同時此樣品僅保留90天。本報告未經本公司書面許可，不可部份複製。

This document is issued by the Company subject to its General Conditions of Service printed overleaf, available on request or accessible at <http://www.sgs.com.tw/Terms-and-Conditions> and for electronic format documents, subject to Terms and Conditions for Electronic Documents at <http://www.sgs.com.tw/Terms-and-Conditions>. Attention is drawn to the limitation of liability, indemnification and jurisdiction issues defined therein. Any holder of this document is advised that information contained hereon reflects the Company's findings at the time of its intervention only and within the limits of Client's instructions, if any. The Company's sole responsibility is to its Client and this document does not exonerate parties to a transaction from exercising all their rights and obligations under the transaction documents. This document cannot be reproduced except in full, without prior written approval of the Company. Any unauthorized alteration, forgery or falsification of the content or appearance of this document is unlawful and offenders may be prosecuted to the fullest extent of the law.

Report Number	:TERF2308001923E2	Test Site	:SAC G Chamber
Operation Mode	:802.11n20	Test Date	:2023-11-02
Test Frequency	:5785 MHz	Temp./Humi.	:22.6°C/55%
Test Mode	:Tx	Antenna Pol.	:Horizontal
EUT Pol	:E2 Plane	Engineer	:Temo Chen

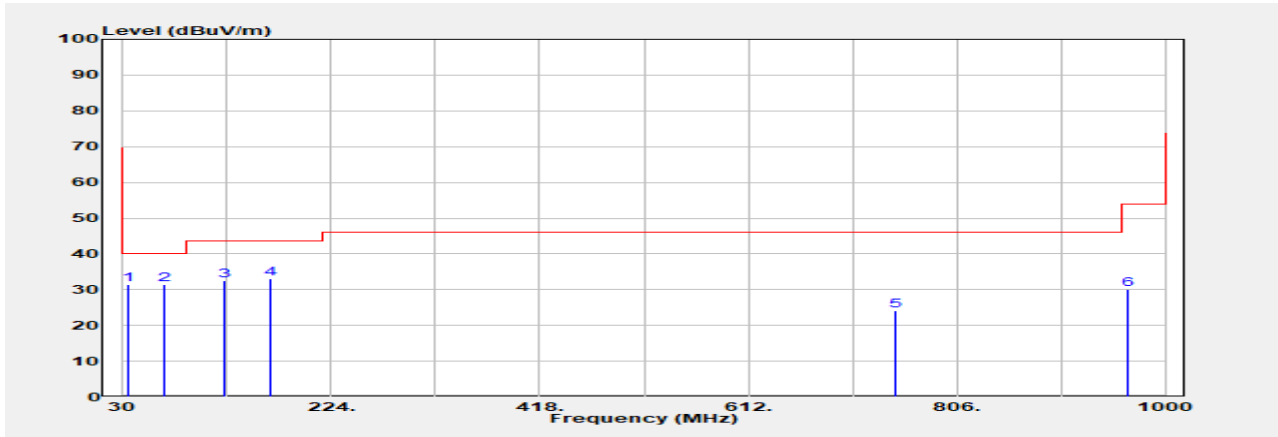

Freq. MHz	Detector Mode PK/QP/AVG	Spectrum Reading Level dBμV	Factor dB	Actual FS dBμV/m	Limit @3m dBμV/m	Margin dB
34.850	Peak	45.49	-14.03	31.46	40.00	-8.54
67.830	Peak	45.74	-14.39	31.35	40.00	-8.65
125.060	Peak	47.41	-14.99	32.41	43.50	-11.09
167.740	Peak	46.33	-13.19	33.13	43.50	-10.37
749.740	QP	26.10	-2.06	24.04	46.00	-21.96
966.050	Peak	29.20	0.89	30.09	54.00	-23.91

Unless otherwise stated the results shown in this test report refer only to the sample(s) tested and such sample(s) are retained for 90 days only.

除非另有說明，此報告結果僅對測試之樣品負責，同時此樣品僅保留90天。本報告未經本公司書面許可，不可部份複製。

This document is issued by the Company subject to its General Conditions of Service printed overleaf, available on request or accessible at <http://www.sgs.com.tw/Terms-and-Conditions> and for electronic format documents, subject to Terms and Conditions for Electronic Documents at <http://www.sgs.com.tw/Terms-and-Conditions>. Attention is drawn to the limitation of liability, indemnification and jurisdiction issues defined therein. Any holder of this document is advised that information contained hereon reflects the Company's findings at the time of its intervention only and within the limits of Client's instructions, if any. The Company's sole responsibility is to its Client and this document does not exonerate parties to a transaction from exercising all their rights and obligations under the transaction documents. This document cannot be reproduced except in full, without prior written approval of the Company. Any unauthorized alteration, forgery or falsification of the content or appearance of this document is unlawful and offenders may be prosecuted to the fullest extent of the law.

Report Number	:TERF2308001923E2	Test Site	:SAC G Chamber
Operation Mode	:802.11be160	Test Date	:2023-11-02
Test Frequency	:5250 MHz	Temp./Humi.	:22.6°C/55%
Test Mode	:Tx	Antenna Pol.	:Vertical
EUT Pol	:E2 Plane	Engineer	:Temo Chen

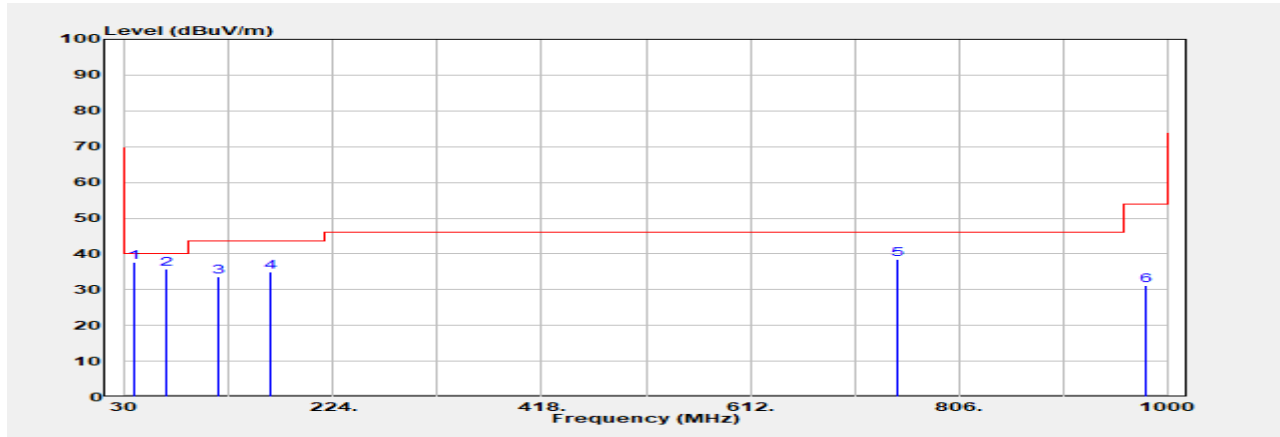

Freq. MHz	Detector Mode PK/QP/AVG	Spectrum Reading Level dBµV	Factor dB	Actual FS dBµV/m	Limit @3m dBµV/m	Margin dB
38.730	QP	51.16	-13.59	37.58	40.00	-2.42
67.830	QP	50.11	-14.39	35.72	40.00	-4.28
117.300	Peak	49.11	-15.52	33.59	43.50	-9.91
165.800	Peak	47.92	-13.05	34.87	43.50	-8.63
749.740	Peak	40.59	-2.06	38.53	46.00	-7.47
979.630	Peak	30.29	0.81	31.10	54.00	-22.90

Unless otherwise stated the results shown in this test report refer only to the sample(s) tested and such sample(s) are retained for 90 days only.

除非另有說明，此報告結果僅對測試之樣品負責，同時此樣品僅保留90天。本報告未經本公司書面許可，不可部份複製。

This document is issued by the Company subject to its General Conditions of Service printed overleaf, available on request or accessible at <http://www.sgs.com.tw/Terms-and-Conditions> and for electronic format documents, subject to Terms and Conditions for Electronic Documents at <http://www.sgs.com.tw/Terms-and-Conditions>. Attention is drawn to the limitation of liability, indemnification and jurisdiction issues defined therein. Any holder of this document is advised that information contained hereon reflects the Company's findings at the time of its intervention only and within the limits of Client's instructions, if any. The Company's sole responsibility is to its Client and this document does not exonerate parties to a transaction from exercising all their rights and obligations under the transaction documents. This document cannot be reproduced except in full, without prior written approval of the Company. Any unauthorized alteration, forgery or falsification of the content or appearance of this document is unlawful and offenders may be prosecuted to the fullest extent of the law.

Report Number	:TERF2308001923E2	Test Site	:SAC G Chamber
Operation Mode	:802.11be160	Test Date	:2023-11-02
Test Frequency	:5250 MHz	Temp./Humi.	:22.6°C/55%
Test Mode	:Tx	Antenna Pol.	:Horizontal
EUT Pol	:E2 Plane	Engineer	:Temo Chen

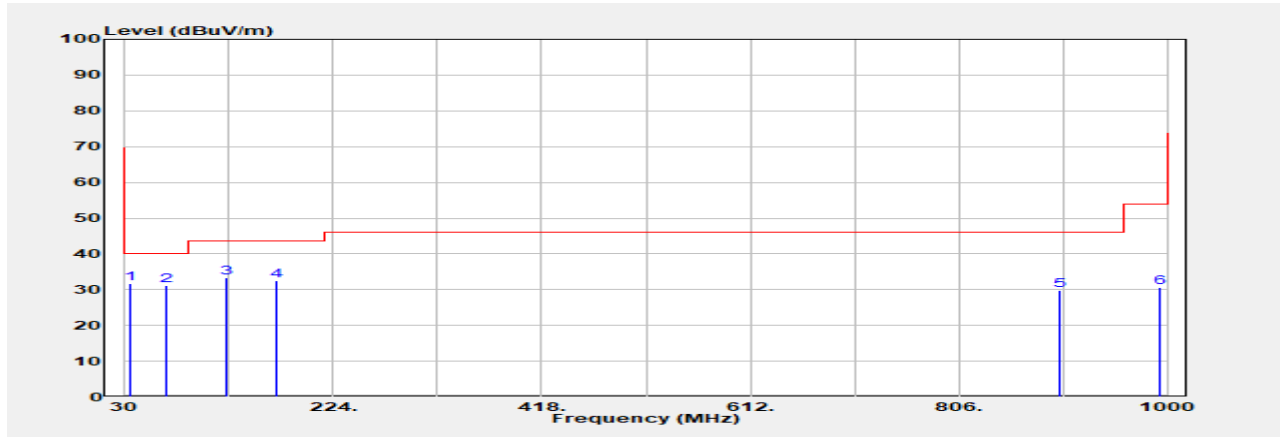

Freq. MHz	Detector Mode PK/QP/AVG	Spectrum Reading Level dBµV	Factor dB	Actual FS dBµV/m	Limit @3m dBµV/m	Margin dB
34.850	Peak	45.64	-14.03	31.61	40.00	-8.39
67.830	Peak	45.42	-14.39	31.03	40.00	-8.97
125.060	Peak	48.39	-14.99	33.40	43.50	-10.10
170.650	Peak	45.95	-13.42	32.54	43.50	-10.96
900.090	Peak	30.49	-0.63	29.86	46.00	-16.14
994.180	Peak	30.03	0.64	30.66	54.00	-23.34

Unless otherwise stated the results shown in this test report refer only to the sample(s) tested and such sample(s) are retained for 90 days only.

除非另有說明，此報告結果僅對測試之樣品負責，同時此樣品僅保留90天。本報告未經本公司書面許可，不可部份複製。

This document is issued by the Company subject to its General Conditions of Service printed overleaf, available on request or accessible at <http://www.sgs.com.tw/Terms-and-Conditions> and for electronic format documents, subject to Terms and Conditions for Electronic Documents at <http://www.sgs.com.tw/Terms-and-Conditions>. Attention is drawn to the limitation of liability, indemnification and jurisdiction issues defined therein. Any holder of this document is advised that information contained hereon reflects the Company's findings at the time of its intervention only and within the limits of Client's instructions, if any. The Company's sole responsibility is to its Client and this document does not exonerate parties to a transaction from exercising all their rights and obligations under the transaction documents. This document cannot be reproduced except in full, without prior written approval of the Company. Any unauthorized alteration, forgery or falsification of the content or appearance of this document is unlawful and offenders may be prosecuted to the fullest extent of the law.

Report Number	:TERF2308001923E2	Test Site	:SAC G Chamber
Operation Mode	:802.11be160	Test Date	:2023-11-02
Test Frequency	:5570 MHz	Temp./Humi.	:22.6°C/55%
Test Mode	:Tx	Antenna Pol.	:Vertical
EUT Pol	:E2 Plane	Engineer	:Temo Chen

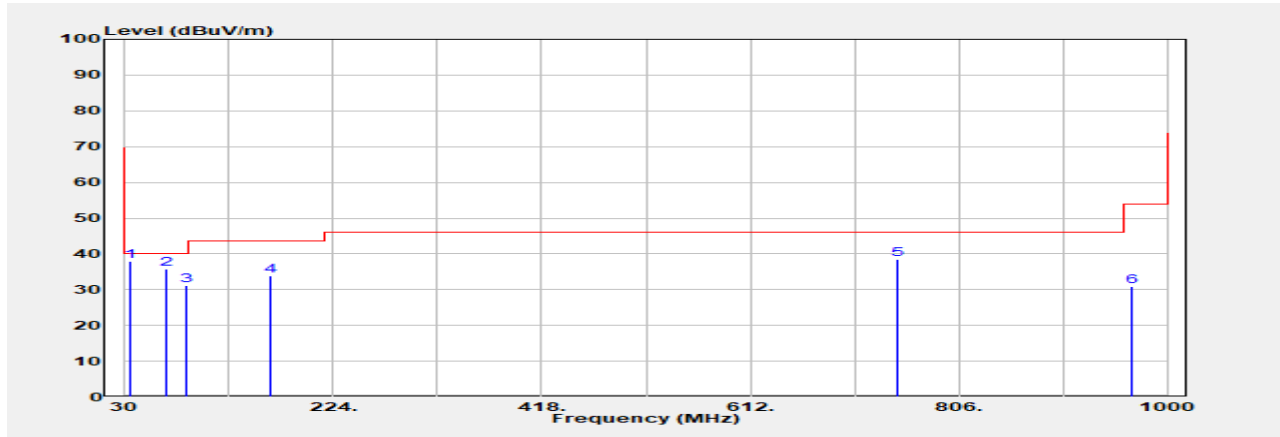

Freq. MHz	Detector Mode PK/QP/AVG	Spectrum Reading Level dBuV	Factor dB	Actual FS dBuV/m	Limit @3m dBuV/m	Margin dB
34.850	QP	51.93	-14.03	37.89	40.00	-2.11
67.830	QP	50.12	-14.39	35.73	40.00	-4.27
87.230	QP	49.74	-18.54	31.20	40.00	-8.80
165.800	Peak	46.93	-13.05	33.88	43.50	-9.62
749.740	Peak	40.57	-2.06	38.51	46.00	-7.49
967.990	Peak	30.00	0.91	30.91	54.00	-23.09

Unless otherwise stated the results shown in this test report refer only to the sample(s) tested and such sample(s) are retained for 90 days only.

除非另有說明，此報告結果僅對測試之樣品負責，同時此樣品僅保留90天。本報告未經本公司書面許可，不可部份複製。

This document is issued by the Company subject to its General Conditions of Service printed overleaf, available on request or accessible at <http://www.sgs.com.tw/Terms-and-Conditions> and for electronic format documents, subject to Terms and Conditions for Electronic Documents at <http://www.sgs.com.tw/Terms-and-Conditions>. Attention is drawn to the limitation of liability, indemnification and jurisdiction issues defined therein. Any holder of this document is advised that information contained hereon reflects the Company's findings at the time of its intervention only and within the limits of Client's instructions, if any. The Company's sole responsibility is to its Client and this document does not exonerate parties to a transaction from exercising all their rights and obligations under the transaction documents. This document cannot be reproduced except in full, without prior written approval of the Company. Any unauthorized alteration, forgery or falsification of the content or appearance of this document is unlawful and offenders may be prosecuted to the fullest extent of the law.

Report Number	:TERF2308001923E2	Test Site	:SAC G Chamber
Operation Mode	:802.11be160	Test Date	:2023-11-02
Test Frequency	:5570 MHz	Temp./Humi.	:22.6°C/55%
Test Mode	:Tx	Antenna Pol.	:Horizontal
EUT Pol	:E2 Plane	Engineer	:Temo Chen

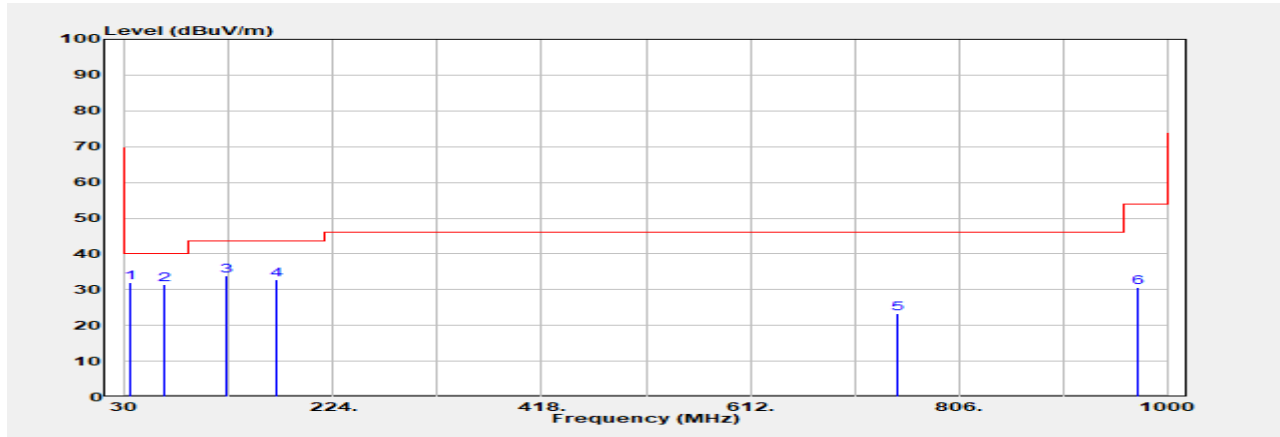

Freq. MHz	Detector Mode PK/QP/AVG	Spectrum Reading Level dBμV	Factor dB	Actual FS dBμV/m	Limit @3m dBμV/m	Margin dB
34.850	Peak	45.98	-14.03	31.94	40.00	-8.06
66.860	Peak	45.75	-14.32	31.43	40.00	-8.57
125.060	Peak	48.93	-14.99	33.94	43.50	-9.56
170.650	Peak	46.15	-13.42	32.73	43.50	-10.77
749.740	QP	25.40	-2.06	23.34	46.00	-22.66
972.840	Peak	29.59	0.92	30.51	54.00	-23.49

Unless otherwise stated the results shown in this test report refer only to the sample(s) tested and such sample(s) are retained for 90 days only.

除非另有說明，此報告結果僅對測試之樣品負責，同時此樣品僅保留90天。本報告未經本公司書面許可，不可部份複製。

This document is issued by the Company subject to its General Conditions of Service printed overleaf, available on request or accessible at <http://www.sgs.com.tw/Terms-and-Conditions> and for electronic format documents, subject to Terms and Conditions for Electronic Documents at <http://www.sgs.com.tw/Terms-and-Conditions>. Attention is drawn to the limitation of liability, indemnification and jurisdiction issues defined therein. Any holder of this document is advised that information contained hereon reflects the Company's findings at the time of its intervention only and within the limits of Client's instructions, if any. The Company's sole responsibility is to its Client and this document does not exonerate parties to a transaction from exercising all their rights and obligations under the transaction documents. This document cannot be reproduced except in full, without prior written approval of the Company. Any unauthorized alteration, forgery or falsification of the content or appearance of this document is unlawful and offenders may be prosecuted to the fullest extent of the law.

Report Number	:TERF2308001923E2	Test Site	:SAC G Chamber
Operation Mode	:802.11n20	Test Date	:2023-09-25
Test Frequency	:5180 MHz	Temp./Humi.	:23.4°C/56%
Test Mode	:Tx	Antenna Pol.	:Vertical
EUT Pol	:E2 Plane	Engineer	:Temo Chen

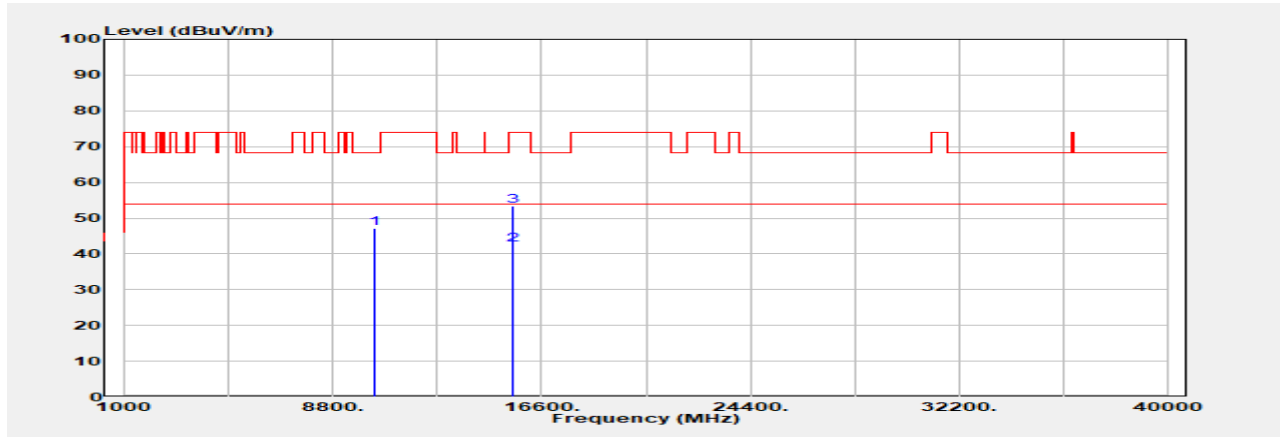

Freq. MHz	Detector Mode PK/QP/AVG	Spectrum Reading Level dB μ V	Factor dB	Actual FS dB μ V/m	Limit @3m dB μ V/m	Margin dB
10360.000	Peak	37.87	9.38	47.25	68.20	-20.95
15540.000	Average	30.46	11.96	42.42	54.00	-11.58
15540.000	Peak	41.33	11.96	53.29	74.00	-20.71

Unless otherwise stated the results shown in this test report refer only to the sample(s) tested and such sample(s) are retained for 90 days only.

除非另有說明，此報告結果僅對測試之樣品負責，同時此樣品僅保留90天。本報告未經本公司書面許可，不可部份複製。

This document is issued by the Company subject to its General Conditions of Service printed overleaf, available on request or accessible at <http://www.sgs.com.tw/Terms-and-Conditions> and for electronic format documents, subject to Terms and Conditions for Electronic Documents at <http://www.sgs.com.tw/Terms-and-Conditions>. Attention is drawn to the limitation of liability, indemnification and jurisdiction issues defined therein. Any holder of this document is advised that information contained hereon reflects the Company's findings at the time of its intervention only and within the limits of Client's instructions, if any. The Company's sole responsibility is to its Client and this document does not exonerate parties to a transaction from exercising all their rights and obligations under the transaction documents. This document cannot be reproduced except in full, without prior written approval of the Company. Any unauthorized alteration, forgery or falsification of the content or appearance of this document is unlawful and offenders may be prosecuted to the fullest extent of the law.

Report Number	:TERF2308001923E2	Test Site	:SAC G Chamber
Operation Mode	:802.11n20	Test Date	:2023-09-25
Test Frequency	:5180 MHz	Temp./Humi.	:23.4°C/56%
Test Mode	:Tx	Antenna Pol.	:Horizontal
EUT Pol	:E2 Plane	Engineer	:Temo Chen

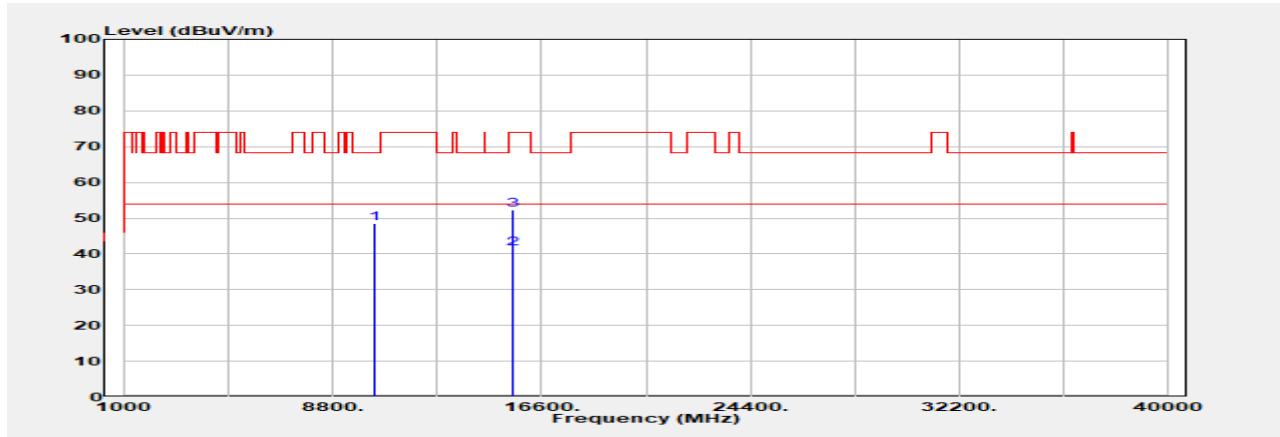

Freq. MHz	Detector Mode PK/QP/AVG	Spectrum Reading Level dB μ V	Factor dB	Actual FS dB μ V/m	Limit @3m dB μ V/m	Margin dB
10360.000	Peak	39.03	9.38	48.41	68.20	-19.79
15540.000	Average	29.43	11.96	41.39	54.00	-12.61
15540.000	Peak	40.31	11.96	52.27	74.00	-21.73

Unless otherwise stated the results shown in this test report refer only to the sample(s) tested and such sample(s) are retained for 90 days only.

除非另有說明，此報告結果僅對測試之樣品負責，同時此樣品僅保留90天。本報告未經本公司書面許可，不可部份複製。

This document is issued by the Company subject to its General Conditions of Service printed overleaf, available on request or accessible at <http://www.sgs.com.tw/Terms-and-Conditions> and for electronic format documents, subject to Terms and Conditions for Electronic Documents at <http://www.sgs.com.tw/Terms-and-Conditions>. Attention is drawn to the limitation of liability, indemnification and jurisdiction issues defined therein. Any holder of this document is advised that information contained hereon reflects the Company's findings at the time of its intervention only and within the limits of Client's instructions, if any. The Company's sole responsibility is to its Client and this document does not exonerate parties to a transaction from exercising all their rights and obligations under the transaction documents. This document cannot be reproduced except in full, without prior written approval of the Company. Any unauthorized alteration, forgery or falsification of the content or appearance of this document is unlawful and offenders may be prosecuted to the fullest extent of the law.

Report Number :TERF2308001923E2
 Operation Mode :802.11n20
 Test Frequency :5220 MHz
 Test Mode :Tx
 EUT Pol :E2 Plane

Test Site :SAC G Chamber
 Test Date :2023-09-25
 Temp./Humi. :23.4°C/56%
 Antenna Pol. :Vertical
 Engineer :Temo Chen

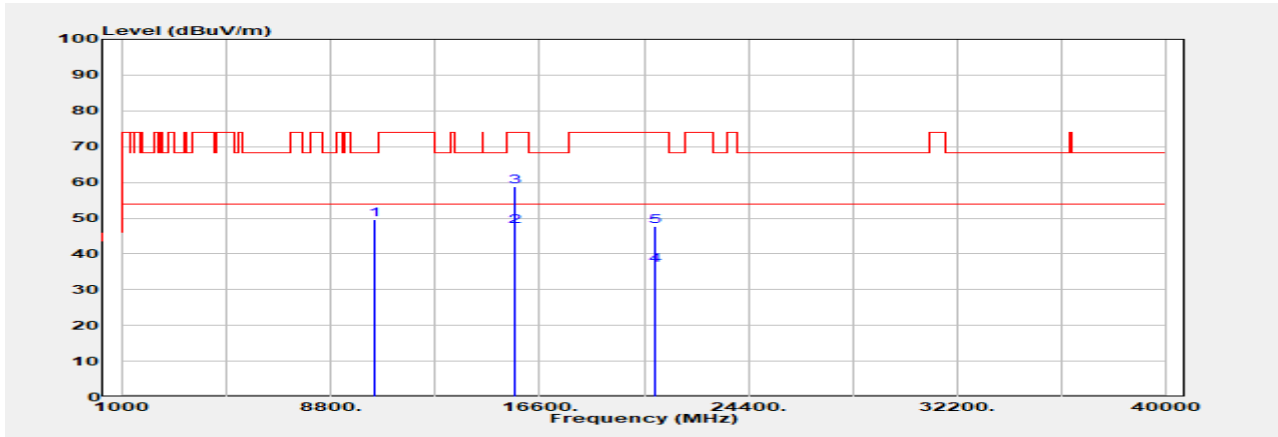

Freq. MHz	Detector Mode PK/QP/AVG	Spectrum Reading Level dB μ V	Factor dB	Actual FS dB μ V/m	Limit @3m dB μ V/m	Margin dB
10440.000	Peak	39.99	9.66	49.65	68.20	-18.55
15660.000	Average	35.35	12.32	47.67	54.00	-6.33
15660.000	Peak	46.50	12.32	58.82	74.00	-15.18
20880.000	Average	36.76	0.17	36.93	54.00	-17.07
20880.000	Peak	47.64	0.17	47.81	74.00	-26.19

Unless otherwise stated the results shown in this test report refer only to the sample(s) tested and such sample(s) are retained for 90 days only.

除非另有說明，此報告結果僅對測試之樣品負責，同時此樣品僅保留90天。本報告未經本公司書面許可，不可部份複製。

This document is issued by the Company subject to its General Conditions of Service printed overleaf, available on request or accessible at <http://www.sgs.com.tw/Terms-and-Conditions> and for electronic format documents, subject to Terms and Conditions for Electronic Documents at <http://www.sgs.com.tw/Terms-and-Conditions>. Attention is drawn to the limitation of liability, indemnification and jurisdiction issues defined therein. Any holder of this document is advised that information contained hereon reflects the Company's findings at the time of its intervention only and within the limits of Client's instructions, if any. The Company's sole responsibility is to its Client and this document does not exonerate parties to a transaction from exercising all their rights and obligations under the transaction documents. This document cannot be reproduced except in full, without prior written approval of the Company. Any unauthorized alteration, forgery or falsification of the content or appearance of this document is unlawful and offenders may be prosecuted to the fullest extent of the law.

Report Number :TERF2308001923E2
 Operation Mode :802.11n20
 Test Frequency :5220 MHz
 Test Mode :Tx
 EUT Pol :E2 Plane

Test Site :SAC G Chamber
 Test Date :2023-09-25
 Temp./Humi. :23.4°C/56%
 Antenna Pol. :Horizontal
 Engineer :Temo Chen

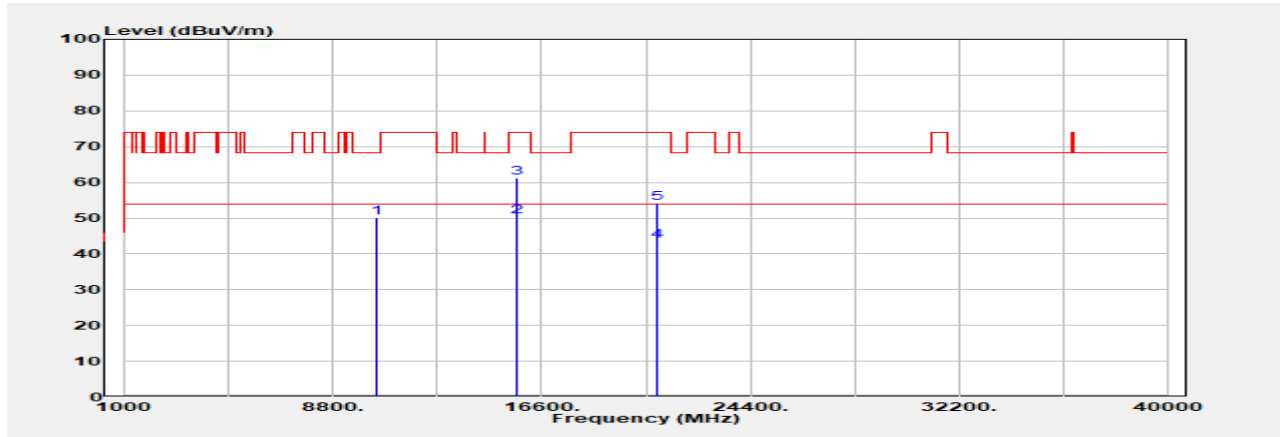

Freq. MHz	Detector Mode PK/QP/AVG	Spectrum Reading Level dB μ V	Factor dB	Actual FS dB μ V/m	Limit @3m dB μ V/m	Margin dB
10440.000	Peak	40.46	9.66	50.12	68.20	-18.08
15660.000	Average	37.97	12.32	50.29	54.00	-3.71
15660.000	Peak	48.80	12.32	61.12	74.00	-12.88
20880.000	Average	43.48	0.17	43.65	54.00	-10.35
20880.000	Peak	54.00	0.17	54.17	74.00	-19.83

Unless otherwise stated the results shown in this test report refer only to the sample(s) tested and such sample(s) are retained for 90 days only.

除非另有說明，此報告結果僅對測試之樣品負責，同時此樣品僅保留90天。本報告未經本公司書面許可，不可部份複製。

This document is issued by the Company subject to its General Conditions of Service printed overleaf, available on request or accessible at <http://www.sgs.com.tw/Terms-and-Conditions> and for electronic format documents, subject to Terms and Conditions for Electronic Documents at <http://www.sgs.com.tw/Terms-and-Conditions>. Attention is drawn to the limitation of liability, indemnification and jurisdiction issues defined therein. Any holder of this document is advised that information contained hereon reflects the Company's findings at the time of its intervention only and within the limits of Client's instructions, if any. The Company's sole responsibility is to its Client and this document does not exonerate parties to a transaction from exercising all their rights and obligations under the transaction documents. This document cannot be reproduced except in full, without prior written approval of the Company. Any unauthorized alteration, forgery or falsification of the content or appearance of this document is unlawful and offenders may be prosecuted to the fullest extent of the law.

Report Number	:TERF2308001923E2	Test Site	:SAC G Chamber
Operation Mode	:802.11n20	Test Date	:2023-09-25
Test Frequency	:5240 MHz	Temp./Humi.	:23.4°C/56%
Test Mode	:Tx	Antenna Pol.	:Vertical
EUT Pol	:E2 Plane	Engineer	:Temo Chen

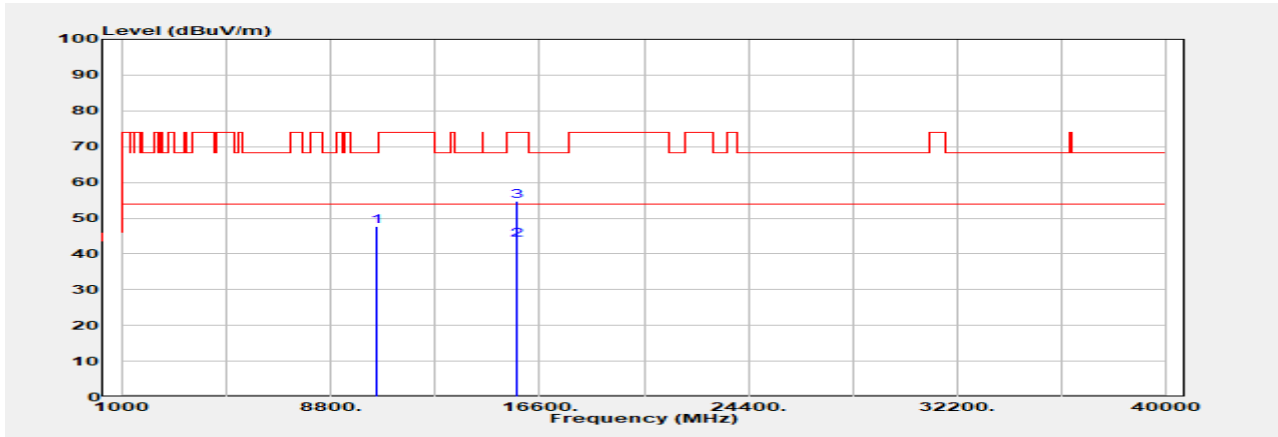

Freq. MHz	Detector Mode	Spectrum Reading Level dB μ V	Factor dB	Actual FS dB μ V/m	Limit @3m dB μ V/m	Margin dB
10480.000	Peak	37.87	9.82	47.69	68.20	-20.51
15720.000	Average	31.43	12.56	43.99	54.00	-10.01
15720.000	Peak	42.30	12.56	54.86	74.00	-19.14

Unless otherwise stated the results shown in this test report refer only to the sample(s) tested and such sample(s) are retained for 90 days only.

除非另有說明，此報告結果僅對測試之樣品負責，同時此樣品僅保留90天。本報告未經本公司書面許可，不可部份複製。

This document is issued by the Company subject to its General Conditions of Service printed overleaf, available on request or accessible at <http://www.sgs.com.tw/Terms-and-Conditions> and for electronic format documents, subject to Terms and Conditions for Electronic Documents at <http://www.sgs.com.tw/Terms-and-Conditions>. Attention is drawn to the limitation of liability, indemnification and jurisdiction issues defined therein. Any holder of this document is advised that information contained hereon reflects the Company's findings at the time of its intervention only and within the limits of Client's instructions, if any. The Company's sole responsibility is to its Client and this document does not exonerate parties to a transaction from exercising all their rights and obligations under the transaction documents. This document cannot be reproduced except in full, without prior written approval of the Company. Any unauthorized alteration, forgery or falsification of the content or appearance of this document is unlawful and offenders may be prosecuted to the fullest extent of the law.

Report Number	:TERF2308001923E2	Test Site	:SAC G Chamber
Operation Mode	:802.11n20	Test Date	:2023-09-25
Test Frequency	:5240 MHz	Temp./Humi.	:23.4°C/56%
Test Mode	:Tx	Antenna Pol.	:Horizontal
EUT Pol	:E2 Plane	Engineer	:Temo Chen

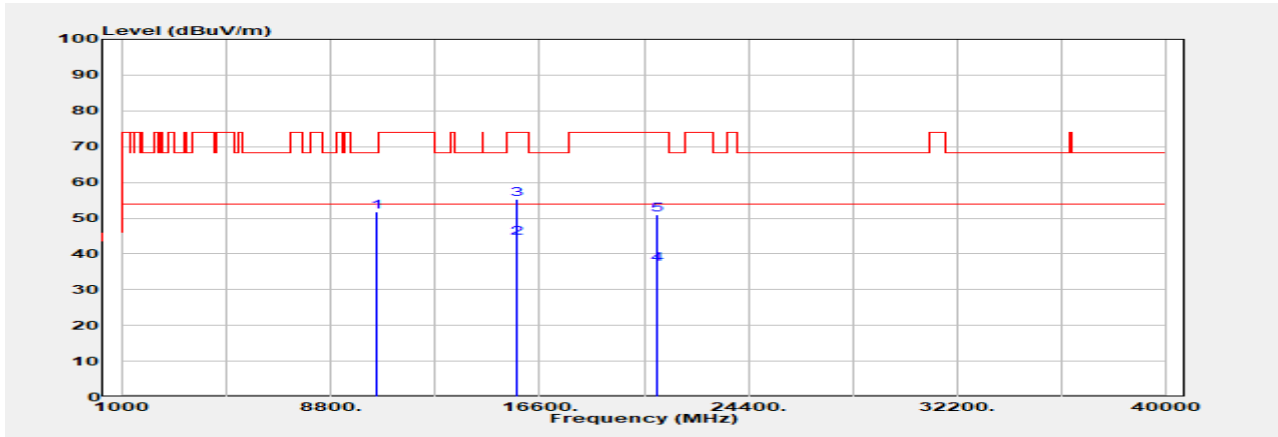

Freq. MHz	Detector Mode PK/QP/AVG	Spectrum Reading Level dB μ V	Factor dB	Actual FS dB μ V/m	Limit @3m dB μ V/m	Margin dB
10480.000	Peak	42.06	9.82	51.88	68.20	-16.32
15720.000	Average	31.76	12.56	44.32	54.00	-9.68
15720.000	Peak	42.86	12.56	55.42	74.00	-18.58
20960.000	Average	37.02	0.03	37.05	54.00	-16.95
20960.000	Peak	51.05	0.03	51.08	74.00	-22.92

Unless otherwise stated the results shown in this test report refer only to the sample(s) tested and such sample(s) are retained for 90 days only.

除非另有說明，此報告結果僅對測試之樣品負責，同時此樣品僅保留90天。本報告未經本公司書面許可，不可部份複製。

This document is issued by the Company subject to its General Conditions of Service printed overleaf, available on request or accessible at <http://www.sgs.com.tw/Terms-and-Conditions> and for electronic format documents, subject to Terms and Conditions for Electronic Documents at <http://www.sgs.com.tw/Terms-and-Conditions>. Attention is drawn to the limitation of liability, indemnification and jurisdiction issues defined therein. Any holder of this document is advised that information contained hereon reflects the Company's findings at the time of its intervention only and within the limits of Client's instructions, if any. The Company's sole responsibility is to its Client and this document does not exonerate parties to a transaction from exercising all their rights and obligations under the transaction documents. This document cannot be reproduced except in full, without prior written approval of the Company. Any unauthorized alteration, forgery or falsification of the content or appearance of this document is unlawful and offenders may be prosecuted to the fullest extent of the law.

Report Number :TERF2308001923E2
 Operation Mode :802.11n20
 Test Frequency :5260 MHz
 Test Mode :Tx
 EUT Pol :E2 Plane

Test Site :SAC G Chamber
 Test Date :2023-09-25
 Temp./Humi. :23.4°C/56%
 Antenna Pol. :Vertical
 Engineer :Temo Chen

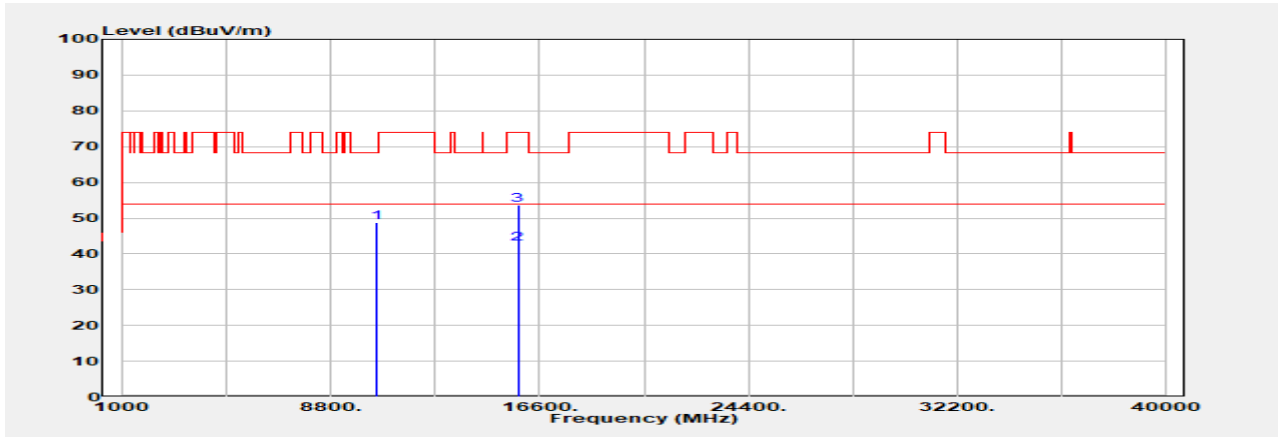

Freq. MHz	Detector Mode PK/QP/AVG	Spectrum Reading Level dB μ V	Factor dB	Actual FS dB μ V/m	Limit @3m dB μ V/m	Margin dB
10520.000	Peak	38.77	9.92	48.69	68.20	-19.51
15780.000	Average	30.43	12.44	42.87	54.00	-11.13
15780.000	Peak	41.23	12.44	53.67	74.00	-20.33

Unless otherwise stated the results shown in this test report refer only to the sample(s) tested and such sample(s) are retained for 90 days only.

除非另有說明，此報告結果僅對測試之樣品負責，同時此樣品僅保留90天。本報告未經本公司書面許可，不可部份複製。

This document is issued by the Company subject to its General Conditions of Service printed overleaf, available on request or accessible at <http://www.sgs.com.tw/Terms-and-Conditions> and for electronic format documents, subject to Terms and Conditions for Electronic Documents at <http://www.sgs.com.tw/Terms-and-Conditions>. Attention is drawn to the limitation of liability, indemnification and jurisdiction issues defined therein. Any holder of this document is advised that information contained hereon reflects the Company's findings at the time of its intervention only and within the limits of Client's instructions, if any. The Company's sole responsibility is to its Client and this document does not exonerate parties to a transaction from exercising all their rights and obligations under the transaction documents. This document cannot be reproduced except in full, without prior written approval of the Company. Any unauthorized alteration, forgery or falsification of the content or appearance of this document is unlawful and offenders may be prosecuted to the fullest extent of the law.

Report Number	:TERF2308001923E2	Test Site	:SAC G Chamber
Operation Mode	:802.11n20	Test Date	:2023-09-25
Test Frequency	:5260 MHz	Temp./Humi.	:23.4°C/56%
Test Mode	:Tx	Antenna Pol.	:Horizontal
EUT Pol	:E2 Plane	Engineer	:Temo Chen

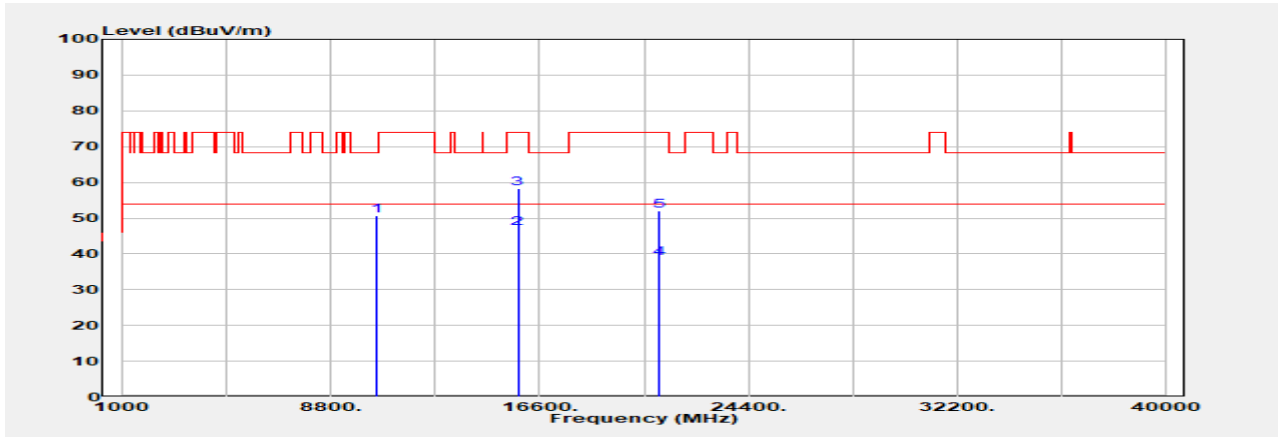

Freq. MHz	Detector Mode	Spectrum Reading Level dB μ V	Factor dB	Actual FS dB μ V/m	Limit @3m dB μ V/m	Margin dB
10520.000	Peak	40.75	9.92	50.67	68.20	-17.53
15780.000	Average	34.76	12.44	47.20	54.00	-6.80
15780.000	Peak	45.78	12.44	58.22	74.00	-15.78
21040.000	Average	39.32	-0.55	38.77	54.00	-15.23
21040.000	Peak	52.65	-0.55	52.10	74.00	-21.90

Unless otherwise stated the results shown in this test report refer only to the sample(s) tested and such sample(s) are retained for 90 days only.

除非另有說明，此報告結果僅對測試之樣品負責，同時此樣品僅保留90天。本報告未經本公司書面許可，不可部份複製。

This document is issued by the Company subject to its General Conditions of Service printed overleaf, available on request or accessible at <http://www.sgs.com.tw/Terms-and-Conditions> and for electronic format documents, subject to Terms and Conditions for Electronic Documents at <http://www.sgs.com.tw/Terms-and-Conditions>. Attention is drawn to the limitation of liability, indemnification and jurisdiction issues defined therein. Any holder of this document is advised that information contained hereon reflects the Company's findings at the time of its intervention only and within the limits of Client's instructions, if any. The Company's sole responsibility is to its Client and this document does not exonerate parties to a transaction from exercising all their rights and obligations under the transaction documents. This document cannot be reproduced except in full, without prior written approval of the Company. Any unauthorized alteration, forgery or falsification of the content or appearance of this document is unlawful and offenders may be prosecuted to the fullest extent of the law.

Report Number	:TERF2308001923E2	Test Site	:SAC G Chamber
Operation Mode	:802.11n20	Test Date	:2023-09-25
Test Frequency	:5280 MHz	Temp./Humi.	:23.4°C/56%
Test Mode	:Tx	Antenna Pol.	:Vertical
EUT Pol	:E2 Plane	Engineer	:Temo Chen

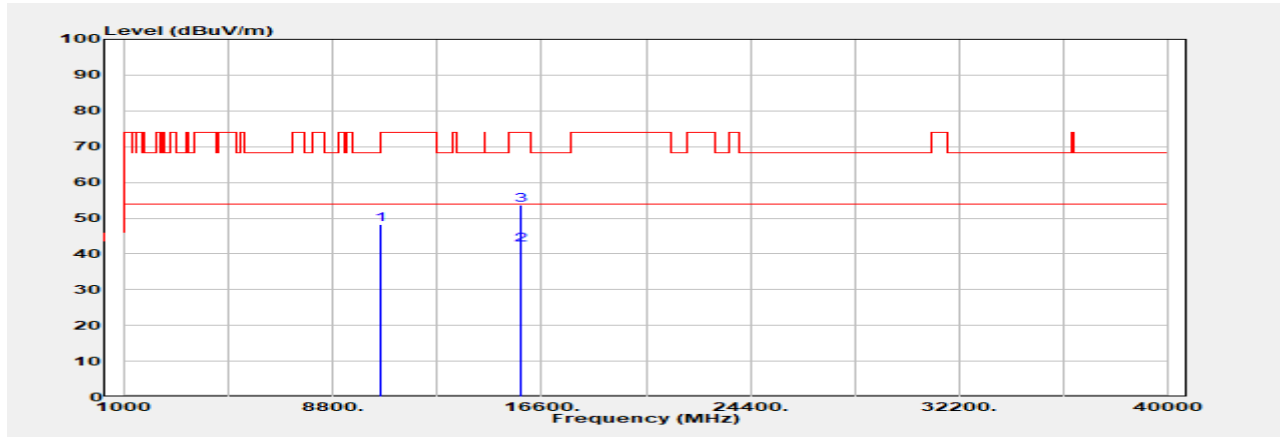

Freq. MHz	Detector Mode PK/QP/AVG	Spectrum Reading Level dB μ V	Factor dB	Actual FS dB μ V/m	Limit @3m dB μ V/m	Margin dB
10560.000	Peak	38.32	9.96	48.28	68.20	-19.92
15840.000	Average	30.12	12.32	42.44	54.00	-11.56
15840.000	Peak	41.35	12.32	53.66	74.00	-20.34

Unless otherwise stated the results shown in this test report refer only to the sample(s) tested and such sample(s) are retained for 90 days only.

除非另有說明，此報告結果僅對測試之樣品負責，同時此樣品僅保留90天。本報告未經本公司書面許可，不可部份複製。

This document is issued by the Company subject to its General Conditions of Service printed overleaf, available on request or accessible at <http://www.sgs.com.tw/Terms-and-Conditions> and for electronic format documents, subject to Terms and Conditions for Electronic Documents at <http://www.sgs.com.tw/Terms-and-Conditions>. Attention is drawn to the limitation of liability, indemnification and jurisdiction issues defined therein. Any holder of this document is advised that information contained hereon reflects the Company's findings at the time of its intervention only and within the limits of Client's instructions, if any. The Company's sole responsibility is to its Client and this document does not exonerate parties to a transaction from exercising all their rights and obligations under the transaction documents. This document cannot be reproduced except in full, without prior written approval of the Company. Any unauthorized alteration, forgery or falsification of the content or appearance of this document is unlawful and offenders may be prosecuted to the fullest extent of the law.

Report Number	:TERF2308001923E2	Test Site	:SAC G Chamber
Operation Mode	:802.11n20	Test Date	:2023-09-25
Test Frequency	:5280 MHz	Temp./Humi.	:23.4°C/56%
Test Mode	:Tx	Antenna Pol.	:Horizontal
EUT Pol	:E2 Plane	Engineer	:Temo Chen

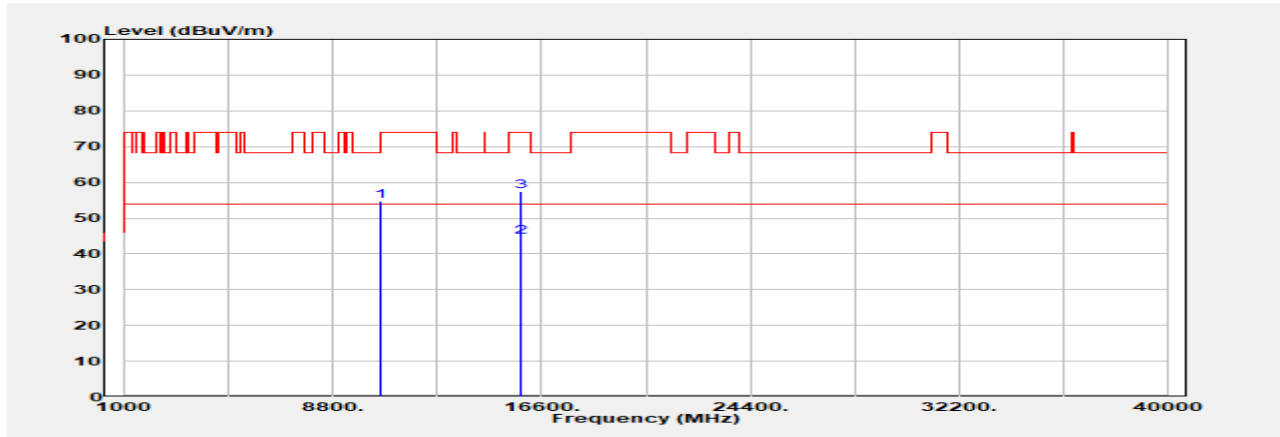

Freq. MHz	Detector Mode PK/QP/AVG	Spectrum Reading Level dB μ V	Factor dB	Actual FS dB μ V/m	Limit @3m dB μ V/m	Margin dB
10560.000	Peak	44.78	9.96	54.74	68.20	-13.46
15840.000	Average	32.43	12.32	44.75	54.00	-9.25
15840.000	Peak	45.21	12.32	57.53	74.00	-16.47

Unless otherwise stated the results shown in this test report refer only to the sample(s) tested and such sample(s) are retained for 90 days only.

除非另有說明，此報告結果僅對測試之樣品負責，同時此樣品僅保留90天。本報告未經本公司書面許可，不可部份複製。

This document is issued by the Company subject to its General Conditions of Service printed overleaf, available on request or accessible at <http://www.sgs.com.tw/Terms-and-Conditions> and for electronic format documents, subject to Terms and Conditions for Electronic Documents at <http://www.sgs.com.tw/Terms-and-Conditions>. Attention is drawn to the limitation of liability, indemnification and jurisdiction issues defined therein. Any holder of this document is advised that information contained hereon reflects the Company's findings at the time of its intervention only and within the limits of Client's instructions, if any. The Company's sole responsibility is to its Client and this document does not exonerate parties to a transaction from exercising all their rights and obligations under the transaction documents. This document cannot be reproduced except in full, without prior written approval of the Company. Any unauthorized alteration, forgery or falsification of the content or appearance of this document is unlawful and offenders may be prosecuted to the fullest extent of the law.

Report Number	:TERF2308001923E2	Test Site	:SAC G Chamber
Operation Mode	:802.11n20	Test Date	:2023-09-25
Test Frequency	:5320 MHz	Temp./Humi.	:23.4°C/56%
Test Mode	:Tx	Antenna Pol.	:Vertical
EUT Pol	:E2 Plane	Engineer	:Temo Chen

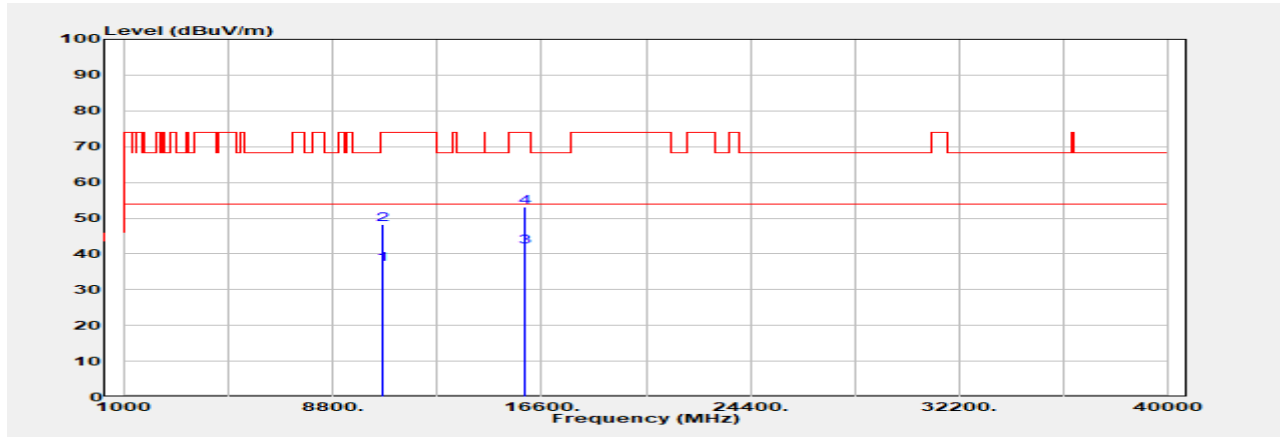

Freq. MHz	Detector Mode PK/QP/AVG	Spectrum Reading Level dB μ V	Factor dB	Actual FS dB μ V/m	Limit @3m dB μ V/m	Margin dB
10640.000	Average	27.49	9.72	37.21	54.00	-16.79
10640.000	Peak	38.53	9.72	48.25	74.00	-25.75
15960.000	Average	30.02	11.90	41.92	54.00	-12.08
15960.000	Peak	41.31	11.90	53.21	74.00	-20.79

Unless otherwise stated the results shown in this test report refer only to the sample(s) tested and such sample(s) are retained for 90 days only.

除非另有說明，此報告結果僅對測試之樣品負責，同時此樣品僅保留90天。本報告未經本公司書面許可，不可部份複製。

This document is issued by the Company subject to its General Conditions of Service printed overleaf, available on request or accessible at <http://www.sgs.com.tw/Terms-and-Conditions> and for electronic format documents, subject to Terms and Conditions for Electronic Documents at <http://www.sgs.com.tw/Terms-and-Conditions>. Attention is drawn to the limitation of liability, indemnification and jurisdiction issues defined therein. Any holder of this document is advised that information contained hereon reflects the Company's findings at the time of its intervention only and within the limits of Client's instructions, if any. The Company's sole responsibility is to its Client and this document does not exonerate parties to a transaction from exercising all their rights and obligations under the transaction documents. This document cannot be reproduced except in full, without prior written approval of the Company. Any unauthorized alteration, forgery or falsification of the content or appearance of this document is unlawful and offenders may be prosecuted to the fullest extent of the law.

Report Number	:TERF2308001923E2	Test Site	:SAC G Chamber
Operation Mode	:802.11n20	Test Date	:2023-09-25
Test Frequency	:5320 MHz	Temp./Humi.	:23.4°C/56%
Test Mode	:Tx	Antenna Pol.	:Horizontal
EUT Pol	:E2 Plane	Engineer	:Temo Chen

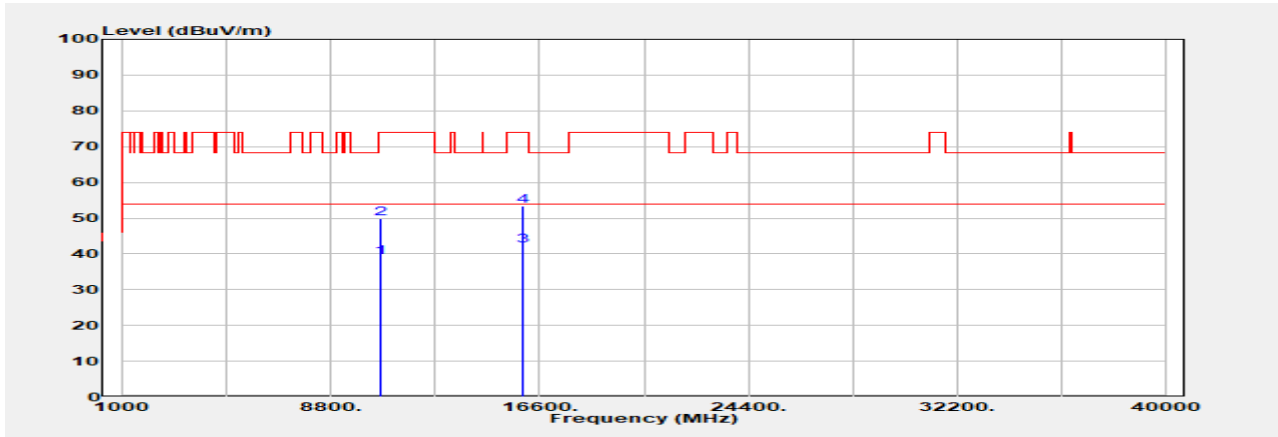

Freq. MHz	Detector Mode	Spectrum Reading Level dB μ V	Factor dB	Actual FS dB μ V/m	Limit @3m dB μ V/m	Margin dB
10640.000	Average	29.17	9.72	38.89	54.00	-15.11
10640.000	Peak	40.16	9.72	49.88	74.00	-24.12
15960.000	Average	30.33	11.90	42.23	54.00	-11.77
15960.000	Peak	41.49	11.90	53.39	74.00	-20.61

Unless otherwise stated the results shown in this test report refer only to the sample(s) tested and such sample(s) are retained for 90 days only.

除非另有說明，此報告結果僅對測試之樣品負責，同時此樣品僅保留90天。本報告未經本公司書面許可，不可部份複製。

This document is issued by the Company subject to its General Conditions of Service printed overleaf, available on request or accessible at <http://www.sgs.com.tw/Terms-and-Conditions> and for electronic format documents, subject to Terms and Conditions for Electronic Documents at <http://www.sgs.com.tw/Terms-and-Conditions>. Attention is drawn to the limitation of liability, indemnification and jurisdiction issues defined therein. Any holder of this document is advised that information contained hereon reflects the Company's findings at the time of its intervention only and within the limits of Client's instructions, if any. The Company's sole responsibility is to its Client and this document does not exonerate parties to a transaction from exercising all their rights and obligations under the transaction documents. This document cannot be reproduced except in full, without prior written approval of the Company. Any unauthorized alteration, forgery or falsification of the content or appearance of this document is unlawful and offenders may be prosecuted to the fullest extent of the law.

Report Number	:TERF2308001923E2	Test Site	:SAC G Chamber
Operation Mode	:802.11n20	Test Date	:2023-09-25
Test Frequency	:5500 MHz	Temp./Humi.	:23.4°C/56%
Test Mode	:Tx	Antenna Pol.	:Vertical
EUT Pol	:E2 Plane	Engineer	:Temo Chen

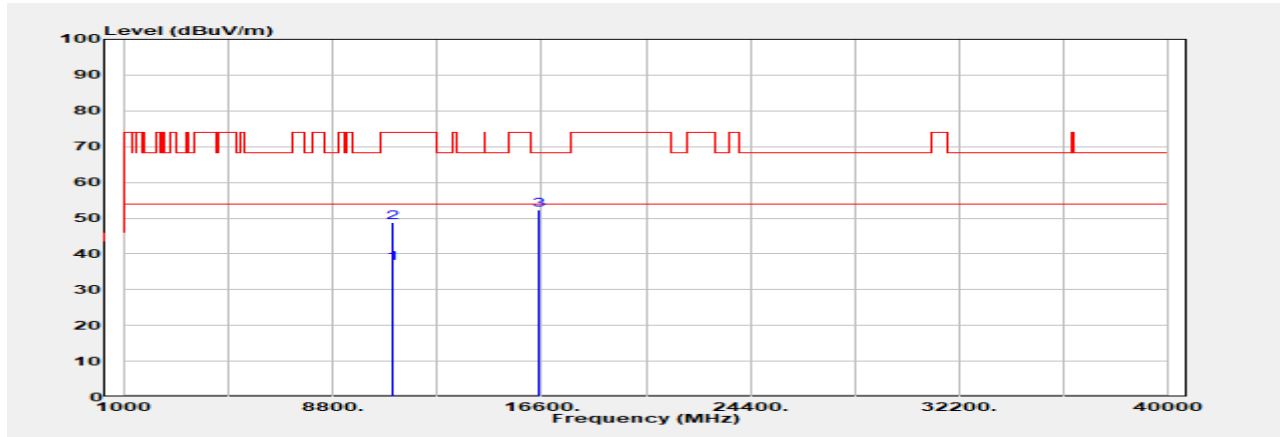

Freq. MHz	Detector Mode PK/QP/AVG	Spectrum Reading Level dB μ V	Factor dB	Actual FS dB μ V/m	Limit @3m dB μ V/m	Margin dB
11000.000	Average	25.41	11.90	37.31	54.00	-16.69
11000.000	Peak	36.88	11.90	48.78	74.00	-25.22
16500.000	Peak	40.42	12.00	52.42	68.20	-15.78

Unless otherwise stated the results shown in this test report refer only to the sample(s) tested and such sample(s) are retained for 90 days only.

除非另有說明，此報告結果僅對測試之樣品負責，同時此樣品僅保留90天。本報告未經本公司書面許可，不可部份複製。

This document is issued by the Company subject to its General Conditions of Service printed overleaf, available on request or accessible at <http://www.sgs.com.tw/Terms-and-Conditions> and for electronic format documents, subject to Terms and Conditions for Electronic Documents at <http://www.sgs.com.tw/Terms-and-Conditions>. Attention is drawn to the limitation of liability, indemnification and jurisdiction issues defined therein. Any holder of this document is advised that information contained hereon reflects the Company's findings at the time of its intervention only and within the limits of Client's instructions, if any. The Company's sole responsibility is to its Client and this document does not exonerate parties to a transaction from exercising all their rights and obligations under the transaction documents. This document cannot be reproduced except in full, without prior written approval of the Company. Any unauthorized alteration, forgery or falsification of the content or appearance of this document is unlawful and offenders may be prosecuted to the fullest extent of the law.

Report Number	:TERF2308001923E2	Test Site	:SAC G Chamber
Operation Mode	:802.11n20	Test Date	:2023-09-25
Test Frequency	:5500 MHz	Temp./Humi.	:23.4°C/56%
Test Mode	:Tx	Antenna Pol.	:Horizontal
EUT Pol	:E2 Plane	Engineer	:Temo Chen

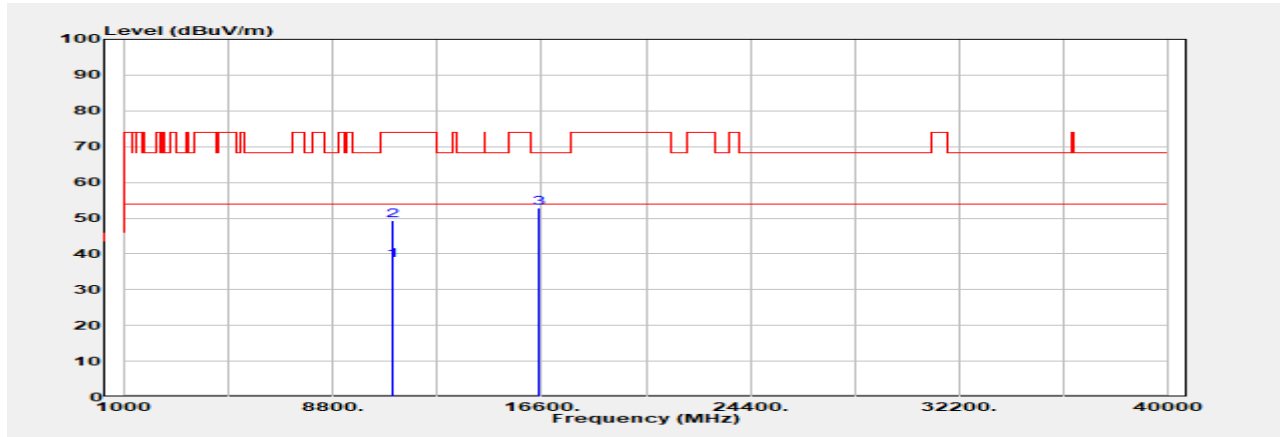

Freq. MHz	Detector Mode PK/QP/AVG	Spectrum Reading Level dBµV	Factor dB	Actual FS dBµV/m	Limit @3m dBµV/m	Margin dB
11000.000	Average	26.32	11.90	38.22	54.00	-15.78
11000.000	Peak	37.44	11.90	49.34	74.00	-24.66
16500.000	Peak	40.73	12.00	52.73	68.20	-15.47

Unless otherwise stated the results shown in this test report refer only to the sample(s) tested and such sample(s) are retained for 90 days only.

除非另有說明，此報告結果僅對測試之樣品負責，同時此樣品僅保留90天。本報告未經本公司書面許可，不可部份複製。

This document is issued by the Company subject to its General Conditions of Service printed overleaf, available on request or accessible at <http://www.sgs.com.tw/Terms-and-Conditions> and for electronic format documents, subject to Terms and Conditions for Electronic Documents at <http://www.sgs.com.tw/Terms-and-Conditions>. Attention is drawn to the limitation of liability, indemnification and jurisdiction issues defined therein. Any holder of this document is advised that information contained hereon reflects the Company's findings at the time of its intervention only and within the limits of Client's instructions, if any. The Company's sole responsibility is to its Client and this document does not exonerate parties to a transaction from exercising all their rights and obligations under the transaction documents. This document cannot be reproduced except in full, without prior written approval of the Company. Any unauthorized alteration, forgery or falsification of the content or appearance of this document is unlawful and offenders may be prosecuted to the fullest extent of the law.

Report Number	:TERF2308001923E2	Test Site	:SAC G Chamber
Operation Mode	:802.11n20	Test Date	:2023-09-25
Test Frequency	:5580 MHz	Temp./Humi.	:23.4°C/56%
Test Mode	:Tx	Antenna Pol.	:Vertical
EUT Pol	:E2 Plane	Engineer	:Temo Chen



Freq. MHz	Detector Mode PK/QP/AVG	Spectrum Reading Level dB μ V	Factor dB	Actual FS dB μ V/m	Limit @3m dB μ V/m	Margin dB
11160.000	Average	27.12	9.88	37.00	54.00	-17.00
11160.000	Peak	38.32	9.88	48.20	74.00	-25.80
16740.000	Peak	42.33	11.66	53.99	68.20	-14.21

Unless otherwise stated the results shown in this test report refer only to the sample(s) tested and such sample(s) are retained for 90 days only.

除非另有說明，此報告結果僅對測試之樣品負責，同時此樣品僅保留90天。本報告未經本公司書面許可，不可部份複製。

This document is issued by the Company subject to its General Conditions of Service printed overleaf, available on request or accessible at <http://www.sgs.com.tw/Terms-and-Conditions> and for electronic format documents, subject to Terms and Conditions for Electronic Documents at <http://www.sgs.com.tw/Terms-and-Conditions>. Attention is drawn to the limitation of liability, indemnification and jurisdiction issues defined therein. Any holder of this document is advised that information contained hereon reflects the Company's findings at the time of its intervention only and within the limits of Client's instructions, if any. The Company's sole responsibility is to its Client and this document does not exonerate parties to a transaction from exercising all their rights and obligations under the transaction documents. This document cannot be reproduced except in full, without prior written approval of the Company. Any unauthorized alteration, forgery or falsification of the content or appearance of this document is unlawful and offenders may be prosecuted to the fullest extent of the law.

Report Number	:TERF2308001923E2	Test Site	:SAC G Chamber
Operation Mode	:802.11n20	Test Date	:2023-09-25
Test Frequency	:5580 MHz	Temp./Humi.	:23.4°C/56%
Test Mode	:Tx	Antenna Pol.	:Horizontal
EUT Pol	:E2 Plane	Engineer	:Temo Chen

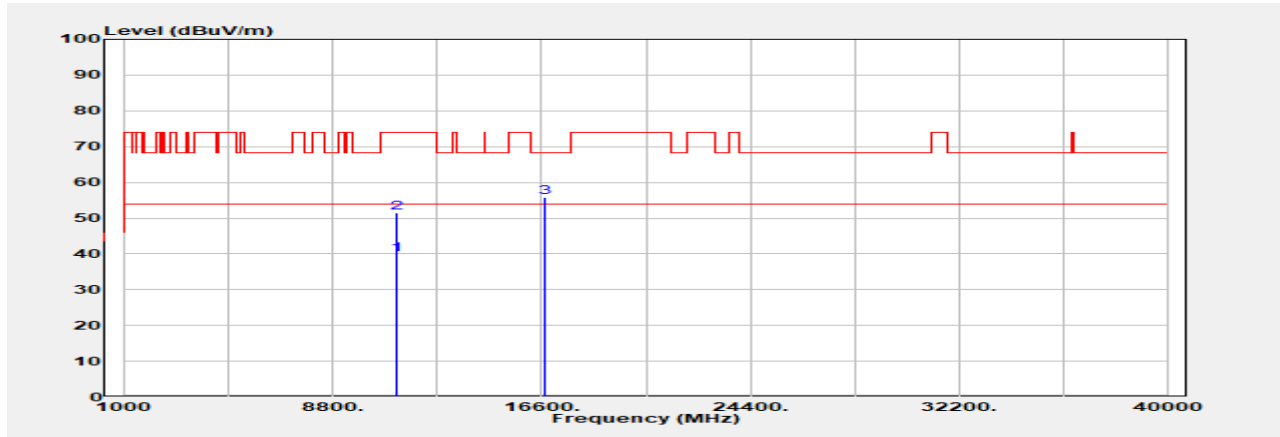

Freq. MHz	Detector Mode PK/QP/AVG	Spectrum Reading Level dB μ V	Factor dB	Actual FS dB μ V/m	Limit @3m dB μ V/m	Margin dB
11160.000	Average	30.05	9.88	39.93	54.00	-14.07
11160.000	Peak	41.62	9.88	51.50	74.00	-22.50
16740.000	Peak	44.22	11.66	55.88	68.20	-12.32

Unless otherwise stated the results shown in this test report refer only to the sample(s) tested and such sample(s) are retained for 90 days only.

除非另有說明，此報告結果僅對測試之樣品負責，同時此樣品僅保留90天。本報告未經本公司書面許可，不可部份複製。

This document is issued by the Company subject to its General Conditions of Service printed overleaf, available on request or accessible at <http://www.sgs.com.tw/Terms-and-Conditions> and for electronic format documents, subject to Terms and Conditions for Electronic Documents at <http://www.sgs.com.tw/Terms-and-Conditions>. Attention is drawn to the limitation of liability, indemnification and jurisdiction issues defined therein. Any holder of this document is advised that information contained hereon reflects the Company's findings at the time of its intervention only and within the limits of Client's instructions, if any. The Company's sole responsibility is to its Client and this document does not exonerate parties to a transaction from exercising all their rights and obligations under the transaction documents. This document cannot be reproduced except in full, without prior written approval of the Company. Any unauthorized alteration, forgery or falsification of the content or appearance of this document is unlawful and offenders may be prosecuted to the fullest extent of the law.

Report Number	:TERF2308001923E2	Test Site	:SAC G Chamber
Operation Mode	:802.11n20	Test Date	:2023-09-25
Test Frequency	:5700 MHz	Temp./Humi.	:23.4°C/56%
Test Mode	:Tx	Antenna Pol.	:Vertical
EUT Pol	:E2 Plane	Engineer	:Temo Chen

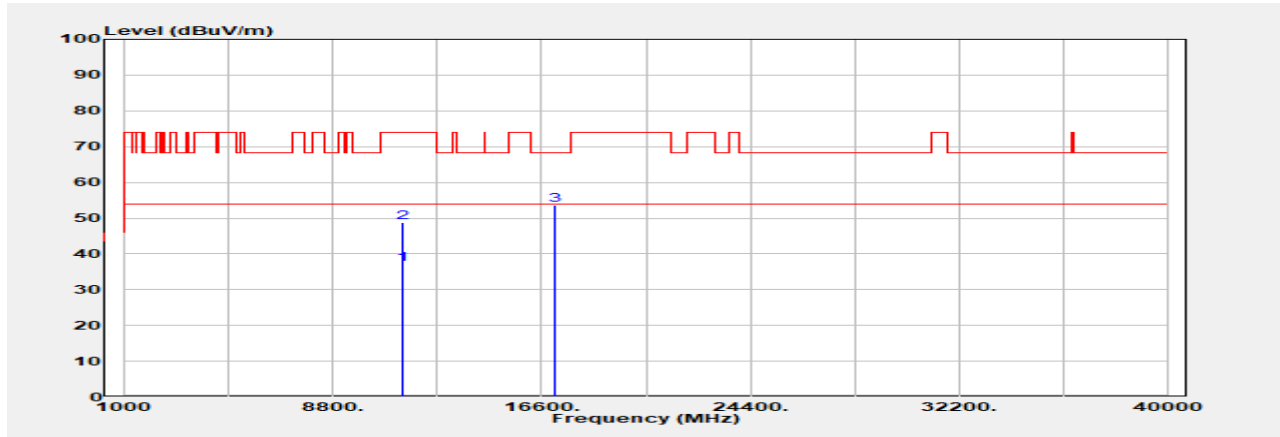

Freq. MHz	Detector Mode	Spectrum Reading Level dB μ V	Factor dB	Actual FS dB μ V/m	Limit @3m dB μ V/m	Margin dB
11400.000	Average	27.43	9.80	37.23	54.00	-16.77
11400.000	Peak	38.88	9.80	48.68	74.00	-25.32
17100.000	Peak	41.36	12.20	53.56	68.20	-14.64

Unless otherwise stated the results shown in this test report refer only to the sample(s) tested and such sample(s) are retained for 90 days only.

除非另有說明，此報告結果僅對測試之樣品負責，同時此樣品僅保留90天。本報告未經本公司書面許可，不可部份複製。

This document is issued by the Company subject to its General Conditions of Service printed overleaf, available on request or accessible at <http://www.sgs.com.tw/Terms-and-Conditions> and for electronic format documents, subject to Terms and Conditions for Electronic Documents at <http://www.sgs.com.tw/Terms-and-Conditions>. Attention is drawn to the limitation of liability, indemnification and jurisdiction issues defined therein. Any holder of this document is advised that information contained hereon reflects the Company's findings at the time of its intervention only and within the limits of Client's instructions, if any. The Company's sole responsibility is to its Client and this document does not exonerate parties to a transaction from exercising all their rights and obligations under the transaction documents. This document cannot be reproduced except in full, without prior written approval of the Company. Any unauthorized alteration, forgery or falsification of the content or appearance of this document is unlawful and offenders may be prosecuted to the fullest extent of the law.

Report Number	:TERF2308001923E2	Test Site	:SAC G Chamber
Operation Mode	:802.11n20	Test Date	:2023-09-25
Test Frequency	:5700 MHz	Temp./Humi.	:23.4°C/56%
Test Mode	:Tx	Antenna Pol.	:Horizontal
EUT Pol	:E2 Plane	Engineer	:Temo Chen

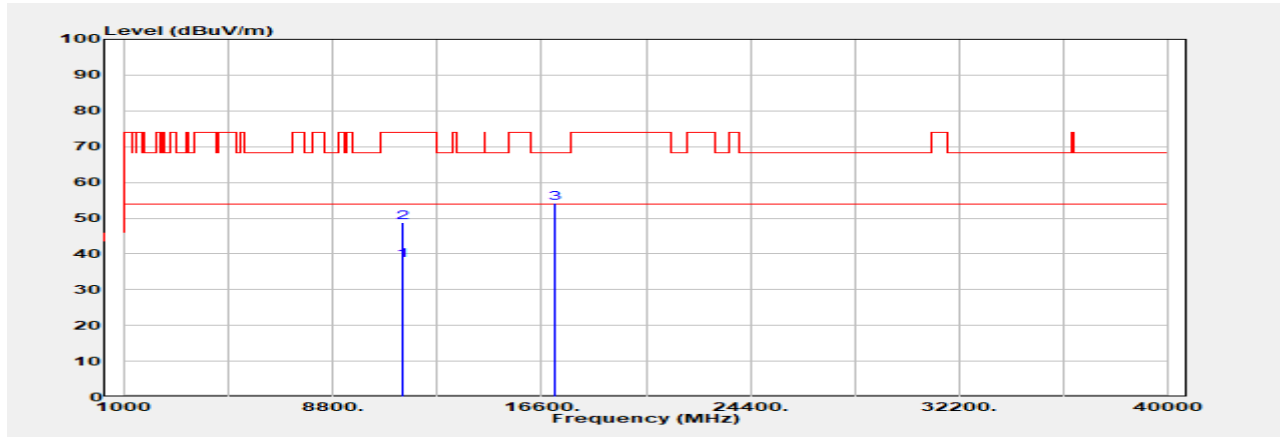

Freq. MHz	Detector Mode PK/QP/AVG	Spectrum Reading Level dBμV	Factor dB	Actual FS dBμV/m	Limit @3m dBμV/m	Margin dB
11400.000	Average	28.53	9.80	38.33	54.00	-15.67
11400.000	Peak	39.04	9.80	48.84	74.00	-25.16
17100.000	Peak	41.91	12.20	54.11	68.20	-14.09

Unless otherwise stated the results shown in this test report refer only to the sample(s) tested and such sample(s) are retained for 90 days only.

除非另有說明，此報告結果僅對測試之樣品負責，同時此樣品僅保留90天。本報告未經本公司書面許可，不可部份複製。

This document is issued by the Company subject to its General Conditions of Service printed overleaf, available on request or accessible at <http://www.sgs.com.tw/Terms-and-Conditions> and for electronic format documents, subject to Terms and Conditions for Electronic Documents at <http://www.sgs.com.tw/Terms-and-Conditions>. Attention is drawn to the limitation of liability, indemnification and jurisdiction issues defined therein. Any holder of this document is advised that information contained hereon reflects the Company's findings at the time of its intervention only and within the limits of Client's instructions, if any. The Company's sole responsibility is to its Client and this document does not exonerate parties to a transaction from exercising all their rights and obligations under the transaction documents. This document cannot be reproduced except in full, without prior written approval of the Company. Any unauthorized alteration, forgery or falsification of the content or appearance of this document is unlawful and offenders may be prosecuted to the fullest extent of the law.

Report Number	:TERF2308001923E2	Test Site	:SAC G Chamber
Operation Mode	:802.11n20	Test Date	:2023-09-25
Test Frequency	:5720 MHz	Temp./Humi.	:23.4°C/56%
Test Mode	:Tx	Antenna Pol.	:Vertical
EUT Pol	:E2 Plane	Engineer	:Temo Chen

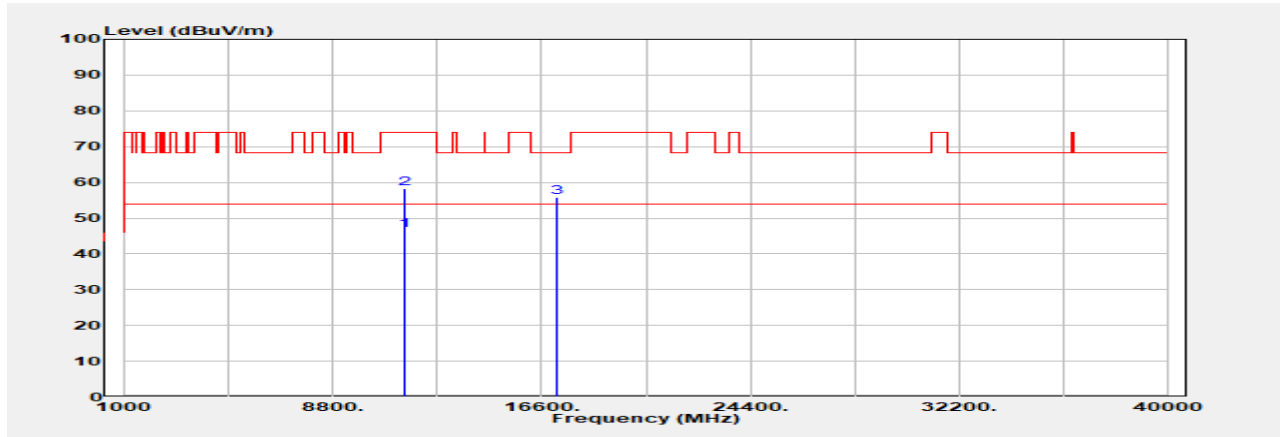

Freq. MHz	Detector Mode	Spectrum Reading Level dBμV	Factor dB	Actual FS dBμV/m	Limit @3m dBμV/m	Margin dB
11440.000	Average	36.32	10.36	46.68	54.00	-7.32
11440.000	Peak	47.89	10.36	58.25	74.00	-15.75
17160.000	Peak	44.75	11.12	55.87	68.20	-12.33

Unless otherwise stated the results shown in this test report refer only to the sample(s) tested and such sample(s) are retained for 90 days only.

除非另有說明，此報告結果僅對測試之樣品負責，同時此樣品僅保留90天。本報告未經本公司書面許可，不可部份複製。

This document is issued by the Company subject to its General Conditions of Service printed overleaf, available on request or accessible at <http://www.sgs.com.tw/Terms-and-Conditions> and for electronic format documents, subject to Terms and Conditions for Electronic Documents at <http://www.sgs.com.tw/Terms-and-Conditions>. Attention is drawn to the limitation of liability, indemnification and jurisdiction issues defined therein. Any holder of this document is advised that information contained hereon reflects the Company's findings at the time of its intervention only and within the limits of Client's instructions, if any. The Company's sole responsibility is to its Client and this document does not exonerate parties to a transaction from exercising all their rights and obligations under the transaction documents. This document cannot be reproduced except in full, without prior written approval of the Company. Any unauthorized alteration, forgery or falsification of the content or appearance of this document is unlawful and offenders may be prosecuted to the fullest extent of the law.

Report Number	:TERF2308001923E2	Test Site	:SAC G Chamber
Operation Mode	:802.11n20	Test Date	:2023-09-25
Test Frequency	:5720 MHz	Temp./Humi.	:23.4°C/56%
Test Mode	:Tx	Antenna Pol.	:Horizontal
EUT Pol	:E2 Plane	Engineer	:Temo Chen

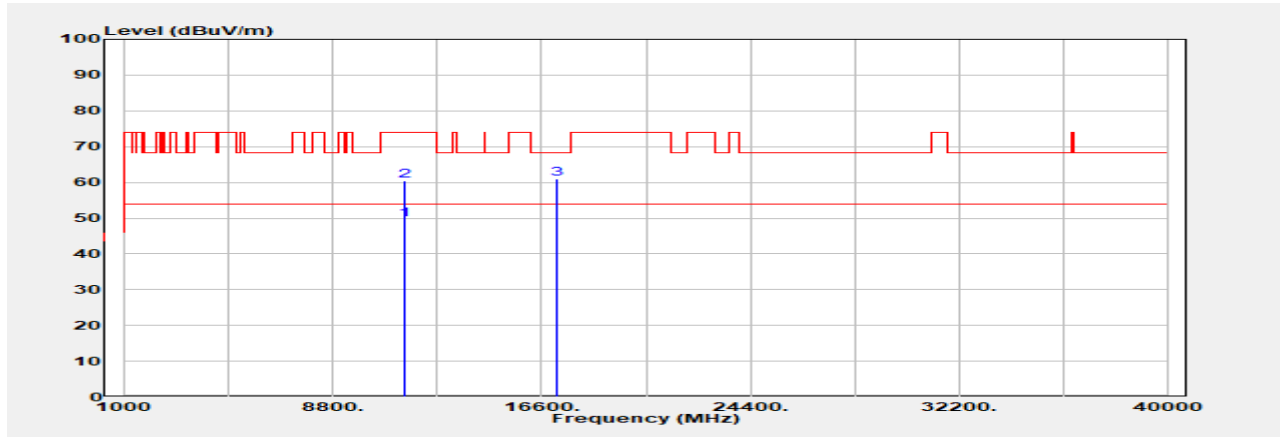

Freq. MHz	Detector Mode PK/QP/AVG	Spectrum Reading Level dBμV	Factor dB	Actual FS dBμV/m	Limit @3m dBμV/m	Margin dB
11440.000	Average	39.13	10.36	49.49	54.00	-4.51
11440.000	Peak	50.04	10.36	60.41	74.00	-13.59
17160.000	Peak	49.80	11.12	60.91	68.20	-7.29

Unless otherwise stated the results shown in this test report refer only to the sample(s) tested and such sample(s) are retained for 90 days only.

除非另有說明，此報告結果僅對測試之樣品負責，同時此樣品僅保留90天。本報告未經本公司書面許可，不可部份複製。

This document is issued by the Company subject to its General Conditions of Service printed overleaf, available on request or accessible at <http://www.sgs.com.tw/Terms-and-Conditions> and for electronic format documents, subject to Terms and Conditions for Electronic Documents at <http://www.sgs.com.tw/Terms-and-Conditions>. Attention is drawn to the limitation of liability, indemnification and jurisdiction issues defined therein. Any holder of this document is advised that information contained hereon reflects the Company's findings at the time of its intervention only and within the limits of Client's instructions, if any. The Company's sole responsibility is to its Client and this document does not exonerate parties to a transaction from exercising all their rights and obligations under the transaction documents. This document cannot be reproduced except in full, without prior written approval of the Company. Any unauthorized alteration, forgery or falsification of the content or appearance of this document is unlawful and offenders may be prosecuted to the fullest extent of the law.

Report Number	:TERF2308001923E2	Test Site	:SAC G Chamber
Operation Mode	:802.11n20	Test Date	:2023-09-25
Test Frequency	:5745 MHz	Temp./Humi.	:23.4°C/56%
Test Mode	:Tx	Antenna Pol.	:Vertical
EUT Pol	:E2 Plane	Engineer	:Temo Chen

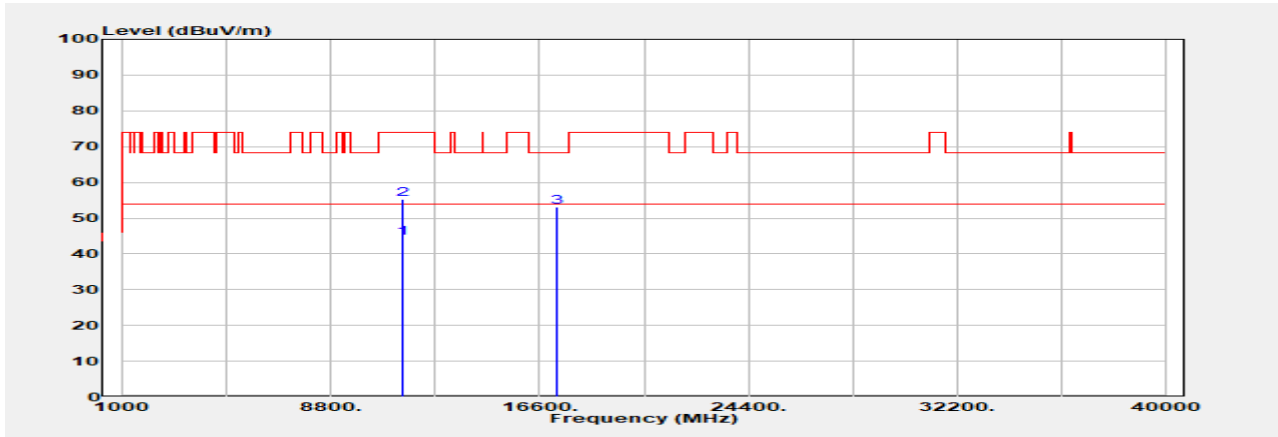

Freq. MHz	Detector Mode PK/QP/AVG	Spectrum Reading Level dBµV	Factor dB	Actual FS dBµV/m	Limit @3m dBµV/m	Margin dB
11490.000	Average	33.46	11.06	44.52	54.00	-9.48
11490.000	Peak	44.10	11.06	55.16	74.00	-18.84
17235.000	Peak	42.23	10.82	53.05	68.20	-15.15

Unless otherwise stated the results shown in this test report refer only to the sample(s) tested and such sample(s) are retained for 90 days only.

除非另有說明，此報告結果僅對測試之樣品負責，同時此樣品僅保留90天。本報告未經本公司書面許可，不可部份複製。

This document is issued by the Company subject to its General Conditions of Service printed overleaf, available on request or accessible at <http://www.sgs.com.tw/Terms-and-Conditions> and for electronic format documents, subject to Terms and Conditions for Electronic Documents at <http://www.sgs.com.tw/Terms-and-Conditions>. Attention is drawn to the limitation of liability, indemnification and jurisdiction issues defined therein. Any holder of this document is advised that information contained hereon reflects the Company's findings at the time of its intervention only and within the limits of Client's instructions, if any. The Company's sole responsibility is to its Client and this document does not exonerate parties to a transaction from exercising all their rights and obligations under the transaction documents. This document cannot be reproduced except in full, without prior written approval of the Company. Any unauthorized alteration, forgery or falsification of the content or appearance of this document is unlawful and offenders may be prosecuted to the fullest extent of the law.

Report Number	:TERF2308001923E2	Test Site	:SAC G Chamber
Operation Mode	:802.11n20	Test Date	:2023-09-25
Test Frequency	:5745 MHz	Temp./Humi.	:23.4°C/56%
Test Mode	:Tx	Antenna Pol.	:Horizontal
EUT Pol	:E2 Plane	Engineer	:Temo Chen

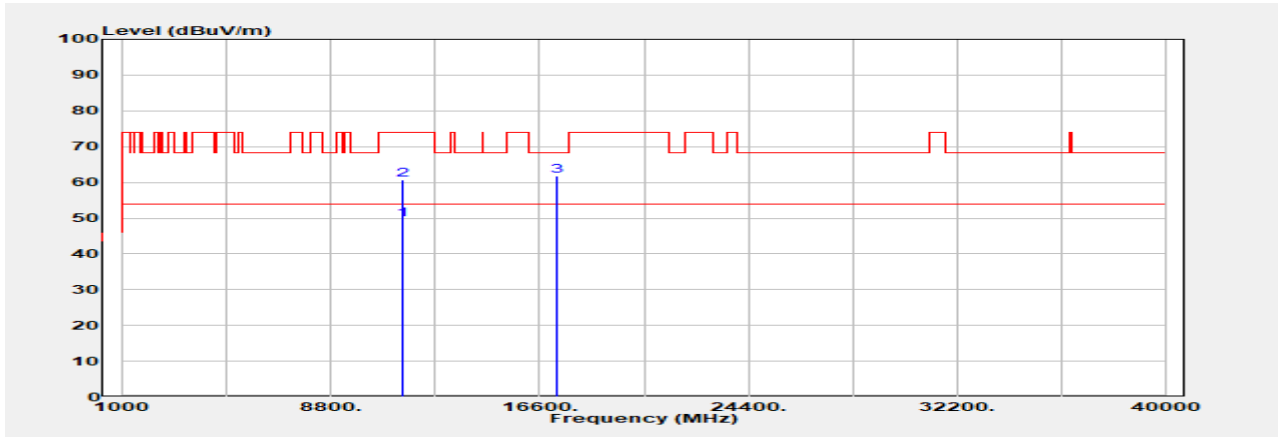

Freq. MHz	Detector Mode PK/QP/AVG	Spectrum Reading Level dBμV	Factor dB	Actual FS dBμV/m	Limit @3m dBμV/m	Margin dB
11490.000	Average	38.47	11.06	49.53	54.00	-4.47
11490.000	Peak	49.57	11.06	60.63	74.00	-13.37
17235.000	Peak	50.86	10.82	61.68	68.20	-6.52

Unless otherwise stated the results shown in this test report refer only to the sample(s) tested and such sample(s) are retained for 90 days only.

除非另有說明，此報告結果僅對測試之樣品負責，同時此樣品僅保留90天。本報告未經本公司書面許可，不可部份複製。

This document is issued by the Company subject to its General Conditions of Service printed overleaf, available on request or accessible at <http://www.sgs.com.tw/Terms-and-Conditions> and for electronic format documents, subject to Terms and Conditions for Electronic Documents at <http://www.sgs.com.tw/Terms-and-Conditions>. Attention is drawn to the limitation of liability, indemnification and jurisdiction issues defined therein. Any holder of this document is advised that information contained hereon reflects the Company's findings at the time of its intervention only and within the limits of Client's instructions, if any. The Company's sole responsibility is to its Client and this document does not exonerate parties to a transaction from exercising all their rights and obligations under the transaction documents. This document cannot be reproduced except in full, without prior written approval of the Company. Any unauthorized alteration, forgery or falsification of the content or appearance of this document is unlawful and offenders may be prosecuted to the fullest extent of the law.

Report Number	:TERF2308001923E2	Test Site	:SAC G Chamber
Operation Mode	:802.11n20	Test Date	:2023-09-25
Test Frequency	:5785 MHz	Temp./Humi.	:23.4°C/56%
Test Mode	:Tx	Antenna Pol.	:Vertical
EUT Pol	:E2 Plane	Engineer	:Temo Chen

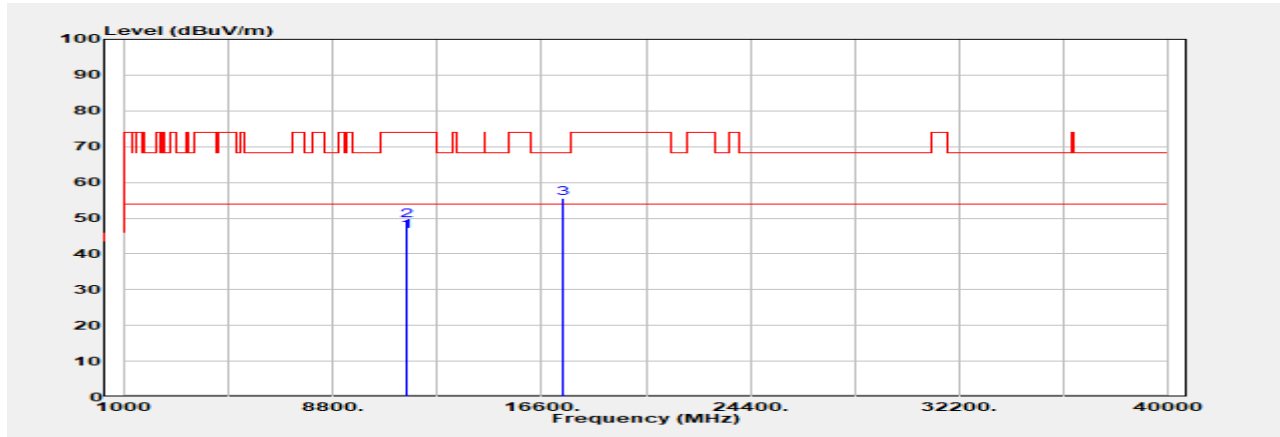

Freq. MHz	Detector Mode PK/QP/AVG	Spectrum Reading Level dB μ V	Factor dB	Actual FS dB μ V/m	Limit @3m dB μ V/m	Margin dB
11570.000	Average	36.08	10.15	46.23	54.00	-7.77
11570.000	Peak	39.30	10.15	49.45	74.00	-24.55
17355.000	Peak	43.65	11.82	55.47	68.20	-12.73

Unless otherwise stated the results shown in this test report refer only to the sample(s) tested and such sample(s) are retained for 90 days only.

除非另有說明，此報告結果僅對測試之樣品負責，同時此樣品僅保留90天。本報告未經本公司書面許可，不可部份複製。

This document is issued by the Company subject to its General Conditions of Service printed overleaf, available on request or accessible at <http://www.sgs.com.tw/Terms-and-Conditions> and for electronic format documents, subject to Terms and Conditions for Electronic Documents at <http://www.sgs.com.tw/Terms-and-Conditions>. Attention is drawn to the limitation of liability, indemnification and jurisdiction issues defined therein. Any holder of this document is advised that information contained hereon reflects the Company's findings at the time of its intervention only and within the limits of Client's instructions, if any. The Company's sole responsibility is to its Client and this document does not exonerate parties to a transaction from exercising all their rights and obligations under the transaction documents. This document cannot be reproduced except in full, without prior written approval of the Company. Any unauthorized alteration, forgery or falsification of the content or appearance of this document is unlawful and offenders may be prosecuted to the fullest extent of the law.

Report Number	:TERF2308001923E2	Test Site	:SAC G Chamber
Operation Mode	:802.11n20	Test Date	:2023-09-25
Test Frequency	:5785 MHz	Temp./Humi.	:23.4°C/56%
Test Mode	:Tx	Antenna Pol.	:Horizontal
EUT Pol	:E2 Plane	Engineer	:Temo Chen

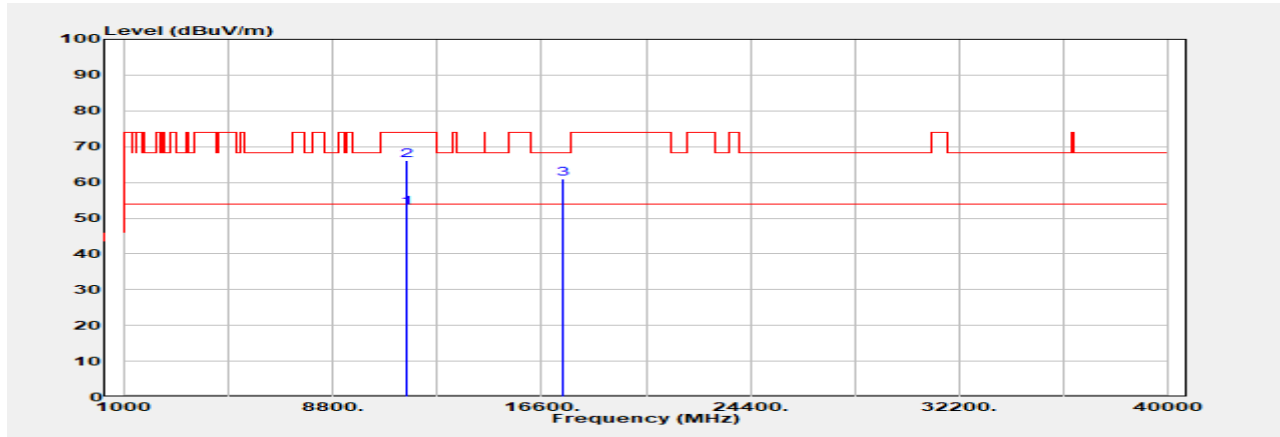

Freq. MHz	Detector Mode PK/QP/AVG	Spectrum Reading Level dBμV	Factor dB	Actual FS dBμV/m	Limit @3m dBμV/m	Margin dB
11570.000	Average	42.72	10.15	52.87	54.00	-1.13
11570.000	Peak	55.98	10.15	66.13	74.00	-7.87
17355.000	Peak	49.09	11.82	60.91	68.20	-7.29

Unless otherwise stated the results shown in this test report refer only to the sample(s) tested and such sample(s) are retained for 90 days only.

除非另有說明，此報告結果僅對測試之樣品負責，同時此樣品僅保留90天。本報告未經本公司書面許可，不可部份複製。

This document is issued by the Company subject to its General Conditions of Service printed overleaf, available on request or accessible at <http://www.sgs.com.tw/Terms-and-Conditions> and for electronic format documents, subject to Terms and Conditions for Electronic Documents at <http://www.sgs.com.tw/Terms-and-Conditions>. Attention is drawn to the limitation of liability, indemnification and jurisdiction issues defined therein. Any holder of this document is advised that information contained hereon reflects the Company's findings at the time of its intervention only and within the limits of Client's instructions, if any. The Company's sole responsibility is to its Client and this document does not exonerate parties to a transaction from exercising all their rights and obligations under the transaction documents. This document cannot be reproduced except in full, without prior written approval of the Company. Any unauthorized alteration, forgery or falsification of the content or appearance of this document is unlawful and offenders may be prosecuted to the fullest extent of the law.

Report Number	:TERF2308001923E2	Test Site	:SAC G Chamber
Operation Mode	:802.11n20	Test Date	:2023-09-25
Test Frequency	:5825 MHz	Temp./Humi.	:23.4°C/56%
Test Mode	:Tx	Antenna Pol.	:Vertical
EUT Pol	:E2 Plane	Engineer	:Temo Chen

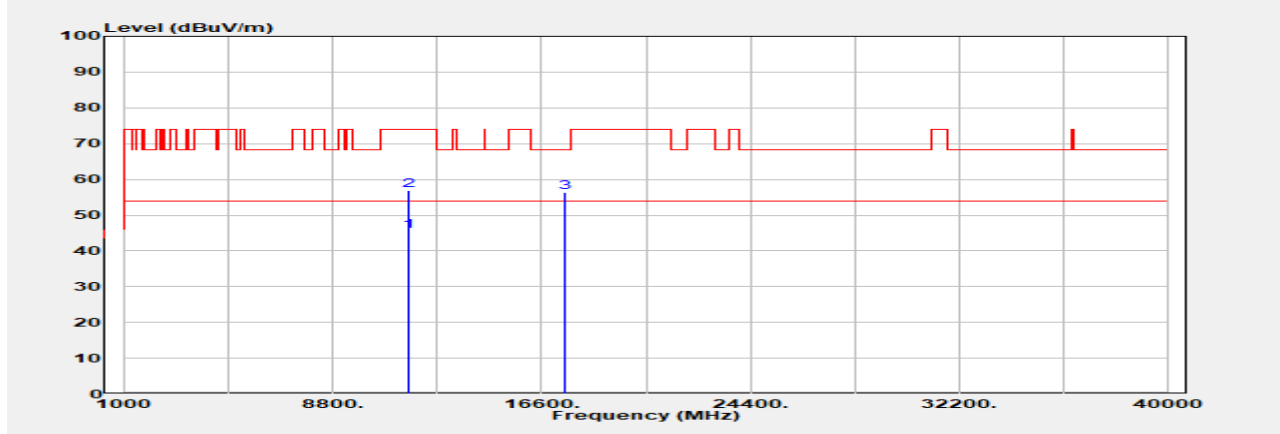

Freq. MHz	Detector Mode PK/QP/AVG	Spectrum Reading Level dB μ V	Factor dB	Actual FS dB μ V/m	Limit @3m dB μ V/m	Margin dB
11650.000	Average	35.49	10.05	45.54	54.00	-8.46
11650.000	Peak	46.97	10.05	57.02	74.00	-16.98
17475.000	Peak	45.35	11.10	56.45	68.20	-11.75

Unless otherwise stated the results shown in this test report refer only to the sample(s) tested and such sample(s) are retained for 90 days only.

除非另有說明，此報告結果僅對測試之樣品負責，同時此樣品僅保留90天。本報告未經本公司書面許可，不可部份複製。

This document is issued by the Company subject to its General Conditions of Service printed overleaf, available on request or accessible at <http://www.sgs.com.tw/Terms-and-Conditions> and for electronic format documents, subject to Terms and Conditions for Electronic Documents at <http://www.sgs.com.tw/Terms-and-Conditions>. Attention is drawn to the limitation of liability, indemnification and jurisdiction issues defined therein. Any holder of this document is advised that information contained hereon reflects the Company's findings at the time of its intervention only and within the limits of Client's instructions, if any. The Company's sole responsibility is to its Client and this document does not exonerate parties to a transaction from exercising all their rights and obligations under the transaction documents. This document cannot be reproduced except in full, without prior written approval of the Company. Any unauthorized alteration, forgery or falsification of the content or appearance of this document is unlawful and offenders may be prosecuted to the fullest extent of the law.

Report Number	:TERF2308001923E2	Test Site	:SAC G Chamber
Operation Mode	:802.11n20	Test Date	:2023-09-25
Test Frequency	:5825 MHz	Temp./Humi.	:23.4°C/56%
Test Mode	:Tx	Antenna Pol.	:Horizontal
EUT Pol	:E2 Plane	Engineer	:Temo Chen

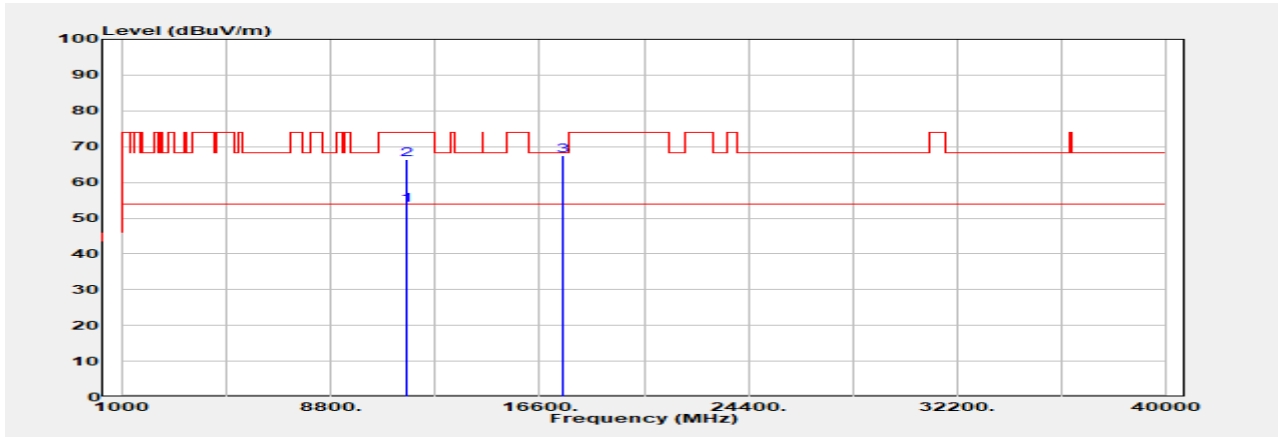

Freq. MHz	Detector Mode PK/QP/AVG	Spectrum Reading Level dBµV	Factor dB	Actual FS dBµV/m	Limit @3m dBµV/m	Margin dB
11650.000	Average	43.67	10.05	53.72	54.00	-0.28
11650.000	Peak	56.37	10.05	66.42	74.00	-7.58
17475.000	Peak	56.48	11.10	67.58	68.20	-0.62

Unless otherwise stated the results shown in this test report refer only to the sample(s) tested and such sample(s) are retained for 90 days only.

除非另有說明，此報告結果僅對測試之樣品負責，同時此樣品僅保留90天。本報告未經本公司書面許可，不可部份複製。

This document is issued by the Company subject to its General Conditions of Service printed overleaf, available on request or accessible at <http://www.sgs.com.tw/Terms-and-Conditions> and for electronic format documents, subject to Terms and Conditions for Electronic Documents at <http://www.sgs.com.tw/Terms-and-Conditions>. Attention is drawn to the limitation of liability, indemnification and jurisdiction issues defined therein. Any holder of this document is advised that information contained hereon reflects the Company's findings at the time of its intervention only and within the limits of Client's instructions, if any. The Company's sole responsibility is to its Client and this document does not exonerate parties to a transaction from exercising all their rights and obligations under the transaction documents. This document cannot be reproduced except in full, without prior written approval of the Company. Any unauthorized alteration, forgery or falsification of the content or appearance of this document is unlawful and offenders may be prosecuted to the fullest extent of the law.

Report Number	:TERF2308001923E2	Test Site	:SAC G Chamber
Operation Mode	:802.11n40	Test Date	:2023-09-25
Test Frequency	:5190 MHz	Temp./Humi.	:23.4°C/56%
Test Mode	:Tx	Antenna Pol.	:Vertical
EUT Pol	:E2 Plane	Engineer	:Temo Chen

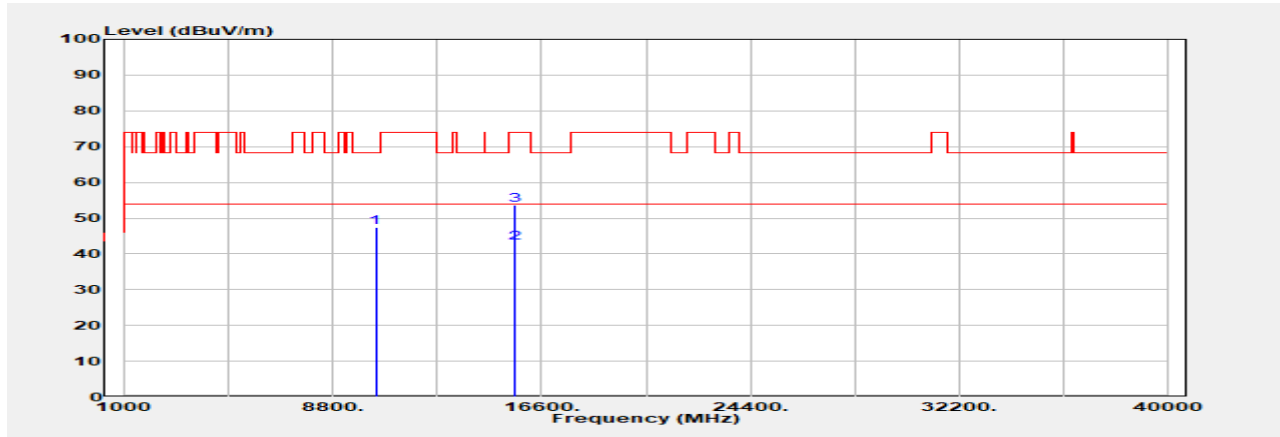

Freq. MHz	Detector Mode PK/QP/AVG	Spectrum Reading Level dB μ V	Factor dB	Actual FS dB μ V/m	Limit @3m dB μ V/m	Margin dB
10380.000	Peak	37.93	9.44	47.37	68.20	-20.83
15570.000	Average	31.19	11.93	43.12	54.00	-10.88
15570.000	Peak	41.63	11.93	53.56	74.00	-20.44

Unless otherwise stated the results shown in this test report refer only to the sample(s) tested and such sample(s) are retained for 90 days only.

除非另有說明，此報告結果僅對測試之樣品負責，同時此樣品僅保留90天。本報告未經本公司書面許可，不可部份複製。

This document is issued by the Company subject to its General Conditions of Service printed overleaf, available on request or accessible at <http://www.sgs.com.tw/Terms-and-Conditions> and for electronic format documents, subject to Terms and Conditions for Electronic Documents at <http://www.sgs.com.tw/Terms-and-Conditions>. Attention is drawn to the limitation of liability, indemnification and jurisdiction issues defined therein. Any holder of this document is advised that information contained hereon reflects the Company's findings at the time of its intervention only and within the limits of Client's instructions, if any. The Company's sole responsibility is to its Client and this document does not exonerate parties to a transaction from exercising all their rights and obligations under the transaction documents. This document cannot be reproduced except in full, without prior written approval of the Company. Any unauthorized alteration, forgery or falsification of the content or appearance of this document is unlawful and offenders may be prosecuted to the fullest extent of the law.

Report Number	:TERF2308001923E2	Test Site	:SAC G Chamber
Operation Mode	:802.11n40	Test Date	:2023-09-25
Test Frequency	:5190 MHz	Temp./Humi.	:23.4°C/56%
Test Mode	:Tx	Antenna Pol.	:Horizontal
EUT Pol	:E2 Plane	Engineer	:Temo Chen

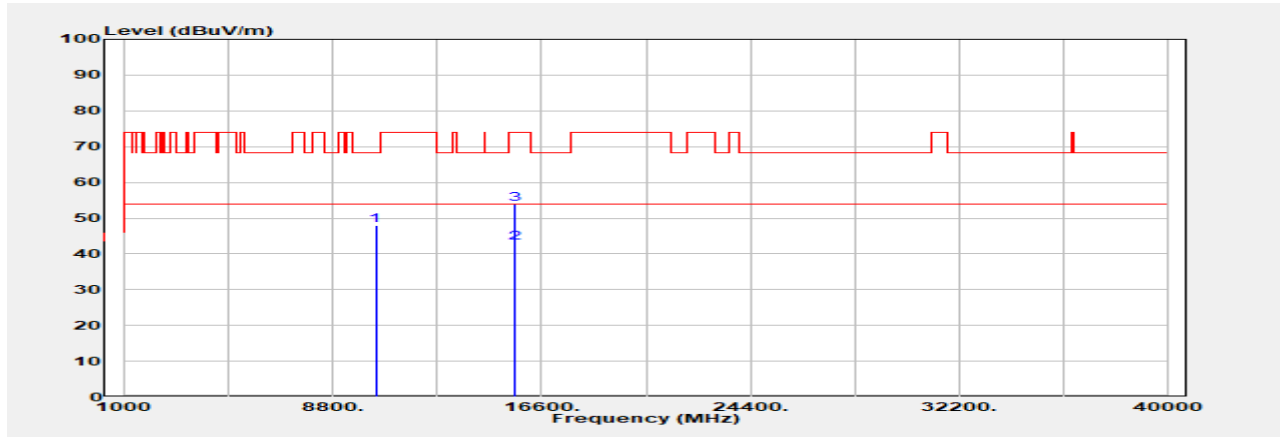

Freq. MHz	Detector Mode PK/QP/AVG	Spectrum Reading Level dB μ V	Factor dB	Actual FS dB μ V/m	Limit @3m dB μ V/m	Margin dB
10380.000	Peak	38.62	9.44	48.06	68.20	-20.14
15570.000	Average	31.18	11.93	43.11	54.00	-10.89
15570.000	Peak	41.87	11.93	53.80	74.00	-20.20

Unless otherwise stated the results shown in this test report refer only to the sample(s) tested and such sample(s) are retained for 90 days only.

除非另有說明，此報告結果僅對測試之樣品負責，同時此樣品僅保留90天。本報告未經本公司書面許可，不可部份複製。

This document is issued by the Company subject to its General Conditions of Service printed overleaf, available on request or accessible at <http://www.sgs.com.tw/Terms-and-Conditions> and for electronic format documents, subject to Terms and Conditions for Electronic Documents at <http://www.sgs.com.tw/Terms-and-Conditions>. Attention is drawn to the limitation of liability, indemnification and jurisdiction issues defined therein. Any holder of this document is advised that information contained hereon reflects the Company's findings at the time of its intervention only and within the limits of Client's instructions, if any. The Company's sole responsibility is to its Client and this document does not exonerate parties to a transaction from exercising all their rights and obligations under the transaction documents. This document cannot be reproduced except in full, without prior written approval of the Company. Any unauthorized alteration, forgery or falsification of the content or appearance of this document is unlawful and offenders may be prosecuted to the fullest extent of the law.

Report Number	:TERF2308001923E2	Test Site	:SAC G Chamber
Operation Mode	:802.11n40	Test Date	:2023-09-25
Test Frequency	:5230 MHz	Temp./Humi.	:23.4°C/56%
Test Mode	:Tx	Antenna Pol.	:Vertical
EUT Pol	:E2 Plane	Engineer	:Temo Chen

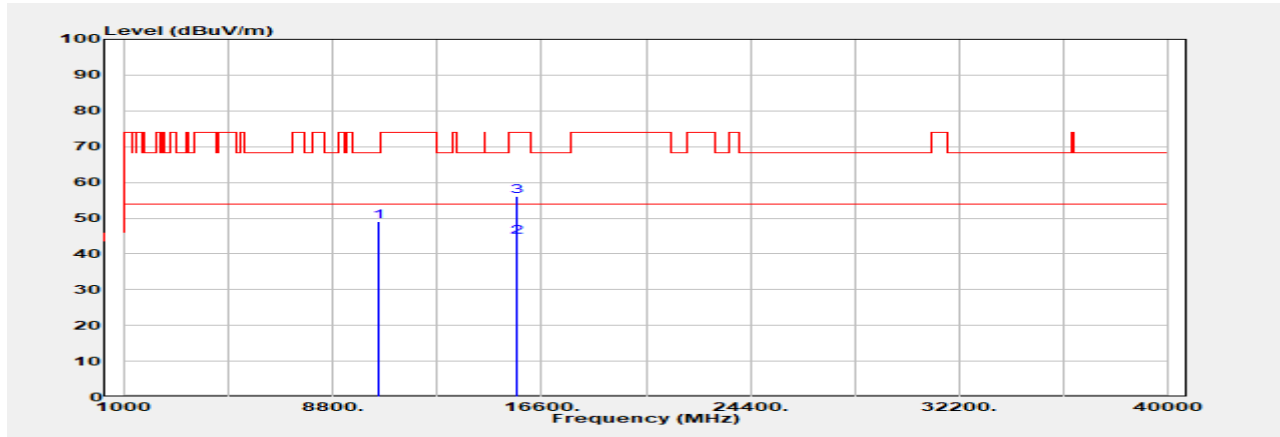

Freq. MHz	Detector Mode PK/QP/AVG	Spectrum Reading Level dB μ V	Factor dB	Actual FS dB μ V/m	Limit @3m dB μ V/m	Margin dB
10460.000	Peak	39.22	9.74	48.96	68.20	-19.24
15690.000	Average	32.09	12.53	44.62	54.00	-9.38
15690.000	Peak	43.53	12.53	56.06	74.00	-17.94

Unless otherwise stated the results shown in this test report refer only to the sample(s) tested and such sample(s) are retained for 90 days only.

除非另有說明，此報告結果僅對測試之樣品負責，同時此樣品僅保留90天。本報告未經本公司書面許可，不可部份複製。

This document is issued by the Company subject to its General Conditions of Service printed overleaf, available on request or accessible at <http://www.sgs.com.tw/Terms-and-Conditions> and for electronic format documents, subject to Terms and Conditions for Electronic Documents at <http://www.sgs.com.tw/Terms-and-Conditions>. Attention is drawn to the limitation of liability, indemnification and jurisdiction issues defined therein. Any holder of this document is advised that information contained hereon reflects the Company's findings at the time of its intervention only and within the limits of Client's instructions, if any. The Company's sole responsibility is to its Client and this document does not exonerate parties to a transaction from exercising all their rights and obligations under the transaction documents. This document cannot be reproduced except in full, without prior written approval of the Company. Any unauthorized alteration, forgery or falsification of the content or appearance of this document is unlawful and offenders may be prosecuted to the fullest extent of the law.

Report Number	:TERF2308001923E2	Test Site	:SAC G Chamber
Operation Mode	:802.11n40	Test Date	:2023-09-25
Test Frequency	:5230 MHz	Temp./Humi.	:23.4°C/56%
Test Mode	:Tx	Antenna Pol.	:Horizontal
EUT Pol	:E2 Plane	Engineer	:Temo Chen

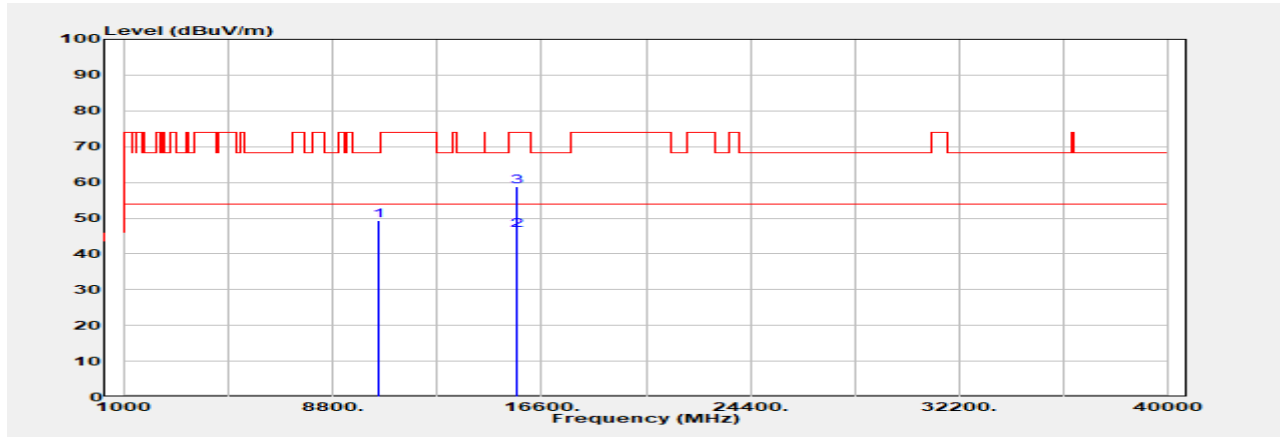

Freq. MHz	Detector Mode PK/QP/AVG	Spectrum Reading Level dB μ V	Factor dB	Actual FS dB μ V/m	Limit @3m dB μ V/m	Margin dB
10460.000	Peak	39.61	9.74	49.35	68.20	-18.85
15690.000	Average	34.14	12.53	46.67	54.00	-7.33
15690.000	Peak	46.33	12.53	58.86	74.00	-15.14

Unless otherwise stated the results shown in this test report refer only to the sample(s) tested and such sample(s) are retained for 90 days only.

除非另有說明，此報告結果僅對測試之樣品負責，同時此樣品僅保留90天。本報告未經本公司書面許可，不可部份複製。

This document is issued by the Company subject to its General Conditions of Service printed overleaf, available on request or accessible at <http://www.sgs.com.tw/Terms-and-Conditions> and for electronic format documents, subject to Terms and Conditions for Electronic Documents at <http://www.sgs.com.tw/Terms-and-Conditions>. Attention is drawn to the limitation of liability, indemnification and jurisdiction issues defined therein. Any holder of this document is advised that information contained hereon reflects the Company's findings at the time of its intervention only and within the limits of Client's instructions, if any. The Company's sole responsibility is to its Client and this document does not exonerate parties to a transaction from exercising all their rights and obligations under the transaction documents. This document cannot be reproduced except in full, without prior written approval of the Company. Any unauthorized alteration, forgery or falsification of the content or appearance of this document is unlawful and offenders may be prosecuted to the fullest extent of the law.

Report Number	:TERF2308001923E2	Test Site	:SAC G Chamber
Operation Mode	:802.11n40	Test Date	:2023-09-25
Test Frequency	:5270 MHz	Temp./Humi.	:23.4°C/56%
Test Mode	:Tx	Antenna Pol.	:Vertical
EUT Pol	:E2 Plane	Engineer	:Temo Chen

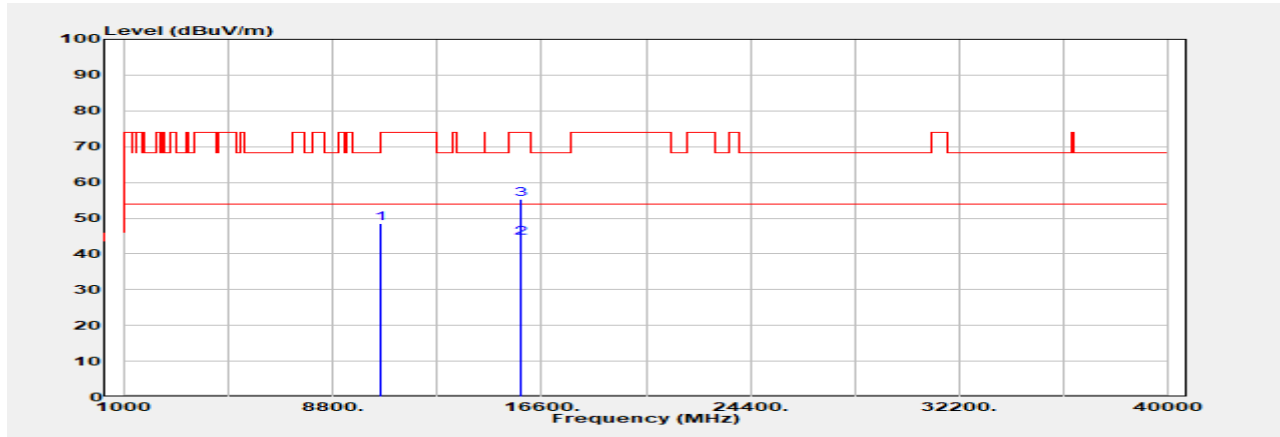

Freq. MHz	Detector Mode PK/QP/AVG	Spectrum Reading Level dBµV	Factor dB	Actual FS dBµV/m	Limit @3m dBµV/m	Margin dB
10540.000	Peak	38.47	9.94	48.41	68.20	-19.79
15810.000	Average	32.12	12.38	44.50	54.00	-9.50
15810.000	Peak	42.82	12.38	55.20	74.00	-18.80

Unless otherwise stated the results shown in this test report refer only to the sample(s) tested and such sample(s) are retained for 90 days only.

除非另有說明，此報告結果僅對測試之樣品負責，同時此樣品僅保留90天。本報告未經本公司書面許可，不可部份複製。

This document is issued by the Company subject to its General Conditions of Service printed overleaf, available on request or accessible at <http://www.sgs.com.tw/Terms-and-Conditions> and for electronic format documents, subject to Terms and Conditions for Electronic Documents at <http://www.sgs.com.tw/Terms-and-Conditions>. Attention is drawn to the limitation of liability, indemnification and jurisdiction issues defined therein. Any holder of this document is advised that information contained hereon reflects the Company's findings at the time of its intervention only and within the limits of Client's instructions, if any. The Company's sole responsibility is to its Client and this document does not exonerate parties to a transaction from exercising all their rights and obligations under the transaction documents. This document cannot be reproduced except in full, without prior written approval of the Company. Any unauthorized alteration, forgery or falsification of the content or appearance of this document is unlawful and offenders may be prosecuted to the fullest extent of the law.

Report Number	:TERF2308001923E2	Test Site	:SAC G Chamber
Operation Mode	:802.11n40	Test Date	:2023-09-25
Test Frequency	:5270 MHz	Temp./Humi.	:23.4°C/56%
Test Mode	:Tx	Antenna Pol.	:Horizontal
EUT Pol	:E2 Plane	Engineer	:Temo Chen

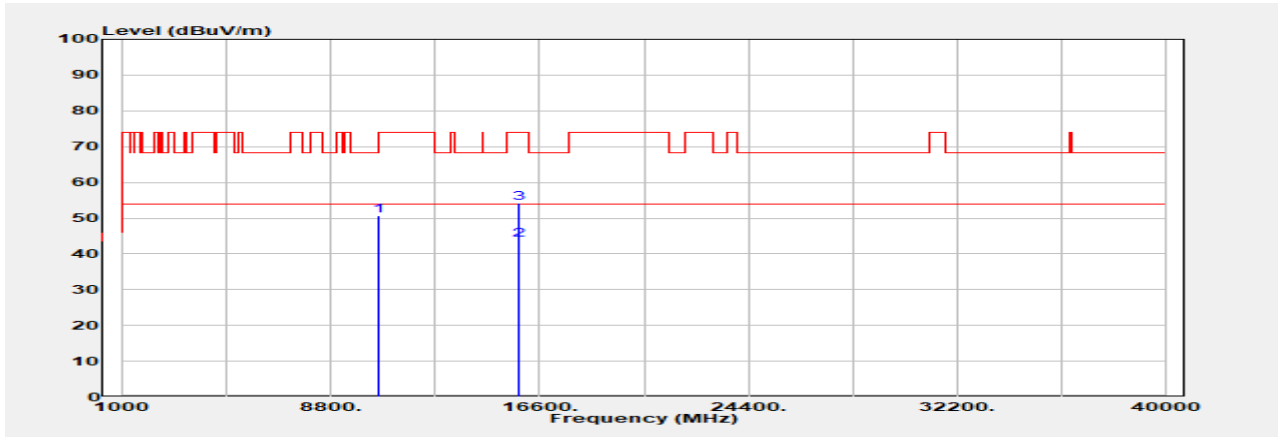

Freq. MHz	Detector Mode PK/QP/AVG	Spectrum Reading Level dB μ V	Factor dB	Actual FS dB μ V/m	Limit @3m dB μ V/m	Margin dB
10540.000	Peak	40.85	9.94	50.79	68.20	-17.41
15810.000	Average	31.58	12.38	43.96	54.00	-10.04
15810.000	Peak	41.89	12.38	54.27	74.00	-19.73

Unless otherwise stated the results shown in this test report refer only to the sample(s) tested and such sample(s) are retained for 90 days only.

除非另有說明，此報告結果僅對測試之樣品負責，同時此樣品僅保留90天。本報告未經本公司書面許可，不可部份複製。

This document is issued by the Company subject to its General Conditions of Service printed overleaf, available on request or accessible at <http://www.sgs.com.tw/Terms-and-Conditions> and for electronic format documents, subject to Terms and Conditions for Electronic Documents at <http://www.sgs.com.tw/Terms-and-Conditions>. Attention is drawn to the limitation of liability, indemnification and jurisdiction issues defined therein. Any holder of this document is advised that information contained hereon reflects the Company's findings at the time of its intervention only and within the limits of Client's instructions, if any. The Company's sole responsibility is to its Client and this document does not exonerate parties to a transaction from exercising all their rights and obligations under the transaction documents. This document cannot be reproduced except in full, without prior written approval of the Company. Any unauthorized alteration, forgery or falsification of the content or appearance of this document is unlawful and offenders may be prosecuted to the fullest extent of the law.

Report Number	:TERF2308001923E2	Test Site	:SAC G Chamber
Operation Mode	:802.11n40	Test Date	:2023-09-25
Test Frequency	:5310 MHz	Temp./Humi.	:23.4°C/56%
Test Mode	:Tx	Antenna Pol.	:Vertical
EUT Pol	:E2 Plane	Engineer	:Temo Chen

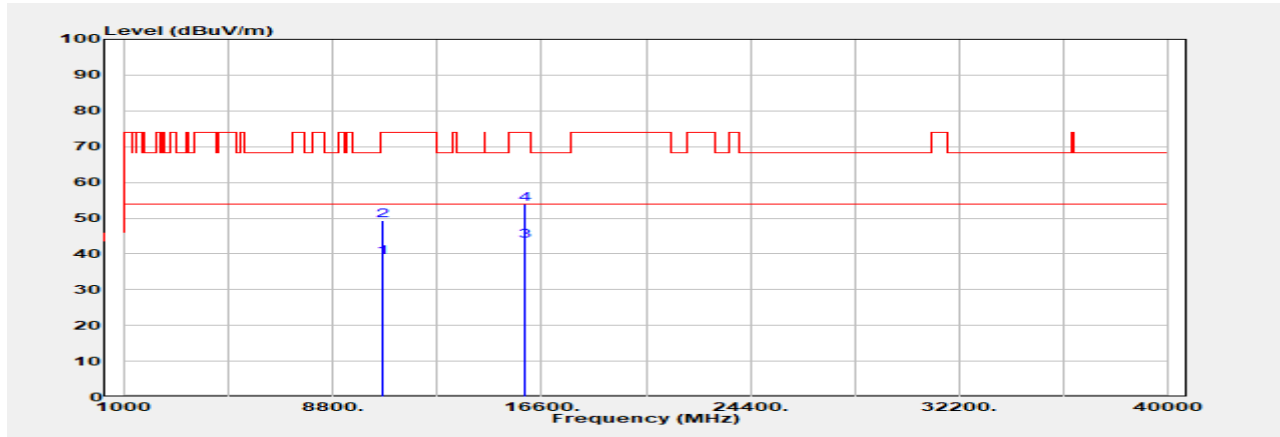

Freq. MHz	Detector Mode PK/QP/AVG	Spectrum Reading Level dB μ V	Factor dB	Actual FS dB μ V/m	Limit @3m dB μ V/m	Margin dB
10620.000	Average	29.20	9.86	39.06	54.00	-14.94
10620.000	Peak	39.37	9.86	49.23	74.00	-24.77
15930.000	Average	31.70	12.05	43.75	54.00	-10.25
15930.000	Peak	42.01	12.05	54.06	74.00	-19.94

Unless otherwise stated the results shown in this test report refer only to the sample(s) tested and such sample(s) are retained for 90 days only.

除非另有說明，此報告結果僅對測試之樣品負責，同時此樣品僅保留90天。本報告未經本公司書面許可，不可部份複製。

This document is issued by the Company subject to its General Conditions of Service printed overleaf, available on request or accessible at <http://www.sgs.com.tw/Terms-and-Conditions> and for electronic format documents, subject to Terms and Conditions for Electronic Documents at <http://www.sgs.com.tw/Terms-and-Conditions>. Attention is drawn to the limitation of liability, indemnification and jurisdiction issues defined therein. Any holder of this document is advised that information contained hereon reflects the Company's findings at the time of its intervention only and within the limits of Client's instructions, if any. The Company's sole responsibility is to its Client and this document does not exonerate parties to a transaction from exercising all their rights and obligations under the transaction documents. This document cannot be reproduced except in full, without prior written approval of the Company. Any unauthorized alteration, forgery or falsification of the content or appearance of this document is unlawful and offenders may be prosecuted to the fullest extent of the law.

Report Number	:TERF2308001923E2	Test Site	:SAC G Chamber
Operation Mode	:802.11n40	Test Date	:2023-09-25
Test Frequency	:5310 MHz	Temp./Humi.	:23.4°C/56%
Test Mode	:Tx	Antenna Pol.	:Horizontal
EUT Pol	:E2 Plane	Engineer	:Temo Chen

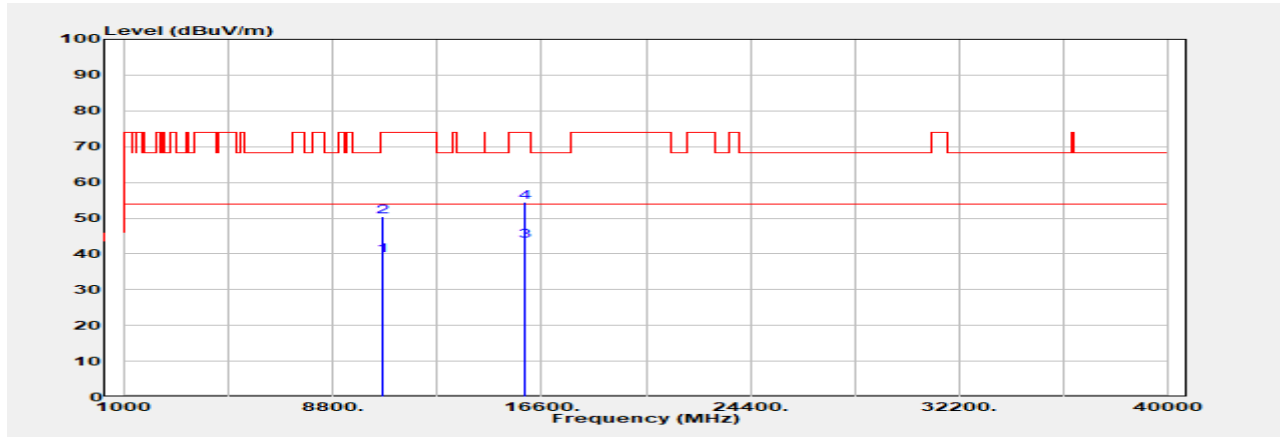

Freq. MHz	Detector Mode	Spectrum Reading Level dB μ V	Factor dB	Actual FS dB μ V/m	Limit @3m dB μ V/m	Margin dB
10620.000	Average	29.59	9.86	39.45	54.00	-14.55
10620.000	Peak	40.65	9.86	50.51	74.00	-23.49
15930.000	Average	31.66	12.05	43.71	54.00	-10.29
15930.000	Peak	42.29	12.05	54.34	74.00	-19.66

Unless otherwise stated the results shown in this test report refer only to the sample(s) tested and such sample(s) are retained for 90 days only.

除非另有說明，此報告結果僅對測試之樣品負責，同時此樣品僅保留90天。本報告未經本公司書面許可，不可部份複製。

This document is issued by the Company subject to its General Conditions of Service printed overleaf, available on request or accessible at <http://www.sgs.com.tw/Terms-and-Conditions> and for electronic format documents, subject to Terms and Conditions for Electronic Documents at <http://www.sgs.com.tw/Terms-and-Conditions>. Attention is drawn to the limitation of liability, indemnification and jurisdiction issues defined therein. Any holder of this document is advised that information contained hereon reflects the Company's findings at the time of its intervention only and within the limits of Client's instructions, if any. The Company's sole responsibility is to its Client and this document does not exonerate parties to a transaction from exercising all their rights and obligations under the transaction documents. This document cannot be reproduced except in full, without prior written approval of the Company. Any unauthorized alteration, forgery or falsification of the content or appearance of this document is unlawful and offenders may be prosecuted to the fullest extent of the law.

Report Number	:TERF2308001923E2	Test Site	:SAC G Chamber
Operation Mode	:802.11n40	Test Date	:2023-09-25
Test Frequency	:5510 MHz	Temp./Humi.	:23.4°C/56%
Test Mode	:Tx	Antenna Pol.	:Vertical
EUT Pol	:E2 Plane	Engineer	:Temo Chen

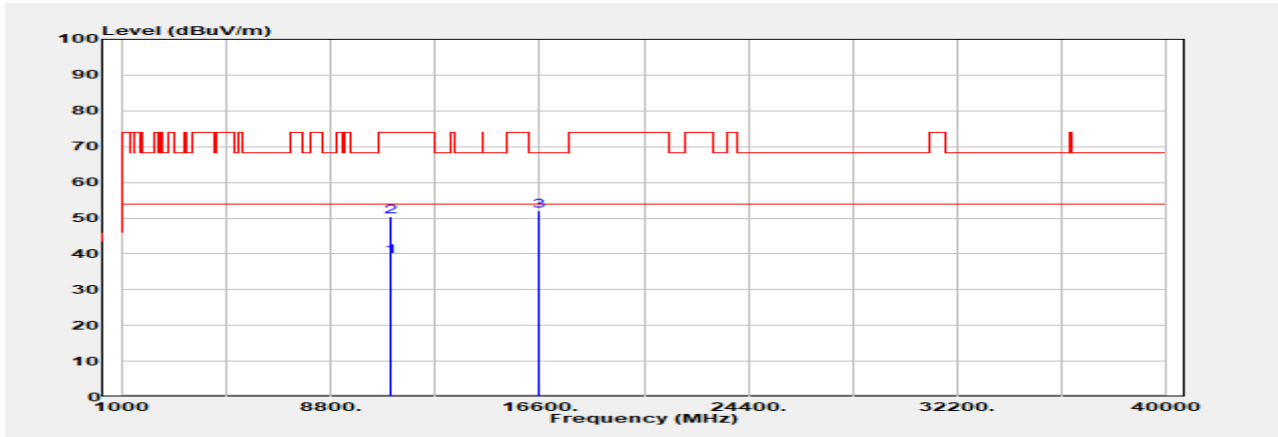

Freq. MHz	Detector Mode PK/QP/AVG	Spectrum Reading Level dBµV	Factor dB	Actual FS dBµV/m	Limit @3m dBµV/m	Margin dB
11020.000	Average	27.82	11.46	39.28	54.00	-14.72
11020.000	Peak	38.96	11.46	50.42	74.00	-23.58
16530.000	Peak	40.08	11.94	52.02	68.20	-16.18

Unless otherwise stated the results shown in this test report refer only to the sample(s) tested and such sample(s) are retained for 90 days only.

除非另有說明，此報告結果僅對測試之樣品負責，同時此樣品僅保留90天。本報告未經本公司書面許可，不可部份複製。

This document is issued by the Company subject to its General Conditions of Service printed overleaf, available on request or accessible at <http://www.sgs.com.tw/Terms-and-Conditions> and for electronic format documents, subject to Terms and Conditions for Electronic Documents at <http://www.sgs.com.tw/Terms-and-Conditions>. Attention is drawn to the limitation of liability, indemnification and jurisdiction issues defined therein. Any holder of this document is advised that information contained hereon reflects the Company's findings at the time of its intervention only and within the limits of Client's instructions, if any. The Company's sole responsibility is to its Client and this document does not exonerate parties to a transaction from exercising all their rights and obligations under the transaction documents. This document cannot be reproduced except in full, without prior written approval of the Company. Any unauthorized alteration, forgery or falsification of the content or appearance of this document is unlawful and offenders may be prosecuted to the fullest extent of the law.

Report Number	:TERF2308001923E2	Test Site	:SAC G Chamber
Operation Mode	:802.11n40	Test Date	:2023-09-25
Test Frequency	:5510 MHz	Temp./Humi.	:23.4°C/56%
Test Mode	:Tx	Antenna Pol.	:Horizontal
EUT Pol	:E2 Plane	Engineer	:Temo Chen

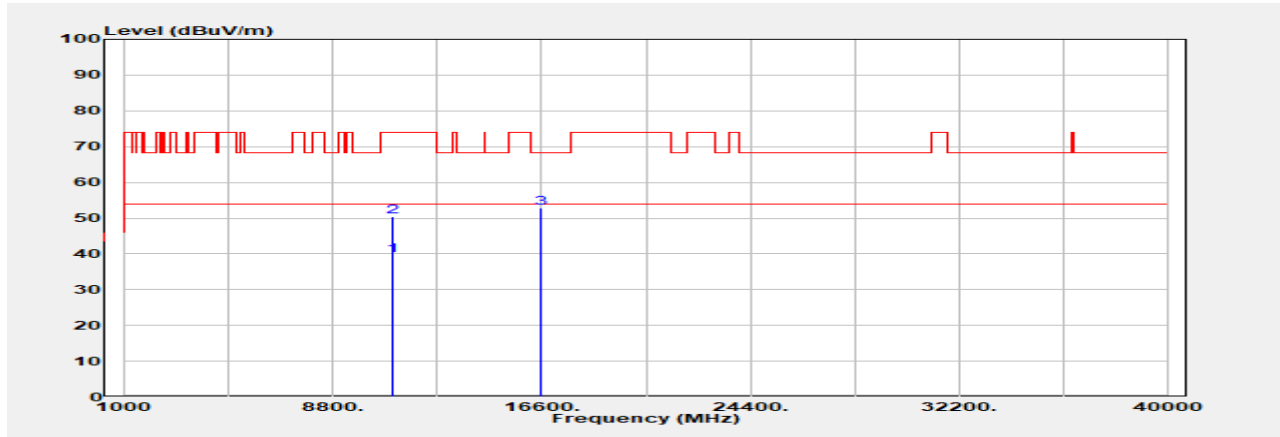

Freq. MHz	Detector Mode PK/QP/AVG	Spectrum Reading Level dB μ V	Factor dB	Actual FS dB μ V/m	Limit @3m dB μ V/m	Margin dB
11020.000	Average	28.17	11.46	39.63	54.00	-14.37
11020.000	Peak	38.87	11.46	50.33	74.00	-23.67
16530.000	Peak	40.81	11.94	52.75	68.20	-15.45

Unless otherwise stated the results shown in this test report refer only to the sample(s) tested and such sample(s) are retained for 90 days only.

除非另有說明，此報告結果僅對測試之樣品負責，同時此樣品僅保留90天。本報告未經本公司書面許可，不可部份複製。

This document is issued by the Company subject to its General Conditions of Service printed overleaf, available on request or accessible at <http://www.sgs.com.tw/Terms-and-Conditions> and for electronic format documents, subject to Terms and Conditions for Electronic Documents at <http://www.sgs.com.tw/Terms-and-Conditions>. Attention is drawn to the limitation of liability, indemnification and jurisdiction issues defined therein. Any holder of this document is advised that information contained hereon reflects the Company's findings at the time of its intervention only and within the limits of Client's instructions, if any. The Company's sole responsibility is to its Client and this document does not exonerate parties to a transaction from exercising all their rights and obligations under the transaction documents. This document cannot be reproduced except in full, without prior written approval of the Company. Any unauthorized alteration, forgery or falsification of the content or appearance of this document is unlawful and offenders may be prosecuted to the fullest extent of the law.

Report Number	:TERF2308001923E2	Test Site	:SAC G Chamber
Operation Mode	:802.11n40	Test Date	:2023-09-25
Test Frequency	:5550 MHz	Temp./Humi.	:23.4°C/56%
Test Mode	:Tx	Antenna Pol.	:Vertical
EUT Pol	:E2 Plane	Engineer	:Temo Chen

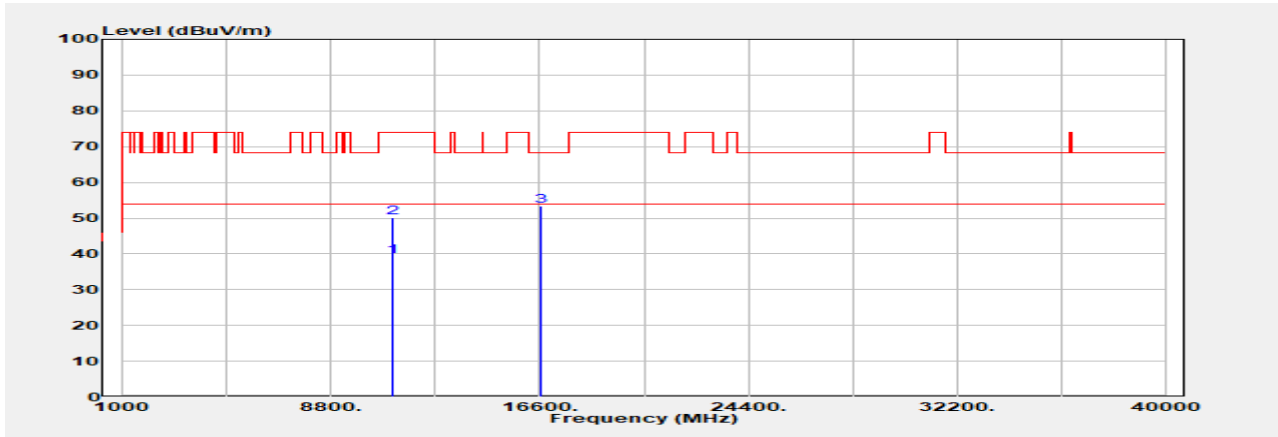

Freq. MHz	Detector Mode	Spectrum Reading Level dBμV	Factor dB	Actual FS dBμV/m	Limit @3m dBμV/m	Margin dB
11100.000	Average	29.64	9.70	39.34	54.00	-14.66
11100.000	Peak	40.57	9.70	50.27	74.00	-23.73
16650.000	Peak	41.53	11.75	53.28	68.20	-14.92

Unless otherwise stated the results shown in this test report refer only to the sample(s) tested and such sample(s) are retained for 90 days only.

除非另有說明，此報告結果僅對測試之樣品負責，同時此樣品僅保留90天。本報告未經本公司書面許可，不可部份複製。

This document is issued by the Company subject to its General Conditions of Service printed overleaf, available on request or accessible at <http://www.sgs.com.tw/Terms-and-Conditions> and for electronic format documents, subject to Terms and Conditions for Electronic Documents at <http://www.sgs.com.tw/Terms-and-Conditions>. Attention is drawn to the limitation of liability, indemnification and jurisdiction issues defined therein. Any holder of this document is advised that information contained hereon reflects the Company's findings at the time of its intervention only and within the limits of Client's instructions, if any. The Company's sole responsibility is to its Client and this document does not exonerate parties to a transaction from exercising all their rights and obligations under the transaction documents. This document cannot be reproduced except in full, without prior written approval of the Company. Any unauthorized alteration, forgery or falsification of the content or appearance of this document is unlawful and offenders may be prosecuted to the fullest extent of the law.

Report Number	:TERF2308001923E2	Test Site	:SAC G Chamber
Operation Mode	:802.11n40	Test Date	:2023-09-25
Test Frequency	:5550 MHz	Temp./Humi.	:23.4°C/56%
Test Mode	:Tx	Antenna Pol.	:Horizontal
EUT Pol	:E2 Plane	Engineer	:Temo Chen

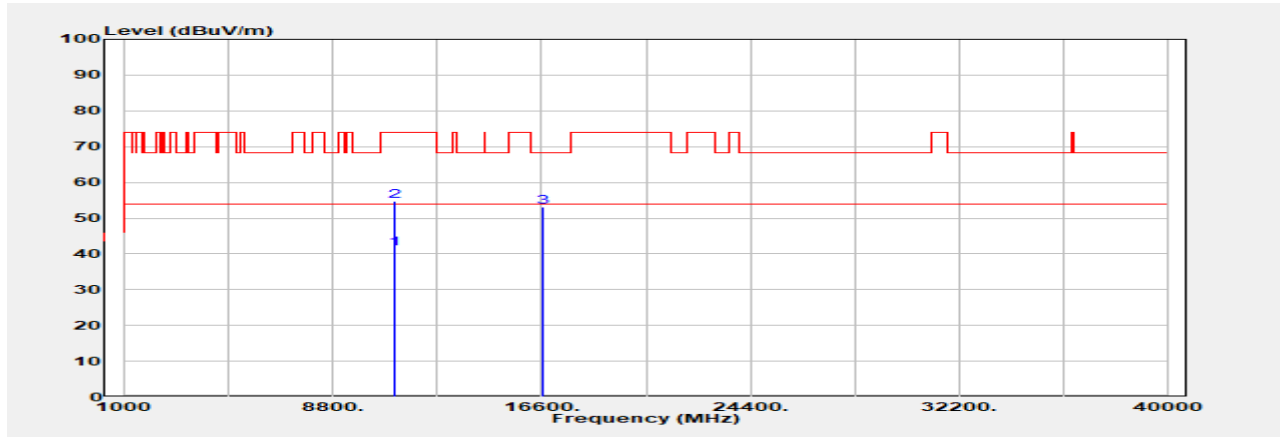

Freq. MHz	Detector Mode PK/QP/AVG	Spectrum Reading Level dBµV	Factor dB	Actual FS dBµV/m	Limit @3m dBµV/m	Margin dB
11100.000	Average	31.67	9.70	41.37	54.00	-12.63
11100.000	Peak	45.00	9.70	54.70	74.00	-19.30
16650.000	Peak	41.42	11.75	53.17	68.20	-15.03

Unless otherwise stated the results shown in this test report refer only to the sample(s) tested and such sample(s) are retained for 90 days only.

除非另有說明，此報告結果僅對測試之樣品負責，同時此樣品僅保留90天。本報告未經本公司書面許可，不可部份複製。

This document is issued by the Company subject to its General Conditions of Service printed overleaf, available on request or accessible at <http://www.sgs.com.tw/Terms-and-Conditions> and for electronic format documents, subject to Terms and Conditions for Electronic Documents at <http://www.sgs.com.tw/Terms-and-Conditions>. Attention is drawn to the limitation of liability, indemnification and jurisdiction issues defined therein. Any holder of this document is advised that information contained hereon reflects the Company's findings at the time of its intervention only and within the limits of Client's instructions, if any. The Company's sole responsibility is to its Client and this document does not exonerate parties to a transaction from exercising all their rights and obligations under the transaction documents. This document cannot be reproduced except in full, without prior written approval of the Company. Any unauthorized alteration, forgery or falsification of the content or appearance of this document is unlawful and offenders may be prosecuted to the fullest extent of the law.

Report Number :TERF2308001923E2
 Operation Mode :802.11n40
 Test Frequency :5670 MHz
 Test Mode :Tx
 EUT Pol :E2 Plane

Test Site :SAC G Chamber
 Test Date :2023-09-25
 Temp./Humi. :23.4°C/56%
 Antenna Pol. :Vertical
 Engineer :Temo Chen

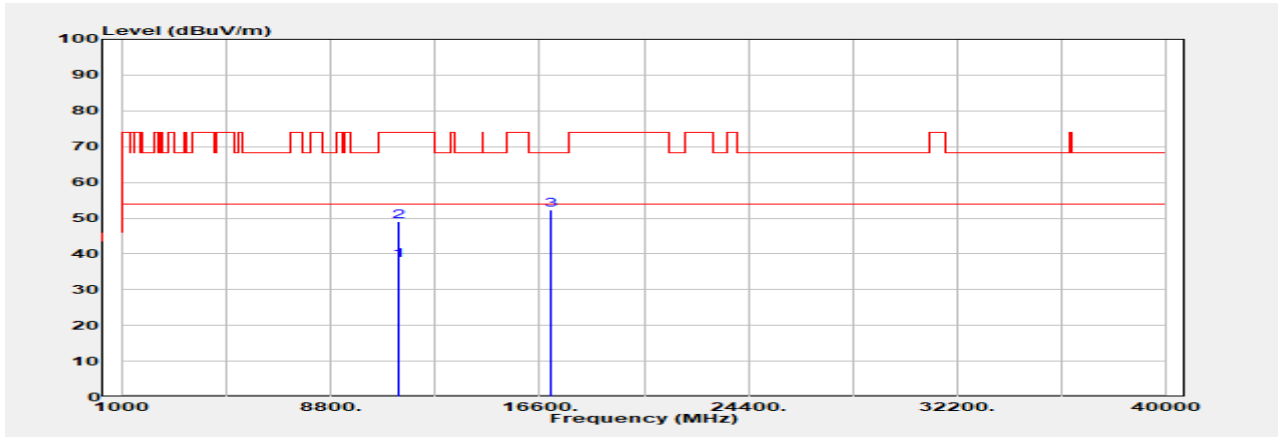

Freq. MHz	Detector Mode PK/QP/AVG	Spectrum Reading Level dBμV	Factor dB	Actual FS dBμV/m	Limit @3m dBμV/m	Margin dB
11340.000	Average	28.60	9.74	38.34	54.00	-15.66
11340.000	Peak	39.26	9.74	49.00	74.00	-25.00
17010.000	Peak	40.51	11.84	52.35	68.20	-15.85

Unless otherwise stated the results shown in this test report refer only to the sample(s) tested and such sample(s) are retained for 90 days only.

除非另有說明，此報告結果僅對測試之樣品負責，同時此樣品僅保留90天。本報告未經本公司書面許可，不可部份複製。

This document is issued by the Company subject to its General Conditions of Service printed overleaf, available on request or accessible at <http://www.sgs.com.tw/Terms-and-Conditions> and for electronic format documents, subject to Terms and Conditions for Electronic Documents at <http://www.sgs.com.tw/Terms-and-Conditions>. Attention is drawn to the limitation of liability, indemnification and jurisdiction issues defined therein. Any holder of this document is advised that information contained hereon reflects the Company's findings at the time of its intervention only and within the limits of Client's instructions, if any. The Company's sole responsibility is to its Client and this document does not exonerate parties to a transaction from exercising all their rights and obligations under the transaction documents. This document cannot be reproduced except in full, without prior written approval of the Company. Any unauthorized alteration, forgery or falsification of the content or appearance of this document is unlawful and offenders may be prosecuted to the fullest extent of the law.

Report Number	:TERF2308001923E2	Test Site	:SAC G Chamber
Operation Mode	:802.11n40	Test Date	:2023-09-25
Test Frequency	:5670 MHz	Temp./Humi.	:23.4°C/56%
Test Mode	:Tx	Antenna Pol.	:Horizontal
EUT Pol	:E2 Plane	Engineer	:Temo Chen

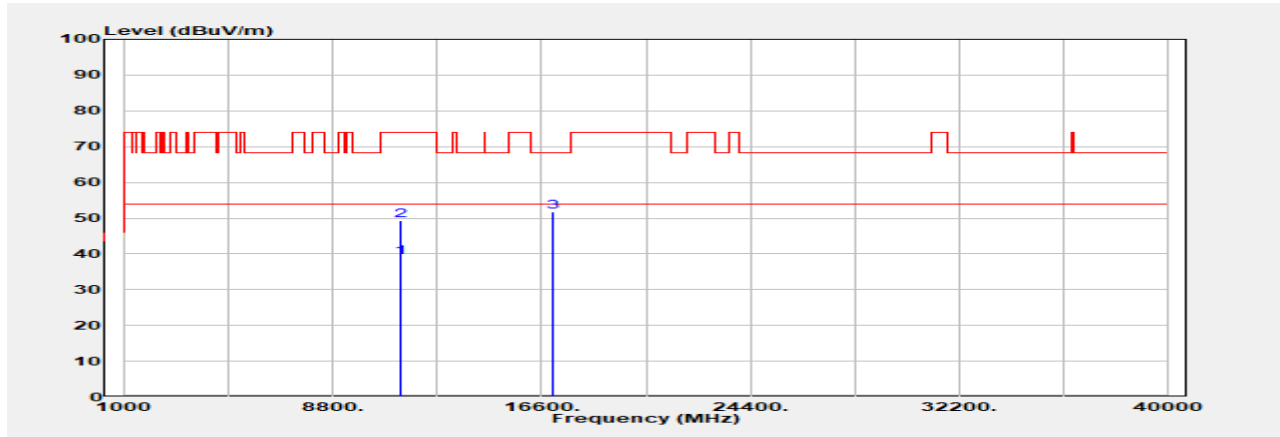

Freq. MHz	Detector Mode PK/QP/AVG	Spectrum Reading Level dBµV	Factor dB	Actual FS dBµV/m	Limit @3m dBµV/m	Margin dB
11340.000	Average	29.24	9.74	38.98	54.00	-15.02
11340.000	Peak	39.48	9.74	49.22	74.00	-24.78
17010.000	Peak	40.04	11.84	51.88	68.20	-16.32

Unless otherwise stated the results shown in this test report refer only to the sample(s) tested and such sample(s) are retained for 90 days only.

除非另有說明，此報告結果僅對測試之樣品負責，同時此樣品僅保留90天。本報告未經本公司書面許可，不可部份複製。

This document is issued by the Company subject to its General Conditions of Service printed overleaf, available on request or accessible at <http://www.sgs.com.tw/Terms-and-Conditions> and for electronic format documents, subject to Terms and Conditions for Electronic Documents at <http://www.sgs.com.tw/Terms-and-Conditions>. Attention is drawn to the limitation of liability, indemnification and jurisdiction issues defined therein. Any holder of this document is advised that information contained hereon reflects the Company's findings at the time of its intervention only and within the limits of Client's instructions, if any. The Company's sole responsibility is to its Client and this document does not exonerate parties to a transaction from exercising all their rights and obligations under the transaction documents. This document cannot be reproduced except in full, without prior written approval of the Company. Any unauthorized alteration, forgery or falsification of the content or appearance of this document is unlawful and offenders may be prosecuted to the fullest extent of the law.

Report Number	:TERF2308001923E2	Test Site	:SAC G Chamber
Operation Mode	:802.11n40	Test Date	:2023-09-25
Test Frequency	:5710 MHz	Temp./Humi.	:23.4°C/56%
Test Mode	:Tx	Antenna Pol.	:Vertical
EUT Pol	:E2 Plane	Engineer	:Temo Chen

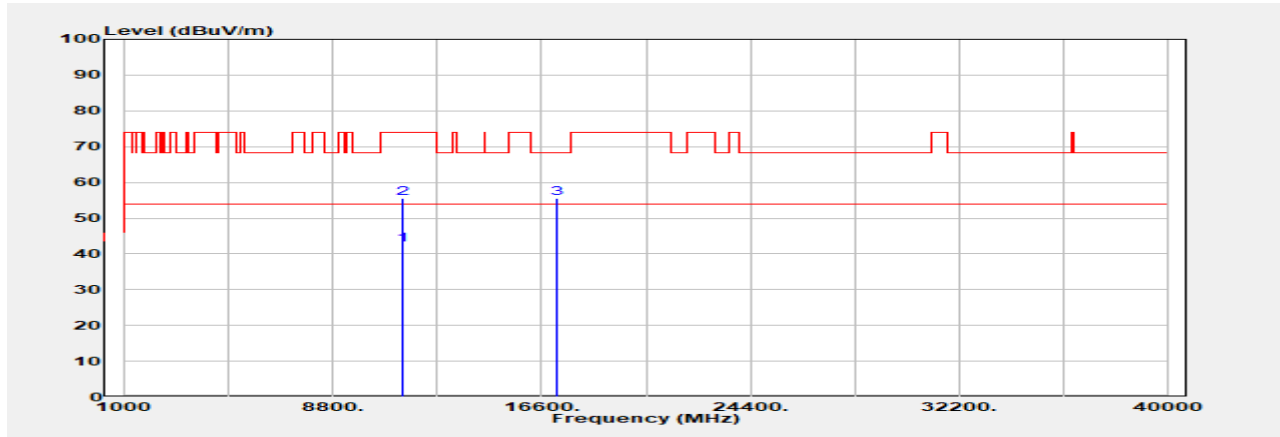

Freq. MHz	Detector Mode PK/QP/AVG	Spectrum Reading Level dBµV	Factor dB	Actual FS dBµV/m	Limit @3m dBµV/m	Margin dB
11420.000	Average	32.34	10.08	42.42	54.00	-11.58
11420.000	Peak	45.56	10.08	55.64	74.00	-18.36
17130.000	Peak	43.79	11.66	55.45	68.20	-12.75

Unless otherwise stated the results shown in this test report refer only to the sample(s) tested and such sample(s) are retained for 90 days only.

除非另有說明，此報告結果僅對測試之樣品負責，同時此樣品僅保留90天。本報告未經本公司書面許可，不可部份複製。

This document is issued by the Company subject to its General Conditions of Service printed overleaf, available on request or accessible at <http://www.sgs.com.tw/Terms-and-Conditions> and for electronic format documents, subject to Terms and Conditions for Electronic Documents at <http://www.sgs.com.tw/Terms-and-Conditions>. Attention is drawn to the limitation of liability, indemnification and jurisdiction issues defined therein. Any holder of this document is advised that information contained hereon reflects the Company's findings at the time of its intervention only and within the limits of Client's instructions, if any. The Company's sole responsibility is to its Client and this document does not exonerate parties to a transaction from exercising all their rights and obligations under the transaction documents. This document cannot be reproduced except in full, without prior written approval of the Company. Any unauthorized alteration, forgery or falsification of the content or appearance of this document is unlawful and offenders may be prosecuted to the fullest extent of the law.

Report Number	:TERF2308001923E2	Test Site	:SAC G Chamber
Operation Mode	:802.11n40	Test Date	:2023-09-25
Test Frequency	:5710 MHz	Temp./Humi.	:23.4°C/56%
Test Mode	:Tx	Antenna Pol.	:Horizontal
EUT Pol	:E2 Plane	Engineer	:Temo Chen

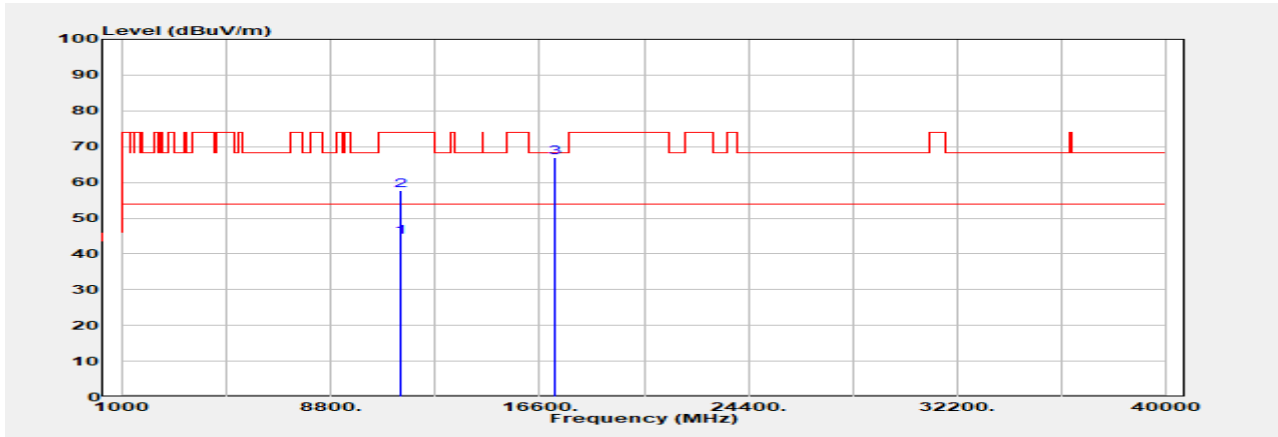

Freq. MHz	Detector Mode PK/QP/AVG	Spectrum Reading Level dBμV	Factor dB	Actual FS dBμV/m	Limit @3m dBμV/m	Margin dB
11420.000	Average	34.54	10.08	44.62	54.00	-9.38
11420.000	Peak	47.56	10.08	57.64	74.00	-16.36
17130.000	Peak	55.16	11.66	66.82	68.20	-1.38

Unless otherwise stated the results shown in this test report refer only to the sample(s) tested and such sample(s) are retained for 90 days only.

除非另有說明，此報告結果僅對測試之樣品負責，同時此樣品僅保留90天。本報告未經本公司書面許可，不可部份複製。

This document is issued by the Company subject to its General Conditions of Service printed overleaf, available on request or accessible at <http://www.sgs.com.tw/Terms-and-Conditions> and for electronic format documents, subject to Terms and Conditions for Electronic Documents at <http://www.sgs.com.tw/Terms-and-Conditions>. Attention is drawn to the limitation of liability, indemnification and jurisdiction issues defined therein. Any holder of this document is advised that information contained hereon reflects the Company's findings at the time of its intervention only and within the limits of Client's instructions, if any. The Company's sole responsibility is to its Client and this document does not exonerate parties to a transaction from exercising all their rights and obligations under the transaction documents. This document cannot be reproduced except in full, without prior written approval of the Company. Any unauthorized alteration, forgery or falsification of the content or appearance of this document is unlawful and offenders may be prosecuted to the fullest extent of the law.

Report Number	:TERF2308001923E2	Test Site	:SAC G Chamber
Operation Mode	:802.11n40	Test Date	:2023-09-25
Test Frequency	:5755 MHz	Temp./Humi.	:23.4°C/56%
Test Mode	:Tx	Antenna Pol.	:Vertical
EUT Pol	:E2 Plane	Engineer	:Temo Chen

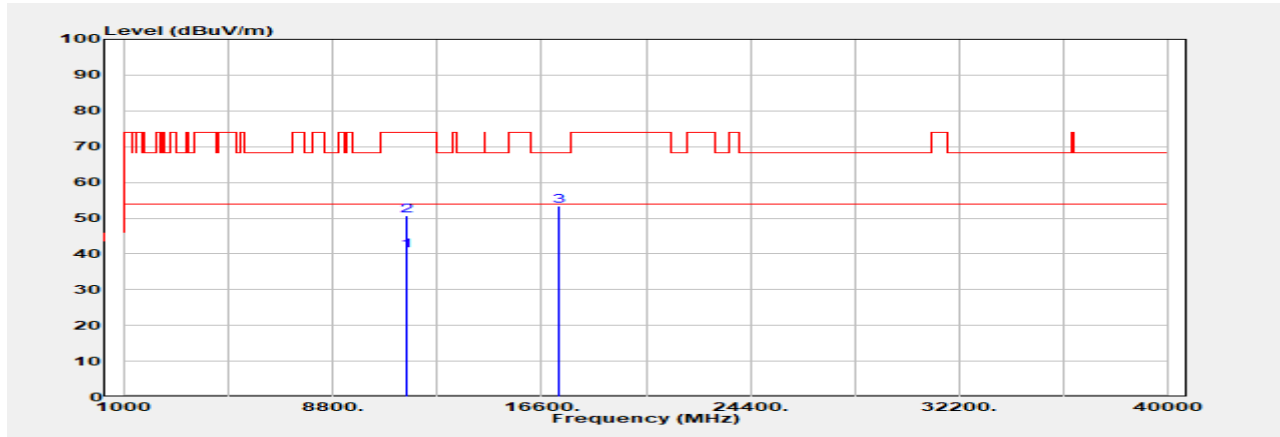

Freq. MHz	Detector Mode PK/QP/AVG	Spectrum Reading Level dB μ V	Factor dB	Actual FS dB μ V/m	Limit @3m dB μ V/m	Margin dB
11510.000	Average	29.76	11.05	40.81	54.00	-13.19
11510.000	Peak	39.73	11.05	50.78	74.00	-23.22
17265.000	Peak	42.30	11.18	53.48	68.20	-14.72

Unless otherwise stated the results shown in this test report refer only to the sample(s) tested and such sample(s) are retained for 90 days only.

除非另有說明，此報告結果僅對測試之樣品負責，同時此樣品僅保留90天。本報告未經本公司書面許可，不可部份複製。

This document is issued by the Company subject to its General Conditions of Service printed overleaf, available on request or accessible at <http://www.sgs.com.tw/Terms-and-Conditions> and for electronic format documents, subject to Terms and Conditions for Electronic Documents at <http://www.sgs.com.tw/Terms-and-Conditions>. Attention is drawn to the limitation of liability, indemnification and jurisdiction issues defined therein. Any holder of this document is advised that information contained hereon reflects the Company's findings at the time of its intervention only and within the limits of Client's instructions, if any. The Company's sole responsibility is to its Client and this document does not exonerate parties to a transaction from exercising all their rights and obligations under the transaction documents. This document cannot be reproduced except in full, without prior written approval of the Company. Any unauthorized alteration, forgery or falsification of the content or appearance of this document is unlawful and offenders may be prosecuted to the fullest extent of the law.

Report Number	:TERF2308001923E2	Test Site	:SAC G Chamber
Operation Mode	:802.11n40	Test Date	:2023-09-25
Test Frequency	:5755 MHz	Temp./Humi.	:23.4°C/56%
Test Mode	:Tx	Antenna Pol.	:Horizontal
EUT Pol	:E2 Plane	Engineer	:Temo Chen

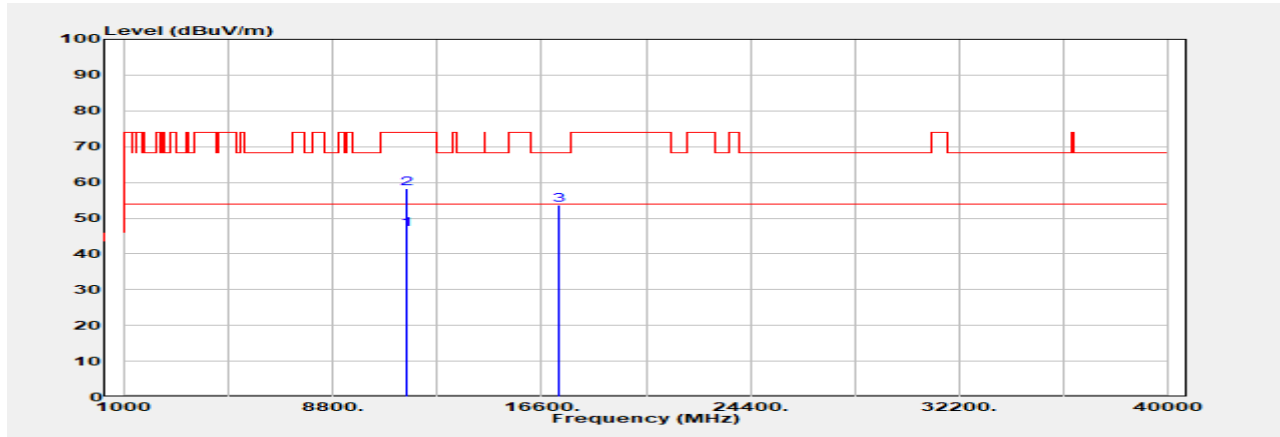

Freq. MHz	Detector Mode PK/QP/AVG	Spectrum Reading Level dB μ V	Factor dB	Actual FS dB μ V/m	Limit @3m dB μ V/m	Margin dB
11510.000	Average	35.94	11.05	46.99	54.00	-7.01
11510.000	Peak	47.25	11.05	58.29	74.00	-15.71
17265.000	Peak	42.51	11.18	53.69	68.20	-14.51

Unless otherwise stated the results shown in this test report refer only to the sample(s) tested and such sample(s) are retained for 90 days only.

除非另有說明，此報告結果僅對測試之樣品負責，同時此樣品僅保留90天。本報告未經本公司書面許可，不可部份複製。

This document is issued by the Company subject to its General Conditions of Service printed overleaf, available on request or accessible at <http://www.sgs.com.tw/Terms-and-Conditions> and for electronic format documents, subject to Terms and Conditions for Electronic Documents at <http://www.sgs.com.tw/Terms-and-Conditions>. Attention is drawn to the limitation of liability, indemnification and jurisdiction issues defined therein. Any holder of this document is advised that information contained hereon reflects the Company's findings at the time of its intervention only and within the limits of Client's instructions, if any. The Company's sole responsibility is to its Client and this document does not exonerate parties to a transaction from exercising all their rights and obligations under the transaction documents. This document cannot be reproduced except in full, without prior written approval of the Company. Any unauthorized alteration, forgery or falsification of the content or appearance of this document is unlawful and offenders may be prosecuted to the fullest extent of the law.

Report Number	:TERF2308001923E2	Test Site	:SAC G Chamber
Operation Mode	:802.11n40	Test Date	:2023-09-25
Test Frequency	:5795 MHz	Temp./Humi.	:23.4°C/56%
Test Mode	:Tx	Antenna Pol.	:Vertical
EUT Pol	:E2 Plane	Engineer	:Temo Chen

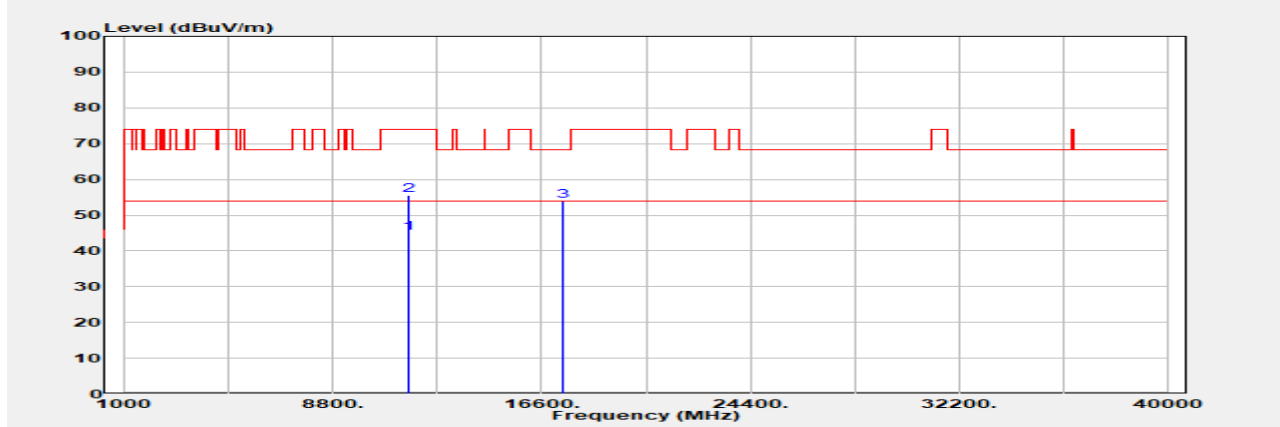

Freq. MHz	Detector Mode PK/QP/AVG	Spectrum Reading Level dBuV	Factor dB	Actual FS dBuV/m	Limit @3m dBuV/m	Margin dB
11590.000	Average	35.08	9.85	44.93	54.00	-9.07
11590.000	Peak	45.58	9.85	55.43	74.00	-18.57
17385.000	Peak	41.86	11.94	53.80	68.20	-14.40

Unless otherwise stated the results shown in this test report refer only to the sample(s) tested and such sample(s) are retained for 90 days only.
 除非另有說明，此報告結果僅對測試之樣品負責，同時此樣品僅保留90天。本報告未經本公司書面許可，不可部份複製。
 This document is issued by the Company subject to its General Conditions of Service printed overleaf, available on request or accessible at <http://www.sgs.com.tw/Terms-and-Conditions> and for electronic format documents, subject to Terms and Conditions for Electronic Documents at <http://www.sgs.com.tw/Terms-and-Conditions>. Attention is drawn to the limitation of liability, indemnification and jurisdiction issues defined therein. Any holder of this document is advised that information contained hereon reflects the Company's findings at the time of its intervention only and within the limits of Client's instructions, if any. The Company's sole responsibility is to its Client and this document does not exonerate parties to a transaction from exercising all their rights and obligations under the transaction documents. This document cannot be reproduced except in full, without prior written approval of the Company. Any unauthorized alteration, forgery or falsification of the content or appearance of this document is unlawful and offenders may be prosecuted to the fullest extent of the law.

Report Number	:TERF2308001923E2	Test Site	:SAC G Chamber
Operation Mode	:802.11n40	Test Date	:2023-09-25
Test Frequency	:5795 MHz	Temp./Humi.	:23.4°C/56%
Test Mode	:Tx	Antenna Pol.	:Horizontal
EUT Pol	:E2 Plane	Engineer	:Temo Chen

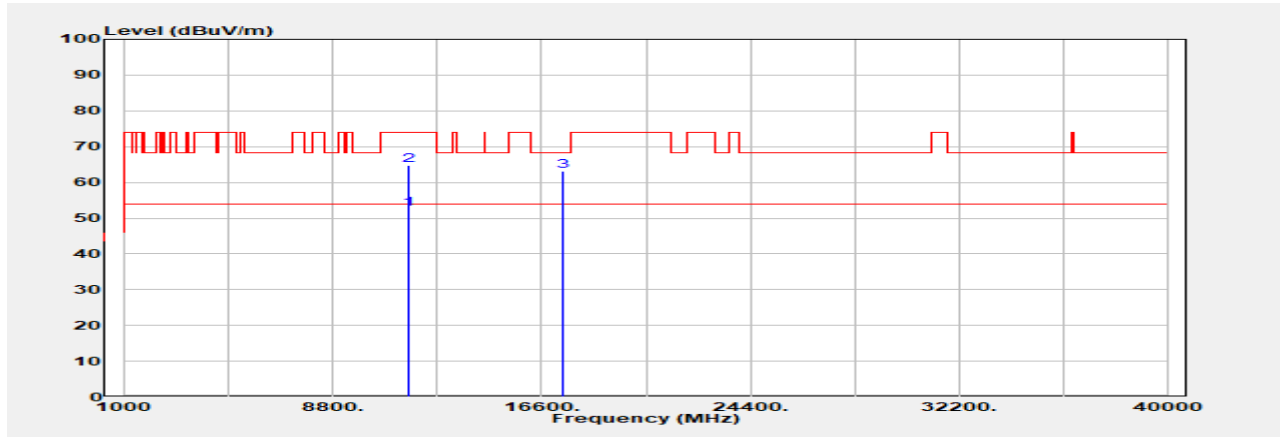

Freq. MHz	Detector Mode PK/QP/AVG	Spectrum Reading Level dB μ V	Factor dB	Actual FS dB μ V/m	Limit @3m dB μ V/m	Margin dB
11590.000	Average	42.80	9.85	52.65	54.00	-1.35
11590.000	Peak	54.96	9.85	64.81	74.00	-9.19
17385.000	Peak	51.13	11.94	63.07	68.20	-5.13

Unless otherwise stated the results shown in this test report refer only to the sample(s) tested and such sample(s) are retained for 90 days only.

除非另有說明，此報告結果僅對測試之樣品負責，同時此樣品僅保留90天。本報告未經本公司書面許可，不可部份複製。

This document is issued by the Company subject to its General Conditions of Service printed overleaf, available on request or accessible at <http://www.sgs.com.tw/Terms-and-Conditions> and for electronic format documents, subject to Terms and Conditions for Electronic Documents at <http://www.sgs.com.tw/Terms-and-Conditions>. Attention is drawn to the limitation of liability, indemnification and jurisdiction issues defined therein. Any holder of this document is advised that information contained hereon reflects the Company's findings at the time of its intervention only and within the limits of Client's instructions, if any. The Company's sole responsibility is to its Client and this document does not exonerate parties to a transaction from exercising all their rights and obligations under the transaction documents. This document cannot be reproduced except in full, without prior written approval of the Company. Any unauthorized alteration, forgery or falsification of the content or appearance of this document is unlawful and offenders may be prosecuted to the fullest extent of the law.

Report Number	:TERF2308001923E2	Test Site	:SAC G Chamber
Operation Mode	:802.11ac80	Test Date	:2023-09-25
Test Frequency	:5210 MHz	Temp./Humi.	:23.4°C/56%
Test Mode	:Tx	Antenna Pol.	:Vertical
EUT Pol	:E2 Plane	Engineer	:Temo Chen

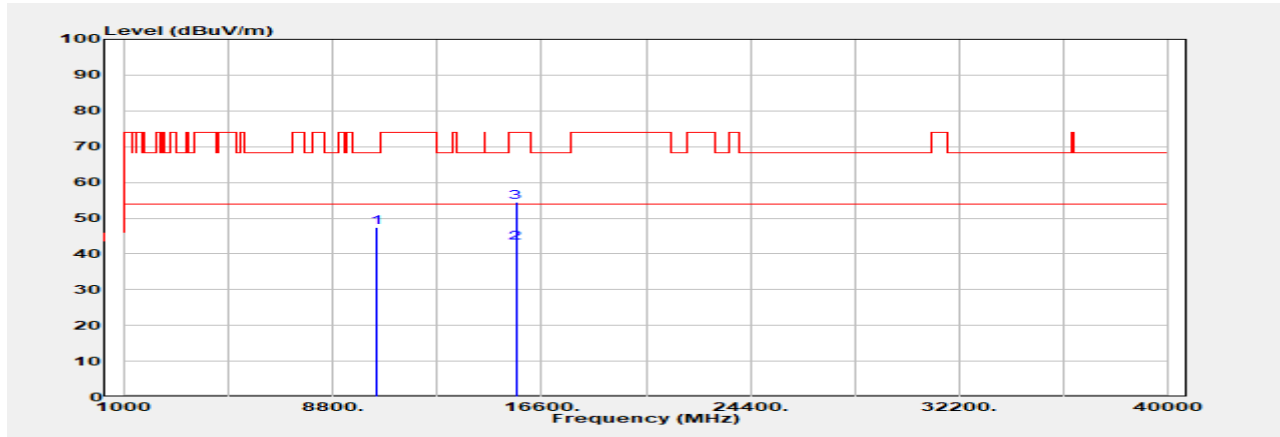

Freq. MHz	Detector Mode PK/QP/AVG	Spectrum Reading Level dB μ V	Factor dB	Actual FS dB μ V/m	Limit @3m dB μ V/m	Margin dB
10420.000	Peak	37.94	9.58	47.52	68.20	-20.68
15630.000	Average	30.90	12.11	43.01	54.00	-10.99
15630.000	Peak	42.25	12.11	54.36	74.00	-19.64

Unless otherwise stated the results shown in this test report refer only to the sample(s) tested and such sample(s) are retained for 90 days only.

除非另有說明，此報告結果僅對測試之樣品負責，同時此樣品僅保留90天。本報告未經本公司書面許可，不可部份複製。

This document is issued by the Company subject to its General Conditions of Service printed overleaf, available on request or accessible at <http://www.sgs.com.tw/Terms-and-Conditions> and for electronic format documents, subject to Terms and Conditions for Electronic Documents at <http://www.sgs.com.tw/Terms-and-Conditions>. Attention is drawn to the limitation of liability, indemnification and jurisdiction issues defined therein. Any holder of this document is advised that information contained hereon reflects the Company's findings at the time of its intervention only and within the limits of Client's instructions, if any. The Company's sole responsibility is to its Client and this document does not exonerate parties to a transaction from exercising all their rights and obligations under the transaction documents. This document cannot be reproduced except in full, without prior written approval of the Company. Any unauthorized alteration, forgery or falsification of the content or appearance of this document is unlawful and offenders may be prosecuted to the fullest extent of the law.

Report Number	:TERF2308001923E2	Test Site	:SAC G Chamber
Operation Mode	:802.11ac80	Test Date	:2023-09-25
Test Frequency	:5210 MHz	Temp./Humi.	:23.4°C/56%
Test Mode	:Tx	Antenna Pol.	:Horizontal
EUT Pol	:E2 Plane	Engineer	:Temo Chen

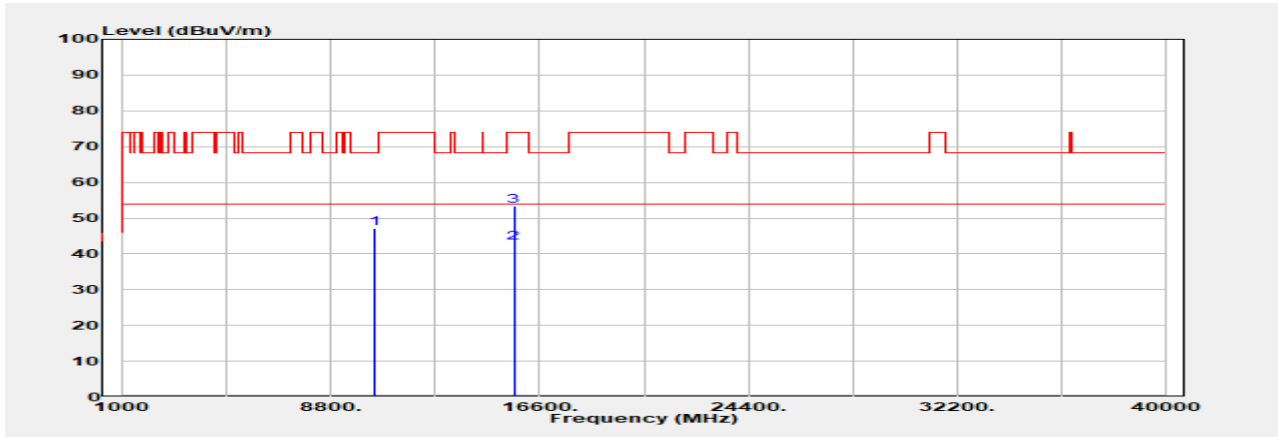

Freq. MHz	Detector Mode PK/QP/AVG	Spectrum Reading Level dB μ V	Factor dB	Actual FS dB μ V/m	Limit @3m dB μ V/m	Margin dB
10420.000	Peak	37.60	9.58	47.18	68.20	-21.02
15630.000	Average	30.96	12.11	43.07	54.00	-10.93
15630.000	Peak	41.15	12.11	53.26	74.00	-20.74

Unless otherwise stated the results shown in this test report refer only to the sample(s) tested and such sample(s) are retained for 90 days only.

除非另有說明，此報告結果僅對測試之樣品負責，同時此樣品僅保留90天。本報告未經本公司書面許可，不可部份複製。

This document is issued by the Company subject to its General Conditions of Service printed overleaf, available on request or accessible at <http://www.sgs.com.tw/Terms-and-Conditions> and for electronic format documents, subject to Terms and Conditions for Electronic Documents at <http://www.sgs.com.tw/Terms-and-Conditions>. Attention is drawn to the limitation of liability, indemnification and jurisdiction issues defined therein. Any holder of this document is advised that information contained hereon reflects the Company's findings at the time of its intervention only and within the limits of Client's instructions, if any. The Company's sole responsibility is to its Client and this document does not exonerate parties to a transaction from exercising all their rights and obligations under the transaction documents. This document cannot be reproduced except in full, without prior written approval of the Company. Any unauthorized alteration, forgery or falsification of the content or appearance of this document is unlawful and offenders may be prosecuted to the fullest extent of the law.

Report Number	:TERF2308001923E2	Test Site	:SAC G Chamber
Operation Mode	:802.11ac80	Test Date	:2023-09-25
Test Frequency	:5290 MHz	Temp./Humi.	:23.4°C/56%
Test Mode	:Tx	Antenna Pol.	:Vertical
EUT Pol	:E2 Plane	Engineer	:Temo Chen

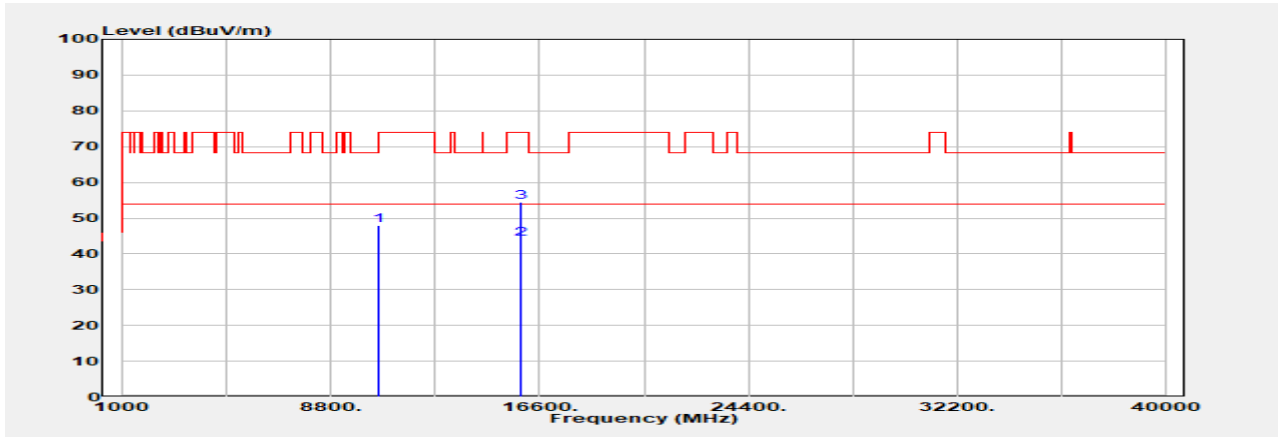

Freq. MHz	Detector Mode PK/QP/AVG	Spectrum Reading Level dB μ V	Factor dB	Actual FS dB μ V/m	Limit @3m dB μ V/m	Margin dB
10580.000	Peak	37.88	9.98	47.86	68.20	-20.34
15870.000	Average	31.83	12.26	44.09	54.00	-9.91
15870.000	Peak	42.21	12.26	54.47	74.00	-19.53

Unless otherwise stated the results shown in this test report refer only to the sample(s) tested and such sample(s) are retained for 90 days only.

除非另有說明，此報告結果僅對測試之樣品負責，同時此樣品僅保留90天。本報告未經本公司書面許可，不可部份複製。

This document is issued by the Company subject to its General Conditions of Service printed overleaf, available on request or accessible at <http://www.sgs.com.tw/Terms-and-Conditions> and for electronic format documents, subject to Terms and Conditions for Electronic Documents at <http://www.sgs.com.tw/Terms-and-Conditions>. Attention is drawn to the limitation of liability, indemnification and jurisdiction issues defined therein. Any holder of this document is advised that information contained hereon reflects the Company's findings at the time of its intervention only and within the limits of Client's instructions, if any. The Company's sole responsibility is to its Client and this document does not exonerate parties to a transaction from exercising all their rights and obligations under the transaction documents. This document cannot be reproduced except in full, without prior written approval of the Company. Any unauthorized alteration, forgery or falsification of the content or appearance of this document is unlawful and offenders may be prosecuted to the fullest extent of the law.

Report Number	:TERF2308001923E2	Test Site	:SAC G Chamber
Operation Mode	:802.11ac80	Test Date	:2023-09-25
Test Frequency	:5290 MHz	Temp./Humi.	:23.4°C/56%
Test Mode	:Tx	Antenna Pol.	:Horizontal
EUT Pol	:E2 Plane	Engineer	:Temo Chen

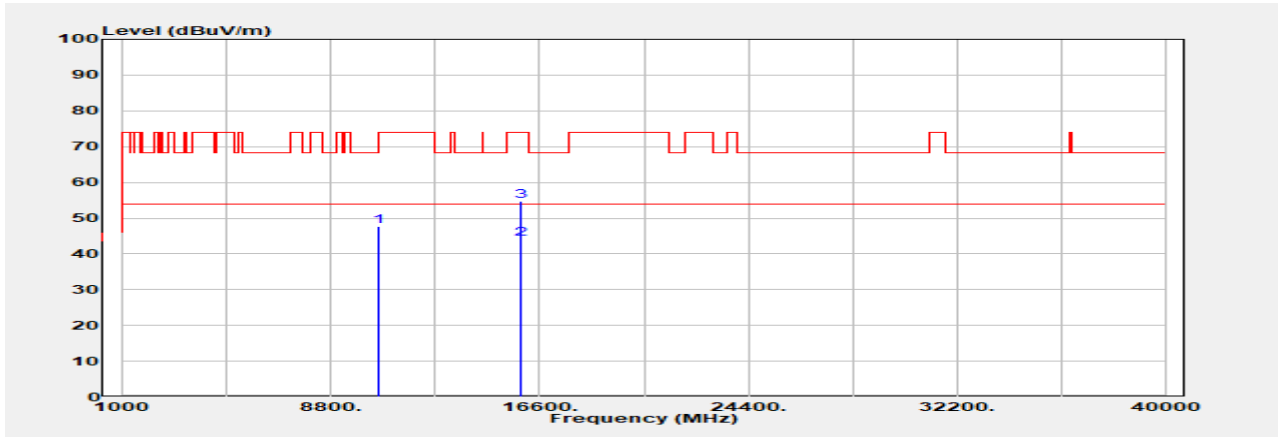

Freq. MHz	Detector Mode	Spectrum Reading Level dB μ V	Factor dB	Actual FS dB μ V/m	Limit @3m dB μ V/m	Margin dB
10580.000	Peak	37.84	9.98	47.82	68.20	-20.38
15870.000	Average	31.95	12.26	44.21	54.00	-9.79
15870.000	Peak	42.61	12.26	54.87	74.00	-19.13

Unless otherwise stated the results shown in this test report refer only to the sample(s) tested and such sample(s) are retained for 90 days only.

除非另有說明，此報告結果僅對測試之樣品負責，同時此樣品僅保留90天。本報告未經本公司書面許可，不可部份複製。

This document is issued by the Company subject to its General Conditions of Service printed overleaf, available on request or accessible at <http://www.sgs.com.tw/Terms-and-Conditions> and for electronic format documents, subject to Terms and Conditions for Electronic Documents at <http://www.sgs.com.tw/Terms-and-Conditions>. Attention is drawn to the limitation of liability, indemnification and jurisdiction issues defined therein. Any holder of this document is advised that information contained hereon reflects the Company's findings at the time of its intervention only and within the limits of Client's instructions, if any. The Company's sole responsibility is to its Client and this document does not exonerate parties to a transaction from exercising all their rights and obligations under the transaction documents. This document cannot be reproduced except in full, without prior written approval of the Company. Any unauthorized alteration, forgery or falsification of the content or appearance of this document is unlawful and offenders may be prosecuted to the fullest extent of the law.

Report Number	:TERF2308001923E2	Test Site	:SAC G Chamber
Operation Mode	:802.11ac80	Test Date	:2023-09-25
Test Frequency	:5530 MHz	Temp./Humi.	:23.4°C/56%
Test Mode	:Tx	Antenna Pol.	:Vertical
EUT Pol	:E2 Plane	Engineer	:Temo Chen

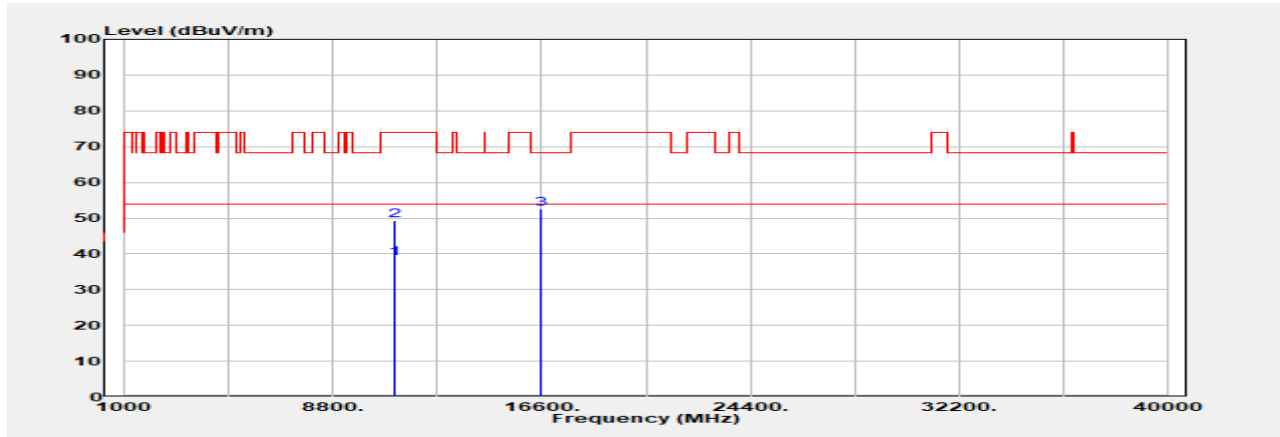

Freq. MHz	Detector Mode PK/QP/AVG	Spectrum Reading Level dB μ V	Factor dB	Actual FS dB μ V/m	Limit @3m dB μ V/m	Margin dB
11060.000	Average	28.25	10.58	38.83	54.00	-15.17
11060.000	Peak	38.88	10.58	49.46	74.00	-24.54
16590.000	Peak	40.66	11.82	52.48	68.20	-15.72

Unless otherwise stated the results shown in this test report refer only to the sample(s) tested and such sample(s) are retained for 90 days only.

除非另有說明，此報告結果僅對測試之樣品負責，同時此樣品僅保留90天。本報告未經本公司書面許可，不可部份複製。

This document is issued by the Company subject to its General Conditions of Service printed overleaf, available on request or accessible at <http://www.sgs.com.tw/Terms-and-Conditions> and for electronic format documents, subject to Terms and Conditions for Electronic Documents at <http://www.sgs.com.tw/Terms-and-Conditions>. Attention is drawn to the limitation of liability, indemnification and jurisdiction issues defined therein. Any holder of this document is advised that information contained hereon reflects the Company's findings at the time of its intervention only and within the limits of Client's instructions, if any. The Company's sole responsibility is to its Client and this document does not exonerate parties to a transaction from exercising all their rights and obligations under the transaction documents. This document cannot be reproduced except in full, without prior written approval of the Company. Any unauthorized alteration, forgery or falsification of the content or appearance of this document is unlawful and offenders may be prosecuted to the fullest extent of the law.

Report Number	:TERF2308001923E2	Test Site	:SAC G Chamber
Operation Mode	:802.11ac80	Test Date	:2023-09-25
Test Frequency	:5530 MHz	Temp./Humi.	:23.4°C/56%
Test Mode	:Tx	Antenna Pol.	:Horizontal
EUT Pol	:E2 Plane	Engineer	:Temo Chen

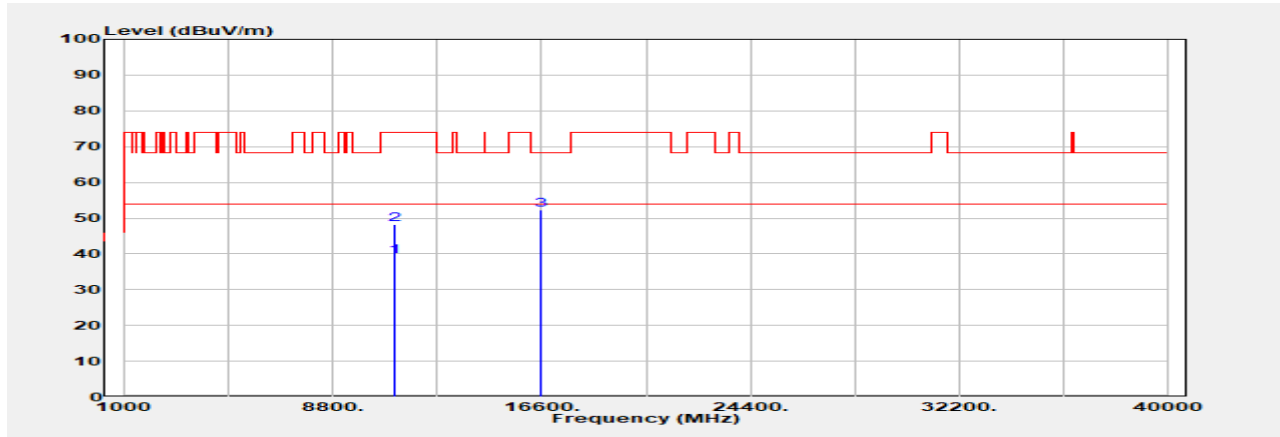

Freq. MHz	Detector Mode PK/QP/AVG	Spectrum Reading Level dB μ V	Factor dB	Actual FS dB μ V/m	Limit @3m dB μ V/m	Margin dB
11060.000	Average	28.77	10.58	39.35	54.00	-14.65
11060.000	Peak	37.78	10.58	48.36	74.00	-25.64
16590.000	Peak	40.60	11.82	52.42	68.20	-15.78

Unless otherwise stated the results shown in this test report refer only to the sample(s) tested and such sample(s) are retained for 90 days only.

除非另有說明，此報告結果僅對測試之樣品負責，同時此樣品僅保留90天。本報告未經本公司書面許可，不可部份複製。

This document is issued by the Company subject to its General Conditions of Service printed overleaf, available on request or accessible at <http://www.sgs.com.tw/Terms-and-Conditions> and for electronic format documents, subject to Terms and Conditions for Electronic Documents at <http://www.sgs.com.tw/Terms-and-Conditions>. Attention is drawn to the limitation of liability, indemnification and jurisdiction issues defined therein. Any holder of this document is advised that information contained hereon reflects the Company's findings at the time of its intervention only and within the limits of Client's instructions, if any. The Company's sole responsibility is to its Client and this document does not exonerate parties to a transaction from exercising all their rights and obligations under the transaction documents. This document cannot be reproduced except in full, without prior written approval of the Company. Any unauthorized alteration, forgery or falsification of the content or appearance of this document is unlawful and offenders may be prosecuted to the fullest extent of the law.

Report Number	:TERF2308001923E2	Test Site	:SAC G Chamber
Operation Mode	:802.11ac80	Test Date	:2023-09-25
Test Frequency	:5610 MHz	Temp./Humi.	:23.4°C/56%
Test Mode	:Tx	Antenna Pol.	:Vertical
EUT Pol	:E2 Plane	Engineer	:Temo Chen

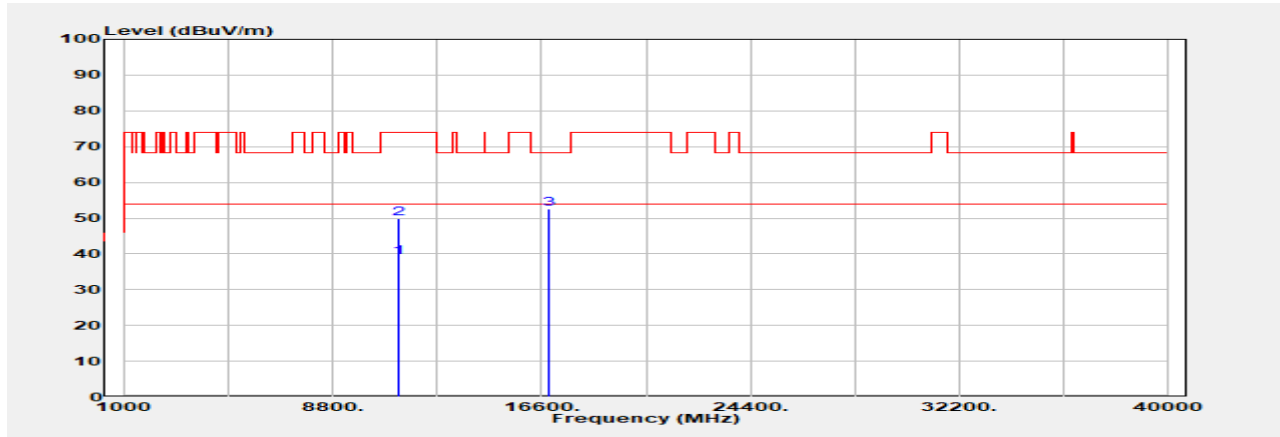

Freq. MHz	Detector Mode PK/QP/AVG	Spectrum Reading Level dB μ V	Factor dB	Actual FS dB μ V/m	Limit @3m dB μ V/m	Margin dB
11220.000	Average	29.04	9.94	38.98	54.00	-15.02
11220.000	Peak	39.92	9.94	49.86	74.00	-24.14
16830.000	Peak	41.31	11.27	52.58	68.20	-15.62

Unless otherwise stated the results shown in this test report refer only to the sample(s) tested and such sample(s) are retained for 90 days only.

除非另有說明，此報告結果僅對測試之樣品負責，同時此樣品僅保留90天。本報告未經本公司書面許可，不可部份複製。

This document is issued by the Company subject to its General Conditions of Service printed overleaf, available on request or accessible at <http://www.sgs.com.tw/Terms-and-Conditions> and for electronic format documents, subject to Terms and Conditions for Electronic Documents at <http://www.sgs.com.tw/Terms-and-Conditions>. Attention is drawn to the limitation of liability, indemnification and jurisdiction issues defined therein. Any holder of this document is advised that information contained hereon reflects the Company's findings at the time of its intervention only and within the limits of Client's instructions, if any. The Company's sole responsibility is to its Client and this document does not exonerate parties to a transaction from exercising all their rights and obligations under the transaction documents. This document cannot be reproduced except in full, without prior written approval of the Company. Any unauthorized alteration, forgery or falsification of the content or appearance of this document is unlawful and offenders may be prosecuted to the fullest extent of the law.

Report Number	:TERF2308001923E2	Test Site	:SAC G Chamber
Operation Mode	:802.11ac80	Test Date	:2023-09-25
Test Frequency	:5610 MHz	Temp./Humi.	:23.4°C/56%
Test Mode	:Tx	Antenna Pol.	:Horizontal
EUT Pol	:E2 Plane	Engineer	:Temo Chen

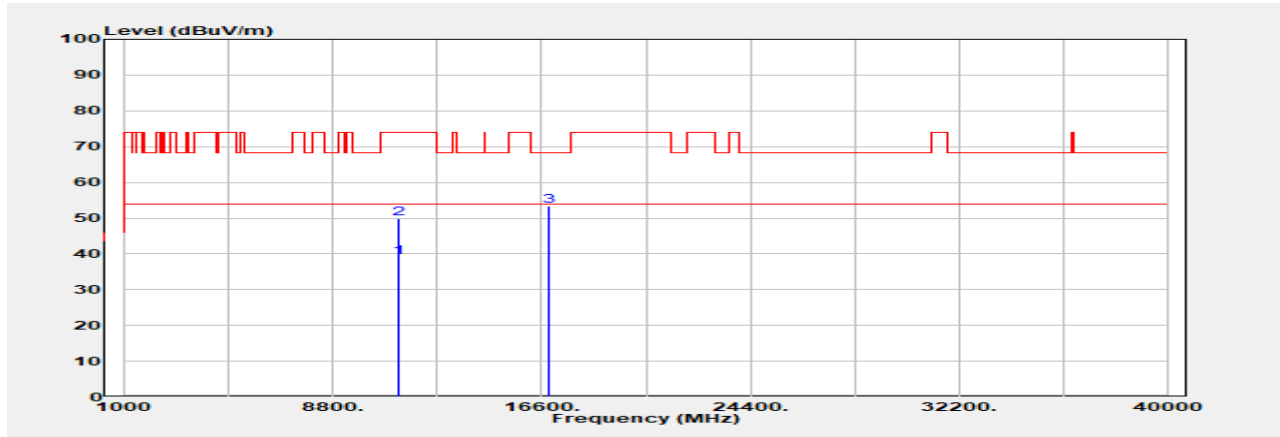

Freq. MHz	Detector Mode PK/QP/AVG	Spectrum Reading Level dB μ V	Factor dB	Actual FS dB μ V/m	Limit @3m dB μ V/m	Margin dB
11220.000	Average	29.16	9.94	39.10	54.00	-14.90
11220.000	Peak	39.82	9.94	49.76	74.00	-24.24
16830.000	Peak	42.20	11.27	53.47	68.20	-14.73

Unless otherwise stated the results shown in this test report refer only to the sample(s) tested and such sample(s) are retained for 90 days only.

除非另有說明，此報告結果僅對測試之樣品負責，同時此樣品僅保留90天。本報告未經本公司書面許可，不可部份複製。

This document is issued by the Company subject to its General Conditions of Service printed overleaf, available on request or accessible at <http://www.sgs.com.tw/Terms-and-Conditions> and for electronic format documents, subject to Terms and Conditions for Electronic Documents at <http://www.sgs.com.tw/Terms-and-Conditions>. Attention is drawn to the limitation of liability, indemnification and jurisdiction issues defined therein. Any holder of this document is advised that information contained hereon reflects the Company's findings at the time of its intervention only and within the limits of Client's instructions, if any. The Company's sole responsibility is to its Client and this document does not exonerate parties to a transaction from exercising all their rights and obligations under the transaction documents. This document cannot be reproduced except in full, without prior written approval of the Company. Any unauthorized alteration, forgery or falsification of the content or appearance of this document is unlawful and offenders may be prosecuted to the fullest extent of the law.

Report Number	:TERF2308001923E2	Test Site	:SAC G Chamber
Operation Mode	:802.11ac80	Test Date	:2023-09-25
Test Frequency	:5690 MHz	Temp./Humi.	:23.4°C/56%
Test Mode	:Tx	Antenna Pol.	:Vertical
EUT Pol	:E2 Plane	Engineer	:Temo Chen

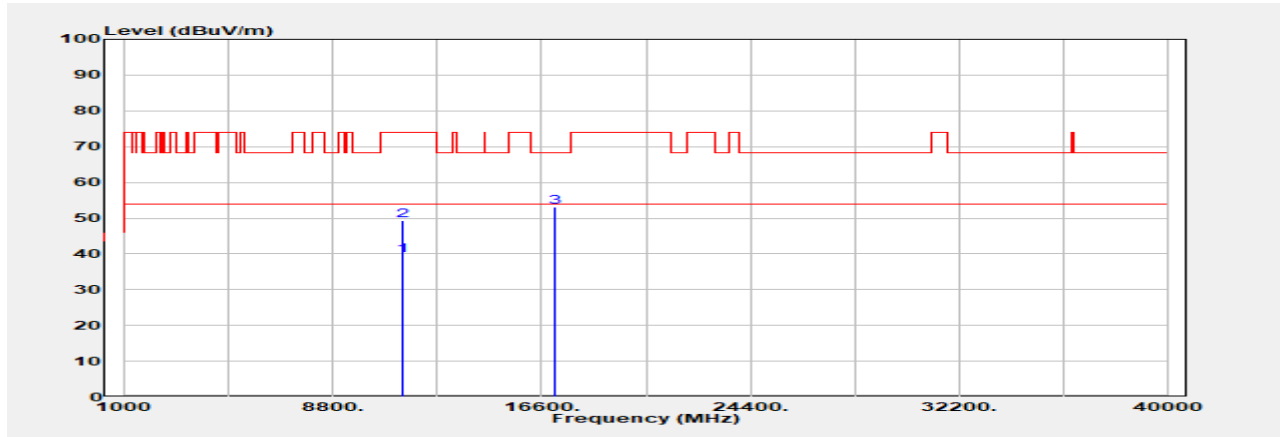

Freq. MHz	Detector Mode PK/QP/AVG	Spectrum Reading Level dBuV	Factor dB	Actual FS dBuV/m	Limit @3m dBuV/m	Margin dB
11380.000	Average	29.87	9.78	39.65	54.00	-14.35
11380.000	Peak	39.67	9.78	49.45	74.00	-24.55
17070.000	Peak	41.02	12.08	53.10	68.20	-15.10

Unless otherwise stated the results shown in this test report refer only to the sample(s) tested and such sample(s) are retained for 90 days only.

除非另有說明，此報告結果僅對測試之樣品負責，同時此樣品僅保留90天。本報告未經本公司書面許可，不可部份複製。

This document is issued by the Company subject to its General Conditions of Service printed overleaf, available on request or accessible at <http://www.sgs.com.tw/Terms-and-Conditions> and for electronic format documents, subject to Terms and Conditions for Electronic Documents at <http://www.sgs.com.tw/Terms-and-Conditions>. Attention is drawn to the limitation of liability, indemnification and jurisdiction issues defined therein. Any holder of this document is advised that information contained hereon reflects the Company's findings at the time of its intervention only and within the limits of Client's instructions, if any. The Company's sole responsibility is to its Client and this document does not exonerate parties to a transaction from exercising all their rights and obligations under the transaction documents. This document cannot be reproduced except in full, without prior written approval of the Company. Any unauthorized alteration, forgery or falsification of the content or appearance of this document is unlawful and offenders may be prosecuted to the fullest extent of the law.

Report Number	:TERF2308001923E2	Test Site	:SAC G Chamber
Operation Mode	:802.11ac80	Test Date	:2023-09-25
Test Frequency	:5690 MHz	Temp./Humi.	:23.4°C/56%
Test Mode	:Tx	Antenna Pol.	:Horizontal
EUT Pol	:E2 Plane	Engineer	:Temo Chen

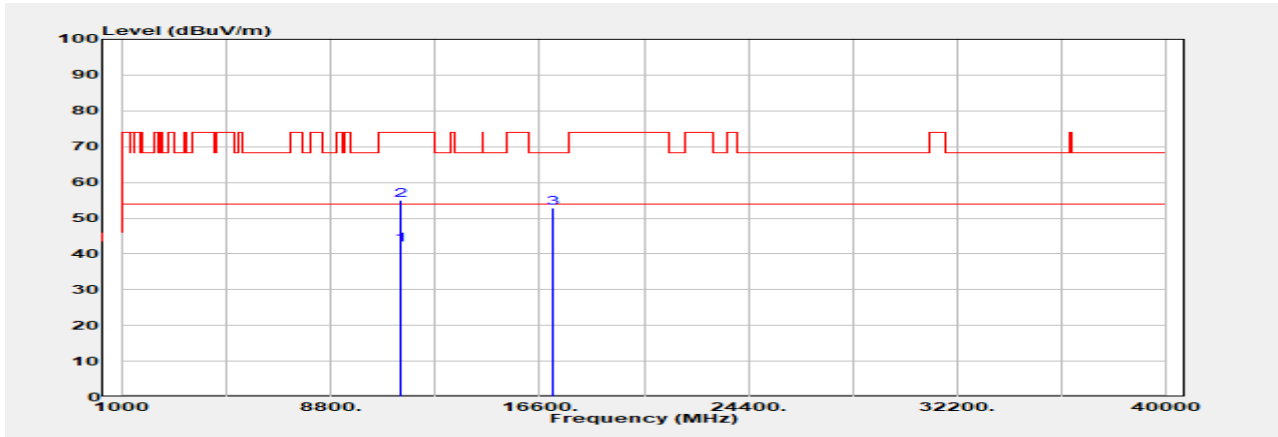

Freq. MHz	Detector Mode PK/QP/AVG	Spectrum Reading Level dBµV	Factor dB	Actual FS dBµV/m	Limit @3m dBµV/m	Margin dB
11380.000	Average	32.81	9.78	42.59	54.00	-11.41
11380.000	Peak	45.21	9.78	54.99	74.00	-19.01
17070.000	Peak	40.83	12.08	52.91	68.20	-15.29

Unless otherwise stated the results shown in this test report refer only to the sample(s) tested and such sample(s) are retained for 90 days only.

除非另有說明，此報告結果僅對測試之樣品負責，同時此樣品僅保留90天。本報告未經本公司書面許可，不可部份複製。

This document is issued by the Company subject to its General Conditions of Service printed overleaf, available on request or accessible at <http://www.sgs.com.tw/Terms-and-Conditions> and for electronic format documents, subject to Terms and Conditions for Electronic Documents at <http://www.sgs.com.tw/Terms-and-Conditions>. Attention is drawn to the limitation of liability, indemnification and jurisdiction issues defined therein. Any holder of this document is advised that information contained hereon reflects the Company's findings at the time of its intervention only and within the limits of Client's instructions, if any. The Company's sole responsibility is to its Client and this document does not exonerate parties to a transaction from exercising all their rights and obligations under the transaction documents. This document cannot be reproduced except in full, without prior written approval of the Company. Any unauthorized alteration, forgery or falsification of the content or appearance of this document is unlawful and offenders may be prosecuted to the fullest extent of the law.

Report Number	:TERF2308001923E2	Test Site	:SAC G Chamber
Operation Mode	:802.11ac80	Test Date	:2023-09-25
Test Frequency	:5775 MHz	Temp./Humi.	:23.4°C/56%
Test Mode	:Tx	Antenna Pol.	:Vertical
EUT Pol	:E2 Plane	Engineer	:Temo Chen

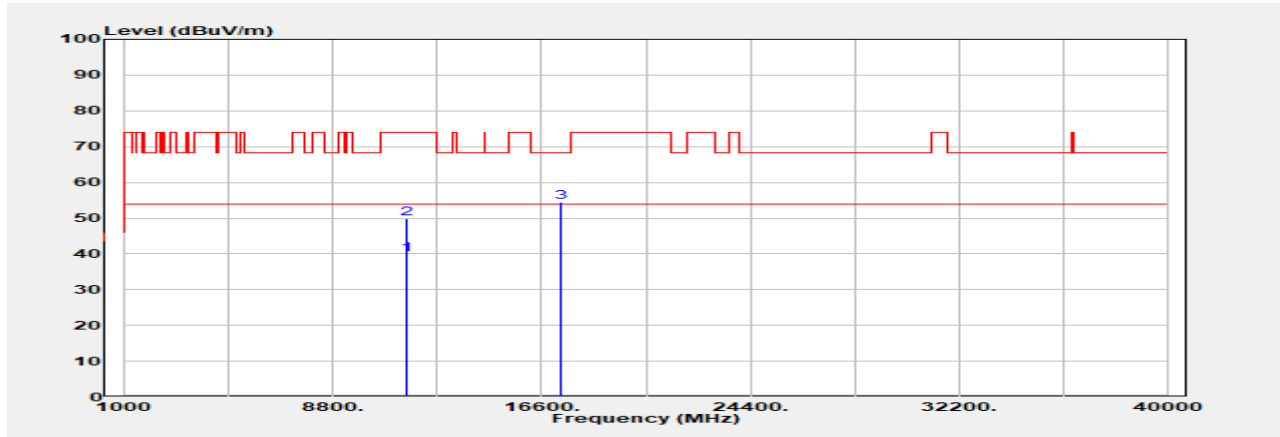

Freq. MHz	Detector Mode PK/QP/AVG	Spectrum Reading Level dBuV	Factor dB	Actual FS dBuV/m	Limit @3m dBuV/m	Margin dB
11550.000	Average	29.50	10.45	39.95	54.00	-14.05
11550.000	Peak	39.45	10.45	49.90	74.00	-24.10
17325.000	Peak	42.85	11.70	54.55	68.20	-13.65

Unless otherwise stated the results shown in this test report refer only to the sample(s) tested and such sample(s) are retained for 90 days only.

除非另有說明，此報告結果僅對測試之樣品負責，同時此樣品僅保留90天。本報告未經本公司書面許可，不可部份複製。

This document is issued by the Company subject to its General Conditions of Service printed overleaf, available on request or accessible at <http://www.sgs.com.tw/Terms-and-Conditions> and for electronic format documents, subject to Terms and Conditions for Electronic Documents at <http://www.sgs.com.tw/Terms-and-Conditions>. Attention is drawn to the limitation of liability, indemnification and jurisdiction issues defined therein. Any holder of this document is advised that information contained hereon reflects the Company's findings at the time of its intervention only and within the limits of Client's instructions, if any. The Company's sole responsibility is to its Client and this document does not exonerate parties to a transaction from exercising all their rights and obligations under the transaction documents. This document cannot be reproduced except in full, without prior written approval of the Company. Any unauthorized alteration, forgery or falsification of the content or appearance of this document is unlawful and offenders may be prosecuted to the fullest extent of the law.

Report Number	:TERF2308001923E2	Test Site	:SAC G Chamber
Operation Mode	:802.11ac80	Test Date	:2023-09-25
Test Frequency	:5775 MHz	Temp./Humi.	:23.4°C/56%
Test Mode	:Tx	Antenna Pol.	:Horizontal
EUT Pol	:E2 Plane	Engineer	:Temo Chen

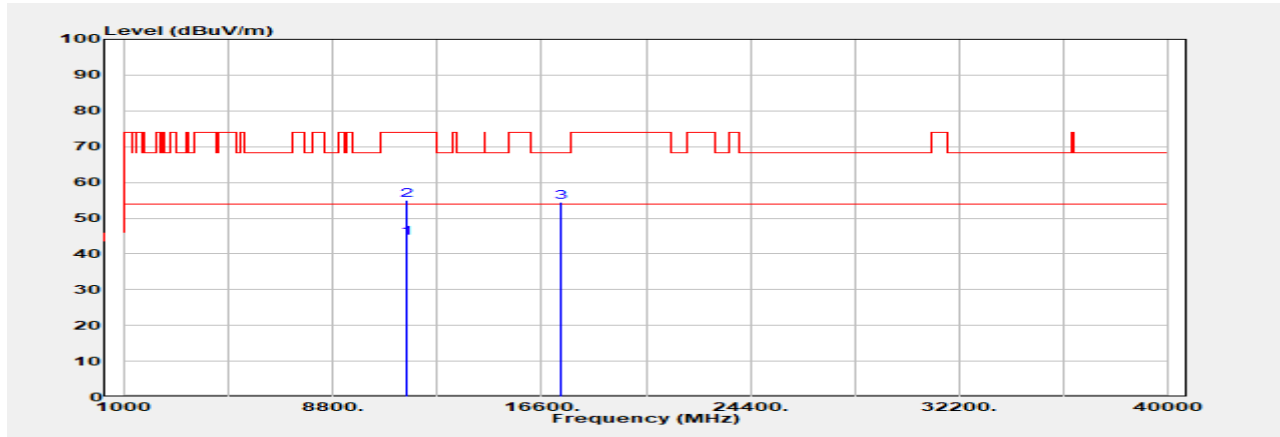

Freq. MHz	Detector Mode PK/QP/AVG	Spectrum Reading Level dBμV	Factor dB	Actual FS dBμV/m	Limit @3m dBμV/m	Margin dB
11550.000	Average	33.97	10.45	44.42	54.00	-9.58
11550.000	Peak	44.55	10.45	55.00	74.00	-19.00
17325.000	Peak	42.75	11.70	54.45	68.20	-13.75

Unless otherwise stated the results shown in this test report refer only to the sample(s) tested and such sample(s) are retained for 90 days only.

除非另有說明，此報告結果僅對測試之樣品負責，同時此樣品僅保留90天。本報告未經本公司書面許可，不可部份複製。

This document is issued by the Company subject to its General Conditions of Service printed overleaf, available on request or accessible at <http://www.sgs.com.tw/Terms-and-Conditions> and for electronic format documents, subject to Terms and Conditions for Electronic Documents at <http://www.sgs.com.tw/Terms-and-Conditions>. Attention is drawn to the limitation of liability, indemnification and jurisdiction issues defined therein. Any holder of this document is advised that information contained hereon reflects the Company's findings at the time of its intervention only and within the limits of Client's instructions, if any. The Company's sole responsibility is to its Client and this document does not exonerate parties to a transaction from exercising all their rights and obligations under the transaction documents. This document cannot be reproduced except in full, without prior written approval of the Company. Any unauthorized alteration, forgery or falsification of the content or appearance of this document is unlawful and offenders may be prosecuted to the fullest extent of the law.

Report Number	:TERF2308001923E2	Test Site	:SAC G Chamber
Operation Mode	:802.11ac160	Test Date	:2023-09-25
Test Frequency	:5250 MHz	Temp./Humi.	:23.4°C/56%
Test Mode	:Tx	Antenna Pol.	:Vertical
EUT Pol	:E2 Plane	Engineer	:Temo Chen

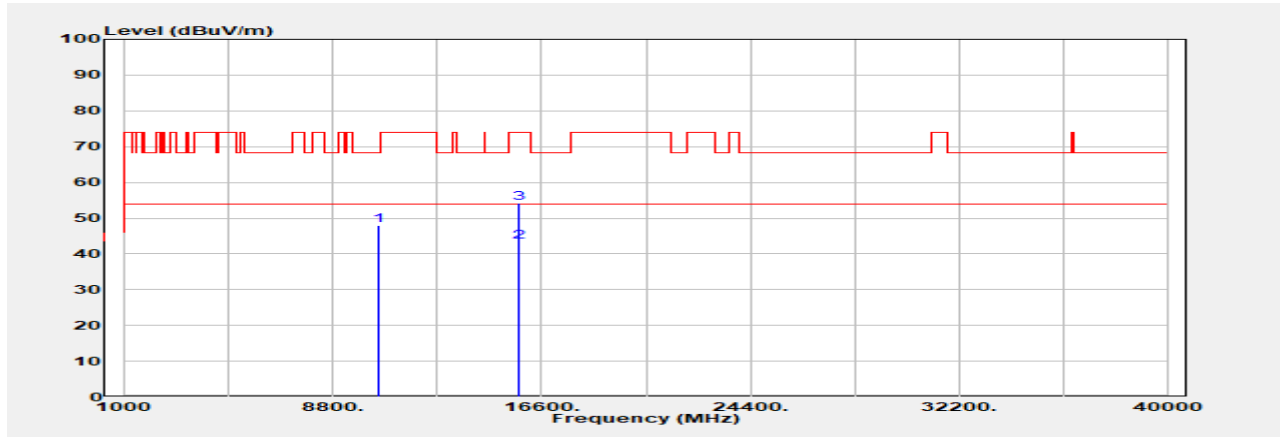

Freq. MHz	Detector Mode PK/QP/AVG	Spectrum Reading Level dB μ V	Factor dB	Actual FS dB μ V/m	Limit @3m dB μ V/m	Margin dB
10500.000	Peak	38.06	9.90	47.96	68.20	-20.24
15750.000	Average	30.86	12.50	43.36	54.00	-10.64
15750.000	Peak	41.58	12.50	54.08	74.00	-19.92

Unless otherwise stated the results shown in this test report refer only to the sample(s) tested and such sample(s) are retained for 90 days only.

除非另有說明，此報告結果僅對測試之樣品負責，同時此樣品僅保留90天。本報告未經本公司書面許可，不可部份複製。

This document is issued by the Company subject to its General Conditions of Service printed overleaf, available on request or accessible at <http://www.sgs.com.tw/Terms-and-Conditions> and for electronic format documents, subject to Terms and Conditions for Electronic Documents at <http://www.sgs.com.tw/Terms-and-Conditions>. Attention is drawn to the limitation of liability, indemnification and jurisdiction issues defined therein. Any holder of this document is advised that information contained hereon reflects the Company's findings at the time of its intervention only and within the limits of Client's instructions, if any. The Company's sole responsibility is to its Client and this document does not exonerate parties to a transaction from exercising all their rights and obligations under the transaction documents. This document cannot be reproduced except in full, without prior written approval of the Company. Any unauthorized alteration, forgery or falsification of the content or appearance of this document is unlawful and offenders may be prosecuted to the fullest extent of the law.

Report Number	:TERF2308001923E2	Test Site	:SAC G Chamber
Operation Mode	:802.11ac160	Test Date	:2023-09-25
Test Frequency	:5250 MHz	Temp./Humi.	:23.4°C/56%
Test Mode	:Tx	Antenna Pol.	:Horizontal
EUT Pol	:E2 Plane	Engineer	:Temo Chen

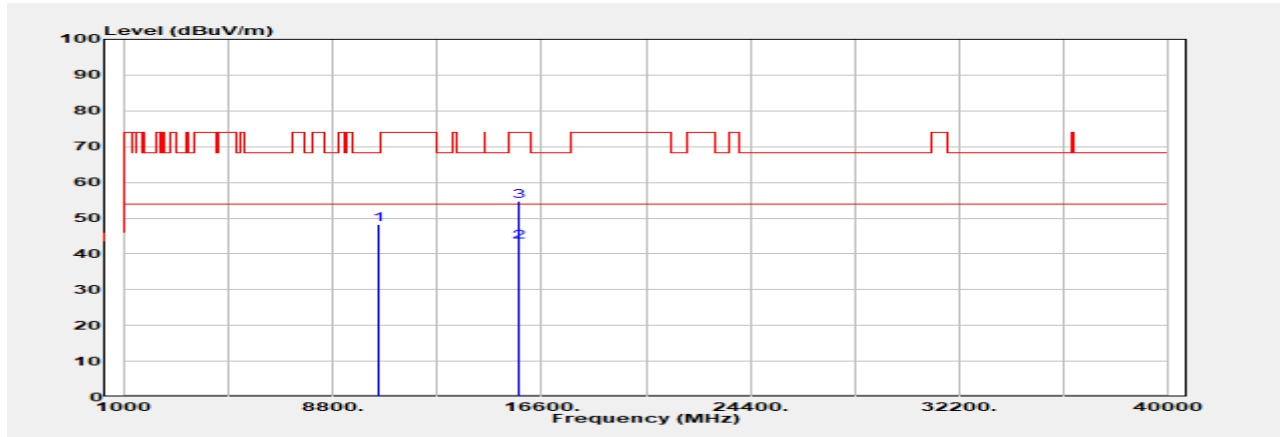

Freq. MHz	Detector Mode PK/QP/AVG	Spectrum Reading Level dB μ V	Factor dB	Actual FS dB μ V/m	Limit @3m dB μ V/m	Margin dB
10500.000	Peak	38.36	9.90	48.26	68.20	-19.94
15750.000	Average	30.92	12.50	43.42	54.00	-10.58
15750.000	Peak	42.34	12.50	54.84	74.00	-19.16

Unless otherwise stated the results shown in this test report refer only to the sample(s) tested and such sample(s) are retained for 90 days only.

除非另有說明，此報告結果僅對測試之樣品負責，同時此樣品僅保留90天。本報告未經本公司書面許可，不可部份複製。

This document is issued by the Company subject to its General Conditions of Service printed overleaf, available on request or accessible at <http://www.sgs.com.tw/Terms-and-Conditions> and for electronic format documents, subject to Terms and Conditions for Electronic Documents at <http://www.sgs.com.tw/Terms-and-Conditions>. Attention is drawn to the limitation of liability, indemnification and jurisdiction issues defined therein. Any holder of this document is advised that information contained hereon reflects the Company's findings at the time of its intervention only and within the limits of Client's instructions, if any. The Company's sole responsibility is to its Client and this document does not exonerate parties to a transaction from exercising all their rights and obligations under the transaction documents. This document cannot be reproduced except in full, without prior written approval of the Company. Any unauthorized alteration, forgery or falsification of the content or appearance of this document is unlawful and offenders may be prosecuted to the fullest extent of the law.

Report Number	:TERF2308001923E2	Test Site	:SAC G Chamber
Operation Mode	:802.11ac160	Test Date	:2023-09-25
Test Frequency	:5570 MHz	Temp./Humi.	:23.4°C/56%
Test Mode	:Tx	Antenna Pol.	:Vertical
EUT Pol	:E2 Plane	Engineer	:Temo Chen

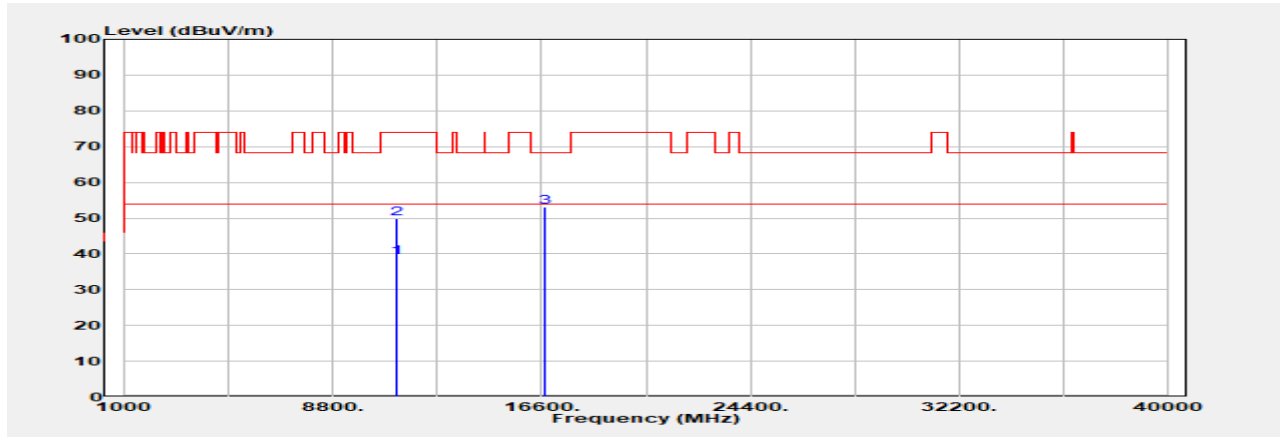

Freq. MHz	Detector Mode PK/QP/AVG	Spectrum Reading Level dBuV	Factor dB	Actual FS dBuV/m	Limit @3m dBuV/m	Margin dB
11140.000	Average	29.10	9.82	38.92	54.00	-15.08
11140.000	Peak	39.94	9.82	49.77	74.00	-24.23
16710.000	Peak	41.36	11.69	53.05	68.20	-15.15

Unless otherwise stated the results shown in this test report refer only to the sample(s) tested and such sample(s) are retained for 90 days only.

除非另有說明，此報告結果僅對測試之樣品負責，同時此樣品僅保留90天。本報告未經本公司書面許可，不可部份複製。

This document is issued by the Company subject to its General Conditions of Service printed overleaf, available on request or accessible at <http://www.sgs.com.tw/Terms-and-Conditions> and for electronic format documents, subject to Terms and Conditions for Electronic Documents at <http://www.sgs.com.tw/Terms-and-Conditions>. Attention is drawn to the limitation of liability, indemnification and jurisdiction issues defined therein. Any holder of this document is advised that information contained hereon reflects the Company's findings at the time of its intervention only and within the limits of Client's instructions, if any. The Company's sole responsibility is to its Client and this document does not exonerate parties to a transaction from exercising all their rights and obligations under the transaction documents. This document cannot be reproduced except in full, without prior written approval of the Company. Any unauthorized alteration, forgery or falsification of the content or appearance of this document is unlawful and offenders may be prosecuted to the fullest extent of the law.

Report Number	:TERF2308001923E2	Test Site	:SAC G Chamber
Operation Mode	:802.11ac160	Test Date	:2023-09-25
Test Frequency	:5570 MHz	Temp./Humi.	:23.4°C/56%
Test Mode	:Tx	Antenna Pol.	:Horizontal
EUT Pol	:E2 Plane	Engineer	:Temo Chen

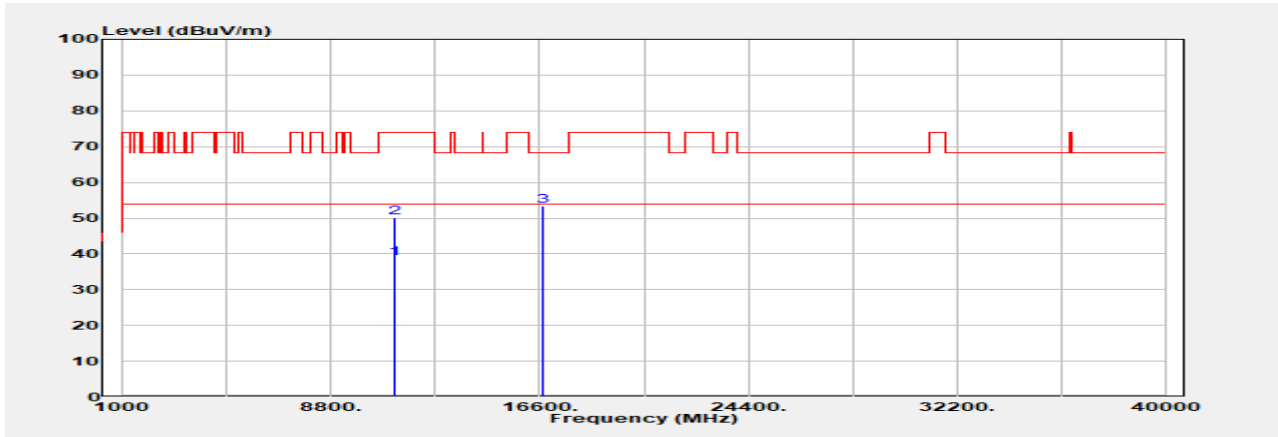

Freq. MHz	Detector Mode PK/QP/AVG	Spectrum Reading Level dB μ V	Factor dB	Actual FS dB μ V/m	Limit @3m dB μ V/m	Margin dB
11140.000	Average	28.99	9.82	38.81	54.00	-15.19
11140.000	Peak	40.33	9.82	50.15	74.00	-23.85
16710.000	Peak	41.69	11.69	53.38	68.20	-14.82

Unless otherwise stated the results shown in this test report refer only to the sample(s) tested and such sample(s) are retained for 90 days only.

除非另有說明，此報告結果僅對測試之樣品負責，同時此樣品僅保留90天。本報告未經本公司書面許可，不可部份複製。

This document is issued by the Company subject to its General Conditions of Service printed overleaf, available on request or accessible at <http://www.sgs.com.tw/Terms-and-Conditions> and for electronic format documents, subject to Terms and Conditions for Electronic Documents at <http://www.sgs.com.tw/Terms-and-Conditions>. Attention is drawn to the limitation of liability, indemnification and jurisdiction issues defined therein. Any holder of this document is advised that information contained hereon reflects the Company's findings at the time of its intervention only and within the limits of Client's instructions, if any. The Company's sole responsibility is to its Client and this document does not exonerate parties to a transaction from exercising all their rights and obligations under the transaction documents. This document cannot be reproduced except in full, without prior written approval of the Company. Any unauthorized alteration, forgery or falsification of the content or appearance of this document is unlawful and offenders may be prosecuted to the fullest extent of the law.

Report Number	:TERF2308001923E2	Test Site	:SAC G Chamber
Operation Mode	:802.11be20	Test Date	:2023-09-21
Test Frequency	:5180 MHz	Temp./Humi.	:21.9°C/65%
Test Mode	:Tx	Antenna Pol.	:Vertical
EUT Pol	:E2 Plane	Engineer	:Temo Chen

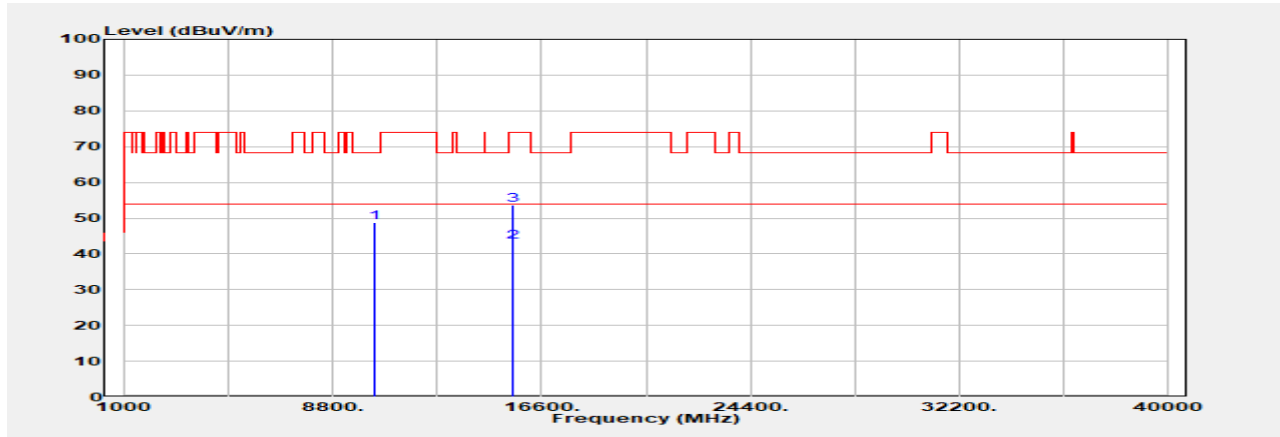

Freq. MHz	Detector Mode PK/QP/AVG	Spectrum Reading Level dB μ V	Factor dB	Actual FS dB μ V/m	Limit @3m dB μ V/m	Margin dB
10360.000	Peak	39.30	9.38	48.68	68.20	-19.52
15540.000	Average	31.34	11.96	43.30	54.00	-10.70
15540.000	Peak	41.62	11.96	53.58	74.00	-20.42

Unless otherwise stated the results shown in this test report refer only to the sample(s) tested and such sample(s) are retained for 90 days only.

除非另有說明，此報告結果僅對測試之樣品負責，同時此樣品僅保留90天。本報告未經本公司書面許可，不可部份複製。

This document is issued by the Company subject to its General Conditions of Service printed overleaf, available on request or accessible at <http://www.sgs.com.tw/Terms-and-Conditions> and for electronic format documents, subject to Terms and Conditions for Electronic Documents at <http://www.sgs.com.tw/Terms-and-Conditions>. Attention is drawn to the limitation of liability, indemnification and jurisdiction issues defined therein. Any holder of this document is advised that information contained hereon reflects the Company's findings at the time of its intervention only and within the limits of Client's instructions, if any. The Company's sole responsibility is to its Client and this document does not exonerate parties to a transaction from exercising all their rights and obligations under the transaction documents. This document cannot be reproduced except in full, without prior written approval of the Company. Any unauthorized alteration, forgery or falsification of the content or appearance of this document is unlawful and offenders may be prosecuted to the fullest extent of the law.

Report Number	:TERF2308001923E2	Test Site	:SAC G Chamber
Operation Mode	:802.11be20	Test Date	:2023-09-21
Test Frequency	:5180 MHz	Temp./Humi.	:21.9°C/65%
Test Mode	:Tx	Antenna Pol.	:Horizontal
EUT Pol	:E2 Plane	Engineer	:Temo Chen

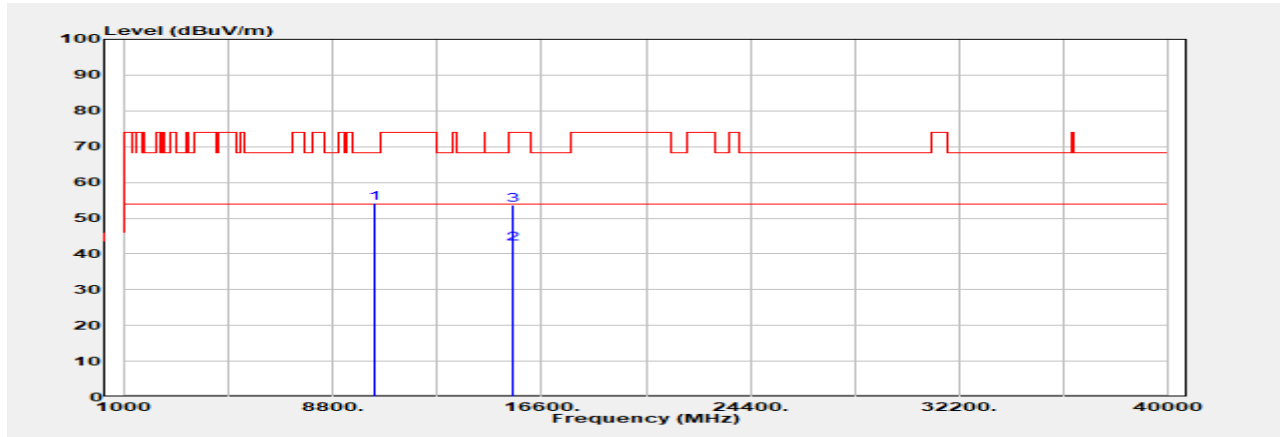

Freq. MHz	Detector Mode PK/QP/AVG	Spectrum Reading Level dB μ V	Factor dB	Actual FS dB μ V/m	Limit @3m dB μ V/m	Margin dB
10360.000	Peak	44.79	9.38	54.17	68.20	-14.03
15540.000	Average	30.88	11.96	42.84	54.00	-11.16
15540.000	Peak	41.70	11.96	53.66	74.00	-20.34

Unless otherwise stated the results shown in this test report refer only to the sample(s) tested and such sample(s) are retained for 90 days only.

除非另有說明，此報告結果僅對測試之樣品負責，同時此樣品僅保留90天。本報告未經本公司書面許可，不可部份複製。

This document is issued by the Company subject to its General Conditions of Service printed overleaf, available on request or accessible at <http://www.sgs.com.tw/Terms-and-Conditions> and for electronic format documents, subject to Terms and Conditions for Electronic Documents at <http://www.sgs.com.tw/Terms-and-Conditions>. Attention is drawn to the limitation of liability, indemnification and jurisdiction issues defined therein. Any holder of this document is advised that information contained hereon reflects the Company's findings at the time of its intervention only and within the limits of Client's instructions, if any. The Company's sole responsibility is to its Client and this document does not exonerate parties to a transaction from exercising all their rights and obligations under the transaction documents. This document cannot be reproduced except in full, without prior written approval of the Company. Any unauthorized alteration, forgery or falsification of the content or appearance of this document is unlawful and offenders may be prosecuted to the fullest extent of the law.

Report Number	:TERF2308001923E2	Test Site	:SAC G Chamber
Operation Mode	:802.11be20	Test Date	:2023-09-21
Test Frequency	:5220 MHz	Temp./Humi.	:21.9°C/65%
Test Mode	:Tx	Antenna Pol.	:Vertical
EUT Pol	:E2 Plane	Engineer	:Temo Chen

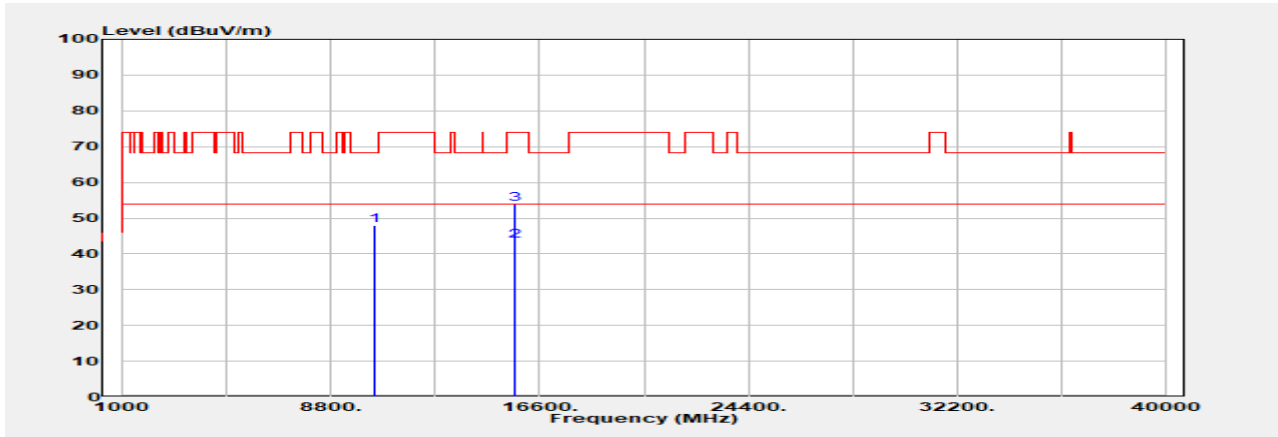

Freq. MHz	Detector Mode PK/QP/AVG	Spectrum Reading Level dB μ V	Factor dB	Actual FS dB μ V/m	Limit @3m dB μ V/m	Margin dB
10440.000	Peak	38.21	9.66	47.87	68.20	-20.33
15660.000	Average	31.27	12.32	43.59	54.00	-10.41
15660.000	Peak	41.67	12.32	53.99	74.00	-20.01

Unless otherwise stated the results shown in this test report refer only to the sample(s) tested and such sample(s) are retained for 90 days only.

除非另有說明，此報告結果僅對測試之樣品負責，同時此樣品僅保留90天。本報告未經本公司書面許可，不可部份複製。

This document is issued by the Company subject to its General Conditions of Service printed overleaf, available on request or accessible at <http://www.sgs.com.tw/Terms-and-Conditions> and for electronic format documents, subject to Terms and Conditions for Electronic Documents at <http://www.sgs.com.tw/Terms-and-Conditions>. Attention is drawn to the limitation of liability, indemnification and jurisdiction issues defined therein. Any holder of this document is advised that information contained hereon reflects the Company's findings at the time of its intervention only and within the limits of Client's instructions, if any. The Company's sole responsibility is to its Client and this document does not exonerate parties to a transaction from exercising all their rights and obligations under the transaction documents. This document cannot be reproduced except in full, without prior written approval of the Company. Any unauthorized alteration, forgery or falsification of the content or appearance of this document is unlawful and offenders may be prosecuted to the fullest extent of the law.

Report Number	:TERF2308001923E2	Test Site	:SAC G Chamber
Operation Mode	:802.11be20	Test Date	:2023-09-21
Test Frequency	:5220 MHz	Temp./Humi.	:21.9°C/65%
Test Mode	:Tx	Antenna Pol.	:Horizontal
EUT Pol	:E2 Plane	Engineer	:Temo Chen

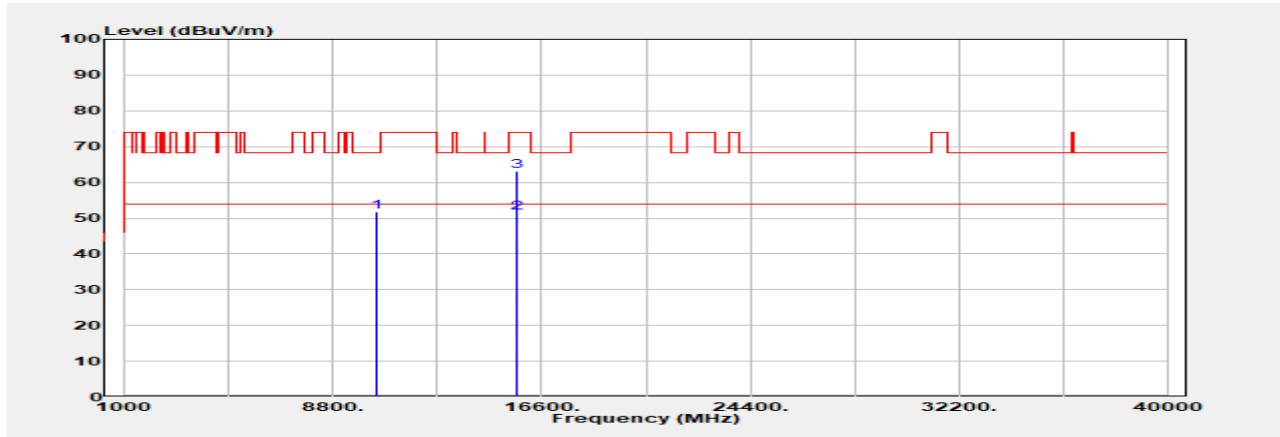

Freq. MHz	Detector Mode PK/QP/AVG	Spectrum Reading Level dBµV	Factor dB	Actual FS dBµV/m	Limit @3m dBµV/m	Margin dB
10440.000	Peak	42.12	9.66	51.78	68.20	-16.42
15660.000	Average	39.17	12.32	51.49	54.00	-2.51
15660.000	Peak	50.85	12.32	63.17	74.00	-10.83

Unless otherwise stated the results shown in this test report refer only to the sample(s) tested and such sample(s) are retained for 90 days only.

除非另有說明，此報告結果僅對測試之樣品負責，同時此樣品僅保留90天。本報告未經本公司書面許可，不可部份複製。

This document is issued by the Company subject to its General Conditions of Service printed overleaf, available on request or accessible at <http://www.sgs.com.tw/Terms-and-Conditions> and for electronic format documents, subject to Terms and Conditions for Electronic Documents at <http://www.sgs.com.tw/Terms-and-Conditions>. Attention is drawn to the limitation of liability, indemnification and jurisdiction issues defined therein. Any holder of this document is advised that information contained hereon reflects the Company's findings at the time of its intervention only and within the limits of Client's instructions, if any. The Company's sole responsibility is to its Client and this document does not exonerate parties to a transaction from exercising all their rights and obligations under the transaction documents. This document cannot be reproduced except in full, without prior written approval of the Company. Any unauthorized alteration, forgery or falsification of the content or appearance of this document is unlawful and offenders may be prosecuted to the fullest extent of the law.

Report Number	:TERF2308001923E2	Test Site	:SAC G Chamber
Operation Mode	:802.11be20	Test Date	:2023-09-21
Test Frequency	:5240 MHz	Temp./Humi.	:21.9°C/65%
Test Mode	:Tx	Antenna Pol.	:Vertical
EUT Pol	:E2 Plane	Engineer	:Temo Chen

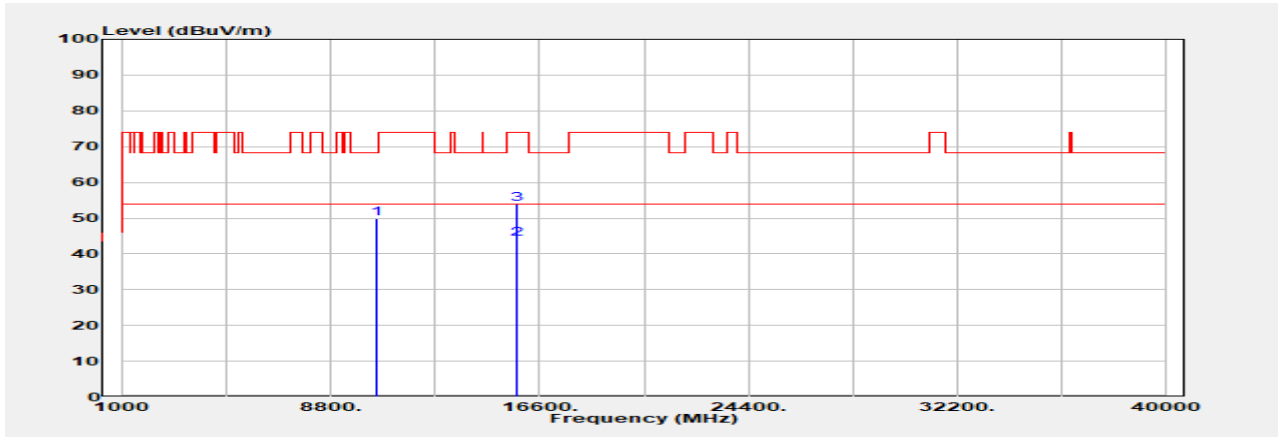

Freq. MHz	Detector Mode	Spectrum Reading Level dB μ V	Factor dB	Actual FS dB μ V/m	Limit @3m dB μ V/m	Margin dB
10480.000	Peak	40.07	9.82	49.89	68.20	-18.31
15720.000	Average	31.55	12.56	44.11	54.00	-9.89
15720.000	Peak	41.38	12.56	53.94	74.00	-20.06

Unless otherwise stated the results shown in this test report refer only to the sample(s) tested and such sample(s) are retained for 90 days only.

除非另有說明，此報告結果僅對測試之樣品負責，同時此樣品僅保留90天。本報告未經本公司書面許可，不可部份複製。

This document is issued by the Company subject to its General Conditions of Service printed overleaf, available on request or accessible at <http://www.sgs.com.tw/Terms-and-Conditions> and for electronic format documents, subject to Terms and Conditions for Electronic Documents at <http://www.sgs.com.tw/Terms-and-Conditions>. Attention is drawn to the limitation of liability, indemnification and jurisdiction issues defined therein. Any holder of this document is advised that information contained hereon reflects the Company's findings at the time of its intervention only and within the limits of Client's instructions, if any. The Company's sole responsibility is to its Client and this document does not exonerate parties to a transaction from exercising all their rights and obligations under the transaction documents. This document cannot be reproduced except in full, without prior written approval of the Company. Any unauthorized alteration, forgery or falsification of the content or appearance of this document is unlawful and offenders may be prosecuted to the fullest extent of the law.

Report Number	:TERF2308001923E2	Test Site	:SAC G Chamber
Operation Mode	:802.11be20	Test Date	:2023-09-21
Test Frequency	:5240 MHz	Temp./Humi.	:21.9°C/65%
Test Mode	:Tx	Antenna Pol.	:Horizontal
EUT Pol	:E2 Plane	Engineer	:Temo Chen

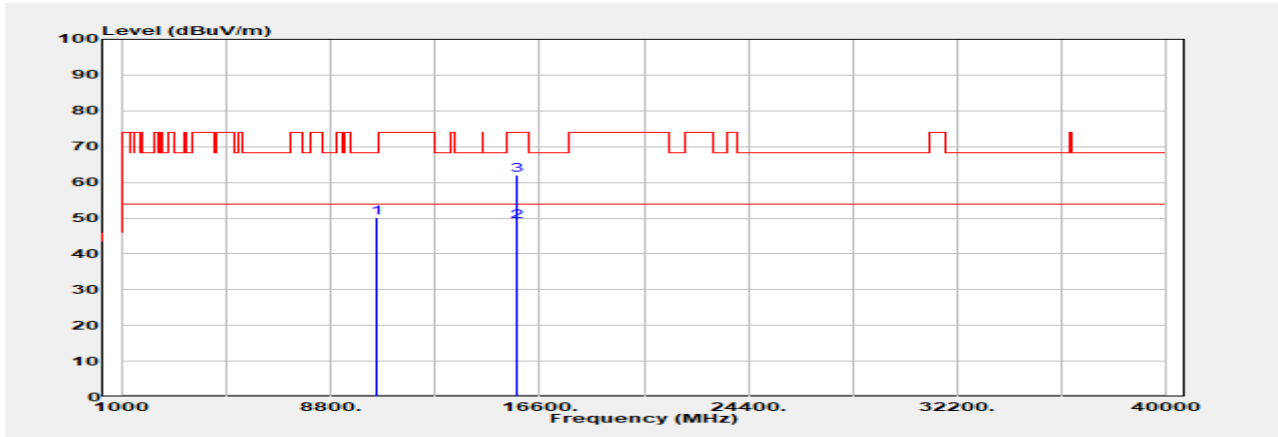

Freq. MHz	Detector Mode PK/QP/AVG	Spectrum Reading Level dBµV	Factor dB	Actual FS dBµV/m	Limit @3m dBµV/m	Margin dB
10480.000	Peak	40.39	9.82	50.21	68.20	-17.99
15720.000	Average	36.41	12.56	48.97	54.00	-5.03
15720.000	Peak	49.38	12.56	61.94	74.00	-12.06

Unless otherwise stated the results shown in this test report refer only to the sample(s) tested and such sample(s) are retained for 90 days only.

除非另有說明，此報告結果僅對測試之樣品負責，同時此樣品僅保留90天。本報告未經本公司書面許可，不可部份複製。

This document is issued by the Company subject to its General Conditions of Service printed overleaf, available on request or accessible at <http://www.sgs.com.tw/Terms-and-Conditions> and for electronic format documents, subject to Terms and Conditions for Electronic Documents at <http://www.sgs.com.tw/Terms-and-Conditions>. Attention is drawn to the limitation of liability, indemnification and jurisdiction issues defined therein. Any holder of this document is advised that information contained hereon reflects the Company's findings at the time of its intervention only and within the limits of Client's instructions, if any. The Company's sole responsibility is to its Client and this document does not exonerate parties to a transaction from exercising all their rights and obligations under the transaction documents. This document cannot be reproduced except in full, without prior written approval of the Company. Any unauthorized alteration, forgery or falsification of the content or appearance of this document is unlawful and offenders may be prosecuted to the fullest extent of the law.

Report Number	:TERF2308001923E2	Test Site	:SAC G Chamber
Operation Mode	:802.11be20	Test Date	:2023-09-21
Test Frequency	:5260 MHz	Temp./Humi.	:21.9°C/65%
Test Mode	:Tx	Antenna Pol.	:Vertical
EUT Pol	:E2 Plane	Engineer	:Temo Chen

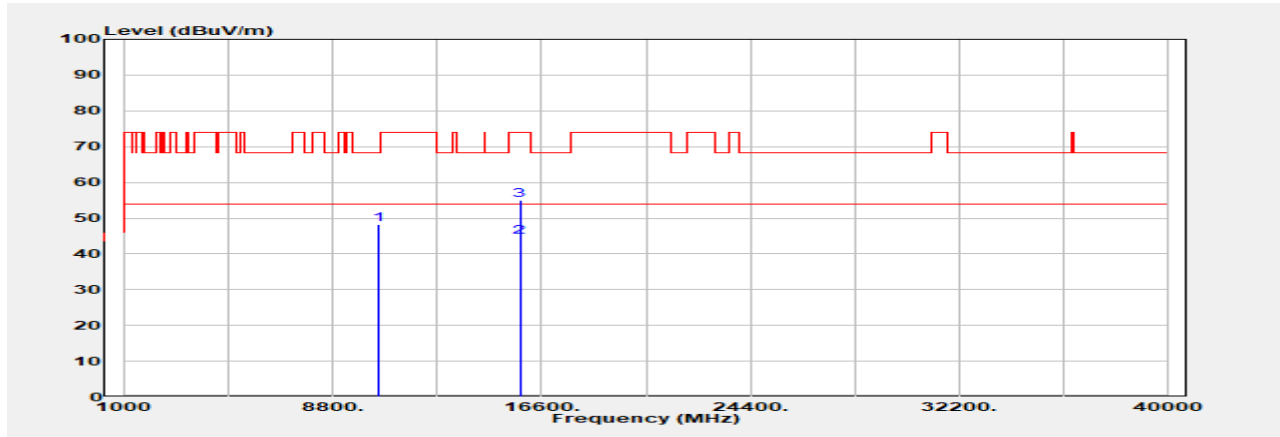

Freq. MHz	Detector Mode PK/QP/AVG	Spectrum Reading Level dB μ V	Factor dB	Actual FS dB μ V/m	Limit @3m dB μ V/m	Margin dB
10520.000	Peak	38.41	9.92	48.33	68.20	-19.87
15780.000	Average	32.41	12.44	44.85	54.00	-9.15
15780.000	Peak	42.49	12.44	54.93	74.00	-19.07

Unless otherwise stated the results shown in this test report refer only to the sample(s) tested and such sample(s) are retained for 90 days only.

除非另有說明，此報告結果僅對測試之樣品負責，同時此樣品僅保留90天。本報告未經本公司書面許可，不可部份複製。

This document is issued by the Company subject to its General Conditions of Service printed overleaf, available on request or accessible at <http://www.sgs.com.tw/Terms-and-Conditions> and for electronic format documents, subject to Terms and Conditions for Electronic Documents at <http://www.sgs.com.tw/Terms-and-Conditions>. Attention is drawn to the limitation of liability, indemnification and jurisdiction issues defined therein. Any holder of this document is advised that information contained hereon reflects the Company's findings at the time of its intervention only and within the limits of Client's instructions, if any. The Company's sole responsibility is to its Client and this document does not exonerate parties to a transaction from exercising all their rights and obligations under the transaction documents. This document cannot be reproduced except in full, without prior written approval of the Company. Any unauthorized alteration, forgery or falsification of the content or appearance of this document is unlawful and offenders may be prosecuted to the fullest extent of the law.

Report Number	:TERF2308001923E2	Test Site	:SAC G Chamber
Operation Mode	:802.11be20	Test Date	:2023-09-21
Test Frequency	:5260 MHz	Temp./Humi.	:21.9°C/65%
Test Mode	:Tx	Antenna Pol.	:Horizontal
EUT Pol	:E2 Plane	Engineer	:Temo Chen

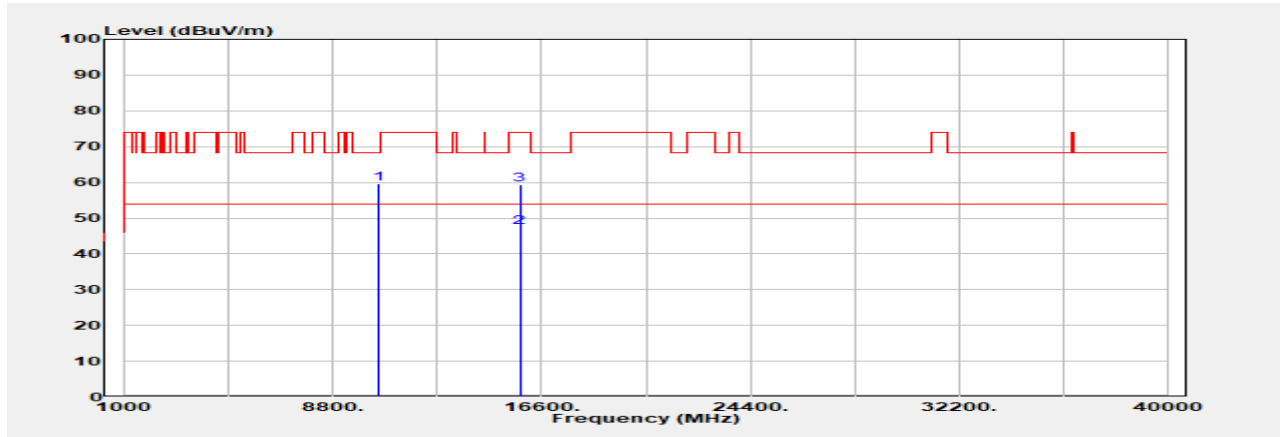

Freq. MHz	Detector Mode PK/QP/AVG	Spectrum Reading Level dB μ V	Factor dB	Actual FS dB μ V/m	Limit @3m dB μ V/m	Margin dB
10520.000	Peak	49.62	9.92	59.54	68.20	-8.66
15780.000	Average	35.02	12.44	47.46	54.00	-6.54
15780.000	Peak	46.96	12.44	59.40	74.00	-14.60

Unless otherwise stated the results shown in this test report refer only to the sample(s) tested and such sample(s) are retained for 90 days only.

除非另有說明，此報告結果僅對測試之樣品負責，同時此樣品僅保留90天。本報告未經本公司書面許可，不可部份複製。

This document is issued by the Company subject to its General Conditions of Service printed overleaf, available on request or accessible at <http://www.sgs.com.tw/Terms-and-Conditions> and for electronic format documents, subject to Terms and Conditions for Electronic Documents at <http://www.sgs.com.tw/Terms-and-Conditions>. Attention is drawn to the limitation of liability, indemnification and jurisdiction issues defined therein. Any holder of this document is advised that information contained hereon reflects the Company's findings at the time of its intervention only and within the limits of Client's instructions, if any. The Company's sole responsibility is to its Client and this document does not exonerate parties to a transaction from exercising all their rights and obligations under the transaction documents. This document cannot be reproduced except in full, without prior written approval of the Company. Any unauthorized alteration, forgery or falsification of the content or appearance of this document is unlawful and offenders may be prosecuted to the fullest extent of the law.

Report Number	:TERF2308001923E2	Test Site	:SAC G Chamber
Operation Mode	:802.11be20	Test Date	:2023-09-21
Test Frequency	:5280 MHz	Temp./Humi.	:21.9°C/65%
Test Mode	:Tx	Antenna Pol.	:Vertical
EUT Pol	:E2 Plane	Engineer	:Temo Chen

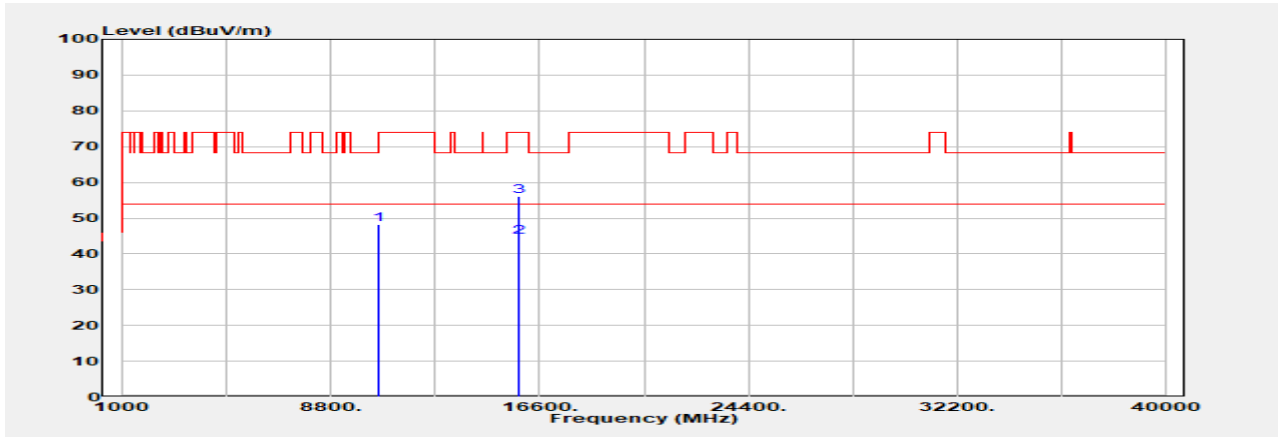

Freq. MHz	Detector Mode PK/QP/AVG	Spectrum Reading Level dBµV	Factor dB	Actual FS dBµV/m	Limit @3m dBµV/m	Margin dB
10560.000	Peak	38.33	9.96	48.29	68.20	-19.91
15840.000	Average	32.27	12.32	44.59	54.00	-9.41
15840.000	Peak	43.82	12.32	56.14	74.00	-17.86

Unless otherwise stated the results shown in this test report refer only to the sample(s) tested and such sample(s) are retained for 90 days only.

除非另有說明，此報告結果僅對測試之樣品負責，同時此樣品僅保留90天。本報告未經本公司書面許可，不可部份複製。

This document is issued by the Company subject to its General Conditions of Service printed overleaf, available on request or accessible at <http://www.sgs.com.tw/Terms-and-Conditions> and for electronic format documents, subject to Terms and Conditions for Electronic Documents at <http://www.sgs.com.tw/Terms-and-Conditions>. Attention is drawn to the limitation of liability, indemnification and jurisdiction issues defined therein. Any holder of this document is advised that information contained hereon reflects the Company's findings at the time of its intervention only and within the limits of Client's instructions, if any. The Company's sole responsibility is to its Client and this document does not exonerate parties to a transaction from exercising all their rights and obligations under the transaction documents. This document cannot be reproduced except in full, without prior written approval of the Company. Any unauthorized alteration, forgery or falsification of the content or appearance of this document is unlawful and offenders may be prosecuted to the fullest extent of the law.

Report Number	:TERF2308001923E2	Test Site	:SAC G Chamber
Operation Mode	:802.11be20	Test Date	:2023-09-21
Test Frequency	:5280 MHz	Temp./Humi.	:21.9°C/65%
Test Mode	:Tx	Antenna Pol.	:Horizontal
EUT Pol	:E2 Plane	Engineer	:Temo Chen

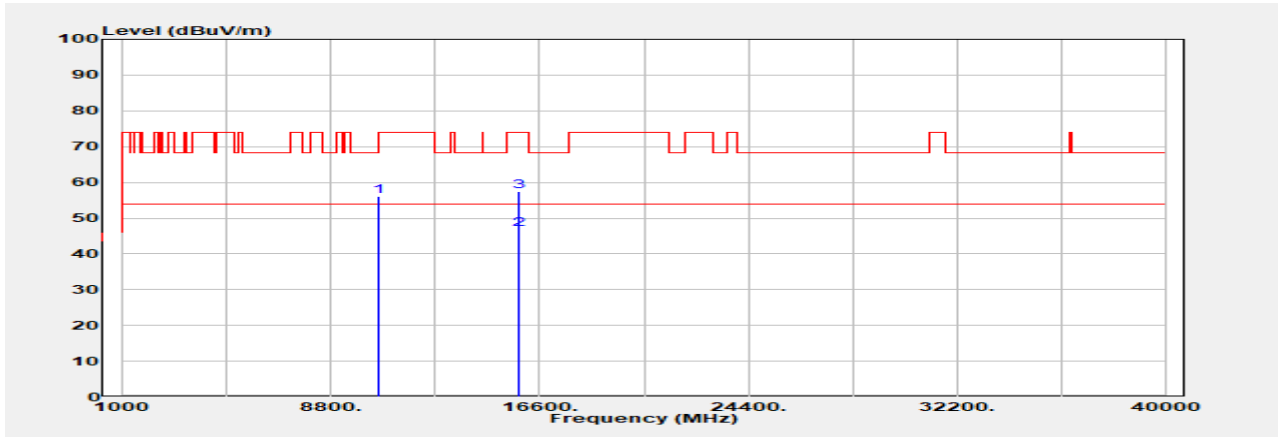

Freq. MHz	Detector Mode	Spectrum Reading Level dB μ V	Factor dB	Actual FS dB μ V/m	Limit @3m dB μ V/m	Margin dB
10560.000	Peak	46.13	9.96	56.09	68.20	-12.11
15840.000	Average	34.57	12.32	46.89	54.00	-7.11
15840.000	Peak	45.23	12.32	57.55	74.00	-16.45

Unless otherwise stated the results shown in this test report refer only to the sample(s) tested and such sample(s) are retained for 90 days only.

除非另有說明，此報告結果僅對測試之樣品負責，同時此樣品僅保留90天。本報告未經本公司書面許可，不可部份複製。

This document is issued by the Company subject to its General Conditions of Service printed overleaf, available on request or accessible at <http://www.sgs.com.tw/Terms-and-Conditions> and for electronic format documents, subject to Terms and Conditions for Electronic Documents at <http://www.sgs.com.tw/Terms-and-Conditions>. Attention is drawn to the limitation of liability, indemnification and jurisdiction issues defined therein. Any holder of this document is advised that information contained hereon reflects the Company's findings at the time of its intervention only and within the limits of Client's instructions, if any. The Company's sole responsibility is to its Client and this document does not exonerate parties to a transaction from exercising all their rights and obligations under the transaction documents. This document cannot be reproduced except in full, without prior written approval of the Company. Any unauthorized alteration, forgery or falsification of the content or appearance of this document is unlawful and offenders may be prosecuted to the fullest extent of the law.

Report Number	:TERF2308001923E2	Test Site	:SAC G Chamber
Operation Mode	:802.11be20	Test Date	:2023-09-21
Test Frequency	:5320 MHz	Temp./Humi.	:21.9°C/65%
Test Mode	:Tx	Antenna Pol.	:Vertical
EUT Pol	:E2 Plane	Engineer	:Temo Chen

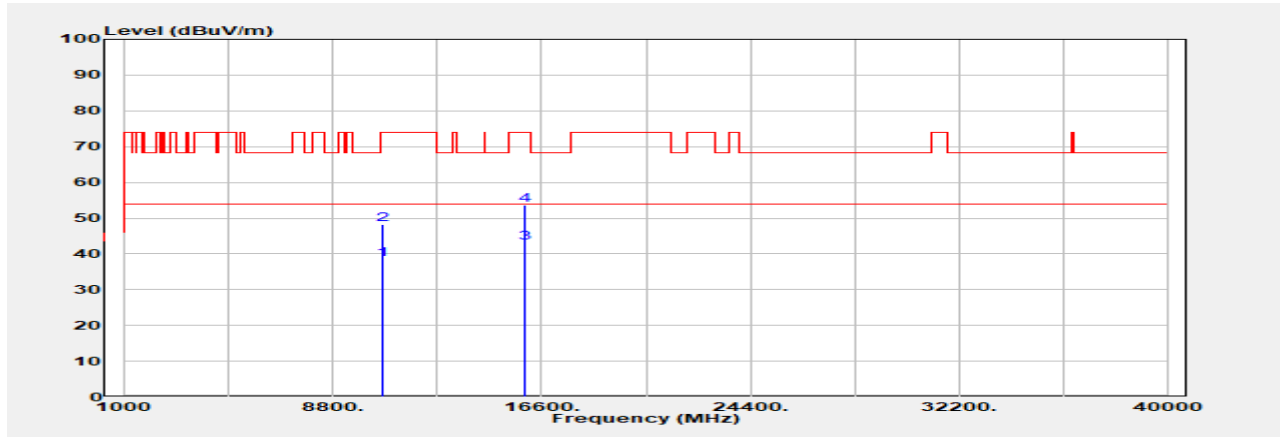

Freq. MHz	Detector Mode PK/QP/AVG	Spectrum Reading Level dB μ V	Factor dB	Actual FS dB μ V/m	Limit @3m dB μ V/m	Margin dB
10640.000	Average	28.75	9.72	38.47	54.00	-15.53
10640.000	Peak	38.59	9.72	48.31	74.00	-25.69
15960.000	Average	31.22	11.90	43.12	54.00	-10.88
15960.000	Peak	41.76	11.90	53.66	74.00	-20.34

Unless otherwise stated the results shown in this test report refer only to the sample(s) tested and such sample(s) are retained for 90 days only.

除非另有說明，此報告結果僅對測試之樣品負責，同時此樣品僅保留90天。本報告未經本公司書面許可，不可部份複製。

This document is issued by the Company subject to its General Conditions of Service printed overleaf, available on request or accessible at <http://www.sgs.com.tw/Terms-and-Conditions> and for electronic format documents, subject to Terms and Conditions for Electronic Documents at <http://www.sgs.com.tw/Terms-and-Conditions>. Attention is drawn to the limitation of liability, indemnification and jurisdiction issues defined therein. Any holder of this document is advised that information contained hereon reflects the Company's findings at the time of its intervention only and within the limits of Client's instructions, if any. The Company's sole responsibility is to its Client and this document does not exonerate parties to a transaction from exercising all their rights and obligations under the transaction documents. This document cannot be reproduced except in full, without prior written approval of the Company. Any unauthorized alteration, forgery or falsification of the content or appearance of this document is unlawful and offenders may be prosecuted to the fullest extent of the law.

Report Number	:TERF2308001923E2	Test Site	:SAC G Chamber
Operation Mode	:802.11be20	Test Date	:2023-09-21
Test Frequency	:5320 MHz	Temp./Humi.	:21.9°C/65%
Test Mode	:Tx	Antenna Pol.	:Horizontal
EUT Pol	:E2 Plane	Engineer	:Temo Chen

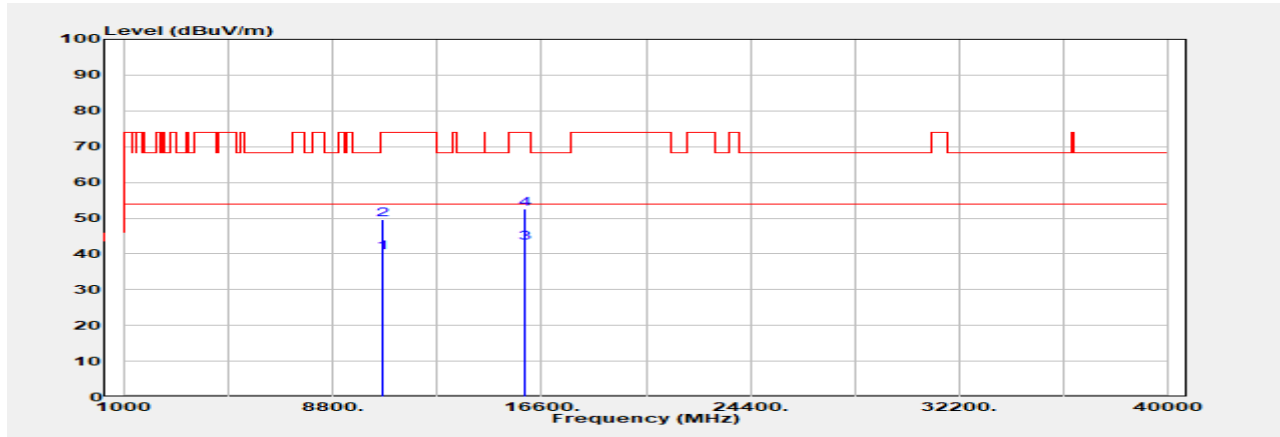

Freq. MHz	Detector Mode PK/QP/AVG	Spectrum Reading Level dB μ V	Factor dB	Actual FS dB μ V/m	Limit @3m dB μ V/m	Margin dB
10640.000	Average	30.76	9.72	40.48	54.00	-13.52
10640.000	Peak	39.75	9.72	49.47	74.00	-24.53
15960.000	Average	31.22	11.90	43.12	54.00	-10.88
15960.000	Peak	40.77	11.90	52.67	74.00	-21.33

Unless otherwise stated the results shown in this test report refer only to the sample(s) tested and such sample(s) are retained for 90 days only.

除非另有說明，此報告結果僅對測試之樣品負責，同時此樣品僅保留90天。本報告未經本公司書面許可，不可部份複製。

This document is issued by the Company subject to its General Conditions of Service printed overleaf, available on request or accessible at <http://www.sgs.com.tw/Terms-and-Conditions> and for electronic format documents, subject to Terms and Conditions for Electronic Documents at <http://www.sgs.com.tw/Terms-and-Conditions>. Attention is drawn to the limitation of liability, indemnification and jurisdiction issues defined therein. Any holder of this document is advised that information contained hereon reflects the Company's findings at the time of its intervention only and within the limits of Client's instructions, if any. The Company's sole responsibility is to its Client and this document does not exonerate parties to a transaction from exercising all their rights and obligations under the transaction documents. This document cannot be reproduced except in full, without prior written approval of the Company. Any unauthorized alteration, forgery or falsification of the content or appearance of this document is unlawful and offenders may be prosecuted to the fullest extent of the law.

Report Number	:TERF2308001923E2	Test Site	:SAC G Chamber
Operation Mode	:802.11be20	Test Date	:2023-09-21
Test Frequency	:5500 MHz	Temp./Humi.	:21.9°C/65%
Test Mode	:Tx	Antenna Pol.	:Vertical
EUT Pol	:E2 Plane	Engineer	:Temo Chen

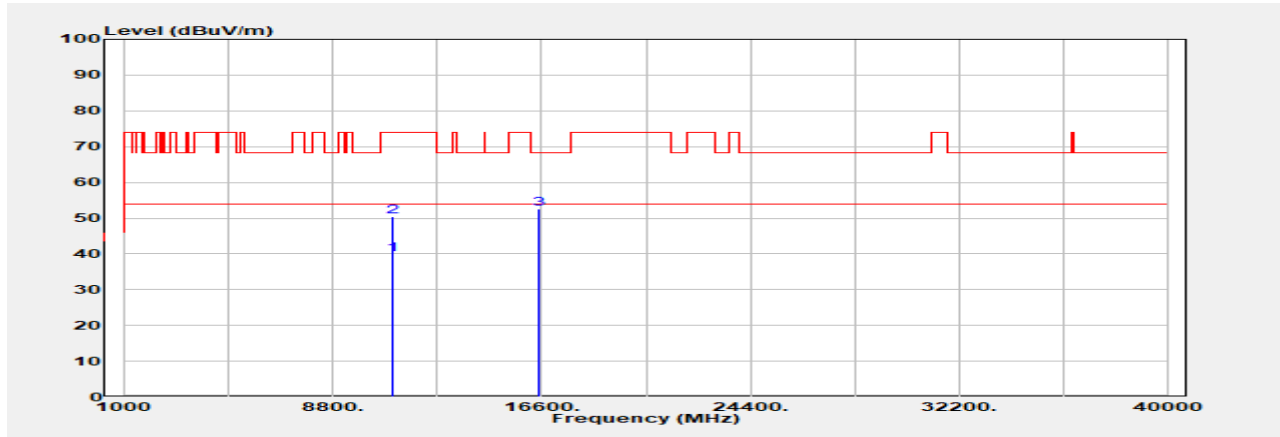

Freq. MHz	Detector Mode PK/QP/AVG	Spectrum Reading Level dB μ V	Factor dB	Actual FS dB μ V/m	Limit @3m dB μ V/m	Margin dB
11000.000	Average	28.06	11.90	39.96	54.00	-14.04
11000.000	Peak	38.60	11.90	50.50	74.00	-23.50
16500.000	Peak	40.58	12.00	52.58	68.20	-15.62

Unless otherwise stated the results shown in this test report refer only to the sample(s) tested and such sample(s) are retained for 90 days only.

除非另有說明，此報告結果僅對測試之樣品負責，同時此樣品僅保留90天。本報告未經本公司書面許可，不可部份複製。

This document is issued by the Company subject to its General Conditions of Service printed overleaf, available on request or accessible at <http://www.sgs.com.tw/Terms-and-Conditions> and for electronic format documents, subject to Terms and Conditions for Electronic Documents at <http://www.sgs.com.tw/Terms-and-Conditions>. Attention is drawn to the limitation of liability, indemnification and jurisdiction issues defined therein. Any holder of this document is advised that information contained hereon reflects the Company's findings at the time of its intervention only and within the limits of Client's instructions, if any. The Company's sole responsibility is to its Client and this document does not exonerate parties to a transaction from exercising all their rights and obligations under the transaction documents. This document cannot be reproduced except in full, without prior written approval of the Company. Any unauthorized alteration, forgery or falsification of the content or appearance of this document is unlawful and offenders may be prosecuted to the fullest extent of the law.

Report Number	:TERF2308001923E2	Test Site	:SAC G Chamber
Operation Mode	:802.11be20	Test Date	:2023-09-21
Test Frequency	:5500 MHz	Temp./Humi.	:21.9°C/65%
Test Mode	:Tx	Antenna Pol.	:Horizontal
EUT Pol	:E2 Plane	Engineer	:Temo Chen

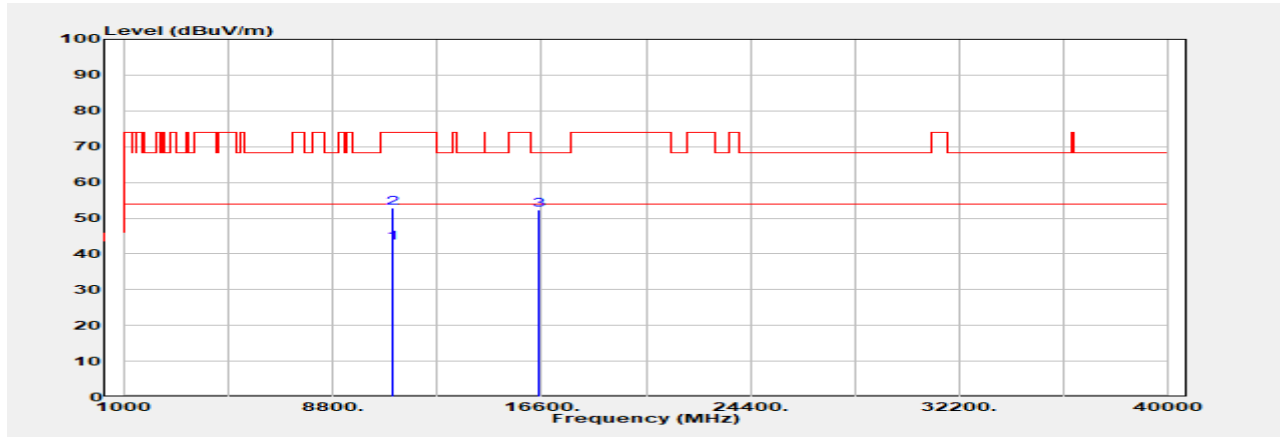

Freq. MHz	Detector Mode PK/QP/AVG	Spectrum Reading Level dB μ V	Factor dB	Actual FS dB μ V/m	Limit @3m dB μ V/m	Margin dB
11000.000	Average	31.19	11.90	43.09	54.00	-10.91
11000.000	Peak	41.07	11.90	52.97	74.00	-21.03
16500.000	Peak	40.37	12.00	52.37	68.20	-15.83

Unless otherwise stated the results shown in this test report refer only to the sample(s) tested and such sample(s) are retained for 90 days only.

除非另有說明，此報告結果僅對測試之樣品負責，同時此樣品僅保留90天。本報告未經本公司書面許可，不可部份複製。

This document is issued by the Company subject to its General Conditions of Service printed overleaf, available on request or accessible at <http://www.sgs.com.tw/Terms-and-Conditions> and for electronic format documents, subject to Terms and Conditions for Electronic Documents at <http://www.sgs.com.tw/Terms-and-Conditions>. Attention is drawn to the limitation of liability, indemnification and jurisdiction issues defined therein. Any holder of this document is advised that information contained hereon reflects the Company's findings at the time of its intervention only and within the limits of Client's instructions, if any. The Company's sole responsibility is to its Client and this document does not exonerate parties to a transaction from exercising all their rights and obligations under the transaction documents. This document cannot be reproduced except in full, without prior written approval of the Company. Any unauthorized alteration, forgery or falsification of the content or appearance of this document is unlawful and offenders may be prosecuted to the fullest extent of the law.

Report Number	:TERF2308001923E2	Test Site	:SAC G Chamber
Operation Mode	:802.11be20	Test Date	:2023-09-21
Test Frequency	:5580 MHz	Temp./Humi.	:21.9°C/65%
Test Mode	:Tx	Antenna Pol.	:Vertical
EUT Pol	:E2 Plane	Engineer	:Temo Chen

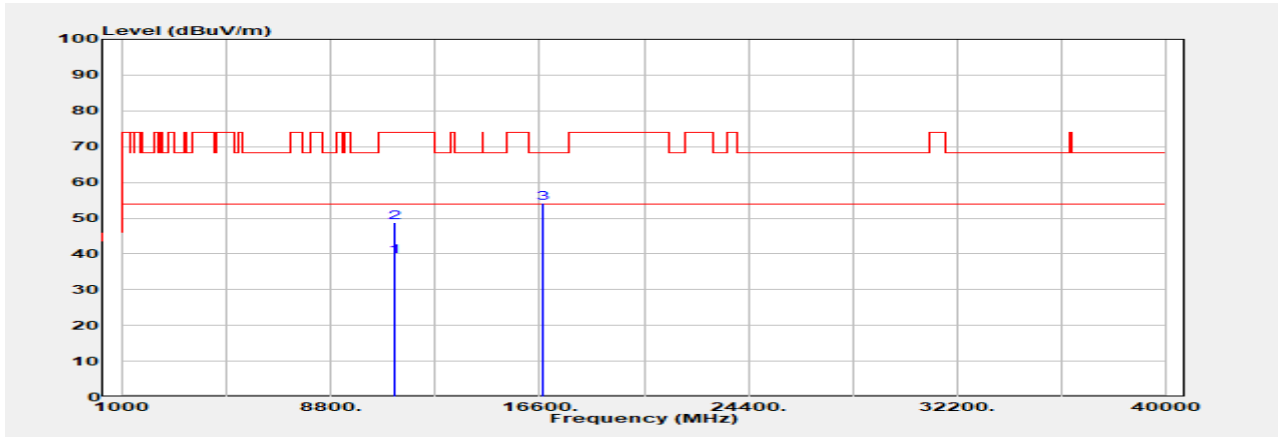

Freq. MHz	Detector Mode PK/QP/AVG	Spectrum Reading Level dBµV	Factor dB	Actual FS dBµV/m	Limit @3m dBµV/m	Margin dB
11160.000	Average	29.31	9.88	39.19	54.00	-14.81
11160.000	Peak	38.99	9.88	48.87	74.00	-25.13
16740.000	Peak	42.53	11.66	54.19	68.20	-14.01

Unless otherwise stated the results shown in this test report refer only to the sample(s) tested and such sample(s) are retained for 90 days only.

除非另有說明，此報告結果僅對測試之樣品負責，同時此樣品僅保留90天。本報告未經本公司書面許可，不可部份複製。

This document is issued by the Company subject to its General Conditions of Service printed overleaf, available on request or accessible at <http://www.sgs.com.tw/Terms-and-Conditions> and for electronic format documents, subject to Terms and Conditions for Electronic Documents at <http://www.sgs.com.tw/Terms-and-Conditions>. Attention is drawn to the limitation of liability, indemnification and jurisdiction issues defined therein. Any holder of this document is advised that information contained hereon reflects the Company's findings at the time of its intervention only and within the limits of Client's instructions, if any. The Company's sole responsibility is to its Client and this document does not exonerate parties to a transaction from exercising all their rights and obligations under the transaction documents. This document cannot be reproduced except in full, without prior written approval of the Company. Any unauthorized alteration, forgery or falsification of the content or appearance of this document is unlawful and offenders may be prosecuted to the fullest extent of the law.

Report Number	:TERF2308001923E2	Test Site	:SAC G Chamber
Operation Mode	:802.11be20	Test Date	:2023-09-21
Test Frequency	:5580 MHz	Temp./Humi.	:21.9°C/65%
Test Mode	:Tx	Antenna Pol.	:Horizontal
EUT Pol	:E2 Plane	Engineer	:Temo Chen

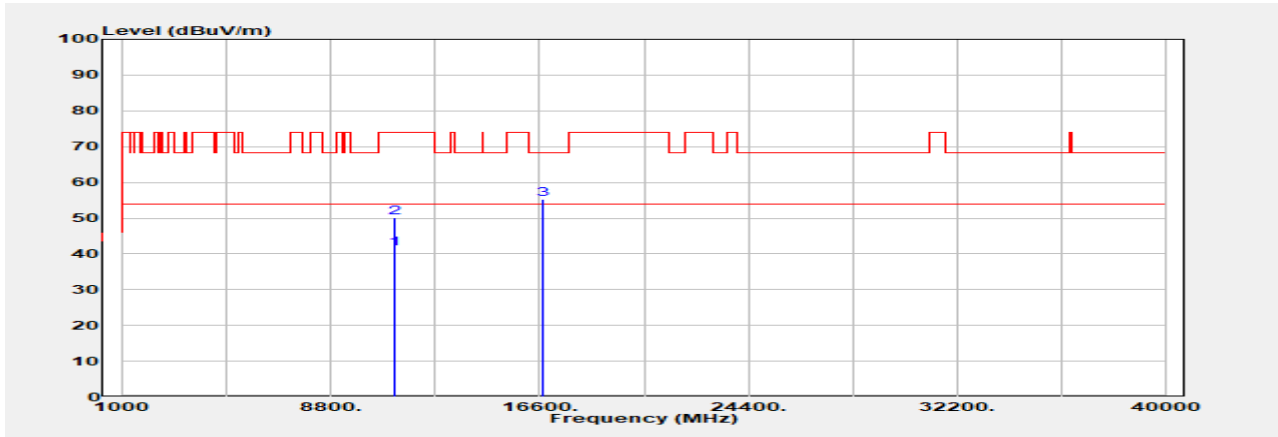

Freq. MHz	Detector Mode PK/QP/AVG	Spectrum Reading Level dBµV	Factor dB	Actual FS dBµV/m	Limit @3m dBµV/m	Margin dB
11160.000	Average	31.68	9.88	41.56	54.00	-12.44
11160.000	Peak	40.37	9.88	50.25	74.00	-23.75
16740.000	Peak	43.68	11.66	55.34	68.20	-12.86

Unless otherwise stated the results shown in this test report refer only to the sample(s) tested and such sample(s) are retained for 90 days only.

除非另有說明，此報告結果僅對測試之樣品負責，同時此樣品僅保留90天。本報告未經本公司書面許可，不可部份複製。

This document is issued by the Company subject to its General Conditions of Service printed overleaf, available on request or accessible at <http://www.sgs.com.tw/Terms-and-Conditions> and for electronic format documents, subject to Terms and Conditions for Electronic Documents at <http://www.sgs.com.tw/Terms-and-Conditions>. Attention is drawn to the limitation of liability, indemnification and jurisdiction issues defined therein. Any holder of this document is advised that information contained hereon reflects the Company's findings at the time of its intervention only and within the limits of Client's instructions, if any. The Company's sole responsibility is to its Client and this document does not exonerate parties to a transaction from exercising all their rights and obligations under the transaction documents. This document cannot be reproduced except in full, without prior written approval of the Company. Any unauthorized alteration, forgery or falsification of the content or appearance of this document is unlawful and offenders may be prosecuted to the fullest extent of the law.

Report Number	:TERF2308001923E2	Test Site	:SAC G Chamber
Operation Mode	:802.11be20	Test Date	:2023-09-21
Test Frequency	:5700 MHz	Temp./Humi.	:21.9°C/65%
Test Mode	:Tx	Antenna Pol.	:Vertical
EUT Pol	:E2 Plane	Engineer	:Temo Chen

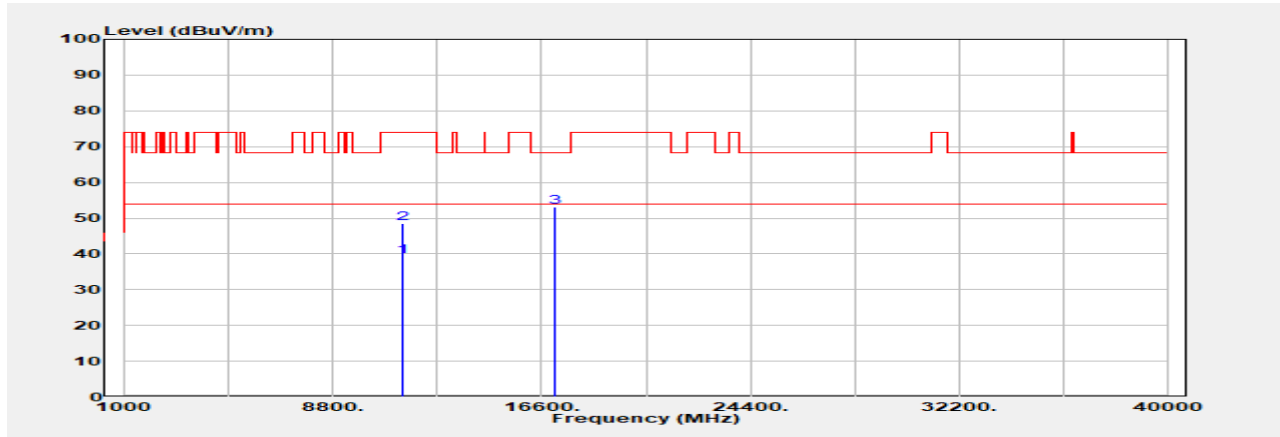

Freq. MHz	Detector Mode PK/QP/AVG	Spectrum Reading Level dBuV	Factor dB	Actual FS dBuV/m	Limit @3m dBuV/m	Margin dB
11400.000	Average	29.63	9.80	39.43	54.00	-14.57
11400.000	Peak	38.75	9.80	48.55	74.00	-25.45
17100.000	Peak	40.88	12.20	53.08	68.20	-15.12

Unless otherwise stated the results shown in this test report refer only to the sample(s) tested and such sample(s) are retained for 90 days only.

除非另有說明，此報告結果僅對測試之樣品負責，同時此樣品僅保留90天。本報告未經本公司書面許可，不可部份複製。

This document is issued by the Company subject to its General Conditions of Service printed overleaf, available on request or accessible at <http://www.sgs.com.tw/Terms-and-Conditions> and for electronic format documents, subject to Terms and Conditions for Electronic Documents at <http://www.sgs.com.tw/Terms-and-Conditions>. Attention is drawn to the limitation of liability, indemnification and jurisdiction issues defined therein. Any holder of this document is advised that information contained hereon reflects the Company's findings at the time of its intervention only and within the limits of Client's instructions, if any. The Company's sole responsibility is to its Client and this document does not exonerate parties to a transaction from exercising all their rights and obligations under the transaction documents. This document cannot be reproduced except in full, without prior written approval of the Company. Any unauthorized alteration, forgery or falsification of the content or appearance of this document is unlawful and offenders may be prosecuted to the fullest extent of the law.

Report Number	:TERF2308001923E2	Test Site	:SAC G Chamber
Operation Mode	:802.11be20	Test Date	:2023-09-21
Test Frequency	:5700 MHz	Temp./Humi.	:21.9°C/65%
Test Mode	:Tx	Antenna Pol.	:Horizontal
EUT Pol	:E2 Plane	Engineer	:Temo Chen

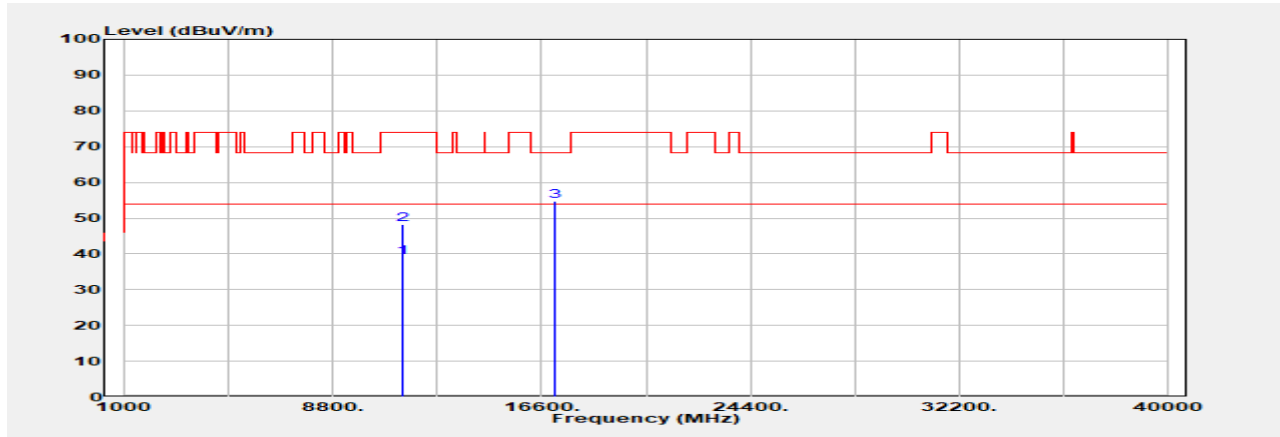

Freq. MHz	Detector Mode PK/QP/AVG	Spectrum Reading Level dBuV	Factor dB	Actual FS dBuV/m	Limit @3m dBuV/m	Margin dB
11400.000	Average	29.32	9.80	39.12	54.00	-14.88
11400.000	Peak	38.33	9.80	48.13	74.00	-25.87
17100.000	Peak	42.55	12.20	54.75	68.20	-13.45

Unless otherwise stated the results shown in this test report refer only to the sample(s) tested and such sample(s) are retained for 90 days only.

除非另有說明，此報告結果僅對測試之樣品負責，同時此樣品僅保留90天。本報告未經本公司書面許可，不可部份複製。

This document is issued by the Company subject to its General Conditions of Service printed overleaf, available on request or accessible at <http://www.sgs.com.tw/Terms-and-Conditions> and for electronic format documents, subject to Terms and Conditions for Electronic Documents at <http://www.sgs.com.tw/Terms-and-Conditions>. Attention is drawn to the limitation of liability, indemnification and jurisdiction issues defined therein. Any holder of this document is advised that information contained hereon reflects the Company's findings at the time of its intervention only and within the limits of Client's instructions, if any. The Company's sole responsibility is to its Client and this document does not exonerate parties to a transaction from exercising all their rights and obligations under the transaction documents. This document cannot be reproduced except in full, without prior written approval of the Company. Any unauthorized alteration, forgery or falsification of the content or appearance of this document is unlawful and offenders may be prosecuted to the fullest extent of the law.

Report Number	:TERF2308001923E2	Test Site	:SAC G Chamber
Operation Mode	:802.11be20	Test Date	:2023-09-21
Test Frequency	:5745 MHz	Temp./Humi.	:21.9°C/65%
Test Mode	:Tx	Antenna Pol.	:Vertical
EUT Pol	:E2 Plane	Engineer	:Temo Chen

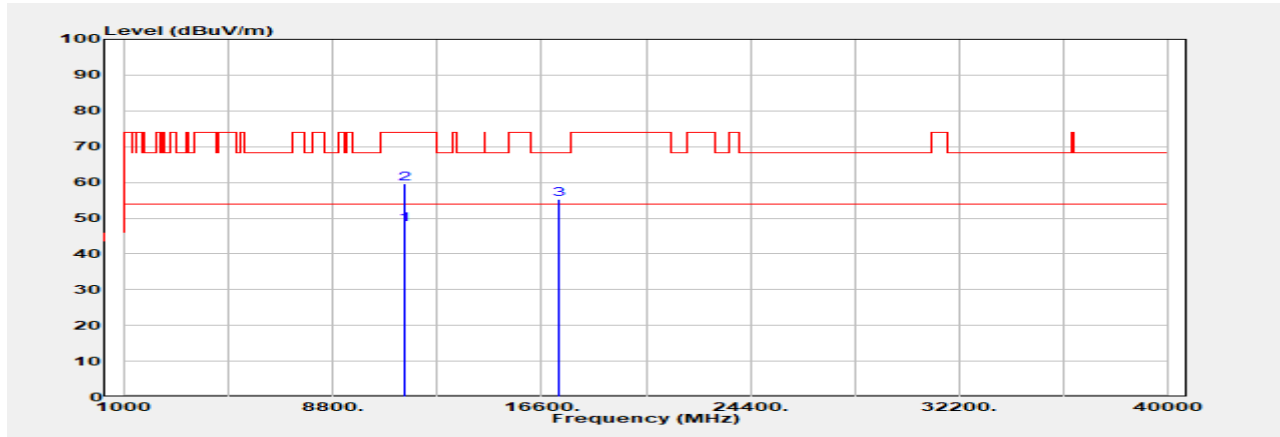

Freq. MHz	Detector Mode PK/QP/AVG	Spectrum Reading Level dB μ V	Factor dB	Actual FS dB μ V/m	Limit @3m dB μ V/m	Margin dB
11490.000	Average	37.30	11.06	48.36	54.00	-5.64
11490.000	Peak	48.44	11.06	59.50	74.00	-14.50
17235.000	Peak	44.45	10.82	55.27	68.20	-12.93

Unless otherwise stated the results shown in this test report refer only to the sample(s) tested and such sample(s) are retained for 90 days only.

除非另有說明，此報告結果僅對測試之樣品負責，同時此樣品僅保留90天。本報告未經本公司書面許可，不可部份複製。

This document is issued by the Company subject to its General Conditions of Service printed overleaf, available on request or accessible at <http://www.sgs.com.tw/Terms-and-Conditions> and for electronic format documents, subject to Terms and Conditions for Electronic Documents at <http://www.sgs.com.tw/Terms-and-Conditions>. Attention is drawn to the limitation of liability, indemnification and jurisdiction issues defined therein. Any holder of this document is advised that information contained hereon reflects the Company's findings at the time of its intervention only and within the limits of Client's instructions, if any. The Company's sole responsibility is to its Client and this document does not exonerate parties to a transaction from exercising all their rights and obligations under the transaction documents. This document cannot be reproduced except in full, without prior written approval of the Company. Any unauthorized alteration, forgery or falsification of the content or appearance of this document is unlawful and offenders may be prosecuted to the fullest extent of the law.

Report Number	:TERF2308001923E2	Test Site	:SAC G Chamber
Operation Mode	:802.11be20	Test Date	:2023-09-21
Test Frequency	:5745 MHz	Temp./Humi.	:21.9°C/65%
Test Mode	:Tx	Antenna Pol.	:Horizontal
EUT Pol	:E2 Plane	Engineer	:Temo Chen

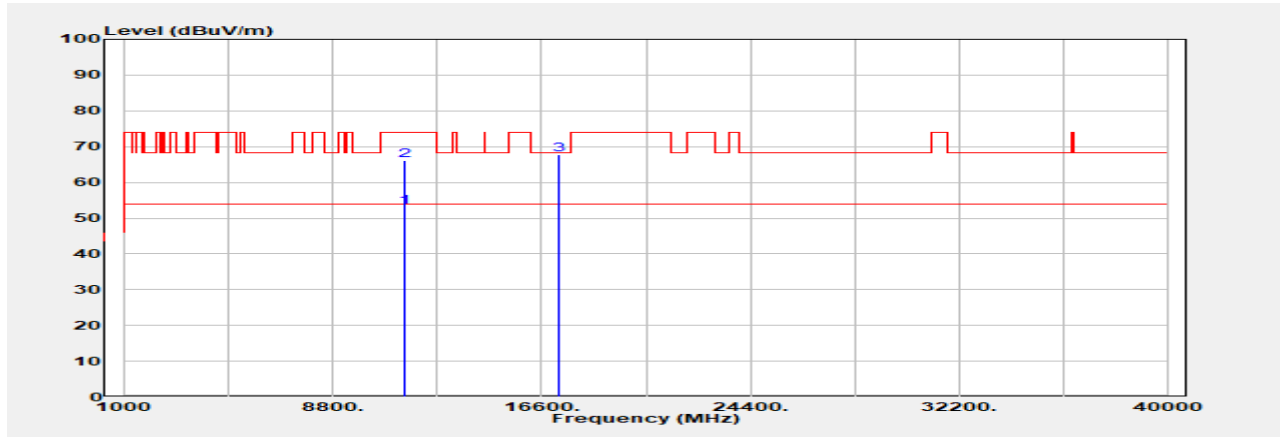

Freq. MHz	Detector Mode PK/QP/AVG	Spectrum Reading Level dBµV	Factor dB	Actual FS dBµV/m	Limit @3m dBµV/m	Margin dB
11490.000	Average	42.11	11.06	53.17	54.00	-0.83
11490.000	Peak	54.93	11.06	65.99	74.00	-8.01
17235.000	Peak	56.99	10.82	67.81	68.20	-0.39

Unless otherwise stated the results shown in this test report refer only to the sample(s) tested and such sample(s) are retained for 90 days only.

除非另有說明，此報告結果僅對測試之樣品負責，同時此樣品僅保留90天。本報告未經本公司書面許可，不可部份複製。

This document is issued by the Company subject to its General Conditions of Service printed overleaf, available on request or accessible at <http://www.sgs.com.tw/Terms-and-Conditions> and for electronic format documents, subject to Terms and Conditions for Electronic Documents at <http://www.sgs.com.tw/Terms-and-Conditions>. Attention is drawn to the limitation of liability, indemnification and jurisdiction issues defined therein. Any holder of this document is advised that information contained hereon reflects the Company's findings at the time of its intervention only and within the limits of Client's instructions, if any. The Company's sole responsibility is to its Client and this document does not exonerate parties to a transaction from exercising all their rights and obligations under the transaction documents. This document cannot be reproduced except in full, without prior written approval of the Company. Any unauthorized alteration, forgery or falsification of the content or appearance of this document is unlawful and offenders may be prosecuted to the fullest extent of the law.

Report Number	:TERF2308001923E2	Test Site	:SAC G Chamber
Operation Mode	:802.11be20	Test Date	:2023-09-21
Test Frequency	:5785 MHz	Temp./Humi.	:21.9°C/65%
Test Mode	:Tx	Antenna Pol.	:Vertical
EUT Pol	:E2 Plane	Engineer	:Temo Chen

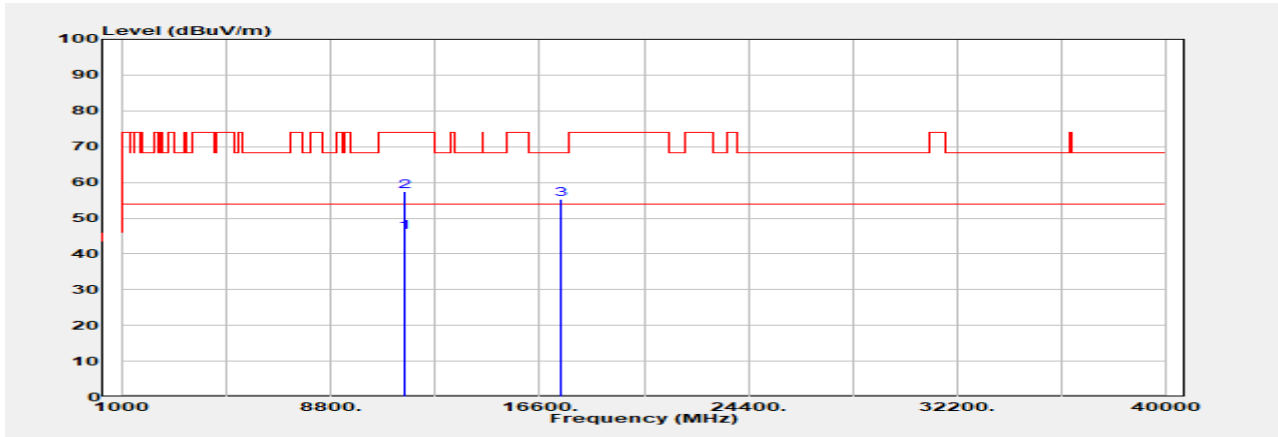

Freq. MHz	Detector Mode PK/QP/AVG	Spectrum Reading Level dBμV	Factor dB	Actual FS dBμV/m	Limit @3m dBμV/m	Margin dB
11570.000	Average	36.01	10.15	46.16	54.00	-7.84
11570.000	Peak	47.29	10.15	57.44	74.00	-16.56
17355.000	Peak	43.44	11.82	55.26	68.20	-12.94

Unless otherwise stated the results shown in this test report refer only to the sample(s) tested and such sample(s) are retained for 90 days only.

除非另有說明，此報告結果僅對測試之樣品負責，同時此樣品僅保留90天。本報告未經本公司書面許可，不可部份複製。

This document is issued by the Company subject to its General Conditions of Service printed overleaf, available on request or accessible at <http://www.sgs.com.tw/Terms-and-Conditions> and for electronic format documents, subject to Terms and Conditions for Electronic Documents at <http://www.sgs.com.tw/Terms-and-Conditions>. Attention is drawn to the limitation of liability, indemnification and jurisdiction issues defined therein. Any holder of this document is advised that information contained hereon reflects the Company's findings at the time of its intervention only and within the limits of Client's instructions, if any. The Company's sole responsibility is to its Client and this document does not exonerate parties to a transaction from exercising all their rights and obligations under the transaction documents. This document cannot be reproduced except in full, without prior written approval of the Company. Any unauthorized alteration, forgery or falsification of the content or appearance of this document is unlawful and offenders may be prosecuted to the fullest extent of the law.

Report Number	:TERF2308001923E2	Test Site	:SAC G Chamber
Operation Mode	:802.11be20	Test Date	:2023-09-21
Test Frequency	:5785 MHz	Temp./Humi.	:21.9°C/65%
Test Mode	:Tx	Antenna Pol.	:Horizontal
EUT Pol	:E2 Plane	Engineer	:Temo Chen

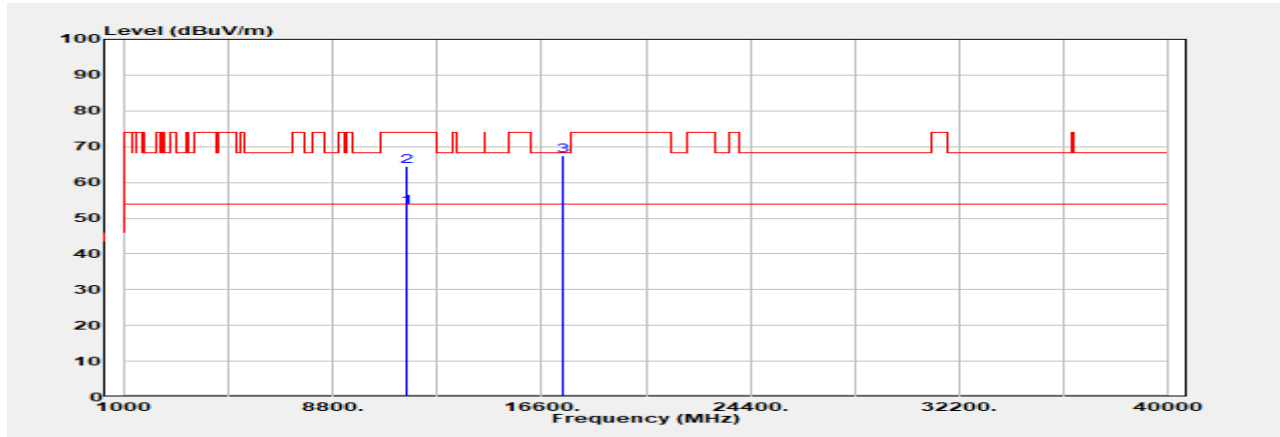

Freq. MHz	Detector Mode PK/QP/AVG	Spectrum Reading Level dBμV	Factor dB	Actual FS dBμV/m	Limit @3m dBμV/m	Margin dB
11570.000	Average	43.04	10.15	53.19	54.00	-0.81
11570.000	Peak	54.28	10.15	64.43	74.00	-9.57
17355.000	Peak	55.71	11.82	67.53	68.20	-0.67

Unless otherwise stated the results shown in this test report refer only to the sample(s) tested and such sample(s) are retained for 90 days only.

除非另有說明，此報告結果僅對測試之樣品負責，同時此樣品僅保留90天。本報告未經本公司書面許可，不可部份複製。

This document is issued by the Company subject to its General Conditions of Service printed overleaf, available on request or accessible at <http://www.sgs.com.tw/Terms-and-Conditions> and for electronic format documents, subject to Terms and Conditions for Electronic Documents at <http://www.sgs.com.tw/Terms-and-Conditions>. Attention is drawn to the limitation of liability, indemnification and jurisdiction issues defined therein. Any holder of this document is advised that information contained hereon reflects the Company's findings at the time of its intervention only and within the limits of Client's instructions, if any. The Company's sole responsibility is to its Client and this document does not exonerate parties to a transaction from exercising all their rights and obligations under the transaction documents. This document cannot be reproduced except in full, without prior written approval of the Company. Any unauthorized alteration, forgery or falsification of the content or appearance of this document is unlawful and offenders may be prosecuted to the fullest extent of the law.

Report Number	:TERF2308001923E2	Test Site	:SAC G Chamber
Operation Mode	:802.11be20	Test Date	:2023-09-21
Test Frequency	:5825 MHz	Temp./Humi.	:21.9°C/65%
Test Mode	:Tx	Antenna Pol.	:Vertical
EUT Pol	:E2 Plane	Engineer	:Temo Chen

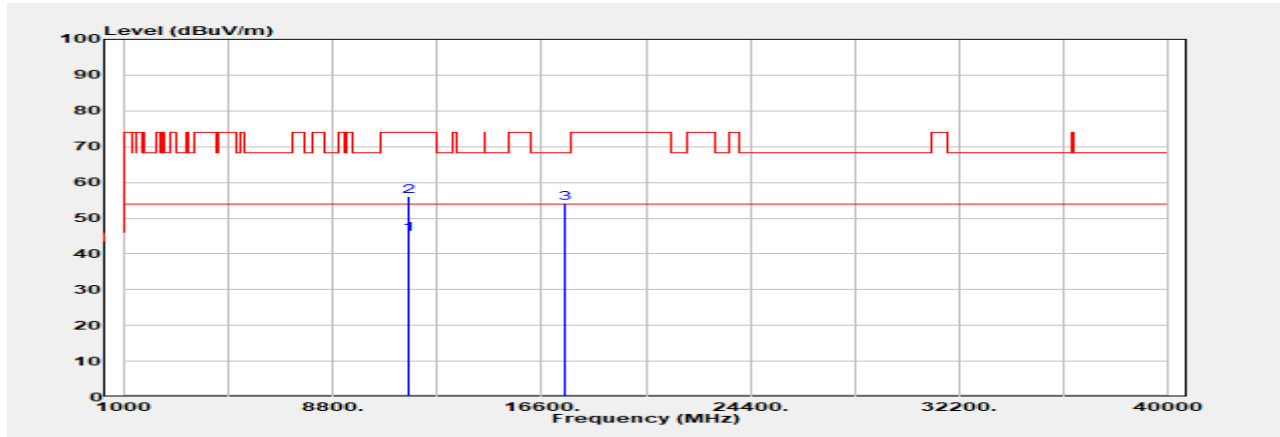

Freq. MHz	Detector Mode PK/QP/AVG	Spectrum Reading Level dBμV	Factor dB	Actual FS dBμV/m	Limit @3m dBμV/m	Margin dB
11650.000	Average	35.43	10.05	45.48	54.00	-8.52
11650.000	Peak	46.10	10.05	56.15	74.00	-17.85
17475.000	Peak	43.06	11.10	54.16	68.20	-14.04

Unless otherwise stated the results shown in this test report refer only to the sample(s) tested and such sample(s) are retained for 90 days only.

除非另有說明，此報告結果僅對測試之樣品負責，同時此樣品僅保留90天。本報告未經本公司書面許可，不可部份複製。

This document is issued by the Company subject to its General Conditions of Service printed overleaf, available on request or accessible at <http://www.sgs.com.tw/Terms-and-Conditions> and for electronic format documents, subject to Terms and Conditions for Electronic Documents at <http://www.sgs.com.tw/Terms-and-Conditions>. Attention is drawn to the limitation of liability, indemnification and jurisdiction issues defined therein. Any holder of this document is advised that information contained hereon reflects the Company's findings at the time of its intervention only and within the limits of Client's instructions, if any. The Company's sole responsibility is to its Client and this document does not exonerate parties to a transaction from exercising all their rights and obligations under the transaction documents. This document cannot be reproduced except in full, without prior written approval of the Company. Any unauthorized alteration, forgery or falsification of the content or appearance of this document is unlawful and offenders may be prosecuted to the fullest extent of the law.

Report Number	:TERF2308001923E2	Test Site	:SAC G Chamber
Operation Mode	:802.11be20	Test Date	:2023-09-21
Test Frequency	:5825 MHz	Temp./Humi.	:21.9°C/65%
Test Mode	:Tx	Antenna Pol.	:Horizontal
EUT Pol	:E2 Plane	Engineer	:Temo Chen

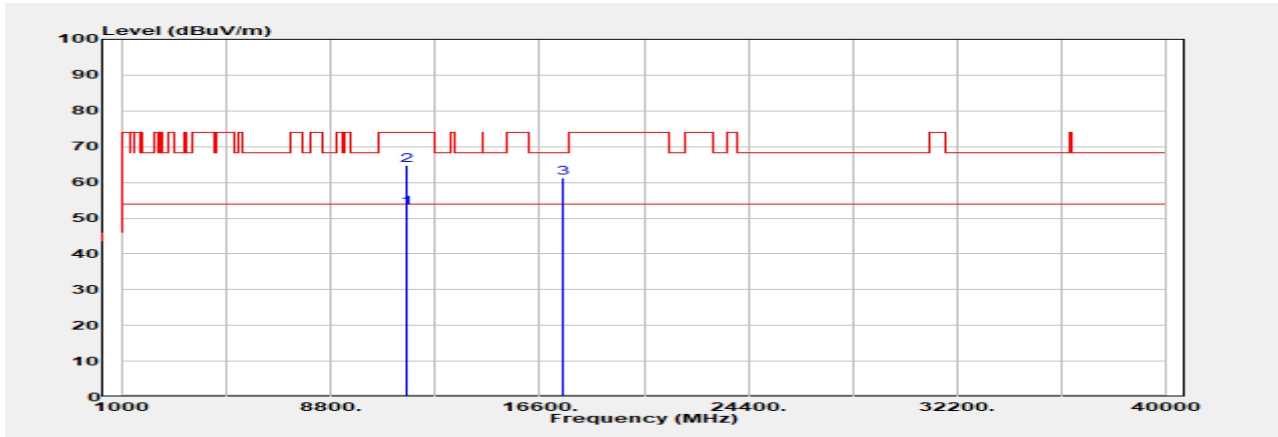

Freq. MHz	Detector Mode PK/QP/AVG	Spectrum Reading Level dBμV	Factor dB	Actual FS dBμV/m	Limit @3m dBμV/m	Margin dB
11650.000	Average	42.72	10.05	52.77	54.00	-1.23
11650.000	Peak	54.63	10.05	64.68	74.00	-9.32
17475.000	Peak	50.13	11.10	61.23	68.20	-6.97

Unless otherwise stated the results shown in this test report refer only to the sample(s) tested and such sample(s) are retained for 90 days only.

除非另有說明，此報告結果僅對測試之樣品負責，同時此樣品僅保留90天。本報告未經本公司書面許可，不可部份複製。

This document is issued by the Company subject to its General Conditions of Service printed overleaf, available on request or accessible at <http://www.sgs.com.tw/Terms-and-Conditions> and for electronic format documents, subject to Terms and Conditions for Electronic Documents at <http://www.sgs.com.tw/Terms-and-Conditions>. Attention is drawn to the limitation of liability, indemnification and jurisdiction issues defined therein. Any holder of this document is advised that information contained hereon reflects the Company's findings at the time of its intervention only and within the limits of Client's instructions, if any. The Company's sole responsibility is to its Client and this document does not exonerate parties to a transaction from exercising all their rights and obligations under the transaction documents. This document cannot be reproduced except in full, without prior written approval of the Company. Any unauthorized alteration, forgery or falsification of the content or appearance of this document is unlawful and offenders may be prosecuted to the fullest extent of the law.

Report Number	:TERF2308001923E2	Test Site	:SAC G Chamber
Operation Mode	:802.11be40	Test Date	:2023-09-23
Test Frequency	:5190 MHz	Temp./Humi.	:21.8°C/63%
Test Mode	:Tx	Antenna Pol.	:Vertical
EUT Pol	:E2 Plane	Engineer	:Temo Chen

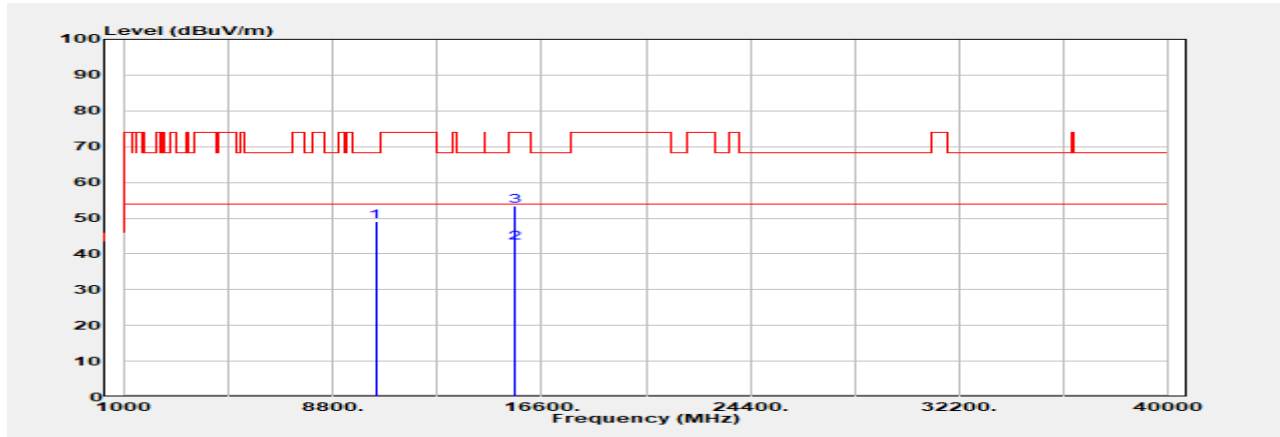

Freq. MHz	Detector Mode PK/QP/AVG	Spectrum Reading Level dB μ V	Factor dB	Actual FS dB μ V/m	Limit @3m dB μ V/m	Margin dB
10380.000	Peak	39.57	9.44	49.01	68.20	-19.19
15570.000	Average	31.26	11.93	43.19	54.00	-10.81
15570.000	Peak	41.59	11.93	53.52	74.00	-20.48

Unless otherwise stated the results shown in this test report refer only to the sample(s) tested and such sample(s) are retained for 90 days only.

除非另有說明，此報告結果僅對測試之樣品負責，同時此樣品僅保留90天。本報告未經本公司書面許可，不可部份複製。

This document is issued by the Company subject to its General Conditions of Service printed overleaf, available on request or accessible at <http://www.sgs.com.tw/Terms-and-Conditions> and for electronic format documents, subject to Terms and Conditions for Electronic Documents at <http://www.sgs.com.tw/Terms-and-Conditions>. Attention is drawn to the limitation of liability, indemnification and jurisdiction issues defined therein. Any holder of this document is advised that information contained hereon reflects the Company's findings at the time of its intervention only and within the limits of Client's instructions, if any. The Company's sole responsibility is to its Client and this document does not exonerate parties to a transaction from exercising all their rights and obligations under the transaction documents. This document cannot be reproduced except in full, without prior written approval of the Company. Any unauthorized alteration, forgery or falsification of the content or appearance of this document is unlawful and offenders may be prosecuted to the fullest extent of the law.

Report Number	:TERF2308001923E2	Test Site	:SAC G Chamber
Operation Mode	:802.11be40	Test Date	:2023-09-23
Test Frequency	:5190 MHz	Temp./Humi.	:21.8°C/63%
Test Mode	:Tx	Antenna Pol.	:Horizontal
EUT Pol	:E2 Plane	Engineer	:Temo Chen

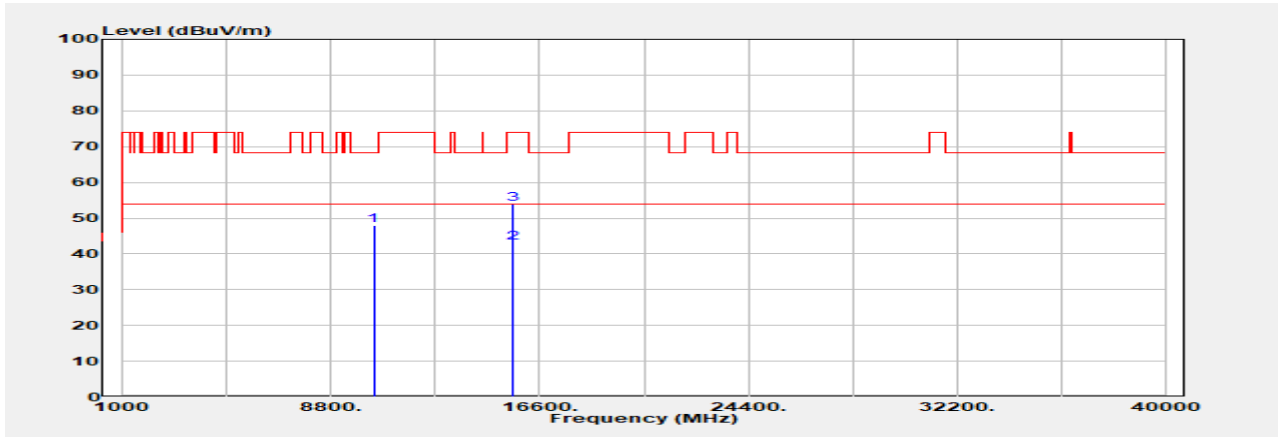

Freq. MHz	Detector Mode PK/QP/AVG	Spectrum Reading Level dBµV	Factor dB	Actual FS dBµV/m	Limit @3m dBµV/m	Margin dB
10380.000	Peak	38.51	9.44	47.95	68.20	-20.25
15570.000	Average	31.24	11.93	43.17	54.00	-10.83
15570.000	Peak	41.93	11.93	53.86	74.00	-20.14

Unless otherwise stated the results shown in this test report refer only to the sample(s) tested and such sample(s) are retained for 90 days only.

除非另有說明，此報告結果僅對測試之樣品負責，同時此樣品僅保留90天。本報告未經本公司書面許可，不可部份複製。

This document is issued by the Company subject to its General Conditions of Service printed overleaf, available on request or accessible at <http://www.sgs.com.tw/Terms-and-Conditions> and for electronic format documents, subject to Terms and Conditions for Electronic Documents at <http://www.sgs.com.tw/Terms-and-Conditions>. Attention is drawn to the limitation of liability, indemnification and jurisdiction issues defined therein. Any holder of this document is advised that information contained hereon reflects the Company's findings at the time of its intervention only and within the limits of Client's instructions, if any. The Company's sole responsibility is to its Client and this document does not exonerate parties to a transaction from exercising all their rights and obligations under the transaction documents. This document cannot be reproduced except in full, without prior written approval of the Company. Any unauthorized alteration, forgery or falsification of the content or appearance of this document is unlawful and offenders may be prosecuted to the fullest extent of the law.

Report Number	:TERF2308001923E2	Test Site	:SAC G Chamber
Operation Mode	:802.11be40	Test Date	:2023-09-23
Test Frequency	:5230 MHz	Temp./Humi.	:21.8°C/63%
Test Mode	:Tx	Antenna Pol.	:Vertical
EUT Pol	:E2 Plane	Engineer	:Temo Chen

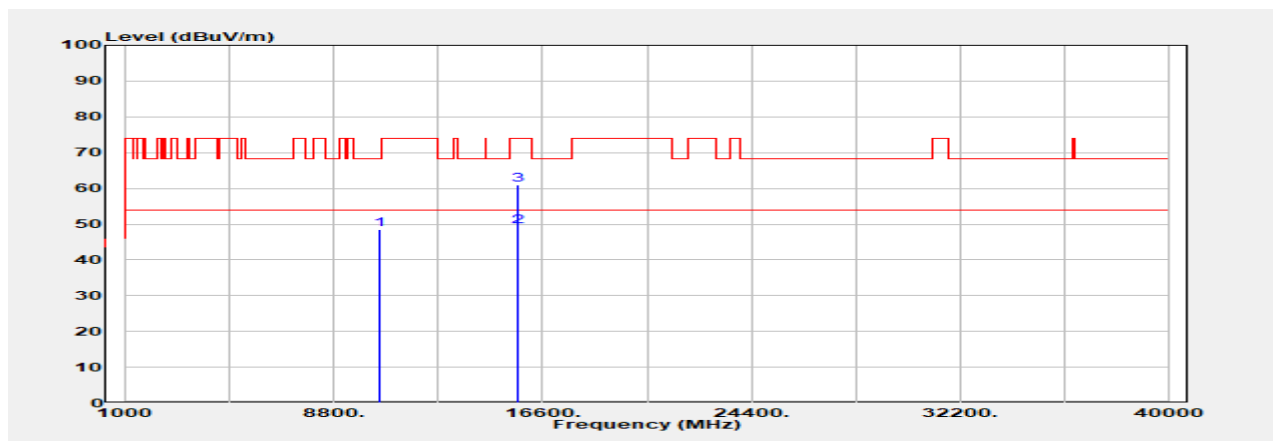

Freq. MHz	Detector Mode PK/QP/AVG	Spectrum Reading Level dBµV	Factor dB	Actual FS dBµV/m	Limit @3m dBµV/m	Margin dB
10460.000	Peak	38.87	9.74	48.61	68.20	-19.59
15690.000	Average	36.81	12.53	49.34	54.00	-4.66
15690.000	Peak	48.36	12.53	60.89	74.00	-13.11

Unless otherwise stated the results shown in this test report refer only to the sample(s) tested and such sample(s) are retained for 90 days only.

除非另有說明，此報告結果僅對測試之樣品負責，同時此樣品僅保留90天。本報告未經本公司書面許可，不可部份複製。

This document is issued by the Company subject to its General Conditions of Service printed overleaf, available on request or accessible at <http://www.sgs.com.tw/Terms-and-Conditions> and for electronic format documents, subject to Terms and Conditions for Electronic Documents at <http://www.sgs.com.tw/Terms-and-Conditions>. Attention is drawn to the limitation of liability, indemnification and jurisdiction issues defined therein. Any holder of this document is advised that information contained hereon reflects the Company's findings at the time of its intervention only and within the limits of Client's instructions, if any. The Company's sole responsibility is to its Client and this document does not exonerate parties to a transaction from exercising all their rights and obligations under the transaction documents. This document cannot be reproduced except in full, without prior written approval of the Company. Any unauthorized alteration, forgery or falsification of the content or appearance of this document is unlawful and offenders may be prosecuted to the fullest extent of the law.

Report Number	:TERF2308001923E2	Test Site	:SAC G Chamber
Operation Mode	:802.11be40	Test Date	:2023-09-23
Test Frequency	:5230 MHz	Temp./Humi.	:21.8°C/63%
Test Mode	:Tx	Antenna Pol.	:Horizontal
EUT Pol	:E2 Plane	Engineer	:Temo Chen

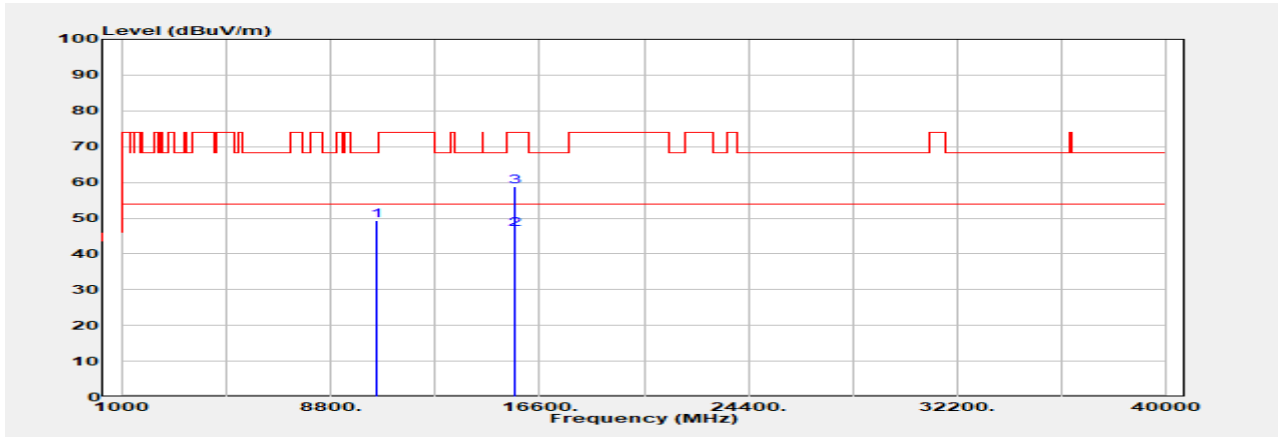

Freq. MHz	Detector Mode PK/QP/AVG	Spectrum Reading Level dB μ V	Factor dB	Actual FS dB μ V/m	Limit @3m dB μ V/m	Margin dB
10460.000	Peak	39.63	9.74	49.37	68.20	-18.83
15690.000	Average	34.26	12.53	46.79	54.00	-7.21
15690.000	Peak	46.29	12.53	58.82	74.00	-15.18

Unless otherwise stated the results shown in this test report refer only to the sample(s) tested and such sample(s) are retained for 90 days only.

除非另有說明，此報告結果僅對測試之樣品負責，同時此樣品僅保留90天。本報告未經本公司書面許可，不可部份複製。

This document is issued by the Company subject to its General Conditions of Service printed overleaf, available on request or accessible at <http://www.sgs.com.tw/Terms-and-Conditions> and for electronic format documents, subject to Terms and Conditions for Electronic Documents at <http://www.sgs.com.tw/Terms-and-Conditions>. Attention is drawn to the limitation of liability, indemnification and jurisdiction issues defined therein. Any holder of this document is advised that information contained hereon reflects the Company's findings at the time of its intervention only and within the limits of Client's instructions, if any. The Company's sole responsibility is to its Client and this document does not exonerate parties to a transaction from exercising all their rights and obligations under the transaction documents. This document cannot be reproduced except in full, without prior written approval of the Company. Any unauthorized alteration, forgery or falsification of the content or appearance of this document is unlawful and offenders may be prosecuted to the fullest extent of the law.

Report Number	:TERF2308001923E2	Test Site	:SAC G Chamber
Operation Mode	:802.11be40	Test Date	:2023-09-23
Test Frequency	:5270 MHz	Temp./Humi.	:21.8°C/63%
Test Mode	:Tx	Antenna Pol.	:Vertical
EUT Pol	:E2 Plane	Engineer	:Temo Chen

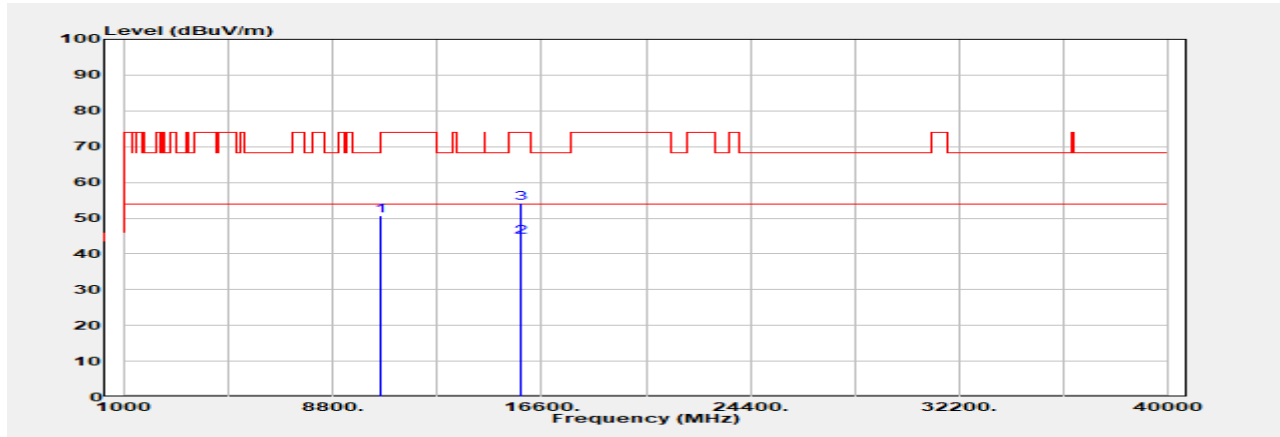

Freq. MHz	Detector Mode PK/QP/AVG	Spectrum Reading Level dBµV	Factor dB	Actual FS dBµV/m	Limit @3m dBµV/m	Margin dB
10540.000	Peak	40.67	9.94	50.61	68.20	-17.59
15810.000	Average	32.44	12.38	44.82	54.00	-9.18
15810.000	Peak	41.90	12.38	54.28	74.00	-19.72

Unless otherwise stated the results shown in this test report refer only to the sample(s) tested and such sample(s) are retained for 90 days only.

除非另有說明，此報告結果僅對測試之樣品負責，同時此樣品僅保留90天。本報告未經本公司書面許可，不可部份複製。

This document is issued by the Company subject to its General Conditions of Service printed overleaf, available on request or accessible at <http://www.sgs.com.tw/Terms-and-Conditions> and for electronic format documents, subject to Terms and Conditions for Electronic Documents at <http://www.sgs.com.tw/Terms-and-Conditions>. Attention is drawn to the limitation of liability, indemnification and jurisdiction issues defined therein. Any holder of this document is advised that information contained hereon reflects the Company's findings at the time of its intervention only and within the limits of Client's instructions, if any. The Company's sole responsibility is to its Client and this document does not exonerate parties to a transaction from exercising all their rights and obligations under the transaction documents. This document cannot be reproduced except in full, without prior written approval of the Company. Any unauthorized alteration, forgery or falsification of the content or appearance of this document is unlawful and offenders may be prosecuted to the fullest extent of the law.

Report Number	:TERF2308001923E2	Test Site	:SAC G Chamber
Operation Mode	:802.11be40	Test Date	:2023-09-23
Test Frequency	:5270 MHz	Temp./Humi.	:21.8°C/63%
Test Mode	:Tx	Antenna Pol.	:Horizontal
EUT Pol	:E2 Plane	Engineer	:Temo Chen

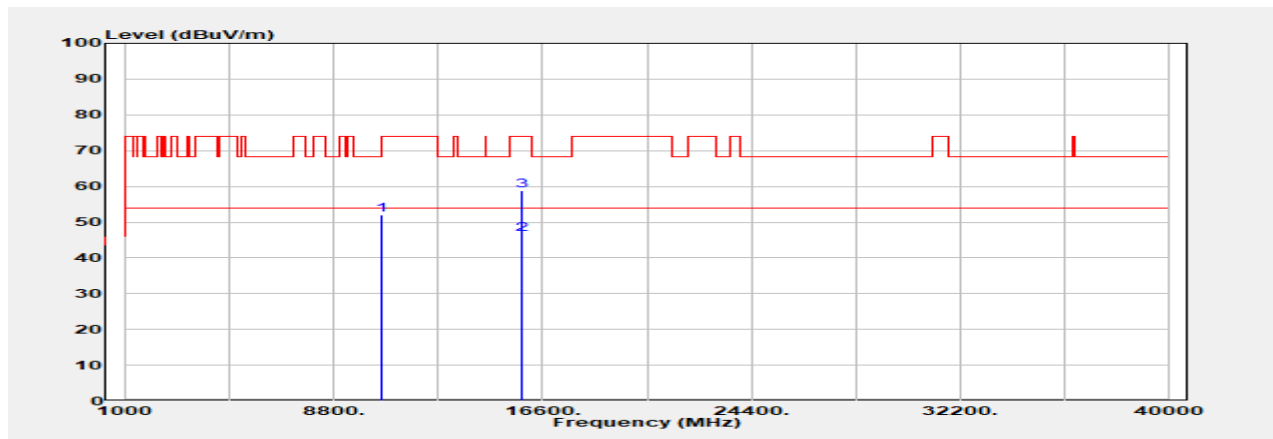

Freq. MHz	Detector Mode PK/QP/AVG	Spectrum Reading Level dB μ V	Factor dB	Actual FS dB μ V/m	Limit @3m dB μ V/m	Margin dB
10540.000	Peak	42.12	9.94	52.06	68.20	-16.14
15810.000	Average	34.22	12.38	46.60	54.00	-7.40
15810.000	Peak	46.40	12.38	58.78	74.00	-15.22

Unless otherwise stated the results shown in this test report refer only to the sample(s) tested and such sample(s) are retained for 90 days only.

除非另有說明，此報告結果僅對測試之樣品負責，同時此樣品僅保留90天。本報告未經本公司書面許可，不可部份複製。

This document is issued by the Company subject to its General Conditions of Service printed overleaf, available on request or accessible at <http://www.sgs.com.tw/Terms-and-Conditions> and for electronic format documents, subject to Terms and Conditions for Electronic Documents at <http://www.sgs.com.tw/Terms-and-Conditions>. Attention is drawn to the limitation of liability, indemnification and jurisdiction issues defined therein. Any holder of this document is advised that information contained hereon reflects the Company's findings at the time of its intervention only and within the limits of Client's instructions, if any. The Company's sole responsibility is to its Client and this document does not exonerate parties to a transaction from exercising all their rights and obligations under the transaction documents. This document cannot be reproduced except in full, without prior written approval of the Company. Any unauthorized alteration, forgery or falsification of the content or appearance of this document is unlawful and offenders may be prosecuted to the fullest extent of the law.

Report Number	:TERF2308001923E2	Test Site	:SAC G Chamber
Operation Mode	:802.11be40	Test Date	:2023-09-23
Test Frequency	:5310 MHz	Temp./Humi.	:21.8°C/63%
Test Mode	:Tx	Antenna Pol.	:Vertical
EUT Pol	:E2 Plane	Engineer	:Temo Chen

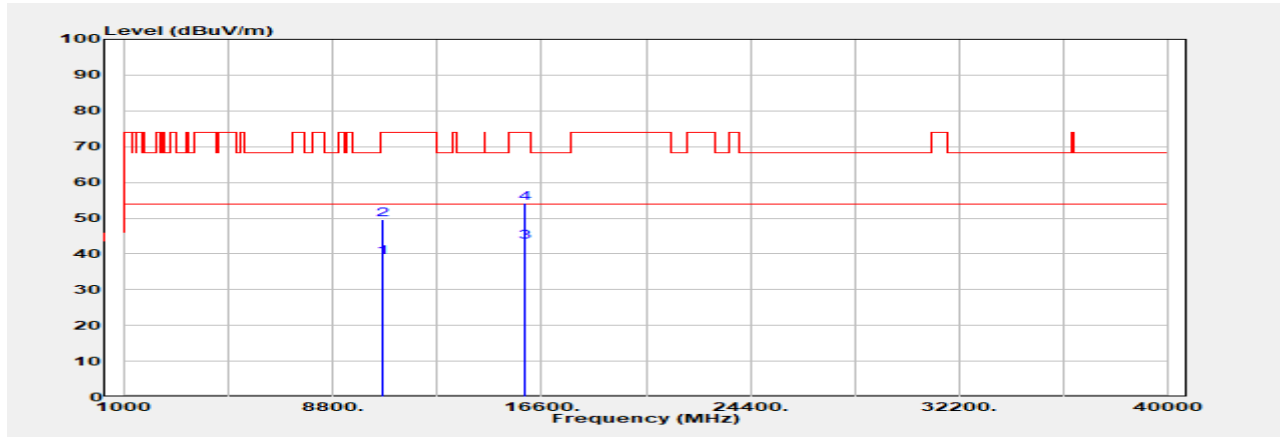

Freq. MHz	Detector Mode	Spectrum Reading Level dB μ V	Factor dB	Actual FS dB μ V/m	Limit @3m dB μ V/m	Margin dB
10620.000	Average	29.03	9.86	38.89	54.00	-15.11
10620.000	Peak	39.67	9.86	49.53	74.00	-24.47
15930.000	Average	31.44	12.05	43.49	54.00	-10.51
15930.000	Peak	42.15	12.05	54.20	74.00	-19.80

Unless otherwise stated the results shown in this test report refer only to the sample(s) tested and such sample(s) are retained for 90 days only.

除非另有說明，此報告結果僅對測試之樣品負責，同時此樣品僅保留90天。本報告未經本公司書面許可，不可部份複製。

This document is issued by the Company subject to its General Conditions of Service printed overleaf, available on request or accessible at <http://www.sgs.com.tw/Terms-and-Conditions> and for electronic format documents, subject to Terms and Conditions for Electronic Documents at <http://www.sgs.com.tw/Terms-and-Conditions>. Attention is drawn to the limitation of liability, indemnification and jurisdiction issues defined therein. Any holder of this document is advised that information contained hereon reflects the Company's findings at the time of its intervention only and within the limits of Client's instructions, if any. The Company's sole responsibility is to its Client and this document does not exonerate parties to a transaction from exercising all their rights and obligations under the transaction documents. This document cannot be reproduced except in full, without prior written approval of the Company. Any unauthorized alteration, forgery or falsification of the content or appearance of this document is unlawful and offenders may be prosecuted to the fullest extent of the law.

Report Number	:TERF2308001923E2	Test Site	:SAC G Chamber
Operation Mode	:802.11be40	Test Date	:2023-09-23
Test Frequency	:5310 MHz	Temp./Humi.	:21.8°C/63%
Test Mode	:Tx	Antenna Pol.	:Horizontal
EUT Pol	:E2 Plane	Engineer	:Temo Chen

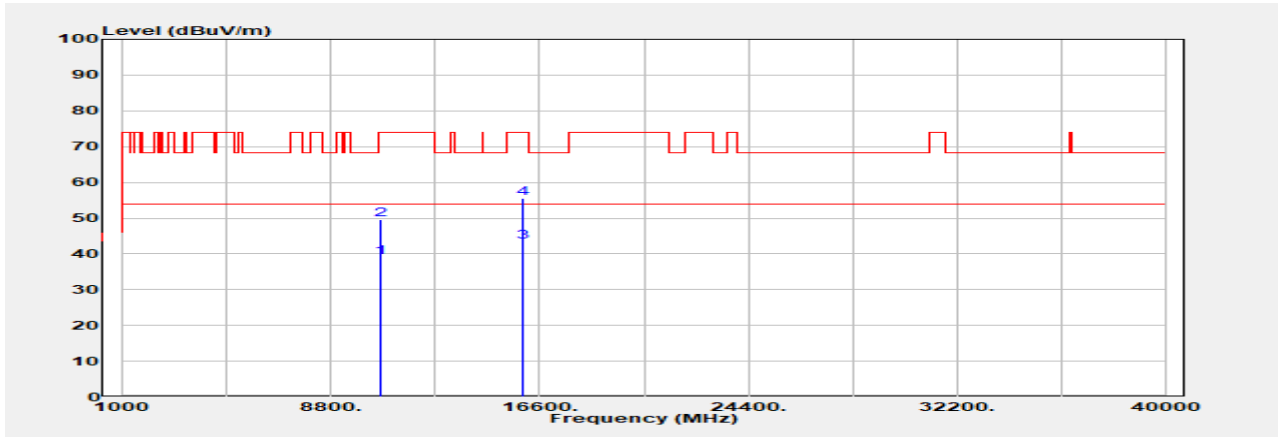

Freq. MHz	Detector Mode PK/QP/AVG	Spectrum Reading Level dB μ V	Factor dB	Actual FS dB μ V/m	Limit @3m dB μ V/m	Margin dB
10620.000	Average	29.26	9.86	39.12	54.00	-14.88
10620.000	Peak	39.77	9.86	49.63	74.00	-24.37
15930.000	Average	31.44	12.05	43.49	54.00	-10.51
15930.000	Peak	43.58	12.05	55.63	74.00	-18.37

Unless otherwise stated the results shown in this test report refer only to the sample(s) tested and such sample(s) are retained for 90 days only.

除非另有說明，此報告結果僅對測試之樣品負責，同時此樣品僅保留90天。本報告未經本公司書面許可，不可部份複製。

This document is issued by the Company subject to its General Conditions of Service printed overleaf, available on request or accessible at <http://www.sgs.com.tw/Terms-and-Conditions> and for electronic format documents, subject to Terms and Conditions for Electronic Documents at <http://www.sgs.com.tw/Terms-and-Conditions>. Attention is drawn to the limitation of liability, indemnification and jurisdiction issues defined therein. Any holder of this document is advised that information contained hereon reflects the Company's findings at the time of its intervention only and within the limits of Client's instructions, if any. The Company's sole responsibility is to its Client and this document does not exonerate parties to a transaction from exercising all their rights and obligations under the transaction documents. This document cannot be reproduced except in full, without prior written approval of the Company. Any unauthorized alteration, forgery or falsification of the content or appearance of this document is unlawful and offenders may be prosecuted to the fullest extent of the law.

Report Number	:TERF2308001923E2	Test Site	:SAC G Chamber
Operation Mode	:802.11be40	Test Date	:2023-09-23
Test Frequency	:5510 MHz	Temp./Humi.	:21.8°C/63%
Test Mode	:Tx	Antenna Pol.	:Vertical
EUT Pol	:E2 Plane	Engineer	:Temo Chen

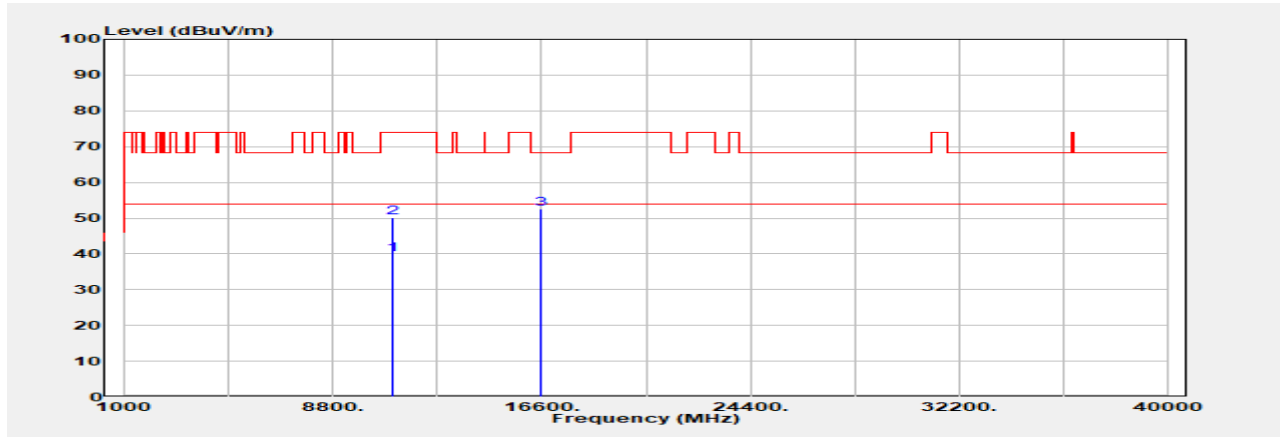

Freq. MHz	Detector Mode PK/QP/AVG	Spectrum Reading Level dB μ V	Factor dB	Actual FS dB μ V/m	Limit @3m dB μ V/m	Margin dB
11020.000	Average	28.43	11.46	39.88	54.00	-14.12
11020.000	Peak	38.76	11.46	50.22	74.00	-23.78
16530.000	Peak	40.72	11.94	52.66	68.20	-15.54

Unless otherwise stated the results shown in this test report refer only to the sample(s) tested and such sample(s) are retained for 90 days only.

除非另有說明，此報告結果僅對測試之樣品負責，同時此樣品僅保留90天。本報告未經本公司書面許可，不可部份複製。

This document is issued by the Company subject to its General Conditions of Service printed overleaf, available on request or accessible at <http://www.sgs.com.tw/Terms-and-Conditions> and for electronic format documents, subject to Terms and Conditions for Electronic Documents at <http://www.sgs.com.tw/Terms-and-Conditions>. Attention is drawn to the limitation of liability, indemnification and jurisdiction issues defined therein. Any holder of this document is advised that information contained hereon reflects the Company's findings at the time of its intervention only and within the limits of Client's instructions, if any. The Company's sole responsibility is to its Client and this document does not exonerate parties to a transaction from exercising all their rights and obligations under the transaction documents. This document cannot be reproduced except in full, without prior written approval of the Company. Any unauthorized alteration, forgery or falsification of the content or appearance of this document is unlawful and offenders may be prosecuted to the fullest extent of the law.

Report Number	:TERF2308001923E2	Test Site	:SAC G Chamber
Operation Mode	:802.11be40	Test Date	:2023-09-23
Test Frequency	:5510 MHz	Temp./Humi.	:21.8°C/63%
Test Mode	:Tx	Antenna Pol.	:Horizontal
EUT Pol	:E2 Plane	Engineer	:Temo Chen

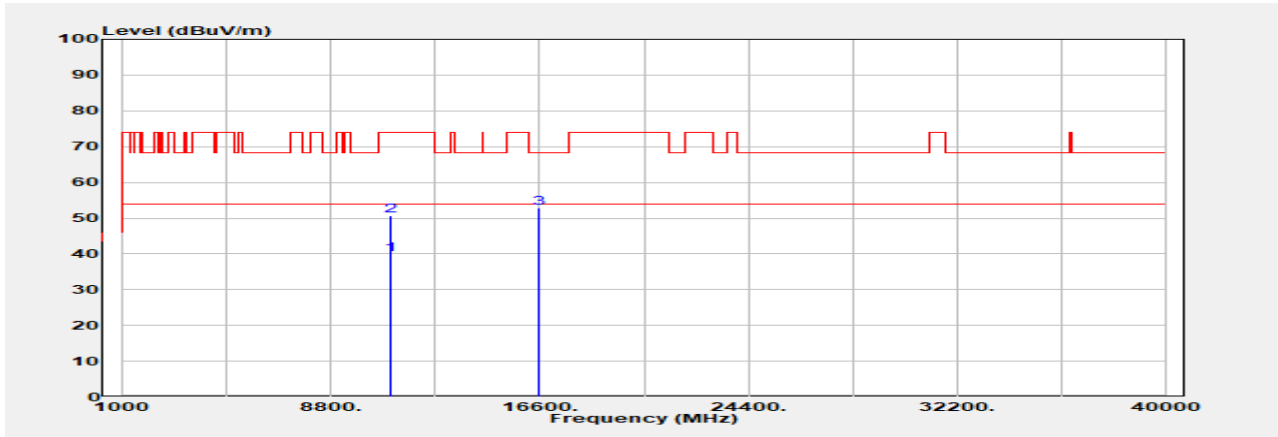

Freq. MHz	Detector Mode PK/QP/AVG	Spectrum Reading Level dB μ V	Factor dB	Actual FS dB μ V/m	Limit @3m dB μ V/m	Margin dB
11020.000	Average	28.33	11.46	39.79	54.00	-14.21
11020.000	Peak	39.29	11.46	50.74	74.00	-23.26
16530.000	Peak	40.77	11.94	52.71	68.20	-15.49

Unless otherwise stated the results shown in this test report refer only to the sample(s) tested and such sample(s) are retained for 90 days only.

除非另有說明，此報告結果僅對測試之樣品負責，同時此樣品僅保留90天。本報告未經本公司書面許可，不可部份複製。

This document is issued by the Company subject to its General Conditions of Service printed overleaf, available on request or accessible at <http://www.sgs.com.tw/Terms-and-Conditions> and for electronic format documents, subject to Terms and Conditions for Electronic Documents at <http://www.sgs.com.tw/Terms-and-Conditions>. Attention is drawn to the limitation of liability, indemnification and jurisdiction issues defined therein. Any holder of this document is advised that information contained hereon reflects the Company's findings at the time of its intervention only and within the limits of Client's instructions, if any. The Company's sole responsibility is to its Client and this document does not exonerate parties to a transaction from exercising all their rights and obligations under the transaction documents. This document cannot be reproduced except in full, without prior written approval of the Company. Any unauthorized alteration, forgery or falsification of the content or appearance of this document is unlawful and offenders may be prosecuted to the fullest extent of the law.

Report Number	:TERF2308001923E2	Test Site	:SAC G Chamber
Operation Mode	:802.11be40	Test Date	:2023-09-23
Test Frequency	:5550 MHz	Temp./Humi.	:21.8°C/63%
Test Mode	:Tx	Antenna Pol.	:Vertical
EUT Pol	:E2 Plane	Engineer	:Temo Chen



Freq. MHz	Detector Mode PK/QP/AVG	Spectrum Reading Level dBuV	Factor dB	Actual FS dBuV/m	Limit @3m dBuV/m	Margin dB
11100.000	Average	28.79	9.70	38.49	54.00	-15.51
11100.000	Peak	39.74	9.70	49.44	74.00	-24.56
16650.000	Peak	41.20	11.75	52.95	68.20	-15.25

Unless otherwise stated the results shown in this test report refer only to the sample(s) tested and such sample(s) are retained for 90 days only.

除非另有說明，此報告結果僅對測試之樣品負責，同時此樣品僅保留90天。本報告未經本公司書面許可，不可部份複製。

This document is issued by the Company subject to its General Conditions of Service printed overleaf, available on request or accessible at <http://www.sgs.com.tw/Terms-and-Conditions> and for electronic format documents, subject to Terms and Conditions for Electronic Documents at <http://www.sgs.com.tw/Terms-and-Conditions>. Attention is drawn to the limitation of liability, indemnification and jurisdiction issues defined therein. Any holder of this document is advised that information contained hereon reflects the Company's findings at the time of its intervention only and within the limits of Client's instructions, if any. The Company's sole responsibility is to its Client and this document does not exonerate parties to a transaction from exercising all their rights and obligations under the transaction documents. This document cannot be reproduced except in full, without prior written approval of the Company. Any unauthorized alteration, forgery or falsification of the content or appearance of this document is unlawful and offenders may be prosecuted to the fullest extent of the law.

Report Number	:TERF2308001923E2	Test Site	:SAC G Chamber
Operation Mode	:802.11be40	Test Date	:2023-09-23
Test Frequency	:5550 MHz	Temp./Humi.	:21.8°C/63%
Test Mode	:Tx	Antenna Pol.	:Horizontal
EUT Pol	:E2 Plane	Engineer	:Temo Chen

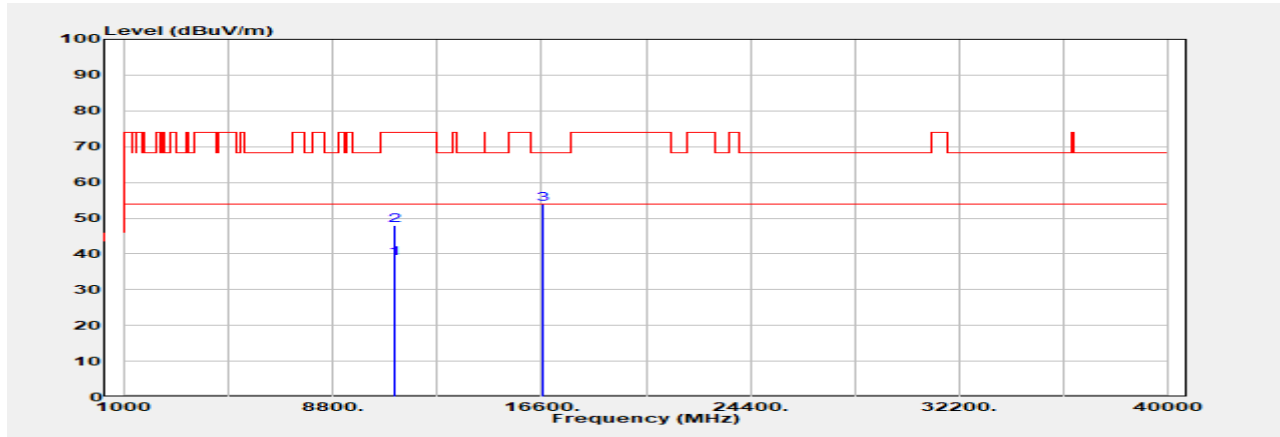

Freq. MHz	Detector Mode	Spectrum Reading Level dB μ V	Factor dB	Actual FS dB μ V/m	Limit @3m dB μ V/m	Margin dB
11100.000	Average	29.01	9.70	38.71	54.00	-15.29
11100.000	Peak	38.25	9.70	47.95	74.00	-26.05
16650.000	Peak	42.08	11.75	53.83	68.20	-14.37

Unless otherwise stated the results shown in this test report refer only to the sample(s) tested and such sample(s) are retained for 90 days only.

除非另有說明，此報告結果僅對測試之樣品負責，同時此樣品僅保留90天。本報告未經本公司書面許可，不可部份複製。

This document is issued by the Company subject to its General Conditions of Service printed overleaf, available on request or accessible at <http://www.sgs.com.tw/Terms-and-Conditions> and for electronic format documents, subject to Terms and Conditions for Electronic Documents at <http://www.sgs.com.tw/Terms-and-Conditions>. Attention is drawn to the limitation of liability, indemnification and jurisdiction issues defined therein. Any holder of this document is advised that information contained hereon reflects the Company's findings at the time of its intervention only and within the limits of Client's instructions, if any. The Company's sole responsibility is to its Client and this document does not exonerate parties to a transaction from exercising all their rights and obligations under the transaction documents. This document cannot be reproduced except in full, without prior written approval of the Company. Any unauthorized alteration, forgery or falsification of the content or appearance of this document is unlawful and offenders may be prosecuted to the fullest extent of the law.

Report Number	:TERF2308001923E2	Test Site	:SAC G Chamber
Operation Mode	:802.11be40	Test Date	:2023-09-23
Test Frequency	:5670 MHz	Temp./Humi.	:21.8°C/63%
Test Mode	:Tx	Antenna Pol.	:Vertical
EUT Pol	:E2 Plane	Engineer	:Temo Chen

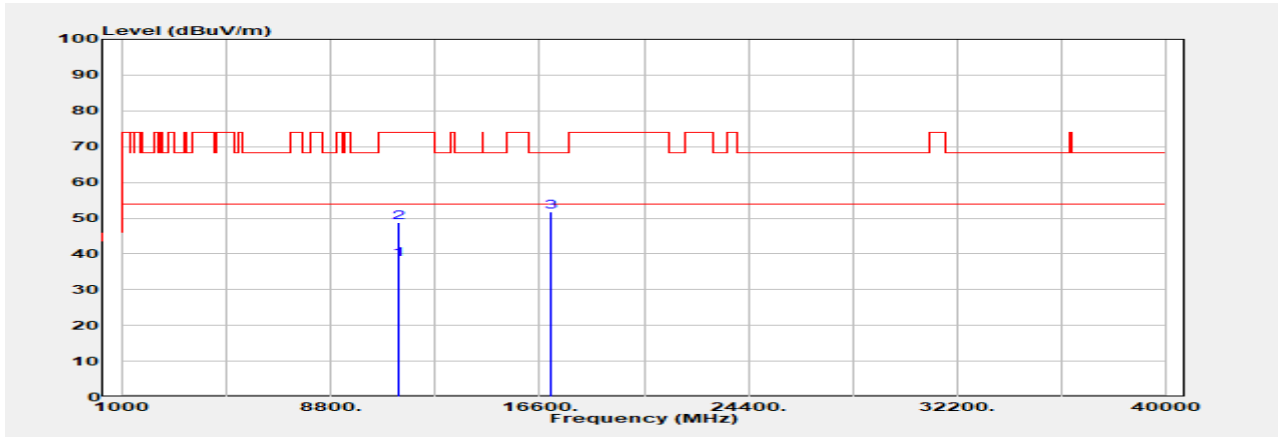

Freq. MHz	Detector Mode PK/QP/AVG	Spectrum Reading Level dBμV	Factor dB	Actual FS dBμV/m	Limit @3m dBμV/m	Margin dB
11340.000	Average	28.72	9.74	38.46	54.00	-15.54
11340.000	Peak	39.14	9.74	48.88	74.00	-25.12
17010.000	Peak	39.79	11.84	51.63	68.20	-16.57

Unless otherwise stated the results shown in this test report refer only to the sample(s) tested and such sample(s) are retained for 90 days only.

除非另有說明，此報告結果僅對測試之樣品負責，同時此樣品僅保留90天。本報告未經本公司書面許可，不可部份複製。

This document is issued by the Company subject to its General Conditions of Service printed overleaf, available on request or accessible at <http://www.sgs.com.tw/Terms-and-Conditions> and for electronic format documents, subject to Terms and Conditions for Electronic Documents at <http://www.sgs.com.tw/Terms-and-Conditions>. Attention is drawn to the limitation of liability, indemnification and jurisdiction issues defined therein. Any holder of this document is advised that information contained hereon reflects the Company's findings at the time of its intervention only and within the limits of Client's instructions, if any. The Company's sole responsibility is to its Client and this document does not exonerate parties to a transaction from exercising all their rights and obligations under the transaction documents. This document cannot be reproduced except in full, without prior written approval of the Company. Any unauthorized alteration, forgery or falsification of the content or appearance of this document is unlawful and offenders may be prosecuted to the fullest extent of the law.

Report Number	:TERF2308001923E2	Test Site	:SAC G Chamber
Operation Mode	:802.11be40	Test Date	:2023-09-23
Test Frequency	:5670 MHz	Temp./Humi.	:21.8°C/63%
Test Mode	:Tx	Antenna Pol.	:Horizontal
EUT Pol	:E2 Plane	Engineer	:Temo Chen

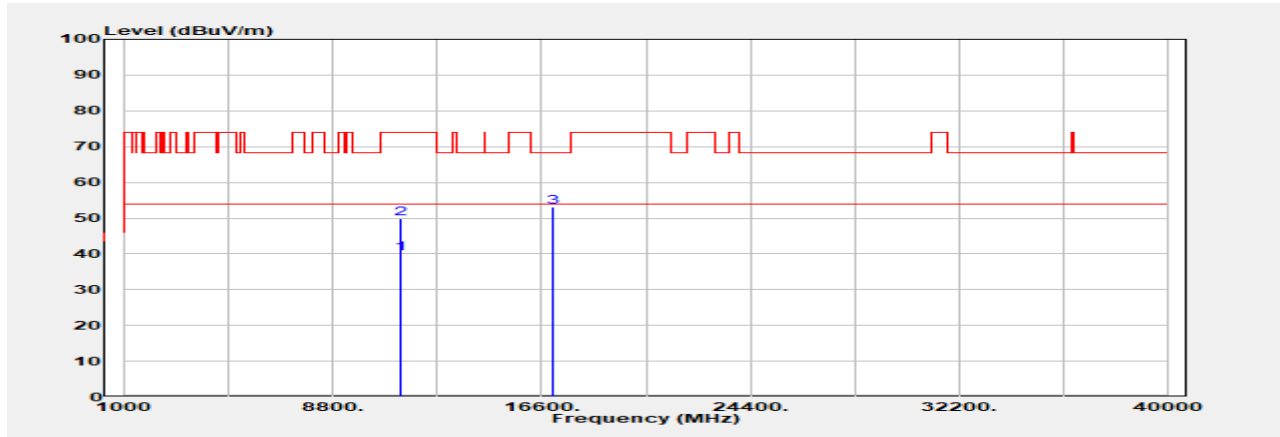

Freq. MHz	Detector Mode PK/QP/AVG	Spectrum Reading Level dB μ V	Factor dB	Actual FS dB μ V/m	Limit @3m dB μ V/m	Margin dB
11340.000	Average	30.31	9.74	40.05	54.00	-13.95
11340.000	Peak	40.03	9.74	49.77	74.00	-24.23
17010.000	Peak	41.41	11.84	53.25	68.20	-14.95

Unless otherwise stated the results shown in this test report refer only to the sample(s) tested and such sample(s) are retained for 90 days only.

除非另有說明，此報告結果僅對測試之樣品負責，同時此樣品僅保留90天。本報告未經本公司書面許可，不可部份複製。

This document is issued by the Company subject to its General Conditions of Service printed overleaf, available on request or accessible at <http://www.sgs.com.tw/Terms-and-Conditions> and for electronic format documents, subject to Terms and Conditions for Electronic Documents at <http://www.sgs.com.tw/Terms-and-Conditions>. Attention is drawn to the limitation of liability, indemnification and jurisdiction issues defined therein. Any holder of this document is advised that information contained hereon reflects the Company's findings at the time of its intervention only and within the limits of Client's instructions, if any. The Company's sole responsibility is to its Client and this document does not exonerate parties to a transaction from exercising all their rights and obligations under the transaction documents. This document cannot be reproduced except in full, without prior written approval of the Company. Any unauthorized alteration, forgery or falsification of the content or appearance of this document is unlawful and offenders may be prosecuted to the fullest extent of the law.

Report Number	:TERF2308001923E2	Test Site	:SAC G Chamber
Operation Mode	:802.11be40	Test Date	:2023-09-23
Test Frequency	:5710 MHz	Temp./Humi.	:21.8°C/63%
Test Mode	:Tx	Antenna Pol.	:Vertical
EUT Pol	:E2 Plane	Engineer	:Temo Chen

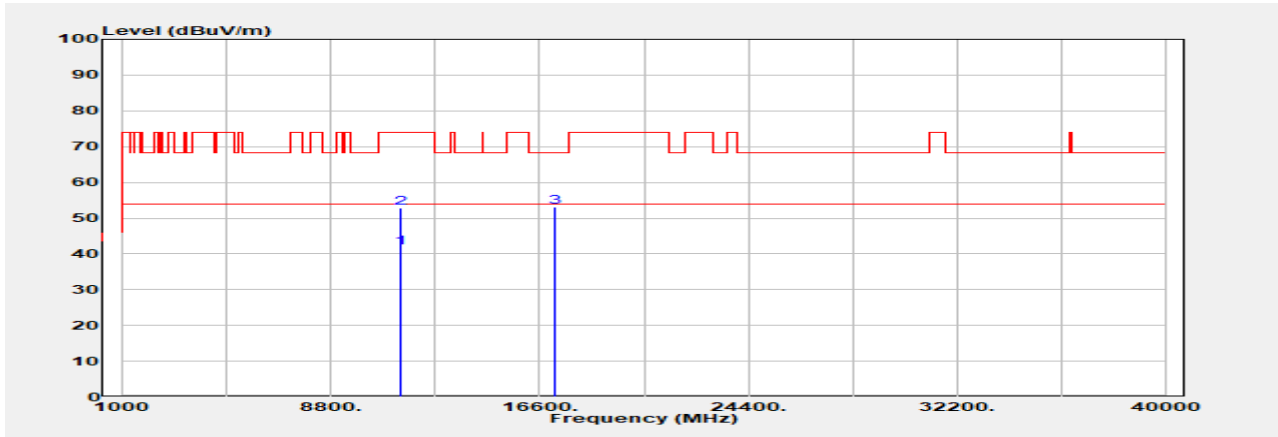

Freq. MHz	Detector Mode PK/QP/AVG	Spectrum Reading Level dBµV	Factor dB	Actual FS dBµV/m	Limit @3m dBµV/m	Margin dB
11420.000	Average	31.66	10.08	41.74	54.00	-12.26
11420.000	Peak	42.89	10.08	52.97	74.00	-21.03
17130.000	Peak	41.49	11.66	53.15	68.20	-15.05

Unless otherwise stated the results shown in this test report refer only to the sample(s) tested and such sample(s) are retained for 90 days only.

除非另有說明，此報告結果僅對測試之樣品負責，同時此樣品僅保留90天。本報告未經本公司書面許可，不可部份複製。

This document is issued by the Company subject to its General Conditions of Service printed overleaf, available on request or accessible at <http://www.sgs.com.tw/Terms-and-Conditions> and for electronic format documents, subject to Terms and Conditions for Electronic Documents at <http://www.sgs.com.tw/Terms-and-Conditions>. Attention is drawn to the limitation of liability, indemnification and jurisdiction issues defined therein. Any holder of this document is advised that information contained hereon reflects the Company's findings at the time of its intervention only and within the limits of Client's instructions, if any. The Company's sole responsibility is to its Client and this document does not exonerate parties to a transaction from exercising all their rights and obligations under the transaction documents. This document cannot be reproduced except in full, without prior written approval of the Company. Any unauthorized alteration, forgery or falsification of the content or appearance of this document is unlawful and offenders may be prosecuted to the fullest extent of the law.

Report Number	:TERF2308001923E2	Test Site	:SAC G Chamber
Operation Mode	:802.11be40	Test Date	:2023-09-23
Test Frequency	:5710 MHz	Temp./Humi.	:21.8°C/63%
Test Mode	:Tx	Antenna Pol.	:Horizontal
EUT Pol	:E2 Plane	Engineer	:Temo Chen

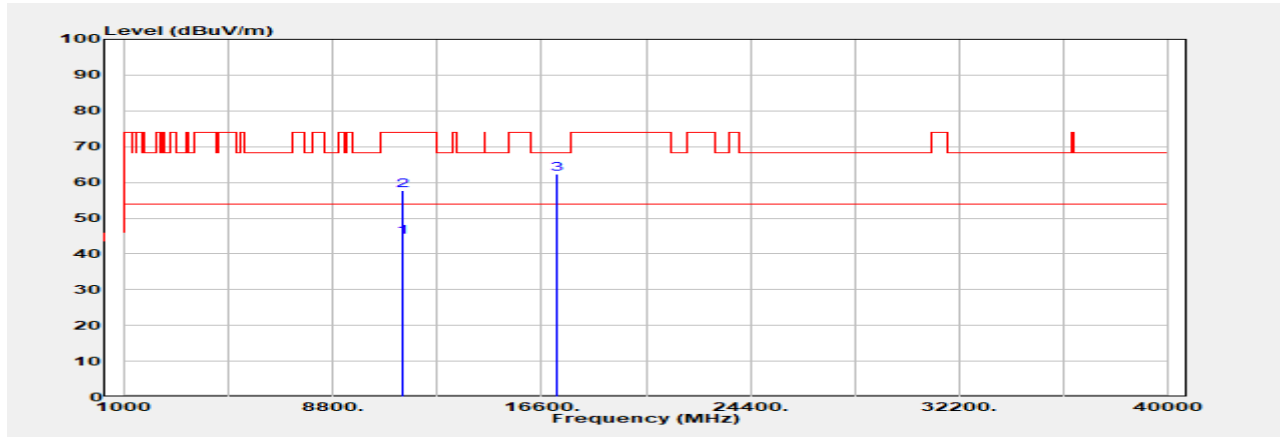

Freq. MHz	Detector Mode PK/QP/AVG	Spectrum Reading Level dBµV	Factor dB	Actual FS dBµV/m	Limit @3m dBµV/m	Margin dB
11420.000	Average	34.71	10.08	44.79	54.00	-9.21
11420.000	Peak	47.71	10.08	57.79	74.00	-16.21
17130.000	Peak	50.65	11.66	62.31	68.20	-5.89

Unless otherwise stated the results shown in this test report refer only to the sample(s) tested and such sample(s) are retained for 90 days only.

除非另有說明，此報告結果僅對測試之樣品負責，同時此樣品僅保留90天。本報告未經本公司書面許可，不可部份複製。

This document is issued by the Company subject to its General Conditions of Service printed overleaf, available on request or accessible at <http://www.sgs.com.tw/Terms-and-Conditions> and for electronic format documents, subject to Terms and Conditions for Electronic Documents at <http://www.sgs.com.tw/Terms-and-Conditions>. Attention is drawn to the limitation of liability, indemnification and jurisdiction issues defined therein. Any holder of this document is advised that information contained hereon reflects the Company's findings at the time of its intervention only and within the limits of Client's instructions, if any. The Company's sole responsibility is to its Client and this document does not exonerate parties to a transaction from exercising all their rights and obligations under the transaction documents. This document cannot be reproduced except in full, without prior written approval of the Company. Any unauthorized alteration, forgery or falsification of the content or appearance of this document is unlawful and offenders may be prosecuted to the fullest extent of the law.

Report Number	:TERF2308001923E2	Test Site	:SAC G Chamber
Operation Mode	:802.11be40	Test Date	:2023-09-23
Test Frequency	:5755 MHz	Temp./Humi.	:21.8°C/63%
Test Mode	:Tx	Antenna Pol.	:Vertical
EUT Pol	:E2 Plane	Engineer	:Temo Chen

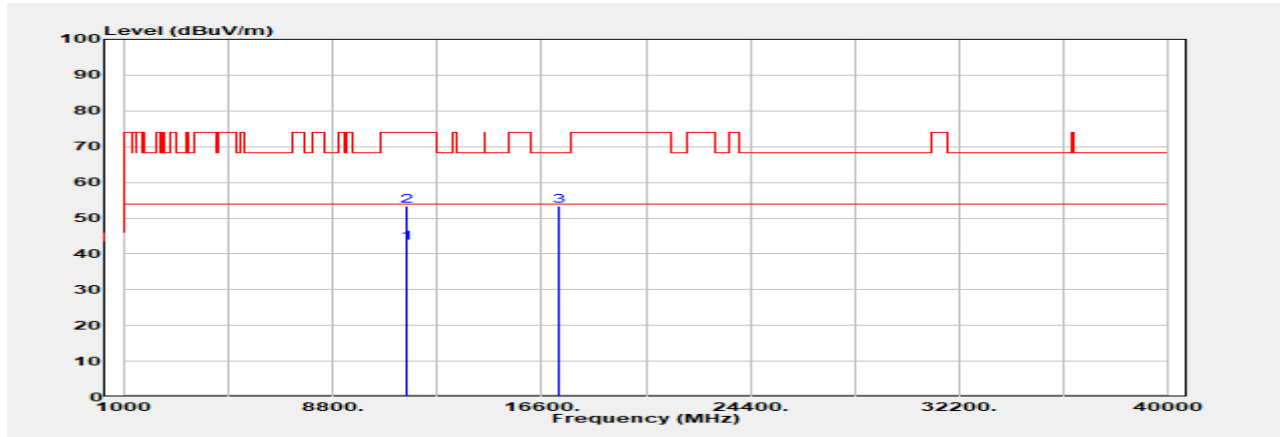

Freq. MHz	Detector Mode PK/QP/AVG	Spectrum Reading Level dB μ V	Factor dB	Actual FS dB μ V/m	Limit @3m dB μ V/m	Margin dB
11510.000	Average	31.97	11.05	43.02	54.00	-10.98
11510.000	Peak	42.33	11.05	53.38	74.00	-20.62
17265.000	Peak	42.34	11.18	53.52	68.20	-14.68

Unless otherwise stated the results shown in this test report refer only to the sample(s) tested and such sample(s) are retained for 90 days only.

除非另有說明，此報告結果僅對測試之樣品負責，同時此樣品僅保留90天。本報告未經本公司書面許可，不可部份複製。

This document is issued by the Company subject to its General Conditions of Service printed overleaf, available on request or accessible at <http://www.sgs.com.tw/Terms-and-Conditions> and for electronic format documents, subject to Terms and Conditions for Electronic Documents at <http://www.sgs.com.tw/Terms-and-Conditions>. Attention is drawn to the limitation of liability, indemnification and jurisdiction issues defined therein. Any holder of this document is advised that information contained hereon reflects the Company's findings at the time of its intervention only and within the limits of Client's instructions, if any. The Company's sole responsibility is to its Client and this document does not exonerate parties to a transaction from exercising all their rights and obligations under the transaction documents. This document cannot be reproduced except in full, without prior written approval of the Company. Any unauthorized alteration, forgery or falsification of the content or appearance of this document is unlawful and offenders may be prosecuted to the fullest extent of the law.

Report Number	:TERF2308001923E2	Test Site	:SAC G Chamber
Operation Mode	:802.11be40	Test Date	:2023-09-23
Test Frequency	:5755 MHz	Temp./Humi.	:21.8°C/63%
Test Mode	:Tx	Antenna Pol.	:Horizontal
EUT Pol	:E2 Plane	Engineer	:Temo Chen

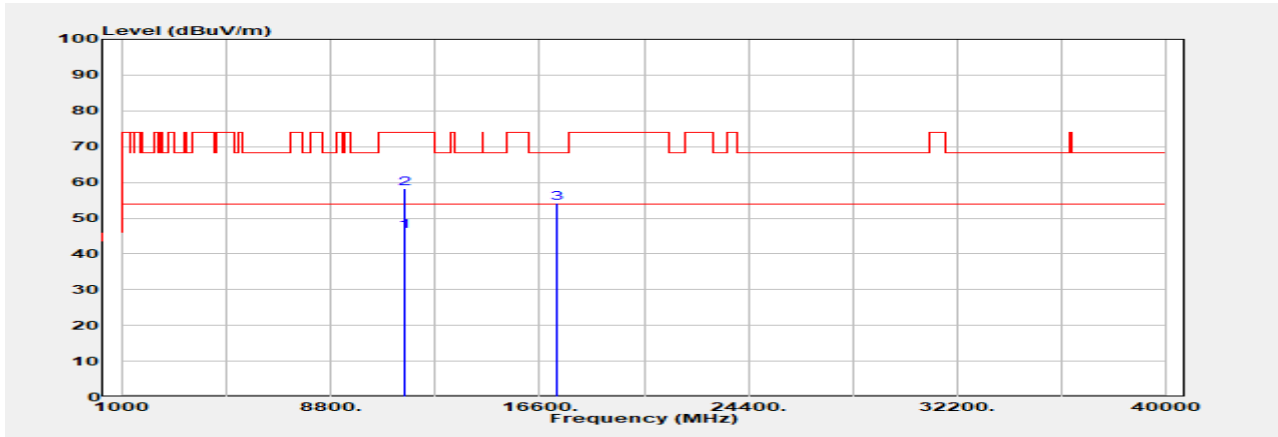

Freq. MHz	Detector Mode PK/QP/AVG	Spectrum Reading Level dBµV	Factor dB	Actual FS dBµV/m	Limit @3m dBµV/m	Margin dB
11510.000	Average	35.19	11.05	46.24	54.00	-7.76
11510.000	Peak	47.17	11.05	58.22	74.00	-15.78
17265.000	Peak	42.99	11.18	54.17	68.20	-14.03

Unless otherwise stated the results shown in this test report refer only to the sample(s) tested and such sample(s) are retained for 90 days only.

除非另有說明，此報告結果僅對測試之樣品負責，同時此樣品僅保留90天。本報告未經本公司書面許可，不可部份複製。

This document is issued by the Company subject to its General Conditions of Service printed overleaf, available on request or accessible at <http://www.sgs.com.tw/Terms-and-Conditions> and for electronic format documents, subject to Terms and Conditions for Electronic Documents at <http://www.sgs.com.tw/Terms-and-Conditions>. Attention is drawn to the limitation of liability, indemnification and jurisdiction issues defined therein. Any holder of this document is advised that information contained hereon reflects the Company's findings at the time of its intervention only and within the limits of Client's instructions, if any. The Company's sole responsibility is to its Client and this document does not exonerate parties to a transaction from exercising all their rights and obligations under the transaction documents. This document cannot be reproduced except in full, without prior written approval of the Company. Any unauthorized alteration, forgery or falsification of the content or appearance of this document is unlawful and offenders may be prosecuted to the fullest extent of the law.

Report Number	:TERF2308001923E2	Test Site	:SAC G Chamber
Operation Mode	:802.11be40	Test Date	:2023-09-23
Test Frequency	:5795 MHz	Temp./Humi.	:21.8°C/63%
Test Mode	:Tx	Antenna Pol.	:Vertical
EUT Pol	:E2 Plane	Engineer	:Temo Chen

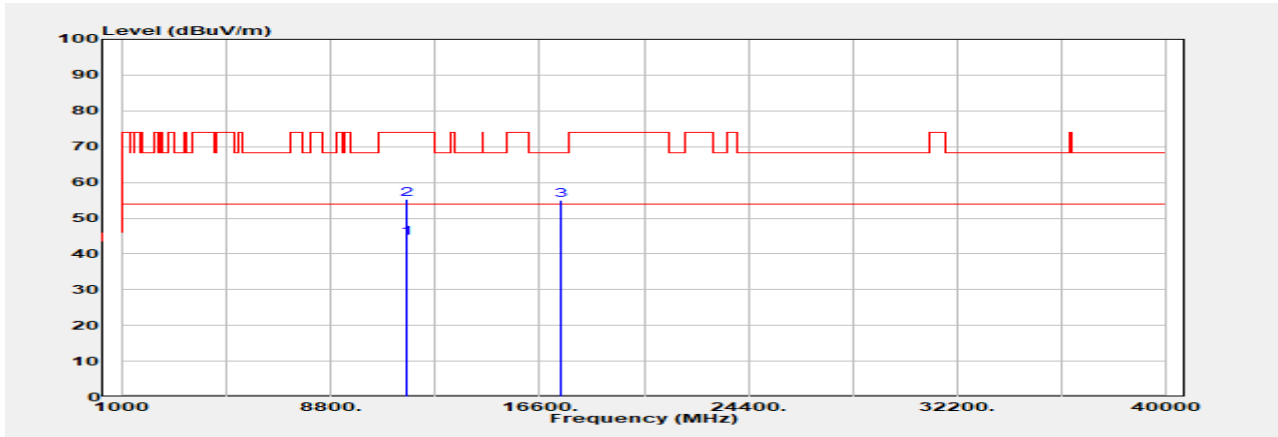

Freq. MHz	Detector Mode PK/QP/AVG	Spectrum Reading Level dB μ V	Factor dB	Actual FS dB μ V/m	Limit @3m dB μ V/m	Margin dB
11590.000	Average	34.50	9.85	44.35	54.00	-9.65
11590.000	Peak	45.41	9.85	55.26	74.00	-18.74
17385.000	Peak	43.01	11.94	54.95	68.20	-13.25

Unless otherwise stated the results shown in this test report refer only to the sample(s) tested and such sample(s) are retained for 90 days only.

除非另有說明，此報告結果僅對測試之樣品負責，同時此樣品僅保留90天。本報告未經本公司書面許可，不可部份複製。

This document is issued by the Company subject to its General Conditions of Service printed overleaf, available on request or accessible at <http://www.sgs.com.tw/Terms-and-Conditions> and for electronic format documents, subject to Terms and Conditions for Electronic Documents at <http://www.sgs.com.tw/Terms-and-Conditions>. Attention is drawn to the limitation of liability, indemnification and jurisdiction issues defined therein. Any holder of this document is advised that information contained hereon reflects the Company's findings at the time of its intervention only and within the limits of Client's instructions, if any. The Company's sole responsibility is to its Client and this document does not exonerate parties to a transaction from exercising all their rights and obligations under the transaction documents. This document cannot be reproduced except in full, without prior written approval of the Company. Any unauthorized alteration, forgery or falsification of the content or appearance of this document is unlawful and offenders may be prosecuted to the fullest extent of the law.

Report Number	:TERF2308001923E2	Test Site	:SAC G Chamber
Operation Mode	:802.11be40	Test Date	:2023-09-23
Test Frequency	:5795 MHz	Temp./Humi.	:21.8°C/63%
Test Mode	:Tx	Antenna Pol.	:Horizontal
EUT Pol	:E2 Plane	Engineer	:Temo Chen

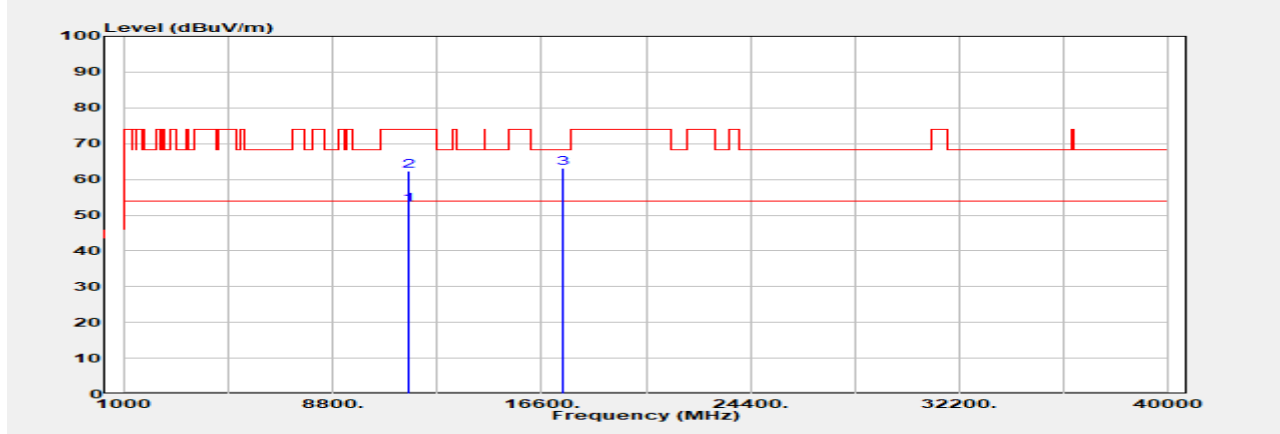

Freq. MHz	Detector Mode PK/QP/AVG	Spectrum Reading Level dB μ V	Factor dB	Actual FS dB μ V/m	Limit @3m dB μ V/m	Margin dB
11590.000	Average	42.96	9.85	52.81	54.00	-1.19
11590.000	Peak	52.44	9.85	62.29	74.00	-11.71
17385.000	Peak	51.25	11.94	63.19	68.20	-5.01

Unless otherwise stated the results shown in this test report refer only to the sample(s) tested and such sample(s) are retained for 90 days only.

除非另有說明，此報告結果僅對測試之樣品負責，同時此樣品僅保留90天。本報告未經本公司書面許可，不可部份複製。

This document is issued by the Company subject to its General Conditions of Service printed overleaf, available on request or accessible at <http://www.sgs.com.tw/Terms-and-Conditions> and for electronic format documents, subject to Terms and Conditions for Electronic Documents at <http://www.sgs.com.tw/Terms-and-Conditions>. Attention is drawn to the limitation of liability, indemnification and jurisdiction issues defined therein. Any holder of this document is advised that information contained hereon reflects the Company's findings at the time of its intervention only and within the limits of Client's instructions, if any. The Company's sole responsibility is to its Client and this document does not exonerate parties to a transaction from exercising all their rights and obligations under the transaction documents. This document cannot be reproduced except in full, without prior written approval of the Company. Any unauthorized alteration, forgery or falsification of the content or appearance of this document is unlawful and offenders may be prosecuted to the fullest extent of the law.

Report Number	:TERF2308001923E2	Test Site	:SAC G Chamber
Operation Mode	:802.11be80	Test Date	:2023-09-23
Test Frequency	:5210 MHz	Temp./Humi.	:21.8°C/63%
Test Mode	:Tx	Antenna Pol.	:Vertical
EUT Pol	:E2 Plane	Engineer	:Temo Chen

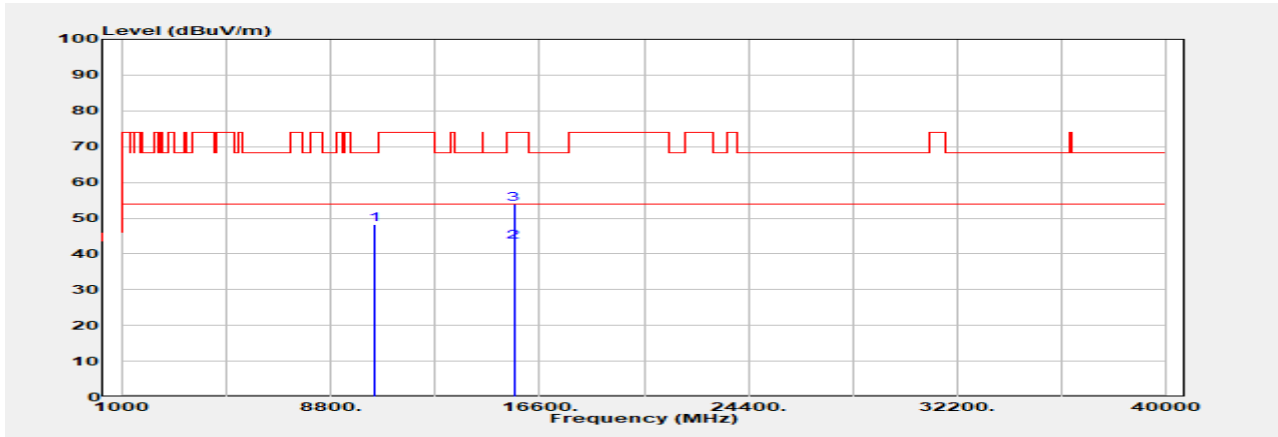

Freq. MHz	Detector Mode PK/QP/AVG	Spectrum Reading Level dB μ V	Factor dB	Actual FS dB μ V/m	Limit @3m dB μ V/m	Margin dB
10420.000	Peak	38.65	9.58	48.23	68.20	-19.97
15630.000	Average	31.25	12.11	43.36	54.00	-10.64
15630.000	Peak	41.71	12.11	53.82	74.00	-20.18

Unless otherwise stated the results shown in this test report refer only to the sample(s) tested and such sample(s) are retained for 90 days only.

除非另有說明，此報告結果僅對測試之樣品負責，同時此樣品僅保留90天。本報告未經本公司書面許可，不可部份複製。

This document is issued by the Company subject to its General Conditions of Service printed overleaf, available on request or accessible at <http://www.sgs.com.tw/Terms-and-Conditions> and for electronic format documents, subject to Terms and Conditions for Electronic Documents at <http://www.sgs.com.tw/Terms-and-Conditions>. Attention is drawn to the limitation of liability, indemnification and jurisdiction issues defined therein. Any holder of this document is advised that information contained hereon reflects the Company's findings at the time of its intervention only and within the limits of Client's instructions, if any. The Company's sole responsibility is to its Client and this document does not exonerate parties to a transaction from exercising all their rights and obligations under the transaction documents. This document cannot be reproduced except in full, without prior written approval of the Company. Any unauthorized alteration, forgery or falsification of the content or appearance of this document is unlawful and offenders may be prosecuted to the fullest extent of the law.

Report Number	:TERF2308001923E2	Test Site	:SAC G Chamber
Operation Mode	:802.11be80	Test Date	:2023-09-23
Test Frequency	:5210 MHz	Temp./Humi.	:21.8°C/63%
Test Mode	:Tx	Antenna Pol.	:Horizontal
EUT Pol	:E2 Plane	Engineer	:Temo Chen

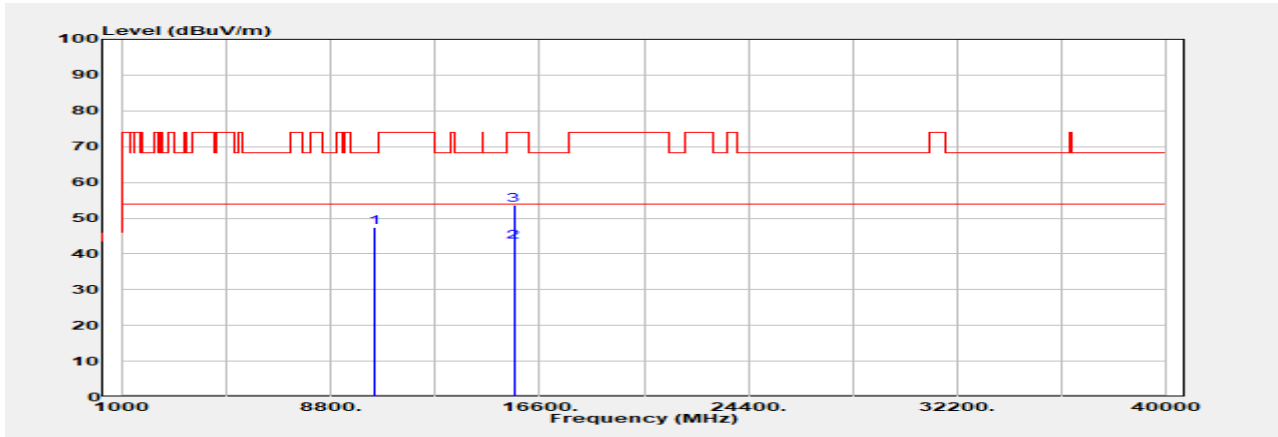

Freq. MHz	Detector Mode PK/QP/AVG	Spectrum Reading Level dB μ V	Factor dB	Actual FS dB μ V/m	Limit @3m dB μ V/m	Margin dB
10420.000	Peak	37.96	9.58	47.54	68.20	-20.66
15630.000	Average	31.29	12.11	43.41	54.00	-10.59
15630.000	Peak	41.49	12.11	53.60	74.00	-20.40

Unless otherwise stated the results shown in this test report refer only to the sample(s) tested and such sample(s) are retained for 90 days only.

除非另有說明，此報告結果僅對測試之樣品負責，同時此樣品僅保留90天。本報告未經本公司書面許可，不可部份複製。

This document is issued by the Company subject to its General Conditions of Service printed overleaf, available on request or accessible at <http://www.sgs.com.tw/Terms-and-Conditions> and for electronic format documents, subject to Terms and Conditions for Electronic Documents at <http://www.sgs.com.tw/Terms-and-Conditions>. Attention is drawn to the limitation of liability, indemnification and jurisdiction issues defined therein. Any holder of this document is advised that information contained hereon reflects the Company's findings at the time of its intervention only and within the limits of Client's instructions, if any. The Company's sole responsibility is to its Client and this document does not exonerate parties to a transaction from exercising all their rights and obligations under the transaction documents. This document cannot be reproduced except in full, without prior written approval of the Company. Any unauthorized alteration, forgery or falsification of the content or appearance of this document is unlawful and offenders may be prosecuted to the fullest extent of the law.

Report Number	:TERF2308001923E2	Test Site	:SAC G Chamber
Operation Mode	:802.11be80	Test Date	:2023-09-23
Test Frequency	:5290 MHz	Temp./Humi.	:21.8°C/63%
Test Mode	:Tx	Antenna Pol.	:Vertical
EUT Pol	:E2 Plane	Engineer	:Temo Chen

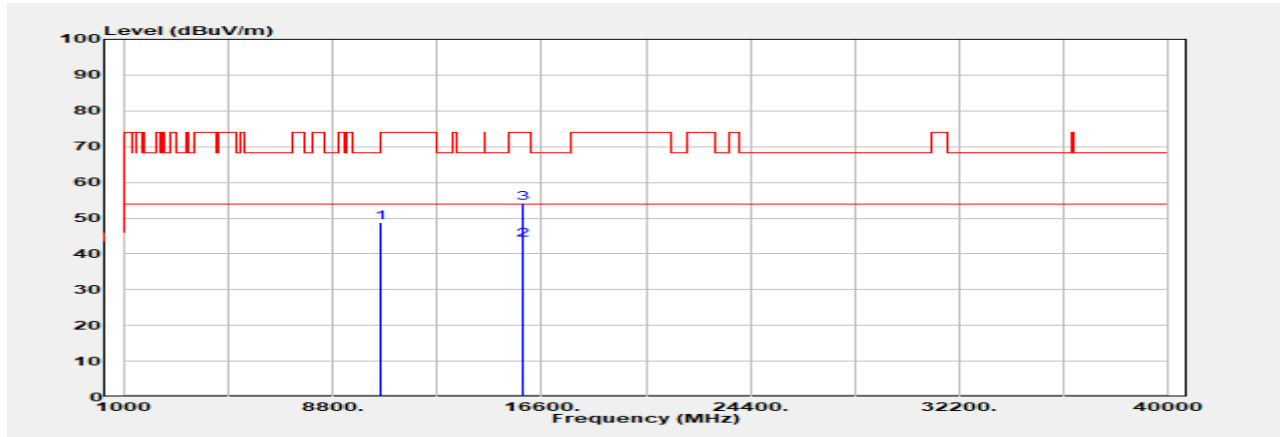

Freq. MHz	Detector Mode PK/QP/AVG	Spectrum Reading Level dBµV	Factor dB	Actual FS dBµV/m	Limit @3m dBµV/m	Margin dB
10580.000	Peak	38.68	9.98	48.66	68.20	-19.54
15870.000	Average	31.74	12.26	44.00	54.00	-10.00
15870.000	Peak	41.90	12.26	54.16	74.00	-19.84

Unless otherwise stated the results shown in this test report refer only to the sample(s) tested and such sample(s) are retained for 90 days only.

除非另有說明，此報告結果僅對測試之樣品負責，同時此樣品僅保留90天。本報告未經本公司書面許可，不可部份複製。

This document is issued by the Company subject to its General Conditions of Service printed overleaf, available on request or accessible at <http://www.sgs.com.tw/Terms-and-Conditions> and for electronic format documents, subject to Terms and Conditions for Electronic Documents at <http://www.sgs.com.tw/Terms-and-Conditions>. Attention is drawn to the limitation of liability, indemnification and jurisdiction issues defined therein. Any holder of this document is advised that information contained hereon reflects the Company's findings at the time of its intervention only and within the limits of Client's instructions, if any. The Company's sole responsibility is to its Client and this document does not exonerate parties to a transaction from exercising all their rights and obligations under the transaction documents. This document cannot be reproduced except in full, without prior written approval of the Company. Any unauthorized alteration, forgery or falsification of the content or appearance of this document is unlawful and offenders may be prosecuted to the fullest extent of the law.

Report Number	:TERF2308001923E2	Test Site	:SAC G Chamber
Operation Mode	:802.11be80	Test Date	:2023-09-23
Test Frequency	:5290 MHz	Temp./Humi.	:21.8°C/63%
Test Mode	:Tx	Antenna Pol.	:Horizontal
EUT Pol	:E2 Plane	Engineer	:Temo Chen

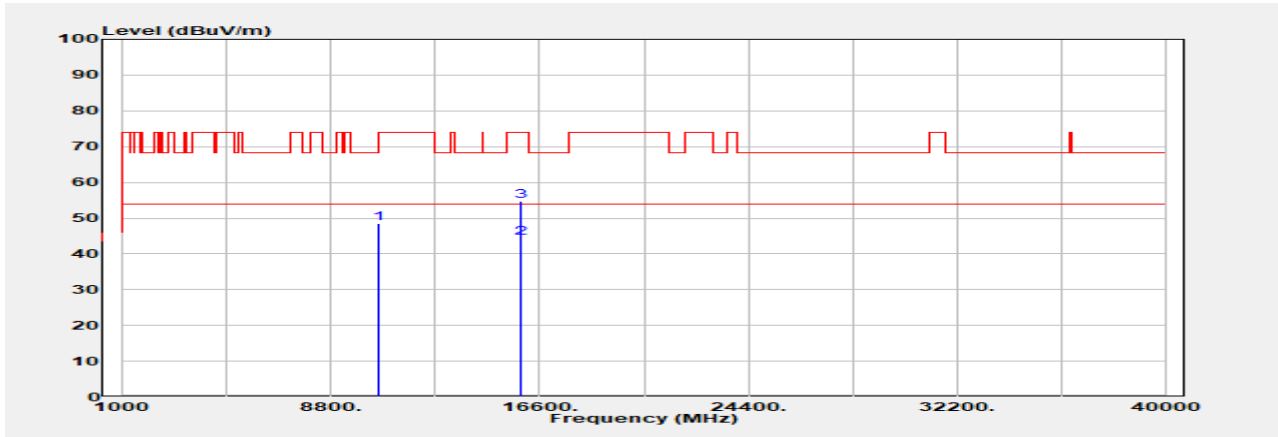

Freq. MHz	Detector Mode PK/QP/AVG	Spectrum Reading Level dBµV	Factor dB	Actual FS dBµV/m	Limit @3m dBµV/m	Margin dB
10580.000	Peak	38.42	9.98	48.40	68.20	-19.80
15870.000	Average	32.11	12.26	44.37	54.00	-9.63
15870.000	Peak	42.37	12.26	54.63	74.00	-19.37

Unless otherwise stated the results shown in this test report refer only to the sample(s) tested and such sample(s) are retained for 90 days only.

除非另有說明，此報告結果僅對測試之樣品負責，同時此樣品僅保留90天。本報告未經本公司書面許可，不可部份複製。

This document is issued by the Company subject to its General Conditions of Service printed overleaf, available on request or accessible at <http://www.sgs.com.tw/Terms-and-Conditions> and for electronic format documents, subject to Terms and Conditions for Electronic Documents at <http://www.sgs.com.tw/Terms-and-Conditions>. Attention is drawn to the limitation of liability, indemnification and jurisdiction issues defined therein. Any holder of this document is advised that information contained hereon reflects the Company's findings at the time of its intervention only and within the limits of Client's instructions, if any. The Company's sole responsibility is to its Client and this document does not exonerate parties to a transaction from exercising all their rights and obligations under the transaction documents. This document cannot be reproduced except in full, without prior written approval of the Company. Any unauthorized alteration, forgery or falsification of the content or appearance of this document is unlawful and offenders may be prosecuted to the fullest extent of the law.

Report Number	:TERF2308001923E2	Test Site	:SAC G Chamber
Operation Mode	:802.11be80	Test Date	:2023-09-23
Test Frequency	:5530 MHz	Temp./Humi.	:21.8°C/63%
Test Mode	:Tx	Antenna Pol.	:Vertical
EUT Pol	:E2 Plane	Engineer	:Temo Chen

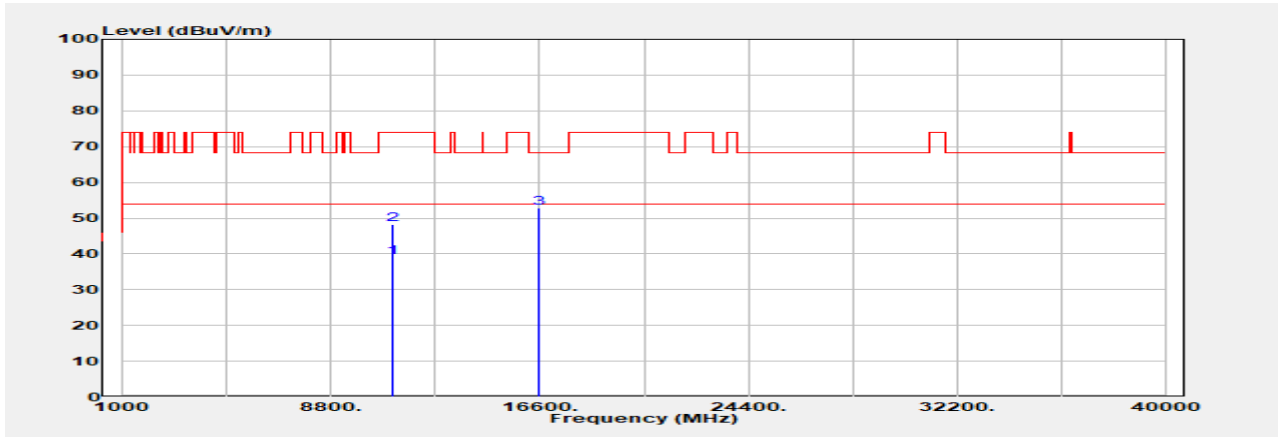

Freq. MHz	Detector Mode PK/QP/AVG	Spectrum Reading Level dBuV	Factor dB	Actual FS dBuV/m	Limit @3m dBuV/m	Margin dB
11060.000	Average	28.37	10.58	38.95	54.00	-15.05
11060.000	Peak	37.78	10.58	48.36	74.00	-25.64
16590.000	Peak	40.90	11.82	52.72	68.20	-15.48

Unless otherwise stated the results shown in this test report refer only to the sample(s) tested and such sample(s) are retained for 90 days only.

除非另有說明，此報告結果僅對測試之樣品負責，同時此樣品僅保留90天。本報告未經本公司書面許可，不可部份複製。

This document is issued by the Company subject to its General Conditions of Service printed overleaf, available on request or accessible at <http://www.sgs.com.tw/Terms-and-Conditions> and for electronic format documents, subject to Terms and Conditions for Electronic Documents at <http://www.sgs.com.tw/Terms-and-Conditions>. Attention is drawn to the limitation of liability, indemnification and jurisdiction issues defined therein. Any holder of this document is advised that information contained hereon reflects the Company's findings at the time of its intervention only and within the limits of Client's instructions, if any. The Company's sole responsibility is to its Client and this document does not exonerate parties to a transaction from exercising all their rights and obligations under the transaction documents. This document cannot be reproduced except in full, without prior written approval of the Company. Any unauthorized alteration, forgery or falsification of the content or appearance of this document is unlawful and offenders may be prosecuted to the fullest extent of the law.

Report Number	:TERF2308001923E2	Test Site	:SAC G Chamber
Operation Mode	:802.11be80	Test Date	:2023-09-23
Test Frequency	:5530 MHz	Temp./Humi.	:21.8°C/63%
Test Mode	:Tx	Antenna Pol.	:Horizontal
EUT Pol	:E2 Plane	Engineer	:Temo Chen

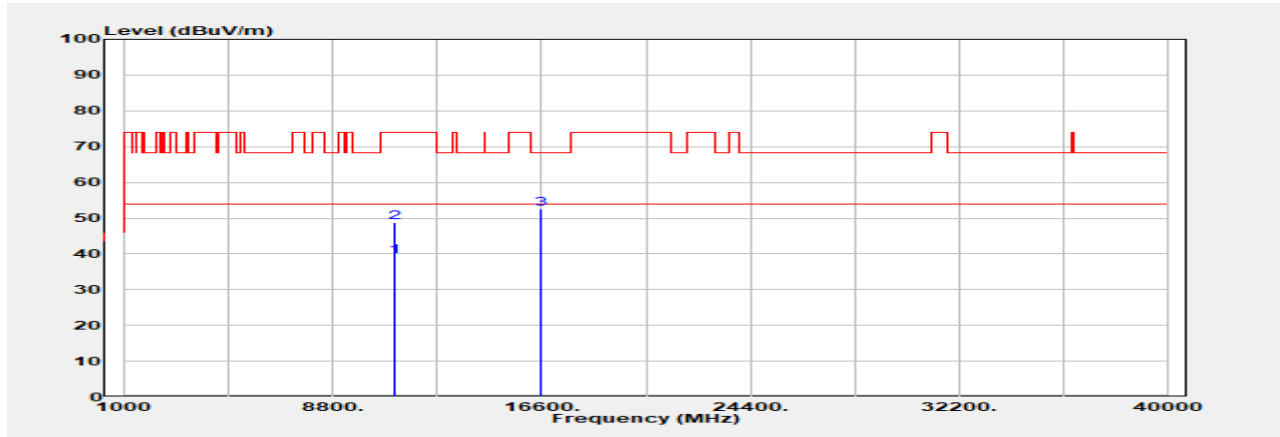

Freq. MHz	Detector Mode PK/QP/AVG	Spectrum Reading Level dBµV	Factor dB	Actual FS dBµV/m	Limit @3m dBµV/m	Margin dB
11060.000	Average	28.66	10.58	39.24	54.00	-14.76
11060.000	Peak	38.14	10.58	48.72	74.00	-25.28
16590.000	Peak	40.83	11.82	52.65	68.20	-15.55

Unless otherwise stated the results shown in this test report refer only to the sample(s) tested and such sample(s) are retained for 90 days only.

除非另有說明，此報告結果僅對測試之樣品負責，同時此樣品僅保留90天。本報告未經本公司書面許可，不可部份複製。

This document is issued by the Company subject to its General Conditions of Service printed overleaf, available on request or accessible at <http://www.sgs.com.tw/Terms-and-Conditions> and for electronic format documents, subject to Terms and Conditions for Electronic Documents at <http://www.sgs.com.tw/Terms-and-Conditions>. Attention is drawn to the limitation of liability, indemnification and jurisdiction issues defined therein. Any holder of this document is advised that information contained hereon reflects the Company's findings at the time of its intervention only and within the limits of Client's instructions, if any. The Company's sole responsibility is to its Client and this document does not exonerate parties to a transaction from exercising all their rights and obligations under the transaction documents. This document cannot be reproduced except in full, without prior written approval of the Company. Any unauthorized alteration, forgery or falsification of the content or appearance of this document is unlawful and offenders may be prosecuted to the fullest extent of the law.

Report Number	:TERF2308001923E2	Test Site	:SAC G Chamber
Operation Mode	:802.11be80	Test Date	:2023-09-23
Test Frequency	:5610 MHz	Temp./Humi.	:21.8°C/63%
Test Mode	:Tx	Antenna Pol.	:Vertical
EUT Pol	:E2 Plane	Engineer	:Temo Chen

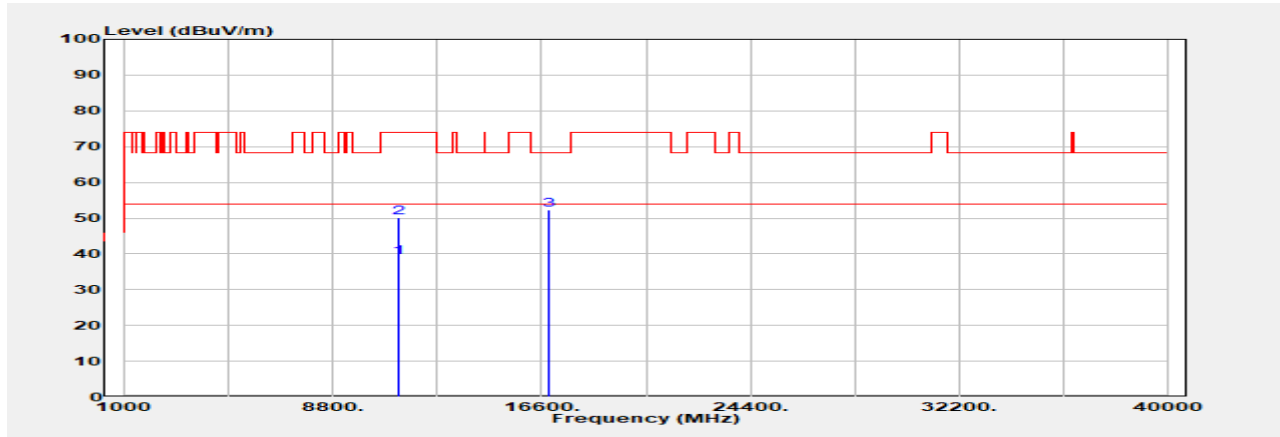

Freq. MHz	Detector Mode PK/QP/AVG	Spectrum Reading Level dBμV	Factor dB	Actual FS dBμV/m	Limit @3m dBμV/m	Margin dB
11220.000	Average	29.17	9.94	39.11	54.00	-14.89
11220.000	Peak	40.08	9.94	50.02	74.00	-23.98
16830.000	Peak	40.92	11.27	52.19	68.20	-16.01

Unless otherwise stated the results shown in this test report refer only to the sample(s) tested and such sample(s) are retained for 90 days only.

除非另有說明，此報告結果僅對測試之樣品負責，同時此樣品僅保留90天。本報告未經本公司書面許可，不可部份複製。

This document is issued by the Company subject to its General Conditions of Service printed overleaf, available on request or accessible at <http://www.sgs.com.tw/Terms-and-Conditions> and for electronic format documents, subject to Terms and Conditions for Electronic Documents at <http://www.sgs.com.tw/Terms-and-Conditions>. Attention is drawn to the limitation of liability, indemnification and jurisdiction issues defined therein. Any holder of this document is advised that information contained hereon reflects the Company's findings at the time of its intervention only and within the limits of Client's instructions, if any. The Company's sole responsibility is to its Client and this document does not exonerate parties to a transaction from exercising all their rights and obligations under the transaction documents. This document cannot be reproduced except in full, without prior written approval of the Company. Any unauthorized alteration, forgery or falsification of the content or appearance of this document is unlawful and offenders may be prosecuted to the fullest extent of the law.

Report Number	:TERF2308001923E2	Test Site	:SAC G Chamber
Operation Mode	:802.11be80	Test Date	:2023-09-23
Test Frequency	:5610 MHz	Temp./Humi.	:21.8°C/63%
Test Mode	:Tx	Antenna Pol.	:Horizontal
EUT Pol	:E2 Plane	Engineer	:Temo Chen

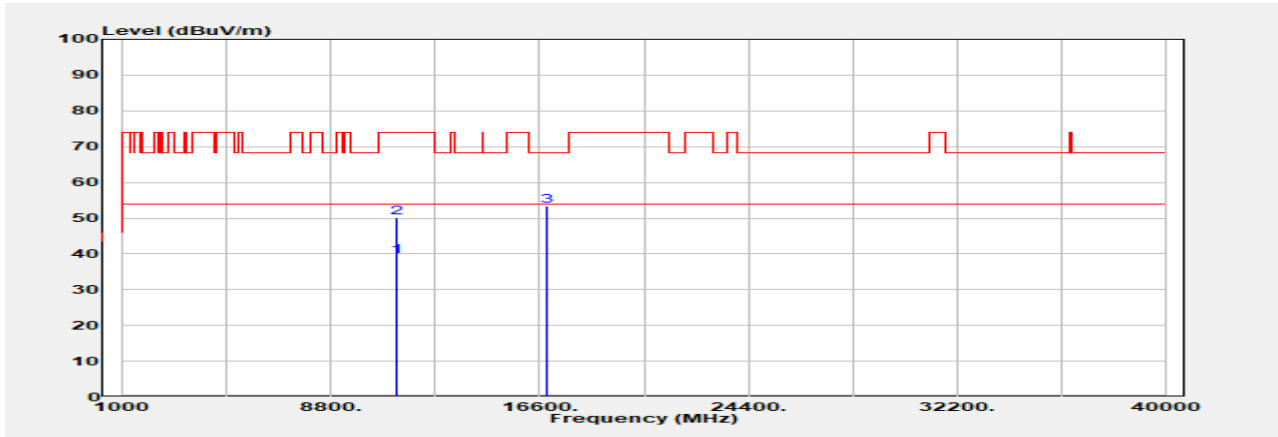

Freq. MHz	Detector Mode PK/QP/AVG	Spectrum Reading Level dBµV	Factor dB	Actual FS dBµV/m	Limit @3m dBµV/m	Margin dB
11220.000	Average	29.29	9.94	39.23	54.00	-14.77
11220.000	Peak	40.12	9.94	50.06	74.00	-23.94
16830.000	Peak	42.23	11.27	53.50	68.20	-14.70

Unless otherwise stated the results shown in this test report refer only to the sample(s) tested and such sample(s) are retained for 90 days only.

除非另有說明，此報告結果僅對測試之樣品負責，同時此樣品僅保留90天。本報告未經本公司書面許可，不可部份複製。

This document is issued by the Company subject to its General Conditions of Service printed overleaf, available on request or accessible at <http://www.sgs.com.tw/Terms-and-Conditions> and for electronic format documents, subject to Terms and Conditions for Electronic Documents at <http://www.sgs.com.tw/Terms-and-Conditions>. Attention is drawn to the limitation of liability, indemnification and jurisdiction issues defined therein. Any holder of this document is advised that information contained hereon reflects the Company's findings at the time of its intervention only and within the limits of Client's instructions, if any. The Company's sole responsibility is to its Client and this document does not exonerate parties to a transaction from exercising all their rights and obligations under the transaction documents. This document cannot be reproduced except in full, without prior written approval of the Company. Any unauthorized alteration, forgery or falsification of the content or appearance of this document is unlawful and offenders may be prosecuted to the fullest extent of the law.

Report Number	:TERF2308001923E2	Test Site	:SAC G Chamber
Operation Mode	:802.11be80	Test Date	:2023-09-23
Test Frequency	:5690 MHz	Temp./Humi.	:21.8°C/63%
Test Mode	:Tx	Antenna Pol.	:Vertical
EUT Pol	:E2 Plane	Engineer	:Temo Chen

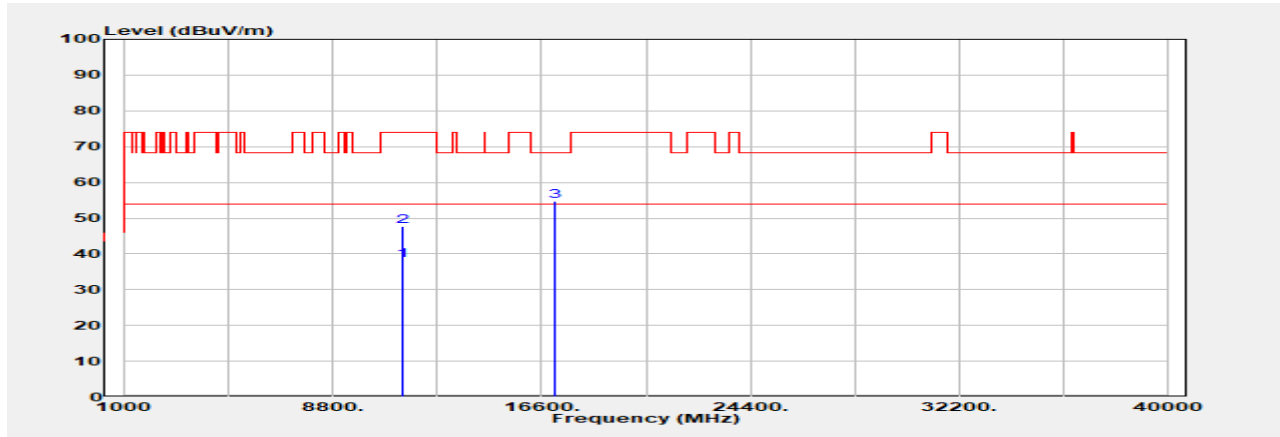

Freq. MHz	Detector Mode	Spectrum Reading Level dB μ V	Factor dB	Actual FS dB μ V/m	Limit @3m dB μ V/m	Margin dB
11380.000	Average	28.36	9.78	38.14	54.00	-15.86
11380.000	Peak	37.94	9.78	47.72	74.00	-26.28
17070.000	Peak	42.67	12.08	54.75	68.20	-13.45

Unless otherwise stated the results shown in this test report refer only to the sample(s) tested and such sample(s) are retained for 90 days only.

除非另有說明，此報告結果僅對測試之樣品負責，同時此樣品僅保留90天。本報告未經本公司書面許可，不可部份複製。

This document is issued by the Company subject to its General Conditions of Service printed overleaf, available on request or accessible at <http://www.sgs.com.tw/Terms-and-Conditions> and for electronic format documents, subject to Terms and Conditions for Electronic Documents at <http://www.sgs.com.tw/Terms-and-Conditions>. Attention is drawn to the limitation of liability, indemnification and jurisdiction issues defined therein. Any holder of this document is advised that information contained hereon reflects the Company's findings at the time of its intervention only and within the limits of Client's instructions, if any. The Company's sole responsibility is to its Client and this document does not exonerate parties to a transaction from exercising all their rights and obligations under the transaction documents. This document cannot be reproduced except in full, without prior written approval of the Company. Any unauthorized alteration, forgery or falsification of the content or appearance of this document is unlawful and offenders may be prosecuted to the fullest extent of the law.

Report Number	:TERF2308001923E2	Test Site	:SAC G Chamber
Operation Mode	:802.11be80	Test Date	:2023-09-23
Test Frequency	:5690 MHz	Temp./Humi.	:21.8°C/63%
Test Mode	:Tx	Antenna Pol.	:Horizontal
EUT Pol	:E2 Plane	Engineer	:Temo Chen

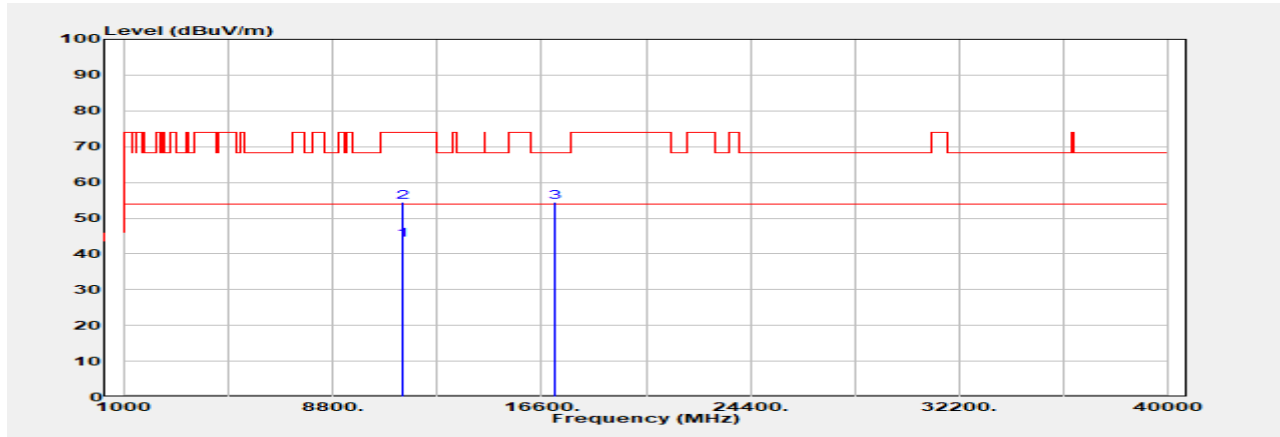

Freq. MHz	Detector Mode PK/QP/AVG	Spectrum Reading Level dBµV	Factor dB	Actual FS dBµV/m	Limit @3m dBµV/m	Margin dB
11380.000	Average	34.10	9.78	43.88	54.00	-10.12
11380.000	Peak	44.56	9.78	54.34	74.00	-19.66
17070.000	Peak	42.41	12.08	54.49	68.20	-13.71

Unless otherwise stated the results shown in this test report refer only to the sample(s) tested and such sample(s) are retained for 90 days only.

除非另有說明，此報告結果僅對測試之樣品負責，同時此樣品僅保留90天。本報告未經本公司書面許可，不可部份複製。

This document is issued by the Company subject to its General Conditions of Service printed overleaf, available on request or accessible at <http://www.sgs.com.tw/Terms-and-Conditions> and for electronic format documents, subject to Terms and Conditions for Electronic Documents at <http://www.sgs.com.tw/Terms-and-Conditions>. Attention is drawn to the limitation of liability, indemnification and jurisdiction issues defined therein. Any holder of this document is advised that information contained hereon reflects the Company's findings at the time of its intervention only and within the limits of Client's instructions, if any. The Company's sole responsibility is to its Client and this document does not exonerate parties to a transaction from exercising all their rights and obligations under the transaction documents. This document cannot be reproduced except in full, without prior written approval of the Company. Any unauthorized alteration, forgery or falsification of the content or appearance of this document is unlawful and offenders may be prosecuted to the fullest extent of the law.

Report Number	:TERF2308001923E2	Test Site	:SAC G Chamber
Operation Mode	:802.11be80	Test Date	:2023-09-23
Test Frequency	:5775 MHz	Temp./Humi.	:21.8°C/63%
Test Mode	:Tx	Antenna Pol.	:Vertical
EUT Pol	:E2 Plane	Engineer	:Temo Chen

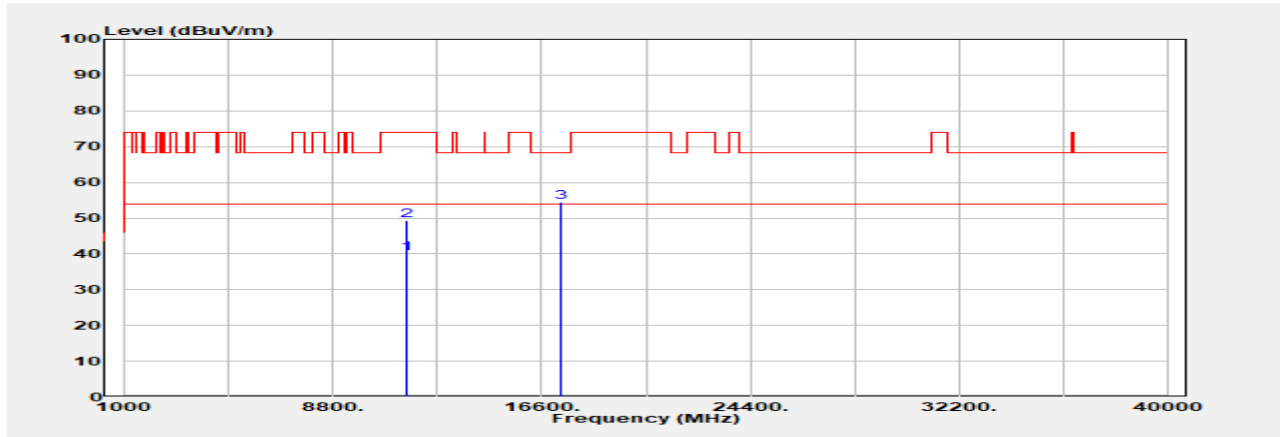

Freq. MHz	Detector Mode PK/QP/AVG	Spectrum Reading Level dB μ V	Factor dB	Actual FS dB μ V/m	Limit @3m dB μ V/m	Margin dB
11550.000	Average	29.74	10.45	40.19	54.00	-13.81
11550.000	Peak	39.00	10.45	49.45	74.00	-24.55
17325.000	Peak	42.88	11.70	54.58	68.20	-13.62

Unless otherwise stated the results shown in this test report refer only to the sample(s) tested and such sample(s) are retained for 90 days only.

除非另有說明，此報告結果僅對測試之樣品負責，同時此樣品僅保留90天。本報告未經本公司書面許可，不可部份複製。

This document is issued by the Company subject to its General Conditions of Service printed overleaf, available on request or accessible at <http://www.sgs.com.tw/Terms-and-Conditions> and for electronic format documents, subject to Terms and Conditions for Electronic Documents at <http://www.sgs.com.tw/Terms-and-Conditions>. Attention is drawn to the limitation of liability, indemnification and jurisdiction issues defined therein. Any holder of this document is advised that information contained hereon reflects the Company's findings at the time of its intervention only and within the limits of Client's instructions, if any. The Company's sole responsibility is to its Client and this document does not exonerate parties to a transaction from exercising all their rights and obligations under the transaction documents. This document cannot be reproduced except in full, without prior written approval of the Company. Any unauthorized alteration, forgery or falsification of the content or appearance of this document is unlawful and offenders may be prosecuted to the fullest extent of the law.

Report Number	:TERF2308001923E2	Test Site	:SAC G Chamber
Operation Mode	:802.11be80	Test Date	:2023-09-23
Test Frequency	:5775 MHz	Temp./Humi.	:21.8°C/63%
Test Mode	:Tx	Antenna Pol.	:Horizontal
EUT Pol	:E2 Plane	Engineer	:Temo Chen

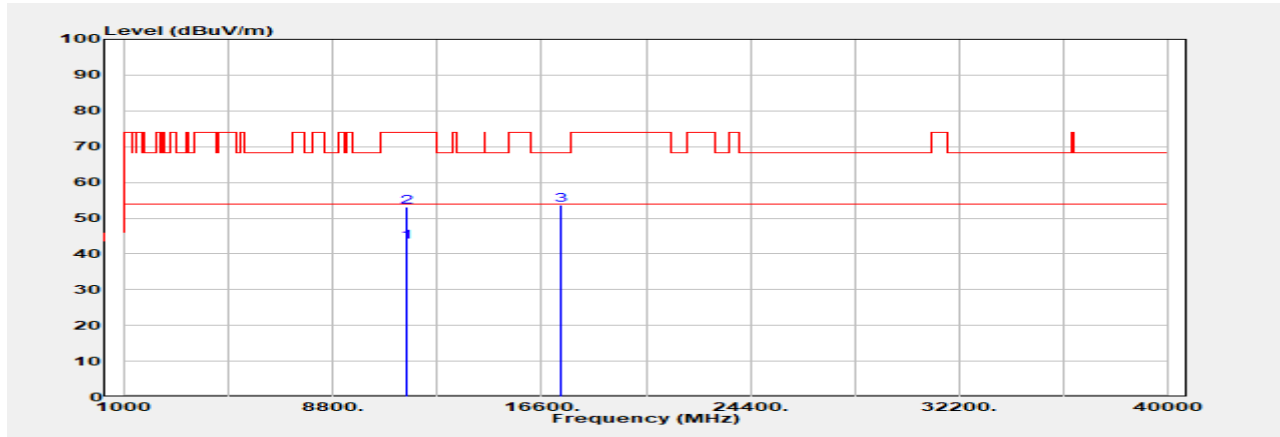

Freq. MHz	Detector Mode PK/QP/AVG	Spectrum Reading Level dBµV	Factor dB	Actual FS dBµV/m	Limit @3m dBµV/m	Margin dB
11550.000	Average	32.96	10.45	43.41	54.00	-10.59
11550.000	Peak	42.80	10.45	53.25	74.00	-20.75
17325.000	Peak	41.84	11.70	53.54	68.20	-14.66

Unless otherwise stated the results shown in this test report refer only to the sample(s) tested and such sample(s) are retained for 90 days only.

除非另有說明，此報告結果僅對測試之樣品負責，同時此樣品僅保留90天。本報告未經本公司書面許可，不可部份複製。

This document is issued by the Company subject to its General Conditions of Service printed overleaf, available on request or accessible at <http://www.sgs.com.tw/Terms-and-Conditions> and for electronic format documents, subject to Terms and Conditions for Electronic Documents at <http://www.sgs.com.tw/Terms-and-Conditions>. Attention is drawn to the limitation of liability, indemnification and jurisdiction issues defined therein. Any holder of this document is advised that information contained hereon reflects the Company's findings at the time of its intervention only and within the limits of Client's instructions, if any. The Company's sole responsibility is to its Client and this document does not exonerate parties to a transaction from exercising all their rights and obligations under the transaction documents. This document cannot be reproduced except in full, without prior written approval of the Company. Any unauthorized alteration, forgery or falsification of the content or appearance of this document is unlawful and offenders may be prosecuted to the fullest extent of the law.

Report Number	:TERF2308001923E2	Test Site	:SAC G Chamber
Operation Mode	:802.11be160	Test Date	:2023-09-23
Test Frequency	:5250 MHz	Temp./Humi.	:21.8°C/63%
Test Mode	:Tx	Antenna Pol.	:Vertical
EUT Pol	:E2 Plane	Engineer	:Temo Chen

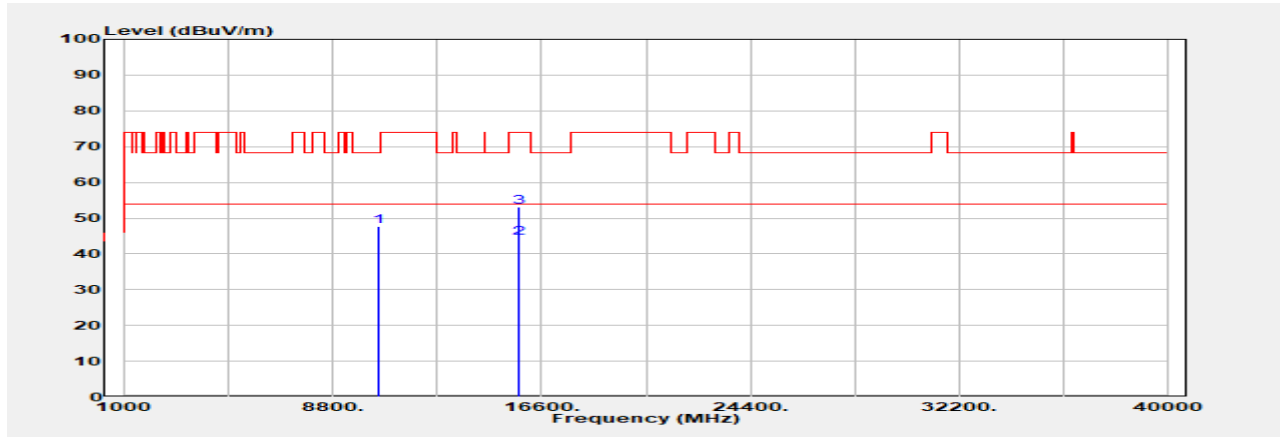

Freq. MHz	Detector Mode PK/QP/AVG	Spectrum Reading Level dBµV	Factor dB	Actual FS dBµV/m	Limit @3m dBµV/m	Margin dB
10500.000	Peak	37.87	9.90	47.77	68.20	-20.43
15750.000	Average	31.84	12.50	44.34	54.00	-9.66
15750.000	Peak	40.62	12.50	53.12	74.00	-20.88

Unless otherwise stated the results shown in this test report refer only to the sample(s) tested and such sample(s) are retained for 90 days only.

除非另有說明，此報告結果僅對測試之樣品負責，同時此樣品僅保留90天。本報告未經本公司書面許可，不可部份複製。

This document is issued by the Company subject to its General Conditions of Service printed overleaf, available on request or accessible at <http://www.sgs.com.tw/Terms-and-Conditions> and for electronic format documents, subject to Terms and Conditions for Electronic Documents at <http://www.sgs.com.tw/Terms-and-Conditions>. Attention is drawn to the limitation of liability, indemnification and jurisdiction issues defined therein. Any holder of this document is advised that information contained hereon reflects the Company's findings at the time of its intervention only and within the limits of Client's instructions, if any. The Company's sole responsibility is to its Client and this document does not exonerate parties to a transaction from exercising all their rights and obligations under the transaction documents. This document cannot be reproduced except in full, without prior written approval of the Company. Any unauthorized alteration, forgery or falsification of the content or appearance of this document is unlawful and offenders may be prosecuted to the fullest extent of the law.

Report Number	:TERF2308001923E2	Test Site	:SAC G Chamber
Operation Mode	:802.11be160	Test Date	:2023-09-23
Test Frequency	:5250 MHz	Temp./Humi.	:21.8°C/63%
Test Mode	:Tx	Antenna Pol.	:Horizontal
EUT Pol	:E2 Plane	Engineer	:Temo Chen

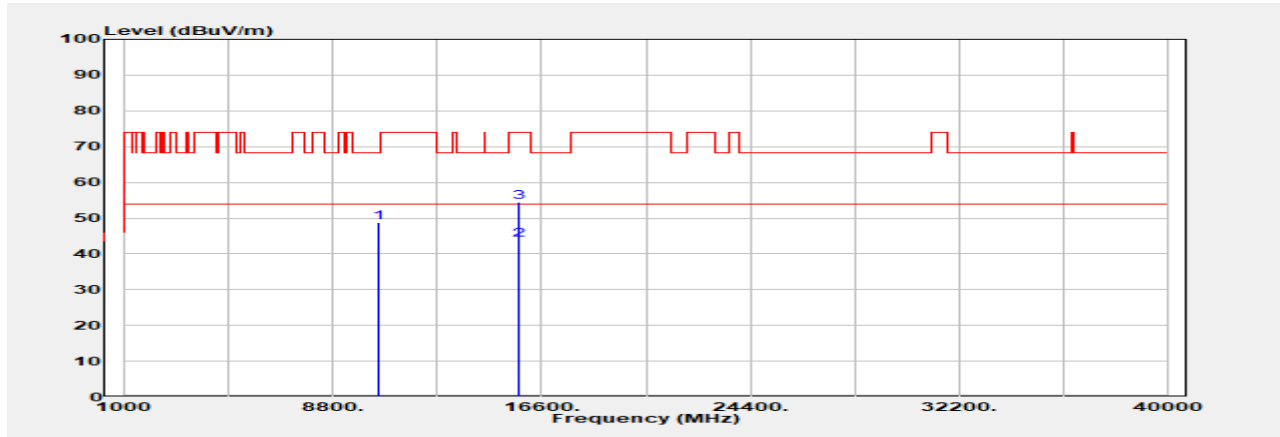

Freq. MHz	Detector Mode PK/QP/AVG	Spectrum Reading Level dB μ V	Factor dB	Actual FS dB μ V/m	Limit @3m dB μ V/m	Margin dB
10500.000	Peak	38.84	9.90	48.74	68.20	-19.47
15750.000	Average	31.32	12.50	43.82	54.00	-10.18
15750.000	Peak	41.95	12.50	54.45	74.00	-19.55

Unless otherwise stated the results shown in this test report refer only to the sample(s) tested and such sample(s) are retained for 90 days only.

除非另有說明，此報告結果僅對測試之樣品負責，同時此樣品僅保留90天。本報告未經本公司書面許可，不可部份複製。

This document is issued by the Company subject to its General Conditions of Service printed overleaf, available on request or accessible at <http://www.sgs.com.tw/Terms-and-Conditions> and for electronic format documents, subject to Terms and Conditions for Electronic Documents at <http://www.sgs.com.tw/Terms-and-Conditions>. Attention is drawn to the limitation of liability, indemnification and jurisdiction issues defined therein. Any holder of this document is advised that information contained hereon reflects the Company's findings at the time of its intervention only and within the limits of Client's instructions, if any. The Company's sole responsibility is to its Client and this document does not exonerate parties to a transaction from exercising all their rights and obligations under the transaction documents. This document cannot be reproduced except in full, without prior written approval of the Company. Any unauthorized alteration, forgery or falsification of the content or appearance of this document is unlawful and offenders may be prosecuted to the fullest extent of the law.

Report Number	:TERF2308001923E2	Test Site	:SAC G Chamber
Operation Mode	:802.11be160	Test Date	:2023-09-23
Test Frequency	:5570 MHz	Temp./Humi.	:21.8°C/63%
Test Mode	:Tx	Antenna Pol.	:Vertical
EUT Pol	:E2 Plane	Engineer	:Temo Chen

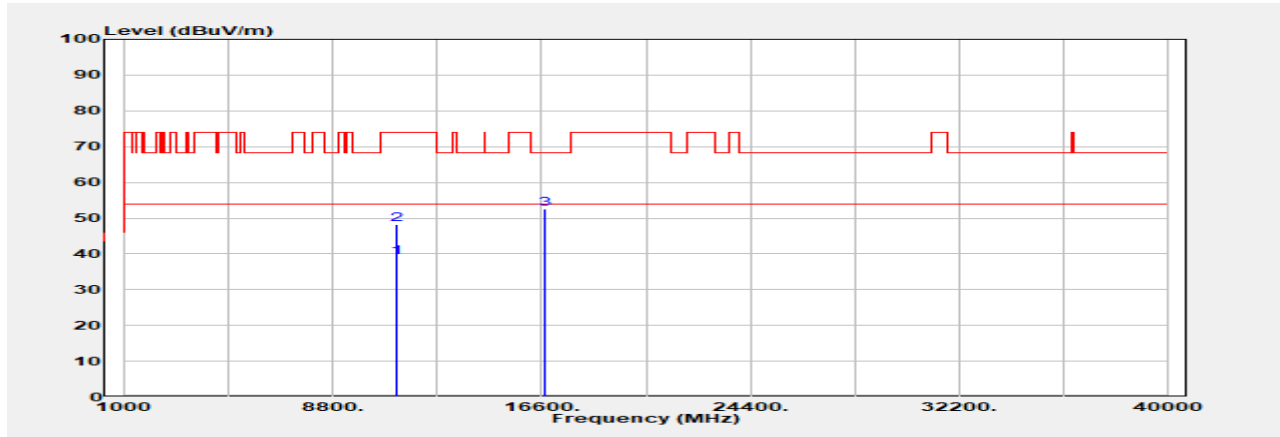

Freq. MHz	Detector Mode PK/QP/AVG	Spectrum Reading Level dBuV	Factor dB	Actual FS dBuV/m	Limit @3m dBuV/m	Margin dB
11140.000	Average	29.32	9.82	39.14	54.00	-14.86
11140.000	Peak	38.35	9.82	48.17	74.00	-25.83
16710.000	Peak	40.77	11.69	52.46	68.20	-15.74

Unless otherwise stated the results shown in this test report refer only to the sample(s) tested and such sample(s) are retained for 90 days only.

除非另有說明，此報告結果僅對測試之樣品負責，同時此樣品僅保留90天。本報告未經本公司書面許可，不可部份複製。

This document is issued by the Company subject to its General Conditions of Service printed overleaf, available on request or accessible at <http://www.sgs.com.tw/Terms-and-Conditions> and for electronic format documents, subject to Terms and Conditions for Electronic Documents at <http://www.sgs.com.tw/Terms-and-Conditions>. Attention is drawn to the limitation of liability, indemnification and jurisdiction issues defined therein. Any holder of this document is advised that information contained hereon reflects the Company's findings at the time of its intervention only and within the limits of Client's instructions, if any. The Company's sole responsibility is to its Client and this document does not exonerate parties to a transaction from exercising all their rights and obligations under the transaction documents. This document cannot be reproduced except in full, without prior written approval of the Company. Any unauthorized alteration, forgery or falsification of the content or appearance of this document is unlawful and offenders may be prosecuted to the fullest extent of the law.

Report Number	:TERF2308001923E2	Test Site	:SAC G Chamber
Operation Mode	:802.11be160	Test Date	:2023-09-23
Test Frequency	:5570 MHz	Temp./Humi.	:21.8°C/63%
Test Mode	:Tx	Antenna Pol.	:Horizontal
EUT Pol	:E2 Plane	Engineer	:Temo Chen

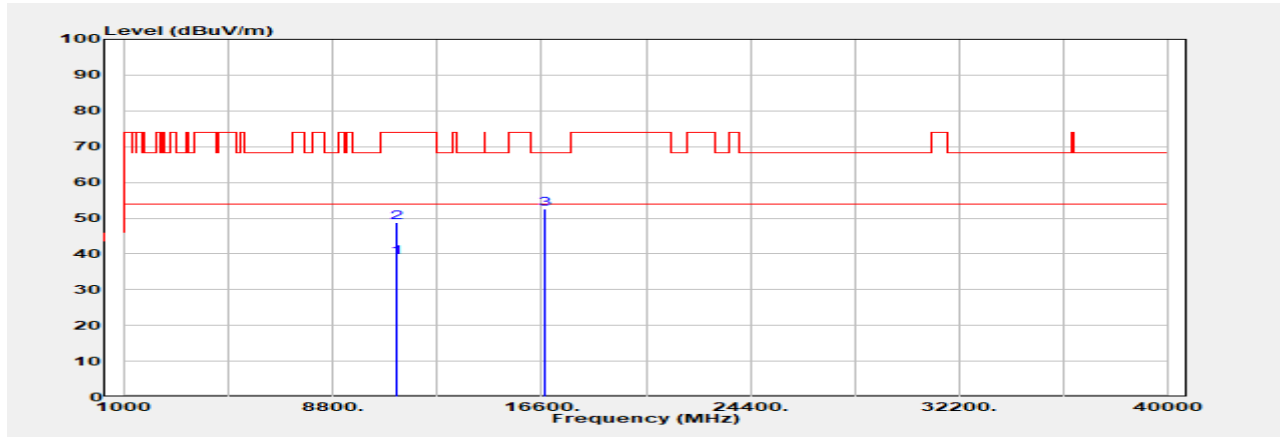

Freq. MHz	Detector Mode PK/QP/AVG	Spectrum Reading Level dBµV	Factor dB	Actual FS dBµV/m	Limit @3m dBµV/m	Margin dB
11140.000	Average	29.33	9.82	39.15	54.00	-14.85
11140.000	Peak	38.91	9.82	48.73	74.00	-25.27
16710.000	Peak	40.84	11.69	52.53	68.20	-15.67

Unless otherwise stated the results shown in this test report refer only to the sample(s) tested and such sample(s) are retained for 90 days only.

除非另有說明，此報告結果僅對測試之樣品負責，同時此樣品僅保留90天。本報告未經本公司書面許可，不可部份複製。

This document is issued by the Company subject to its General Conditions of Service printed overleaf, available on request or accessible at <http://www.sgs.com.tw/Terms-and-Conditions> and for electronic format documents, subject to Terms and Conditions for Electronic Documents at <http://www.sgs.com.tw/Terms-and-Conditions>. Attention is drawn to the limitation of liability, indemnification and jurisdiction issues defined therein. Any holder of this document is advised that information contained hereon reflects the Company's findings at the time of its intervention only and within the limits of Client's instructions, if any. The Company's sole responsibility is to its Client and this document does not exonerate parties to a transaction from exercising all their rights and obligations under the transaction documents. This document cannot be reproduced except in full, without prior written approval of the Company. Any unauthorized alteration, forgery or falsification of the content or appearance of this document is unlawful and offenders may be prosecuted to the fullest extent of the law.

Spot Check
Mode: Beaforming

Report Number	:TERF2310002502E2	Test Site	:SAC G Chamber
Operation Mode	:802.11n20	Test Date	:2023-12-06
Test Frequency	:5825 MHz	Temp./Humi.	:22.6°C/68%
Test Mode	:Tx	Antenna Pol.	:Vertical
EUT Pol	:E2 Plane	Engineer	:Temo Chen

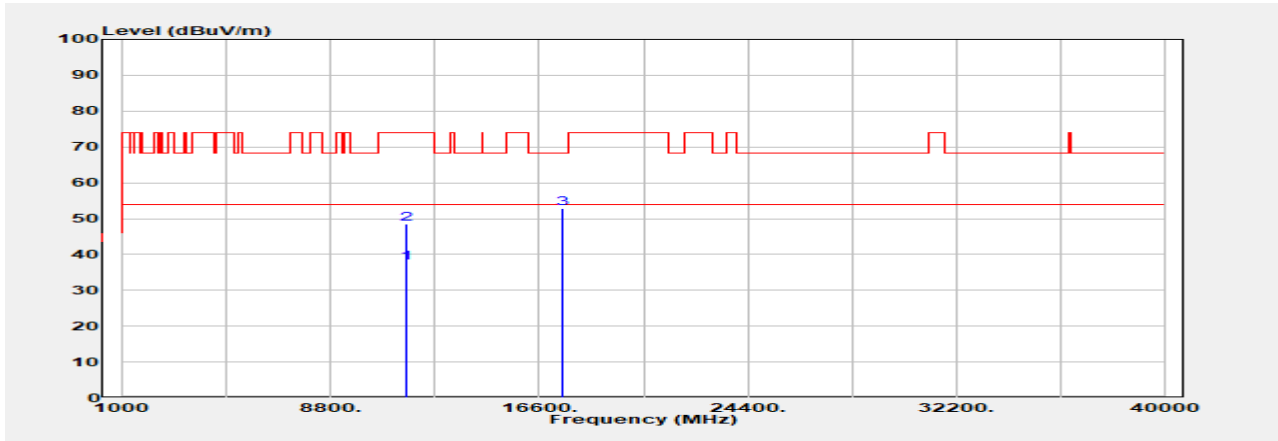

Freq. MHz	Detector Mode PK/QP/AVG	Spectrum Reading Level dB μ V	Factor dB	Actual FS dB μ V/m	Limit @3m dB μ V/m	Margin dB
11650.000	Average	27.74	10.05	37.79	54.00	-16.21
11650.000	Peak	38.46	10.05	48.51	74.00	-25.49
17475.000	Peak	41.68	11.10	52.78	68.20	-15.42

Unless otherwise stated the results shown in this test report refer only to the sample(s) tested and such sample(s) are retained for 90 days only.

除非另有說明，此報告結果僅對測試之樣品負責，同時此樣品僅保留90天。本報告未經本公司書面許可，不可部份複製。

This document is issued by the Company subject to its General Conditions of Service printed overleaf, available on request or accessible at <http://www.sgs.com.tw/Terms-and-Conditions> and for electronic format documents, subject to Terms and Conditions for Electronic Documents at <http://www.sgs.com.tw/Terms-and-Conditions>. Attention is drawn to the limitation of liability, indemnification and jurisdiction issues defined therein. Any holder of this document is advised that information contained hereon reflects the Company's findings at the time of its intervention only and within the limits of Client's instructions, if any. The Company's sole responsibility is to its Client and this document does not exonerate parties to a transaction from exercising all their rights and obligations under the transaction documents. This document cannot be reproduced except in full, without prior written approval of the Company. Any unauthorized alteration, forgery or falsification of the content or appearance of this document is unlawful and offenders may be prosecuted to the fullest extent of the law.

Report Number	:TERF2310002502E2	Test Site	:SAC G Chamber
Operation Mode	:802.11n20	Test Date	:2023-12-06
Test Frequency	:5825 MHz	Temp./Humi.	:22.6°C/68%
Test Mode	:Tx	Antenna Pol.	:Horizontal
EUT Pol	:E2 Plane	Engineer	:Temo Chen

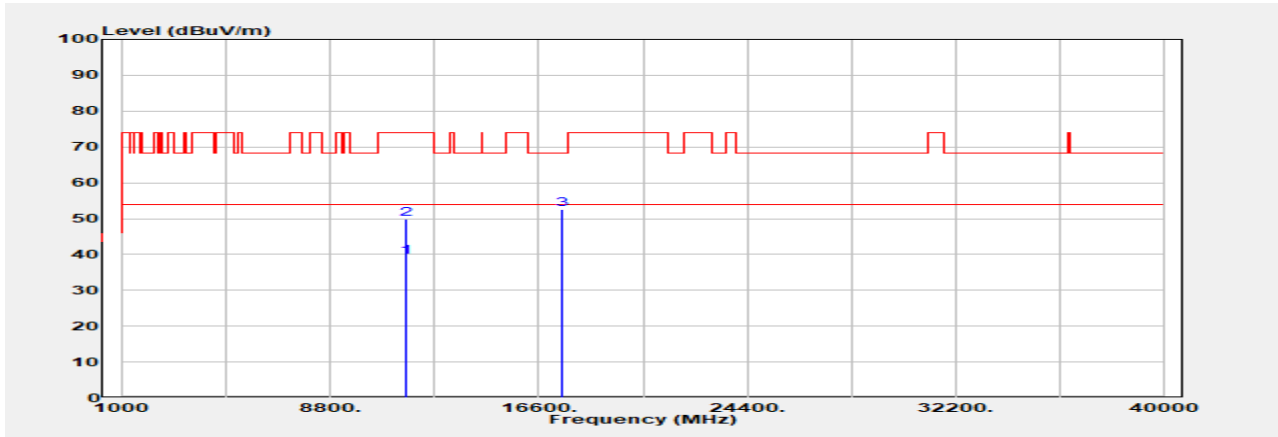

Freq. MHz	Detector Mode PK/QP/AVG	Spectrum Reading Level dB μ V	Factor dB	Actual FS dB μ V/m	Limit @3m dB μ V/m	Margin dB
11650.000	Average	29.14	10.05	39.19	54.00	-14.81
11650.000	Peak	39.89	10.05	49.94	74.00	-24.06
17475.000	Peak	41.39	11.10	52.49	68.20	-15.71

Unless otherwise stated the results shown in this test report refer only to the sample(s) tested and such sample(s) are retained for 90 days only.

除非另有說明，此報告結果僅對測試之樣品負責，同時此樣品僅保留90天。本報告未經本公司書面許可，不可部份複製。

This document is issued by the Company subject to its General Conditions of Service printed overleaf, available on request or accessible at <http://www.sgs.com.tw/Terms-and-Conditions> and for electronic format documents, subject to Terms and Conditions for Electronic Documents at <http://www.sgs.com.tw/Terms-and-Conditions>. Attention is drawn to the limitation of liability, indemnification and jurisdiction issues defined therein. Any holder of this document is advised that information contained hereon reflects the Company's findings at the time of its intervention only and within the limits of Client's instructions, if any. The Company's sole responsibility is to its Client and this document does not exonerate parties to a transaction from exercising all their rights and obligations under the transaction documents. This document cannot be reproduced except in full, without prior written approval of the Company. Any unauthorized alteration, forgery or falsification of the content or appearance of this document is unlawful and offenders may be prosecuted to the fullest extent of the law.

Report Number	:TERF2310002502E2	Test Site	:SAC G Chamber
Operation Mode	:802.11n40	Test Date	:2023-12-06
Test Frequency	:5710 MHz	Temp./Humi.	:22.6°C/68%
Test Mode	:Tx	Antenna Pol.	:Vertical
EUT Pol	:E2 Plane	Engineer	:Temo Chen

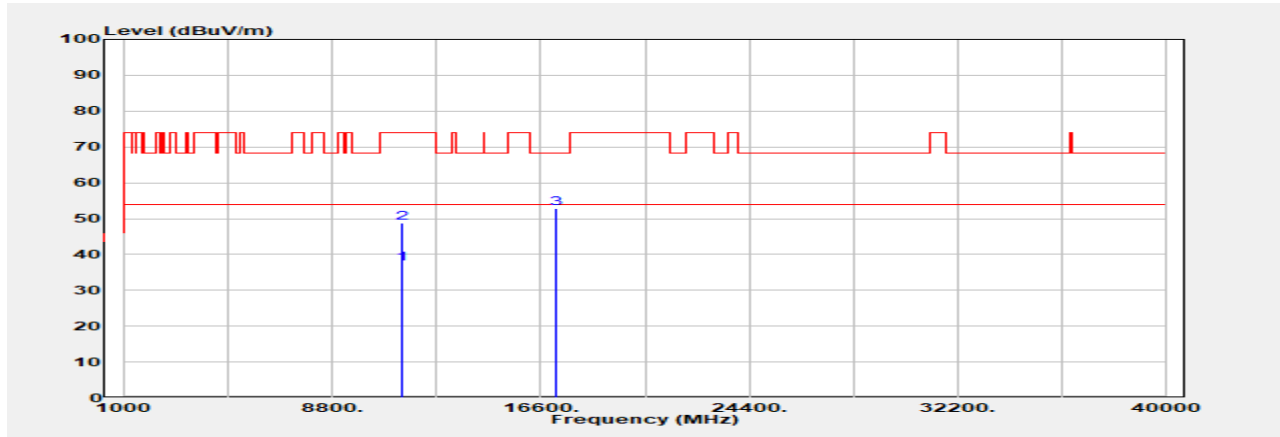

Freq. MHz	Detector Mode PK/QP/AVG	Spectrum Reading Level dB μ V	Factor dB	Actual FS dB μ V/m	Limit @3m dB μ V/m	Margin dB
11420.000	Average	27.27	10.08	37.35	54.00	-16.65
11420.000	Peak	38.70	10.08	48.78	74.00	-25.22
17130.000	Peak	41.29	11.66	52.94	68.20	-15.26

Unless otherwise stated the results shown in this test report refer only to the sample(s) tested and such sample(s) are retained for 90 days only.

除非另有說明，此報告結果僅對測試之樣品負責，同時此樣品僅保留90天。本報告未經本公司書面許可，不可部份複製。

This document is issued by the Company subject to its General Conditions of Service printed overleaf, available on request or accessible at <http://www.sgs.com.tw/Terms-and-Conditions> and for electronic format documents, subject to Terms and Conditions for Electronic Documents at <http://www.sgs.com.tw/Terms-and-Conditions>. Attention is drawn to the limitation of liability, indemnification and jurisdiction issues defined therein. Any holder of this document is advised that information contained hereon reflects the Company's findings at the time of its intervention only and within the limits of Client's instructions, if any. The Company's sole responsibility is to its Client and this document does not exonerate parties to a transaction from exercising all their rights and obligations under the transaction documents. This document cannot be reproduced except in full, without prior written approval of the Company. Any unauthorized alteration, forgery or falsification of the content or appearance of this document is unlawful and offenders may be prosecuted to the fullest extent of the law.

Report Number	:TERF2310002502E2	Test Site	:SAC G Chamber
Operation Mode	:802.11n40	Test Date	:2023-12-06
Test Frequency	:5710 MHz	Temp./Humi.	:22.6°C/68%
Test Mode	:Tx	Antenna Pol.	:Horizontal
EUT Pol	:E2 Plane	Engineer	:Temo Chen

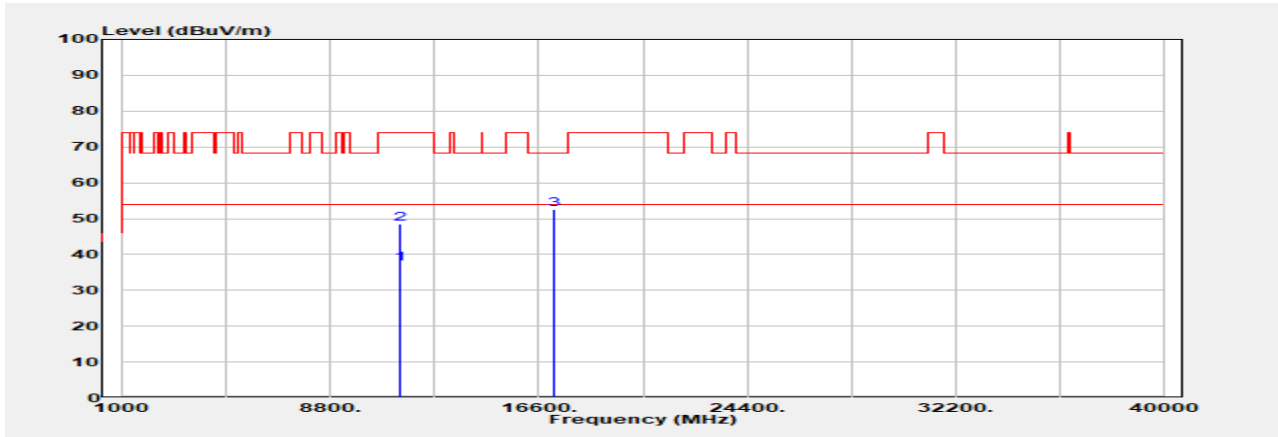

Freq. MHz	Detector Mode PK/QP/AVG	Spectrum Reading Level dB μ V	Factor dB	Actual FS dB μ V/m	Limit @3m dB μ V/m	Margin dB
11420.000	Average	27.42	10.08	37.50	54.00	-16.50
11420.000	Peak	38.55	10.08	48.63	74.00	-25.37
17130.000	Peak	40.94	11.66	52.60	68.20	-15.60

Unless otherwise stated the results shown in this test report refer only to the sample(s) tested and such sample(s) are retained for 90 days only.

除非另有說明，此報告結果僅對測試之樣品負責，同時此樣品僅保留90天。本報告未經本公司書面許可，不可部份複製。

This document is issued by the Company subject to its General Conditions of Service printed overleaf, available on request or accessible at <http://www.sgs.com.tw/Terms-and-Conditions> and for electronic format documents, subject to Terms and Conditions for Electronic Documents at <http://www.sgs.com.tw/Terms-and-Conditions>. Attention is drawn to the limitation of liability, indemnification and jurisdiction issues defined therein. Any holder of this document is advised that information contained hereon reflects the Company's findings at the time of its intervention only and within the limits of Client's instructions, if any. The Company's sole responsibility is to its Client and this document does not exonerate parties to a transaction from exercising all their rights and obligations under the transaction documents. This document cannot be reproduced except in full, without prior written approval of the Company. Any unauthorized alteration, forgery or falsification of the content or appearance of this document is unlawful and offenders may be prosecuted to the fullest extent of the law.

Report Number :TERF2310002502E2
 Operation Mode :802.11be20
 Test Frequency :5220 MHz
 Test Mode :Tx
 EUT Pol :E2 Plane

Test Site :SAC G Chamber
 Test Date :2023-12-06
 Temp./Humi. :22.6°C/68%
 Antenna Pol. :Vertical
 Engineer :Temo Chen

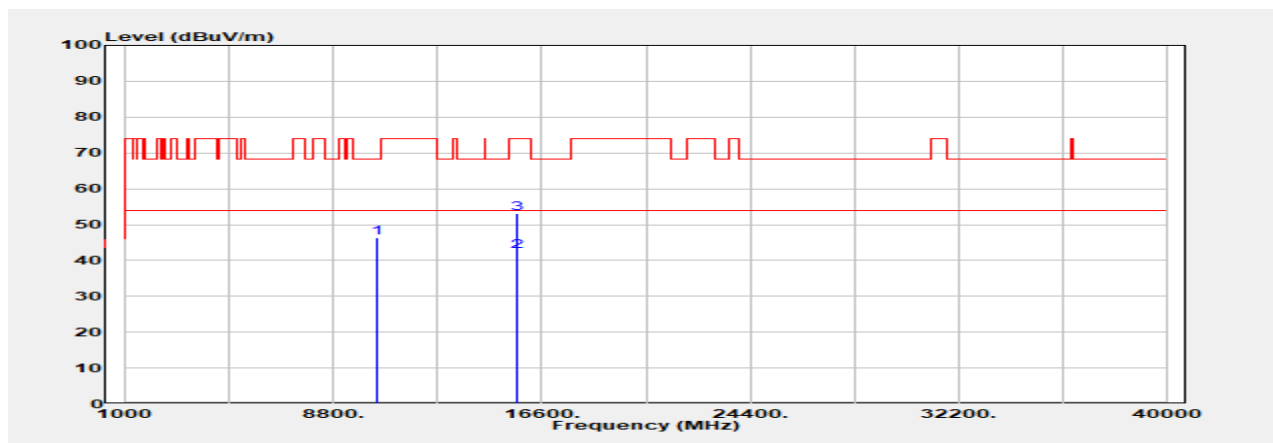

Freq. MHz	Detector Mode PK/QP/AVG	Spectrum Reading Level dB μ V	Factor dB	Actual FS dB μ V/m	Limit @3m dB μ V/m	Margin dB
10440.000	Peak	36.73	9.66	46.39	68.20	-21.81
15660.000	Average	30.27	12.32	42.59	54.00	-11.41
15660.000	Peak	40.85	12.32	53.17	74.00	-20.83

Unless otherwise stated the results shown in this test report refer only to the sample(s) tested and such sample(s) are retained for 90 days only.

除非另有說明，此報告結果僅對測試之樣品負責，同時此樣品僅保留90天。本報告未經本公司書面許可，不可部份複製。

This document is issued by the Company subject to its General Conditions of Service printed overleaf, available on request or accessible at <http://www.sgs.com.tw/Terms-and-Conditions> and for electronic format documents, subject to Terms and Conditions for Electronic Documents at <http://www.sgs.com.tw/Terms-and-Conditions>. Attention is drawn to the limitation of liability, indemnification and jurisdiction issues defined therein. Any holder of this document is advised that information contained hereon reflects the Company's findings at the time of its intervention only and within the limits of Client's instructions, if any. The Company's sole responsibility is to its Client and this document does not exonerate parties to a transaction from exercising all their rights and obligations under the transaction documents. This document cannot be reproduced except in full, without prior written approval of the Company. Any unauthorized alteration, forgery or falsification of the content or appearance of this document is unlawful and offenders may be prosecuted to the fullest extent of the law.

Report Number	:TERF2310002502E2	Test Site	:SAC G Chamber
Operation Mode	:802.11be20	Test Date	:2023-12-06
Test Frequency	:5220 MHz	Temp./Humi.	:22.6°C/68%
Test Mode	:Tx	Antenna Pol.	:Horizontal
EUT Pol	:E2 Plane	Engineer	:Temo Chen

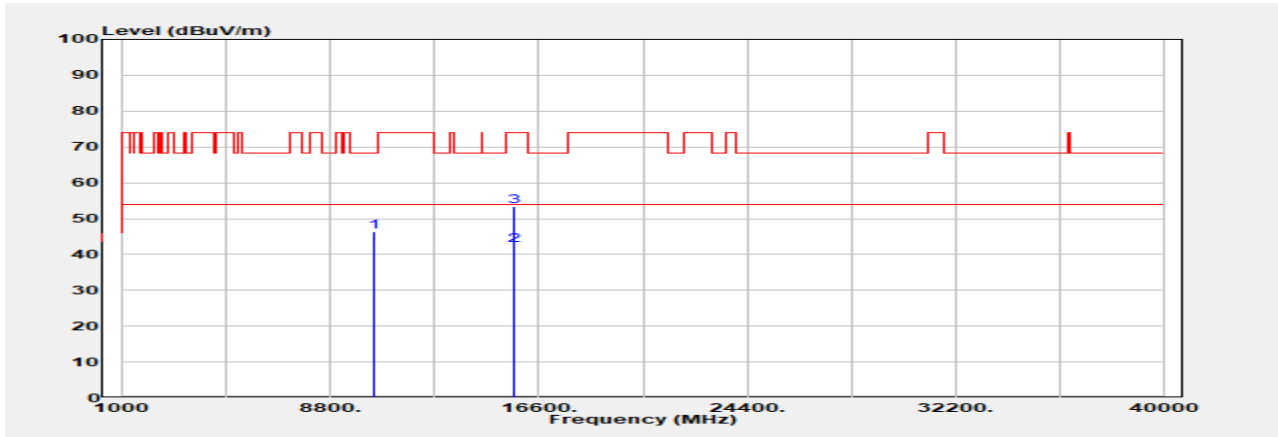

Freq. MHz	Detector Mode PK/QP/AVG	Spectrum Reading Level dB μ V	Factor dB	Actual FS dB μ V/m	Limit @3m dB μ V/m	Margin dB
10440.000	Peak	36.55	9.66	46.21	68.20	-21.99
15660.000	Average	30.13	12.32	42.45	54.00	-11.55
15660.000	Peak	41.02	12.32	53.34	74.00	-20.66

Unless otherwise stated the results shown in this test report refer only to the sample(s) tested and such sample(s) are retained for 90 days only.

除非另有說明，此報告結果僅對測試之樣品負責，同時此樣品僅保留90天。本報告未經本公司書面許可，不可部份複製。

This document is issued by the Company subject to its General Conditions of Service printed overleaf, available on request or accessible at <http://www.sgs.com.tw/Terms-and-Conditions> and for electronic format documents, subject to Terms and Conditions for Electronic Documents at <http://www.sgs.com.tw/Terms-and-Conditions>. Attention is drawn to the limitation of liability, indemnification and jurisdiction issues defined therein. Any holder of this document is advised that information contained hereon reflects the Company's findings at the time of its intervention only and within the limits of Client's instructions, if any. The Company's sole responsibility is to its Client and this document does not exonerate parties to a transaction from exercising all their rights and obligations under the transaction documents. This document cannot be reproduced except in full, without prior written approval of the Company. Any unauthorized alteration, forgery or falsification of the content or appearance of this document is unlawful and offenders may be prosecuted to the fullest extent of the law.

Report Number	:TERF2310002502E2	Test Site	:SAC G Chamber
Operation Mode	:802.11be20	Test Date	:2023-12-06
Test Frequency	:5260 MHz	Temp./Humi.	:22.6°C/68%
Test Mode	:Tx	Antenna Pol.	:Vertical
EUT Pol	:E2 Plane	Engineer	:Temo Chen

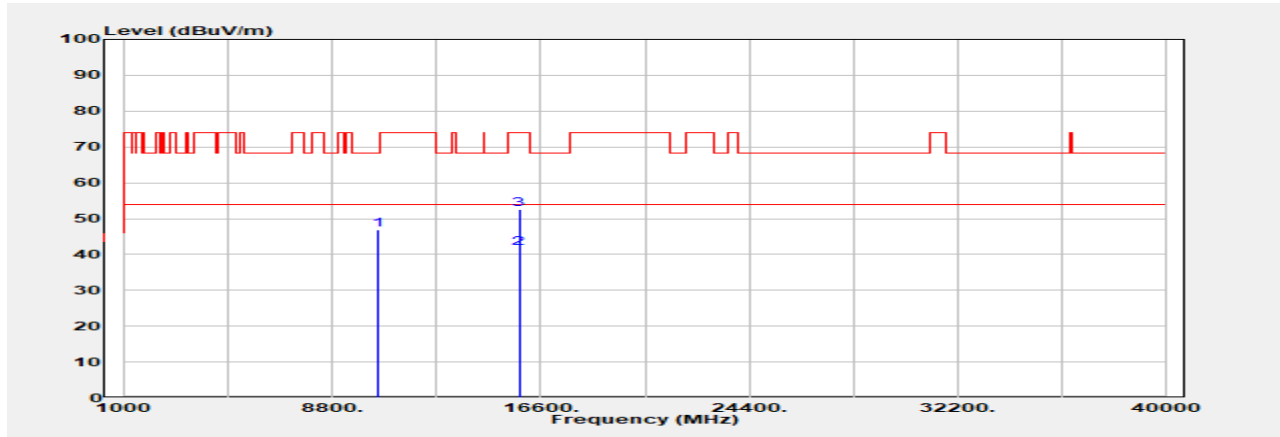

Freq. MHz	Detector Mode PK/QP/AVG	Spectrum Reading Level dB μ V	Factor dB	Actual FS dB μ V/m	Limit @3m dB μ V/m	Margin dB
10520.000	Peak	36.87	9.92	46.79	68.20	-21.41
15780.000	Average	29.33	12.44	41.77	54.00	-12.23
15780.000	Peak	40.18	12.44	52.62	74.00	-21.38

Unless otherwise stated the results shown in this test report refer only to the sample(s) tested and such sample(s) are retained for 90 days only.

除非另有說明，此報告結果僅對測試之樣品負責，同時此樣品僅保留90天。本報告未經本公司書面許可，不可部份複製。

This document is issued by the Company subject to its General Conditions of Service printed overleaf, available on request or accessible at <http://www.sgs.com.tw/Terms-and-Conditions> and for electronic format documents, subject to Terms and Conditions for Electronic Documents at <http://www.sgs.com.tw/Terms-and-Conditions>. Attention is drawn to the limitation of liability, indemnification and jurisdiction issues defined therein. Any holder of this document is advised that information contained hereon reflects the Company's findings at the time of its intervention only and within the limits of Client's instructions, if any. The Company's sole responsibility is to its Client and this document does not exonerate parties to a transaction from exercising all their rights and obligations under the transaction documents. This document cannot be reproduced except in full, without prior written approval of the Company. Any unauthorized alteration, forgery or falsification of the content or appearance of this document is unlawful and offenders may be prosecuted to the fullest extent of the law.

Report Number	:TERF2310002502E2	Test Site	:SAC G Chamber
Operation Mode	:802.11be20	Test Date	:2023-12-06
Test Frequency	:5260 MHz	Temp./Humi.	:22.6°C/68%
Test Mode	:Tx	Antenna Pol.	:Horizontal
EUT Pol	:E2 Plane	Engineer	:Temo Chen

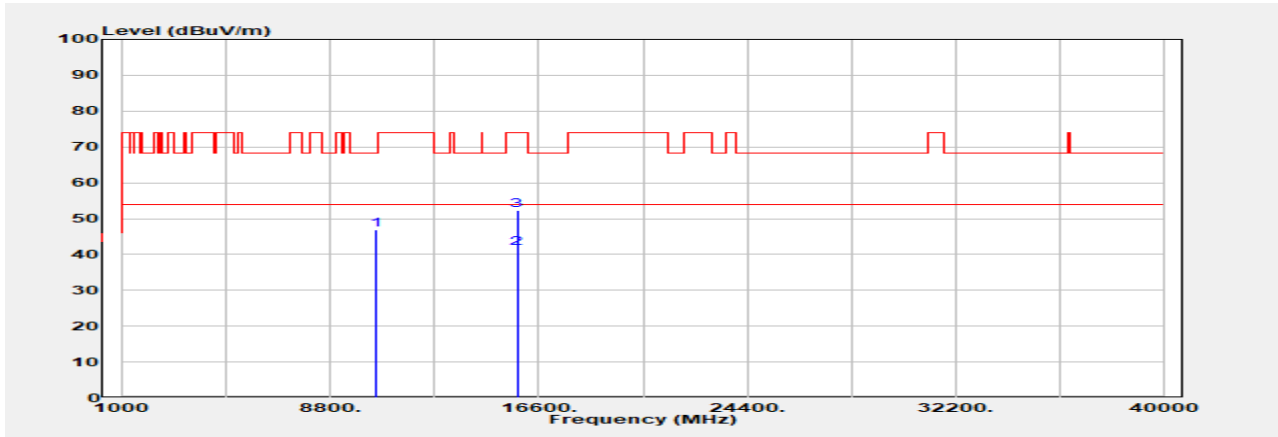

Freq. MHz	Detector Mode PK/QP/AVG	Spectrum Reading Level dB μ V	Factor dB	Actual FS dB μ V/m	Limit @3m dB μ V/m	Margin dB
10520.000	Peak	36.89	9.92	46.81	68.20	-21.39
15780.000	Average	29.22	12.44	41.66	54.00	-12.34
15780.000	Peak	39.85	12.44	52.29	74.00	-21.71

Unless otherwise stated the results shown in this test report refer only to the sample(s) tested and such sample(s) are retained for 90 days only.

除非另有說明，此報告結果僅對測試之樣品負責，同時此樣品僅保留90天。本報告未經本公司書面許可，不可部份複製。

This document is issued by the Company subject to its General Conditions of Service printed overleaf, available on request or accessible at <http://www.sgs.com.tw/Terms-and-Conditions> and for electronic format documents, subject to Terms and Conditions for Electronic Documents at <http://www.sgs.com.tw/Terms-and-Conditions>. Attention is drawn to the limitation of liability, indemnification and jurisdiction issues defined therein. Any holder of this document is advised that information contained hereon reflects the Company's findings at the time of its intervention only and within the limits of Client's instructions, if any. The Company's sole responsibility is to its Client and this document does not exonerate parties to a transaction from exercising all their rights and obligations under the transaction documents. This document cannot be reproduced except in full, without prior written approval of the Company. Any unauthorized alteration, forgery or falsification of the content or appearance of this document is unlawful and offenders may be prosecuted to the fullest extent of the law.

11.6.2 Band edge falling to restricted band

Mode: CDD

Report Number	:TERF2308001923E2	Test Site	:SAC G Chamber
Operation Mode	:802.11a	Test Date	:2023-10-18
Test Frequency	:5180 MHz	Temp./Humi.	:19.7°C/63%
Test Mode	:Bandedge	Antenna Pol.	:Vertical
EUT Pol	:E2 Plane	Engineer	:Temo Chen

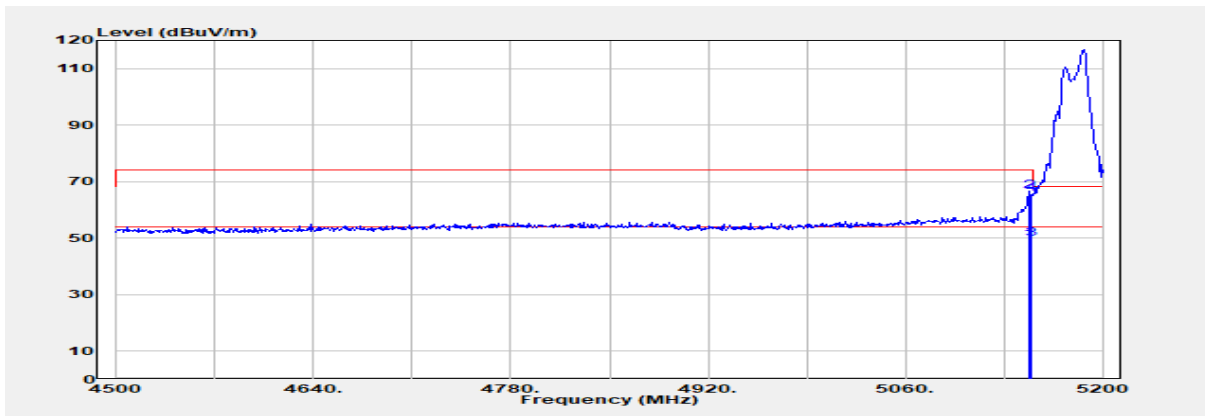

Freq. MHz	Detector Mode PK/QP/AV	Spectrum Reading Level dBμV	Factor dB	Actual FS dBμV/m	Limit @3m dBμV/m	Margin dB
5147.500	Average	45.51	3.77	49.27	54.00	-4.73
5147.500	Peak	63.06	3.77	66.82	74.00	-7.18
5150.000	Average	45.90	3.74	49.64	54.00	-4.36
5150.000	Peak	61.94	3.74	65.68	74.00	-8.32

Unless otherwise stated the results shown in this test report refer only to the sample(s) tested and such sample(s) are retained for 90 days only.

除非另有說明，此報告結果僅對測試之樣品負責，同時此樣品僅保留90天。本報告未經本公司書面許可，不可部份複製。
 This document is issued by the Company subject to its General Conditions of Service printed overleaf, available on request or accessible at <http://www.sgs.com.tw/Terms-and-Conditions> and for electronic format documents, subject to Terms and Conditions for Electronic Documents at <http://www.sgs.com.tw/Terms-and-Conditions>. Attention is drawn to the limitation of liability, indemnification and jurisdiction issues defined therein. Any holder of this document is advised that information contained hereon reflects the Company's findings at the time of its intervention only and within the limits of Client's instructions, if any. The Company's sole responsibility is to its Client and this document does not exonerate parties to a transaction from exercising all their rights and obligations under the transaction documents. This document cannot be reproduced except in full, without prior written approval of the Company. Any unauthorized alteration, forgery or falsification of the content or appearance of this document is unlawful and offenders may be prosecuted to the fullest extent of the law.

Report Number :TERF2308001923E2
 Operation Mode :802.11a
 Test Frequency :5180 MHz
 Test Mode :Bandedge
 EUT Pol :E2 Plane

Test Site :SAC G Chamber
 Test Date :2023-10-18
 Temp./Humi. :19.7°C/63%
 Antenna Pol. :Horizontal
 Engineer :Temo Chen

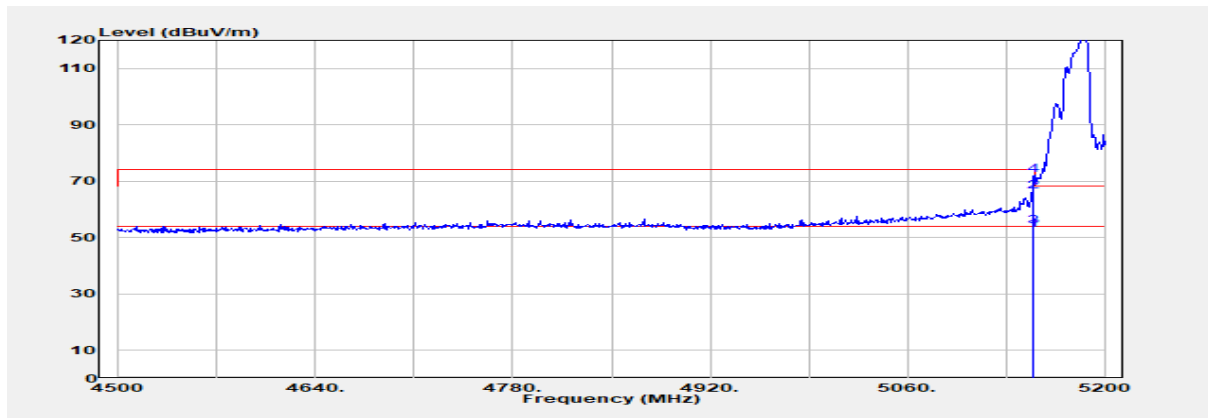

Freq. MHz	Detector Mode PK/QP/AV	Spectrum Reading Level dB μ V	Factor dB	Actual FS dB μ V/m	Limit @3m dB μ V/m	Margin dB
5148.900	Average	48.97	3.75	52.72	54.00	-1.28
5148.900	Peak	62.57	3.75	66.32	74.00	-7.68
5150.000	Average	50.11	3.74	53.85	54.00	-0.15
5150.000	Peak	68.33	3.74	72.08	74.00	-1.92

Unless otherwise stated the results shown in this test report refer only to the sample(s) tested and such sample(s) are retained for 90 days only.

除非另有說明，此報告結果僅對測試之樣品負責，同時此樣品僅保留90天。本報告未經本公司書面許可，不可部份複製。

This document is issued by the Company subject to its General Conditions of Service printed overleaf, available on request or accessible at <http://www.sgs.com.tw/Terms-and-Conditions> and for electronic format documents, subject to Terms and Conditions for Electronic Documents at <http://www.sgs.com.tw/Terms-and-Conditions>. Attention is drawn to the limitation of liability, indemnification and jurisdiction issues defined therein. Any holder of this document is advised that information contained hereon reflects the Company's findings at the time of its intervention only and within the limits of Client's instructions, if any. The Company's sole responsibility is to its Client and this document does not exonerate parties to a transaction from exercising all their rights and obligations under the transaction documents. This document cannot be reproduced except in full, without prior written approval of the Company. Any unauthorized alteration, forgery or falsification of the content or appearance of this document is unlawful and offenders may be prosecuted to the fullest extent of the law.

Report Number :TERF2308001923E2
 Operation Mode :802.11a
 Test Frequency :5320 MHz
 Test Mode :Bandedge
 EUT Pol :E2 Plane

Test Site :SAC G Chamber
 Test Date :2023-10-18
 Temp./Humi. :19.7°C/63%
 Antenna Pol. :Vertical
 Engineer :Temo Chen

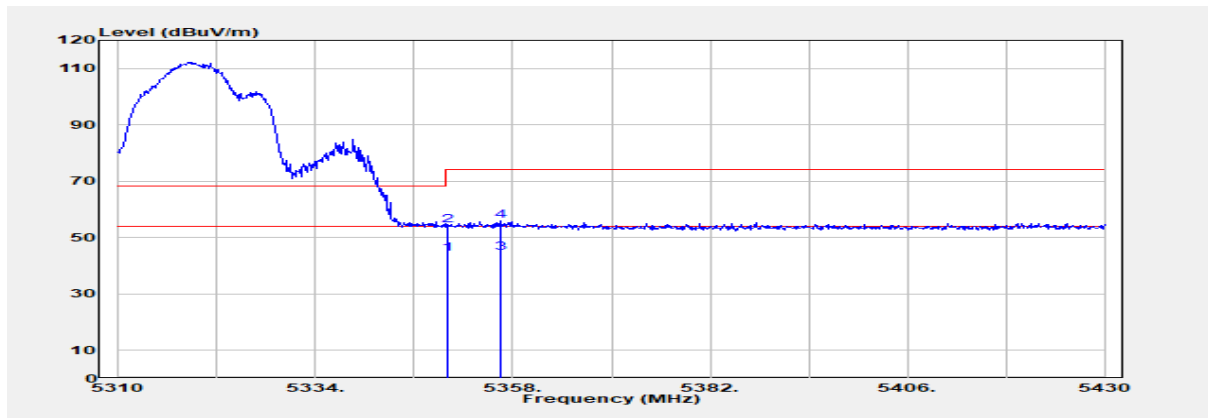

Freq. MHz	Detector Mode PK/QP/AV	Spectrum Reading Level dB μ V	Factor dB	Actual FS dB μ V/m	Limit @3m dB μ V/m	Margin dB
5350.000	Average	41.02	3.37	44.39	54.00	-9.61
5350.000	Peak	50.94	3.37	54.31	74.00	-19.69
5356.440	Average	41.07	3.37	44.44	54.00	-9.56
5356.440	Peak	52.47	3.37	55.84	74.00	-18.16

Unless otherwise stated the results shown in this test report refer only to the sample(s) tested and such sample(s) are retained for 90 days only.

除非另有說明，此報告結果僅對測試之樣品負責，同時此樣品僅保留90天。本報告未經本公司書面許可，不可部份複製。

This document is issued by the Company subject to its General Conditions of Service printed overleaf, available on request or accessible at <http://www.sgs.com.tw/Terms-and-Conditions> and for electronic format documents, subject to Terms and Conditions for Electronic Documents at <http://www.sgs.com.tw/Terms-and-Conditions>. Attention is drawn to the limitation of liability, indemnification and jurisdiction issues defined therein. Any holder of this document is advised that information contained hereon reflects the Company's findings at the time of its intervention only and within the limits of Client's instructions, if any. The Company's sole responsibility is to its Client and this document does not exonerate parties to a transaction from exercising all their rights and obligations under the transaction documents. This document cannot be reproduced except in full, without prior written approval of the Company. Any unauthorized alteration, forgery or falsification of the content or appearance of this document is unlawful and offenders may be prosecuted to the fullest extent of the law.

Report Number :TERF2308001923E2
 Operation Mode :802.11a
 Test Frequency :5320 MHz
 Test Mode :Bandedge
 EUT Pol :E2 Plane

Test Site :SAC G Chamber
 Test Date :2023-10-18
 Temp./Humi. :19.7°C/63%
 Antenna Pol. :Horizontal
 Engineer :Temo Chen

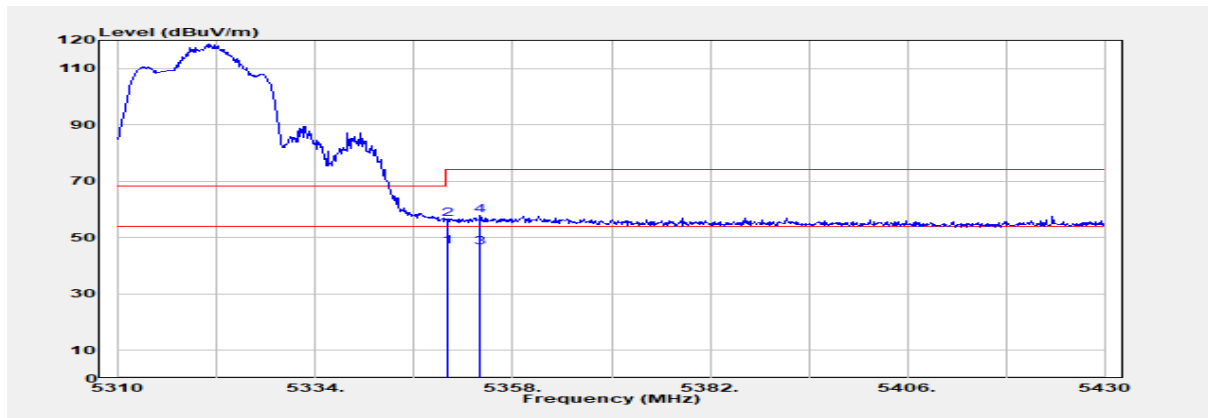

Freq. MHz	Detector Mode PK/QP/AV	Spectrum Reading Level dB μ V	Factor dB	Actual FS dB μ V/m	Limit @3m dB μ V/m	Margin dB
5350.000	Average	43.48	3.37	46.85	54.00	-7.15
5350.000	Peak	53.18	3.37	56.55	74.00	-17.45
5354.040	Average	43.21	3.37	46.58	54.00	-7.42
5354.040	Peak	54.48	3.37	57.85	74.00	-16.15

Unless otherwise stated the results shown in this test report refer only to the sample(s) tested and such sample(s) are retained for 90 days only.

除非另有說明，此報告結果僅對測試之樣品負責，同時此樣品僅保留90天。本報告未經本公司書面許可，不可部份複製。

This document is issued by the Company subject to its General Conditions of Service printed overleaf, available on request or accessible at <http://www.sgs.com.tw/Terms-and-Conditions> and for electronic format documents, subject to Terms and Conditions for Electronic Documents at <http://www.sgs.com.tw/Terms-and-Conditions>. Attention is drawn to the limitation of liability, indemnification and jurisdiction issues defined therein. Any holder of this document is advised that information contained hereon reflects the Company's findings at the time of its intervention only and within the limits of Client's instructions, if any. The Company's sole responsibility is to its Client and this document does not exonerate parties to a transaction from exercising all their rights and obligations under the transaction documents. This document cannot be reproduced except in full, without prior written approval of the Company. Any unauthorized alteration, forgery or falsification of the content or appearance of this document is unlawful and offenders may be prosecuted to the fullest extent of the law.

Report Number :TERF2308001923E2
 Operation Mode :802.11a
 Test Frequency :5500 MHz
 Test Mode :Bandedge
 EUT Pol :E2 Plane

Test Site :SAC G Chamber
 Test Date :2023-10-18
 Temp./Humi. :19.7°C/63%
 Antenna Pol. :Vertical
 Engineer :Temo Chen

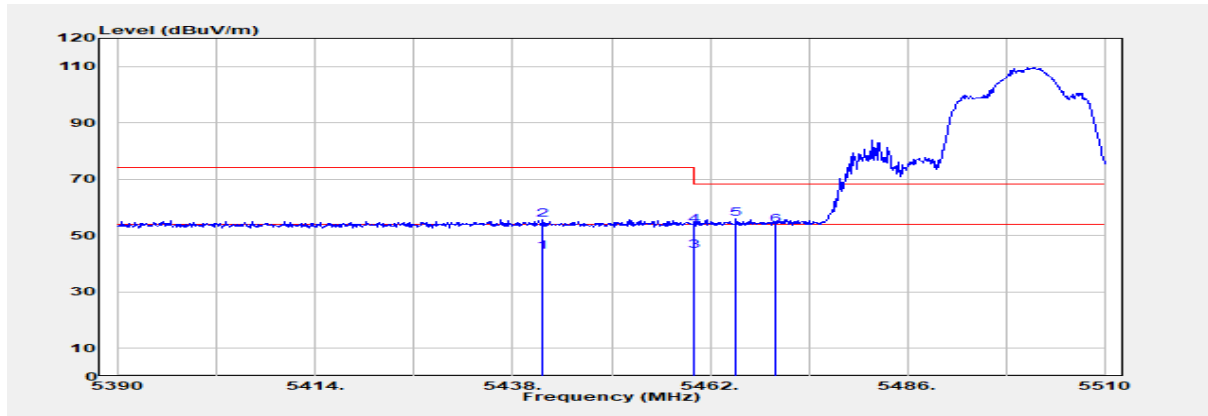

Freq. MHz	Detector Mode PK/QP/AV	Spectrum Reading Level dBμV	Factor dB	Actual FS dBμV/m	Limit @3m dBμV/m	Margin dB
5441.600	Average	40.78	3.56	44.34	54.00	-9.66
5441.600	Peak	52.18	3.56	55.74	74.00	-18.26
5460.000	Average	40.94	3.68	44.62	54.00	-9.38
5460.000	Peak	50.05	3.68	53.73	74.00	-20.27
5465.120	Peak	52.15	3.72	55.87	68.20	-12.33
5470.000	Peak	49.89	3.76	53.65	68.20	-14.55

Unless otherwise stated the results shown in this test report refer only to the sample(s) tested and such sample(s) are retained for 90 days only.

除非另有說明，此報告結果僅對測試之樣品負責，同時此樣品僅保留90天。本報告未經本公司書面許可，不可部份複製。

This document is issued by the Company subject to its General Conditions of Service printed overleaf, available on request or accessible at <http://www.sgs.com.tw/Terms-and-Conditions> and for electronic format documents, subject to Terms and Conditions for Electronic Documents at <http://www.sgs.com.tw/Terms-and-Conditions>. Attention is drawn to the limitation of liability, indemnification and jurisdiction issues defined therein. Any holder of this document is advised that information contained hereon reflects the Company's findings at the time of its intervention only and within the limits of Client's instructions, if any. The Company's sole responsibility is to its Client and this document does not exonerate parties to a transaction from exercising all their rights and obligations under the transaction documents. This document cannot be reproduced except in full, without prior written approval of the Company. Any unauthorized alteration, forgery or falsification of the content or appearance of this document is unlawful and offenders may be prosecuted to the fullest extent of the law.

Report Number :TERF2308001923E2
 Operation Mode :802.11a
 Test Frequency :5500 MHz
 Test Mode :Bandedge
 EUT Pol :E2 Plane

Test Site :SAC G Chamber
 Test Date :2023-10-18
 Temp./Humi. :19.7°C/63%
 Antenna Pol. :Horizontal
 Engineer :Temo Chen

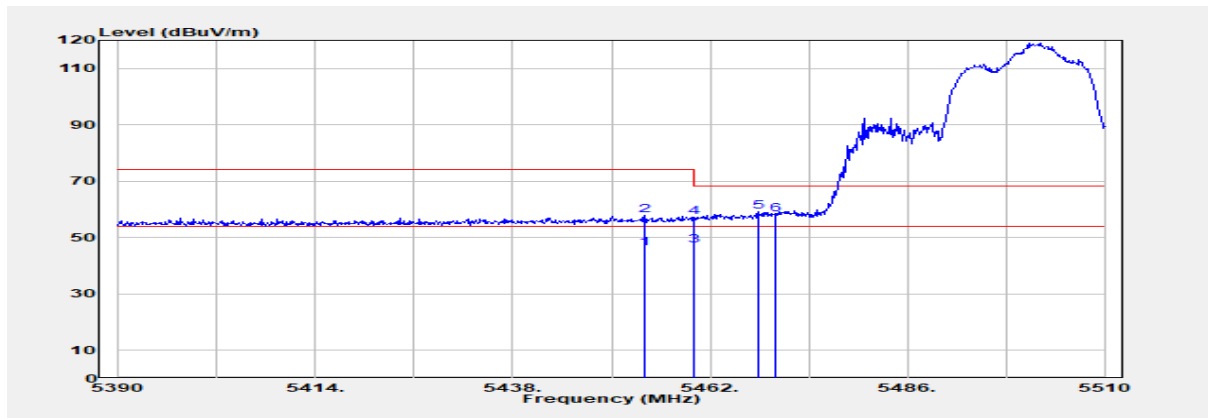

Freq. MHz	Detector Mode PK/QP/AV	Spectrum Reading Level dBμV	Factor dB	Actual FS dBμV/m	Limit @3m dBμV/m	Margin dB
5453.960	Average	42.67	3.63	46.30	54.00	-7.70
5453.960	Peak	54.11	3.63	57.74	74.00	-16.26
5460.000	Average	43.35	3.68	47.03	54.00	-6.97
5460.000	Peak	53.60	3.68	57.28	74.00	-16.72
5467.880	Peak	55.56	3.74	59.30	68.20	-8.90
5470.000	Peak	54.40	3.76	58.16	68.20	-10.04

Unless otherwise stated the results shown in this test report refer only to the sample(s) tested and such sample(s) are retained for 90 days only.

除非另有說明，此報告結果僅對測試之樣品負責，同時此樣品僅保留90天。本報告未經本公司書面許可，不可部份複製。

This document is issued by the Company subject to its General Conditions of Service printed overleaf, available on request or accessible at <http://www.sgs.com.tw/Terms-and-Conditions> and for electronic format documents, subject to Terms and Conditions for Electronic Documents at <http://www.sgs.com.tw/Terms-and-Conditions>. Attention is drawn to the limitation of liability, indemnification and jurisdiction issues defined therein. Any holder of this document is advised that information contained hereon reflects the Company's findings at the time of its intervention only and within the limits of Client's instructions, if any. The Company's sole responsibility is to its Client and this document does not exonerate parties to a transaction from exercising all their rights and obligations under the transaction documents. This document cannot be reproduced except in full, without prior written approval of the Company. Any unauthorized alteration, forgery or falsification of the content or appearance of this document is unlawful and offenders may be prosecuted to the fullest extent of the law.

Report Number :TERF2308001923E2
 Operation Mode :802.11a
 Test Frequency :5700 MHz
 Test Mode :Bandedge
 EUT Pol :E2 Plane

Test Site :SAC G Chamber
 Test Date :2023-10-18
 Temp./Humi. :19.7°C/63%
 Antenna Pol. :Vertical
 Engineer :Temo Chen

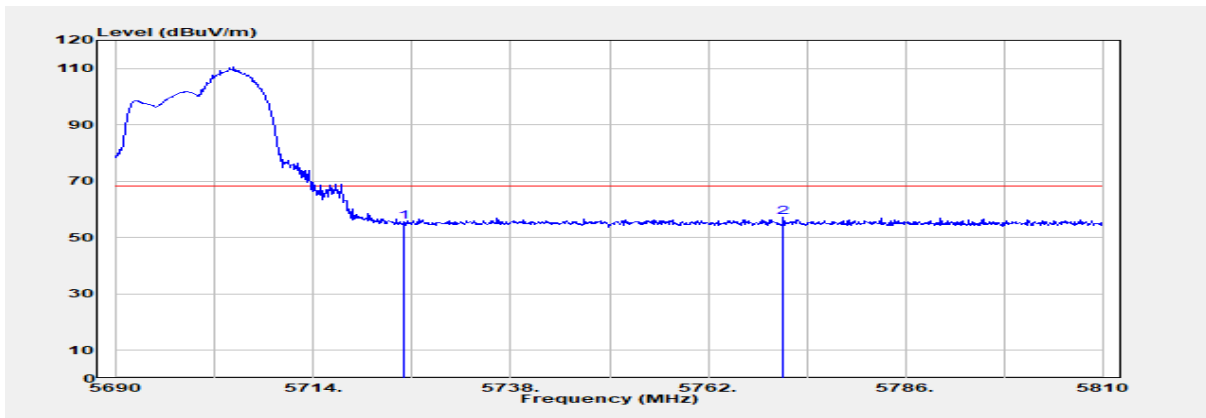

Freq. MHz	Detector Mode PK/QP/AV	Spectrum Reading Level dB μ V	Factor dB	Actual FS dB μ V/m	Limit @3m dB μ V/m	Margin dB
5725.000	Peak	49.93	5.57	55.51	68.20	-12.69
5771.120	Peak	51.65	5.60	57.25	68.20	-10.95

Unless otherwise stated the results shown in this test report refer only to the sample(s) tested and such sample(s) are retained for 90 days only.

除非另有說明，此報告結果僅對測試之樣品負責，同時此樣品僅保留90天。本報告未經本公司書面許可，不可部份複製。

This document is issued by the Company subject to its General Conditions of Service printed overleaf, available on request or accessible at <http://www.sgs.com.tw/Terms-and-Conditions>, and for electronic format documents, subject to Terms and Conditions for Electronic Documents at <http://www.sgs.com.tw/Terms-and-Conditions>. Attention is drawn to the limitation of liability, indemnification and jurisdiction issues defined therein. Any holder of this document is advised that information contained hereon reflects the Company's findings at the time of its intervention only and within the limits of Client's instructions, if any. The Company's sole responsibility is to its Client and this document does not exonerate parties to a transaction from exercising all their rights and obligations under the transaction documents. This document cannot be reproduced except in full, without prior written approval of the Company. Any unauthorized alteration, forgery or falsification of the content or appearance of this document is unlawful and offenders may be prosecuted to the fullest extent of the law.

Report Number :TERF2308001923E2
 Operation Mode :802.11a
 Test Frequency :5700 MHz
 Test Mode :Bandedge
 EUT Pol :E2 Plane

Test Site :SAC G Chamber
 Test Date :2023-10-18
 Temp./Humi. :19.7°C/63%
 Antenna Pol. :Horizontal
 Engineer :Temo Chen

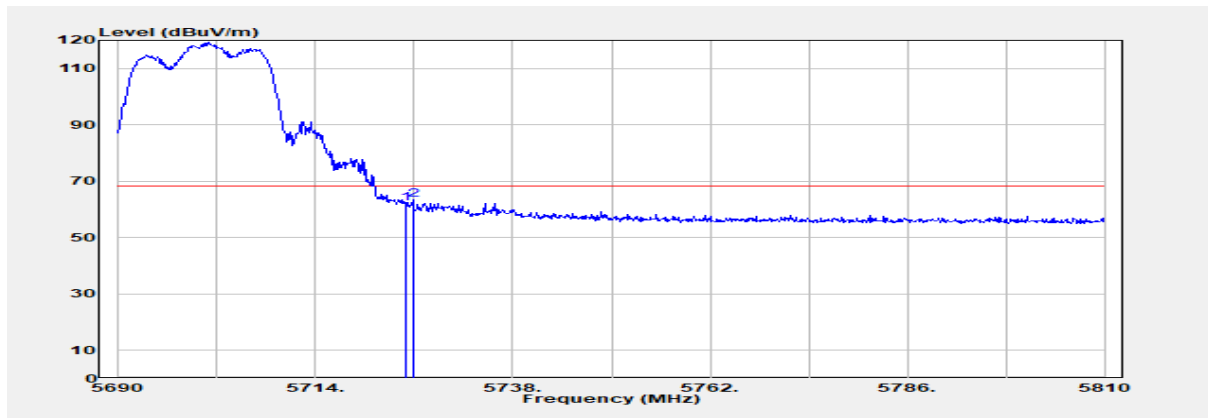

Freq. MHz	Detector Mode PK/QP/AV	Spectrum Reading Level dBμV	Factor dB	Actual FS dBμV/m	Limit @3m dBμV/m	Margin dB
5725.000	Peak	56.63	5.57	62.20	68.20	-6.00
5725.880	Peak	57.89	5.58	63.46	68.20	-4.74

Unless otherwise stated the results shown in this test report refer only to the sample(s) tested and such sample(s) are retained for 90 days only.

除非另有說明，此報告結果僅對測試之樣品負責，同時此樣品僅保留90天。本報告未經本公司書面許可，不可部份複製。

This document is issued by the Company subject to its General Conditions of Service printed overleaf, available on request or accessible at <http://www.sgs.com.tw/Terms-and-Conditions> and for electronic format documents, subject to Terms and Conditions for Electronic Documents at <http://www.sgs.com.tw/Terms-and-Conditions>. Attention is drawn to the limitation of liability, indemnification and jurisdiction issues defined therein. Any holder of this document is advised that information contained hereon reflects the Company's findings at the time of its intervention only and within the limits of Client's instructions, if any. The Company's sole responsibility is to its Client and this document does not exonerate parties to a transaction from exercising all their rights and obligations under the transaction documents. This document cannot be reproduced except in full, without prior written approval of the Company. Any unauthorized alteration, forgery or falsification of the content or appearance of this document is unlawful and offenders may be prosecuted to the fullest extent of the law.

Report Number :TERF2308001923E2
 Operation Mode :802.11a
 Test Frequency :5745 MHz
 Test Mode :Bandedge
 EUT Pol :E2 Plane

Test Site :SAC G Chamber
 Test Date :2023-10-18
 Temp./Humi. :19.7°C/63%
 Antenna Pol. :Vertical
 Engineer :Temo Chen

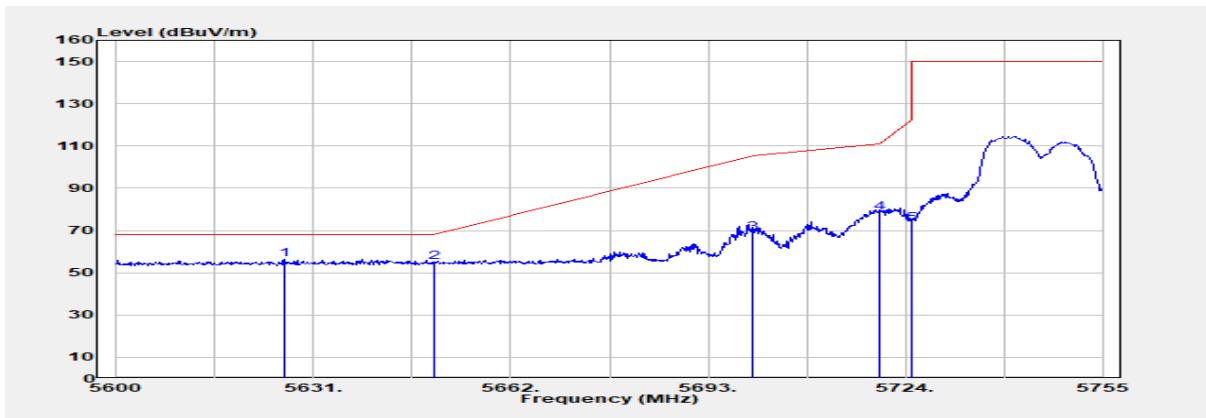

Freq. MHz	Detector Mode PK/QP/AV	Spectrum Reading Level dB μ V	Factor dB	Actual FS dB μ V/m	Limit @3m dB μ V/m	Margin dB
5626.505	Peak	52.09	4.38	56.47	68.20	-11.73
5650.000	Peak	50.11	4.76	54.87	68.20	-13.33
5700.000	Peak	63.39	5.56	68.95	105.20	-36.25
5720.000	Peak	72.96	5.57	78.53	110.80	-32.27
5725.000	Peak	67.74	5.57	73.31	122.20	-48.89

Unless otherwise stated the results shown in this test report refer only to the sample(s) tested and such sample(s) are retained for 90 days only.

除非另有說明，此報告結果僅對測試之樣品負責，同時此樣品僅保留90天。本報告未經本公司書面許可，不可部份複製。

This document is issued by the Company subject to its General Conditions of Service printed overleaf, available on request or accessible at <http://www.sgs.com.tw/Terms-and-Conditions>, and for electronic format documents, subject to Terms and Conditions for Electronic Documents at <http://www.sgs.com.tw/Terms-and-Conditions>. Attention is drawn to the limitation of liability, indemnification and jurisdiction issues defined therein. Any holder of this document is advised that information contained hereon reflects the Company's findings at the time of its intervention only and within the limits of Client's instructions, if any. The Company's sole responsibility is to its Client and this document does not exonerate parties to a transaction from exercising all their rights and obligations under the transaction documents. This document cannot be reproduced except in full, without prior written approval of the Company. Any unauthorized alteration, forgery or falsification of the content or appearance of this document is unlawful and offenders may be prosecuted to the fullest extent of the law.

Report Number :TERF2308001923E2
 Operation Mode :802.11a
 Test Frequency :5745 MHz
 Test Mode :Bandedge
 EUT Pol :E2 Plane

Test Site :SAC G Chamber
 Test Date :2023-10-18
 Temp./Humi. :19.7°C/63%
 Antenna Pol. :Horizontal
 Engineer :Temo Chen

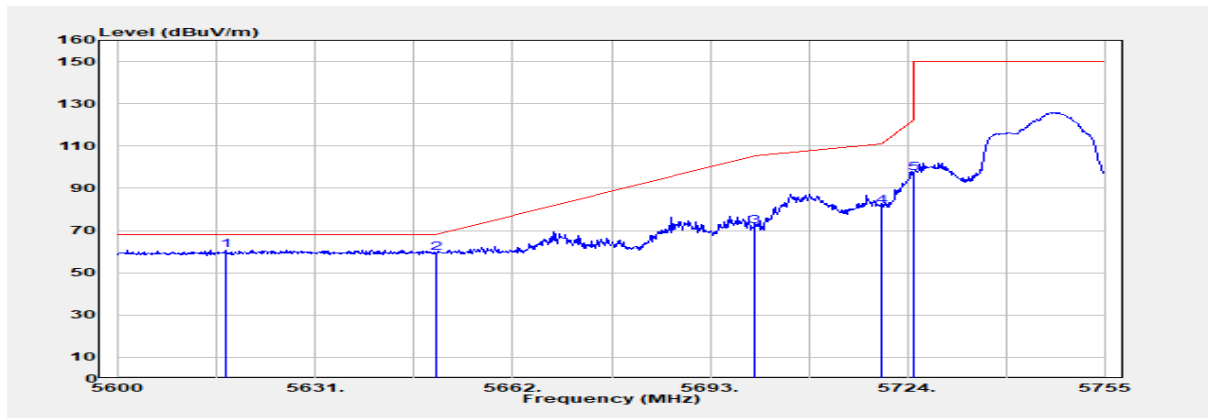

Freq. MHz	Detector Mode PK/QP/AV	Spectrum Reading Level dB μ V	Factor dB	Actual FS dB μ V/m	Limit @3m dB μ V/m	Margin dB
5616.895	Peak	56.64	4.22	60.87	68.20	-7.33
5650.000	Peak	54.44	4.76	59.20	68.20	-9.00
5700.000	Peak	66.36	5.56	71.92	105.20	-33.28
5720.000	Peak	76.10	5.57	81.67	110.80	-29.13
5725.000	Peak	91.53	5.57	97.10	122.20	-25.10

Unless otherwise stated the results shown in this test report refer only to the sample(s) tested and such sample(s) are retained for 90 days only.

除非另有說明，此報告結果僅對測試之樣品負責，同時此樣品僅保留90天。本報告未經本公司書面許可，不可部份複製。

This document is issued by the Company subject to its General Conditions of Service printed overleaf, available on request or accessible at <http://www.sgs.com.tw/Terms-and-Conditions> and for electronic format documents, subject to Terms and Conditions for Electronic Documents at <http://www.sgs.com.tw/Terms-and-Conditions>. Attention is drawn to the limitation of liability, indemnification and jurisdiction issues defined therein. Any holder of this document is advised that information contained hereon reflects the Company's findings at the time of its intervention only and within the limits of Client's instructions, if any. The Company's sole responsibility is to its Client and this document does not exonerate parties to a transaction from exercising all their rights and obligations under the transaction documents. This document cannot be reproduced except in full, without prior written approval of the Company. Any unauthorized alteration, forgery or falsification of the content or appearance of this document is unlawful and offenders may be prosecuted to the fullest extent of the law.

Report Number :TERF2308001923E2
 Operation Mode :802.11a
 Test Frequency :5825 MHz
 Test Mode :Bandedge
 EUT Pol :E2 Plane

Test Site :SAC G Chamber
 Test Date :2023-10-18
 Temp./Humi. :19.7°C/63%
 Antenna Pol. :Vertical
 Engineer :Temo Chen

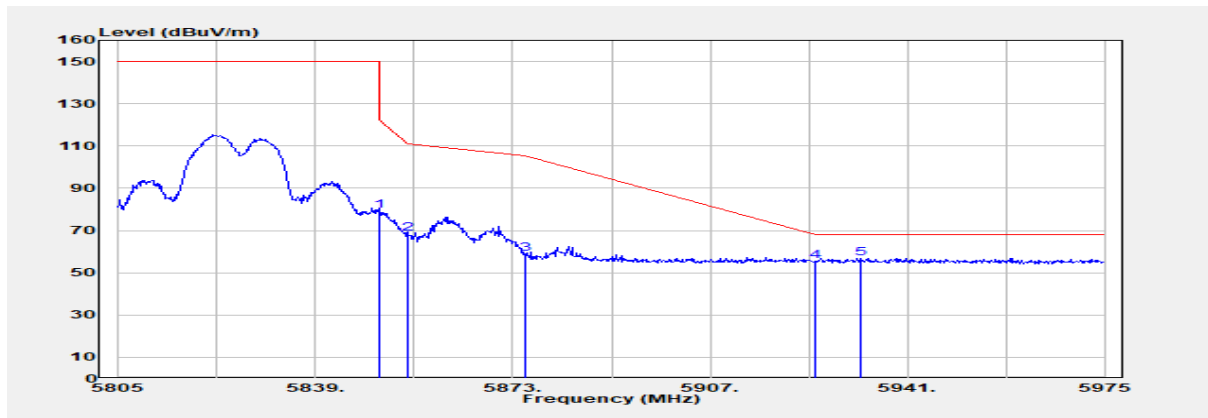

Freq. MHz	Detector Mode PK/QP/AV	Spectrum Reading Level dB μ V	Factor dB	Actual FS dB μ V/m	Limit @3m dB μ V/m	Margin dB
5850.000	Peak	73.51	5.66	79.17	122.20	-43.03
5855.000	Peak	62.90	5.68	68.58	110.80	-42.22
5875.000	Peak	53.21	5.78	58.99	105.20	-46.21
5925.000	Peak	49.67	5.66	55.32	68.20	-12.88
5932.840	Peak	51.39	5.58	56.97	68.20	-11.23

Unless otherwise stated the results shown in this test report refer only to the sample(s) tested and such sample(s) are retained for 90 days only.

除非另有說明，此報告結果僅對測試之樣品負責，同時此樣品僅保留90天。本報告未經本公司書面許可，不可部份複製。

This document is issued by the Company subject to its General Conditions of Service printed overleaf, available on request or accessible at <http://www.sgs.com.tw/Terms-and-Conditions> and for electronic format documents, subject to Terms and Conditions for Electronic Documents at <http://www.sgs.com.tw/Terms-and-Conditions>. Attention is drawn to the limitation of liability, indemnification and jurisdiction issues defined therein. Any holder of this document is advised that information contained hereon reflects the Company's findings at the time of its intervention only and within the limits of Client's instructions, if any. The Company's sole responsibility is to its Client and this document does not exonerate parties to a transaction from exercising all their rights and obligations under the transaction documents. This document cannot be reproduced except in full, without prior written approval of the Company. Any unauthorized alteration, forgery or falsification of the content or appearance of this document is unlawful and offenders may be prosecuted to the fullest extent of the law.

Report Number :TERF2308001923E2
 Operation Mode :802.11a
 Test Frequency :5825 MHz
 Test Mode :Bandedge
 EUT Pol :E2 Plane

Test Site :SAC G Chamber
 Test Date :2023-10-18
 Temp./Humi. :19.7°C/63%
 Antenna Pol. :Horizontal
 Engineer :Temo Chen

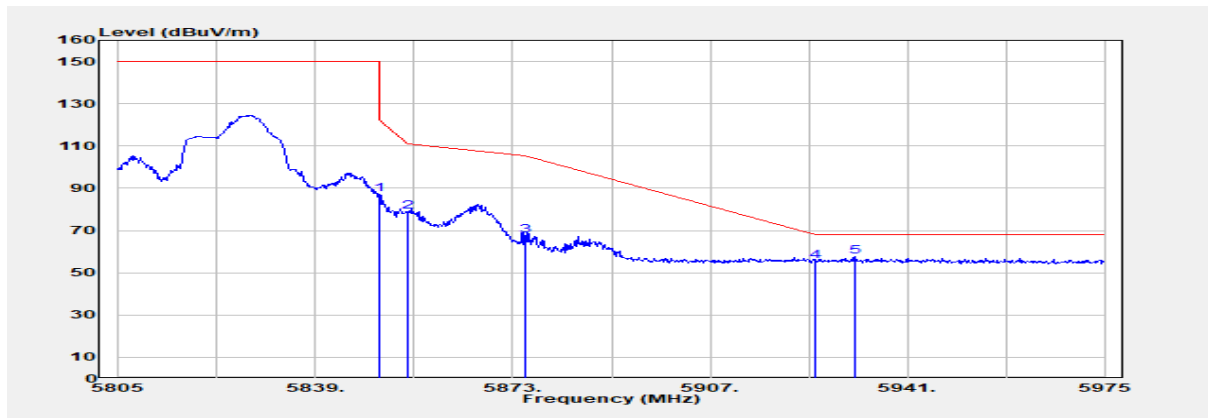

Freq. MHz	Detector Mode PK/QP/AV	Spectrum Reading Level dB μ V	Factor dB	Actual FS dB μ V/m	Limit @3m dB μ V/m	Margin dB
5850.000	Peak	81.44	5.66	87.10	122.20	-35.10
5855.000	Peak	73.16	5.68	78.84	110.80	-31.96
5875.000	Peak	61.76	5.78	67.54	105.20	-37.66
5925.000	Peak	49.89	5.66	55.54	68.20	-12.66
5931.990	Peak	52.22	5.59	57.81	68.20	-10.39

Unless otherwise stated the results shown in this test report refer only to the sample(s) tested and such sample(s) are retained for 90 days only.

除非另有說明，此報告結果僅對測試之樣品負責，同時此樣品僅保留90天。本報告未經本公司書面許可，不可部份複製。

This document is issued by the Company subject to its General Conditions of Service printed overleaf, available on request or accessible at <http://www.sgs.com.tw/Terms-and-Conditions> and for electronic format documents, subject to Terms and Conditions for Electronic Documents at <http://www.sgs.com.tw/Terms-and-Conditions>. Attention is drawn to the limitation of liability, indemnification and jurisdiction issues defined therein. Any holder of this document is advised that information contained hereon reflects the Company's findings at the time of its intervention only and within the limits of Client's instructions, if any. The Company's sole responsibility is to its Client and this document does not exonerate parties to a transaction from exercising all their rights and obligations under the transaction documents. This document cannot be reproduced except in full, without prior written approval of the Company. Any unauthorized alteration, forgery or falsification of the content or appearance of this document is unlawful and offenders may be prosecuted to the fullest extent of the law.

Report Number :TERF2308001923E2
 Operation Mode :802.11n20
 Test Frequency :5180 MHz
 Test Mode :Bandedge
 EUT Pol :E2 Plane

Test Site :SAC G Chamber
 Test Date :2023-10-18
 Temp./Humi. :19.7°C/63%
 Antenna Pol. :Vertical
 Engineer :Temo Chen

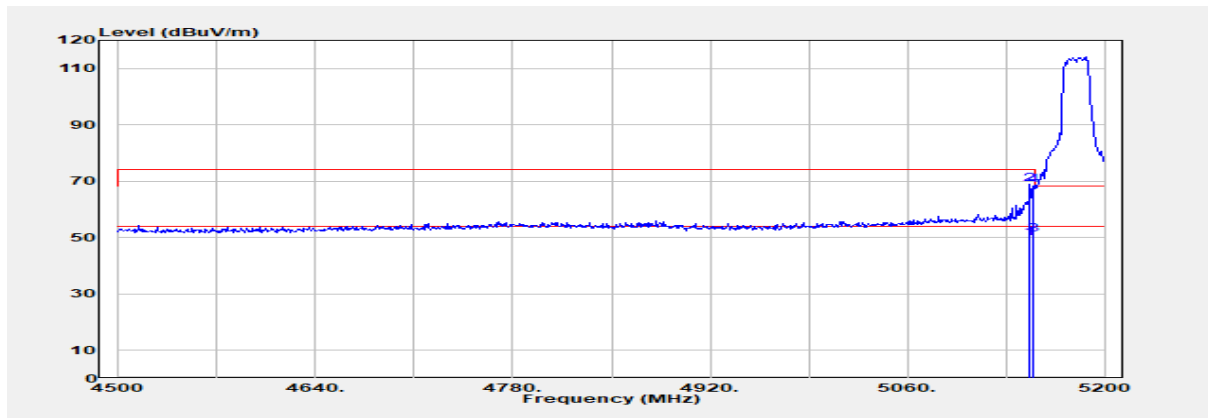

Freq. MHz	Detector Mode PK/QP/AV	Spectrum Reading Level dBμV	Factor dB	Actual FS dBμV/m	Limit @3m dBμV/m	Margin dB
5146.800	Average	46.12	3.77	49.89	54.00	-4.11
5146.800	Peak	65.32	3.77	69.09	74.00	-4.91
5150.000	Average	47.36	3.74	51.10	54.00	-2.90
5150.000	Peak	65.03	3.74	68.77	74.00	-5.23

Unless otherwise stated the results shown in this test report refer only to the sample(s) tested and such sample(s) are retained for 90 days only.

除非另有說明，此報告結果僅對測試之樣品負責，同時此樣品僅保留90天。本報告未經本公司書面許可，不可部份複製。

This document is issued by the Company subject to its General Conditions of Service printed overleaf, available on request or accessible at <http://www.sgs.com.tw/Terms-and-Conditions> and for electronic format documents, subject to Terms and Conditions for Electronic Documents at <http://www.sgs.com.tw/Terms-and-Conditions>. Attention is drawn to the limitation of liability, indemnification and jurisdiction issues defined therein. Any holder of this document is advised that information contained hereon reflects the Company's findings at the time of its intervention only and within the limits of Client's instructions, if any. The Company's sole responsibility is to its Client and this document does not exonerate parties to a transaction from exercising all their rights and obligations under the transaction documents. This document cannot be reproduced except in full, without prior written approval of the Company. Any unauthorized alteration, forgery or falsification of the content or appearance of this document is unlawful and offenders may be prosecuted to the fullest extent of the law.

Report Number :TERF2308001923E2
 Operation Mode :802.11n20
 Test Frequency :5180 MHz
 Test Mode :Bandedge
 EUT Pol :E2 Plane

Test Site :SAC G Chamber
 Test Date :2023-10-18
 Temp./Humi. :19.7°C/63%
 Antenna Pol. :Horizontal
 Engineer :Temo Chen

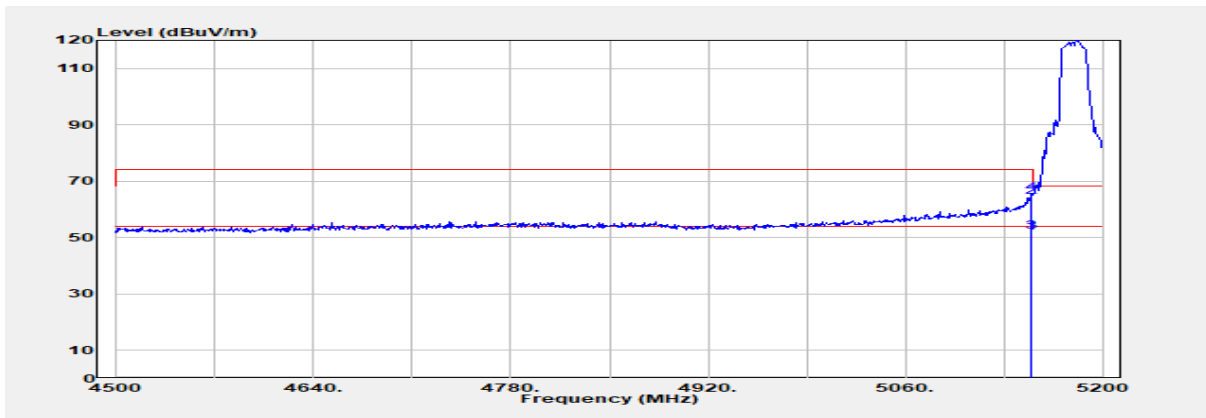

Freq. MHz	Detector Mode	Spectrum Reading Level dB μ V	Factor dB	Actual FS dB μ V/m	Limit @3m dB μ V/m	Margin dB
5148.900	Average	47.93	3.75	51.68	54.00	-2.32
5148.900	Peak	60.75	3.75	64.50	74.00	-9.50
5150.000	Average	48.39	3.74	52.13	54.00	-1.87
5150.000	Peak	61.99	3.74	65.73	74.00	-8.27

Unless otherwise stated the results shown in this test report refer only to the sample(s) tested and such sample(s) are retained for 90 days only.

除非另有說明，此報告結果僅對測試之樣品負責，同時此樣品僅保留90天。本報告未經本公司書面許可，不可部份複製。

This document is issued by the Company subject to its General Conditions of Service printed overleaf, available on request or accessible at <http://www.sgs.com.tw/Terms-and-Conditions> and for electronic format documents, subject to Terms and Conditions for Electronic Documents at <http://www.sgs.com.tw/Terms-and-Conditions>. Attention is drawn to the limitation of liability, indemnification and jurisdiction issues defined therein. Any holder of this document is advised that information contained hereon reflects the Company's findings at the time of its intervention only and within the limits of Client's instructions, if any. The Company's sole responsibility is to its Client and this document does not exonerate parties to a transaction from exercising all their rights and obligations under the transaction documents. This document cannot be reproduced except in full, without prior written approval of the Company. Any unauthorized alteration, forgery or falsification of the content or appearance of this document is unlawful and offenders may be prosecuted to the fullest extent of the law.

Report Number :TERF2308001923E2
 Operation Mode :802.11n20
 Test Frequency :5320 MHz
 Test Mode :Bandedge
 EUT Pol :E2 Plane

Test Site :SAC G Chamber
 Test Date :2023-10-19
 Temp./Humi. :20.2°C/65%
 Antenna Pol. :Vertical
 Engineer :Temo Chen

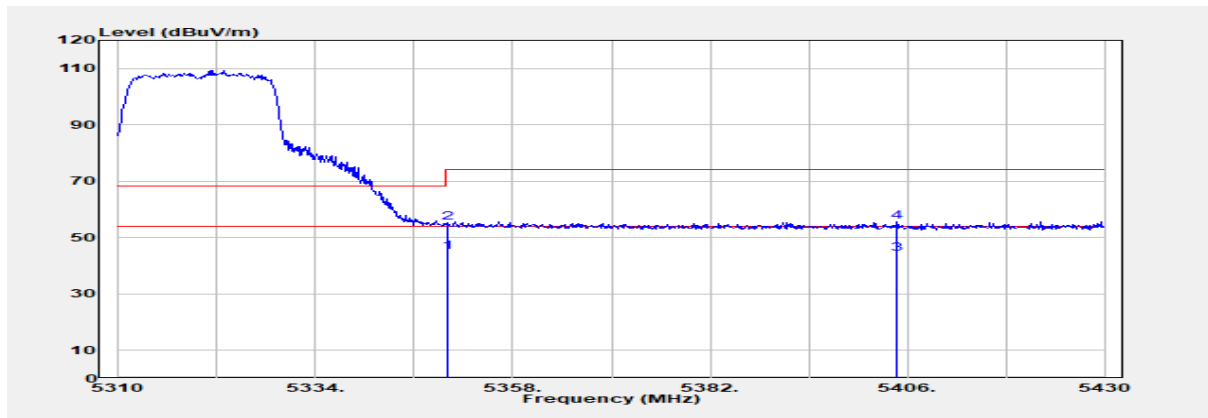

Freq. MHz	Detector Mode PK/QP/AV	Spectrum Reading Level dBμV	Factor dB	Actual FS dBμV/m	Limit @3m dBμV/m	Margin dB
5350.000	Average	41.35	3.37	44.72	54.00	-9.28
5350.000	Peak	52.03	3.37	55.40	74.00	-18.60
5404.800	Average	40.70	3.40	44.10	54.00	-9.90
5404.800	Peak	52.37	3.40	55.77	74.00	-18.23

Unless otherwise stated the results shown in this test report refer only to the sample(s) tested and such sample(s) are retained for 90 days only.

除非另有說明，此報告結果僅對測試之樣品負責，同時此樣品僅保留90天。本報告未經本公司書面許可，不可部份複製。

This document is issued by the Company subject to its General Conditions of Service printed overleaf, available on request or accessible at <http://www.sgs.com.tw/Terms-and-Conditions> and for electronic format documents, subject to Terms and Conditions for Electronic Documents at <http://www.sgs.com.tw/Terms-and-Conditions>. Attention is drawn to the limitation of liability, indemnification and jurisdiction issues defined therein. Any holder of this document is advised that information contained hereon reflects the Company's findings at the time of its intervention only and within the limits of Client's instructions, if any. The Company's sole responsibility is to its Client and this document does not exonerate parties to a transaction from exercising all their rights and obligations under the transaction documents. This document cannot be reproduced except in full, without prior written approval of the Company. Any unauthorized alteration, forgery or falsification of the content or appearance of this document is unlawful and offenders may be prosecuted to the fullest extent of the law.

Report Number :TERF2308001923E2
 Operation Mode :802.11n20
 Test Frequency :5320 MHz
 Test Mode :Bandedge
 EUT Pol :E2 Plane

Test Site :SAC G Chamber
 Test Date :2023-10-19
 Temp./Humi. :20.2°C/65%
 Antenna Pol. :Horizontal
 Engineer :Temo Chen

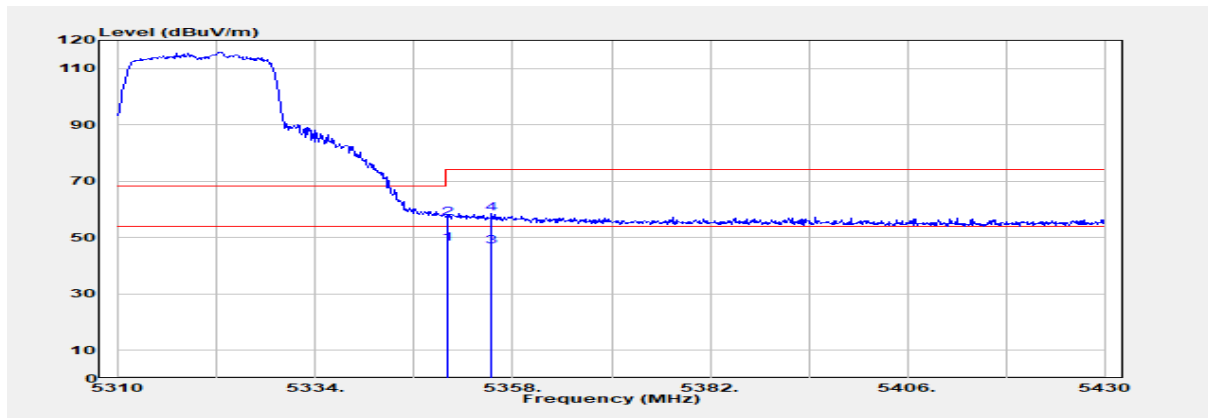

Freq. MHz	Detector Mode PK/QP/AV	Spectrum Reading Level dB μ V	Factor dB	Actual FS dB μ V/m	Limit @3m dB μ V/m	Margin dB
5350.000	Average	44.43	3.37	47.80	54.00	-6.20
5350.000	Peak	53.67	3.37	57.04	74.00	-16.96
5355.360	Average	43.59	3.37	46.96	54.00	-7.04
5355.360	Peak	55.21	3.37	58.58	74.00	-15.42

Unless otherwise stated the results shown in this test report refer only to the sample(s) tested and such sample(s) are retained for 90 days only.

除非另有說明，此報告結果僅對測試之樣品負責，同時此樣品僅保留90天。本報告未經本公司書面許可，不可部份複製。

This document is issued by the Company subject to its General Conditions of Service printed overleaf, available on request or accessible at <http://www.sgs.com.tw/Terms-and-Conditions> and for electronic format documents, subject to Terms and Conditions for Electronic Documents at <http://www.sgs.com.tw/Terms-and-Conditions>. Attention is drawn to the limitation of liability, indemnification and jurisdiction issues defined therein. Any holder of this document is advised that information contained hereon reflects the Company's findings at the time of its intervention only and within the limits of Client's instructions, if any. The Company's sole responsibility is to its Client and this document does not exonerate parties to a transaction from exercising all their rights and obligations under the transaction documents. This document cannot be reproduced except in full, without prior written approval of the Company. Any unauthorized alteration, forgery or falsification of the content or appearance of this document is unlawful and offenders may be prosecuted to the fullest extent of the law.

Report Number :TERF2308001923E2
 Operation Mode :802.11n20
 Test Frequency :5500 MHz
 Test Mode :Bandedge
 EUT Pol :E2 Plane

Test Site :SAC G Chamber
 Test Date :2023-10-19
 Temp./Humi. :20.2°C/65%
 Antenna Pol. :Vertical
 Engineer :Temo Chen

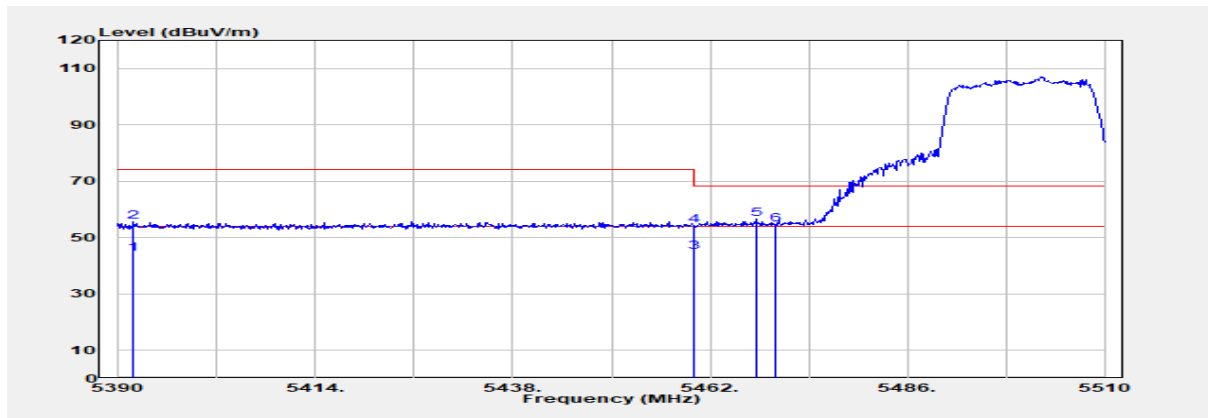

Freq. MHz	Detector Mode PK/QP/AV	Spectrum Reading Level dB μ V	Factor dB	Actual FS dB μ V/m	Limit @3m dB μ V/m	Margin dB
5391.800	Average	40.92	3.38	44.30	54.00	-9.70
5391.800	Peak	52.34	3.38	55.72	74.00	-18.28
5460.000	Average	41.10	3.68	44.78	54.00	-9.22
5460.000	Peak	50.56	3.68	54.24	74.00	-19.76
5467.640	Peak	52.69	3.74	56.43	68.20	-11.77
5470.000	Peak	50.80	3.76	54.56	68.20	-13.64

Unless otherwise stated the results shown in this test report refer only to the sample(s) tested and such sample(s) are retained for 90 days only.

除非另有說明，此報告結果僅對測試之樣品負責，同時此樣品僅保留90天。本報告未經本公司書面許可，不可部份複製。

This document is issued by the Company subject to its General Conditions of Service printed overleaf, available on request or accessible at <http://www.sgs.com.tw/Terms-and-Conditions> and for electronic format documents, subject to Terms and Conditions for Electronic Documents at <http://www.sgs.com.tw/Terms-and-Conditions>. Attention is drawn to the limitation of liability, indemnification and jurisdiction issues defined therein. Any holder of this document is advised that information contained hereon reflects the Company's findings at the time of its intervention only and within the limits of Client's instructions, if any. The Company's sole responsibility is to its Client and this document does not exonerate parties to a transaction from exercising all their rights and obligations under the transaction documents. This document cannot be reproduced except in full, without prior written approval of the Company. Any unauthorized alteration, forgery or falsification of the content or appearance of this document is unlawful and offenders may be prosecuted to the fullest extent of the law.

Report Number :TERF2308001923E2
 Operation Mode :802.11n20
 Test Frequency :5500 MHz
 Test Mode :Bandedge
 EUT Pol :E2 Plane

Test Site :SAC G Chamber
 Test Date :2023-10-19
 Temp./Humi. :20.2°C/65%
 Antenna Pol. :Horizontal
 Engineer :Temo Chen

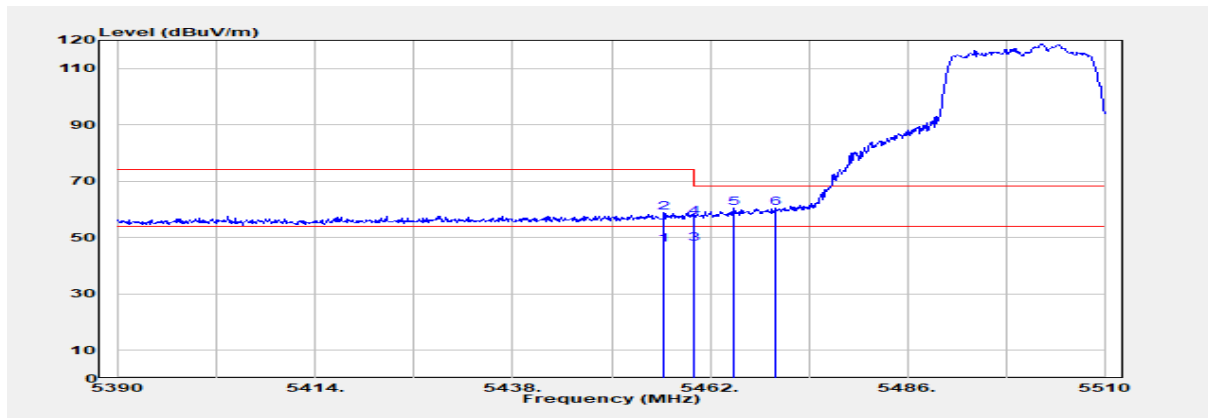

Freq. MHz	Detector Mode PK/QP/AV	Spectrum Reading Level dB μ V	Factor dB	Actual FS dB μ V/m	Limit @3m dB μ V/m	Margin dB
5456.360	Average	43.96	3.65	47.61	54.00	-6.39
5456.360	Peak	55.36	3.65	59.00	74.00	-15.00
5460.000	Average	44.10	3.68	47.78	54.00	-6.22
5460.000	Peak	53.56	3.68	57.24	74.00	-16.76
5464.880	Peak	56.65	3.72	60.37	68.20	-7.83
5470.000	Peak	56.81	3.76	60.57	68.20	-7.63

Unless otherwise stated the results shown in this test report refer only to the sample(s) tested and such sample(s) are retained for 90 days only.

除非另有說明，此報告結果僅對測試之樣品負責，同時此樣品僅保留90天。本報告未經本公司書面許可，不可部份複製。

This document is issued by the Company subject to its General Conditions of Service printed overleaf, available on request or accessible at <http://www.sgs.com.tw/Terms-and-Conditions> and for electronic format documents, subject to Terms and Conditions for Electronic Documents at <http://www.sgs.com.tw/Terms-and-Conditions>. Attention is drawn to the limitation of liability, indemnification and jurisdiction issues defined therein. Any holder of this document is advised that information contained hereon reflects the Company's findings at the time of its intervention only and within the limits of Client's instructions, if any. The Company's sole responsibility is to its Client and this document does not exonerate parties to a transaction from exercising all their rights and obligations under the transaction documents. This document cannot be reproduced except in full, without prior written approval of the Company. Any unauthorized alteration, forgery or falsification of the content or appearance of this document is unlawful and offenders may be prosecuted to the fullest extent of the law.

Report Number :TERF2308001923E2
 Operation Mode :802.11n20
 Test Frequency :5700 MHz
 Test Mode :Bandedge
 EUT Pol :E2 Plane

Test Site :SAC G Chamber
 Test Date :2023-10-19
 Temp./Humi. :20.2°C/65%
 Antenna Pol. :Vertical
 Engineer :Temo Chen

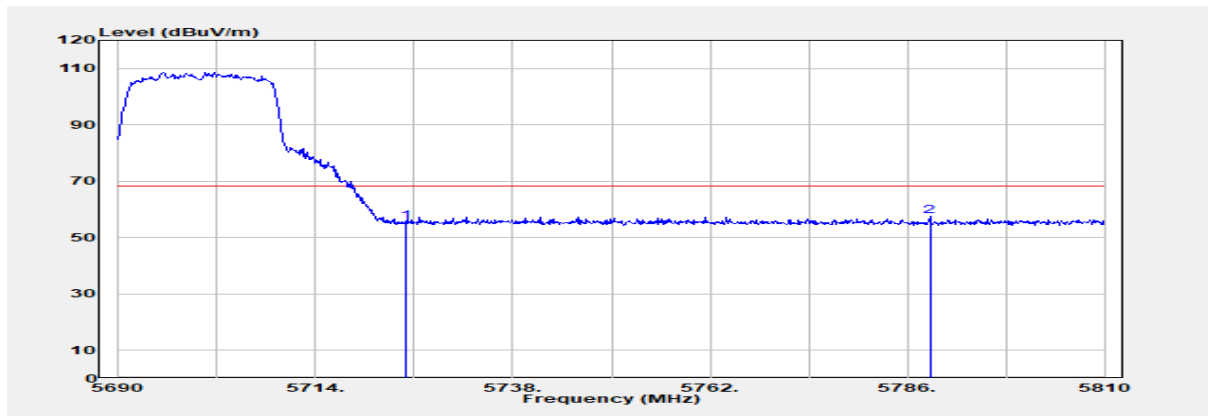

Freq. MHz	Detector Mode PK/QP/AV	Spectrum Reading Level dB μ V	Factor dB	Actual FS dB μ V/m	Limit @3m dB μ V/m	Margin dB
5725.000	Peak	50.15	5.57	55.73	68.20	-12.47
5788.760	Peak	51.87	5.61	57.48	68.20	-10.72

Unless otherwise stated the results shown in this test report refer only to the sample(s) tested and such sample(s) are retained for 90 days only.

除非另有說明，此報告結果僅對測試之樣品負責，同時此樣品僅保留90天。本報告未經本公司書面許可，不可部份複製。

This document is issued by the Company subject to its General Conditions of Service printed overleaf, available on request or accessible at <http://www.sgs.com.tw/Terms-and-Conditions> and for electronic format documents, subject to Terms and Conditions for Electronic Documents at <http://www.sgs.com.tw/Terms-and-Conditions>. Attention is drawn to the limitation of liability, indemnification and jurisdiction issues defined therein. Any holder of this document is advised that information contained hereon reflects the Company's findings at the time of its intervention only and within the limits of Client's instructions, if any. The Company's sole responsibility is to its Client and this document does not exonerate parties to a transaction from exercising all their rights and obligations under the transaction documents. This document cannot be reproduced except in full, without prior written approval of the Company. Any unauthorized alteration, forgery or falsification of the content or appearance of this document is unlawful and offenders may be prosecuted to the fullest extent of the law.

Report Number :TERF2308001923E2
 Operation Mode :802.11n20
 Test Frequency :5700 MHz
 Test Mode :Bandedge
 EUT Pol :E2 Plane

Test Site :SAC G Chamber
 Test Date :2023-10-19
 Temp./Humi. :20.2°C/65%
 Antenna Pol. :Horizontal
 Engineer :Temo Chen

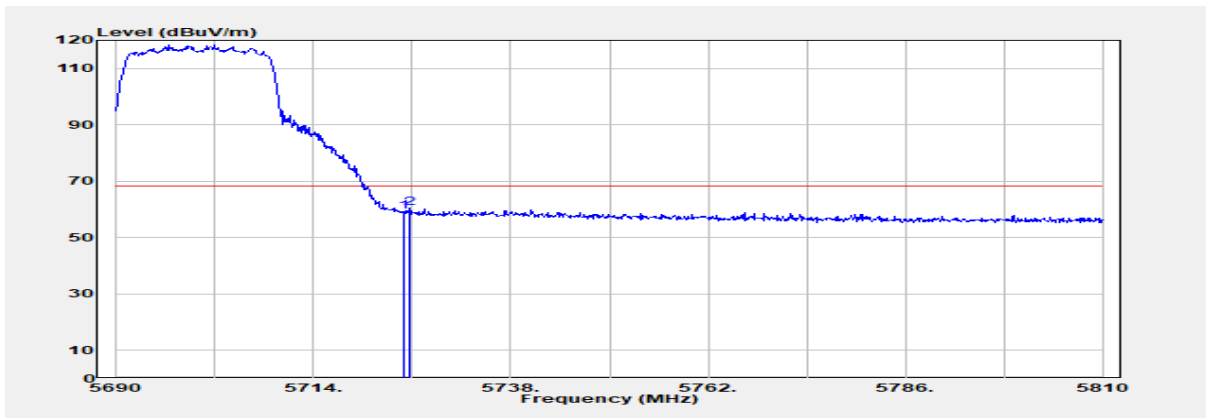

Freq. MHz	Detector Mode	Spectrum Reading Level dB μ V	Factor dB	Actual FS dB μ V/m	Limit @3m dB μ V/m	Margin dB
5725.000	Peak	53.55	5.57	59.12	68.20	-9.08
5725.640	Peak	55.01	5.58	60.58	68.20	-7.62

Unless otherwise stated the results shown in this test report refer only to the sample(s) tested and such sample(s) are retained for 90 days only.

除非另有說明，此報告結果僅對測試之樣品負責，同時此樣品僅保留90天。本報告未經本公司書面許可，不可部份複製。

This document is issued by the Company subject to its General Conditions of Service printed overleaf, available on request or accessible at <http://www.sgs.com.tw/Terms-and-Conditions>, and for electronic format documents, subject to Terms and Conditions for Electronic Documents at <http://www.sgs.com.tw/Terms-and-Conditions>. Attention is drawn to the limitation of liability, indemnification and jurisdiction issues defined therein. Any holder of this document is advised that information contained hereon reflects the Company's findings at the time of its intervention only and within the limits of Client's instructions, if any. The Company's sole responsibility is to its Client and this document does not exonerate parties to a transaction from exercising all their rights and obligations under the transaction documents. This document cannot be reproduced except in full, without prior written approval of the Company. Any unauthorized alteration, forgery or falsification of the content or appearance of this document is unlawful and offenders may be prosecuted to the fullest extent of the law.

Report Number :TERF2308001923E2
 Operation Mode :802.11n20
 Test Frequency :5745 MHz
 Test Mode :Bandedge
 EUT Pol :E2 Plane

Test Site :SAC G Chamber
 Test Date :2023-10-19
 Temp./Humi. :20.2°C/65%
 Antenna Pol. :Vertical
 Engineer :Temo Chen

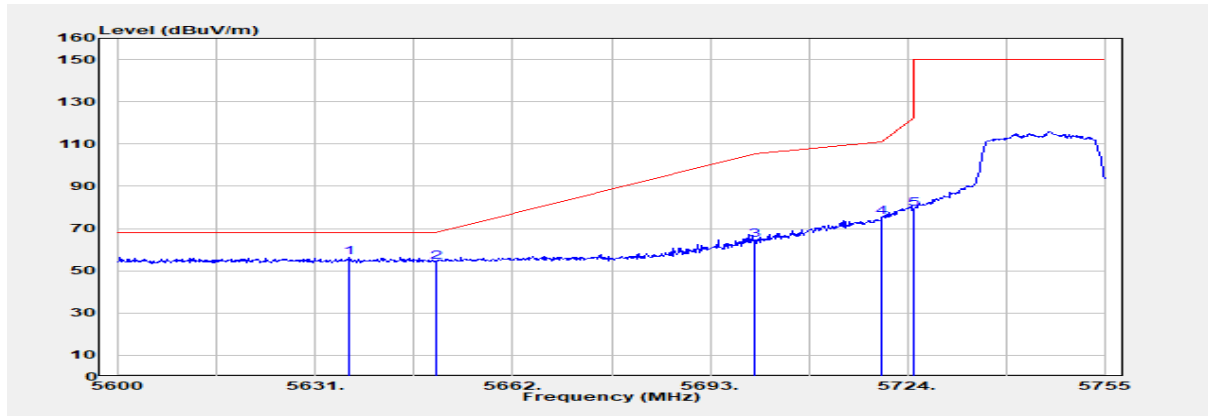

Freq. MHz	Detector Mode PK/QP/AV	Spectrum Reading Level dBμV	Factor dB	Actual FS dBμV/m	Limit @3m dBμV/m	Margin dB
5636.115	Peak	51.83	4.53	56.37	68.20	-11.83
5650.000	Peak	49.57	4.76	54.33	68.20	-13.87
5700.000	Peak	58.84	5.56	64.40	105.20	-40.80
5720.000	Peak	69.95	5.57	75.52	110.80	-35.28
5725.000	Peak	73.80	5.57	79.38	122.20	-42.82

Unless otherwise stated the results shown in this test report refer only to the sample(s) tested and such sample(s) are retained for 90 days only.

除非另有說明，此報告結果僅對測試之樣品負責，同時此樣品僅保留90天。本報告未經本公司書面許可，不可部份複製。

This document is issued by the Company subject to its General Conditions of Service printed overleaf, available on request or accessible at <http://www.sgs.com.tw/Terms-and-Conditions> and for electronic format documents, subject to Terms and Conditions for Electronic Documents at <http://www.sgs.com.tw/Terms-and-Conditions>. Attention is drawn to the limitation of liability, indemnification and jurisdiction issues defined therein. Any holder of this document is advised that information contained hereon reflects the Company's findings at the time of its intervention only and within the limits of Client's instructions, if any. The Company's sole responsibility is to its Client and this document does not exonerate parties to a transaction from exercising all their rights and obligations under the transaction documents. This document cannot be reproduced except in full, without prior written approval of the Company. Any unauthorized alteration, forgery or falsification of the content or appearance of this document is unlawful and offenders may be prosecuted to the fullest extent of the law.

Report Number :TERF2308001923E2
 Operation Mode :802.11n20
 Test Frequency :5745 MHz
 Test Mode :Bandedge
 EUT Pol :E2 Plane

Test Site :SAC G Chamber
 Test Date :2023-10-19
 Temp./Humi. :20.2°C/65%
 Antenna Pol. :Horizontal
 Engineer :Temo Chen

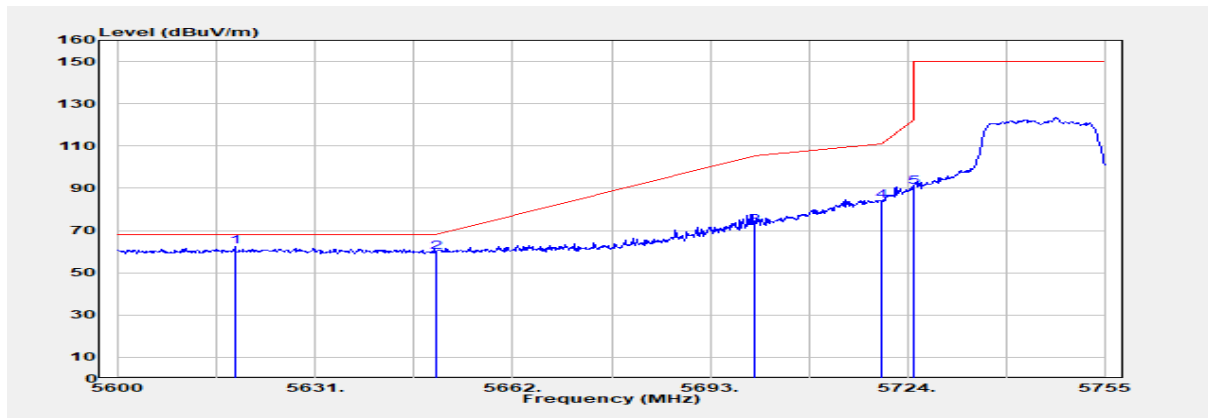

Freq. MHz	Detector Mode PK/QP/AV	Spectrum Reading Level dB μ V	Factor dB	Actual FS dB μ V/m	Limit @3m dB μ V/m	Margin dB
5618.290	Peak	58.15	4.25	62.40	68.20	-5.80
5650.000	Peak	55.23	4.76	59.99	68.20	-8.21
5700.000	Peak	66.93	5.56	72.49	105.20	-32.71
5720.000	Peak	78.63	5.57	84.20	110.80	-26.60
5725.000	Peak	85.13	5.57	90.70	122.20	-31.50

Unless otherwise stated the results shown in this test report refer only to the sample(s) tested and such sample(s) are retained for 90 days only.

除非另有說明，此報告結果僅對測試之樣品負責，同時此樣品僅保留90天。本報告未經本公司書面許可，不可部份複製。

This document is issued by the Company subject to its General Conditions of Service printed overleaf, available on request or accessible at <http://www.sgs.com.tw/Terms-and-Conditions> and for electronic format documents, subject to Terms and Conditions for Electronic Documents at <http://www.sgs.com.tw/Terms-and-Conditions>. Attention is drawn to the limitation of liability, indemnification and jurisdiction issues defined therein. Any holder of this document is advised that information contained hereon reflects the Company's findings at the time of its intervention only and within the limits of Client's instructions, if any. The Company's sole responsibility is to its Client and this document does not exonerate parties to a transaction from exercising all their rights and obligations under the transaction documents. This document cannot be reproduced except in full, without prior written approval of the Company. Any unauthorized alteration, forgery or falsification of the content or appearance of this document is unlawful and offenders may be prosecuted to the fullest extent of the law.

Report Number :TERF2308001923E2
 Operation Mode :802.11n20
 Test Frequency :5825 MHz
 Test Mode :Bandedge
 EUT Pol :E2 Plane

Test Site :SAC G Chamber
 Test Date :2023-10-19
 Temp./Humi. :20.2°C/65%
 Antenna Pol. :Vertical
 Engineer :Temo Chen

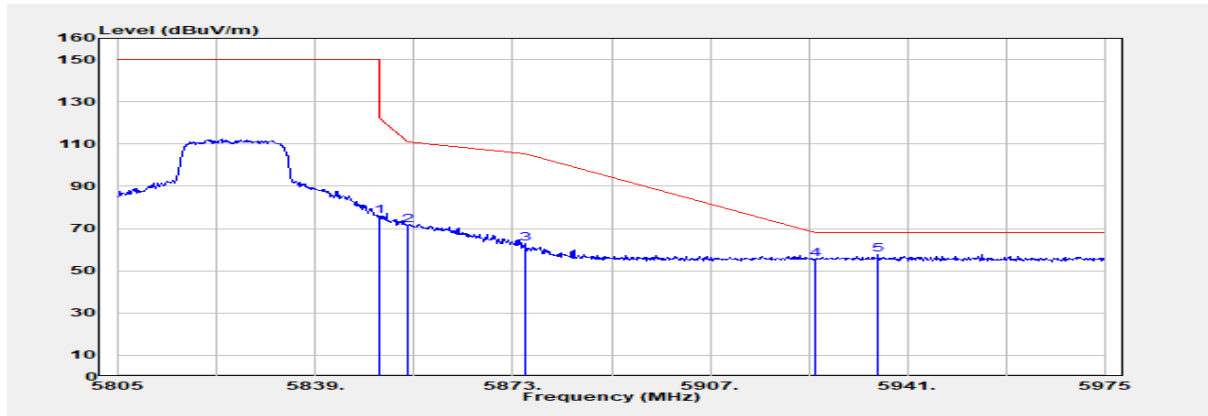

Freq. MHz	Detector Mode PK/QP/AV	Spectrum Reading Level dB μ V	Factor dB	Actual FS dB μ V/m	Limit @3m dB μ V/m	Margin dB
5850.000	Peak	70.33	5.66	75.99	122.20	-46.21
5855.000	Peak	65.95	5.68	71.63	110.80	-39.17
5875.000	Peak	57.23	5.78	63.01	105.20	-42.19
5925.000	Peak	49.69	5.66	55.35	68.20	-12.85
5936.070	Peak	52.00	5.55	57.55	68.20	-10.65

Unless otherwise stated the results shown in this test report refer only to the sample(s) tested and such sample(s) are retained for 90 days only.

除非另有說明，此報告結果僅對測試之樣品負責，同時此樣品僅保留90天。本報告未經本公司書面許可，不可部份複製。

This document is issued by the Company subject to its General Conditions of Service printed overleaf, available on request or accessible at <http://www.sgs.com.tw/Terms-and-Conditions> and for electronic format documents, subject to Terms and Conditions for Electronic Documents at <http://www.sgs.com.tw/Terms-and-Conditions>. Attention is drawn to the limitation of liability, indemnification and jurisdiction issues defined therein. Any holder of this document is advised that information contained hereon reflects the Company's findings at the time of its intervention only and within the limits of Client's instructions, if any. The Company's sole responsibility is to its Client and this document does not exonerate parties to a transaction from exercising all their rights and obligations under the transaction documents. This document cannot be reproduced except in full, without prior written approval of the Company. Any unauthorized alteration, forgery or falsification of the content or appearance of this document is unlawful and offenders may be prosecuted to the fullest extent of the law.

Report Number :TERF2308001923E2
 Operation Mode :802.11n20
 Test Frequency :5825 MHz
 Test Mode :Bandedge
 EUT Pol :E2 Plane

Test Site :SAC G Chamber
 Test Date :2023-10-19
 Temp./Humi. :20.2°C/65%
 Antenna Pol. :Horizontal
 Engineer :Temo Chen

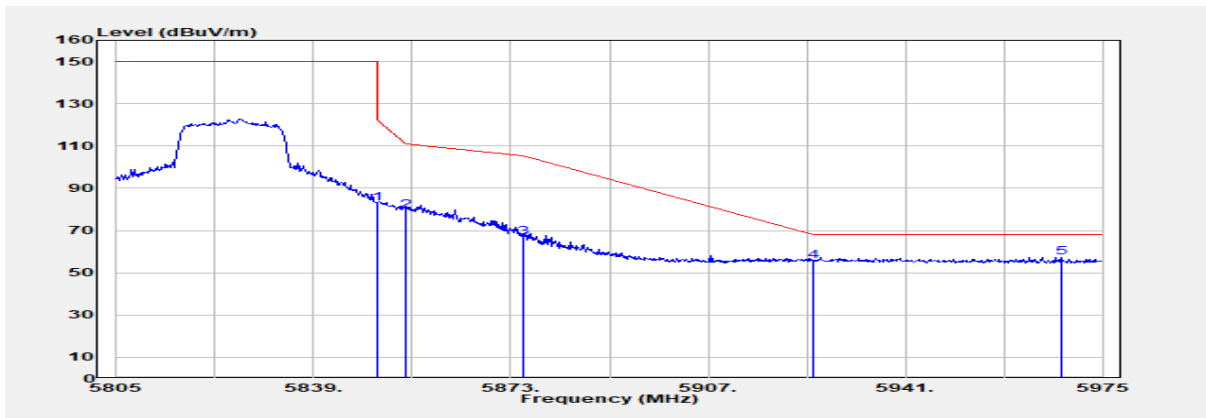

Freq. MHz	Detector Mode PK/QP/AV	Spectrum Reading Level dB μ V	Factor dB	Actual FS dB μ V/m	Limit @3m dB μ V/m	Margin dB
5850.000	Peak	77.36	5.66	83.02	122.20	-39.18
5855.000	Peak	73.80	5.68	79.48	110.80	-31.32
5875.000	Peak	60.88	5.78	66.66	105.20	-38.54
5925.000	Peak	49.66	5.66	55.31	68.20	-12.89
5967.860	Peak	52.22	5.20	57.42	68.20	-10.78

Unless otherwise stated the results shown in this test report refer only to the sample(s) tested and such sample(s) are retained for 90 days only.

除非另有說明，此報告結果僅對測試之樣品負責，同時此樣品僅保留90天。本報告未經本公司書面許可，不可部份複製。

This document is issued by the Company subject to its General Conditions of Service printed overleaf, available on request or accessible at <http://www.sgs.com.tw/Terms-and-Conditions> and for electronic format documents, subject to Terms and Conditions for Electronic Documents at <http://www.sgs.com.tw/Terms-and-Conditions>. Attention is drawn to the limitation of liability, indemnification and jurisdiction issues defined therein. Any holder of this document is advised that information contained hereon reflects the Company's findings at the time of its intervention only and within the limits of Client's instructions, if any. The Company's sole responsibility is to its Client and this document does not exonerate parties to a transaction from exercising all their rights and obligations under the transaction documents. This document cannot be reproduced except in full, without prior written approval of the Company. Any unauthorized alteration, forgery or falsification of the content or appearance of this document is unlawful and offenders may be prosecuted to the fullest extent of the law.

Report Number :TERF2308001923E2
 Operation Mode :802.11n40
 Test Frequency :5190 MHz
 Test Mode :Bandedge
 EUT Pol :E2 Plane

Test Site :SAC G Chamber
 Test Date :2023-10-18
 Temp./Humi. :19.7°C/63%
 Antenna Pol. :Vertical
 Engineer :Temo Chen

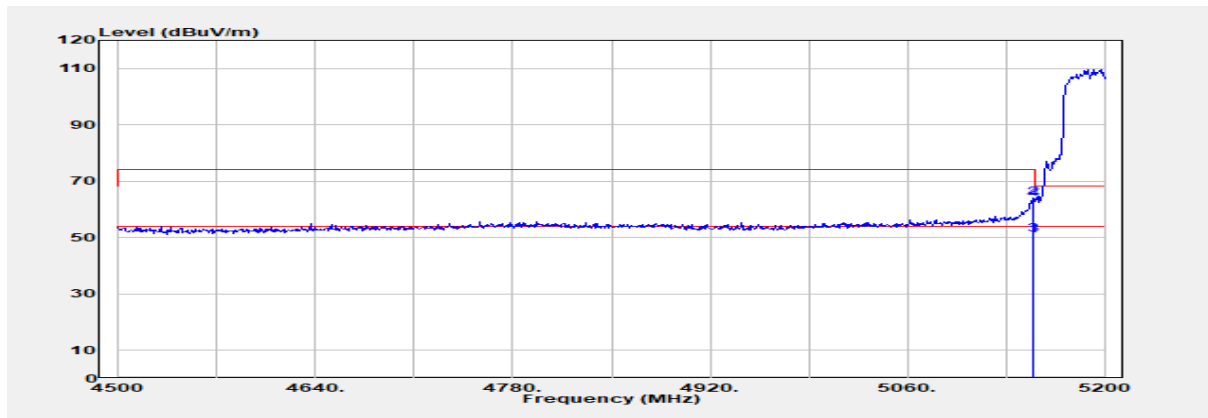

Freq. MHz	Detector Mode	Spectrum Reading Level dB μ V	Factor dB	Actual FS dB μ V/m	Limit @3m dB μ V/m	Margin dB
5148.900	Average	46.82	3.75	50.58	54.00	-3.42
5148.900	Peak	60.33	3.75	64.09	74.00	-9.91
5150.000	Average	47.33	3.74	51.07	54.00	-2.93
5150.000	Peak	59.97	3.74	63.72	74.00	-10.28

Unless otherwise stated the results shown in this test report refer only to the sample(s) tested and such sample(s) are retained for 90 days only.

除非另有說明，此報告結果僅對測試之樣品負責，同時此樣品僅保留90天。本報告未經本公司書面許可，不可部份複製。

This document is issued by the Company subject to its General Conditions of Service printed overleaf, available on request or accessible at <http://www.sgs.com.tw/Terms-and-Conditions> and for electronic format documents, subject to Terms and Conditions for Electronic Documents at <http://www.sgs.com.tw/Terms-and-Conditions>. Attention is drawn to the limitation of liability, indemnification and jurisdiction issues defined therein. Any holder of this document is advised that information contained hereon reflects the Company's findings at the time of its intervention only and within the limits of Client's instructions, if any. The Company's sole responsibility is to its Client and this document does not exonerate parties to a transaction from exercising all their rights and obligations under the transaction documents. This document cannot be reproduced except in full, without prior written approval of the Company. Any unauthorized alteration, forgery or falsification of the content or appearance of this document is unlawful and offenders may be prosecuted to the fullest extent of the law.

Report Number :TERF2308001923E2
 Operation Mode :802.11n40
 Test Frequency :5190 MHz
 Test Mode :Bandedge
 EUT Pol :E2 Plane

Test Site :SAC G Chamber
 Test Date :2023-10-18
 Temp./Humi. :19.7°C/63%
 Antenna Pol. :Horizontal
 Engineer :Temo Chen

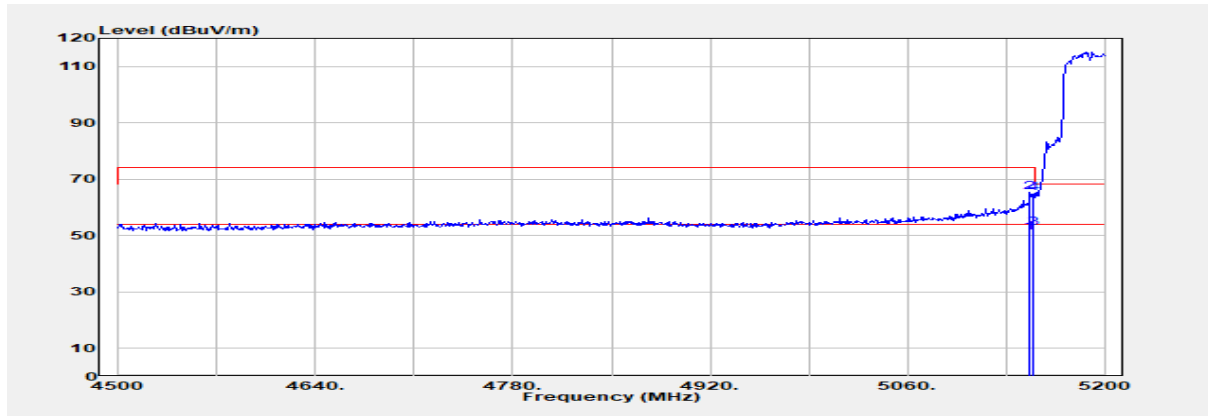

Freq. MHz	Detector Mode	Spectrum Reading Level dB μ V	Factor dB	Actual FS dB μ V/m	Limit @3m dB μ V/m	Margin dB
5146.800	Average	47.43	3.77	51.21	54.00	-2.79
5146.800	Peak	61.48	3.77	65.25	74.00	-8.75
5150.000	Average	48.80	3.74	52.55	54.00	-1.45
5150.000	Peak	61.21	3.74	64.95	74.00	-9.05

Unless otherwise stated the results shown in this test report refer only to the sample(s) tested and such sample(s) are retained for 90 days only.

除非另有說明，此報告結果僅對測試之樣品負責，同時此樣品僅保留90天。本報告未經本公司書面許可，不可部份複製。

This document is issued by the Company subject to its General Conditions of Service printed overleaf, available on request or accessible at <http://www.sgs.com.tw/Terms-and-Conditions> and for electronic format documents, subject to Terms and Conditions for Electronic Documents at <http://www.sgs.com.tw/Terms-and-Conditions>. Attention is drawn to the limitation of liability, indemnification and jurisdiction issues defined therein. Any holder of this document is advised that information contained hereon reflects the Company's findings at the time of its intervention only and within the limits of Client's instructions, if any. The Company's sole responsibility is to its Client and this document does not exonerate parties to a transaction from exercising all their rights and obligations under the transaction documents. This document cannot be reproduced except in full, without prior written approval of the Company. Any unauthorized alteration, forgery or falsification of the content or appearance of this document is unlawful and offenders may be prosecuted to the fullest extent of the law.

Report Number :TERF2308001923E2
 Operation Mode :802.11n40
 Test Frequency :5310 MHz
 Test Mode :Bandedge
 EUT Pol :E2 Plane

Test Site :SAC G Chamber
 Test Date :2023-10-18
 Temp./Humi. :19.7°C/63%
 Antenna Pol. :Vertical
 Engineer :Temo Chen

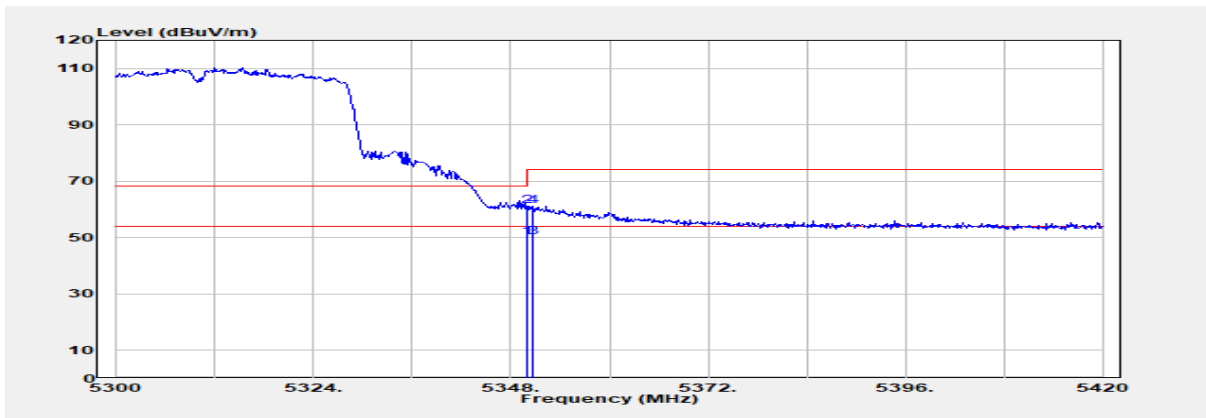

Freq. MHz	Detector Mode PK/QP/AV	Spectrum Reading Level dBμV	Factor dB	Actual FS dBμV/m	Limit @3m dBμV/m	Margin dB
5350.000	Average	46.67	3.37	50.04	54.00	-3.96
5350.000	Peak	57.71	3.37	61.08	74.00	-12.92
5350.760	Average	46.58	3.37	49.95	54.00	-4.05
5350.760	Peak	57.70	3.37	61.07	74.00	-12.93

Unless otherwise stated the results shown in this test report refer only to the sample(s) tested and such sample(s) are retained for 90 days only.

除非另有說明，此報告結果僅對測試之樣品負責，同時此樣品僅保留90天。本報告未經本公司書面許可，不可部份複製。
 This document is issued by the Company subject to its General Conditions of Service printed overleaf, available on request or accessible at <http://www.sgs.com.tw/Terms-and-Conditions> and for electronic format documents, subject to Terms and Conditions for Electronic Documents at <http://www.sgs.com.tw/Terms-and-Conditions>. Attention is drawn to the limitation of liability, indemnification and jurisdiction issues defined therein. Any holder of this document is advised that information contained hereon reflects the Company's findings at the time of its intervention only and within the limits of Client's instructions, if any. The Company's sole responsibility is to its Client and this document does not exonerate parties to a transaction from exercising all their rights and obligations under the transaction documents. This document cannot be reproduced except in full, without prior written approval of the Company. Any unauthorized alteration, forgery or falsification of the content or appearance of this document is unlawful and offenders may be prosecuted to the fullest extent of the law.

Report Number :TERF2308001923E2

Test Site :SAC G Chamber

Operation Mode :802.11n40

Test Date :2023-10-18

Test Frequency :5310 MHz

Temp./Humi. :19.7°C/63%

Test Mode :Bandedge

Antenna Pol. :Horizontal

EUT Pol :E2 Plane

Engineer :Temo Chen

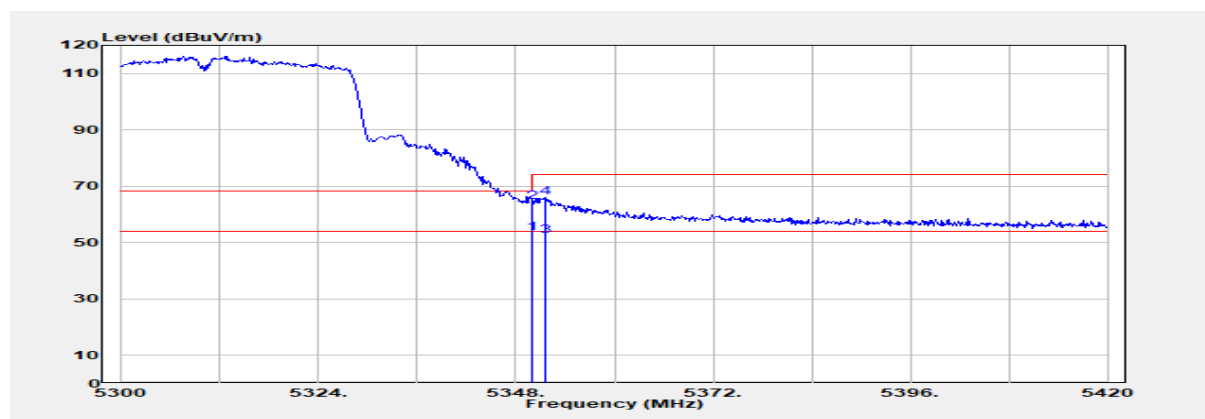

Freq. MHz	Detector Mode PK/QP/AV	Spectrum Reading Level dB μ V	Factor dB	Actual FS dB μ V/m	Limit @3m dB μ V/m	Margin dB
5350.000	Average	49.97	3.37	53.34	54.00	-0.66
5350.000	Peak	61.15	3.37	64.52	74.00	-9.48
5351.480	Average	48.88	3.37	52.25	54.00	-1.75
5351.480	Peak	62.49	3.37	65.86	74.00	-8.14

Unless otherwise stated the results shown in this test report refer only to the sample(s) tested and such sample(s) are retained for 90 days only.

除非另有說明，此報告結果僅對測試之樣品負責，同時此樣品僅保留90天。本報告未經本公司書面許可，不可部份複製。
This document is issued by the Company subject to its General Conditions of Service printed overleaf, available on request or accessible at <http://www.sgs.com.tw/Terms-and-Conditions> and for electronic format documents, subject to Terms and Conditions for Electronic Documents at <http://www.sgs.com.tw/Terms-and-Conditions>. Attention is drawn to the limitation of liability, indemnification and jurisdiction issues defined therein. Any holder of this document is advised that information contained hereon reflects the Company's findings at the time of its intervention only and within the limits of Client's instructions, if any. The Company's sole responsibility is to its Client and this document does not exonerate parties to a transaction from exercising all their rights and obligations under the transaction documents. This document cannot be reproduced except in full, without prior written approval of the Company. Any unauthorized alteration, forgery or falsification of the content or appearance of this document is unlawful and offenders may be prosecuted to the fullest extent of the law.

Report Number :TERF2308001923E2
 Operation Mode :802.11n40
 Test Frequency :5510 MHz
 Test Mode :Bandedge
 EUT Pol :E2 Plane

Test Site :SAC G Chamber
 Test Date :2023-10-19
 Temp./Humi. :20.2°C/65%
 Antenna Pol. :Vertical
 Engineer :Temo Chen

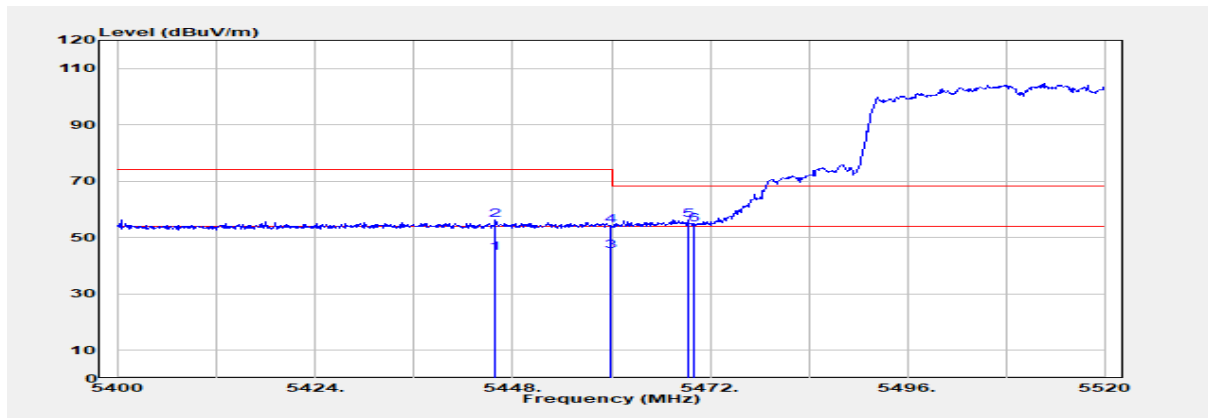

Freq. MHz	Detector Mode PK/QP/AV	Spectrum Reading Level dB μ V	Factor dB	Actual FS dB μ V/m	Limit @3m dB μ V/m	Margin dB
5445.840	Average	41.13	3.58	44.71	54.00	-9.29
5445.840	Peak	52.70	3.58	56.28	74.00	-17.72
5460.000	Average	41.43	3.68	45.11	54.00	-8.89
5460.000	Peak	50.54	3.68	54.22	74.00	-19.78
5469.240	Peak	52.51	3.76	56.27	68.20	-11.93
5470.000	Peak	50.91	3.76	54.67	68.20	-13.53

Unless otherwise stated the results shown in this test report refer only to the sample(s) tested and such sample(s) are retained for 90 days only.

除非另有說明，此報告結果僅對測試之樣品負責，同時此樣品僅保留90天。本報告未經本公司書面許可，不可部份複製。

This document is issued by the Company subject to its General Conditions of Service printed overleaf, available on request or accessible at <http://www.sgs.com.tw/Terms-and-Conditions> and for electronic format documents, subject to Terms and Conditions for Electronic Documents at <http://www.sgs.com.tw/Terms-and-Conditions>. Attention is drawn to the limitation of liability, indemnification and jurisdiction issues defined therein. Any holder of this document is advised that information contained hereon reflects the Company's findings at the time of its intervention only and within the limits of Client's instructions, if any. The Company's sole responsibility is to its Client and this document does not exonerate parties to a transaction from exercising all their rights and obligations under the transaction documents. This document cannot be reproduced except in full, without prior written approval of the Company. Any unauthorized alteration, forgery or falsification of the content or appearance of this document is unlawful and offenders may be prosecuted to the fullest extent of the law.

Report Number :TERF2308001923E2
 Operation Mode :802.11n40
 Test Frequency :5510 MHz
 Test Mode :Bandedge
 EUT Pol :E2 Plane

Test Site :SAC G Chamber
 Test Date :2023-10-19
 Temp./Humi. :20.2°C/65%
 Antenna Pol. :Horizontal
 Engineer :Temo Chen

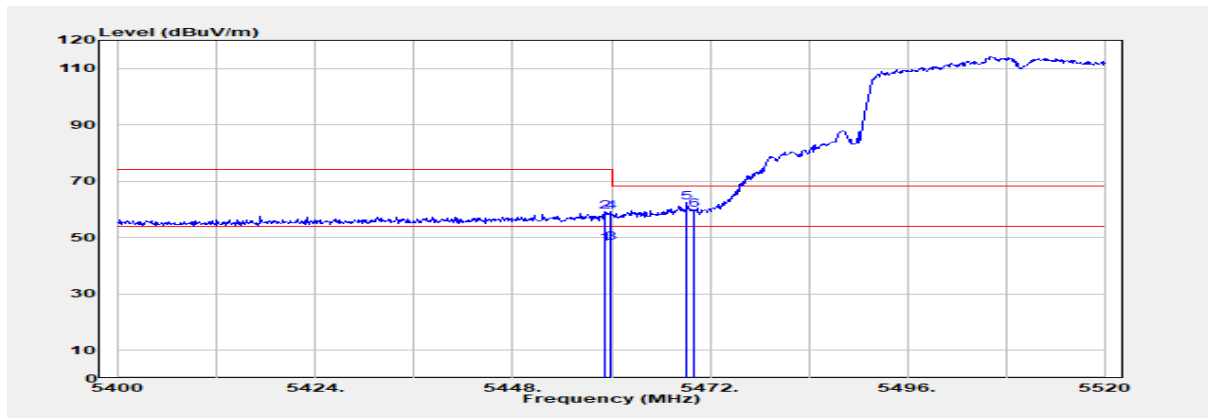

Freq. MHz	Detector Mode PK/QP/AV	Spectrum Reading Level dB μ V	Factor dB	Actual FS dB μ V/m	Limit @3m dB μ V/m	Margin dB
5459.280	Average	44.05	3.67	47.73	54.00	-6.27
5459.280	Peak	55.43	3.67	59.10	74.00	-14.90
5460.000	Average	44.36	3.68	48.04	54.00	-5.96
5460.000	Peak	55.50	3.68	59.18	74.00	-14.82
5469.120	Peak	58.63	3.75	62.39	68.20	-5.81
5470.000	Peak	56.24	3.76	60.00	68.20	-8.20

Unless otherwise stated the results shown in this test report refer only to the sample(s) tested and such sample(s) are retained for 90 days only.

除非另有說明，此報告結果僅對測試之樣品負責，同時此樣品僅保留90天。本報告未經本公司書面許可，不可部份複製。

This document is issued by the Company subject to its General Conditions of Service printed overleaf, available on request or accessible at <http://www.sgs.com.tw/Terms-and-Conditions> and for electronic format documents, subject to Terms and Conditions for Electronic Documents at <http://www.sgs.com.tw/Terms-and-Conditions>. Attention is drawn to the limitation of liability, indemnification and jurisdiction issues defined therein. Any holder of this document is advised that information contained hereon reflects the Company's findings at the time of its intervention only and within the limits of Client's instructions, if any. The Company's sole responsibility is to its Client and this document does not exonerate parties to a transaction from exercising all their rights and obligations under the transaction documents. This document cannot be reproduced except in full, without prior written approval of the Company. Any unauthorized alteration, forgery or falsification of the content or appearance of this document is unlawful and offenders may be prosecuted to the fullest extent of the law.

Report Number :TERF2308001923E2
 Operation Mode :802.11n40
 Test Frequency :5670 MHz
 Test Mode :Bandedge
 EUT Pol :E2 Plane

Test Site :SAC G Chamber
 Test Date :2023-10-19
 Temp./Humi. :20.2°C/65%
 Antenna Pol. :Vertical
 Engineer :Temo Chen

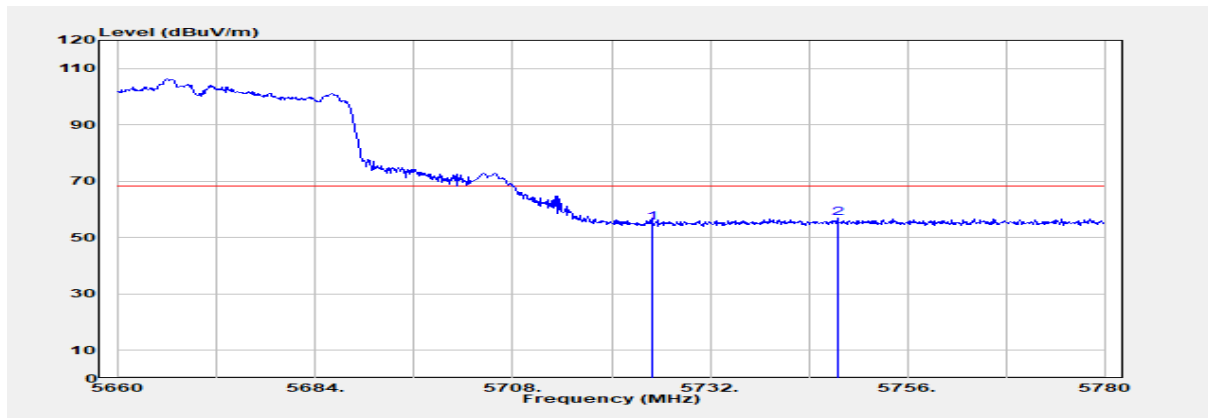

Freq. MHz	Detector Mode PK/QP/AV	Spectrum Reading Level dB μ V	Factor dB	Actual FS dB μ V/m	Limit @3m dB μ V/m	Margin dB
5725.000	Peak	49.56	5.57	55.13	68.20	-13.07
5747.480	Peak	51.24	5.59	56.83	68.20	-11.37

Unless otherwise stated the results shown in this test report refer only to the sample(s) tested and such sample(s) are retained for 90 days only.

除非另有說明，此報告結果僅對測試之樣品負責，同時此樣品僅保留90天。本報告未經本公司書面許可，不可部份複製。

This document is issued by the Company subject to its General Conditions of Service printed overleaf, available on request or accessible at <http://www.sgs.com.tw/Terms-and-Conditions>, and for electronic format documents, subject to Terms and Conditions for Electronic Documents at <http://www.sgs.com.tw/Terms-and-Conditions>. Attention is drawn to the limitation of liability, indemnification and jurisdiction issues defined therein. Any holder of this document is advised that information contained hereon reflects the Company's findings at the time of its intervention only and within the limits of Client's instructions, if any. The Company's sole responsibility is to its Client and this document does not exonerate parties to a transaction from exercising all their rights and obligations under the transaction documents. This document cannot be reproduced except in full, without prior written approval of the Company. Any unauthorized alteration, forgery or falsification of the content or appearance of this document is unlawful and offenders may be prosecuted to the fullest extent of the law.

Report Number :TERF2308001923E2
 Operation Mode :802.11n40
 Test Frequency :5670 MHz
 Test Mode :Bandedge
 EUT Pol :E2 Plane

Test Site :SAC G Chamber
 Test Date :2023-10-19
 Temp./Humi. :20.2°C/65%
 Antenna Pol. :Horizontal
 Engineer :Temo Chen

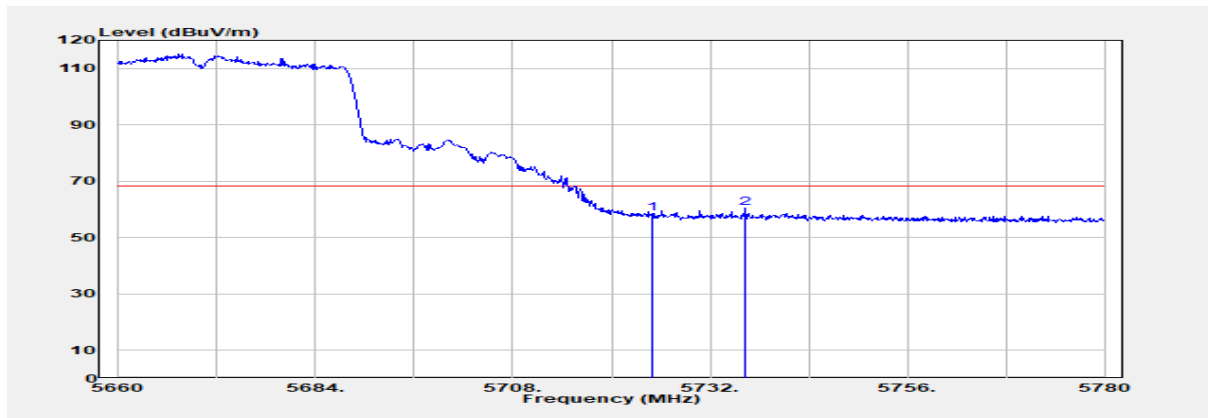

Freq. MHz	Detector Mode PK/QP/AV	Spectrum Reading Level dB μ V	Factor dB	Actual FS dB μ V/m	Limit @3m dB μ V/m	Margin dB
5725.000	Peak	52.85	5.57	58.43	68.20	-9.77
5736.320	Peak	54.99	5.58	60.57	68.20	-7.63

Unless otherwise stated the results shown in this test report refer only to the sample(s) tested and such sample(s) are retained for 90 days only.

除非另有說明，此報告結果僅對測試之樣品負責，同時此樣品僅保留90天。本報告未經本公司書面許可，不可部份複製。

This document is issued by the Company subject to its General Conditions of Service printed overleaf, available on request or accessible at <http://www.sgs.com.tw/Terms-and-Conditions> and for electronic format documents, subject to Terms and Conditions for Electronic Documents at <http://www.sgs.com.tw/Terms-and-Conditions>. Attention is drawn to the limitation of liability, indemnification and jurisdiction issues defined therein. Any holder of this document is advised that information contained hereon reflects the Company's findings at the time of its intervention only and within the limits of Client's instructions, if any. The Company's sole responsibility is to its Client and this document does not exonerate parties to a transaction from exercising all their rights and obligations under the transaction documents. This document cannot be reproduced except in full, without prior written approval of the Company. Any unauthorized alteration, forgery or falsification of the content or appearance of this document is unlawful and offenders may be prosecuted to the fullest extent of the law.

Report Number :TERF2308001923E2
 Operation Mode :802.11n40
 Test Frequency :5755 MHz
 Test Mode :Bandedge
 EUT Pol :E2 Plane

Test Site :SAC G Chamber
 Test Date :2023-10-18
 Temp./Humi. :19.7°C/63%
 Antenna Pol. :Vertical
 Engineer :Temo Chen

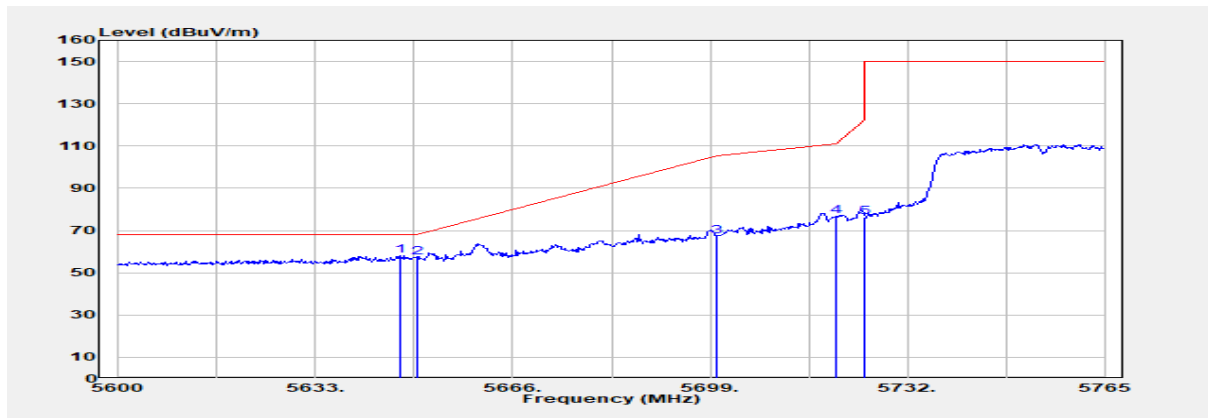

Freq. MHz	Detector Mode PK/QP/AV	Spectrum Reading Level dB μ V	Factor dB	Actual FS dB μ V/m	Limit @3m dB μ V/m	Margin dB
5647.025	Peak	53.37	4.71	58.08	68.20	-10.12
5650.000	Peak	52.37	4.76	57.13	68.20	-11.07
5700.000	Peak	61.76	5.56	67.32	105.20	-37.88
5720.000	Peak	71.01	5.57	76.58	110.80	-34.22
5725.000	Peak	70.94	5.57	76.51	122.20	-45.69

Unless otherwise stated the results shown in this test report refer only to the sample(s) tested and such sample(s) are retained for 90 days only.

除非另有說明，此報告結果僅對測試之樣品負責，同時此樣品僅保留90天。本報告未經本公司書面許可，不可部份複製。

This document is issued by the Company subject to its General Conditions of Service printed overleaf, available on request or accessible at <http://www.sgs.com.tw/Terms-and-Conditions> and for electronic format documents, subject to Terms and Conditions for Electronic Documents at <http://www.sgs.com.tw/Terms-and-Conditions>. Attention is drawn to the limitation of liability, indemnification and jurisdiction issues defined therein. Any holder of this document is advised that information contained hereon reflects the Company's findings at the time of its intervention only and within the limits of Client's instructions, if any. The Company's sole responsibility is to its Client and this document does not exonerate parties to a transaction from exercising all their rights and obligations under the transaction documents. This document cannot be reproduced except in full, without prior written approval of the Company. Any unauthorized alteration, forgery or falsification of the content or appearance of this document is unlawful and offenders may be prosecuted to the fullest extent of the law.

Report Number :TERF2308001923E2
 Operation Mode :802.11n40
 Test Frequency :5755 MHz
 Test Mode :Bandedge
 EUT Pol :E2 Plane

Test Site :SAC G Chamber
 Test Date :2023-10-18
 Temp./Humi. :19.7°C/63%
 Antenna Pol. :Horizontal
 Engineer :Temo Chen

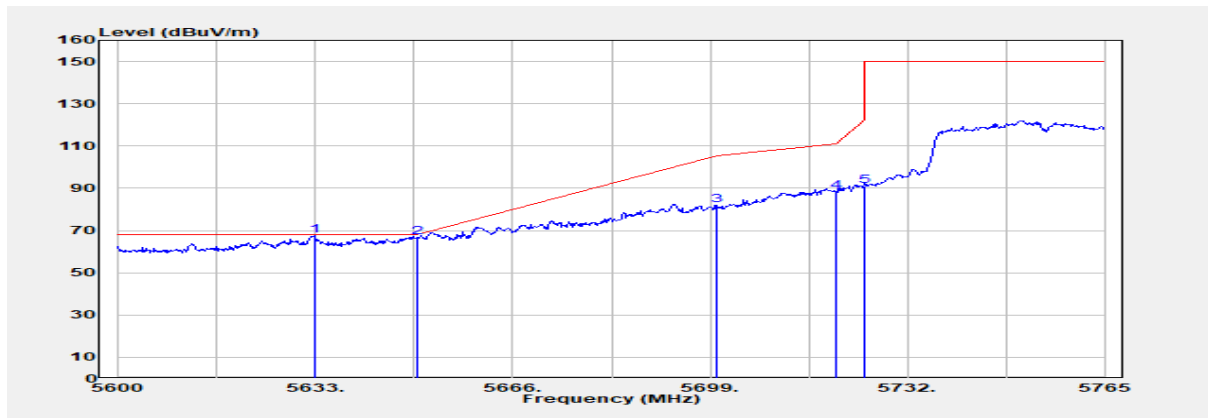

Freq. MHz	Detector Mode PK/QP/AV	Spectrum Reading Level dB μ V	Factor dB	Actual FS dB μ V/m	Limit @3m dB μ V/m	Margin dB
5632.835	Peak	63.01	4.48	67.49	68.20	-0.71
5650.000	Peak	62.19	4.76	66.95	68.20	-1.25
5700.000	Peak	76.36	5.56	81.92	105.20	-23.28
5720.000	Peak	82.96	5.57	88.54	110.80	-22.26
5725.000	Peak	85.41	5.57	90.98	122.20	-31.22

Unless otherwise stated the results shown in this test report refer only to the sample(s) tested and such sample(s) are retained for 90 days only.

除非另有說明，此報告結果僅對測試之樣品負責，同時此樣品僅保留90天。本報告未經本公司書面許可，不可部份複製。

This document is issued by the Company subject to its General Conditions of Service printed overleaf, available on request or accessible at <http://www.sgs.com.tw/Terms-and-Conditions> and for electronic format documents, subject to Terms and Conditions for Electronic Documents at <http://www.sgs.com.tw/Terms-and-Conditions>. Attention is drawn to the limitation of liability, indemnification and jurisdiction issues defined therein. Any holder of this document is advised that information contained hereon reflects the Company's findings at the time of its intervention only and within the limits of Client's instructions, if any. The Company's sole responsibility is to its Client and this document does not exonerate parties to a transaction from exercising all their rights and obligations under the transaction documents. This document cannot be reproduced except in full, without prior written approval of the Company. Any unauthorized alteration, forgery or falsification of the content or appearance of this document is unlawful and offenders may be prosecuted to the fullest extent of the law.

Report Number :TERF2308001923E2
 Operation Mode :802.11n40
 Test Frequency :5795 MHz
 Test Mode :Bandedge
 EUT Pol :E2 Plane

Test Site :SAC G Chamber
 Test Date :2023-10-19
 Temp./Humi. :20.2°C/65%
 Antenna Pol. :Vertical
 Engineer :Temo Chen

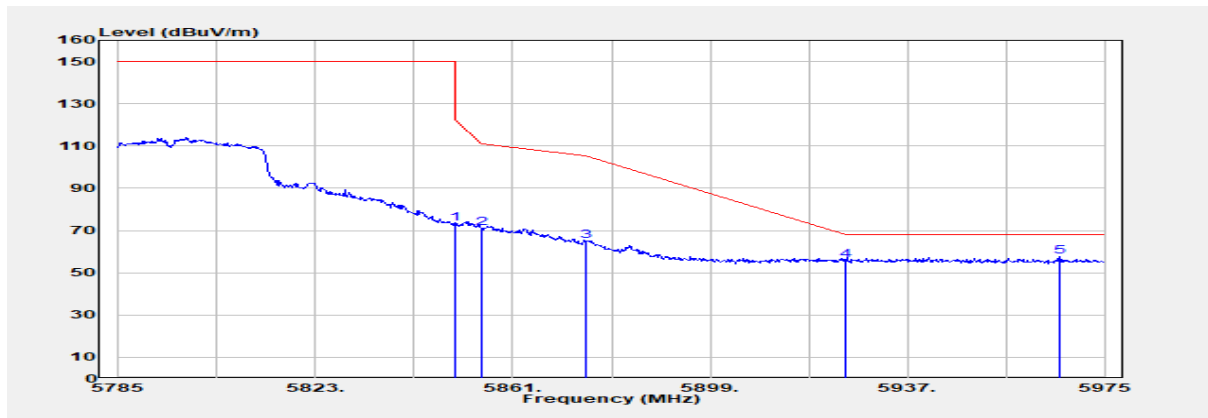

Freq. MHz	Detector Mode PK/QP/AV	Spectrum Reading Level dB μ V	Factor dB	Actual FS dB μ V/m	Limit @3m dB μ V/m	Margin dB
5850.000	Peak	67.70	5.66	73.36	122.20	-48.84
5855.000	Peak	65.39	5.68	71.07	110.80	-39.73
5875.000	Peak	59.36	5.78	65.14	105.20	-40.06
5925.000	Peak	50.28	5.66	55.93	68.20	-12.27
5966.260	Peak	52.23	5.22	57.45	68.20	-10.75

Unless otherwise stated the results shown in this test report refer only to the sample(s) tested and such sample(s) are retained for 90 days only.

除非另有說明，此報告結果僅對測試之樣品負責，同時此樣品僅保留90天。本報告未經本公司書面許可，不可部份複製。

This document is issued by the Company subject to its General Conditions of Service printed overleaf, available on request or accessible at <http://www.sgs.com.tw/Terms-and-Conditions> and for electronic format documents, subject to Terms and Conditions for Electronic Documents at <http://www.sgs.com.tw/Terms-and-Conditions>. Attention is drawn to the limitation of liability, indemnification and jurisdiction issues defined therein. Any holder of this document is advised that information contained hereon reflects the Company's findings at the time of its intervention only and within the limits of Client's instructions, if any. The Company's sole responsibility is to its Client and this document does not exonerate parties to a transaction from exercising all their rights and obligations under the transaction documents. This document cannot be reproduced except in full, without prior written approval of the Company. Any unauthorized alteration, forgery or falsification of the content or appearance of this document is unlawful and offenders may be prosecuted to the fullest extent of the law.

Report Number :TERF2308001923E2
 Operation Mode :802.11n40
 Test Frequency :5795 MHz
 Test Mode :Bandedge
 EUT Pol :E2 Plane

Test Site :SAC G Chamber
 Test Date :2023-10-19
 Temp./Humi. :20.2°C/65%
 Antenna Pol. :Horizontal
 Engineer :Temo Chen

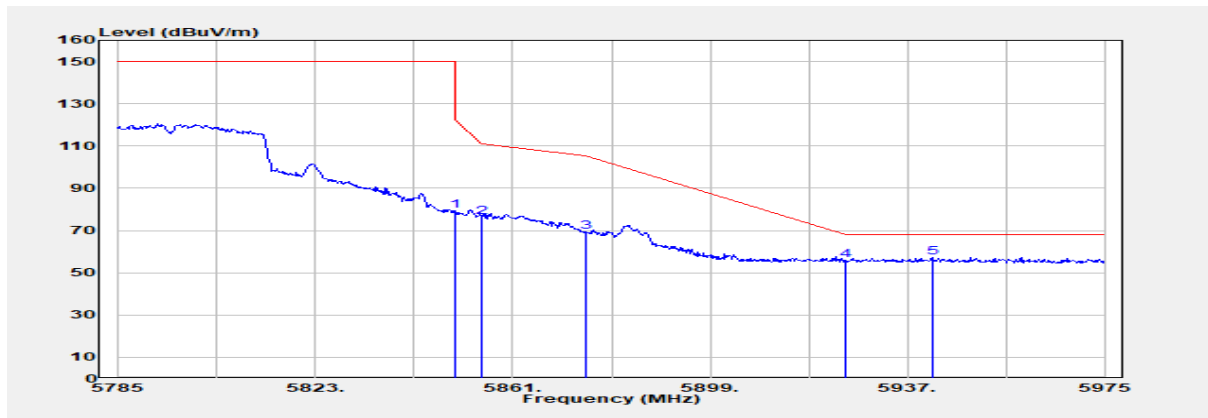

Freq. MHz	Detector Mode PK/QP/AV	Spectrum Reading Level dB μ V	Factor dB	Actual FS dB μ V/m	Limit @3m dB μ V/m	Margin dB
5850.000	Peak	73.49	5.66	79.15	122.20	-43.05
5855.000	Peak	70.80	5.68	76.49	110.80	-34.32
5875.000	Peak	63.49	5.78	69.28	105.20	-35.92
5925.000	Peak	50.41	5.66	56.06	68.20	-12.14
5941.940	Peak	51.93	5.49	57.42	68.20	-10.78

Unless otherwise stated the results shown in this test report refer only to the sample(s) tested and such sample(s) are retained for 90 days only.

除非另有說明，此報告結果僅對測試之樣品負責，同時此樣品僅保留90天。本報告未經本公司書面許可，不可部份複製。

This document is issued by the Company subject to its General Conditions of Service printed overleaf, available on request or accessible at <http://www.sgs.com.tw/Terms-and-Conditions> and for electronic format documents, subject to Terms and Conditions for Electronic Documents at <http://www.sgs.com.tw/Terms-and-Conditions>. Attention is drawn to the limitation of liability, indemnification and jurisdiction issues defined therein. Any holder of this document is advised that information contained hereon reflects the Company's findings at the time of its intervention only and within the limits of Client's instructions, if any. The Company's sole responsibility is to its Client and this document does not exonerate parties to a transaction from exercising all their rights and obligations under the transaction documents. This document cannot be reproduced except in full, without prior written approval of the Company. Any unauthorized alteration, forgery or falsification of the content or appearance of this document is unlawful and offenders may be prosecuted to the fullest extent of the law.

Report Number :TERF2308001923E2
 Operation Mode :802.11ac80
 Test Frequency :5210 MHz
 Test Mode :Bandedge
 EUT Pol :E2 Plane

Test Site :SAC G Chamber
 Test Date :2023-10-18
 Temp./Humi. :19.7°C/63%
 Antenna Pol. :Vertical
 Engineer :Temo Chen

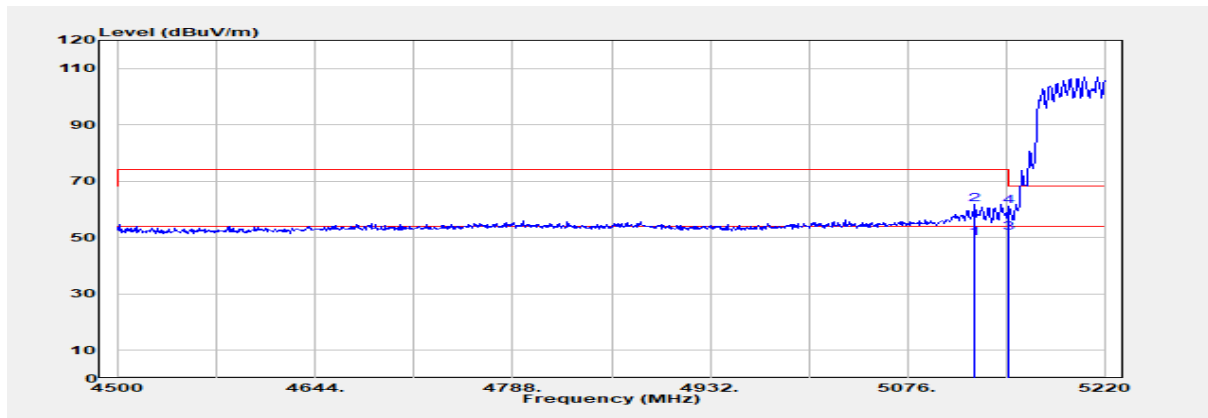

Freq. MHz	Detector Mode PK/QP/AV	Spectrum Reading Level dB μ V	Factor dB	Actual FS dB μ V/m	Limit @3m dB μ V/m	Margin dB
5125.680	Average	45.72	3.97	49.68	54.00	-4.32
5125.680	Peak	57.87	3.97	61.83	74.00	-12.17
5150.000	Average	48.03	3.74	51.77	54.00	-2.23
5150.000	Peak	57.44	3.74	61.19	74.00	-12.81

Unless otherwise stated the results shown in this test report refer only to the sample(s) tested and such sample(s) are retained for 90 days only.

除非另有說明，此報告結果僅對測試之樣品負責，同時此樣品僅保留90天。本報告未經本公司書面許可，不可部份複製。

This document is issued by the Company subject to its General Conditions of Service printed overleaf, available on request or accessible at <http://www.sgs.com.tw/Terms-and-Conditions> and for electronic format documents, subject to Terms and Conditions for Electronic Documents at <http://www.sgs.com.tw/Terms-and-Conditions>. Attention is drawn to the limitation of liability, indemnification and jurisdiction issues defined therein. Any holder of this document is advised that information contained hereon reflects the Company's findings at the time of its intervention only and within the limits of Client's instructions, if any. The Company's sole responsibility is to its Client and this document does not exonerate parties to a transaction from exercising all their rights and obligations under the transaction documents. This document cannot be reproduced except in full, without prior written approval of the Company. Any unauthorized alteration, forgery or falsification of the content or appearance of this document is unlawful and offenders may be prosecuted to the fullest extent of the law.

Report Number :TERF2308001923E2
 Operation Mode :802.11ac80
 Test Frequency :5210 MHz
 Test Mode :Bandedge
 EUT Pol :E2 Plane

Test Site :SAC G Chamber
 Test Date :2023-10-18
 Temp./Humi. :19.7°C/63%
 Antenna Pol. :Horizontal
 Engineer :Temo Chen

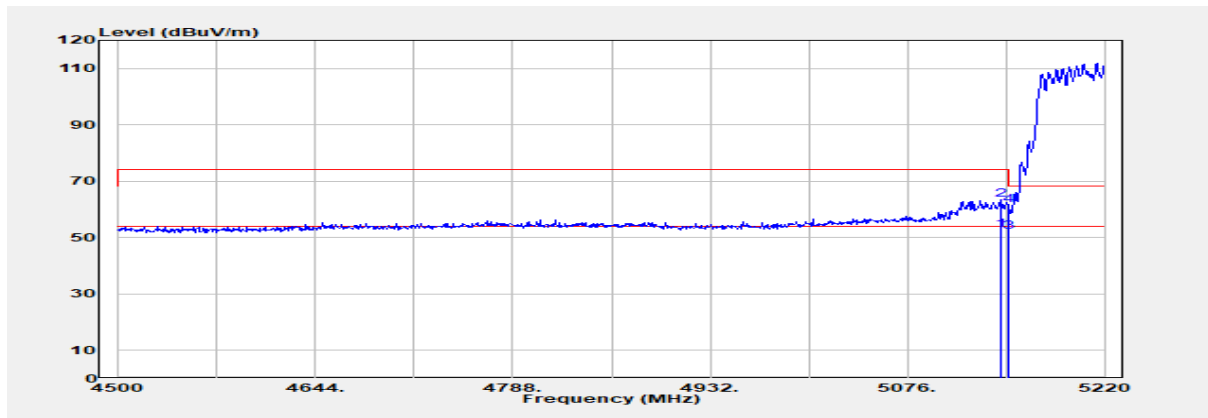

Freq. MHz	Detector Mode PK/QP/AV	Spectrum Reading Level dB μ V	Factor dB	Actual FS dB μ V/m	Limit @3m dB μ V/m	Margin dB
5145.120	Average	49.02	3.79	52.80	54.00	-1.20
5145.120	Peak	59.63	3.79	63.42	74.00	-10.58
5150.000	Average	48.45	3.74	52.19	54.00	-1.81
5150.000	Peak	57.74	3.74	61.49	74.00	-12.51

Unless otherwise stated the results shown in this test report refer only to the sample(s) tested and such sample(s) are retained for 90 days only.

除非另有說明，此報告結果僅對測試之樣品負責，同時此樣品僅保留90天。本報告未經本公司書面許可，不可部份複製。

This document is issued by the Company subject to its General Conditions of Service printed overleaf, available on request or accessible at <http://www.sgs.com.tw/Terms-and-Conditions> and for electronic format documents, subject to Terms and Conditions for Electronic Documents at <http://www.sgs.com.tw/Terms-and-Conditions>. Attention is drawn to the limitation of liability, indemnification and jurisdiction issues defined therein. Any holder of this document is advised that information contained hereon reflects the Company's findings at the time of its intervention only and within the limits of Client's instructions, if any. The Company's sole responsibility is to its Client and this document does not exonerate parties to a transaction from exercising all their rights and obligations under the transaction documents. This document cannot be reproduced except in full, without prior written approval of the Company. Any unauthorized alteration, forgery or falsification of the content or appearance of this document is unlawful and offenders may be prosecuted to the fullest extent of the law.

Report Number :TERF2308001923E2
 Operation Mode :802.11ac80
 Test Frequency :5290 MHz
 Test Mode :Bandedge
 EUT Pol :E2 Plane

Test Site :SAC G Chamber
 Test Date :2023-10-18
 Temp./Humi. :19.7°C/63%
 Antenna Pol. :Vertical
 Engineer :Temo Chen

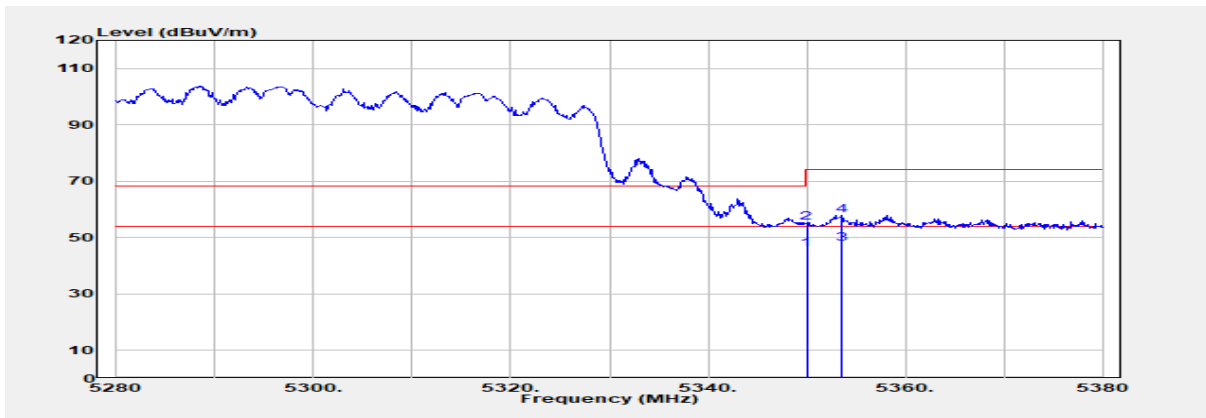

Freq. MHz	Detector Mode PK/QP/AV	Spectrum Reading Level dB μ V	Factor dB	Actual FS dB μ V/m	Limit @3m dB μ V/m	Margin dB
5350.000	Average	42.41	3.37	45.78	54.00	-8.22
5350.000	Peak	51.93	3.37	55.30	74.00	-18.70
5353.600	Average	44.32	3.37	47.69	54.00	-6.31
5353.600	Peak	54.63	3.37	58.00	74.00	-16.00

Unless otherwise stated the results shown in this test report refer only to the sample(s) tested and such sample(s) are retained for 90 days only.

除非另有說明，此報告結果僅對測試之樣品負責，同時此樣品僅保留90天。本報告未經本公司書面許可，不可部份複製。

This document is issued by the Company subject to its General Conditions of Service printed overleaf, available on request or accessible at <http://www.sgs.com.tw/Terms-and-Conditions> and for electronic format documents, subject to Terms and Conditions for Electronic Documents at <http://www.sgs.com.tw/Terms-and-Conditions>. Attention is drawn to the limitation of liability, indemnification and jurisdiction issues defined therein. Any holder of this document is advised that information contained hereon reflects the Company's findings at the time of its intervention only and within the limits of Client's instructions, if any. The Company's sole responsibility is to its Client and this document does not exonerate parties to a transaction from exercising all their rights and obligations under the transaction documents. This document cannot be reproduced except in full, without prior written approval of the Company. Any unauthorized alteration, forgery or falsification of the content or appearance of this document is unlawful and offenders may be prosecuted to the fullest extent of the law.

Report Number :TERF2308001923E2
 Operation Mode :802.11ac80
 Test Frequency :5290 MHz
 Test Mode :Bandedge
 EUT Pol :E2 Plane

Test Site :SAC G Chamber
 Test Date :2023-10-18
 Temp./Humi. :19.7°C/63%
 Antenna Pol. :Horizontal
 Engineer :Temo Chen

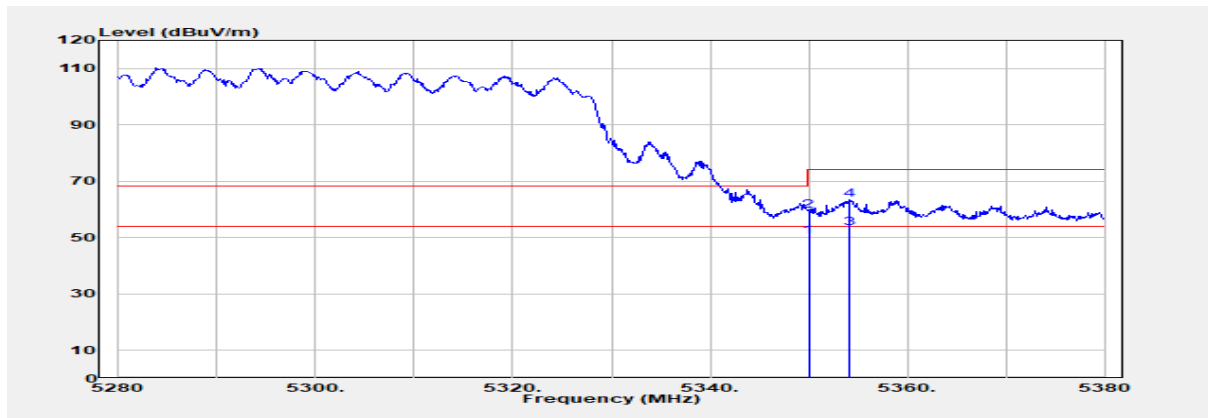

Freq. MHz	Detector Mode PK/QP/AV	Spectrum Reading Level dB μ V	Factor dB	Actual FS dB μ V/m	Limit @3m dB μ V/m	Margin dB
5350.000	Average	47.19	3.37	50.56	54.00	-3.44
5350.000	Peak	56.01	3.37	59.38	74.00	-14.62
5354.100	Average	49.96	3.37	53.33	54.00	-0.67
5354.100	Peak	60.20	3.37	63.58	74.00	-10.42

Unless otherwise stated the results shown in this test report refer only to the sample(s) tested and such sample(s) are retained for 90 days only.

除非另有說明，此報告結果僅對測試之樣品負責，同時此樣品僅保留90天。本報告未經本公司書面許可，不可部份複製。

This document is issued by the Company subject to its General Conditions of Service printed overleaf, available on request or accessible at <http://www.sgs.com.tw/Terms-and-Conditions> and for electronic format documents, subject to Terms and Conditions for Electronic Documents at <http://www.sgs.com.tw/Terms-and-Conditions>. Attention is drawn to the limitation of liability, indemnification and jurisdiction issues defined therein. Any holder of this document is advised that information contained hereon reflects the Company's findings at the time of its intervention only and within the limits of Client's instructions, if any. The Company's sole responsibility is to its Client and this document does not exonerate parties to a transaction from exercising all their rights and obligations under the transaction documents. This document cannot be reproduced except in full, without prior written approval of the Company. Any unauthorized alteration, forgery or falsification of the content or appearance of this document is unlawful and offenders may be prosecuted to the fullest extent of the law.

Report Number :TERF2308001923E2
 Operation Mode :802.11ac80
 Test Frequency :5530 MHz
 Test Mode :Bandedge
 EUT Pol :E2 Plane

Test Site :SAC G Chamber
 Test Date :2023-10-18
 Temp./Humi. :19.7°C/63%
 Antenna Pol. :Vertical
 Engineer :Temo Chen

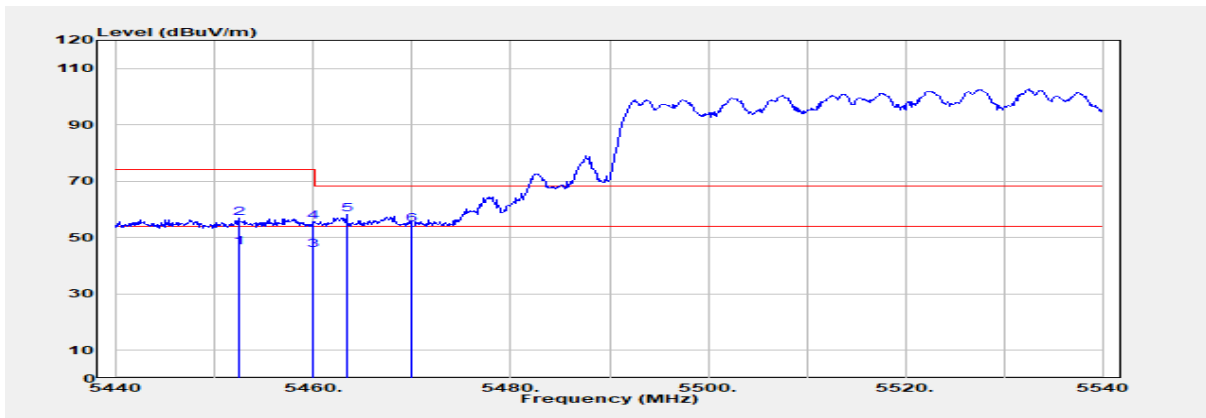

Freq. MHz	Detector Mode PK/QP/AV	Spectrum Reading Level dB μ V	Factor dB	Actual FS dB μ V/m	Limit @3m dB μ V/m	Margin dB
5452.400	Average	43.03	3.62	46.65	54.00	-7.35
5452.400	Peak	53.17	3.62	56.79	74.00	-17.21
5460.000	Average	41.96	3.68	45.64	54.00	-8.36
5460.000	Peak	51.80	3.68	55.48	74.00	-18.52
5463.300	Peak	54.39	3.71	58.10	68.20	-10.10
5470.000	Peak	50.91	3.76	54.67	68.20	-13.53

Unless otherwise stated the results shown in this test report refer only to the sample(s) tested and such sample(s) are retained for 90 days only.

除非另有說明，此報告結果僅對測試之樣品負責，同時此樣品僅保留90天。本報告未經本公司書面許可，不可部份複製。

This document is issued by the Company subject to its General Conditions of Service printed overleaf, available on request or accessible at <http://www.sgs.com.tw/Terms-and-Conditions> and for electronic format documents, subject to Terms and Conditions for Electronic Documents at <http://www.sgs.com.tw/Terms-and-Conditions>. Attention is drawn to the limitation of liability, indemnification and jurisdiction issues defined therein. Any holder of this document is advised that information contained hereon reflects the Company's findings at the time of its intervention only and within the limits of Client's instructions, if any. The Company's sole responsibility is to its Client and this document does not exonerate parties to a transaction from exercising all their rights and obligations under the transaction documents. This document cannot be reproduced except in full, without prior written approval of the Company. Any unauthorized alteration, forgery or falsification of the content or appearance of this document is unlawful and offenders may be prosecuted to the fullest extent of the law.

Report Number :TERF2308001923E2
 Operation Mode :802.11ac80
 Test Frequency :5530 MHz
 Test Mode :Bandedge
 EUT Pol :E2 Plane

Test Site :SAC G Chamber
 Test Date :2023-10-18
 Temp./Humi. :19.7°C/63%
 Antenna Pol. :Horizontal
 Engineer :Temo Chen

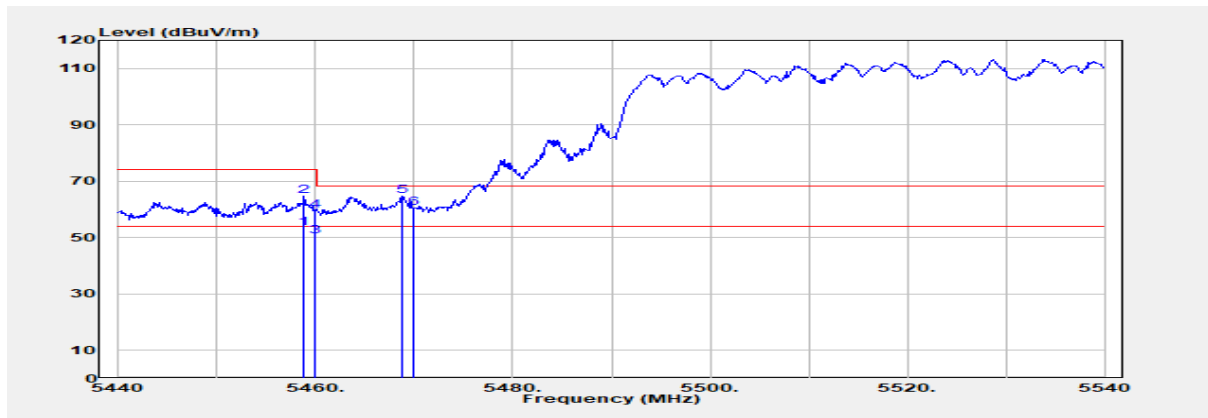

Freq. MHz	Detector Mode PK/QP/AV	Spectrum Reading Level dB μ V	Factor dB	Actual FS dB μ V/m	Limit @3m dB μ V/m	Margin dB
5458.800	Average	49.66	3.67	53.33	54.00	-0.67
5458.800	Peak	60.90	3.67	64.56	74.00	-9.44
5460.000	Average	46.66	3.68	50.34	54.00	-3.66
5460.000	Peak	55.89	3.68	59.57	74.00	-14.43
5468.800	Peak	60.89	3.75	64.65	68.20	-3.55
5470.000	Peak	56.77	3.76	60.53	68.20	-7.67

Unless otherwise stated the results shown in this test report refer only to the sample(s) tested and such sample(s) are retained for 90 days only.

除非另有說明，此報告結果僅對測試之樣品負責，同時此樣品僅保留90天。本報告未經本公司書面許可，不可部份複製。

This document is issued by the Company subject to its General Conditions of Service printed overleaf, available on request or accessible at <http://www.sgs.com.tw/Terms-and-Conditions> and for electronic format documents, subject to Terms and Conditions for Electronic Documents at <http://www.sgs.com.tw/Terms-and-Conditions>. Attention is drawn to the limitation of liability, indemnification and jurisdiction issues defined therein. Any holder of this document is advised that information contained hereon reflects the Company's findings at the time of its intervention only and within the limits of Client's instructions, if any. The Company's sole responsibility is to its Client and this document does not exonerate parties to a transaction from exercising all their rights and obligations under the transaction documents. This document cannot be reproduced except in full, without prior written approval of the Company. Any unauthorized alteration, forgery or falsification of the content or appearance of this document is unlawful and offenders may be prosecuted to the fullest extent of the law.

Report Number :TERF2308001923E2
 Operation Mode :802.11ac80
 Test Frequency :5610 MHz
 Test Mode :Bandedge
 EUT Pol :E2 Plane

Test Site :SAC G Chamber
 Test Date :2023-10-19
 Temp./Humi. :20.2°C/65%
 Antenna Pol. :Vertical
 Engineer :Temo Chen

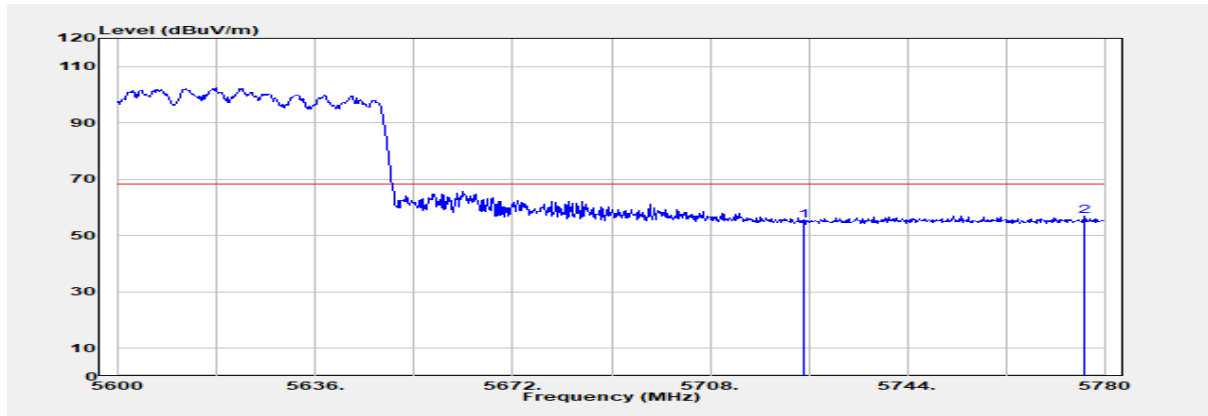

Freq. MHz	Detector Mode PK/QP/AV	Spectrum Reading Level dB μ V	Factor dB	Actual FS dB μ V/m	Limit @3m dB μ V/m	Margin dB
5725.000	Peak	49.86	5.57	55.43	68.20	-12.77
5776.400	Peak	51.37	5.61	56.98	68.20	-11.22

Unless otherwise stated the results shown in this test report refer only to the sample(s) tested and such sample(s) are retained for 90 days only.

除非另有說明，此報告結果僅對測試之樣品負責，同時此樣品僅保留90天。本報告未經本公司書面許可，不可部份複製。

This document is issued by the Company subject to its General Conditions of Service printed overleaf, available on request or accessible at <http://www.sgs.com.tw/Terms-and-Conditions>, and for electronic format documents, subject to Terms and Conditions for Electronic Documents at <http://www.sgs.com.tw/Terms-and-Conditions>. Attention is drawn to the limitation of liability, indemnification and jurisdiction issues defined therein. Any holder of this document is advised that information contained hereon reflects the Company's findings at the time of its intervention only and within the limits of Client's instructions, if any. The Company's sole responsibility is to its Client and this document does not exonerate parties to a transaction from exercising all their rights and obligations under the transaction documents. This document cannot be reproduced except in full, without prior written approval of the Company. Any unauthorized alteration, forgery or falsification of the content or appearance of this document is unlawful and offenders may be prosecuted to the fullest extent of the law.

Report Number	:TERF2308001923E2	Test Site	:SAC G Chamber
Operation Mode	:802.11ac80	Test Date	:2023-10-19
Test Frequency	:5610 MHz	Temp./Humi.	:20.2°C/65%
Test Mode	:Bandedge	Antenna Pol.	:Horizontal
EUT Pol	:E2 Plane	Engineer	:Temo Chen
	:		

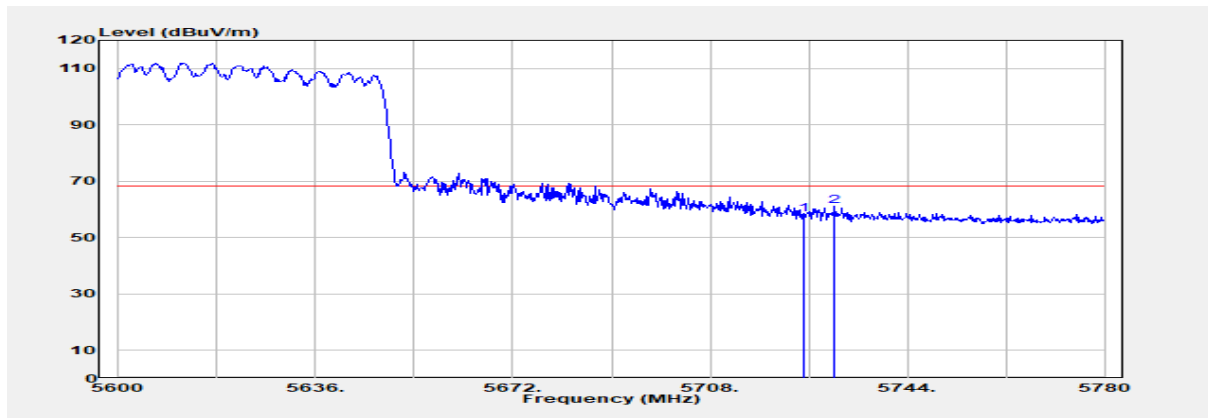

Freq. MHz	Detector Mode PK/QP/AV	Spectrum Reading Level dBμV	Factor dB	Actual FS dBμV/m	Limit @3m dBμV/m	Margin dB
5725.000	Peak	52.68	5.57	58.25	68.20	-9.95
5730.680	Peak	55.59	5.58	61.17	68.20	-7.03

Unless otherwise stated the results shown in this test report refer only to the sample(s) tested and such sample(s) are retained for 90 days only.

除非另有說明，此報告結果僅對測試之樣品負責，同時此樣品僅保留90天。本報告未經本公司書面許可，不可部份複製。

This document is issued by the Company subject to its General Conditions of Service printed overleaf, available on request or accessible at <http://www.sgs.com.tw/Terms-and-Conditions> and for electronic format documents, subject to Terms and Conditions for Electronic Documents at <http://www.sgs.com.tw/Terms-and-Conditions>. Attention is drawn to the limitation of liability, indemnification and jurisdiction issues defined therein. Any holder of this document is advised that information contained hereon reflects the Company's findings at the time of its intervention only and within the limits of Client's instructions, if any. The Company's sole responsibility is to its Client and this document does not exonerate parties to a transaction from exercising all their rights and obligations under the transaction documents. This document cannot be reproduced except in full, without prior written approval of the Company. Any unauthorized alteration, forgery or falsification of the content or appearance of this document is unlawful and offenders may be prosecuted to the fullest extent of the law.

Report Number :TERF2308001923E2
 Operation Mode :802.11ac80
 Test Frequency :5775 MHz
 Test Mode :Bandedge
 EUT Pol :E2 Plane

Test Site :SAC G Chamber
 Test Date :2023-10-18
 Temp./Humi. :19.7°C/63%
 Antenna Pol. :Vertical
 Engineer :Temo Chen

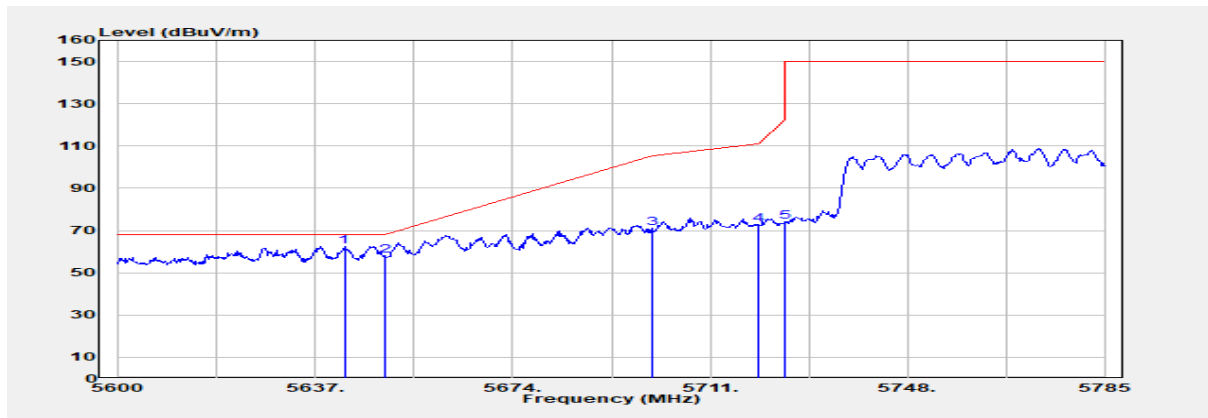

Freq. MHz	Detector Mode PK/QP/AV	Spectrum Reading Level dB μ V	Factor dB	Actual FS dB μ V/m	Limit @3m dB μ V/m	Margin dB
5642.365	Peak	57.98	4.63	62.61	68.20	-5.59
5650.000	Peak	53.31	4.76	58.07	68.20	-10.13
5700.000	Peak	65.40	5.56	70.96	105.20	-34.24
5720.000	Peak	67.43	5.57	73.00	110.80	-37.80
5725.000	Peak	68.46	5.57	74.04	122.20	-48.16

Unless otherwise stated the results shown in this test report refer only to the sample(s) tested and such sample(s) are retained for 90 days only.

除非另有說明，此報告結果僅對測試之樣品負責，同時此樣品僅保留90天。本報告未經本公司書面許可，不可部份複製。

This document is issued by the Company subject to its General Conditions of Service printed overleaf, available on request or accessible at <http://www.sgs.com.tw/Terms-and-Conditions> and for electronic format documents, subject to Terms and Conditions for Electronic Documents at <http://www.sgs.com.tw/Terms-and-Conditions>. Attention is drawn to the limitation of liability, indemnification and jurisdiction issues defined therein. Any holder of this document is advised that information contained hereon reflects the Company's findings at the time of its intervention only and within the limits of Client's instructions, if any. The Company's sole responsibility is to its Client and this document does not exonerate parties to a transaction from exercising all their rights and obligations under the transaction documents. This document cannot be reproduced except in full, without prior written approval of the Company. Any unauthorized alteration, forgery or falsification of the content or appearance of this document is unlawful and offenders may be prosecuted to the fullest extent of the law.

Report Number :TERF2308001923E2
 Operation Mode :802.11ac80
 Test Frequency :5775 MHz
 Test Mode :Bandedge
 EUT Pol :E2 Plane

Test Site :SAC G Chamber
 Test Date :2023-10-18
 Temp./Humi. :19.7°C/63%
 Antenna Pol. :Horizontal
 Engineer :Temo Chen

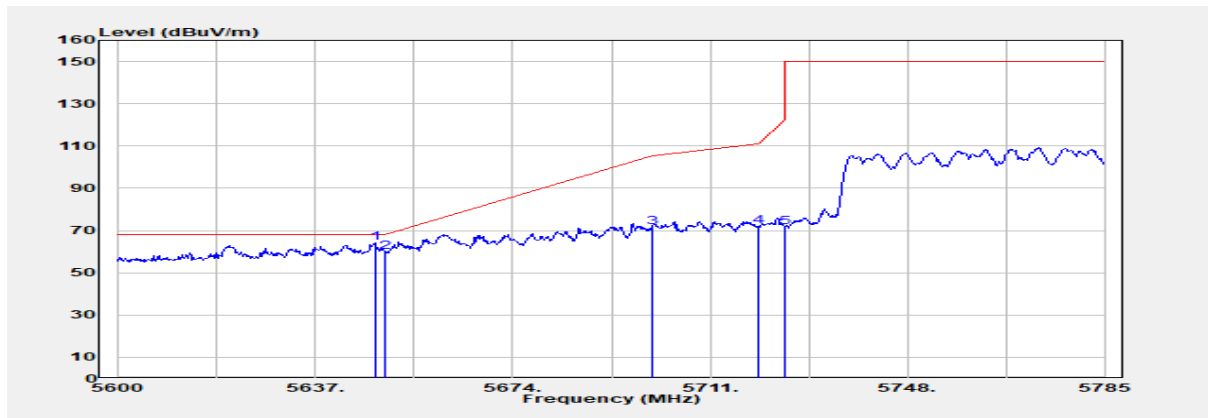

Freq. MHz	Detector Mode PK/QP/AV	Spectrum Reading Level dB μ V	Factor dB	Actual FS dB μ V/m	Limit @3m dB μ V/m	Margin dB
5648.100	Peak	59.46	4.73	64.18	68.20	-4.02
5650.000	Peak	54.91	4.76	59.67	68.20	-8.53
5700.000	Peak	66.17	5.56	71.73	105.20	-33.47
5720.000	Peak	66.36	5.57	71.93	110.80	-38.87
5725.000	Peak	65.82	5.57	71.40	122.20	-50.80

Unless otherwise stated the results shown in this test report refer only to the sample(s) tested and such sample(s) are retained for 90 days only.

除非另有說明，此報告結果僅對測試之樣品負責，同時此樣品僅保留90天。本報告未經本公司書面許可，不可部份複製。

This document is issued by the Company subject to its General Conditions of Service printed overleaf, available on request or accessible at <http://www.sgs.com.tw/Terms-and-Conditions> and for electronic format documents, subject to Terms and Conditions for Electronic Documents at <http://www.sgs.com.tw/Terms-and-Conditions>. Attention is drawn to the limitation of liability, indemnification and jurisdiction issues defined therein. Any holder of this document is advised that information contained hereon reflects the Company's findings at the time of its intervention only and within the limits of Client's instructions, if any. The Company's sole responsibility is to its Client and this document does not exonerate parties to a transaction from exercising all their rights and obligations under the transaction documents. This document cannot be reproduced except in full, without prior written approval of the Company. Any unauthorized alteration, forgery or falsification of the content or appearance of this document is unlawful and offenders may be prosecuted to the fullest extent of the law.

Report Number :TERF2308001923E2
 Operation Mode :802.11ac80
 Test Frequency :5775 MHz
 Test Mode :Bandedge
 EUT Pol :E2 Plane

Test Site :SAC G Chamber
 Test Date :2023-10-18
 Temp./Humi. :19.7°C/63%
 Antenna Pol. :Vertical
 Engineer :Temo Chen

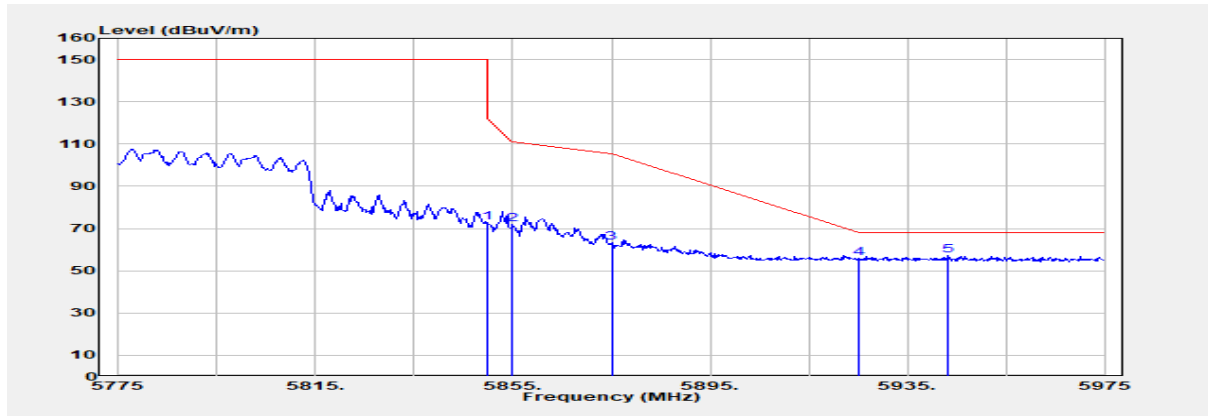

Freq. MHz	Detector Mode PK/QP/AV	Spectrum Reading Level dB μ V	Factor dB	Actual FS dB μ V/m	Limit @3m dB μ V/m	Margin dB
5850.000	Peak	67.35	5.66	73.01	122.20	-49.19
5855.000	Peak	66.27	5.68	71.96	110.80	-38.84
5875.000	Peak	57.35	5.78	63.13	105.20	-42.07
5925.000	Peak	50.32	5.66	55.98	68.20	-12.22
5943.200	Peak	51.94	5.48	57.42	68.20	-10.78

Unless otherwise stated the results shown in this test report refer only to the sample(s) tested and such sample(s) are retained for 90 days only.

除非另有說明，此報告結果僅對測試之樣品負責，同時此樣品僅保留90天。本報告未經本公司書面許可，不可部份複製。

This document is issued by the Company subject to its General Conditions of Service printed overleaf, available on request or accessible at <http://www.sgs.com.tw/Terms-and-Conditions> and for electronic format documents, subject to Terms and Conditions for Electronic Documents at <http://www.sgs.com.tw/Terms-and-Conditions>. Attention is drawn to the limitation of liability, indemnification and jurisdiction issues defined therein. Any holder of this document is advised that information contained hereon reflects the Company's findings at the time of its intervention only and within the limits of Client's instructions, if any. The Company's sole responsibility is to its Client and this document does not exonerate parties to a transaction from exercising all their rights and obligations under the transaction documents. This document cannot be reproduced except in full, without prior written approval of the Company. Any unauthorized alteration, forgery or falsification of the content or appearance of this document is unlawful and offenders may be prosecuted to the fullest extent of the law.

Report Number :TERF2308001923E2
 Operation Mode :802.11ac80
 Test Frequency :5775 MHz
 Test Mode :Bandedge
 EUT Pol :E2 Plane

Test Site :SAC G Chamber
 Test Date :2023-10-18
 Temp./Humi. :19.7°C/63%
 Antenna Pol. :Horizontal
 Engineer :Temo Chen

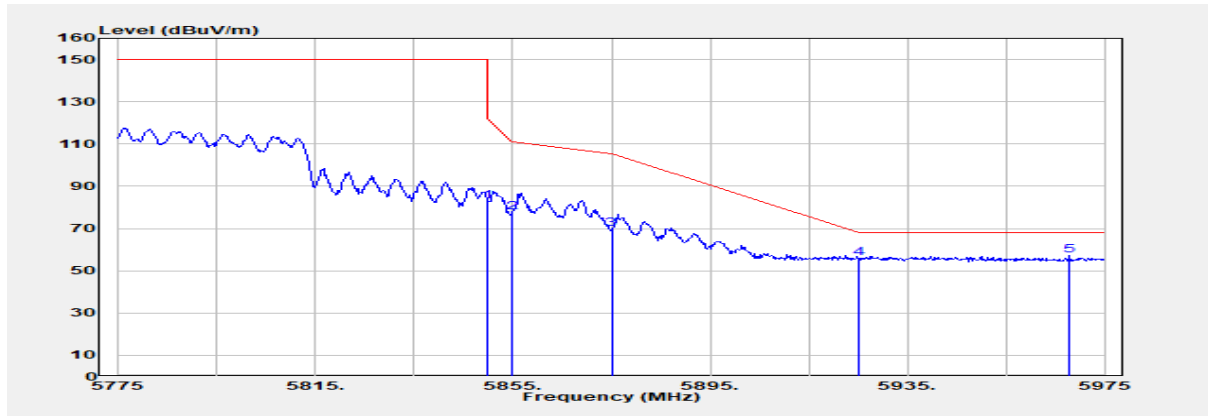

Freq. MHz	Detector Mode PK/QP/AV	Spectrum Reading Level dB μ V	Factor dB	Actual FS dB μ V/m	Limit @3m dB μ V/m	Margin dB
5850.000	Peak	77.34	5.66	83.00	122.20	-39.20
5855.000	Peak	71.99	5.68	77.68	110.80	-33.12
5875.000	Peak	64.09	5.78	69.87	105.20	-35.33
5925.000	Peak	50.07	5.66	55.73	68.20	-12.47
5968.000	Peak	51.93	5.20	57.14	68.20	-11.06

Unless otherwise stated the results shown in this test report refer only to the sample(s) tested and such sample(s) are retained for 90 days only.

除非另有說明，此報告結果僅對測試之樣品負責，同時此樣品僅保留90天。本報告未經本公司書面許可，不可部份複製。

This document is issued by the Company subject to its General Conditions of Service printed overleaf, available on request or accessible at <http://www.sgs.com.tw/Terms-and-Conditions> and for electronic format documents, subject to Terms and Conditions for Electronic Documents at <http://www.sgs.com.tw/Terms-and-Conditions>. Attention is drawn to the limitation of liability, indemnification and jurisdiction issues defined therein. Any holder of this document is advised that information contained hereon reflects the Company's findings at the time of its intervention only and within the limits of Client's instructions, if any. The Company's sole responsibility is to its Client and this document does not exonerate parties to a transaction from exercising all their rights and obligations under the transaction documents. This document cannot be reproduced except in full, without prior written approval of the Company. Any unauthorized alteration, forgery or falsification of the content or appearance of this document is unlawful and offenders may be prosecuted to the fullest extent of the law.

Report Number :TERF2308001923E2
 Operation Mode :802.11ac160
 Test Frequency :5250 MHz
 Test Mode :Bandedge
 EUT Pol :E2 Plane

Test Site :SAC G Chamber
 Test Date :2023-10-18
 Temp./Humi. :19.7°C/63%
 Antenna Pol. :Vertical
 Engineer :Temo Chen

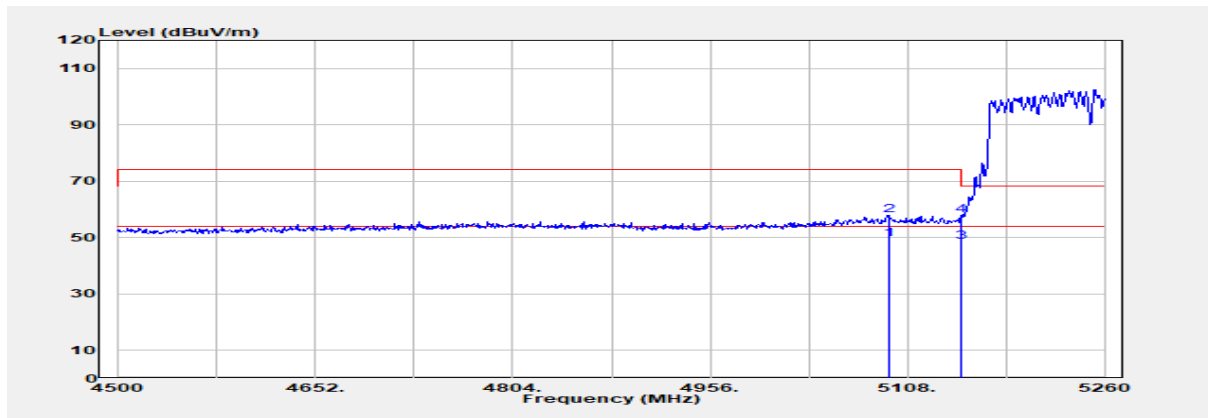

Freq. MHz	Detector Mode PK/QP/AV	Spectrum Reading Level dB μ V	Factor dB	Actual FS dB μ V/m	Limit @3m dB μ V/m	Margin dB
5093.560	Average	45.18	4.19	49.37	54.00	-4.63
5093.560	Peak	53.78	4.19	57.97	74.00	-16.03
5150.000	Average	44.72	3.74	48.47	54.00	-5.53
5150.000	Peak	54.03	3.74	57.77	74.00	-16.23

Unless otherwise stated the results shown in this test report refer only to the sample(s) tested and such sample(s) are retained for 90 days only.

除非另有說明，此報告結果僅對測試之樣品負責，同時此樣品僅保留90天。本報告未經本公司書面許可，不可部份複製。

This document is issued by the Company subject to its General Conditions of Service printed overleaf, available on request or accessible at <http://www.sgs.com.tw/Terms-and-Conditions> and for electronic format documents, subject to Terms and Conditions for Electronic Documents at <http://www.sgs.com.tw/Terms-and-Conditions>. Attention is drawn to the limitation of liability, indemnification and jurisdiction issues defined therein. Any holder of this document is advised that information contained hereon reflects the Company's findings at the time of its intervention only and within the limits of Client's instructions, if any. The Company's sole responsibility is to its Client and this document does not exonerate parties to a transaction from exercising all their rights and obligations under the transaction documents. This document cannot be reproduced except in full, without prior written approval of the Company. Any unauthorized alteration, forgery or falsification of the content or appearance of this document is unlawful and offenders may be prosecuted to the fullest extent of the law.

Report Number :TERF2308001923E2
 Operation Mode :802.11ac160
 Test Frequency :5250 MHz
 Test Mode :Bandedge
 EUT Pol :E2 Plane

Test Site :SAC G Chamber
 Test Date :2023-10-18
 Temp./Humi. :19.7°C/63%
 Antenna Pol. :Horizontal
 Engineer :Temo Chen

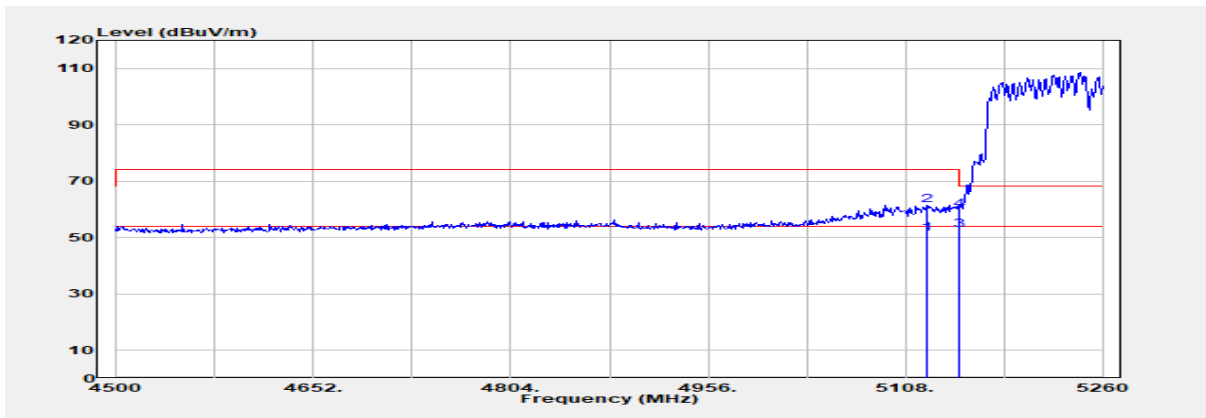

Freq. MHz	Detector Mode	Spectrum Reading Level dB μ V	Factor dB	Actual FS dB μ V/m	Limit @3m dB μ V/m	Margin dB
5124.720	Average	47.34	3.97	51.32	54.00	-2.68
5124.720	Peak	57.65	3.97	61.62	74.00	-12.38
5150.000	Average	48.93	3.74	52.67	54.00	-1.33
5150.000	Peak	55.95	3.74	59.70	74.00	-14.30

Unless otherwise stated the results shown in this test report refer only to the sample(s) tested and such sample(s) are retained for 90 days only.

除非另有說明，此報告結果僅對測試之樣品負責，同時此樣品僅保留90天。本報告未經本公司書面許可，不可部份複製。

This document is issued by the Company subject to its General Conditions of Service printed overleaf, available on request or accessible at <http://www.sgs.com.tw/Terms-and-Conditions> and for electronic format documents, subject to Terms and Conditions for Electronic Documents at <http://www.sgs.com.tw/Terms-and-Conditions>. Attention is drawn to the limitation of liability, indemnification and jurisdiction issues defined therein. Any holder of this document is advised that information contained hereon reflects the Company's findings at the time of its intervention only and within the limits of Client's instructions, if any. The Company's sole responsibility is to its Client and this document does not exonerate parties to a transaction from exercising all their rights and obligations under the transaction documents. This document cannot be reproduced except in full, without prior written approval of the Company. Any unauthorized alteration, forgery or falsification of the content or appearance of this document is unlawful and offenders may be prosecuted to the fullest extent of the law.

Report Number :TERF2308001923E2

Test Site :SAC G Chamber

Operation Mode :802.11ac160

Test Date :2023-10-18

Test Frequency :5250 MHz

Temp./Humi. :19.7°C/63%

Test Mode :Bandedge

Antenna Pol. :Vertical

EUT Pol :E2 Plane

Engineer :Temo Chen

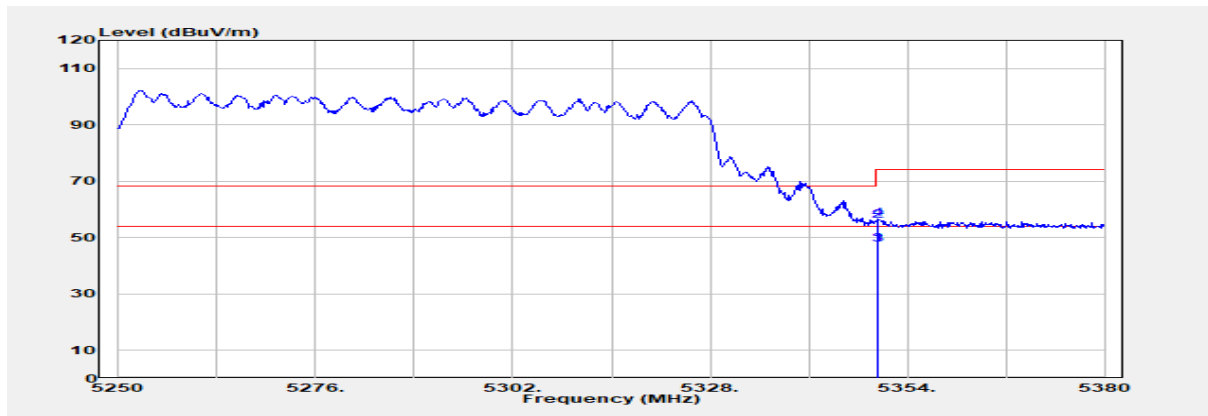

Freq. MHz	Detector Mode PK/QP/AV	Spectrum Reading Level dB μ V	Factor dB	Actual FS dB μ V/m	Limit @3m dB μ V/m	Margin dB
5350.000	Average	44.17	3.37	47.54	54.00	-6.46
5350.000	Peak	52.68	3.37	56.05	74.00	-17.95
5350.230	Average	44.12	3.37	47.49	54.00	-6.51
5350.230	Peak	53.08	3.37	56.45	74.00	-17.55

Unless otherwise stated the results shown in this test report refer only to the sample(s) tested and such sample(s) are retained for 90 days only.

除非另有說明，此報告結果僅對測試之樣品負責，同時此樣品僅保留90天。本報告未經本公司書面許可，不可部份複製。

This document is issued by the Company subject to its General Conditions of Service printed overleaf, available on request or accessible at <http://www.sgs.com.tw/Terms-and-Conditions> and for electronic format documents, subject to Terms and Conditions for Electronic Documents at <http://www.sgs.com.tw/Terms-and-Conditions>. Attention is drawn to the limitation of liability, indemnification and jurisdiction issues defined therein. Any holder of this document is advised that information contained hereon reflects the Company's findings at the time of its intervention only and within the limits of Client's instructions, if any. The Company's sole responsibility is to its Client and this document does not exonerate parties to a transaction from exercising all their rights and obligations under the transaction documents. This document cannot be reproduced except in full, without prior written approval of the Company. Any unauthorized alteration, forgery or falsification of the content or appearance of this document is unlawful and offenders may be prosecuted to the fullest extent of the law.

Report Number :TERF2308001923E2
 Operation Mode :802.11ac160
 Test Frequency :5250 MHz
 Test Mode :Bandedge
 EUT Pol :E2 Plane

Test Site :SAC G Chamber
 Test Date :2023-10-18
 Temp./Humi. :19.7°C/63%
 Antenna Pol. :Horizontal
 Engineer :Temo Chen

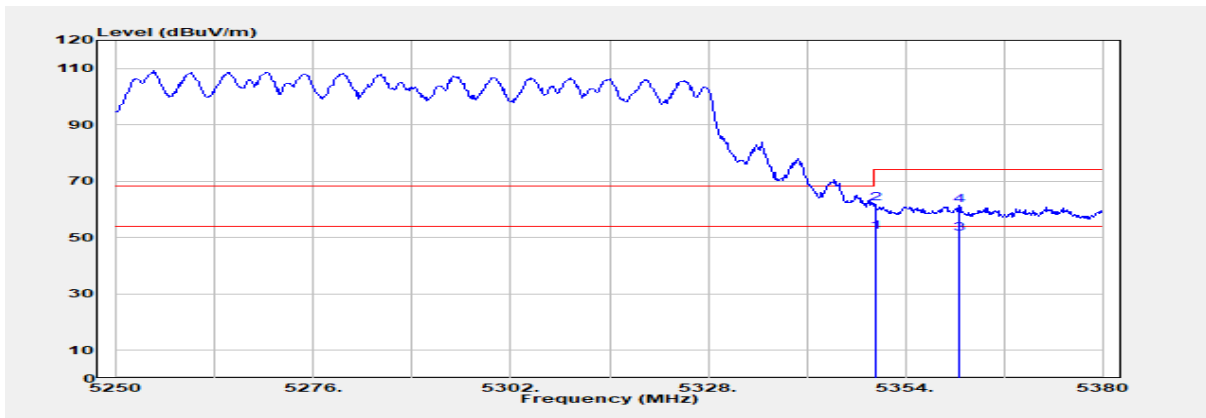

Freq. MHz	Detector Mode PK/QP/AV	Spectrum Reading Level dB μ V	Factor dB	Actual FS dB μ V/m	Limit @3m dB μ V/m	Margin dB
5350.000	Average	48.67	3.37	52.04	54.00	-1.96
5350.000	Peak	58.84	3.37	62.21	74.00	-11.79
5361.020	Average	47.93	3.37	51.30	54.00	-2.70
5361.020	Peak	58.02	3.37	61.39	74.00	-12.61

Unless otherwise stated the results shown in this test report refer only to the sample(s) tested and such sample(s) are retained for 90 days only.

除非另有說明，此報告結果僅對測試之樣品負責，同時此樣品僅保留90天。本報告未經本公司書面許可，不可部份複製。

This document is issued by the Company subject to its General Conditions of Service printed overleaf, available on request or accessible at <http://www.sgs.com.tw/Terms-and-Conditions> and for electronic format documents, subject to Terms and Conditions for Electronic Documents at <http://www.sgs.com.tw/Terms-and-Conditions>. Attention is drawn to the limitation of liability, indemnification and jurisdiction issues defined therein. Any holder of this document is advised that information contained hereon reflects the Company's findings at the time of its intervention only and within the limits of Client's instructions, if any. The Company's sole responsibility is to its Client and this document does not exonerate parties to a transaction from exercising all their rights and obligations under the transaction documents. This document cannot be reproduced except in full, without prior written approval of the Company. Any unauthorized alteration, forgery or falsification of the content or appearance of this document is unlawful and offenders may be prosecuted to the fullest extent of the law.

Report Number :TERF2308001923E2
 Operation Mode :802.11ac160
 Test Frequency :5570 MHz
 Test Mode :Bandedge
 EUT Pol :E2 Plane

Test Site :SAC G Chamber
 Test Date :2023-10-18
 Temp./Humi. :19.7°C/63%
 Antenna Pol. :Vertical
 Engineer :Temo Chen

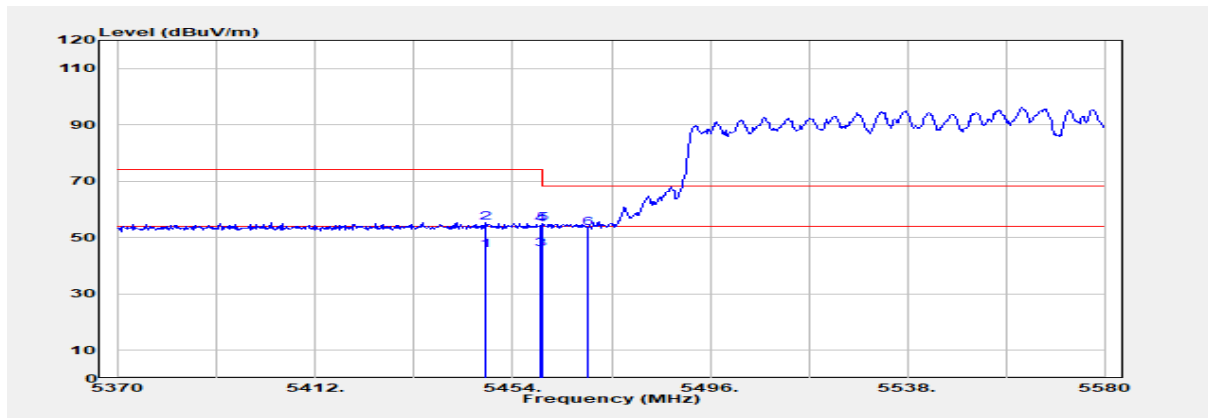

Freq. MHz	Detector Mode PK/QP/AV	Spectrum Reading Level dBμV	Factor dB	Actual FS dBμV/m	Limit @3m dBμV/m	Margin dB
5448.330	Average	41.89	3.59	45.48	54.00	-8.52
5448.330	Peak	51.66	3.59	55.25	74.00	-18.75
5460.000	Average	42.29	3.68	45.97	54.00	-8.03
5460.000	Peak	50.89	3.68	54.57	74.00	-19.43
5460.300	Peak	51.41	3.68	55.09	68.20	-13.11
5470.000	Peak	49.73	3.76	53.49	68.20	-14.71

Unless otherwise stated the results shown in this test report refer only to the sample(s) tested and such sample(s) are retained for 90 days only.

除非另有說明，此報告結果僅對測試之樣品負責，同時此樣品僅保留90天。本報告未經本公司書面許可，不可部份複製。

This document is issued by the Company subject to its General Conditions of Service printed overleaf, available on request or accessible at <http://www.sgs.com.tw/Terms-and-Conditions> and for electronic format documents, subject to Terms and Conditions for Electronic Documents at <http://www.sgs.com.tw/Terms-and-Conditions>. Attention is drawn to the limitation of liability, indemnification and jurisdiction issues defined therein. Any holder of this document is advised that information contained hereon reflects the Company's findings at the time of its intervention only and within the limits of Client's instructions, if any. The Company's sole responsibility is to its Client and this document does not exonerate parties to a transaction from exercising all their rights and obligations under the transaction documents. This document cannot be reproduced except in full, without prior written approval of the Company. Any unauthorized alteration, forgery or falsification of the content or appearance of this document is unlawful and offenders may be prosecuted to the fullest extent of the law.

Report Number :TERF2308001923E2	Test Site :SAC G Chamber
Operation Mode :802.11ac160	Test Date :2023-10-18
Test Frequency :5570 MHz	Temp./Humi. :19.7°C/63%
Test Mode :Bandedge	Antenna Pol. :Horizontal
EUT Pol :E2 Plane	Engineer :Temo Chen

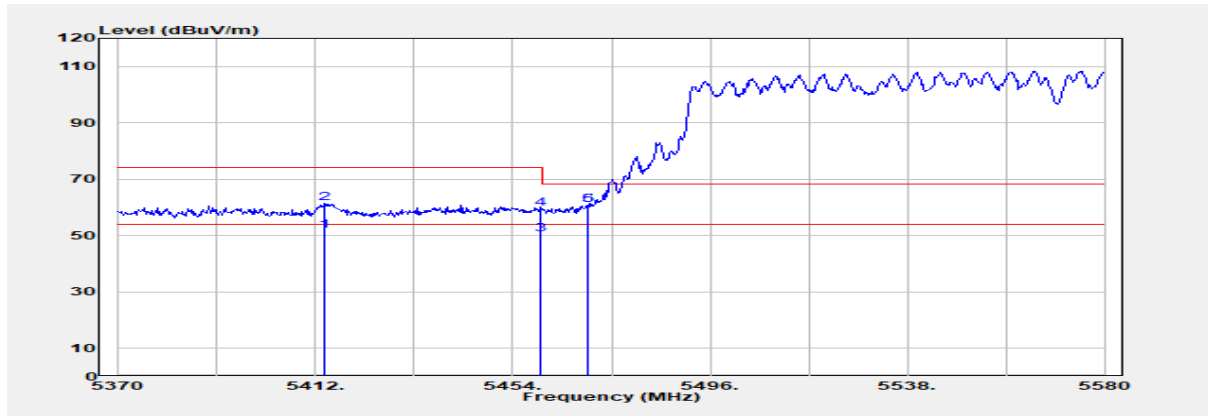

Freq. MHz	Detector Mode PK/QP/AV	Spectrum Reading Level dB μ V	Factor dB	Actual FS dB μ V/m	Limit @3m dB μ V/m	Margin dB
5413.890	Average	48.18	3.44	51.62	54.00	-2.38
5413.890	Peak	57.87	3.44	61.31	74.00	-12.69
5460.000	Average	46.77	3.68	50.45	54.00	-3.55
5460.000	Peak	55.81	3.68	59.49	74.00	-14.51
5469.960	Peak	56.96	3.76	60.72	68.20	-7.48
5470.000	Peak	56.96	3.76	60.72	68.20	-7.48

Unless otherwise stated the results shown in this test report refer only to the sample(s) tested and such sample(s) are retained for 90 days only.

除非另有說明，此報告結果僅對測試之樣品負責，同時此樣品僅保留90天。本報告未經本公司書面許可，不可部份複製。

This document is issued by the Company subject to its General Conditions of Service printed overleaf, available on request or accessible at <http://www.sgs.com.tw/Terms-and-Conditions> and for electronic format documents, subject to Terms and Conditions for Electronic Documents at <http://www.sgs.com.tw/Terms-and-Conditions>. Attention is drawn to the limitation of liability, indemnification and jurisdiction issues defined therein. Any holder of this document is advised that information contained hereon reflects the Company's findings at the time of its intervention only and within the limits of Client's instructions, if any. The Company's sole responsibility is to its Client and this document does not exonerate parties to a transaction from exercising all their rights and obligations under the transaction documents. This document cannot be reproduced except in full, without prior written approval of the Company. Any unauthorized alteration, forgery or falsification of the content or appearance of this document is unlawful and offenders may be prosecuted to the fullest extent of the law.

Report Number :TERF2308001923E2
 Operation Mode :802.11ac160
 Test Frequency :5570 MHz
 Test Mode :Bandedge
 EUT Pol :E2 Plane

Test Site :SAC G Chamber
 Test Date :2023-10-18
 Temp./Humi. :19.7°C/63%
 Antenna Pol. :Vertical
 Engineer :Temo Chen

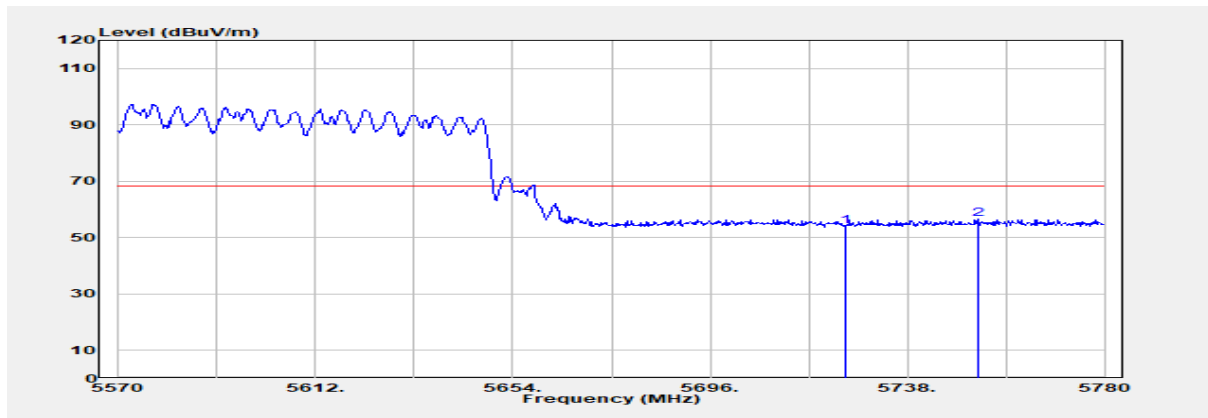

Freq. MHz	Detector Mode PK/QP/AV	Spectrum Reading Level dB μ V	Factor dB	Actual FS dB μ V/m	Limit @3m dB μ V/m	Margin dB
5725.000	Peak	48.48	5.57	54.05	68.20	-14.15
5753.120	Peak	50.90	5.59	56.50	68.20	-11.70

Unless otherwise stated the results shown in this test report refer only to the sample(s) tested and such sample(s) are retained for 90 days only.

除非另有說明，此報告結果僅對測試之樣品負責，同時此樣品僅保留90天。本報告未經本公司書面許可，不可部份複製。

This document is issued by the Company subject to its General Conditions of Service printed overleaf, available on request or accessible at <http://www.sgs.com.tw/Terms-and-Conditions> and for electronic format documents, subject to Terms and Conditions for Electronic Documents at <http://www.sgs.com.tw/Terms-and-Conditions>. Attention is drawn to the limitation of liability, indemnification and jurisdiction issues defined therein. Any holder of this document is advised that information contained hereon reflects the Company's findings at the time of its intervention only and within the limits of Client's instructions, if any. The Company's sole responsibility is to its Client and this document does not exonerate parties to a transaction from exercising all their rights and obligations under the transaction documents. This document cannot be reproduced except in full, without prior written approval of the Company. Any unauthorized alteration, forgery or falsification of the content or appearance of this document is unlawful and offenders may be prosecuted to the fullest extent of the law.

Report Number :TERF2308001923E2	Test Site :SAC G Chamber
Operation Mode :802.11ac160	Test Date :2023-10-18
Test Frequency :5570 MHz	Temp./Humi. :19.7°C/63%
Test Mode :Bandedge	Antenna Pol. :Horizontal
EUT Pol :E2 Plane	Engineer :Temo Chen

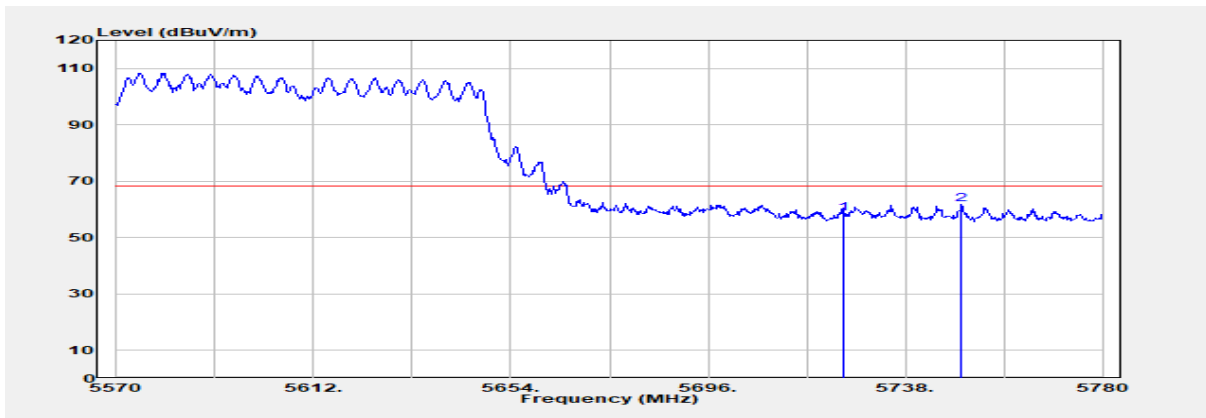

Freq. MHz	Detector Mode PK/QP/AV	Spectrum Reading Level dB μ V	Factor dB	Actual FS dB μ V/m	Limit @3m dB μ V/m	Margin dB
5725.000	Peak	53.11	5.57	58.68	68.20	-9.52
5749.970	Peak	56.15	5.59	61.74	68.20	-6.46

Unless otherwise stated the results shown in this test report refer only to the sample(s) tested and such sample(s) are retained for 90 days only.

除非另有說明，此報告結果僅對測試之樣品負責，同時此樣品僅保留90天。本報告未經本公司書面許可，不可部份複製。

This document is issued by the Company subject to its General Conditions of Service printed overleaf, available on request or accessible at <http://www.sgs.com.tw/Terms-and-Conditions> and for electronic format documents, subject to Terms and Conditions for Electronic Documents at <http://www.sgs.com.tw/Terms-and-Conditions>. Attention is drawn to the limitation of liability, indemnification and jurisdiction issues defined therein. Any holder of this document is advised that information contained hereon reflects the Company's findings at the time of its intervention only and within the limits of Client's instructions, if any. The Company's sole responsibility is to its Client and this document does not exonerate parties to a transaction from exercising all their rights and obligations under the transaction documents. This document cannot be reproduced except in full, without prior written approval of the Company. Any unauthorized alteration, forgery or falsification of the content or appearance of this document is unlawful and offenders may be prosecuted to the fullest extent of the law.

Report Number :TERF2308001923E2
 Operation Mode :802.11be20
 Test Frequency :5180 MHz
 Test Mode :Bandedge
 EUT Pol :E2 Plane

Test Site :SAC G Chamber
 Test Date :2023-10-18
 Temp./Humi. :19.7°C/63%
 Antenna Pol. :Vertical
 Engineer :Temo Chen

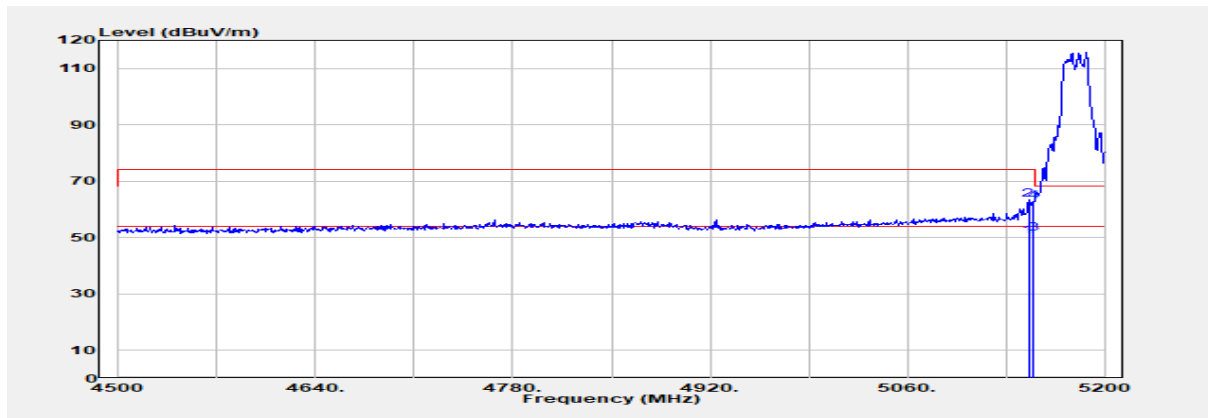

Freq. MHz	Detector Mode	Spectrum Reading Level dB μ V	Factor dB	Actual FS dB μ V/m	Limit @3m dB μ V/m	Margin dB
5146.100	Average	46.63	3.78	50.41	54.00	-3.59
5146.100	Peak	59.55	3.78	63.33	74.00	-10.67
5150.000	Average	47.62	3.74	51.36	54.00	-2.64
5150.000	Peak	59.18	3.74	62.92	74.00	-11.08

Unless otherwise stated the results shown in this test report refer only to the sample(s) tested and such sample(s) are retained for 90 days only.

除非另有說明，此報告結果僅對測試之樣品負責，同時此樣品僅保留90天。本報告未經本公司書面許可，不可部份複製。

This document is issued by the Company subject to its General Conditions of Service printed overleaf, available on request or accessible at <http://www.sgs.com.tw/Terms-and-Conditions> and for electronic format documents, subject to Terms and Conditions for Electronic Documents at <http://www.sgs.com.tw/Terms-and-Conditions>. Attention is drawn to the limitation of liability, indemnification and jurisdiction issues defined therein. Any holder of this document is advised that information contained hereon reflects the Company's findings at the time of its intervention only and within the limits of Client's instructions, if any. The Company's sole responsibility is to its Client and this document does not exonerate parties to a transaction from exercising all their rights and obligations under the transaction documents. This document cannot be reproduced except in full, without prior written approval of the Company. Any unauthorized alteration, forgery or falsification of the content or appearance of this document is unlawful and offenders may be prosecuted to the fullest extent of the law.

Report Number :TERF2308001923E2
 Operation Mode :802.11be20
 Test Frequency :5180 MHz
 Test Mode :Bandedge
 EUT Pol :E2 Plane

Test Site :SAC G Chamber
 Test Date :2023-10-18
 Temp./Humi. :19.7°C/63%
 Antenna Pol. :Horizontal
 Engineer :Temo Chen

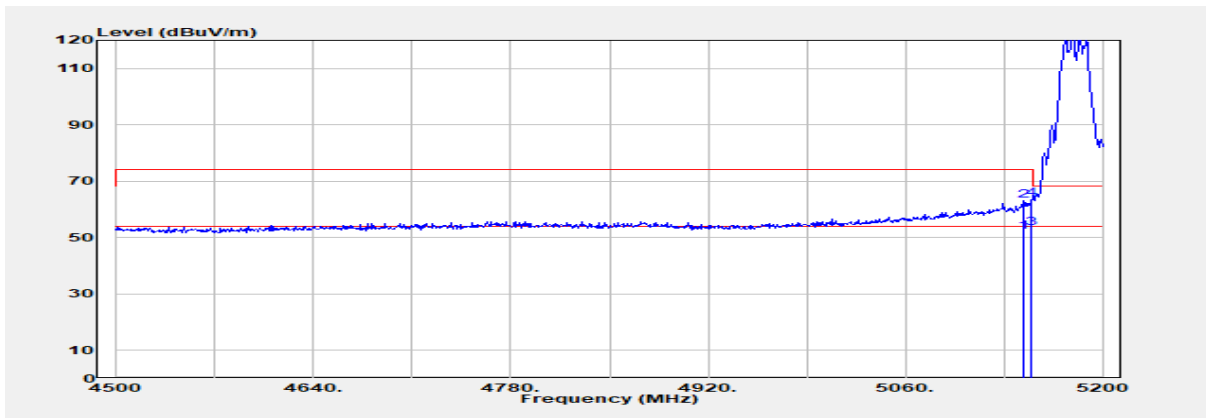

Freq. MHz	Detector Mode PK/QP/AV	Spectrum Reading Level dB μ V	Factor dB	Actual FS dB μ V/m	Limit @3m dB μ V/m	Margin dB
5144.000	Average	48.17	3.80	51.97	54.00	-2.03
5144.000	Peak	59.31	3.80	63.11	74.00	-10.89
5150.000	Average	49.64	3.74	53.39	54.00	-0.61
5150.000	Peak	59.86	3.74	63.60	74.00	-10.40

Unless otherwise stated the results shown in this test report refer only to the sample(s) tested and such sample(s) are retained for 90 days only.

除非另有說明，此報告結果僅對測試之樣品負責，同時此樣品僅保留90天。本報告未經本公司書面許可，不可部份複製。

This document is issued by the Company subject to its General Conditions of Service printed overleaf, available on request or accessible at <http://www.sgs.com.tw/Terms-and-Conditions> and for electronic format documents, subject to Terms and Conditions for Electronic Documents at <http://www.sgs.com.tw/Terms-and-Conditions>. Attention is drawn to the limitation of liability, indemnification and jurisdiction issues defined therein. Any holder of this document is advised that information contained hereon reflects the Company's findings at the time of its intervention only and within the limits of Client's instructions, if any. The Company's sole responsibility is to its Client and this document does not exonerate parties to a transaction from exercising all their rights and obligations under the transaction documents. This document cannot be reproduced except in full, without prior written approval of the Company. Any unauthorized alteration, forgery or falsification of the content or appearance of this document is unlawful and offenders may be prosecuted to the fullest extent of the law.

Report Number :TERF2308001923E2
 Operation Mode :802.11be20
 Test Frequency :5320 MHz
 Test Mode :Bandedge
 EUT Pol :E2 Plane

Test Site :SAC G Chamber
 Test Date :2023-10-19
 Temp./Humi. :20.2°C/65%
 Antenna Pol. :Vertical
 Engineer :Temo Chen

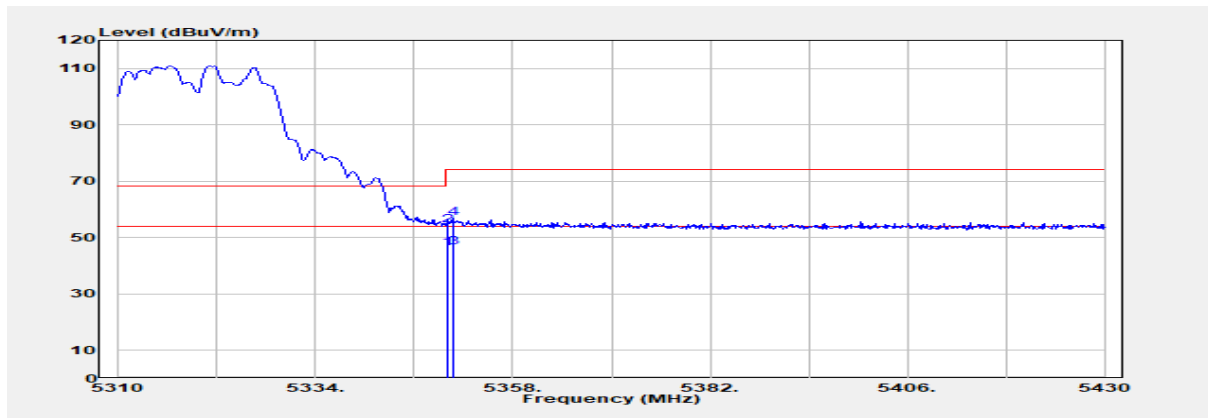

Freq. MHz	Detector Mode PK/QP/AV	Spectrum Reading Level dB μ V	Factor dB	Actual FS dB μ V/m	Limit @3m dB μ V/m	Margin dB
5350.000	Average	42.83	3.37	46.20	54.00	-7.80
5350.000	Peak	50.92	3.37	54.29	74.00	-19.71
5350.680	Average	42.98	3.37	46.35	54.00	-7.65
5350.680	Peak	53.60	3.37	56.97	74.00	-17.03

Unless otherwise stated the results shown in this test report refer only to the sample(s) tested and such sample(s) are retained for 90 days only.

除非另有說明，此報告結果僅對測試之樣品負責，同時此樣品僅保留90天。本報告未經本公司書面許可，不可部份複製。

This document is issued by the Company subject to its General Conditions of Service printed overleaf, available on request or accessible at <http://www.sgs.com.tw/Terms-and-Conditions> and for electronic format documents, subject to Terms and Conditions for Electronic Documents at <http://www.sgs.com.tw/Terms-and-Conditions>. Attention is drawn to the limitation of liability, indemnification and jurisdiction issues defined therein. Any holder of this document is advised that information contained hereon reflects the Company's findings at the time of its intervention only and within the limits of Client's instructions, if any. The Company's sole responsibility is to its Client and this document does not exonerate parties to a transaction from exercising all their rights and obligations under the transaction documents. This document cannot be reproduced except in full, without prior written approval of the Company. Any unauthorized alteration, forgery or falsification of the content or appearance of this document is unlawful and offenders may be prosecuted to the fullest extent of the law.

Report Number :TERF2308001923E2
 Operation Mode :802.11be20
 Test Frequency :5320 MHz
 Test Mode :Bandedge
 EUT Pol :E2 Plane

Test Site :SAC G Chamber
 Test Date :2023-10-19
 Temp./Humi. :20.2°C/65%
 Antenna Pol. :Horizontal
 Engineer :Temo Chen

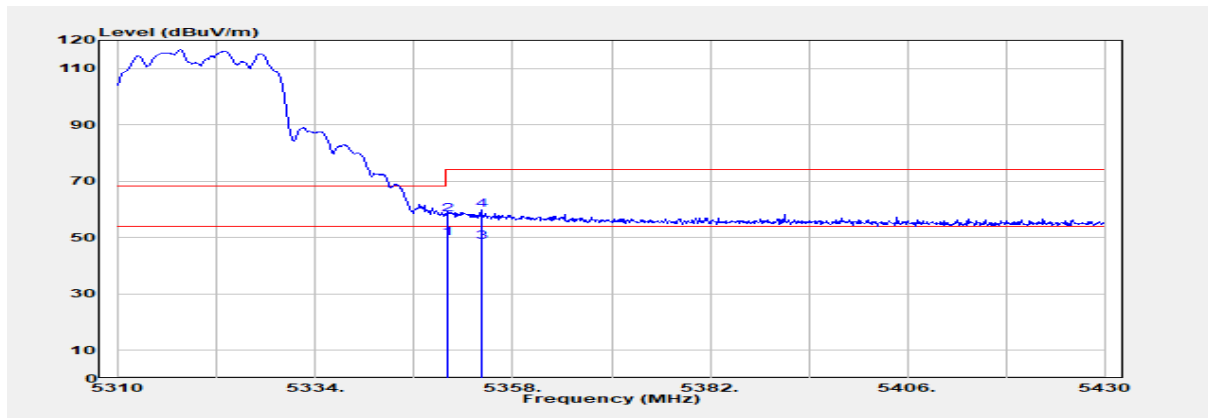

Freq. MHz	Detector Mode PK/QP/AV	Spectrum Reading Level dB μ V	Factor dB	Actual FS dB μ V/m	Limit @3m dB μ V/m	Margin dB
5350.000	Average	46.25	3.37	49.62	54.00	-4.38
5350.000	Peak	54.98	3.37	58.35	74.00	-15.65
5354.160	Average	45.09	3.37	48.46	54.00	-5.54
5354.160	Peak	56.49	3.37	59.86	74.00	-14.14

Unless otherwise stated the results shown in this test report refer only to the sample(s) tested and such sample(s) are retained for 90 days only.

除非另有說明，此報告結果僅對測試之樣品負責，同時此樣品僅保留90天。本報告未經本公司書面許可，不可部份複製。

This document is issued by the Company subject to its General Conditions of Service printed overleaf, available on request or accessible at <http://www.sgs.com.tw/Terms-and-Conditions> and for electronic format documents, subject to Terms and Conditions for Electronic Documents at <http://www.sgs.com.tw/Terms-and-Conditions>. Attention is drawn to the limitation of liability, indemnification and jurisdiction issues defined therein. Any holder of this document is advised that information contained hereon reflects the Company's findings at the time of its intervention only and within the limits of Client's instructions, if any. The Company's sole responsibility is to its Client and this document does not exonerate parties to a transaction from exercising all their rights and obligations under the transaction documents. This document cannot be reproduced except in full, without prior written approval of the Company. Any unauthorized alteration, forgery or falsification of the content or appearance of this document is unlawful and offenders may be prosecuted to the fullest extent of the law.

Report Number :TERF2308001923E2
 Operation Mode :802.11be20
 Test Frequency :5500 MHz
 Test Mode :Bandedge
 EUT Pol :E2 Plane

Test Site :SAC G Chamber
 Test Date :2023-10-19
 Temp./Humi. :20.2°C/65%
 Antenna Pol. :Vertical
 Engineer :Temo Chen

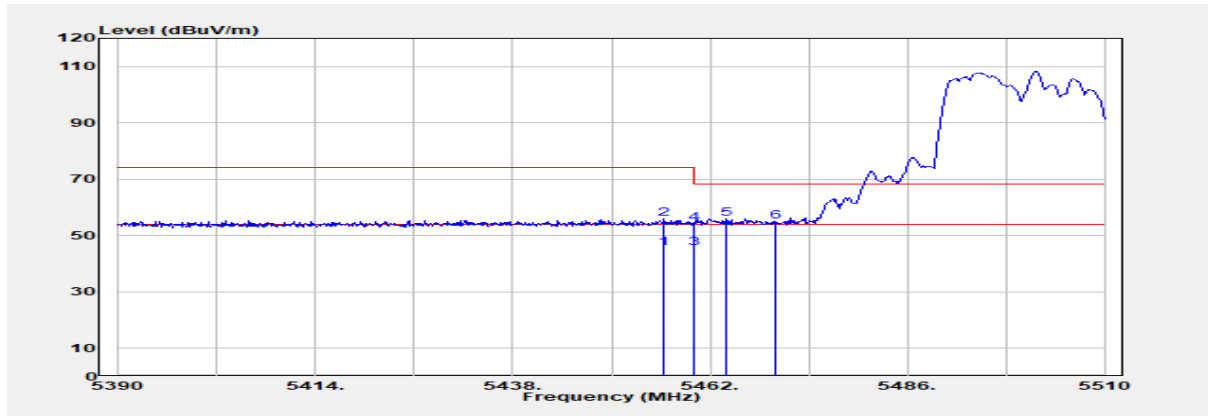

Freq. MHz	Detector Mode PK/QP/AV	Spectrum Reading Level dB μ V	Factor dB	Actual FS dB μ V/m	Limit @3m dB μ V/m	Margin dB
5456.360	Average	42.00	3.65	45.65	54.00	-8.35
5456.360	Peak	52.21	3.65	55.85	74.00	-18.15
5460.000	Average	41.80	3.68	45.48	54.00	-8.52
5460.000	Peak	50.58	3.68	54.26	74.00	-19.74
5464.040	Peak	52.33	3.71	56.04	68.20	-12.16
5470.000	Peak	51.22	3.76	54.99	68.20	-13.21

Unless otherwise stated the results shown in this test report refer only to the sample(s) tested and such sample(s) are retained for 90 days only.

除非另有說明，此報告結果僅對測試之樣品負責，同時此樣品僅保留90天。本報告未經本公司書面許可，不可部份複製。

This document is issued by the Company subject to its General Conditions of Service printed overleaf, available on request or accessible at <http://www.sgs.com.tw/Terms-and-Conditions> and for electronic format documents, subject to Terms and Conditions for Electronic Documents at <http://www.sgs.com.tw/Terms-and-Conditions>. Attention is drawn to the limitation of liability, indemnification and jurisdiction issues defined therein. Any holder of this document is advised that information contained hereon reflects the Company's findings at the time of its intervention only and within the limits of Client's instructions, if any. The Company's sole responsibility is to its Client and this document does not exonerate parties to a transaction from exercising all their rights and obligations under the transaction documents. This document cannot be reproduced except in full, without prior written approval of the Company. Any unauthorized alteration, forgery or falsification of the content or appearance of this document is unlawful and offenders may be prosecuted to the fullest extent of the law.

Report Number :TERF2308001923E2
 Operation Mode :802.11be20
 Test Frequency :5500 MHz
 Test Mode :Bandedge
 EUT Pol :E2 Plane

Test Site :SAC G Chamber
 Test Date :2023-10-19
 Temp./Humi. :20.2°C/65%
 Antenna Pol. :Horizontal
 Engineer :Temo Chen

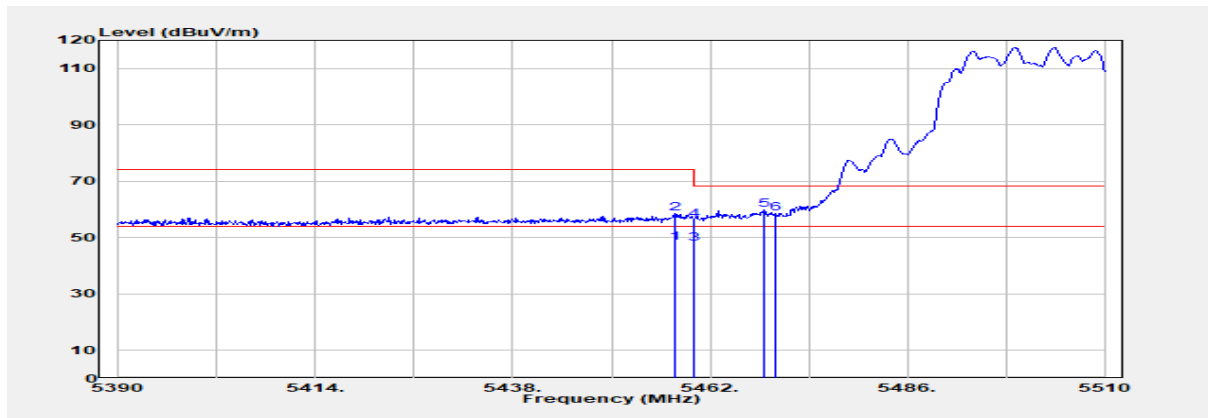

Freq. MHz	Detector Mode PK/QP/AV	Spectrum Reading Level dBμV	Factor dB	Actual FS dBμV/m	Limit @3m dBμV/m	Margin dB
5457.680	Average	44.55	3.66	48.20	54.00	-5.80
5457.680	Peak	54.88	3.66	58.54	74.00	-15.46
5460.000	Average	44.21	3.68	47.89	54.00	-6.11
5460.000	Peak	52.73	3.68	56.41	74.00	-17.59
5468.600	Peak	56.06	3.75	59.81	68.20	-8.39
5470.000	Peak	54.87	3.76	58.63	68.20	-9.57

Unless otherwise stated the results shown in this test report refer only to the sample(s) tested and such sample(s) are retained for 90 days only.

除非另有說明，此報告結果僅對測試之樣品負責，同時此樣品僅保留90天。本報告未經本公司書面許可，不可部份複製。

This document is issued by the Company subject to its General Conditions of Service printed overleaf, available on request or accessible at <http://www.sgs.com.tw/Terms-and-Conditions> and for electronic format documents, subject to Terms and Conditions for Electronic Documents at <http://www.sgs.com.tw/Terms-and-Conditions>. Attention is drawn to the limitation of liability, indemnification and jurisdiction issues defined therein. Any holder of this document is advised that information contained hereon reflects the Company's findings at the time of its intervention only and within the limits of Client's instructions, if any. The Company's sole responsibility is to its Client and this document does not exonerate parties to a transaction from exercising all their rights and obligations under the transaction documents. This document cannot be reproduced except in full, without prior written approval of the Company. Any unauthorized alteration, forgery or falsification of the content or appearance of this document is unlawful and offenders may be prosecuted to the fullest extent of the law.

Report Number :TERF2308001923E2
 Operation Mode :802.11be20
 Test Frequency :5700 MHz
 Test Mode :Bandedge
 EUT Pol :E2 Plane

Test Site :SAC G Chamber
 Test Date :2023-10-19
 Temp./Humi. :20.2°C/65%
 Antenna Pol. :Vertical
 Engineer :Temo Chen

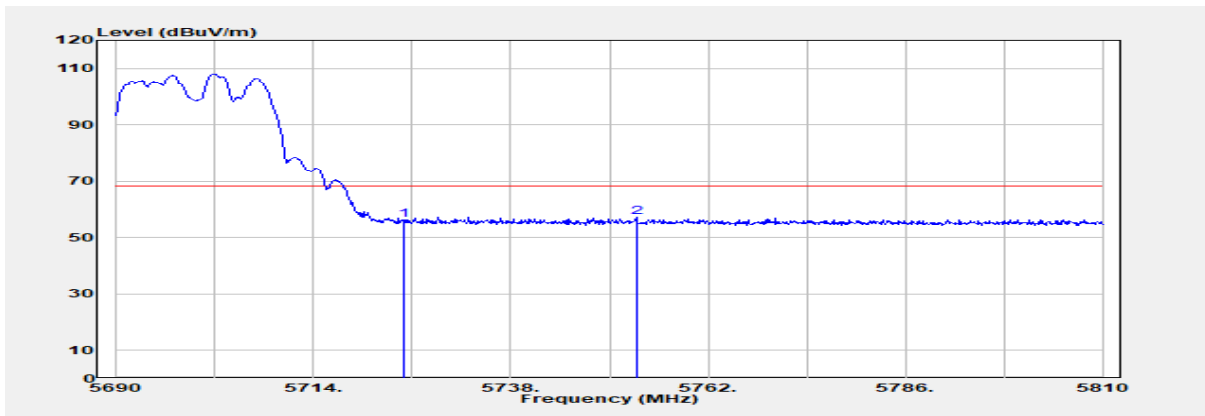

Freq. MHz	Detector Mode PK/QP/AV	Spectrum Reading Level dB μ V	Factor dB	Actual FS dB μ V/m	Limit @3m dB μ V/m	Margin dB
5725.000	Peak	50.66	5.57	56.23	68.20	-11.97
5753.240	Peak	51.63	5.59	57.22	68.20	-10.98

Unless otherwise stated the results shown in this test report refer only to the sample(s) tested and such sample(s) are retained for 90 days only.
 除非另有說明，此報告結果僅對測試之樣品負責，同時此樣品僅保留90天。本報告未經本公司書面許可，不可部份複製。

This document is issued by the Company subject to its General Conditions of Service printed overleaf, available on request or accessible at <http://www.sgs.com.tw/Terms-and-Conditions> and for electronic format documents, subject to Terms and Conditions for Electronic Documents at <http://www.sgs.com.tw/Terms-and-Conditions>. Attention is drawn to the limitation of liability, indemnification and jurisdiction issues defined therein. Any holder of this document is advised that information contained hereon reflects the Company's findings at the time of its intervention only and within the limits of Client's instructions, if any. The Company's sole responsibility is to its Client and this document does not exonerate parties to a transaction from exercising all their rights and obligations under the transaction documents. This document cannot be reproduced except in full, without prior written approval of the Company. Any unauthorized alteration, forgery or falsification of the content or appearance of this document is unlawful and offenders may be prosecuted to the fullest extent of the law.

Report Number :TERF2308001923E2
 Operation Mode :802.11be20
 Test Frequency :5700 MHz
 Test Mode :Bandedge
 EUT Pol :E2 Plane

Test Site :SAC G Chamber
 Test Date :2023-10-19
 Temp./Humi. :20.2°C/65%
 Antenna Pol. :Horizontal
 Engineer :Temo Chen

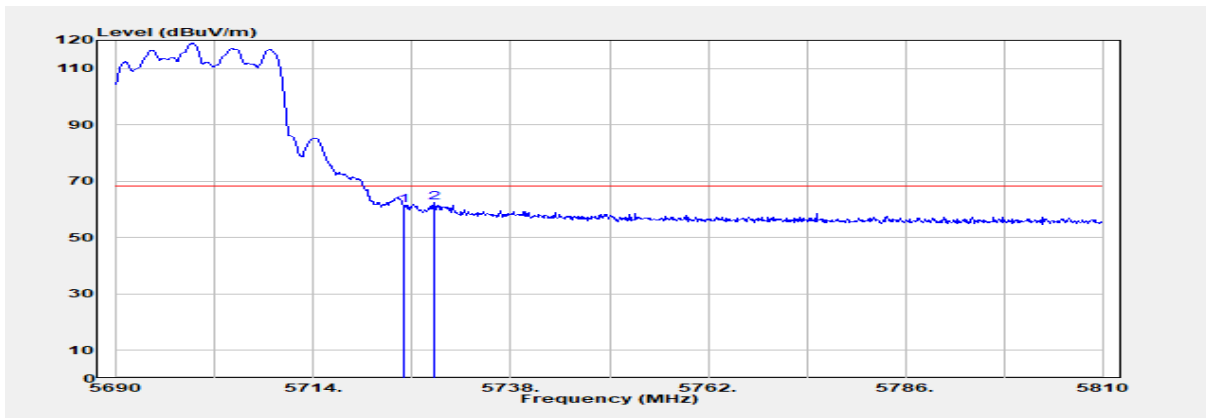

Freq. MHz	Detector Mode PK/QP/AV	Spectrum Reading Level dB μ V	Factor dB	Actual FS dB μ V/m	Limit @3m dB μ V/m	Margin dB
5725.000	Peak	55.79	5.57	61.36	68.20	-6.84
5728.640	Peak	56.85	5.58	62.43	68.20	-5.77

Unless otherwise stated the results shown in this test report refer only to the sample(s) tested and such sample(s) are retained for 90 days only.

除非另有說明，此報告結果僅對測試之樣品負責，同時此樣品僅保留90天。本報告未經本公司書面許可，不可部份複製。

This document is issued by the Company subject to its General Conditions of Service printed overleaf, available on request or accessible at <http://www.sgs.com.tw/Terms-and-Conditions> and for electronic format documents, subject to Terms and Conditions for Electronic Documents at <http://www.sgs.com.tw/Terms-and-Conditions>. Attention is drawn to the limitation of liability, indemnification and jurisdiction issues defined therein. Any holder of this document is advised that information contained hereon reflects the Company's findings at the time of its intervention only and within the limits of Client's instructions, if any. The Company's sole responsibility is to its Client and this document does not exonerate parties to a transaction from exercising all their rights and obligations under the transaction documents. This document cannot be reproduced except in full, without prior written approval of the Company. Any unauthorized alteration, forgery or falsification of the content or appearance of this document is unlawful and offenders may be prosecuted to the fullest extent of the law.

Report Number :TERF2308001923E2
 Operation Mode :802.11be20
 Test Frequency :5745 MHz
 Test Mode :Bandedge
 EUT Pol :E2 Plane

Test Site :SAC G Chamber
 Test Date :2023-10-19
 Temp./Humi. :20.2°C/65%
 Antenna Pol. :Vertical
 Engineer :Temo Chen

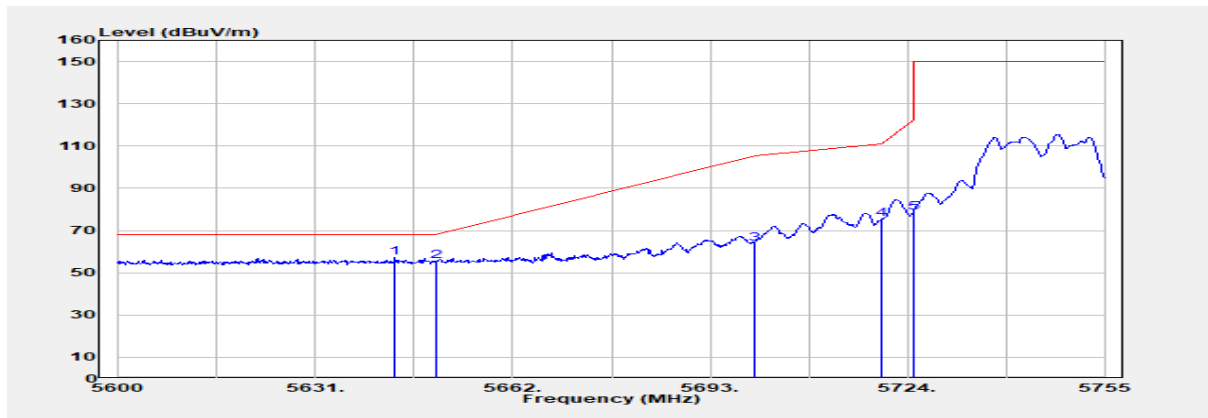

Freq. MHz	Detector Mode PK/QP/AV	Spectrum Reading Level dB μ V	Factor dB	Actual FS dB μ V/m	Limit @3m dB μ V/m	Margin dB
5643.400	Peak	52.65	4.65	57.30	68.20	-10.90
5650.000	Peak	50.90	4.76	55.66	68.20	-12.54
5700.000	Peak	57.97	5.56	63.53	105.20	-41.67
5720.000	Peak	69.73	5.57	75.31	110.80	-35.49
5725.000	Peak	72.82	5.57	78.39	122.20	-43.81

Unless otherwise stated the results shown in this test report refer only to the sample(s) tested and such sample(s) are retained for 90 days only.

除非另有說明，此報告結果僅對測試之樣品負責，同時此樣品僅保留90天。本報告未經本公司書面許可，不可部份複製。

This document is issued by the Company subject to its General Conditions of Service printed overleaf, available on request or accessible at <http://www.sgs.com.tw/Terms-and-Conditions> and for electronic format documents, subject to Terms and Conditions for Electronic Documents at <http://www.sgs.com.tw/Terms-and-Conditions>. Attention is drawn to the limitation of liability, indemnification and jurisdiction issues defined therein. Any holder of this document is advised that information contained hereon reflects the Company's findings at the time of its intervention only and within the limits of Client's instructions, if any. The Company's sole responsibility is to its Client and this document does not exonerate parties to a transaction from exercising all their rights and obligations under the transaction documents. This document cannot be reproduced except in full, without prior written approval of the Company. Any unauthorized alteration, forgery or falsification of the content or appearance of this document is unlawful and offenders may be prosecuted to the fullest extent of the law.

Report Number :TERF2308001923E2
 Operation Mode :802.11be20
 Test Frequency :5745 MHz
 Test Mode :Bandedge
 EUT Pol :E2 Plane

Test Site :SAC G Chamber
 Test Date :2023-10-19
 Temp./Humi. :20.2°C/65%
 Antenna Pol. :Horizontal
 Engineer :Temo Chen

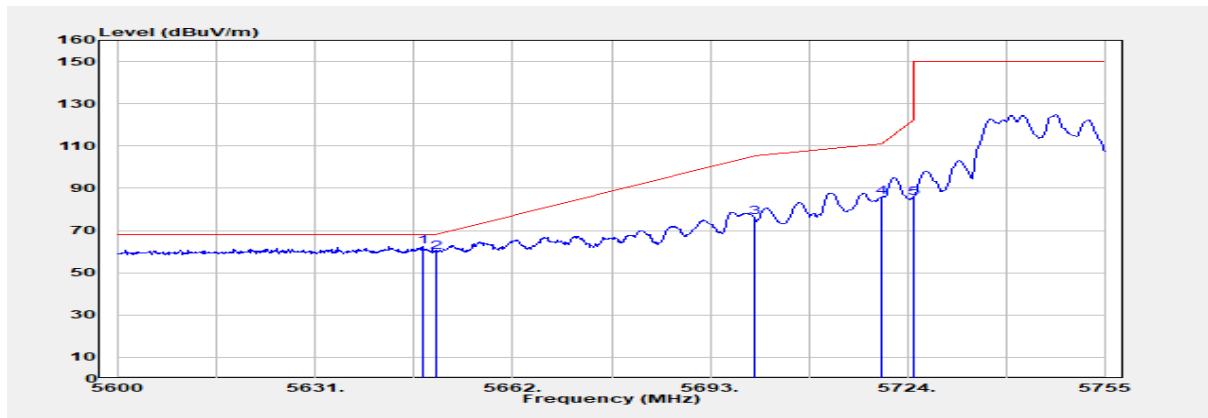

Freq. MHz	Detector Mode PK/QP/AV	Spectrum Reading Level dB μ V	Factor dB	Actual FS dB μ V/m	Limit @3m dB μ V/m	Margin dB
5647.895	Peak	57.83	4.72	62.55	68.20	-5.65
5650.000	Peak	55.04	4.76	59.79	68.20	-8.41
5700.000	Peak	70.87	5.56	76.43	105.20	-28.77
5720.000	Peak	80.46	5.57	86.04	110.80	-24.76
5725.000	Peak	80.01	5.57	85.59	122.20	-36.61

Unless otherwise stated the results shown in this test report refer only to the sample(s) tested and such sample(s) are retained for 90 days only.

除非另有說明，此報告結果僅對測試之樣品負責，同時此樣品僅保留90天。本報告未經本公司書面許可，不可部份複製。

This document is issued by the Company subject to its General Conditions of Service printed overleaf, available on request or accessible at <http://www.sgs.com.tw/Terms-and-Conditions> and for electronic format documents, subject to Terms and Conditions for Electronic Documents at <http://www.sgs.com.tw/Terms-and-Conditions>. Attention is drawn to the limitation of liability, indemnification and jurisdiction issues defined therein. Any holder of this document is advised that information contained hereon reflects the Company's findings at the time of its intervention only and within the limits of Client's instructions, if any. The Company's sole responsibility is to its Client and this document does not exonerate parties to a transaction from exercising all their rights and obligations under the transaction documents. This document cannot be reproduced except in full, without prior written approval of the Company. Any unauthorized alteration, forgery or falsification of the content or appearance of this document is unlawful and offenders may be prosecuted to the fullest extent of the law.

Report Number :TERF2308001923E2
 Operation Mode :802.11be20
 Test Frequency :5825 MHz
 Test Mode :Bandedge
 EUT Pol :E2 Plane

Test Site :SAC G Chamber
 Test Date :2023-10-19
 Temp./Humi. :20.2°C/65%
 Antenna Pol. :Vertical
 Engineer :Temo Chen

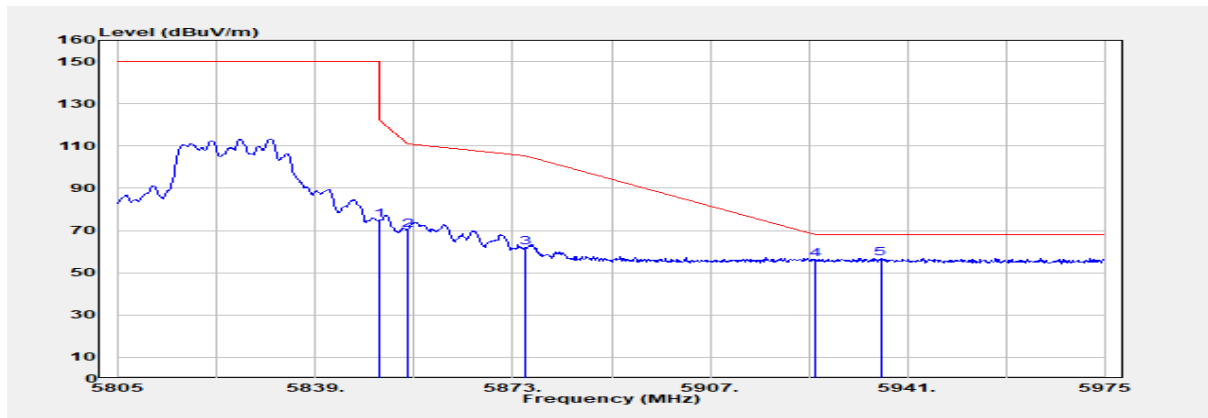

Freq. MHz	Detector Mode PK/QP/AV	Spectrum Reading Level dB μ V	Factor dB	Actual FS dB μ V/m	Limit @3m dB μ V/m	Margin dB
5850.000	Peak	69.38	5.66	75.04	122.20	-47.16
5855.000	Peak	64.46	5.68	70.15	110.80	-40.65
5875.000	Peak	56.05	5.78	61.83	105.20	-43.37
5925.000	Peak	50.66	5.66	56.31	68.20	-11.89
5936.410	Peak	51.45	5.54	56.99	68.20	-11.21

Unless otherwise stated the results shown in this test report refer only to the sample(s) tested and such sample(s) are retained for 90 days only.

除非另有說明，此報告結果僅對測試之樣品負責，同時此樣品僅保留90天。本報告未經本公司書面許可，不可部份複製。

This document is issued by the Company subject to its General Conditions of Service printed overleaf, available on request or accessible at <http://www.sgs.com.tw/Terms-and-Conditions> and for electronic format documents, subject to Terms and Conditions for Electronic Documents at <http://www.sgs.com.tw/Terms-and-Conditions>. Attention is drawn to the limitation of liability, indemnification and jurisdiction issues defined therein. Any holder of this document is advised that information contained hereon reflects the Company's findings at the time of its intervention only and within the limits of Client's instructions, if any. The Company's sole responsibility is to its Client and this document does not exonerate parties to a transaction from exercising all their rights and obligations under the transaction documents. This document cannot be reproduced except in full, without prior written approval of the Company. Any unauthorized alteration, forgery or falsification of the content or appearance of this document is unlawful and offenders may be prosecuted to the fullest extent of the law.

Report Number :TERF2308001923E2
 Operation Mode :802.11be20
 Test Frequency :5825 MHz
 Test Mode :Bandedge
 EUT Pol :E2 Plane

Test Site :SAC G Chamber
 Test Date :2023-10-19
 Temp./Humi. :20.2°C/65%
 Antenna Pol. :Horizontal
 Engineer :Temo Chen

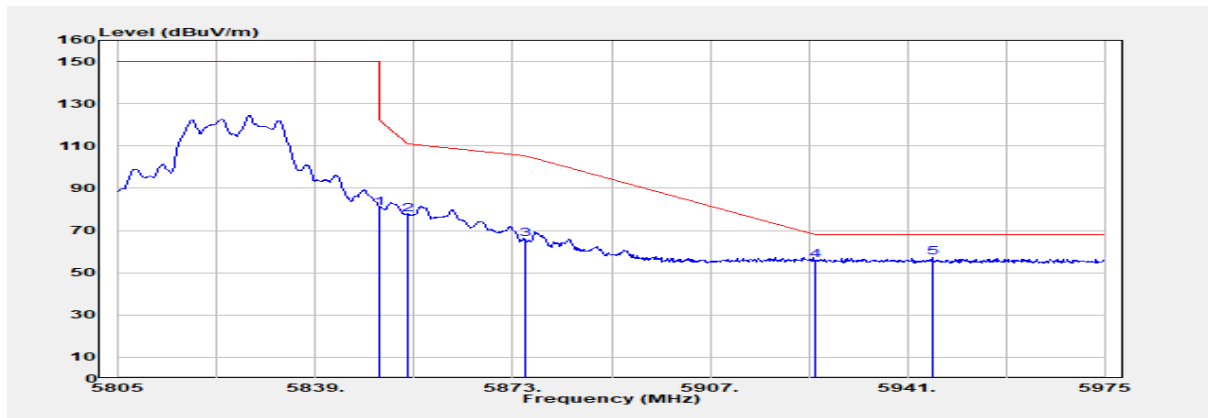

Freq. MHz	Detector Mode PK/QP/AV	Spectrum Reading Level dB μ V	Factor dB	Actual FS dB μ V/m	Limit @3m dB μ V/m	Margin dB
5850.000	Peak	75.08	5.66	80.74	122.20	-41.46
5855.000	Peak	72.03	5.68	77.71	110.80	-33.09
5875.000	Peak	60.15	5.78	65.93	105.20	-39.27
5925.000	Peak	50.40	5.66	56.05	68.20	-12.15
5945.250	Peak	51.73	5.46	57.19	68.20	-11.01

Unless otherwise stated the results shown in this test report refer only to the sample(s) tested and such sample(s) are retained for 90 days only.

除非另有說明，此報告結果僅對測試之樣品負責，同時此樣品僅保留90天。本報告未經本公司書面許可，不可部份複製。

This document is issued by the Company subject to its General Conditions of Service printed overleaf, available on request or accessible at <http://www.sgs.com.tw/Terms-and-Conditions> and for electronic format documents, subject to Terms and Conditions for Electronic Documents at <http://www.sgs.com.tw/Terms-and-Conditions>. Attention is drawn to the limitation of liability, indemnification and jurisdiction issues defined therein. Any holder of this document is advised that information contained hereon reflects the Company's findings at the time of its intervention only and within the limits of Client's instructions, if any. The Company's sole responsibility is to its Client and this document does not exonerate parties to a transaction from exercising all their rights and obligations under the transaction documents. This document cannot be reproduced except in full, without prior written approval of the Company. Any unauthorized alteration, forgery or falsification of the content or appearance of this document is unlawful and offenders may be prosecuted to the fullest extent of the law.

Report Number :TERF2308001923E2
 Operation Mode :802.11be40
 Test Frequency :5190 MHz
 Test Mode :Bandedge
 EUT Pol :E2 Plane

Test Site :SAC G Chamber
 Test Date :2023-10-18
 Temp./Humi. :19.7°C/63%
 Antenna Pol. :Vertical
 Engineer :Temo Chen

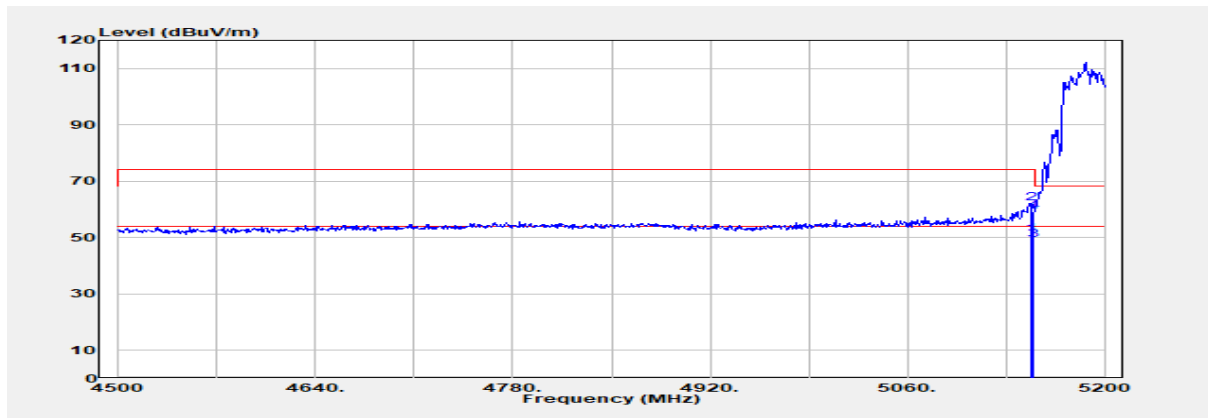

Freq. MHz	Detector Mode PK/QP/AV	Spectrum Reading Level dB μ V	Factor dB	Actual FS dB μ V/m	Limit @3m dB μ V/m	Margin dB
5148.200	Average	47.34	3.76	51.10	54.00	-2.90
5148.200	Peak	58.33	3.76	62.09	74.00	-11.91
5150.000	Average	45.47	3.74	49.21	54.00	-4.79
5150.000	Peak	55.43	3.74	59.17	74.00	-14.83

Unless otherwise stated the results shown in this test report refer only to the sample(s) tested and such sample(s) are retained for 90 days only.

除非另有說明，此報告結果僅對測試之樣品負責，同時此樣品僅保留90天。本報告未經本公司書面許可，不可部份複製。

This document is issued by the Company subject to its General Conditions of Service printed overleaf, available on request or accessible at <http://www.sgs.com.tw/Terms-and-Conditions> and for electronic format documents, subject to Terms and Conditions for Electronic Documents at <http://www.sgs.com.tw/Terms-and-Conditions>. Attention is drawn to the limitation of liability, indemnification and jurisdiction issues defined therein. Any holder of this document is advised that information contained hereon reflects the Company's findings at the time of its intervention only and within the limits of Client's instructions, if any. The Company's sole responsibility is to its Client and this document does not exonerate parties to a transaction from exercising all their rights and obligations under the transaction documents. This document cannot be reproduced except in full, without prior written approval of the Company. Any unauthorized alteration, forgery or falsification of the content or appearance of this document is unlawful and offenders may be prosecuted to the fullest extent of the law.

Report Number :TERF2308001923E2
 Operation Mode :802.11be40
 Test Frequency :5190 MHz
 Test Mode :Bandedge
 EUT Pol :E2 Plane

Test Site :SAC G Chamber
 Test Date :2023-10-18
 Temp./Humi. :19.7°C/63%
 Antenna Pol. :Horizontal
 Engineer :Temo Chen

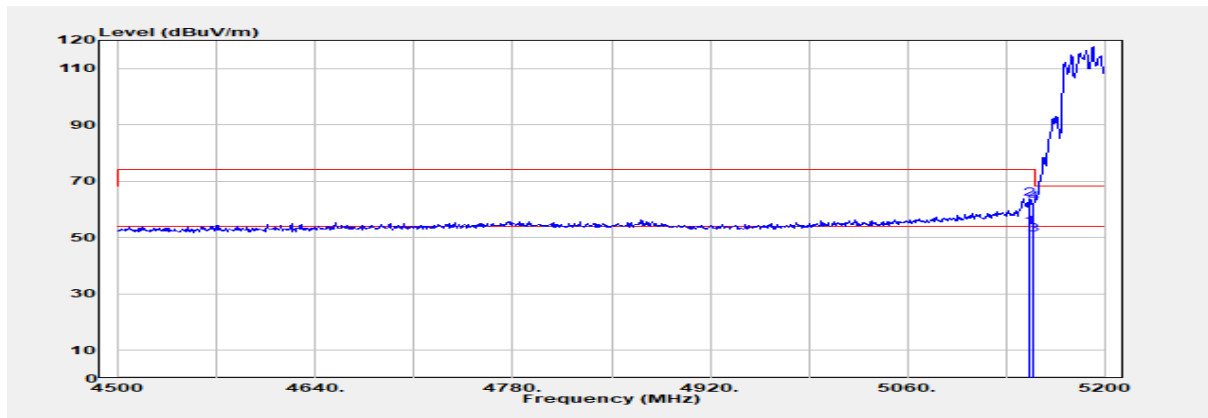

Freq. MHz	Detector Mode	Spectrum Reading Level dB μ V	Factor dB	Actual FS dB μ V/m	Limit @3m dB μ V/m	Margin dB
5146.800	Average	49.87	3.77	53.64	54.00	-0.36
5146.800	Peak	60.10	3.77	63.87	74.00	-10.13
5150.000	Average	47.24	3.74	50.99	54.00	-3.01
5150.000	Peak	58.72	3.74	62.46	74.00	-11.54

Unless otherwise stated the results shown in this test report refer only to the sample(s) tested and such sample(s) are retained for 90 days only.

除非另有說明，此報告結果僅對測試之樣品負責，同時此樣品僅保留90天。本報告未經本公司書面許可，不可部份複製。

This document is issued by the Company subject to its General Conditions of Service printed overleaf, available on request or accessible at <http://www.sgs.com.tw/Terms-and-Conditions> and for electronic format documents, subject to Terms and Conditions for Electronic Documents at <http://www.sgs.com.tw/Terms-and-Conditions>. Attention is drawn to the limitation of liability, indemnification and jurisdiction issues defined therein. Any holder of this document is advised that information contained hereon reflects the Company's findings at the time of its intervention only and within the limits of Client's instructions, if any. The Company's sole responsibility is to its Client and this document does not exonerate parties to a transaction from exercising all their rights and obligations under the transaction documents. This document cannot be reproduced except in full, without prior written approval of the Company. Any unauthorized alteration, forgery or falsification of the content or appearance of this document is unlawful and offenders may be prosecuted to the fullest extent of the law.

Report Number :TERF2308001923E2
 Operation Mode :802.11be40
 Test Frequency :5310 MHz
 Test Mode :Bandedge
 EUT Pol :E2 Plane

Test Site :SAC G Chamber
 Test Date :2023-10-18
 Temp./Humi. :19.7°C/63%
 Antenna Pol. :Vertical
 Engineer :Temo Chen

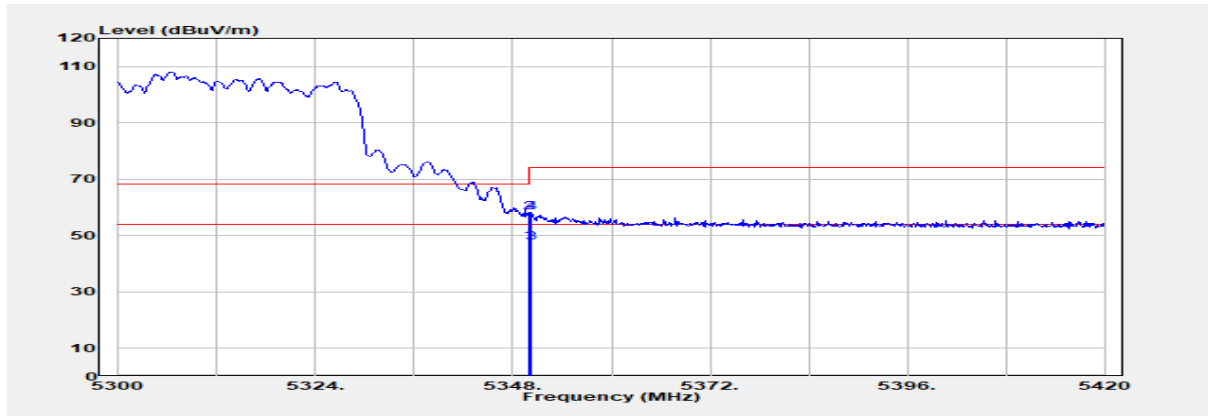

Freq. MHz	Detector Mode PK/QP/AV	Spectrum Reading Level dB μ V	Factor dB	Actual FS dB μ V/m	Limit @3m dB μ V/m	Margin dB
5350.000	Average	44.40	3.37	47.77	54.00	-6.23
5350.000	Peak	54.74	3.37	58.11	74.00	-15.89
5350.160	Average	44.13	3.37	47.50	54.00	-6.50
5350.160	Peak	54.71	3.37	58.08	74.00	-15.92

Unless otherwise stated the results shown in this test report refer only to the sample(s) tested and such sample(s) are retained for 90 days only.

除非另有說明，此報告結果僅對測試之樣品負責，同時此樣品僅保留90天。本報告未經本公司書面許可，不可部份複製。

This document is issued by the Company subject to its General Conditions of Service printed overleaf, available on request or accessible at <http://www.sgs.com.tw/Terms-and-Conditions> and for electronic format documents, subject to Terms and Conditions for Electronic Documents at <http://www.sgs.com.tw/Terms-and-Conditions>. Attention is drawn to the limitation of liability, indemnification and jurisdiction issues defined therein. Any holder of this document is advised that information contained hereon reflects the Company's findings at the time of its intervention only and within the limits of Client's instructions, if any. The Company's sole responsibility is to its Client and this document does not exonerate parties to a transaction from exercising all their rights and obligations under the transaction documents. This document cannot be reproduced except in full, without prior written approval of the Company. Any unauthorized alteration, forgery or falsification of the content or appearance of this document is unlawful and offenders may be prosecuted to the fullest extent of the law.

Report Number :TERF2308001923E2
 Operation Mode :802.11be40
 Test Frequency :5310 MHz
 Test Mode :Bandedge
 EUT Pol :E2 Plane

Test Site :SAC G Chamber
 Test Date :2023-10-18
 Temp./Humi. :19.7°C/63%
 Antenna Pol. :Horizontal
 Engineer :Temo Chen

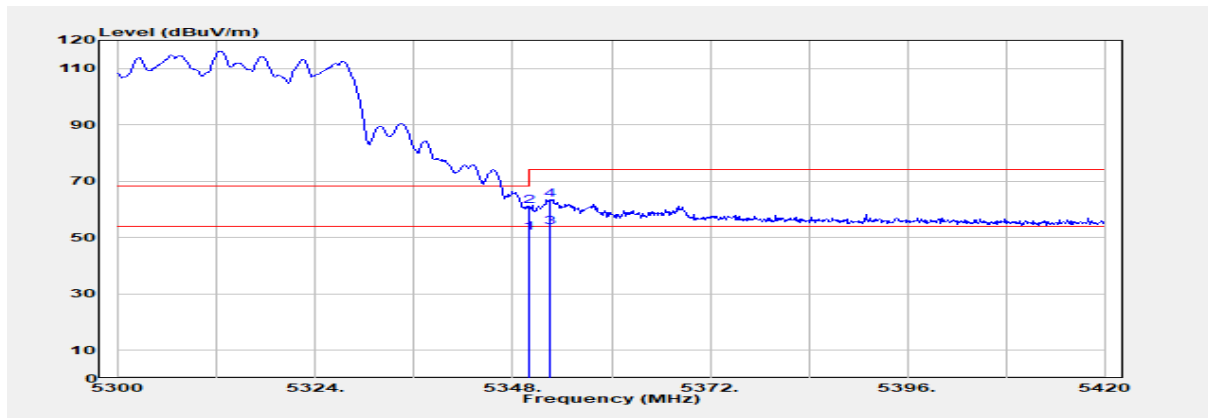

Freq. MHz	Detector Mode PK/QP/AV	Spectrum Reading Level dB μ V	Factor dB	Actual FS dB μ V/m	Limit @3m dB μ V/m	Margin dB
5350.000	Average	48.47	3.37	51.84	54.00	-2.16
5350.000	Peak	57.66	3.37	61.03	74.00	-12.97
5352.440	Average	50.38	3.37	53.75	54.00	-0.25
5352.440	Peak	60.17	3.37	63.54	74.00	-10.46

Unless otherwise stated the results shown in this test report refer only to the sample(s) tested and such sample(s) are retained for 90 days only.

除非另有說明，此報告結果僅對測試之樣品負責，同時此樣品僅保留90天。本報告未經本公司書面許可，不可部份複製。

This document is issued by the Company subject to its General Conditions of Service printed overleaf, available on request or accessible at <http://www.sgs.com.tw/Terms-and-Conditions> and for electronic format documents, subject to Terms and Conditions for Electronic Documents at <http://www.sgs.com.tw/Terms-and-Conditions>. Attention is drawn to the limitation of liability, indemnification and jurisdiction issues defined therein. Any holder of this document is advised that information contained hereon reflects the Company's findings at the time of its intervention only and within the limits of Client's instructions, if any. The Company's sole responsibility is to its Client and this document does not exonerate parties to a transaction from exercising all their rights and obligations under the transaction documents. This document cannot be reproduced except in full, without prior written approval of the Company. Any unauthorized alteration, forgery or falsification of the content or appearance of this document is unlawful and offenders may be prosecuted to the fullest extent of the law.

Report Number :TERF2308001923E2
 Operation Mode :802.11be40
 Test Frequency :5510 MHz
 Test Mode :Bandedge
 EUT Pol :E2 Plane

Test Site :SAC G Chamber
 Test Date :2023-10-19
 Temp./Humi. :20.2°C/65%
 Antenna Pol. :Vertical
 Engineer :Temo Chen

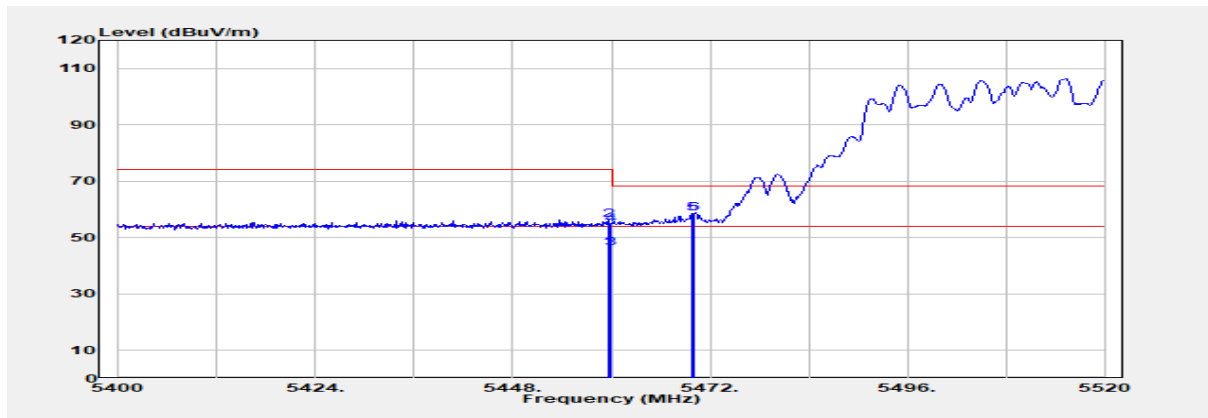

Freq. MHz	Detector Mode PK/QP/AV	Spectrum Reading Level dB μ V	Factor dB	Actual FS dB μ V/m	Limit @3m dB μ V/m	Margin dB
5459.640	Average	42.46	3.68	46.14	54.00	-7.86
5459.640	Peak	52.60	3.68	56.28	74.00	-17.72
5460.000	Average	42.44	3.68	46.12	54.00	-7.88
5460.000	Peak	50.94	3.68	54.62	74.00	-19.38
5469.720	Peak	54.82	3.76	58.58	68.20	-9.62
5470.000	Peak	54.70	3.76	58.46	68.20	-9.74

Unless otherwise stated the results shown in this test report refer only to the sample(s) tested and such sample(s) are retained for 90 days only.

除非另有說明，此報告結果僅對測試之樣品負責，同時此樣品僅保留90天。本報告未經本公司書面許可，不可部份複製。

This document is issued by the Company subject to its General Conditions of Service printed overleaf, available on request or accessible at <http://www.sgs.com.tw/Terms-and-Conditions> and for electronic format documents, subject to Terms and Conditions for Electronic Documents at <http://www.sgs.com.tw/Terms-and-Conditions>. Attention is drawn to the limitation of liability, indemnification and jurisdiction issues defined therein. Any holder of this document is advised that information contained hereon reflects the Company's findings at the time of its intervention only and within the limits of Client's instructions, if any. The Company's sole responsibility is to its Client and this document does not exonerate parties to a transaction from exercising all their rights and obligations under the transaction documents. This document cannot be reproduced except in full, without prior written approval of the Company. Any unauthorized alteration, forgery or falsification of the content or appearance of this document is unlawful and offenders may be prosecuted to the fullest extent of the law.

Report Number :TERF2308001923E2
 Operation Mode :802.11be40
 Test Frequency :5510 MHz
 Test Mode :Bandedge
 EUT Pol :E2 Plane

Test Site :SAC G Chamber
 Test Date :2023-10-19
 Temp./Humi. :20.2°C/65%
 Antenna Pol. :Horizontal
 Engineer :Temo Chen

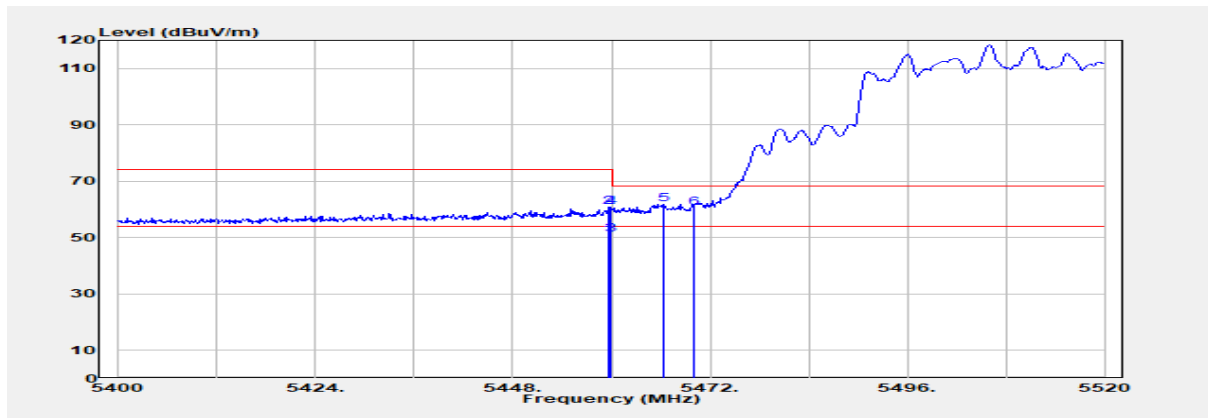

Freq. MHz	Detector Mode PK/QP/AV	Spectrum Reading Level dB μ V	Factor dB	Actual FS dB μ V/m	Limit @3m dB μ V/m	Margin dB
5459.760	Average	47.20	3.68	50.87	54.00	-3.13
5459.760	Peak	57.28	3.68	60.96	74.00	-13.04
5460.000	Average	47.54	3.68	51.22	54.00	-2.78
5460.000	Peak	56.97	3.68	60.65	74.00	-13.35
5466.240	Peak	58.15	3.73	61.88	68.20	-6.32
5470.000	Peak	56.88	3.76	60.64	68.20	-7.56

Unless otherwise stated the results shown in this test report refer only to the sample(s) tested and such sample(s) are retained for 90 days only.

除非另有說明，此報告結果僅對測試之樣品負責，同時此樣品僅保留90天。本報告未經本公司書面許可，不可部份複製。
 This document is issued by the Company subject to its General Conditions of Service printed overleaf, available on request or accessible at <http://www.sgs.com.tw/Terms-and-Conditions> and for electronic format documents, subject to Terms and Conditions for Electronic Documents at <http://www.sgs.com.tw/Terms-and-Conditions>. Attention is drawn to the limitation of liability, indemnification and jurisdiction issues defined therein. Any holder of this document is advised that information contained hereon reflects the Company's findings at the time of its intervention only and within the limits of Client's instructions, if any. The Company's sole responsibility is to its Client and this document does not exonerate parties to a transaction from exercising all their rights and obligations under the transaction documents. This document cannot be reproduced except in full, without prior written approval of the Company. Any unauthorized alteration, forgery or falsification of the content or appearance of this document is unlawful and offenders may be prosecuted to the fullest extent of the law.

Report Number :TERF2308001923E2
 Operation Mode :802.11be40
 Test Frequency :5670 MHz
 Test Mode :Bandedge
 EUT Pol :E2 Plane

Test Site :SAC G Chamber
 Test Date :2023-10-19
 Temp./Humi. :20.2°C/65%
 Antenna Pol. :Vertical
 Engineer :Temo Chen

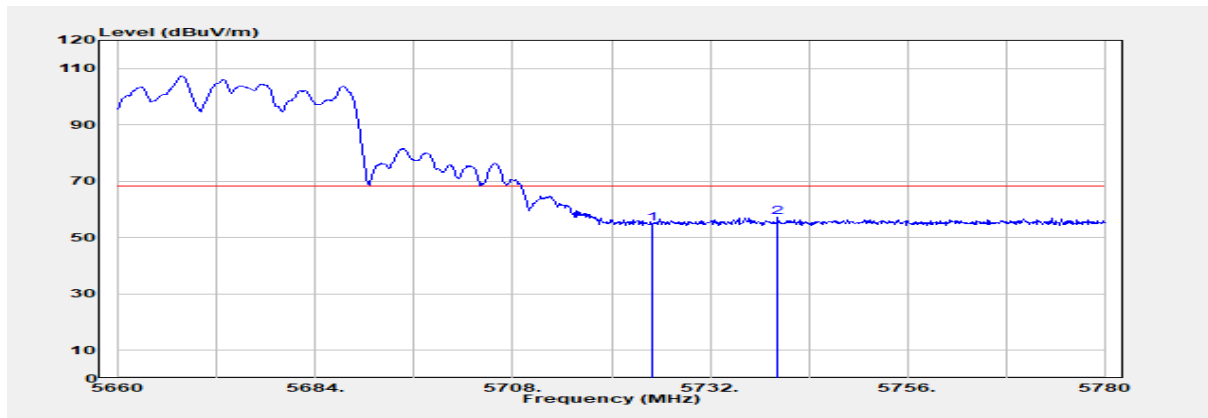

Freq. MHz	Detector Mode PK/QP/AV	Spectrum Reading Level dB μ V	Factor dB	Actual FS dB μ V/m	Limit @3m dB μ V/m	Margin dB
5725.000	Peak	49.40	5.57	54.97	68.20	-13.23
5740.280	Peak	51.52	5.58	57.10	68.20	-11.10

Unless otherwise stated the results shown in this test report refer only to the sample(s) tested and such sample(s) are retained for 90 days only.

除非另有說明，此報告結果僅對測試之樣品負責，同時此樣品僅保留90天。本報告未經本公司書面許可，不可部份複製。

This document is issued by the Company subject to its General Conditions of Service printed overleaf, available on request or accessible at <http://www.sgs.com.tw/Terms-and-Conditions> and for electronic format documents, subject to Terms and Conditions for Electronic Documents at <http://www.sgs.com.tw/Terms-and-Conditions>. Attention is drawn to the limitation of liability, indemnification and jurisdiction issues defined therein. Any holder of this document is advised that information contained hereon reflects the Company's findings at the time of its intervention only and within the limits of Client's instructions, if any. The Company's sole responsibility is to its Client and this document does not exonerate parties to a transaction from exercising all their rights and obligations under the transaction documents. This document cannot be reproduced except in full, without prior written approval of the Company. Any unauthorized alteration, forgery or falsification of the content or appearance of this document is unlawful and offenders may be prosecuted to the fullest extent of the law.

Report Number :TERF2308001923E2
 Operation Mode :802.11be40
 Test Frequency :5670 MHz
 Test Mode :Bandedge
 EUT Pol :E2 Plane

Test Site :SAC G Chamber
 Test Date :2023-10-19
 Temp./Humi. :20.2°C/65%
 Antenna Pol. :Horizontal
 Engineer :Temo Chen

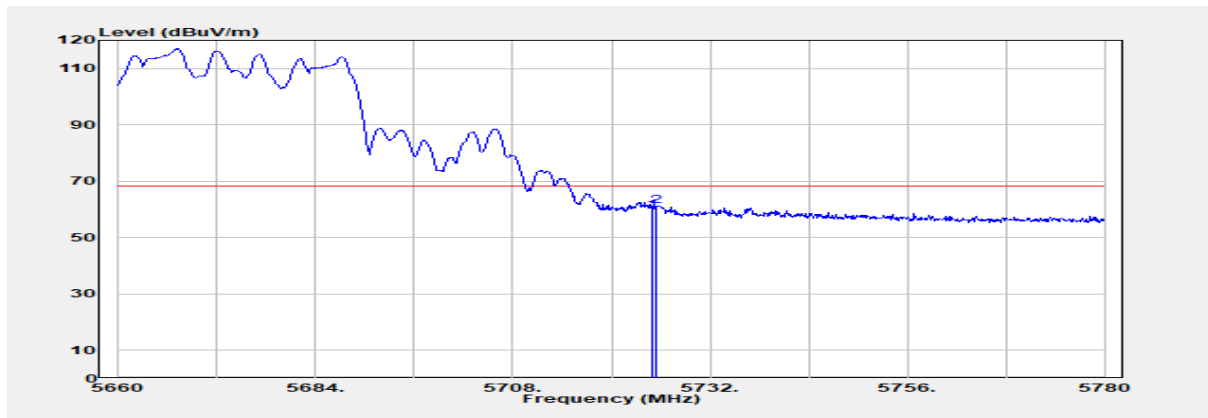

Freq. MHz	Detector Mode PK/QP/AV	Spectrum Reading Level dB μ V	Factor dB	Actual FS dB μ V/m	Limit @3m dB μ V/m	Margin dB
5725.000	Peak	53.79	5.57	59.36	68.20	-8.84
5725.520	Peak	55.66	5.58	61.23	68.20	-6.97

Unless otherwise stated the results shown in this test report refer only to the sample(s) tested and such sample(s) are retained for 90 days only.

除非另有說明，此報告結果僅對測試之樣品負責，同時此樣品僅保留90天。本報告未經本公司書面許可，不可部份複製。

This document is issued by the Company subject to its General Conditions of Service printed overleaf, available on request or accessible at <http://www.sgs.com.tw/Terms-and-Conditions> and for electronic format documents, subject to Terms and Conditions for Electronic Documents at <http://www.sgs.com.tw/Terms-and-Conditions>. Attention is drawn to the limitation of liability, indemnification and jurisdiction issues defined therein. Any holder of this document is advised that information contained hereon reflects the Company's findings at the time of its intervention only and within the limits of Client's instructions, if any. The Company's sole responsibility is to its Client and this document does not exonerate parties to a transaction from exercising all their rights and obligations under the transaction documents. This document cannot be reproduced except in full, without prior written approval of the Company. Any unauthorized alteration, forgery or falsification of the content or appearance of this document is unlawful and offenders may be prosecuted to the fullest extent of the law.

Report Number :TERF2308001923E2
 Operation Mode :802.11be40
 Test Frequency :5755 MHz
 Test Mode :Bandedge
 EUT Pol :E2 Plane

Test Site :SAC G Chamber
 Test Date :2023-10-19
 Temp./Humi. :20.2°C/65%
 Antenna Pol. :Vertical
 Engineer :Temo Chen

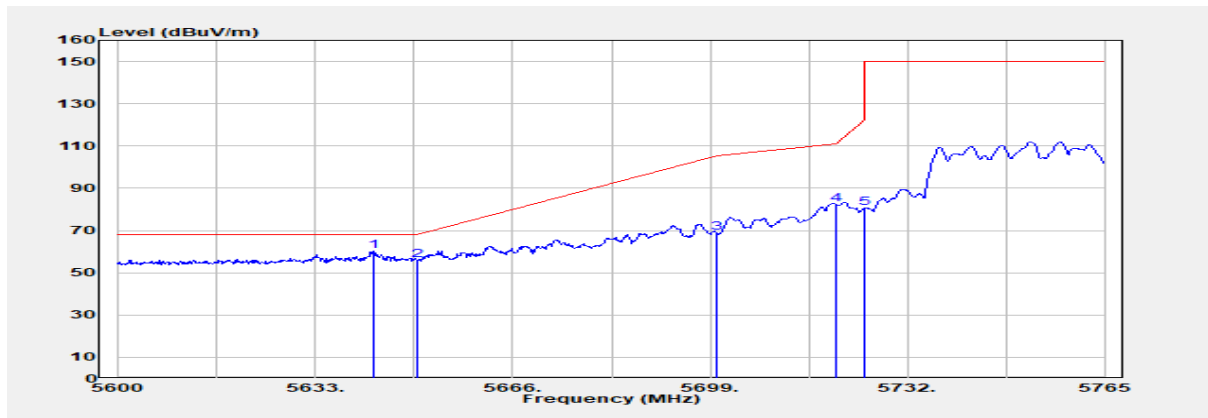

Freq. MHz	Detector Mode PK/QP/AV	Spectrum Reading Level dBμV	Factor dB	Actual FS dBμV/m	Limit @3m dBμV/m	Margin dB
5642.570	Peak	55.67	4.64	60.31	68.20	-7.89
5650.000	Peak	51.03	4.76	55.79	68.20	-12.41
5700.000	Peak	63.44	5.56	69.00	105.20	-36.20
5720.000	Peak	76.76	5.57	82.34	110.80	-28.46
5725.000	Peak	75.18	5.57	80.76	122.20	-41.44

Unless otherwise stated the results shown in this test report refer only to the sample(s) tested and such sample(s) are retained for 90 days only.

除非另有說明，此報告結果僅對測試之樣品負責，同時此樣品僅保留90天。本報告未經本公司書面許可，不可部份複製。

This document is issued by the Company subject to its General Conditions of Service printed overleaf, available on request or accessible at <http://www.sgs.com.tw/Terms-and-Conditions>, and for electronic format documents, subject to Terms and Conditions for Electronic Documents at <http://www.sgs.com.tw/Terms-and-Conditions>. Attention is drawn to the limitation of liability, indemnification and jurisdiction issues defined therein. Any holder of this document is advised that information contained hereon reflects the Company's findings at the time of its intervention only and within the limits of Client's instructions, if any. The Company's sole responsibility is to its Client and this document does not exonerate parties to a transaction from exercising all their rights and obligations under the transaction documents. This document cannot be reproduced except in full, without prior written approval of the Company. Any unauthorized alteration, forgery or falsification of the content or appearance of this document is unlawful and offenders may be prosecuted to the fullest extent of the law.

Report Number :TERF2308001923E2
 Operation Mode :802.11be40
 Test Frequency :5755 MHz
 Test Mode :Bandedge
 EUT Pol :E2 Plane

Test Site :SAC G Chamber
 Test Date :2023-10-19
 Temp./Humi. :20.2°C/65%
 Antenna Pol. :Horizontal
 Engineer :Temo Chen

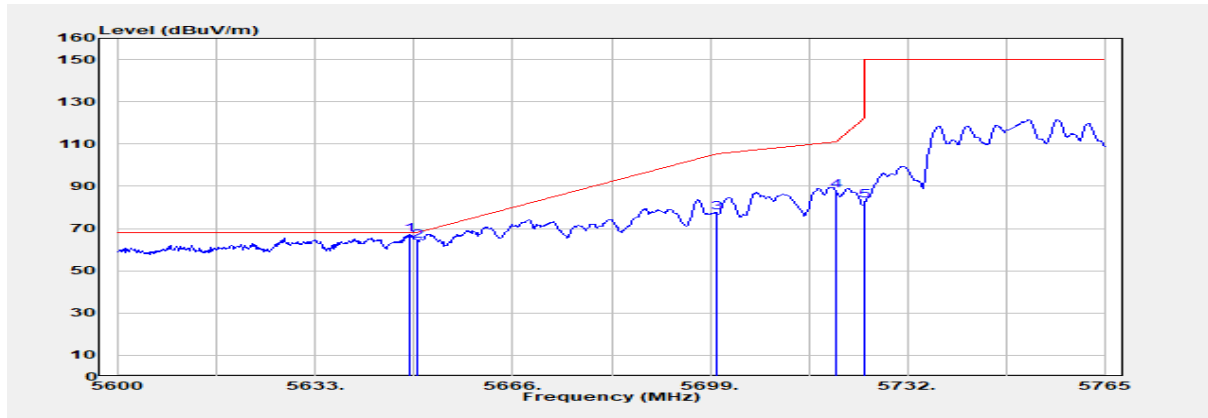

Freq. MHz	Detector Mode PK/QP/AV	Spectrum Reading Level dB μ V	Factor dB	Actual FS dB μ V/m	Limit @3m dB μ V/m	Margin dB
5648.675	Peak	62.37	4.74	67.10	68.20	-1.10
5650.000	Peak	59.42	4.76	64.18	68.20	-4.02
5700.000	Peak	71.84	5.56	77.40	105.20	-27.80
5720.000	Peak	82.62	5.57	88.19	110.80	-22.61
5725.000	Peak	77.62	5.57	83.20	122.20	-39.00

Unless otherwise stated the results shown in this test report refer only to the sample(s) tested and such sample(s) are retained for 90 days only.

除非另有說明，此報告結果僅對測試之樣品負責，同時此樣品僅保留90天。本報告未經本公司書面許可，不可部份複製。

This document is issued by the Company subject to its General Conditions of Service printed overleaf, available on request or accessible at <http://www.sgs.com.tw/Terms-and-Conditions> and for electronic format documents, subject to Terms and Conditions for Electronic Documents at <http://www.sgs.com.tw/Terms-and-Conditions>. Attention is drawn to the limitation of liability, indemnification and jurisdiction issues defined therein. Any holder of this document is advised that information contained hereon reflects the Company's findings at the time of its intervention only and within the limits of Client's instructions, if any. The Company's sole responsibility is to its Client and this document does not exonerate parties to a transaction from exercising all their rights and obligations under the transaction documents. This document cannot be reproduced except in full, without prior written approval of the Company. Any unauthorized alteration, forgery or falsification of the content or appearance of this document is unlawful and offenders may be prosecuted to the fullest extent of the law.

Report Number :TERF2308001923E2	Test Site :SAC G Chamber
Operation Mode :802.11be40	Test Date :2023-10-19
Test Frequency :5795 MHz	Temp./Humi. :20.2°C/65%
Test Mode :Bandedge	Antenna Pol. :Vertical
EUT Pol :E2 Plane	Engineer :Temo Chen

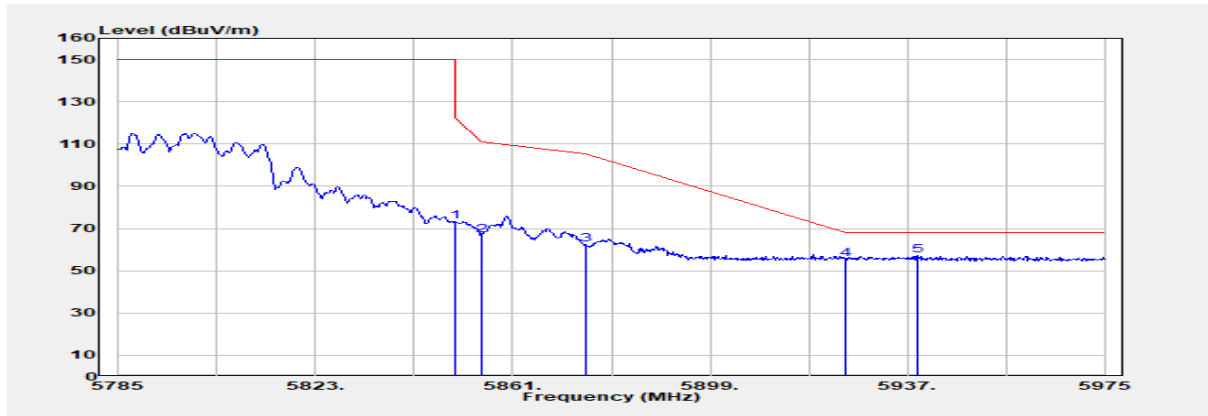

Freq. MHz	Detector Mode PK/QP/AV	Spectrum Reading Level dB μ V	Factor dB	Actual FS dB μ V/m	Limit @3m dB μ V/m	Margin dB
5850.000	Peak	67.74	5.66	73.40	122.20	-48.80
5855.000	Peak	61.00	5.68	66.69	110.80	-44.11
5875.000	Peak	56.87	5.78	62.65	105.20	-42.55
5925.000	Peak	49.78	5.66	55.44	68.20	-12.76
5938.900	Peak	51.69	5.52	57.21	68.20	-10.99

Unless otherwise stated the results shown in this test report refer only to the sample(s) tested and such sample(s) are retained for 90 days only.

除非另有說明，此報告結果僅對測試之樣品負責，同時此樣品僅保留90天。本報告未經本公司書面許可，不可部份複製。

This document is issued by the Company subject to its General Conditions of Service printed overleaf, available on request or accessible at <http://www.sgs.com.tw/Terms-and-Conditions> and for electronic format documents, subject to Terms and Conditions for Electronic Documents at <http://www.sgs.com.tw/Terms-and-Conditions>. Attention is drawn to the limitation of liability, indemnification and jurisdiction issues defined therein. Any holder of this document is advised that information contained hereon reflects the Company's findings at the time of its intervention only and within the limits of Client's instructions, if any. The Company's sole responsibility is to its Client and this document does not exonerate parties to a transaction from exercising all their rights and obligations under the transaction documents. This document cannot be reproduced except in full, without prior written approval of the Company. Any unauthorized alteration, forgery or falsification of the content or appearance of this document is unlawful and offenders may be prosecuted to the fullest extent of the law.

Report Number :TERF2308001923E2
 Operation Mode :802.11be40
 Test Frequency :5795 MHz
 Test Mode :Bandedge
 EUT Pol :E2 Plane

Test Site :SAC G Chamber
 Test Date :2023-10-19
 Temp./Humi. :20.2°C/65%
 Antenna Pol. :Horizontal
 Engineer :Temo Chen

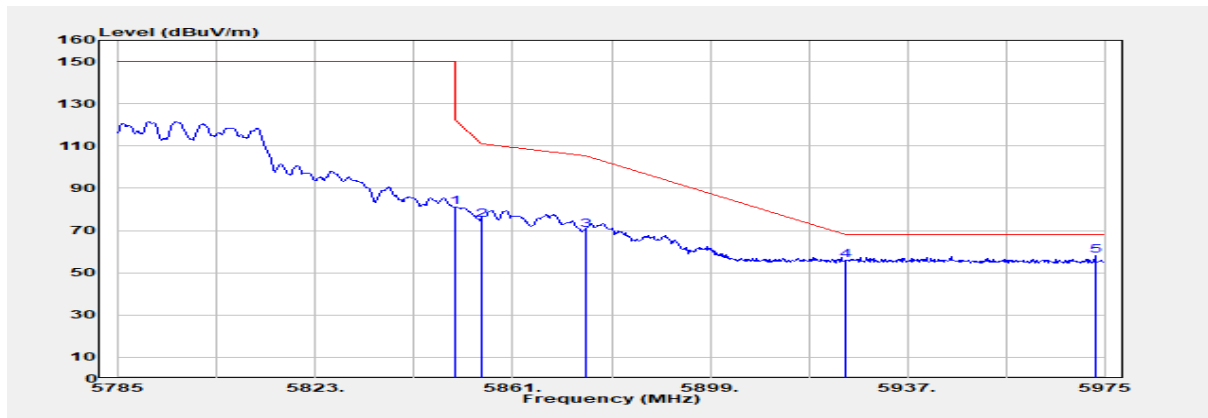

Freq. MHz	Detector Mode PK/QP/AV	Spectrum Reading Level dB μ V	Factor dB	Actual FS dB μ V/m	Limit @3m dB μ V/m	Margin dB
5850.000	Peak	75.54	5.66	81.20	122.20	-41.00
5855.000	Peak	69.46	5.68	75.15	110.80	-35.65
5875.000	Peak	64.62	5.78	70.40	105.20	-34.80
5925.000	Peak	50.33	5.66	55.99	68.20	-12.21
5973.290	Peak	52.91	5.14	58.05	68.20	-10.15

Unless otherwise stated the results shown in this test report refer only to the sample(s) tested and such sample(s) are retained for 90 days only.

除非另有說明，此報告結果僅對測試之樣品負責，同時此樣品僅保留90天。本報告未經本公司書面許可，不可部份複製。

This document is issued by the Company subject to its General Conditions of Service printed overleaf, available on request or accessible at <http://www.sgs.com.tw/Terms-and-Conditions> and for electronic format documents, subject to Terms and Conditions for Electronic Documents at <http://www.sgs.com.tw/Terms-and-Conditions>. Attention is drawn to the limitation of liability, indemnification and jurisdiction issues defined therein. Any holder of this document is advised that information contained hereon reflects the Company's findings at the time of its intervention only and within the limits of Client's instructions, if any. The Company's sole responsibility is to its Client and this document does not exonerate parties to a transaction from exercising all their rights and obligations under the transaction documents. This document cannot be reproduced except in full, without prior written approval of the Company. Any unauthorized alteration, forgery or falsification of the content or appearance of this document is unlawful and offenders may be prosecuted to the fullest extent of the law.

Report Number :TERF2308001923E2
 Operation Mode :802.11be80
 Test Frequency :5210 MHz
 Test Mode :Bandedge
 EUT Pol :E2 Plane

Test Site :SAC G Chamber
 Test Date :2023-10-18
 Temp./Humi. :19.7°C/63%
 Antenna Pol. :Vertical
 Engineer :Temo Chen

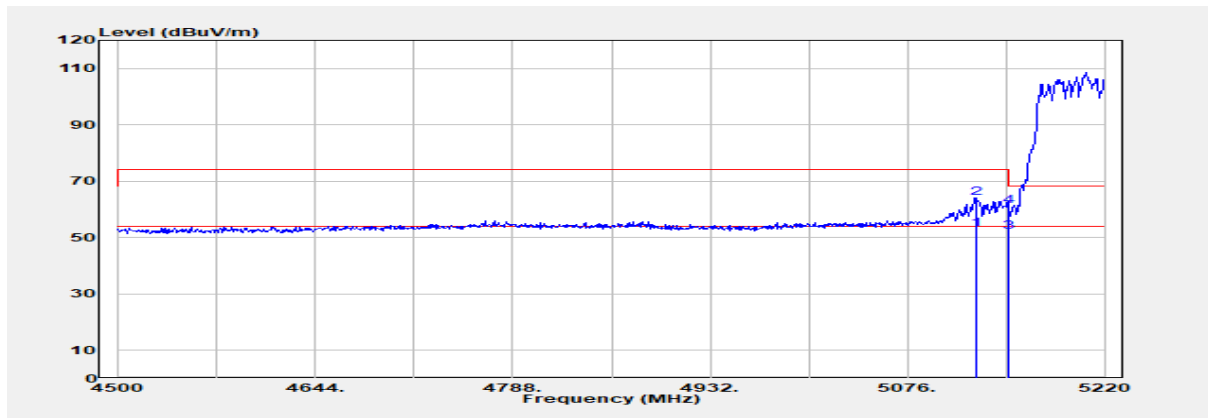

Freq. MHz	Detector Mode PK/QP/AV	Spectrum Reading Level dBμV	Factor dB	Actual FS dBμV/m	Limit @3m dBμV/m	Margin dB
5126.400	Average	49.11	3.96	53.07	54.00	-0.93
5126.400	Peak	60.02	3.96	63.98	74.00	-10.02
5150.000	Average	48.28	3.74	52.02	54.00	-1.98
5150.000	Peak	57.37	3.74	61.11	74.00	-12.89

Unless otherwise stated the results shown in this test report refer only to the sample(s) tested and such sample(s) are retained for 90 days only.

除非另有說明，此報告結果僅對測試之樣品負責，同時此樣品僅保留90天。本報告未經本公司書面許可，不可部份複製。

This document is issued by the Company subject to its General Conditions of Service printed overleaf, available on request or accessible at <http://www.sgs.com.tw/Terms-and-Conditions> and for electronic format documents, subject to Terms and Conditions for Electronic Documents at <http://www.sgs.com.tw/Terms-and-Conditions>. Attention is drawn to the limitation of liability, indemnification and jurisdiction issues defined therein. Any holder of this document is advised that information contained hereon reflects the Company's findings at the time of its intervention only and within the limits of Client's instructions, if any. The Company's sole responsibility is to its Client and this document does not exonerate parties to a transaction from exercising all their rights and obligations under the transaction documents. This document cannot be reproduced except in full, without prior written approval of the Company. Any unauthorized alteration, forgery or falsification of the content or appearance of this document is unlawful and offenders may be prosecuted to the fullest extent of the law.

Report Number :TERF2308001923E2
 Operation Mode :802.11be80
 Test Frequency :5210 MHz
 Test Mode :Bandedge
 EUT Pol :E2 Plane

Test Site :SAC G Chamber
 Test Date :2023-10-18
 Temp./Humi. :19.7°C/63%
 Antenna Pol. :Horizontal
 Engineer :Temo Chen

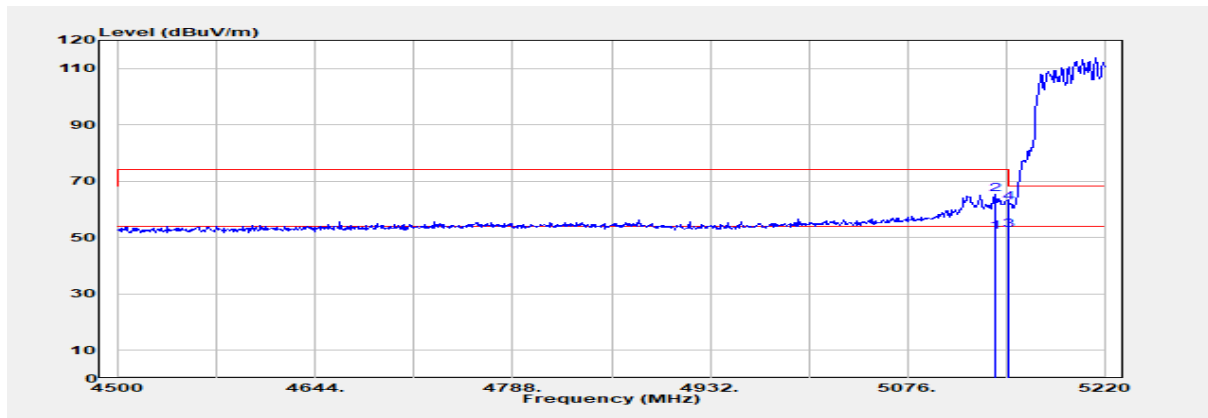

Freq. MHz	Detector Mode	Spectrum Reading Level dB μ V	Factor dB	Actual FS dB μ V/m	Limit @3m dB μ V/m	Margin dB
5140.080	Average	48.18	3.83	52.01	54.00	-1.99
5140.080	Peak	61.40	3.83	65.23	74.00	-8.77
5150.000	Average	49.09	3.74	52.84	54.00	-1.16
5150.000	Peak	58.82	3.74	62.57	74.00	-11.43

Unless otherwise stated the results shown in this test report refer only to the sample(s) tested and such sample(s) are retained for 90 days only.

除非另有說明，此報告結果僅對測試之樣品負責，同時此樣品僅保留90天。本報告未經本公司書面許可，不可部份複製。

This document is issued by the Company subject to its General Conditions of Service printed overleaf, available on request or accessible at <http://www.sgs.com.tw/Terms-and-Conditions> and for electronic format documents, subject to Terms and Conditions for Electronic Documents at <http://www.sgs.com.tw/Terms-and-Conditions>. Attention is drawn to the limitation of liability, indemnification and jurisdiction issues defined therein. Any holder of this document is advised that information contained hereon reflects the Company's findings at the time of its intervention only and within the limits of Client's instructions, if any. The Company's sole responsibility is to its Client and this document does not exonerate parties to a transaction from exercising all their rights and obligations under the transaction documents. This document cannot be reproduced except in full, without prior written approval of the Company. Any unauthorized alteration, forgery or falsification of the content or appearance of this document is unlawful and offenders may be prosecuted to the fullest extent of the law.

Report Number :TERF2308001923E2
 Operation Mode :802.11be80
 Test Frequency :5290 MHz
 Test Mode :Bandedge
 EUT Pol :E2 Plane

Test Site :SAC G Chamber
 Test Date :2023-10-18
 Temp./Humi. :19.7°C/63%
 Antenna Pol. :Vertical
 Engineer :Temo Chen

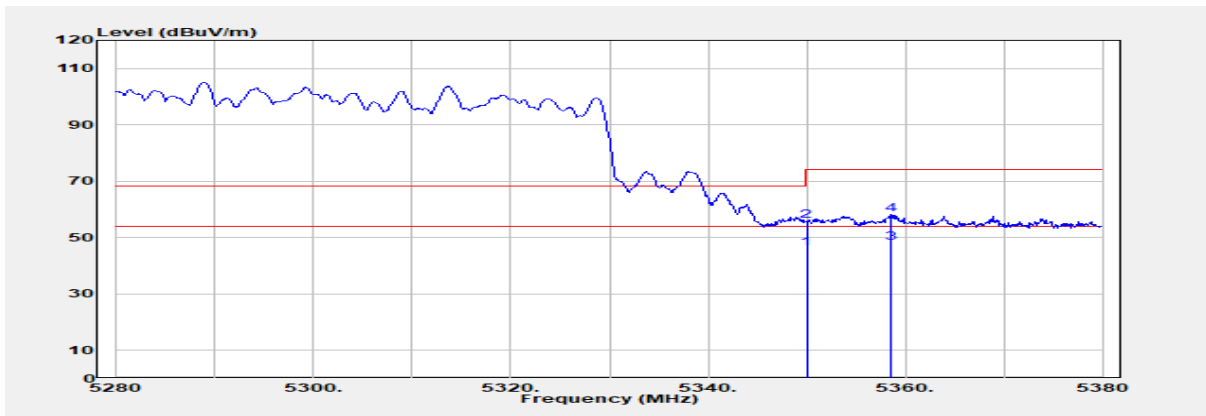

Freq. MHz	Detector Mode PK/QP/AV	Spectrum Reading Level dB μ V	Factor dB	Actual FS dB μ V/m	Limit @3m dB μ V/m	Margin dB
5350.000	Average	42.95	3.37	46.32	54.00	-7.68
5350.000	Peak	52.44	3.37	55.81	74.00	-18.19
5358.600	Average	44.82	3.37	48.19	54.00	-5.81
5358.600	Peak	54.84	3.37	58.21	74.00	-15.79

Unless otherwise stated the results shown in this test report refer only to the sample(s) tested and such sample(s) are retained for 90 days only.

除非另有說明，此報告結果僅對測試之樣品負責，同時此樣品僅保留90天。本報告未經本公司書面許可，不可部份複製。

This document is issued by the Company subject to its General Conditions of Service printed overleaf, available on request or accessible at <http://www.sgs.com.tw/Terms-and-Conditions> and for electronic format documents, subject to Terms and Conditions for Electronic Documents at <http://www.sgs.com.tw/Terms-and-Conditions>. Attention is drawn to the limitation of liability, indemnification and jurisdiction issues defined therein. Any holder of this document is advised that information contained hereon reflects the Company's findings at the time of its intervention only and within the limits of Client's instructions, if any. The Company's sole responsibility is to its Client and this document does not exonerate parties to a transaction from exercising all their rights and obligations under the transaction documents. This document cannot be reproduced except in full, without prior written approval of the Company. Any unauthorized alteration, forgery or falsification of the content or appearance of this document is unlawful and offenders may be prosecuted to the fullest extent of the law.

Report Number :TERF2308001923E2
 Operation Mode :802.11be80
 Test Frequency :5290 MHz
 Test Mode :Bandedge
 EUT Pol :E2 Plane

Test Site :SAC G Chamber
 Test Date :2023-10-18
 Temp./Humi. :19.7°C/63%
 Antenna Pol. :Horizontal
 Engineer :Temo Chen

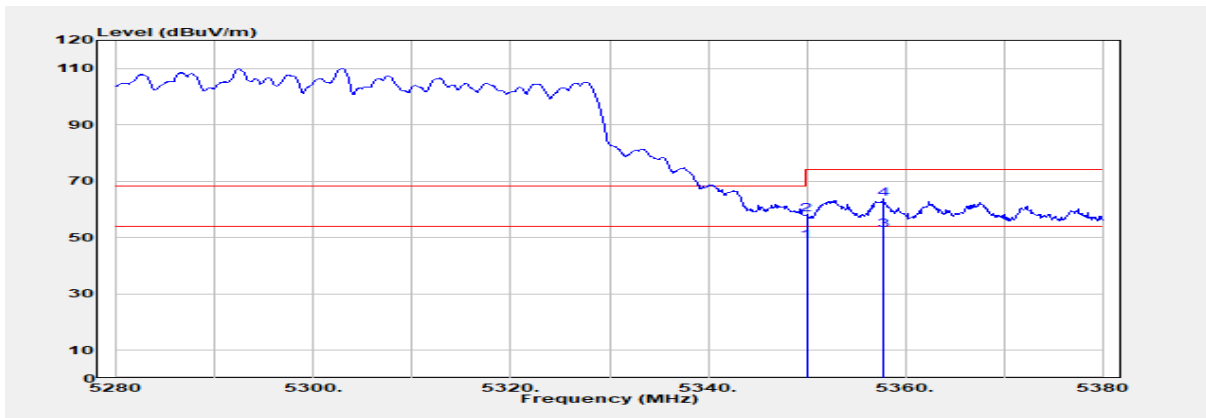

Freq. MHz	Detector Mode PK/QP/AV	Spectrum Reading Level dB μ V	Factor dB	Actual FS dB μ V/m	Limit @3m dB μ V/m	Margin dB
5350.000	Average	45.55	3.37	48.92	54.00	-5.08
5350.000	Peak	54.89	3.37	58.26	74.00	-15.74
5357.800	Average	49.36	3.37	52.74	54.00	-1.26
5357.800	Peak	60.21	3.37	63.58	74.00	-10.42

Unless otherwise stated the results shown in this test report refer only to the sample(s) tested and such sample(s) are retained for 90 days only.

除非另有說明，此報告結果僅對測試之樣品負責，同時此樣品僅保留90天。本報告未經本公司書面許可，不可部份複製。

This document is issued by the Company subject to its General Conditions of Service printed overleaf, available on request or accessible at <http://www.sgs.com.tw/Terms-and-Conditions> and for electronic format documents, subject to Terms and Conditions for Electronic Documents at <http://www.sgs.com.tw/Terms-and-Conditions>. Attention is drawn to the limitation of liability, indemnification and jurisdiction issues defined therein. Any holder of this document is advised that information contained hereon reflects the Company's findings at the time of its intervention only and within the limits of Client's instructions, if any. The Company's sole responsibility is to its Client and this document does not exonerate parties to a transaction from exercising all their rights and obligations under the transaction documents. This document cannot be reproduced except in full, without prior written approval of the Company. Any unauthorized alteration, forgery or falsification of the content or appearance of this document is unlawful and offenders may be prosecuted to the fullest extent of the law.

Report Number :TERF2308001923E2
 Operation Mode :802.11be80
 Test Frequency :5530 MHz
 Test Mode :Bandedge
 EUT Pol :E2 Plane

Test Site :SAC G Chamber
 Test Date :2023-10-18
 Temp./Humi. :19.7°C/63%
 Antenna Pol. :Vertical
 Engineer :Temo Chen

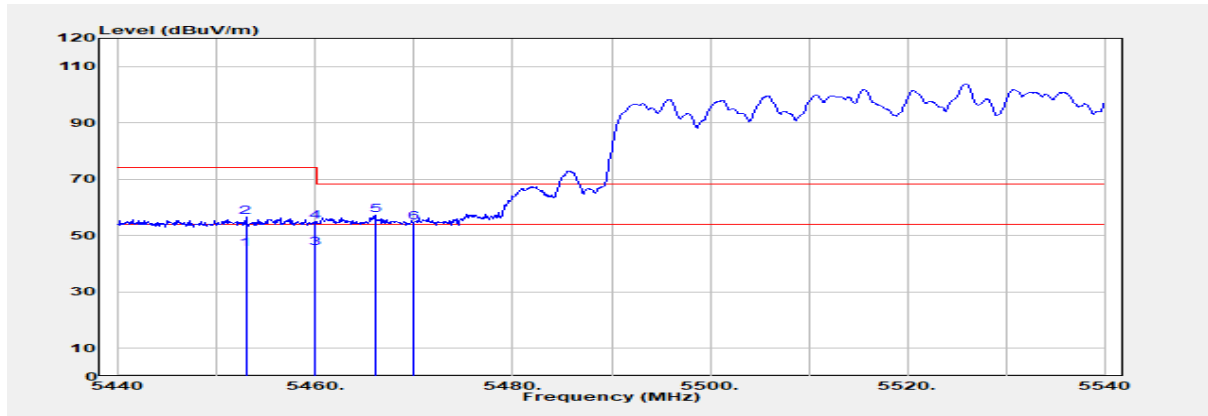

Freq. MHz	Detector Mode PK/QP/AV	Spectrum Reading Level dBμV	Factor dB	Actual FS dBμV/m	Limit @3m dBμV/m	Margin dB
5452.900	Average	41.61	3.62	45.23	54.00	-8.77
5452.900	Peak	53.12	3.62	56.74	74.00	-17.26
5460.000	Average	41.89	3.68	45.57	54.00	-8.43
5460.000	Peak	51.24	3.68	54.92	74.00	-19.08
5466.000	Peak	53.67	3.73	57.40	68.20	-10.80
5470.000	Peak	50.76	3.76	54.52	68.20	-13.68

Unless otherwise stated the results shown in this test report refer only to the sample(s) tested and such sample(s) are retained for 90 days only.

除非另有說明，此報告結果僅對測試之樣品負責，同時此樣品僅保留90天。本報告未經本公司書面許可，不可部份複製。

This document is issued by the Company subject to its General Conditions of Service printed overleaf, available on request or accessible at <http://www.sgs.com.tw/Terms-and-Conditions> and for electronic format documents, subject to Terms and Conditions for Electronic Documents at <http://www.sgs.com.tw/Terms-and-Conditions>. Attention is drawn to the limitation of liability, indemnification and jurisdiction issues defined therein. Any holder of this document is advised that information contained hereon reflects the Company's findings at the time of its intervention only and within the limits of Client's instructions, if any. The Company's sole responsibility is to its Client and this document does not exonerate parties to a transaction from exercising all their rights and obligations under the transaction documents. This document cannot be reproduced except in full, without prior written approval of the Company. Any unauthorized alteration, forgery or falsification of the content or appearance of this document is unlawful and offenders may be prosecuted to the fullest extent of the law.

Report Number :TERF2308001923E2
 Operation Mode :802.11be80
 Test Frequency :5530 MHz
 Test Mode :Bandedge
 EUT Pol :E2 Plane

Test Site :SAC G Chamber
 Test Date :2023-10-18
 Temp./Humi. :19.7°C/63%
 Antenna Pol. :Horizontal
 Engineer :Temo Chen

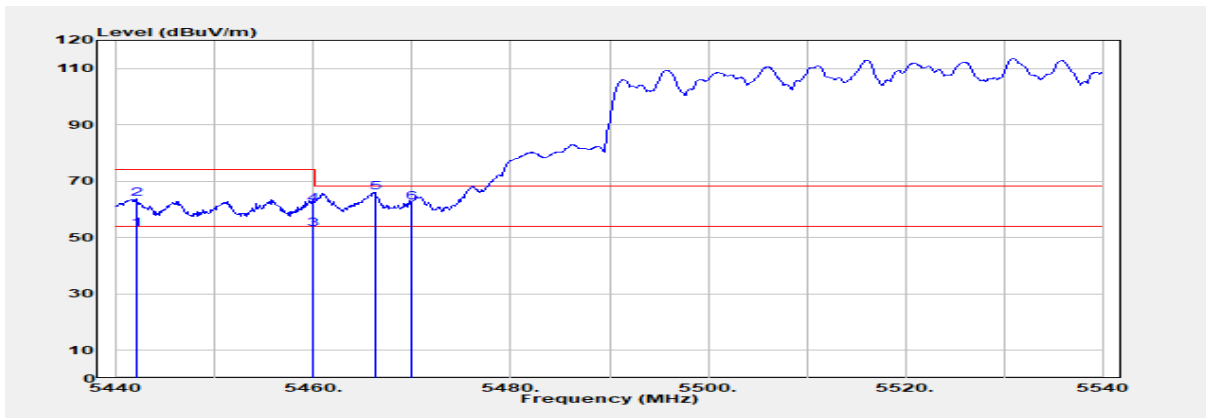

Freq. MHz	Detector Mode PK/QP/AV	Spectrum Reading Level dBμV	Factor dB	Actual FS dBμV/m	Limit @3m dBμV/m	Margin dB
5442.000	Average	49.44	3.56	53.00	54.00	-1.00
5442.000	Peak	60.13	3.56	63.69	74.00	-10.31
5460.000	Average	49.38	3.68	53.06	54.00	-0.94
5460.000	Peak	58.12	3.68	61.80	74.00	-12.20
5466.200	Peak	62.20	3.73	65.93	68.20	-2.27
5470.000	Peak	58.71	3.76	62.47	68.20	-5.73

Unless otherwise stated the results shown in this test report refer only to the sample(s) tested and such sample(s) are retained for 90 days only.

除非另有說明，此報告結果僅對測試之樣品負責，同時此樣品僅保留90天。本報告未經本公司書面許可，不可部份複製。

This document is issued by the Company subject to its General Conditions of Service printed overleaf, available on request or accessible at <http://www.sgs.com.tw/Terms-and-Conditions> and for electronic format documents, subject to Terms and Conditions for Electronic Documents at <http://www.sgs.com.tw/Terms-and-Conditions>. Attention is drawn to the limitation of liability, indemnification and jurisdiction issues defined therein. Any holder of this document is advised that information contained hereon reflects the Company's findings at the time of its intervention only and within the limits of Client's instructions, if any. The Company's sole responsibility is to its Client and this document does not exonerate parties to a transaction from exercising all their rights and obligations under the transaction documents. This document cannot be reproduced except in full, without prior written approval of the Company. Any unauthorized alteration, forgery or falsification of the content or appearance of this document is unlawful and offenders may be prosecuted to the fullest extent of the law.

Report Number :TERF2308001923E2
 Operation Mode :802.11be80
 Test Frequency :5610 MHz
 Test Mode :Bandedge
 EUT Pol :E2 Plane

Test Site :SAC G Chamber
 Test Date :2023-10-19
 Temp./Humi. :20.2°C/65%
 Antenna Pol. :Vertical
 Engineer :Temo Chen

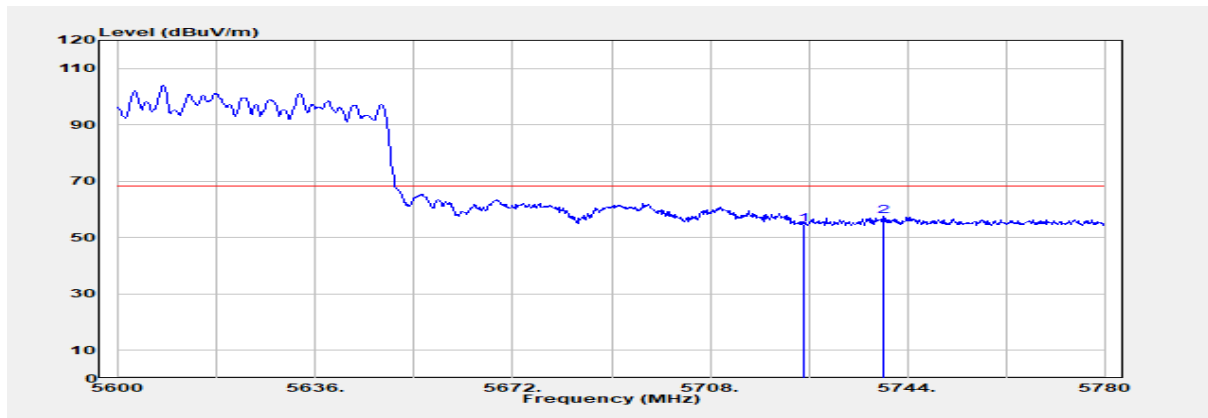

Freq. MHz	Detector Mode PK/QP/AV	Spectrum Reading Level dB μ V	Factor dB	Actual FS dB μ V/m	Limit @3m dB μ V/m	Margin dB
5725.000	Peak	49.15	5.57	54.73	68.20	-13.47
5739.500	Peak	51.89	5.58	57.47	68.20	-10.73

Unless otherwise stated the results shown in this test report refer only to the sample(s) tested and such sample(s) are retained for 90 days only.

除非另有說明，此報告結果僅對測試之樣品負責，同時此樣品僅保留90天。本報告未經本公司書面許可，不可部份複製。

This document is issued by the Company subject to its General Conditions of Service printed overleaf, available on request or accessible at <http://www.sgs.com.tw/Terms-and-Conditions> and for electronic format documents, subject to Terms and Conditions for Electronic Documents at <http://www.sgs.com.tw/Terms-and-Conditions>. Attention is drawn to the limitation of liability, indemnification and jurisdiction issues defined therein. Any holder of this document is advised that information contained hereon reflects the Company's findings at the time of its intervention only and within the limits of Client's instructions, if any. The Company's sole responsibility is to its Client and this document does not exonerate parties to a transaction from exercising all their rights and obligations under the transaction documents. This document cannot be reproduced except in full, without prior written approval of the Company. Any unauthorized alteration, forgery or falsification of the content or appearance of this document is unlawful and offenders may be prosecuted to the fullest extent of the law.

Report Number :TERF2308001923E2
 Operation Mode :802.11be80
 Test Frequency :5610 MHz
 Test Mode :Bandedge
 EUT Pol :E2 Plane

Test Site :SAC G Chamber
 Test Date :2023-10-19
 Temp./Humi. :20.2°C/65%
 Antenna Pol. :Horizontal
 Engineer :Temo Chen

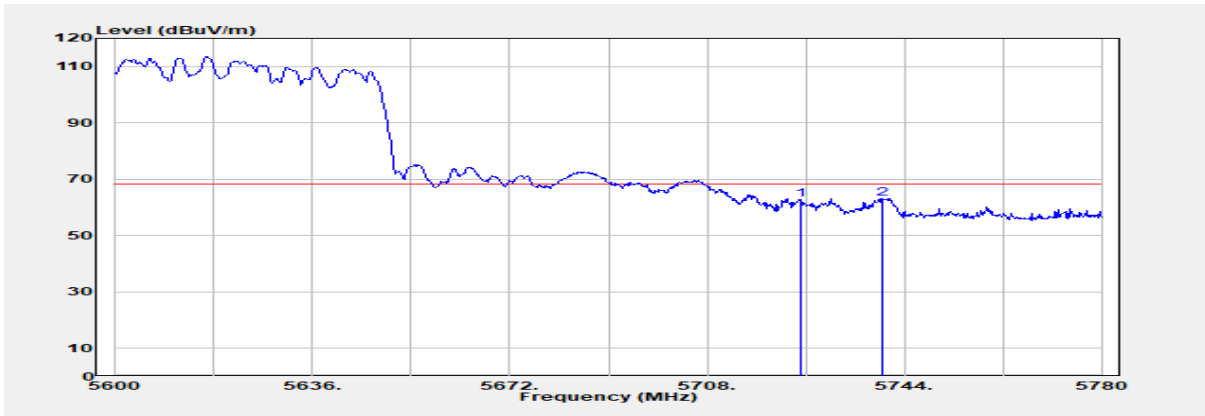

Freq. MHz	Detector Mode PK/QP/AV	Spectrum Reading Level dB μ V	Factor dB	Actual FS dB μ V/m	Limit @3m dB μ V/m	Margin dB
5725.000	Peak	57.05	5.57	62.62	68.20	-5.58
5740.040	Peak	57.53	5.58	63.11	68.20	-5.09

Unless otherwise stated the results shown in this test report refer only to the sample(s) tested and such sample(s) are retained for 90 days only.

除非另有說明，此報告結果僅對測試之樣品負責，同時此樣品僅保留90天。本報告未經本公司書面許可，不可部份複製。

This document is issued by the Company subject to its General Conditions of Service printed overleaf, available on request or accessible at <http://www.sgs.com.tw/Terms-and-Conditions> and for electronic format documents, subject to Terms and Conditions for Electronic Documents at <http://www.sgs.com.tw/Terms-and-Conditions>. Attention is drawn to the limitation of liability, indemnification and jurisdiction issues defined therein. Any holder of this document is advised that information contained hereon reflects the Company's findings at the time of its intervention only and within the limits of Client's instructions, if any. The Company's sole responsibility is to its Client and this document does not exonerate parties to a transaction from exercising all their rights and obligations under the transaction documents. This document cannot be reproduced except in full, without prior written approval of the Company. Any unauthorized alteration, forgery or falsification of the content or appearance of this document is unlawful and offenders may be prosecuted to the fullest extent of the law.

Report Number :TERF2308001923E2
 Operation Mode :802.11be80
 Test Frequency :5775 MHz
 Test Mode :Bandedge
 EUT Pol :E2 Plane

Test Site :SAC G Chamber
 Test Date :2023-10-18
 Temp./Humi. :19.7°C/63%
 Antenna Pol. :Vertical
 Engineer :Temo Chen

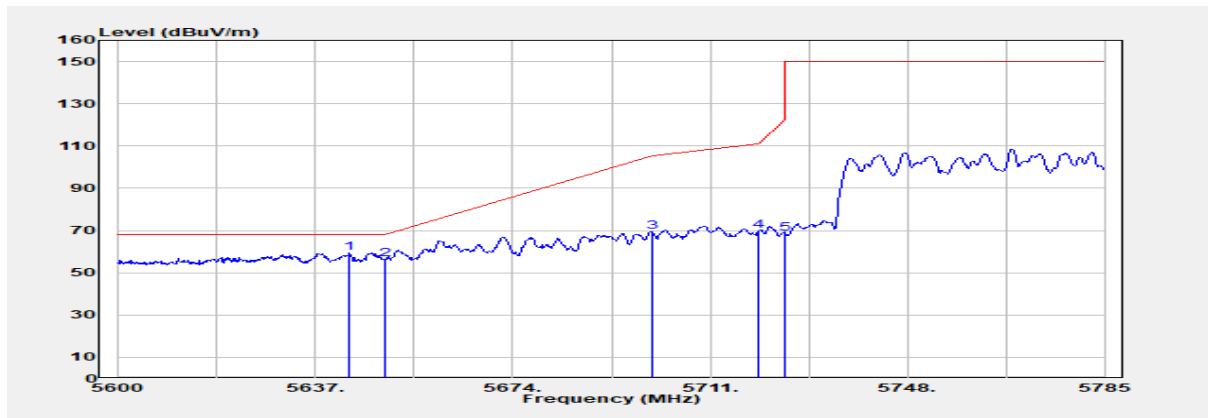

Freq. MHz	Detector Mode PK/QP/AV	Spectrum Reading Level dB μ V	Factor dB	Actual FS dB μ V/m	Limit @3m dB μ V/m	Margin dB
5643.290	Peak	54.88	4.65	59.53	68.20	-8.67
5650.000	Peak	51.52	4.76	56.27	68.20	-11.93
5700.000	Peak	63.93	5.56	69.49	105.20	-35.71
5720.000	Peak	64.15	5.57	69.72	110.80	-41.08
5725.000	Peak	63.06	5.57	68.64	122.20	-53.56

Unless otherwise stated the results shown in this test report refer only to the sample(s) tested and such sample(s) are retained for 90 days only.

除非另有說明，此報告結果僅對測試之樣品負責，同時此樣品僅保留90天。本報告未經本公司書面許可，不可部份複製。

This document is issued by the Company subject to its General Conditions of Service printed overleaf, available on request or accessible at <http://www.sgs.com.tw/Terms-and-Conditions> and for electronic format documents, subject to Terms and Conditions for Electronic Documents at <http://www.sgs.com.tw/Terms-and-Conditions>. Attention is drawn to the limitation of liability, indemnification and jurisdiction issues defined therein. Any holder of this document is advised that information contained hereon reflects the Company's findings at the time of its intervention only and within the limits of Client's instructions, if any. The Company's sole responsibility is to its Client and this document does not exonerate parties to a transaction from exercising all their rights and obligations under the transaction documents. This document cannot be reproduced except in full, without prior written approval of the Company. Any unauthorized alteration, forgery or falsification of the content or appearance of this document is unlawful and offenders may be prosecuted to the fullest extent of the law.

Report Number :TERF2308001923E2
 Operation Mode :802.11be80
 Test Frequency :5775 MHz
 Test Mode :Bandedge
 EUT Pol :E2 Plane

Test Site :SAC G Chamber
 Test Date :2023-10-18
 Temp./Humi. :19.7°C/63%
 Antenna Pol. :Horizontal
 Engineer :Temo Chen

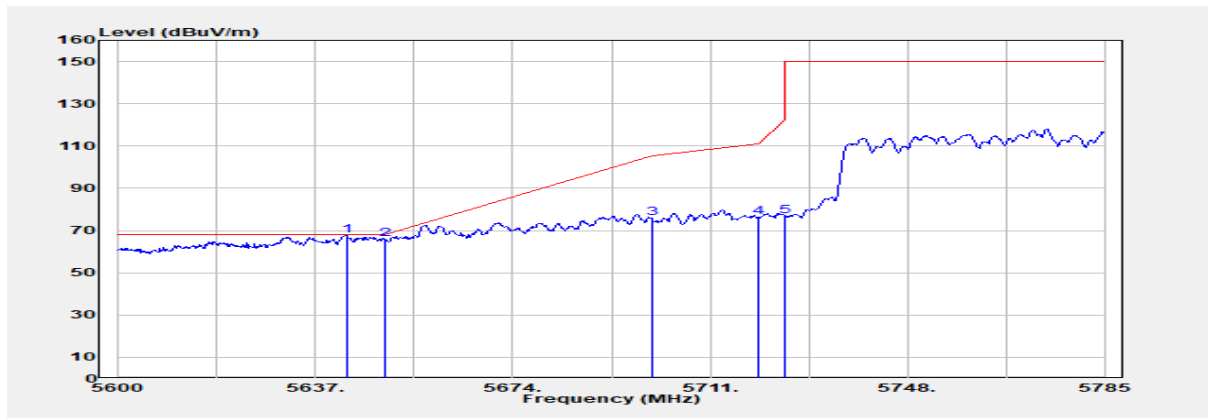

Freq. MHz	Detector Mode PK/QP/AV	Spectrum Reading Level dB μ V	Factor dB	Actual FS dB μ V/m	Limit @3m dB μ V/m	Margin dB
5642.735	Peak	63.21	4.64	67.85	68.20	-0.35
5650.000	Peak	61.17	4.76	65.92	68.20	-2.28
5700.000	Peak	70.14	5.56	75.70	105.20	-29.50
5720.000	Peak	70.67	5.57	76.24	110.80	-34.56
5725.000	Peak	71.11	5.57	76.69	122.20	-45.51

Unless otherwise stated the results shown in this test report refer only to the sample(s) tested and such sample(s) are retained for 90 days only.

除非另有說明，此報告結果僅對測試之樣品負責，同時此樣品僅保留90天。本報告未經本公司書面許可，不可部份複製。

This document is issued by the Company subject to its General Conditions of Service printed overleaf, available on request or accessible at <http://www.sgs.com.tw/Terms-and-Conditions>, and for electronic format documents, subject to Terms and Conditions for Electronic Documents at <http://www.sgs.com.tw/Terms-and-Conditions>. Attention is drawn to the limitation of liability, indemnification and jurisdiction issues defined therein. Any holder of this document is advised that information contained hereon reflects the Company's findings at the time of its intervention only and within the limits of Client's instructions, if any. The Company's sole responsibility is to its Client and this document does not exonerate parties to a transaction from exercising all their rights and obligations under the transaction documents. This document cannot be reproduced except in full, without prior written approval of the Company. Any unauthorized alteration, forgery or falsification of the content or appearance of this document is unlawful and offenders may be prosecuted to the fullest extent of the law.

Report Number :TERF2308001923E2
 Operation Mode :802.11be80
 Test Frequency :5775 MHz
 Test Mode :Bandedge
 EUT Pol :E2 Plane

Test Site :SAC G Chamber
 Test Date :2023-10-18
 Temp./Humi. :19.7°C/63%
 Antenna Pol. :Vertical
 Engineer :Temo Chen

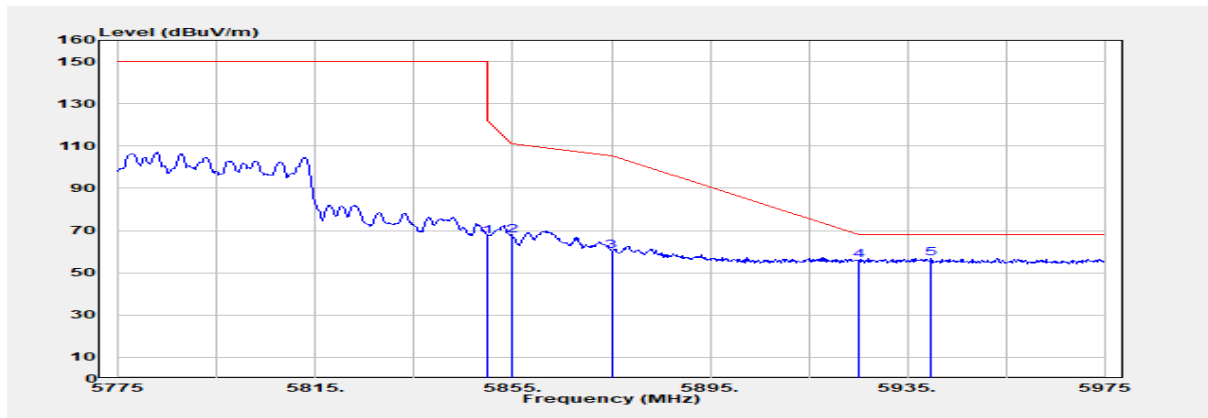

Freq. MHz	Detector Mode PK/QP/AV	Spectrum Reading Level dB μ V	Factor dB	Actual FS dB μ V/m	Limit @3m dB μ V/m	Margin dB
5850.000	Peak	61.64	5.66	67.30	122.20	-54.90
5855.000	Peak	62.01	5.68	67.70	110.80	-43.10
5875.000	Peak	54.29	5.78	60.07	105.20	-45.13
5925.000	Peak	50.36	5.66	56.01	68.20	-12.19
5939.800	Peak	51.39	5.51	56.90	68.20	-11.30

Unless otherwise stated the results shown in this test report refer only to the sample(s) tested and such sample(s) are retained for 90 days only.

除非另有說明，此報告結果僅對測試之樣品負責，同時此樣品僅保留90天。本報告未經本公司書面許可，不可部份複製。

This document is issued by the Company subject to its General Conditions of Service printed overleaf, available on request or accessible at <http://www.sgs.com.tw/Terms-and-Conditions>, and for electronic format documents, subject to Terms and Conditions for Electronic Documents at <http://www.sgs.com.tw/Terms-and-Conditions>. Attention is drawn to the limitation of liability, indemnification and jurisdiction issues defined therein. Any holder of this document is advised that information contained hereon reflects the Company's findings at the time of its intervention only and within the limits of Client's instructions, if any. The Company's sole responsibility is to its Client and this document does not exonerate parties to a transaction from exercising all their rights and obligations under the transaction documents. This document cannot be reproduced except in full, without prior written approval of the Company. Any unauthorized alteration, forgery or falsification of the content or appearance of this document is unlawful and offenders may be prosecuted to the fullest extent of the law.