

**ELECTROMAGNETIC EMISSIONS
COMPLIANCE REPORT**

Applicant: Askey Computer Corporation
10F, No. 119, Jiankang Rd., Zhonghe Dist., New Taipei City,
Taiwan

Manufacturer: Askey Computer Corporation
10F, No. 119, Jiankang Rd., Zhonghe Dist., New Taipei City,
Taiwan

Product Name: 5G NR Sub 6 WiFi 7 Router

Brand Name: Verizon

Model No.: ASK-NCM1100

Model Difference: N/A

Report Number: TERF2308001922E2

FCC ID H8N-ASK-NCM1100

Date of EUT Received: August 4, 2023

Date of Test: August 4, 2023~November 9, 2023

Issue Date: November 13, 2023

Approved By _____

Vito Pei

Vito Pei

We hereby certify that:

The above equipment was tested by SGS Taiwan Ltd. Central RF Lab The test data, data evaluation, test procedures, and equipment configurations shown in this report were made in accordance with the procedures given in ANSI C63.10:2013 and the energy emitted by the sample EUT comply with FCC rule part §15.247.

The results of this report relate only to the sample identified in this report.

Unless otherwise stated the results shown in this test report refer only to the sample(s) tested and such sample(s) are retained for 90 days only.
除非另有說明，此報告結果僅對測試之樣品負責，同時此樣品僅保留90天。本報告未經本公司書面許可，不可部份複製。

This document is issued by the Company subject to its General Conditions of Service printed overleaf, available on request or accessible at <http://www.sgs.com.tw/Terms-and-Conditions> and for electronic format documents, subject to Terms and Conditions for Electronic Documents at <http://www.sgs.com.tw/Terms-and-Conditions>. Attention is drawn to the limitation of liability, indemnification and jurisdiction issues defined therein. Any holder of this document is advised that information contained hereon reflects the Company's findings at the time of its intervention only and within the limits of Client's instructions, if any. The Company's sole responsibility is to its Client and this document does not exonerate parties to a transaction from exercising all their rights and obligations under the transaction documents. This document cannot be reproduced except in full, without prior written approval of the Company. Any unauthorized alteration, forgery or falsification of the content or appearance of this document is unlawful and offenders may be prosecuted to the fullest extent of the law.

Revision History

Report Number	Revision	Description	Issue Date	Revised By	Remark
TERF2308001922E2	00	Original.	November 13, 2023	Susan Lin	

Note:

- The remark "*" indicates modification of the report upon requests from certification body.

Unless otherwise stated the results shown in this test report refer only to the sample(s) tested and such sample(s) are retained for 90 days only.
 除非另有說明，此報告結果僅對測試之樣品負責，同時此樣品僅保留90天。本報告未經本公司書面許可，不可部份複製。

This document is issued by the Company subject to its General Conditions of Service printed overleaf, available on request or accessible at <http://www.sgs.com.tw/Terms-and-Conditions> and for electronic format documents, subject to Terms and Conditions for Electronic Documents at <http://www.sgs.com.tw/Terms-and-Conditions>. Attention is drawn to the limitation of liability, indemnification and jurisdiction issues defined therein. Any holder of this document is advised that information contained hereon reflects the Company's findings at the time of its intervention only and within the limits of Client's instructions, if any. The Company's sole responsibility is to its Client and this document does not exonerate parties to a transaction from exercising all their rights and obligations under the transaction documents. This document cannot be reproduced except in full, without prior written approval of the Company. Any unauthorized alteration, forgery or falsification of the content or appearance of this document is unlawful and offenders may be prosecuted to the fullest extent of the law.

Table of Contents

1	GENERAL INFORMATION.....	4
2	SYSTEM TEST CONFIGURATION.....	7
3	SUMMARY OF TEST RESULTS	10
4	DESCRIPTION OF TEST MODES	11
5	MEASUREMENT UNCERTAINTY	15
6	MEASUREMENT EQUIPMENT USED	16
7	CONDUCTED EMISSION TEST	18
8	PEAK OUTPUT POWER MEASUREMENT	22
9	EMISSION BANDWIDTH MEASUREMENT	30
10	CONDUCTED BAND EDGES AND SPURIOUS EMISSION MEASUREMENT	47
11	RADIATED BANEDGE AND SPURIOUS EMISSION MEASUREMENT	85
12	POWER SPECTRAL DENSITY	197
13	ANTENNA REQUIREMENT.....	213

Unless otherwise stated the results shown in this test report refer only to the sample(s) tested and such sample(s) are retained for 90 days only.
 除非另有說明，此報告結果僅對測試之樣品負責，同時此樣品僅保留90天。本報告未經本公司書面許可，不可部份複製。

This document is issued by the Company subject to its General Conditions of Service printed overleaf, available on request or accessible at <http://www.sgs.com.tw/Terms-and-Conditions> and for electronic format documents, subject to Terms and Conditions for Electronic Documents at <http://www.sgs.com.tw/Terms-and-Conditions>. Attention is drawn to the limitation of liability, indemnification and jurisdiction issues defined therein. Any holder of this document is advised that information contained hereon reflects the Company's findings at the time of its intervention only and within the limits of Client's instructions, if any. The Company's sole responsibility is to its Client and this document does not exonerate parties to a transaction from exercising all their rights and obligations under the transaction documents. This document cannot be reproduced except in full, without prior written approval of the Company. Any unauthorized alteration, forgery or falsification of the content or appearance of this document is unlawful and offenders may be prosecuted to the fullest extent of the law.

1 GENERAL INFORMATION

1.1 Product Description

Product Name:	5G NR Sub 6 WiFi 7 Router
Brand Name:	Verizon
Model No.:	ASK-NCM1100
Model Difference:	N/A
Hardware Version:	Rev4
Firmware Version:	SDK 2.0.6
EUT Series No.:	ACD33200170
Power Supply:	12V
Test Software (Name/Version):	MT7990 QA 0.0.2.99

1.2 RF Specification

Mode: CDD

WLAN 2.4GHz

Wi-Fi	Frequency Range	Channels	Rated Power (dBm)	Modulation Technology
			Avg	
802.11b	2412~2462	11	29.94	DSSS
802.11g	2412~2462	11	29.99	OFDM
802.11n20	2412~2462	11	29.87	OFDM
802.11n40	2422~2452	7	29.86	OFDM
802.11be20	2412~2462	11	29.81	OFDMA
802.11be40	2422~2452	7	29.89	OFDMA
Modulation type:		CCK, DQPSK, DBPSK for DSSS		
		64QAM, 16QAM, QPSK, BPSK for OFDM		
		4096 QAM, 1024 QAM, 256 QAM , 64QAM, 16QAM, QPSK, BPSK for OFDMA		
Data Rate:		802.11 b: 1/2/5.5/11 Mbps		
		802.11 g: 6/9/12/18/24/36/48/54 Mbps		
		802.11 n_20MHz:up to 288.8Mbps		
		802.11 n_40MHz:up to 600Mbps		
		802.11 ax_20MHz:up to 573.6Mbps		
		802.11 ax_40MHz:up to 1147.2Mbps		
		802.11 be_20MHz:up to 688.2Mbps		
		802.11 be_40MHz:up to 1376.5Mbps		

Unless otherwise stated the results shown in this test report refer only to the sample(s) tested and such sample(s) are retained for 90 days only.

除非另有說明，此報告結果僅對測試之樣品負責，同時此樣品僅保留90天。本報告未經本公司書面許可，不可部份複製。

This document is issued by the Company subject to its General Conditions of Service printed overleaf, available on request or accessible at <http://www.sgs.com.tw/Terms-and-Conditions>, and for electronic format documents, subject to Terms and Conditions for Electronic Documents at <http://www.sgs.com.tw/Terms-and-Conditions>. Attention is drawn to the limitation of liability, indemnification and jurisdiction issues defined therein. Any holder of this document is advised that information contained hereon reflects the Company's findings at the time of its intervention only and within the limits of Client's instructions, if any. The Company's sole responsibility is to its Client and this document does not exonerate parties to a transaction from exercising all their rights and obligations under the transaction documents. This document cannot be reproduced except in full, without prior written approval of the Company. Any unauthorized alteration, forgery or falsification of the content or appearance of this document is unlawful and offenders may be prosecuted to the fullest extent of the law.

Mode: Beamforming

WLAN 2.4GHz

Wi-Fi	Frequency Range	Channels	Rated Power (dBm)	Modulation Technology
			Avg.	
802.11n20	2412~2462	11	29.65	OFDM
802.11n40	2422~2452	7	29.84	OFDM
802.11be20	2412~2462	11	29.76	OFDMA
802.11be40	2422~2452	7	29.60	OFDMA
Modulation type:		64QAM, 16QAM, QPSK, BPSK for OFDM		
		4096 QAM, 1024 QAM, 256 QAM , 64QAM, 16QAM, QPSK, BPSK for OFDMA		
Data Rate:		802.11 n_20MHz:up to 288.8Mbps		
		802.11 n_40MHz:up to 600Mbps		
		802.11 ax_20MHz:up to 573.6Mbps		
		802.11 ax_40MHz:up to 1147.2Mbps		
		802.11 be_20MHz:up to 688.2Mbps		
		802.11 be_40MHz:up to 1376.5Mbps		

1.3 Antenna Designation

Antenna Type	Antenna No.	Freq. (MHz)	Peak Antenna Gain (dBi)	Directional Gain (dBi)
PCB	Antenna 11	2412~2462	2.66	5.81
	Antenna 12	2412~2462	4.49	5.81
	Antenna 13	2412~2462	3.49	5.81
	Antenna 14	2412~2462	3.24	5.81

Note:

1. Pre-scanned was done on the above antennas, measurements were demonstrated by using the antenna with the highest gain as the worst case scenarios.
2. Antenna information is provided by the applicant.

Unless otherwise stated the results shown in this test report refer only to the sample(s) tested and such sample(s) are retained for 90 days only.

除非另有說明，此報告結果僅對測試之樣品負責，同時此樣品僅保留90天。本報告未經本公司書面許可，不可部份複製。

This document is issued by the Company subject to its General Conditions of Service printed overleaf, available on request or accessible at <http://www.sgs.com.tw/Terms-and-Conditions> and for electronic format documents, subject to Terms and Conditions for Electronic Documents at <http://www.sgs.com.tw/Terms-and-Conditions>. Attention is drawn to the limitation of liability, indemnification and jurisdiction issues defined therein. Any holder of this document is advised that information contained hereon reflects the Company's findings at the time of its intervention only and within the limits of Client's instructions, if any. The Company's sole responsibility is to its Client and this document does not exonerate parties to a transaction from exercising all their rights and obligations under the transaction documents. This document cannot be reproduced except in full, without prior written approval of the Company. Any unauthorized alteration, forgery or falsification of the content or appearance of this document is unlawful and offenders may be prosecuted to the fullest extent of the law.

1.4 Test Methodology of Applied Standards

FCC Part 15, Subpart C §15.247
 FCC KDB 558074 D01 15.247 Meas Guidance v05r02
 FCC KDB 662911 D01 Multiple Transmitter Output v02r01
 ANSI C63.10:2013

1.5 Test Facility

Laboratory	Test Site Address	Test Site Name	FCC Designation number	IC CAB identifier
SGS Taiwan Ltd. Central RF Lab. (TAF code 3702)	No.134, Wu Kung Road, New Taipei Industrial Park, Wuku District, New Taipei City, Taiwan.	SAC 1	TW0027	
		SAC 2		
		SAC 3		
		Conduction 1		
		Conducted 1		
		Conducted 2		
		Conducted 3		
		Conducted 4		
		Conducted 5		
	Conducted 6			
	No.2, Keji 1st Rd., Guishan District, Taoyuan City, Taiwan 333	Conduction C	TW0028	
		SAC C		
		SAC D		
		SAC G		
		Conducted A		
		Conducted B		
		Conducted C		
		Conducted D		
		Conducted E		
Conducted F				
Conducted G				

Note: Test site name is remarked on the equipment list in each section of this report as an indication where measurements occurred in specific test site and address.

1.6 Special Accessories

There are no special accessories used while test was conducted.

1.7 Equipment Modifications

There was no modification incorporated into the EUT.

Unless otherwise stated the results shown in this test report refer only to the sample(s) tested and such sample(s) are retained for 90 days only.
 除非另有說明，此報告結果僅對測試之樣品負責，同時此樣品僅保留90天。本報告未經本公司書面許可，不可部份複製。

This document is issued by the Company subject to its General Conditions of Service printed overleaf, available on request or accessible at <http://www.sgs.com.tw/Terms-and-Conditions> and for electronic format documents, subject to Terms and Conditions for Electronic Documents at <http://www.sgs.com.tw/Terms-and-Conditions>. Attention is drawn to the limitation of liability, indemnification and jurisdiction issues defined therein. Any holder of this document is advised that information contained hereon reflects the Company's findings at the time of its intervention only and within the limits of Client's instructions, if any. The Company's sole responsibility is to its Client and this document does not exonerate parties to a transaction from exercising all their rights and obligations under the transaction documents. This document cannot be reproduced except in full, without prior written approval of the Company. Any unauthorized alteration, forgery or falsification of the content or appearance of this document is unlawful and offenders may be prosecuted to the fullest extent of the law.

2 SYSTEM TEST CONFIGURATION

2.1 EUT Configuration

The EUT configuration for testing is installed on RF field strength measurement to meet the Commissions requirement and operating in a manner which intends to maximize its emission characteristics in a continuous normal application.

2.2 EUT Exercise

An engineering test mode (software/firmware) that applicant provided was utilized to manipulate the EUT into transmit, selection of the test channel, and modulation scheme.

2.3 Test Procedure

2.3.1 Conducted Emissions

The EUT is a placed on a table which is 0.8 m above ground plane. Conducted emissions from the EUT measured in the frequency range between 0.15 MHz and 30MHz. The CISPR Quasi-Peak and Average detector mode is employed. The two LISNs provide 50uH/50 ohm of coupling impedance for the measuring instrument. Both lines of the power mains connected to the EUT were checked for maximum conducted interference.

2.3.2 Conducted Test (RF)

The active antenna port of the unlicensed wireless device is connected to the spectrum analyzer with attenuator to protect the instrumentation. If a second antenna port is available, it is tested at one operating frequency, with other port(s) appropriately terminated, to verify it has similar output characteristics as the fully tested port.

2.3.3 Radiated Emissions

The EUT is a placed on a turn table. For emissions testing at or below 1 GHz, the table height shall be 0.8 m above the reference ground plane. For emission measurements above 1 GHz, the table height shall be 1.5 m. The turn table shall rotate 360 degrees to determine the position of maximum emission level. EUT is set 3m away from the receiving antenna which varied from 1m to 4m to find out the highest emission. And also, each emission was to be maximized by changing the polarization of receiving antenna both horizontal and vertical. In order to find out the max. emission, the relative positions of this transmitter (EUT) was rotated through three orthogonal axes and measurement procedures for electric field radiated emissions above 1 GHz the EUT measurement is to be made "while keeping the antenna in the 'cone of radiation' from that area and pointed at the area both in azimuth and elevation, with polarization oriented for maximum response." is still within the 3dB illumination BW of the measurement antenna.

Unless otherwise stated the results shown in this test report refer only to the sample(s) tested and such sample(s) are retained for 90 days only.
除非另有說明，此報告結果僅對測試之樣品負責，同時此樣品僅保留90天。本報告未經本公司書面許可，不可部份複製。

This document is issued by the Company subject to its General Conditions of Service printed overleaf, available on request or accessible at <http://www.sgs.com.tw/Terms-and-Conditions> and for electronic format documents, subject to Terms and Conditions for Electronic Documents at <http://www.sgs.com.tw/Terms-and-Conditions>. Attention is drawn to the limitation of liability, indemnification and jurisdiction issues defined therein. Any holder of this document is advised that information contained hereon reflects the Company's findings at the time of its intervention only and within the limits of Client's instructions, if any. The Company's sole responsibility is to its Client and this document does not exonerate parties to a transaction from exercising all their rights and obligations under the transaction documents. This document cannot be reproduced except in full, without prior written approval of the Company. Any unauthorized alteration, forgery or falsification of the content or appearance of this document is unlawful and offenders may be prosecuted to the fullest extent of the law.

2.4 Measurement Results Explanation Example

2.4.1 Radiated Emission Test Sites For Measurements From 9 kHz To 30 MHz

Radiated emission below 30MHz is measured in a 9m*6m*6m semi-anechoic chamber, the measurements correspond to those obtained at an open-field test site.

There is a comparison data of both open-field test site and semi-Anechoic chamber, and the result came out very similar.

2.4.2 For all conducted test items:

The offset level is set in the spectrum analyzer to compensate the RF cable loss and attenuation factor between EUT conducted port and spectrum analyzer. With the offset compensation, the spectrum analyzer reading level is exactly EUT RF output level.

2.5 Test Configuration

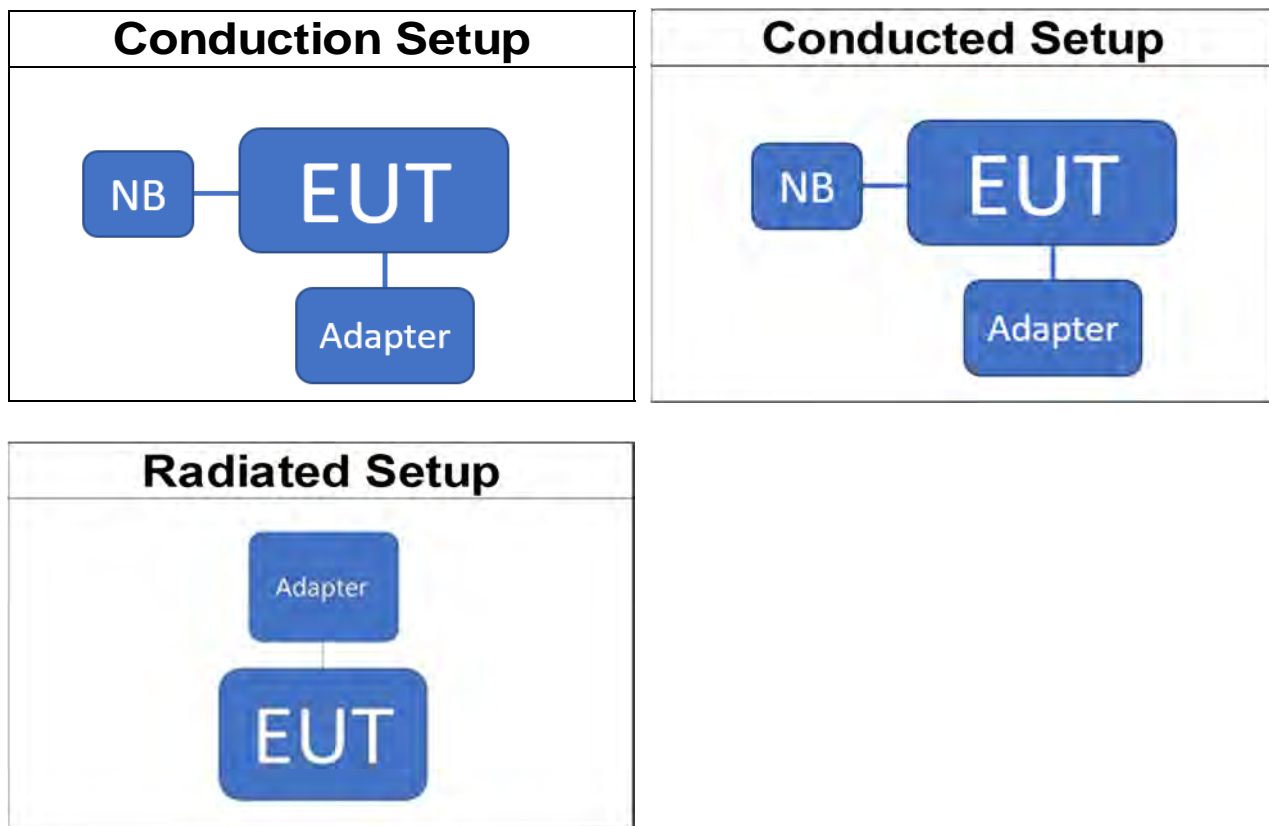

Unless otherwise stated the results shown in this test report refer only to the sample(s) tested and such sample(s) are retained for 90 days only.

除非另有說明，此報告結果僅對測試之樣品負責，同時此樣品僅保留90天。本報告未經本公司書面許可，不可部份複製。

This document is issued by the Company subject to its General Conditions of Service printed overleaf, available on request or accessible at <http://www.sgs.com.tw/Terms-and-Conditions> and for electronic format documents, subject to Terms and Conditions for Electronic Documents at <http://www.sgs.com.tw/Terms-and-Conditions>. Attention is drawn to the limitation of liability, indemnification and jurisdiction issues defined therein. Any holder of this document is advised that information contained hereon reflects the Company's findings at the time of its intervention only and within the limits of Client's instructions, if any. The Company's sole responsibility is to its Client and this document does not exonerate parties to a transaction from exercising all their rights and obligations under the transaction documents. This document cannot be reproduced except in full, without prior written approval of the Company. Any unauthorized alteration, forgery or falsification of the content or appearance of this document is unlawful and offenders may be prosecuted to the fullest extent of the law.

2.6 Control Unit(s)

AC Power-Line Conducted Emission Test Site: Conduction C					
EQUIPMENT TYPE	MFR	MODEL NUMBER	SERIAL NUMBER	LAST CAL.	CAL DUE.
Notebook	Lenovo	T470	P0001293	N/A	N/A

Conducted Emission Test Site: Conducted F					
EQUIPMENT TYPE	MFR	MODEL NUMBER	SERIAL NUMBER	LAST CAL.	CAL DUE.
Notebook	Lenovo	L480	P0002332	N/A	N/A

Radiated Emission Test Site: SAC G					
EQUIPMENT TYPE	MFR	MODEL NUMBER	SERIAL NUMBER	LAST CAL.	CAL DUE.
Adapter	MASS POWER	S065-1B120500VU	N/A	N/A	N/A
Notebook	Lenovo	T440p	P0000665	N/A	N/A

Unless otherwise stated the results shown in this test report refer only to the sample(s) tested and such sample(s) are retained for 90 days only.

除非另有說明，此報告結果僅對測試之樣品負責，同時此樣品僅保留90天。本報告未經本公司書面許可，不可部份複製。

This document is issued by the Company subject to its General Conditions of Service printed overleaf, available on request or accessible at <http://www.sgs.com.tw/Terms-and-Conditions> and for electronic format documents, subject to Terms and Conditions for Electronic Documents at <http://www.sgs.com.tw/Terms-and-Conditions>. Attention is drawn to the limitation of liability, indemnification and jurisdiction issues defined therein. Any holder of this document is advised that information contained hereon reflects the Company's findings at the time of its intervention only and within the limits of Client's instructions, if any. The Company's sole responsibility is to its Client and this document does not exonerate parties to a transaction from exercising all their rights and obligations under the transaction documents. This document cannot be reproduced except in full, without prior written approval of the Company. Any unauthorized alteration, forgery or falsification of the content or appearance of this document is unlawful and offenders may be prosecuted to the fullest extent of the law.

3 SUMMARY OF TEST RESULTS

FCC Rules	Description Of Test	Result
§15.207(a)	AC Power Line Conducted Emission	Compliant
§15.247(b) (3)	Peak Output Power	Compliant
§15.247(a)(2)	Emission Bandwidth	Compliant
§15.205 §15.209 §15.247(d)	Radiated & Conducted Band Edge and Spurious Emission	Compliant
§15.247(e)	Power Spectral Density	Compliant
§15.203	Antenna Requirement	Compliant

Unless otherwise stated the results shown in this test report refer only to the sample(s) tested and such sample(s) are retained for 90 days only.
 除非另有說明，此報告結果僅對測試之樣品負責，同時此樣品僅保留90天。本報告未經本公司書面許可，不可部份複製。

This document is issued by the Company subject to its General Conditions of Service printed overleaf, available on request or accessible at <http://www.sgs.com.tw/Terms-and-Conditions> and for electronic format documents, subject to Terms and Conditions for Electronic Documents at <http://www.sgs.com.tw/Terms-and-Conditions>. Attention is drawn to the limitation of liability, indemnification and jurisdiction issues defined therein. Any holder of this document is advised that information contained hereon reflects the Company's findings at the time of its intervention only and within the limits of Client's instructions, if any. The Company's sole responsibility is to its Client and this document does not exonerate parties to a transaction from exercising all their rights and obligations under the transaction documents. This document cannot be reproduced except in full, without prior written approval of the Company. Any unauthorized alteration, forgery or falsification of the content or appearance of this document is unlawful and offenders may be prosecuted to the fullest extent of the law.

SGS Taiwan Ltd. No.134,Wu Kung Road, New Taipei Industrial Park, Wuku District, New Taipei City, Taiwan/新北市五股區新北產業園區五工路 134 號

4 DESCRIPTION OF TEST MODES

4.1 Operating Frequencies

2400~2483.5 MHz

20MHz		40MHz	
CH	Freq. (MHz)	CH	Freq. (MHz)
1	2412	3	2422
2	2417	4	2427
3	2422	5	2432
4	2427	6	2437
5	2432	7	2442
6	2437	8	2447
7	2442	9	2452
8	2447		
9	2452		
10	2457		
11	2462		

Unless otherwise stated the results shown in this test report refer only to the sample(s) tested and such sample(s) are retained for 90 days only.

除非另有說明，此報告結果僅對測試之樣品負責，同時此樣品僅保留90天。本報告未經本公司書面許可，不可部份複製。

This document is issued by the Company subject to its General Conditions of Service printed overleaf, available on request or accessible at <http://www.sgs.com.tw/Terms-and-Conditions> and for electronic format documents, subject to Terms and Conditions for Electronic Documents at <http://www.sgs.com.tw/Terms-and-Conditions>. Attention is drawn to the limitation of liability, indemnification and jurisdiction issues defined therein. Any holder of this document is advised that information contained hereon reflects the Company's findings at the time of its intervention only and within the limits of Client's instructions, if any. The Company's sole responsibility is to its Client and this document does not exonerate parties to a transaction from exercising all their rights and obligations under the transaction documents. This document cannot be reproduced except in full, without prior written approval of the Company. Any unauthorized alteration, forgery or falsification of the content or appearance of this document is unlawful and offenders may be prosecuted to the fullest extent of the law.

4.2 The Worst Test Modes and Channel Details

1. The EUT has been tested under operating condition.
2. Test program used to control the EUT for staying in continuous transmitting and receiving mode is programmed.
3. Investigation has been done on all the possible configurations for searching the worst case.

The given UE is pre-scanned among below modes.

Mode: CDD

Modulation		Transmission Chain								Single Transmission Spatial		Multi Transmission Spatial	
v	802.11 b	v	Ch0	v	Ch1	v	Ch2	v	Ch3		1TX	v	4TX
v	802.11 g	v	Ch0	v	Ch1	v	Ch2	v	Ch3		1TX	v	4TX
v	802.11 n	v	Ch0	v	Ch1	v	Ch2	v	Ch3		1TX	v	4TX
	802.11 ac		Ch0		Ch1		Ch2		Ch3		1TX		4TX
v	802.11 ax	v	Ch0	v	Ch1	v	Ch2	v	Ch3		1TX	v	4TX
v	802.11 be	v	Ch0	v	Ch1	v	Ch2	v	Ch3		1TX	v	4TX

Mode: Beamforming

Modulation		Transmission Chain								Single Transmission Spatial		Multi Transmission Spatial	
	802.11 b		Ch0		Ch1		Ch2		Ch3		1TX		4TX
	802.11 g		Ch0		Ch1		Ch2		Ch3		1TX		4TX
v	802.11 n	v	Ch0	v	Ch1	v	Ch2	v	Ch3		1TX	v	4TX
	802.11 ac		Ch0		Ch1		Ch2		Ch3		1TX		4TX
v	802.11 ax	v	Ch0	v	Ch1	v	Ch2	v	Ch3		1TX	v	4TX
v	802.11 be	v	Ch0	v	Ch1	v	Ch2	v	Ch3		1TX	v	4TX

4. Therefore, below summary is the modes of test configuration that yield the highest reading and generate the highest emission chosen to carry out the relevantly mandatory test items.

Unless otherwise stated the results shown in this test report refer only to the sample(s) tested and such sample(s) are retained for 90 days only.

除非另有說明，此報告結果僅對測試之樣品負責，同時此樣品僅保留90天。本報告未經本公司書面許可，不可部份複製。
This document is issued by the Company subject to its General Conditions of Service printed overleaf, available on request or accessible at <http://www.sgs.com.tw/Terms-and-Conditions> and for electronic format documents, subject to Terms and Conditions for Electronic Documents at <http://www.sgs.com.tw/Terms-and-Conditions>. Attention is drawn to the limitation of liability, indemnification and jurisdiction issues defined therein. Any holder of this document is advised that information contained hereon reflects the Company's findings at the time of its intervention only and within the limits of Client's instructions, if any. The Company's sole responsibility is to its Client and this document does not exonerate parties to a transaction from exercising all their rights and obligations under the transaction documents. This document cannot be reproduced except in full, without prior written approval of the Company. Any unauthorized alteration, forgery or falsification of the content or appearance of this document is unlawful and offenders may be prosecuted to the fullest extent of the law.

Mode: CDD

Conducted					
MODE	AVAILABLE CHANNEL	TESTED CHANNEL	MODULATION	DATA RATE (Mbps)	ANTENNA PORT
802.11b	1 to 11	1,6,11	DSSS	1	4TX
802.11g	1 to 11	1,6,11	OFDM	6	4TX
802.11n (HT20)	1 to 11	1,6,11	OFDM	MCS0	4TX
802.11n (HT40)	3 to 9	3,6,9	OFDM	MCS0	4TX
802.11be (EHT20)	1 to 11	1,6,11	OFDMA	MCS0	4TX
802.11be (EHT40)	3 to 9	3,6,9	OFDMA	MCS0	4TX

TRANSMIT RADIATED EMISSION TEST (BELOW 1 GHz)					
MODE	AVAILABLE CHANNEL	TESTED CHANNEL	MODULATION	DATA RATE (Mbps)	ANTENNA PORT
802.11g	1 to 11	6	OFDM	6	4TX
802.11be (EHT40)	3 to 9	6	OFDMA	MCS0	4TX

TRANSMIT RADIATED EMISSION TEST (ABOVE 1 GHz)					
MODE	AVAILABLE CHANNEL	TESTED CHANNEL	MODULATION	DATA RATE (Mbps)	ANTENNA PORT
802.11b	1 to 11	1,6,11	DSSS	1	4TX
802.11g	1 to 11	1,6,11	OFDM	6	4TX
802.11n (HT20)	1 to 11	1,6,11	OFDM	MCS0	4TX
802.11n (HT40)	3 to 9	3,6,9	OFDM	MCS0	4TX
802.11be (EHT20)	1 to 11	1,6,11	OFDMA	MCS0	4TX
802.11be (EHT40)	3 to 9	3,6,9	OFDMA	MCS0	4TX

Note:

The field strength of radiated emission was measured as the EUT positioned in different orthogonal planes (E1/E2/H) based on actual usage of the EUT to pre-scan the emissions for determining the worst case scenario.

Unless otherwise stated the results shown in this test report refer only to the sample(s) tested and such sample(s) are retained for 90 days only.
 除非另有說明，此報告結果僅對測試之樣品負責，同時此樣品僅保留90天。本報告未經本公司書面許可，不可部份複製。

This document is issued by the Company subject to its General Conditions of Service printed overleaf, available on request or accessible at <http://www.sgs.com.tw/Terms-and-Conditions> and for electronic format documents, subject to Terms and Conditions for Electronic Documents at <http://www.sgs.com.tw/Terms-and-Conditions>. Attention is drawn to the limitation of liability, indemnification and jurisdiction issues defined therein. Any holder of this document is advised that information contained hereon reflects the Company's findings at the time of its intervention only and within the limits of Client's instructions, if any. The Company's sole responsibility is to its Client and this document does not exonerate parties to a transaction from exercising all their rights and obligations under the transaction documents. This document cannot be reproduced except in full, without prior written approval of the Company. Any unauthorized alteration, forgery or falsification of the content or appearance of this document is unlawful and offenders may be prosecuted to the fullest extent of the law.

Mode: Beamforming

Conducted					
MODE	AVAILABLE CHANNEL	TESTED CHANNEL	MODULATION	DATA RATE (Mbps)	ANTENNA PORT
802.11n (HT20)	1 to 11	1,6,11	OFDM	MCS0	4TX
802.11n (HT40)	3 to 9	3,6,9	OFDM	MCS0	4TX
802.11be (EHT20)	1 to 11	1,6,11	OFDMA	MCS0	4TX
802.11be (EHT40)	3 to 9	3,6,9	OFDMA	MCS0	4TX

TRANSMIT RADIATED EMISSION TEST (BELOW 1 GHz)					
MODE	AVAILABLE CHANNEL	TESTED CHANNEL	MODULATION	DATA RATE (Mbps)	ANTENNA PORT
802.11n (HT20)	6	6	OFDM	MCS0	4TX
802.11be (EHT40)	6	6	OFDMA	MCS0	4TX

TRANSMIT RADIATED EMISSION TEST (ABOVE 1 GHz)					
MODE	AVAILABLE CHANNEL	TESTED CHANNEL	MODULATION	DATA RATE (Mbps)	ANTENNA PORT
802.11n (HT20)	1 to 11	1,6,11	OFDM	MCS0	4TX
802.11n (HT40)	3 to 9	3,6,9	OFDM	MCS0	4TX
802.11be (EHT20)	1 to 11	1,6,11	OFDMA	MCS0	4TX
802.11be (EHT40)	3 to 9	3,6,9	OFDMA	MCS0	4TX

Note:

The field strength of radiated emission was measured as the EUT positioned in different orthogonal planes (E1/E2/H) based on actual usage of the EUT to pre-scan the emissions for determining the worst case scenario.

Unless otherwise stated the results shown in this test report refer only to the sample(s) tested and such sample(s) are retained for 90 days only.
 除非另有說明，此報告結果僅對測試之樣品負責，同時此樣品僅保留90天。本報告未經本公司書面許可，不可部份複製。

This document is issued by the Company subject to its General Conditions of Service printed overleaf, available on request or accessible at <http://www.sgs.com.tw/Terms-and-Conditions> and for electronic format documents, subject to Terms and Conditions for Electronic Documents at <http://www.sgs.com.tw/Terms-and-Conditions>. Attention is drawn to the limitation of liability, indemnification and jurisdiction issues defined therein. Any holder of this document is advised that information contained hereon reflects the Company's findings at the time of its intervention only and within the limits of Client's instructions, if any. The Company's sole responsibility is to its Client and this document does not exonerate parties to a transaction from exercising all their rights and obligations under the transaction documents. This document cannot be reproduced except in full, without prior written approval of the Company. Any unauthorized alteration, forgery or falsification of the content or appearance of this document is unlawful and offenders may be prosecuted to the fullest extent of the law.

5 MEASUREMENT UNCERTAINTY

Test Items	Uncertainty
AC Power Line Conducted Emission	+/- 2.32 dB
Output Power measurement	+/- 1 dB
Emission Bandwidth	+/- 1.53 Hz
Undesignable radiated emission measurement	+/- 1.68 dB
Peak Power Density	+/- 2.16 dB
Temperature	+/- 0.7 °C
Humidity	+/- 3 %
DC / AC Power Source	+/- 1 %

Radiated Spurious Emission Measurement Uncertainty			
Polarization: Vertical	+/-	2.8 dB	9kHz~30MHz
	+/-	4.82 dB	30MHz - 1000MHz
	+/-	4.37 dB	1GHz - 18GHz
	+/-	4.21 dB	18GHz - 40GHz
Polarization: Horizontal	+/-	2.8 dB	9kHz~30MHz
	+/-	4.54 dB	30MHz - 1000MHz
	+/-	4.37 dB	1GHz - 18GHz
	+/-	4.21 dB	18GHz - 40GHz

Note:

1. This uncertainty represents an expanded uncertainty expressed at approximately the 95% confidence level using a coverage factor of k=2.
2. The conformity assessment statement in this report is based solely on the test results, measurement uncertainty is excluded.

Unless otherwise stated the results shown in this test report refer only to the sample(s) tested and such sample(s) are retained for 90 days only.
 除非另有說明，此報告結果僅對測試之樣品負責，同時此樣品僅保留90天。本報告未經本公司書面許可，不可部份複製。

This document is issued by the Company subject to its General Conditions of Service printed overleaf, available on request or accessible at <http://www.sgs.com.tw/Terms-and-Conditions> and for electronic format documents, subject to Terms and Conditions for Electronic Documents at <http://www.sgs.com.tw/Terms-and-Conditions>. Attention is drawn to the limitation of liability, indemnification and jurisdiction issues defined therein. Any holder of this document is advised that information contained hereon reflects the Company's findings at the time of its intervention only and within the limits of Client's instructions, if any. The Company's sole responsibility is to its Client and this document does not exonerate parties to a transaction from exercising all their rights and obligations under the transaction documents. This document cannot be reproduced except in full, without prior written approval of the Company. Any unauthorized alteration, forgery or falsification of the content or appearance of this document is unlawful and offenders may be prosecuted to the fullest extent of the law.

6 MEASUREMENT EQUIPMENT USED

6.1 Emission from AC power line

AC Power-Line Conducted Emission Test Site: Conduction C					
EQUIPMENT TYPE	MFR	MODEL NUMBER	SERIAL NUMBER	LAST CAL.	CAL DUE.
LISN	SCHWARZBECK Mess-Elektronik	NSLK8127	974	06/19/2023	06/18/2024
EMI Test Receiver	R&S	ESCI	101342	04/24/2023	04/23/2024
Coaxial Cable	EC Lab	RF-HY-CAB-250	RF-HY-CAB-250-01	03/27/2023	03/26/2024
Pulse Limiter	EC Lab	VTSD 9561F-N	485	03/27/2023	03/26/2024
Test Software	audix	e3	E3 20923 SGS Ver.9 (C)	N.C.R	N.C.R

6.2 Conducted Measurement

Conducted Emission Test Site: Conducted F					
EQUIPMENT TYPE	MFR	MODEL NUMBER	SERIAL NUMBER	LAST CAL.	CAL DUE.
Spectrum Analyzer	KEYSIGHT	N9010B	MY59071574	06/29/2023	06/28/2024
Power Meter	Anritsu	ML2496A	1326001	08/22/2023	08/21/2024
Power Sensor	Anritsu	MA2411B	1315048	08/22/2023	08/21/2024
Power Sensor	Anritsu	MA2411B	1315049	08/22/2023	08/21/2024
Power Meter	Anritsu	ML2496A	2138005	09/25/2023	09/24/2024
Power Sensor	Anritsu	MA2411B	1911395	09/25/2023	09/24/2024
Power Sensor	Anritsu	MA2411B	1911396	09/25/2023	09/24/2024
Test Software	SGS Taiwan	Radio Test Software	Ver.21	N.C.R	N.C.R
Attenuator	Marvelous	MVE2213-10	RF06	11/16/2022	11/15/2023
Attenuator	Woken	WATT-218FS-10	RF16	11/16/2022	11/15/2023
Attenuator	Woken	WATT-218FS-10	RF22	11/16/2022	11/15/2023
Attenuator	Woken	WATT-218FS-10	RF23	11/16/2022	11/15/2023
DC Block	PASTERNAK	PE8210	RF153	11/16/2022	11/15/2023
Coaxial Cables	Woken	00100A1F2A196C	RF53	11/16/2022	11/15/2023

Unless otherwise stated the results shown in this test report refer only to the sample(s) tested and such sample(s) are retained for 90 days only.

除非另有說明，此報告結果僅對測試之樣品負責，同時此樣品僅保留90天。本報告未經本公司書面許可，不可部份複製。

This document is issued by the Company subject to its General Conditions of Service printed overleaf, available on request or accessible at <http://www.sgs.com.tw/Terms-and-Conditions> and for electronic format documents, subject to Terms and Conditions for Electronic Documents at <http://www.sgs.com.tw/Terms-and-Conditions>. Attention is drawn to the limitation of liability, indemnification and jurisdiction issues defined therein. Any holder of this document is advised that information contained hereon reflects the Company's findings at the time of its intervention only and within the limits of Client's instructions, if any. The Company's sole responsibility is to its Client and this document does not exonerate parties to a transaction from exercising all their rights and obligations under the transaction documents. This document cannot be reproduced except in full, without prior written approval of the Company. Any unauthorized alteration, forgery or falsification of the content or appearance of this document is unlawful and offenders may be prosecuted to the fullest extent of the law.

6.3 Radiated Measurement

Radiated Emission Test Site: SAC G					
EQUIPMENT TYPE	MFR	MODEL NUMBER	SERIAL NUMBER	LAST CAL.	CAL DUE.
Broadband Antenna	SCHWARZBECK	VULB 9168	1206	01/17/2023	01/16/2024
Horn Antenna	RF SPIN	DRH18-E	210105A18E	04/18/2023	04/17/2024
Horn Antenna	Schwarzbeck	BBHA9170	184	12/30/2022	12/29/2023
Loop Antenna	ETS.LINDGREN	6502	14303	05/23/2023	05/22/2024
3m Site NSA	SGS	966 chamber G	N/A	03/30/2023	03/29/2024
Spectrum Analyzer	KEYSIGHT	N9010A	MY51440113	07/17/2023	07/16/2024
Pre-Amplifier	EMC Instruments	EMC18405SEE	980881	10/27/2022	10/26/2023
Pre-Amplifier	EMC Instruments	EMC18405SEE	980881	10/25/2023	2024/1024
Pre-Amplifier	EMC Instruments	EMC330N	980781	03/15/2023	03/14/2024
Pre-Amplifier	EMC Instruments	EMC118A45SE	980815	03/15/2023	03/14/2024
Coaxial Cable	EMC Instruments	EMCCFD400-NM-NM-8000-5000-2000	210216 、 210217 、 210218	03/15/2023	03/14/2024
Coaxial Cable	EMC Instruments	EMC104-SM-SM-8000-5000-5000	210219 、 210220 、 210221	03/15/2023	03/14/2024

NOTE: N.C.R refers to Not Calibrated Required.

Unless otherwise stated the results shown in this test report refer only to the sample(s) tested and such sample(s) are retained for 90 days only.

除非另有說明，此報告結果僅對測試之樣品負責，同時此樣品僅保留90天。本報告未經本公司書面許可，不可部份複製。

This document is issued by the Company subject to its General Conditions of Service printed overleaf, available on request or accessible at <http://www.sgs.com.tw/Terms-and-Conditions> and for electronic format documents, subject to Terms and Conditions for Electronic Documents at <http://www.sgs.com.tw/Terms-and-Conditions>. Attention is drawn to the limitation of liability, indemnification and jurisdiction issues defined therein. Any holder of this document is advised that information contained hereon reflects the Company's findings at the time of its intervention only and within the limits of Client's instructions, if any. The Company's sole responsibility is to its Client and this document does not exonerate parties to a transaction from exercising all their rights and obligations under the transaction documents. This document cannot be reproduced except in full, without prior written approval of the Company. Any unauthorized alteration, forgery or falsification of the content or appearance of this document is unlawful and offenders may be prosecuted to the fullest extent of the law.

7 CONDUCTED EMISSION TEST

7.1 Standard Applicable

Frequency range within 150kHz to 30MHz shall not exceed the Limit table as below.

Frequency range MHz	Limits (dBuV)	
	Quasi-peak	Average
0.15 to 0.50	66 to 56	56 to 46
0.50 to 5	56	46
5 to 30	60	50

Note

- The lower limit shall apply at the transition frequencies
- The limit decreases linearly with the logarithm of the frequency in the range 0.15 MHz to 0.50 MHz.

7.2 EUT Setup:

- The conducted emission tests were performed in the test site, using the setup in accordance with the ANSI C63.10:2013.
- The AC/DC Power adaptor of EUT was plug-in LISN. The EUT was placed flushed with the rear of the table.
- The LISN was connected with 120Vac/60Hz power source.

7.3 Test Setup

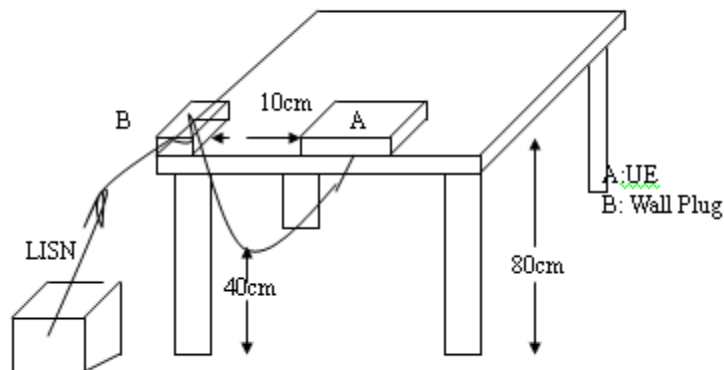

Unless otherwise stated the results shown in this test report refer only to the sample(s) tested and such sample(s) are retained for 90 days only.

除非另有說明，此報告結果僅對測試之樣品負責，同時此樣品僅保留90天。本報告未經本公司書面許可，不可部份複製。

This document is issued by the Company subject to its General Conditions of Service printed overleaf, available on request or accessible at <http://www.sgs.com.tw/Terms-and-Conditions> and for electronic format documents, subject to Terms and Conditions for Electronic Documents at <http://www.sgs.com.tw/Terms-and-Conditions>. Attention is drawn to the limitation of liability, indemnification and jurisdiction issues defined therein. Any holder of this document is advised that information contained hereon reflects the Company's findings at the time of its intervention only and within the limits of Client's instructions, if any. The Company's sole responsibility is to its Client and this document does not exonerate parties to a transaction from exercising all their rights and obligations under the transaction documents. This document cannot be reproduced except in full, without prior written approval of the Company. Any unauthorized alteration, forgery or falsification of the content or appearance of this document is unlawful and offenders may be prosecuted to the fullest extent of the law.

7.4 Measurement Procedure

1. The EUT was placed on a table which is 0.8m above ground plane.
2. Maximum procedure was performed on the six highest emissions to ensure EUT compliance.
3. Repeat above procedures until all phases of power being supplied by given UE are completed

7.5 Measurement Result

Note: Refer to next page for measurement data and plots.

Note2: The * reveals the worst-case results that closest to the limit.

Unless otherwise stated the results shown in this test report refer only to the sample(s) tested and such sample(s) are retained for 90 days only.
除非另有說明，此報告結果僅對測試之樣品負責，同時此樣品僅保留90天。本報告未經本公司書面許可，不可部份複製。

This document is issued by the Company subject to its General Conditions of Service printed overleaf, available on request or accessible at <http://www.sgs.com.tw/Terms-and-Conditions> and for electronic format documents, subject to Terms and Conditions for Electronic Documents at <http://www.sgs.com.tw/Terms-and-Conditions>. Attention is drawn to the limitation of liability, indemnification and jurisdiction issues defined therein. Any holder of this document is advised that information contained hereon reflects the Company's findings at the time of its intervention only and within the limits of Client's instructions, if any. The Company's sole responsibility is to its Client and this document does not exonerate parties to a transaction from exercising all their rights and obligations under the transaction documents. This document cannot be reproduced except in full, without prior written approval of the Company. Any unauthorized alteration, forgery or falsification of the content or appearance of this document is unlawful and offenders may be prosecuted to the fullest extent of the law.

AC POWER LINE CONDUCTED EMISSION TEST DATA

Report Number	:TERF2308001922E2	Test Site	:Conduction C
Test Mode	:2.4G	Test Date	:2023-10-11
Power	:120V60Hz	Temp./Humi.	:22.5°C/54%
Probe	:L1	Engineer	:Temo Chen

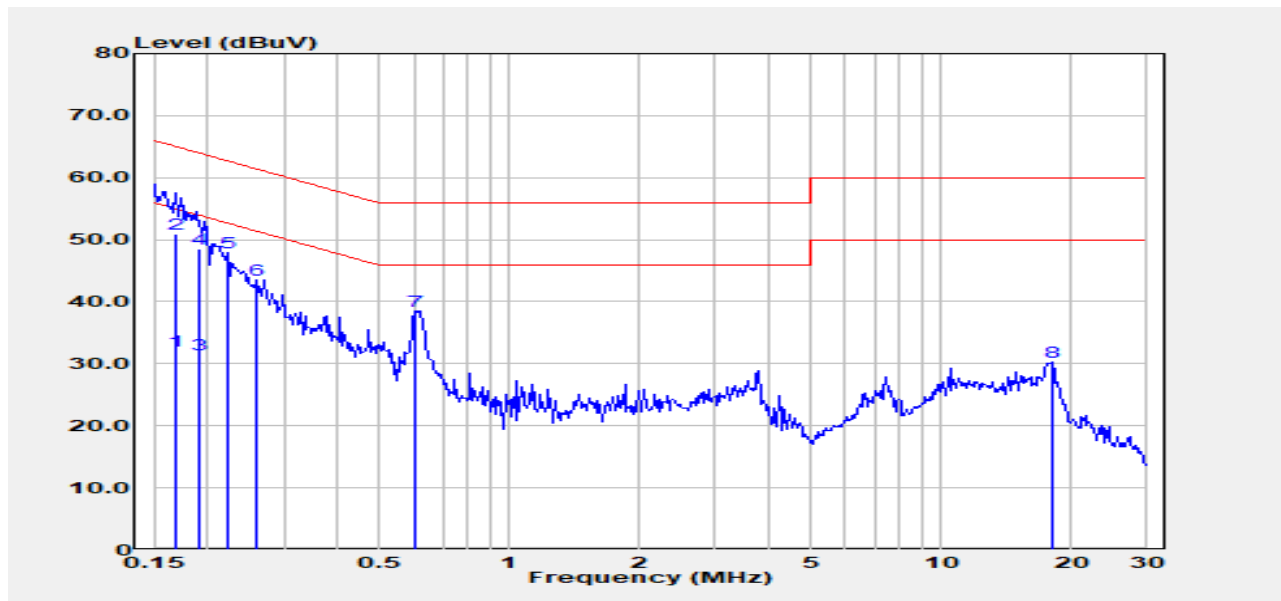

Freq. MHz	Detector Mode	Spectrum Reading Level dB μ V	Factor dB	Actual FS dB μ V	Limit dB μ V	Margin dB
0.168	Average	21.90	10.28	32.18	55.08	-22.90
0.168	QP	40.60	10.28	50.88	65.08	-14.20
0.190	Average	21.20	10.28	31.48	54.03	-22.55
0.190	QP	38.20	10.28	48.48	64.03	-15.55
0.222	Peak	37.71	10.28	47.99	62.76	-14.77
0.260	Peak	33.27	10.29	43.56	61.42	-17.85
0.604	Peak	28.24	10.33	38.57	56.00	-17.43
18.025	Peak	19.46	10.77	30.24	60.00	-29.76

Unless otherwise stated the results shown in this test report refer only to the sample(s) tested and such sample(s) are retained for 90 days only.

除非另有說明，此報告結果僅對測試之樣品負責，同時此樣品僅保留90天。本報告未經本公司書面許可，不可部份複製。

This document is issued by the Company subject to its General Conditions of Service printed overleaf, available on request or accessible at <http://www.sgs.com.tw/Terms-and-Conditions> and for electronic format documents, subject to Terms and Conditions for Electronic Documents at <http://www.sgs.com.tw/Terms-and-Conditions>. Attention is drawn to the limitation of liability, indemnification and jurisdiction issues defined therein. Any holder of this document is advised that information contained hereon reflects the Company's findings at the time of its intervention only and within the limits of Client's instructions, if any. The Company's sole responsibility is to its Client and this document does not exonerate parties to a transaction from exercising all their rights and obligations under the transaction documents. This document cannot be reproduced except in full, without prior written approval of the Company. Any unauthorized alteration, forgery or falsification of the content or appearance of this document is unlawful and offenders may be prosecuted to the fullest extent of the law.

Report Number	:TERF2308001922E2	Test Site	:Conduction C
Test Mode	:2.4G	Test Date	:2023-10-11
Power	:120V60Hz	Temp./Humi.	:22.5°C/54%
Probe	:N	Engineer	:Temo Chen

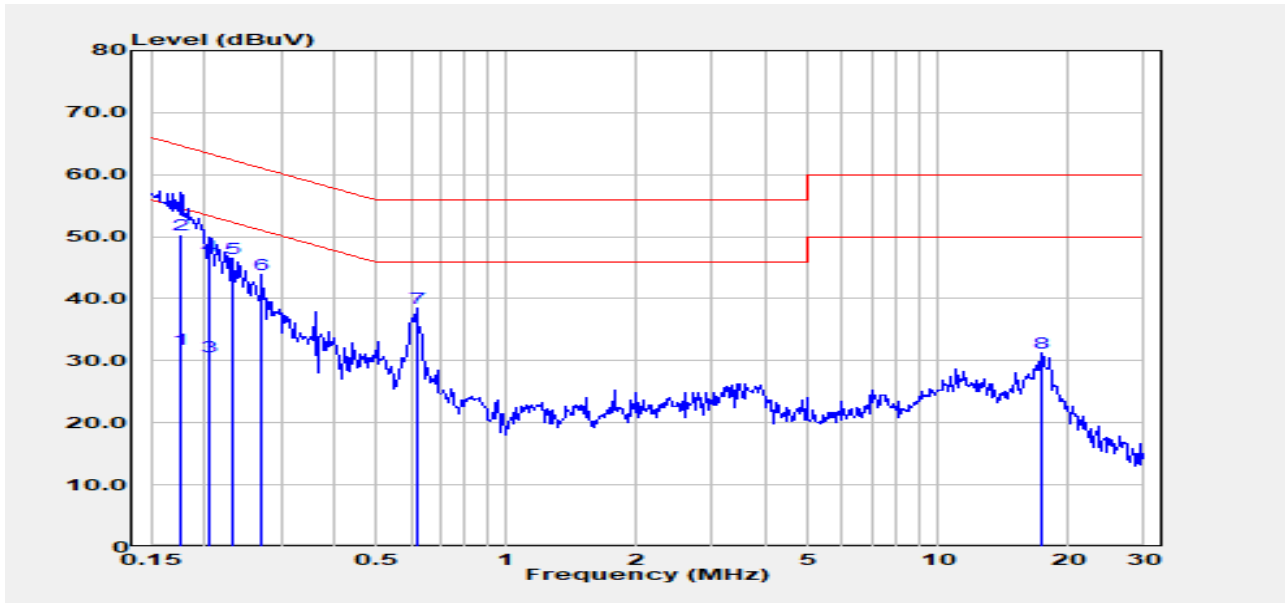

Freq.	Detector	Spectrum	Factor	Actual	Limit	Margin
MHz	Mode	Reading Level	dB	FS	dBuV	dB
	PK/QP/AV	dBuV		dBuV		
0.175	Average	21.20	10.65	31.85	54.73	-22.88
0.175	QP	39.60	10.65	50.25	64.73	-14.48
0.205	Average	20.00	10.65	30.65	53.39	-22.74
0.205	QP	36.20	10.65	46.85	63.39	-16.54
0.233	Peak	35.87	10.64	46.51	62.33	-15.82
0.272	Peak	33.32	10.63	43.95	61.06	-17.11
0.619	Peak	27.96	10.62	38.58	56.00	-17.42
17.276	Peak	20.10	11.12	31.22	60.00	-28.78

Unless otherwise stated the results shown in this test report refer only to the sample(s) tested and such sample(s) are retained for 90 days only.

除非另有說明，此報告結果僅對測試之樣品負責，同時此樣品僅保留90天。本報告未經本公司書面許可，不可部份複製。

This document is issued by the Company subject to its General Conditions of Service printed overleaf, available on request or accessible at <http://www.sgs.com.tw/Terms-and-Conditions> and for electronic format documents, subject to Terms and Conditions for Electronic Documents at <http://www.sgs.com.tw/Terms-and-Conditions>. Attention is drawn to the limitation of liability, indemnification and jurisdiction issues defined therein. Any holder of this document is advised that information contained hereon reflects the Company's findings at the time of its intervention only and within the limits of Client's instructions, if any. The Company's sole responsibility is to its Client and this document does not exonerate parties to a transaction from exercising all their rights and obligations under the transaction documents. This document cannot be reproduced except in full, without prior written approval of the Company. Any unauthorized alteration, forgery or falsification of the content or appearance of this document is unlawful and offenders may be prosecuted to the fullest extent of the law.

SGS Taiwan Ltd. No.134,Wu Kung Road, New Taipei Industrial Park, Wuku District, New Taipei City, Taiwan/新北市五股區新北產業園區五工路 134 號

8 OUTPUT POWER MEASUREMENT

8.1 Standard Applicable

8.1.1 Duty Cycle

Pre-analysis Check: While conducting average power measurement, duty cycle of each mode shall be checked to ensure its duty cycle in order to compensate for the loss due to insufficient ratio of duty cycle.

All duty cycle is pre-scanned, and result as obtained below shows only the most representative ones where duty cycle is conducted as the given transmission with given virtual operation that expresses the percentage.

8.1.2 FCC

For systems using digital modulation in the 2400-2483.5 MHz bands, the limit for peak output power is 1Watt.

If the transmitting antenna of directional gain greater than 6dBi are used the peak output power from the intentional radiator shall be reduced below the above stated value by the amount in dB that the directional gain of the Antenna exceeds 6dBi.

In case of point-to-point operation, the limit has to be reduced by 1dB for every 3dB that the directional gain of Antenna exceeds 6dBi.

Note:

As per section F. 2). e). (ii) of FCC KDB 662911 D01

If antenna gains are not equal and each transmit antenna is driven by only one spatial stream, directional gain may be calculated by either of the following formulas.

$$DirectionalGain = 10 \cdot \log \left[\frac{\sum_{j=1}^{N_{SS}} \left\{ \sum_{k=1}^{N_{ANT}} g_{j,k} \right\}^2}{N_{ANT}} \right]$$

where

Each antenna is driven by no more than one spatial stream;

NSS = the number of independent spatial streams of data;

NANT = the total number of antennas

$g_{j,k} = 10^{G_k/20}$ if the kth antenna is being fed by spatial stream j, or zero if it is not;

G_k is the gain in dBi of the kth antenna.

The antenna gain is not greater than 6 dBi. Therefore, reduction of power is not required.

Unless otherwise stated the results shown in this test report refer only to the sample(s) tested and such sample(s) are retained for 90 days only.
 除非另有說明，此報告結果僅對測試之樣品負責，同時此樣品僅保留90天。本報告未經本公司書面許可，不可部份複製。

This document is issued by the Company subject to its General Conditions of Service printed overleaf, available on request or accessible at <http://www.sgs.com.tw/Terms-and-Conditions> and for electronic format documents, subject to Terms and Conditions for Electronic Documents at <http://www.sgs.com.tw/Terms-and-Conditions>. Attention is drawn to the limitation of liability, indemnification and jurisdiction issues defined therein. Any holder of this document is advised that information contained hereon reflects the Company's findings at the time of its intervention only and within the limits of Client's instructions, if any. The Company's sole responsibility is to its Client and this document does not exonerate parties to a transaction from exercising all their rights and obligations under the transaction documents. This document cannot be reproduced except in full, without prior written approval of the Company. Any unauthorized alteration, forgery or falsification of the content or appearance of this document is unlawful and offenders may be prosecuted to the fullest extent of the law.

8.2 Test Setup

8.2.1 Duty Cycle

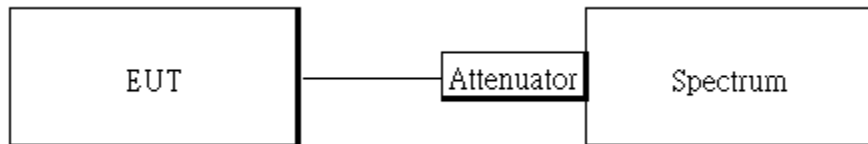

8.2.2 Output Power:

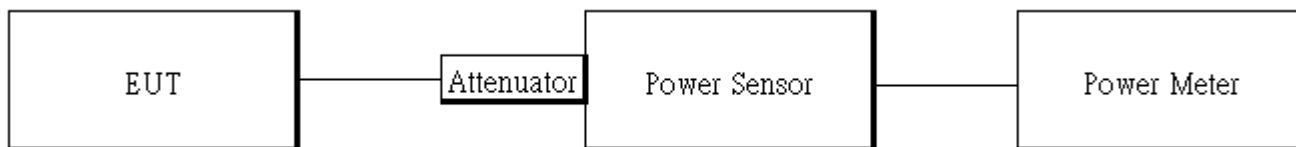

8.3 Measurement Procedure

8.3.1 Duty Cycle:

1. Set span = Zero
2. RBW = 8MHz
3. VBW = 8MHz,
4. Detector = Peak

8.3.2 Output Power

1. Place the EUT on the table and set it in transmitting mode.
2. The testing follows the Measurement Procedure of FCC KDB 558074 D01 DTS Meas. Guidance and C63.10 section 11.9.1 for Maximum peak conducted output power or section 11.9.2 Maximum conducted (average) output power
3. Remove the antenna from the EUT and then connect a low loss RF cable from the antenna port to the power meter or spectrum analyzer

Power Meter:

It is used as the auxiliary test equipment to conduct the output power measurement.

4. Record the max. Reading as observed from Spectrum or Power Meter.
5. MIMO mode: offset is set with “measure and add 10 Log (N)” to measurement for MIMO mode. Offset = cable loss + 10 log (N), where N is number of transmitting antenna, cable loss is specified below.

*** Note: The duty cycle factor and below is compensated to obtain the maximum value of measurement in average.**

Unless otherwise stated the results shown in this test report refer only to the sample(s) tested and such sample(s) are retained for 90 days only.

除非另有說明，此報告結果僅對測試之樣品負責，同時此樣品僅保留90天。本報告未經本公司書面許可，不可部份複製。

This document is issued by the Company subject to its General Conditions of Service printed overleaf, available on request or accessible at <http://www.sgs.com.tw/Terms-and-Conditions> and for electronic format documents, subject to Terms and Conditions for Electronic Documents at <http://www.sgs.com.tw/Terms-and-Conditions>. Attention is drawn to the limitation of liability, indemnification and jurisdiction issues defined therein. Any holder of this document is advised that information contained hereon reflects the Company's findings at the time of its intervention only and within the limits of Client's instructions, if any. The Company's sole responsibility is to its Client and this document does not exonerate parties to a transaction from exercising all their rights and obligations under the transaction documents. This document cannot be reproduced except in full, without prior written approval of the Company. Any unauthorized alteration, forgery or falsification of the content or appearance of this document is unlawful and offenders may be prosecuted to the fullest extent of the law.

8.4 Measurement Result

8.4.1 Duty Cycle:

Mode: CDD

	Duty Cycle (%) = Ton / (Ton+Toff)	Duty Factor (dB) =10*log (1/Duty Cycle)	1/T (kHz)	VBW setting (kHz)
802.11b	98.26	0.08	0.23	0.01
802.11g	98.13	0.08	0.37	0.01
802.11n_20	98.75	0.05	0.24	0.01
802.11n_40	98.75	0.05	0.24	0.01
802.11be_20	98.73	0.06	0.25	0.01
802.11be_40	98.73	0.06	0.25	0.01

Mode: Beamforming

	Duty Cycle (%) = Ton / (Ton+Toff)	Duty Factor (dB) =10*log (1/Duty Cycle)	1/T (kHz)	VBW setting (kHz)
802.11n_20	98.97	0.04	0.20	0.01
802.11n_40	98.25	0.08	0.41	0.01
802.11be_20	98.66	0.06	0.26	0.01
802.11be_40	97.78	0.10	0.52	1.00

Unless otherwise stated the results shown in this test report refer only to the sample(s) tested and such sample(s) are retained for 90 days only.
除非另有說明，此報告結果僅對測試之樣品負責，同時此樣品僅保留90天。本報告未經本公司書面許可，不可部份複製。

This document is issued by the Company subject to its General Conditions of Service printed overleaf, available on request or accessible at <http://www.sgs.com.tw/Terms-and-Conditions> and for electronic format documents, subject to Terms and Conditions for Electronic Documents at <http://www.sgs.com.tw/Terms-and-Conditions>. Attention is drawn to the limitation of liability, indemnification and jurisdiction issues defined therein. Any holder of this document is advised that information contained hereon reflects the Company's findings at the time of its intervention only and within the limits of Client's instructions, if any. The Company's sole responsibility is to its Client and this document does not exonerate parties to a transaction from exercising all their rights and obligations under the transaction documents. This document cannot be reproduced except in full, without prior written approval of the Company. Any unauthorized alteration, forgery or falsification of the content or appearance of this document is unlawful and offenders may be prosecuted to the fullest extent of the law.

8.4.2 Duty Cycle test plots

CDD_802.11b_20MHz_Chain0_2412MHz



802.11n_40MHz_Chain0_2422MHz



802.11g_20MHz_Chain0_2412MHz



802.11be_20MHz_Chain0_2412MHz



802.11n_20MHz_Chain0_2412MHz



802.11be_40MHz_Chain0_2422MHz



Unless otherwise stated the results shown in this test report refer only to the sample(s) tested and such sample(s) are retained for 90 days only.

除非另有說明，此報告結果僅對測試之樣品負責，同時此樣品僅保留90天。本報告未經本公司書面許可，不可部份複製。

This document is issued by the Company subject to its General Conditions of Service printed overleaf, available on request or accessible at <http://www.sgs.com.tw/Terms-and-Conditions> and for electronic format documents, subject to Terms and Conditions for Electronic Documents at <http://www.sgs.com.tw/Terms-and-Conditions>. Attention is drawn to the limitation of liability, indemnification and jurisdiction issues defined therein. Any holder of this document is advised that information contained hereon reflects the Company's findings at the time of its intervention only and within the limits of Client's instructions, if any. The Company's sole responsibility is to its Client and this document does not exonerate parties to a transaction from exercising all their rights and obligations under the transaction documents. This document cannot be reproduced except in full, without prior written approval of the Company. Any unauthorized alteration, forgery or falsification of the content or appearance of this document is unlawful and offenders may be prosecuted to the fullest extent of the law.

Beamforming_802.11n_20MHz_Chain0_2412MHz



802.11be_40MHz_Chain0_2422MHz



802.11n_40MHz_Chain0_2422MHz



802.11be_20MHz_Chain0_2412MHz



Unless otherwise stated the results shown in this test report refer only to the sample(s) tested and such sample(s) are retained for 90 days only.

除非另有說明，此報告結果僅對測試之樣品負責，同時此樣品僅保留90天。本報告未經本公司書面許可，不可部份複製。

This document is issued by the Company subject to its General Conditions of Service printed overleaf, available on request or accessible at <http://www.sgs.com.tw/Terms-and-Conditions> and for electronic format documents, subject to Terms and Conditions for Electronic Documents at <http://www.sgs.com.tw/Terms-and-Conditions>. Attention is drawn to the limitation of liability, indemnification and jurisdiction issues defined therein. Any holder of this document is advised that information contained hereon reflects the Company's findings at the time of its intervention only and within the limits of Client's instructions, if any. The Company's sole responsibility is to its Client and this document does not exonerate parties to a transaction from exercising all their rights and obligations under the transaction documents. This document cannot be reproduced except in full, without prior written approval of the Company. Any unauthorized alteration, forgery or falsification of the content or appearance of this document is unlawful and offenders may be prosecuted to the fullest extent of the law.

8.4.3 Output Power

Mode: CDD

802.11b_4TX									
CH	Freq. (MHz)	Data Rate	Avg. Output Power (dBm)				Total Avg. Output Power (dBm)	Limit (dBm)	RESULT
			Ch0	Ch1	Ch2	Ch3			
1	2412	1	23.63	24.40	22.36	24.03	29.69	30.00	PASS
6	2437	1	24.30	24.53	23.46	23.25	29.94	30.00	PASS
11	2462	1	23.72	24.35	22.85	23.20	29.58	30.00	PASS

802.11g_4TX									
CH	Freq. (MHz)	Data Rate	Avg. Output Power (dBm)				Total Avg. Output Power (dBm)	Limit (dBm)	RESULT
			Ch0	Ch1	Ch2	Ch3			
1	2412	6	24.05	24.35	23.04	24.31	29.99	30.00	PASS
6	2437	6	24.26	23.90	23.46	23.35	29.78	30.00	PASS
11	2462	6	23.83	24.19	23.34	23.51	29.75	30.00	PASS

802.11n_HT20M_4TX									
CH	Freq. (MHz)	Data Rate	Avg. Output Power (dBm)				Total Avg. Output Power (dBm)	Limit (dBm)	RESULT
			Ch0	Ch1	Ch2	Ch3			
1	2412	MCS0	23.82	24.45	22.61	24.27	29.87	30.00	PASS
6	2437	MCS0	24.00	24.13	23.15	23.17	29.66	30.00	PASS
11	2462	MCS0	23.75	24.30	23.02	23.36	29.66	30.00	PASS

802.11n_HT40M_4TX									
CH	Freq. (MHz)	Data Rate	Avg. Output Power (dBm)				Total Avg. Output Power (dBm)	Limit (dBm)	RESULT
			Ch0	Ch1	Ch2	Ch3			
3	2422	MCS0	23.94	24.53	22.59	23.86	29.81	30.00	PASS
6	2437	MCS0	24.27	24.45	23.17	23.30	29.86	30.00	PASS
9	2452	MCS0	24.01	24.16	23.05	23.20	29.66	30.00	PASS

Unless otherwise stated the results shown in this test report refer only to the sample(s) tested and such sample(s) are retained for 90 days only.

除非另有說明，此報告結果僅對測試之樣品負責，同時此樣品僅保留90天。本報告未經本公司書面許可，不可部份複製。

This document is issued by the Company subject to its General Conditions of Service printed overleaf, available on request or accessible at <http://www.sgs.com.tw/Terms-and-Conditions> and for electronic format documents, subject to Terms and Conditions for Electronic Documents at <http://www.sgs.com.tw/Terms-and-Conditions>. Attention is drawn to the limitation of liability, indemnification and jurisdiction issues defined therein. Any holder of this document is advised that information contained hereon reflects the Company's findings at the time of its intervention only and within the limits of Client's instructions, if any. The Company's sole responsibility is to its Client and this document does not exonerate parties to a transaction from exercising all their rights and obligations under the transaction documents. This document cannot be reproduced except in full, without prior written approval of the Company. Any unauthorized alteration, forgery or falsification of the content or appearance of this document is unlawful and offenders may be prosecuted to the fullest extent of the law.

802.11be_EHT20M_4TX

CH	Freq. (MHz)	Data Rate	RU Config	Avg. Output Power (dBm)				Total Avg. Output Power (dBm)	Limit (dBm)	RESULT
				Ch0	Ch1	Ch2	Ch3			
1	2412	MCS0	full	23.63	24.28	22.42	23.93	29.64	30.00	PASS
6	2437	MCS0	full	24.13	24.29	23.28	23.38	29.81	30.00	PASS
11	2462	MCS0	full	23.81	24.42	23.24	23.61	29.81	30.00	PASS

802.11be_EHT40M_4TX

CH	Freq. (MHz)	Data Rate	RU Config	Avg. Output Power (dBm)				Total Avg. Output Power (dBm)	Limit (dBm)	RESULT
				Ch0	Ch1	Ch2	Ch3			
3	2422	MCS0	full	23.72	24.23	22.39	23.64	29.56	30.00	PASS
6	2437	MCS0	full	24.06	24.23	22.89	23.04	29.61	30.00	PASS
9	2452	MCS0	full	24.24	24.41	23.31	23.41	29.89	30.00	PASS

Unless otherwise stated the results shown in this test report refer only to the sample(s) tested and such sample(s) are retained for 90 days only.

除非另有說明，此報告結果僅對測試之樣品負責，同時此樣品僅保留90天。本報告未經本公司書面許可，不可部份複製。

This document is issued by the Company subject to its General Conditions of Service printed overleaf, available on request or accessible at <http://www.sgs.com.tw/Terms-and-Conditions> and for electronic format documents, subject to Terms and Conditions for Electronic Documents at <http://www.sgs.com.tw/Terms-and-Conditions>. Attention is drawn to the limitation of liability, indemnification and jurisdiction issues defined therein. Any holder of this document is advised that information contained hereon reflects the Company's findings at the time of its intervention only and within the limits of Client's instructions, if any. The Company's sole responsibility is to its Client and this document does not exonerate parties to a transaction from exercising all their rights and obligations under the transaction documents. This document cannot be reproduced except in full, without prior written approval of the Company. Any unauthorized alteration, forgery or falsification of the content or appearance of this document is unlawful and offenders may be prosecuted to the fullest extent of the law.

Mode: Beamforming

802.11n_HT20M_4TX										
CH	Freq. (MHz)	Data Rate	Avg. Output Power (dBm)				Total Avg. Output Power (dBm)	Limit (dBm)	RESULT	
			Ch0	Ch1	Ch2	Ch3				
1	2412	MCS0	23.39	24.07	22.68	24.06	29.61	30.00	PASS	
6	2437	MCS0	23.78	23.85	23.49	23.36	29.65	30.00	PASS	
11	2462	MCS0	23.52	23.75	23.54	23.68	29.65	30.00	PASS	
802.11n_HT40M_4TX										
CH	Freq. (MHz)	Data Rate	Avg. Output Power (dBm)				Total Avg. Output Power (dBm)	Limit (dBm)	RESULT	
			Ch0	Ch1	Ch2	Ch3				
3	2422	MCS0	22.46	23.00	21.88	22.27	28.44	30.00	PASS	
6	2437	MCS0	24.06	24.20	23.43	23.55	29.84	30.00	PASS	
9	2452	MCS0	23.81	23.99	23.30	23.40	29.65	30.00	PASS	
802.11be_EHT20M_4TX										
CH	Freq. (MHz)	Data Rate	RU Config	Avg. Output Power (dBm)				Total Avg. Output Power (dBm)	Limit (dBm)	RESULT
				Ch0	Ch1	Ch2	Ch3			
1	2412	MCS0	full	23.11	22.97	23.27	23.20	29.16	30.00	PASS
6	2437	MCS0	full	23.65	23.84	22.98	23.08	29.42	30.00	PASS
11	2462	MCS0	full	23.67	24.21	23.35	23.70	29.76	30.00	PASS
802.11be_EHT40M_4TX										
CH	Freq. (MHz)	Data Rate	RU Config	Avg. Output Power (dBm)				Total Avg. Output Power (dBm)	Limit (dBm)	RESULT
				Ch0	Ch1	Ch2	Ch3			
3	2422	MCS0	full	23.00	23.55	22.42	22.70	28.95	30.00	PASS
6	2437	MCS0	full	23.66	24.02	23.21	23.39	29.60	30.00	PASS
9	2452	MCS0	full	23.71	24.07	22.93	23.23	29.53	30.00	PASS

Unless otherwise stated the results shown in this test report refer only to the sample(s) tested and such sample(s) are retained for 90 days only.

除非另有說明，此報告結果僅對測試之樣品負責，同時此樣品僅保留90天。本報告未經本公司書面許可，不可部份複製。

This document is issued by the Company subject to its General Conditions of Service printed overleaf, available on request or accessible at <http://www.sgs.com.tw/Terms-and-Conditions> and for electronic format documents, subject to Terms and Conditions for Electronic Documents at <http://www.sgs.com.tw/Terms-and-Conditions>. Attention is drawn to the limitation of liability, indemnification and jurisdiction issues defined therein. Any holder of this document is advised that information contained hereon reflects the Company's findings at the time of its intervention only and within the limits of Client's instructions, if any. The Company's sole responsibility is to its Client and this document does not exonerate parties to a transaction from exercising all their rights and obligations under the transaction documents. This document cannot be reproduced except in full, without prior written approval of the Company. Any unauthorized alteration, forgery or falsification of the content or appearance of this document is unlawful and offenders may be prosecuted to the fullest extent of the law.

9 EMISSION BANDWIDTH MEASUREMENT

9.1 Standard Applicable

The minimum 6 dB bandwidth shall be at least 500 kHz.

9.2 Test Setup

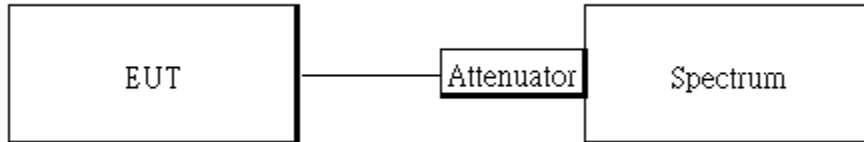

9.3 Measurement Procedure:

1. Place the EUT on the table and set it in transmitting mode.
2. Remove the antenna from the EUT and then connect a low loss RF cable from the antenna port to the spectrum analyzer.

9.3.1 6dB BW measurements

1. The testing follows the Measurement Procedure of the KDB 558074 D01.
2. Set the spectrum analyzer as
RBW= 100 kHz ,
VBW = 3 X RBW,
Span= 2 to 5 times of the OBW,
Sweep=auto, Detector = Peak, and Max hold.
3. Mark the upper and lower frequencies of -6dB.
4. Repeat above procedures until all test default channel is completed.

Unless otherwise stated the results shown in this test report refer only to the sample(s) tested and such sample(s) are retained for 90 days only.
除非另有說明，此報告結果僅對測試之樣品負責，同時此樣品僅保留90天。本報告未經本公司書面許可，不可部份複製。

This document is issued by the Company subject to its General Conditions of Service printed overleaf, available on request or accessible at <http://www.sgs.com.tw/Terms-and-Conditions> and for electronic format documents, subject to Terms and Conditions for Electronic Documents at <http://www.sgs.com.tw/Terms-and-Conditions>. Attention is drawn to the limitation of liability, indemnification and jurisdiction issues defined therein. Any holder of this document is advised that information contained hereon reflects the Company's findings at the time of its intervention only and within the limits of Client's instructions, if any. The Company's sole responsibility is to its Client and this document does not exonerate parties to a transaction from exercising all their rights and obligations under the transaction documents. This document cannot be reproduced except in full, without prior written approval of the Company. Any unauthorized alteration, forgery or falsification of the content or appearance of this document is unlawful and offenders may be prosecuted to the fullest extent of the law.

9.4 Measurement Result:

9.4.1 6dB BW measurements

Mode: CDD

802.11b Ch0

Freq. (MHz)	6dB BW (kHz)	Limit (kHz)	Result
2412	8080.00	≥ 500	PASS
2437	8064.00	≥ 500	PASS
2462	7133.00	≥ 500	PASS

802.11b Ch1

Freq. (MHz)	6dB BW (kHz)	Limit (kHz)	Result
2412	7598.00	≥ 500	PASS
2437	8071.00	≥ 500	PASS
2462	8073.00	≥ 500	PASS

802.11b Ch2

Freq. (MHz)	6dB BW (kHz)	Limit (kHz)	Result
2412	8078.00	≥ 500	PASS
2437	8070.00	≥ 500	PASS
2462	7604.00	≥ 500	PASS

802.11b Ch3

Freq. (MHz)	6dB BW (kHz)	Limit (kHz)	Result
2412	7609.00	≥ 500	PASS
2437	8067.00	≥ 500	PASS
2462	7594.00	≥ 500	PASS

802.11g Ch0

Freq. (MHz)	6dB BW (kHz)	Limit (kHz)	Result
2412	15350.00	≥ 500	PASS
2437	15350.00	≥ 500	PASS
2462	15500.00	≥ 500	PASS

802.11g Ch1

Freq. (MHz)	6dB BW (kHz)	Limit (kHz)	Result
2412	15160.00	≥ 500	PASS
2437	15150.00	≥ 500	PASS
2462	15130.00	≥ 500	PASS

Unless otherwise stated the results shown in this test report refer only to the sample(s) tested and such sample(s) are retained for 90 days only.

除非另有說明，此報告結果僅對測試之樣品負責，同時此樣品僅保留90天。本報告未經本公司書面許可，不可部份複製。

This document is issued by the Company subject to its General Conditions of Service printed overleaf, available on request or accessible at <http://www.sgs.com.tw/Terms-and-Conditions> and for electronic format documents, subject to Terms and Conditions for Electronic Documents at <http://www.sgs.com.tw/Terms-and-Conditions>. Attention is drawn to the limitation of liability, indemnification and jurisdiction issues defined therein. Any holder of this document is advised that information contained hereon reflects the Company's findings at the time of its intervention only and within the limits of Client's instructions, if any. The Company's sole responsibility is to its Client and this document does not exonerate parties to a transaction from exercising all their rights and obligations under the transaction documents. This document cannot be reproduced except in full, without prior written approval of the Company. Any unauthorized alteration, forgery or falsification of the content or appearance of this document is unlawful and offenders may be prosecuted to the fullest extent of the law.

802.11g Ch2

Freq. (MHz)	6dB BW (kHz)	Limit (kHz)	Result
2412	15180.00	≥ 500	PASS
2437	15360.00	≥ 500	PASS
2462	15450.00	≥ 500	PASS

802.11g Ch3

Freq. (MHz)	6dB BW (kHz)	Limit (kHz)	Result
2412	15150.00	≥ 500	PASS
2437	15140.00	≥ 500	PASS
2462	15130.00	≥ 500	PASS

802.11n_HT_20M Ch0

Freq. (MHz)	6dB BW (kHz)	Limit (kHz)	Result
2412	15110.00	≥ 500	PASS
2437	15130.00	≥ 500	PASS
2462	15460.00	≥ 500	PASS

802.11n_HT_20M Ch1

Freq. (MHz)	6dB BW (kHz)	Limit (kHz)	Result
2412	16320.00	≥ 500	PASS
2437	15740.00	≥ 500	PASS
2462	16540.00	≥ 500	PASS

802.11n_HT_20M Ch2

Freq. (MHz)	6dB BW (kHz)	Limit (kHz)	Result
2412	15690.00	≥ 500	PASS
2437	15300.00	≥ 500	PASS
2462	15730.00	≥ 500	PASS

802.11n_HT_20M Ch3

Freq. (MHz)	6dB BW (kHz)	Limit (kHz)	Result
2412	15720.00	≥ 500	PASS
2437	15120.00	≥ 500	PASS
2462	15100.00	≥ 500	PASS

802.11n_HT_40M Ch0

Freq. (MHz)	6dB BW (kHz)	Limit (kHz)	Result
2422	31380.00	≥ 500	PASS
2437	35050.00	≥ 500	PASS
2452	32700.00	≥ 500	PASS

Unless otherwise stated the results shown in this test report refer only to the sample(s) tested and such sample(s) are retained for 90 days only.

除非另有說明，此報告結果僅對測試之樣品負責，同時此樣品僅保留90天。本報告未經本公司書面許可，不可部份複製。

This document is issued by the Company subject to its General Conditions of Service printed overleaf, available on request or accessible at <http://www.sgs.com.tw/Terms-and-Conditions>, and for electronic format documents, subject to Terms and Conditions for Electronic Documents at <http://www.sgs.com.tw/Terms-and-Conditions>. Attention is drawn to the limitation of liability, indemnification and jurisdiction issues defined therein. Any holder of this document is advised that information contained hereon reflects the Company's findings at the time of its intervention only and within the limits of Client's instructions, if any. The Company's sole responsibility is to its Client and this document does not exonerate parties to a transaction from exercising all their rights and obligations under the transaction documents. This document cannot be reproduced except in full, without prior written approval of the Company. Any unauthorized alteration, forgery or falsification of the content or appearance of this document is unlawful and offenders may be prosecuted to the fullest extent of the law.

802.11n_HT_40M Ch1

Freq. (MHz)	6dB BW (kHz)	Limit (kHz)	Result
2422	35070.00	≥ 500	PASS
2437	34990.00	≥ 500	PASS
2452	35100.00	≥ 500	PASS

802.11n_HT_40M Ch2

Freq. (MHz)	6dB BW (kHz)	Limit (kHz)	Result
2422	33870.00	≥ 500	PASS
2437	31320.00	≥ 500	PASS
2452	32540.00	≥ 500	PASS

802.11n_HT_40M Ch3

Freq. (MHz)	6dB BW (kHz)	Limit (kHz)	Result
2422	31340.00	≥ 500	PASS
2437	35090.00	≥ 500	PASS
2452	31330.00	≥ 500	PASS

802.11be_EHT_20M Ch0

Freq. (MHz)	RU Config	6dB BW (kHz)	Limit (kHz)	Result
2412	full	16610.00	≥ 500	PASS
2437	full	17070.00	≥ 500	PASS
2462	full	16720.00	≥ 500	PASS

802.11be_EHT_20M Ch1

Freq. (MHz)	RU Config	6dB BW (kHz)	Limit (kHz)	Result
2412	full	15180.00	≥ 500	PASS
2437	full	15170.00	≥ 500	PASS
2462	full	15140.00	≥ 500	PASS

802.11be_EHT_20M Ch2

Freq. (MHz)	RU Config	6dB BW (kHz)	Limit (kHz)	Result
2412	full	15790.00	≥ 500	PASS
2437	full	15200.00	≥ 500	PASS
2462	full	16670.00	≥ 500	PASS

Unless otherwise stated the results shown in this test report refer only to the sample(s) tested and such sample(s) are retained for 90 days only.

除非另有說明，此報告結果僅對測試之樣品負責，同時此樣品僅保留90天。本報告未經本公司書面許可，不可部份複製。

This document is issued by the Company subject to its General Conditions of Service printed overleaf, available on request or accessible at <http://www.sgs.com.tw/Terms-and-Conditions> and for electronic format documents, subject to Terms and Conditions for Electronic Documents at <http://www.sgs.com.tw/Terms-and-Conditions>. Attention is drawn to the limitation of liability, indemnification and jurisdiction issues defined therein. Any holder of this document is advised that information contained hereon reflects the Company's findings at the time of its intervention only and within the limits of Client's instructions, if any. The Company's sole responsibility is to its Client and this document does not exonerate parties to a transaction from exercising all their rights and obligations under the transaction documents. This document cannot be reproduced except in full, without prior written approval of the Company. Any unauthorized alteration, forgery or falsification of the content or appearance of this document is unlawful and offenders may be prosecuted to the fullest extent of the law.

802.11be_EHT_20M Ch3

Freq. (MHz)	RU Config	6dB BW (kHz)	Limit (kHz)	Result
2412	full	15860.00	≥ 500	PASS
2437	full	17370.00	≥ 500	PASS
2462	full	16300.00	≥ 500	PASS

802.11be_EHT_40M Ch0

Freq. (MHz)	RU Config	6dB BW (kHz)	Limit (kHz)	Result
2422	full	35080.00	≥ 500	PASS
2437	full	35060.00	≥ 500	PASS
2452	full	35080.00	≥ 500	PASS

802.11be_EHT_40M Ch1

Freq. (MHz)	RU Config	6dB BW (kHz)	Limit (kHz)	Result
2422	full	35080.00	≥ 500	PASS
2437	full	35070.00	≥ 500	PASS
2452	full	33840.00	≥ 500	PASS

802.11be_EHT_40M Ch2

Freq. (MHz)	RU Config	6dB BW (kHz)	Limit (kHz)	Result
2422	full	35080.00	≥ 500	PASS
2437	full	33880.00	≥ 500	PASS
2452	full	32580.00	≥ 500	PASS

802.11be_EHT_40M Ch3

Freq. (MHz)	RU Config	6dB BW (kHz)	Limit (kHz)	Result
2422	full	30130.00	≥ 500	PASS
2437	full	35090.00	≥ 500	PASS
2452	full	32610.00	≥ 500	PASS

Unless otherwise stated the results shown in this test report refer only to the sample(s) tested and such sample(s) are retained for 90 days only.

除非另有說明，此報告結果僅對測試之樣品負責，同時此樣品僅保留90天。本報告未經本公司書面許可，不可部份複製。

This document is issued by the Company subject to its General Conditions of Service printed overleaf, available on request or accessible at <http://www.sgs.com.tw/Terms-and-Conditions> and for electronic format documents, subject to Terms and Conditions for Electronic Documents at <http://www.sgs.com.tw/Terms-and-Conditions>. Attention is drawn to the limitation of liability, indemnification and jurisdiction issues defined therein. Any holder of this document is advised that information contained hereon reflects the Company's findings at the time of its intervention only and within the limits of Client's instructions, if any. The Company's sole responsibility is to its Client and this document does not exonerate parties to a transaction from exercising all their rights and obligations under the transaction documents. This document cannot be reproduced except in full, without prior written approval of the Company. Any unauthorized alteration, forgery or falsification of the content or appearance of this document is unlawful and offenders may be prosecuted to the fullest extent of the law.

CDD_802.11b_20MHz_Chain0_2412MHz

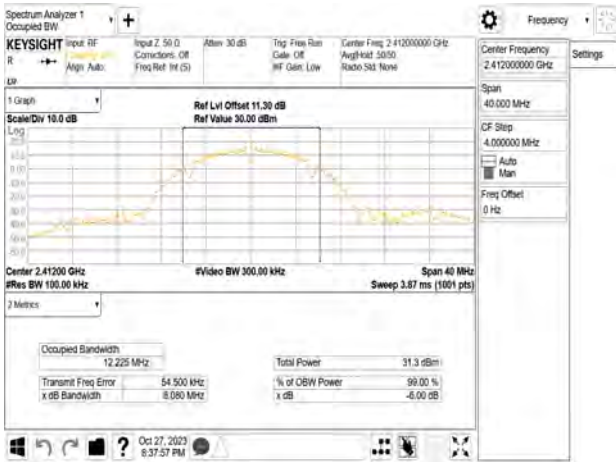

802.11b_20MHz_Chain1_2412MHz



802.11b_20MHz_Chain0_2437MHz

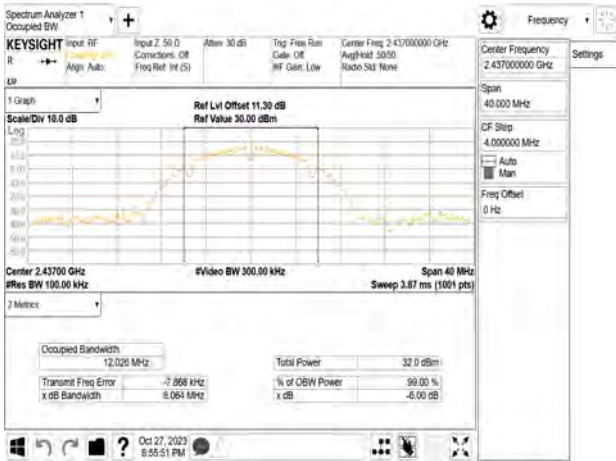

802.11b_20MHz_Chain1_2437MHz

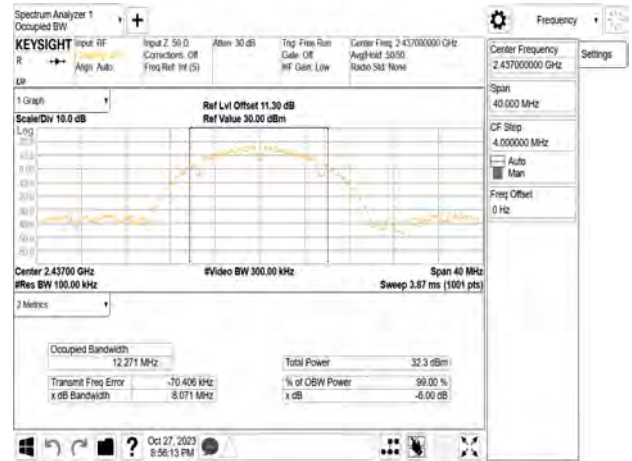

802.11b_20MHz_Chain0_2462MHz

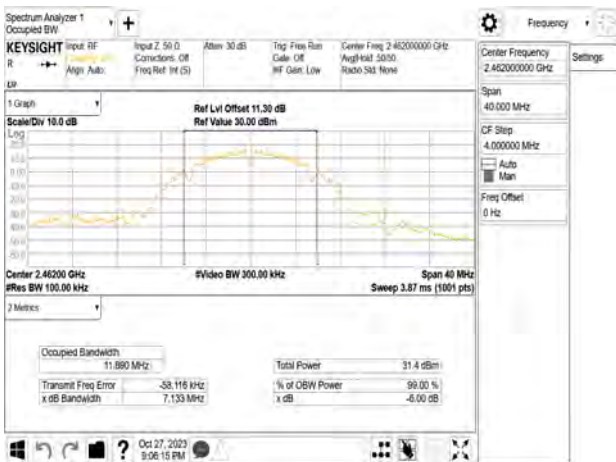

802.11b_20MHz_Chain1_2462MHz



Unless otherwise stated the results shown in this test report refer only to the sample(s) tested and such sample(s) are retained for 90 days only.

除非另有說明，此報告結果僅對測試之樣品負責，同時此樣品僅保留90天。本報告未經本公司書面許可，不可部份複製。

This document is issued by the Company subject to its General Conditions of Service printed overleaf, available on request or accessible at <http://www.sgs.com.tw/Terms-and-Conditions> and for electronic format documents, subject to Terms and Conditions for Electronic Documents at <http://www.sgs.com.tw/Terms-and-Conditions>. Attention is drawn to the limitation of liability, indemnification and jurisdiction issues defined therein. Any holder of this document is advised that information contained hereon reflects the Company's findings at the time of its intervention only and within the limits of Client's instructions, if any. The Company's sole responsibility is to its Client and this document does not exonerate parties to a transaction from exercising all their rights and obligations under the transaction documents. This document cannot be reproduced except in full, without prior written approval of the Company. Any unauthorized alteration, forgery or falsification of the content or appearance of this document is unlawful and offenders may be prosecuted to the fullest extent of the law.

802.11b_20MHz_Chain2_2412MHz

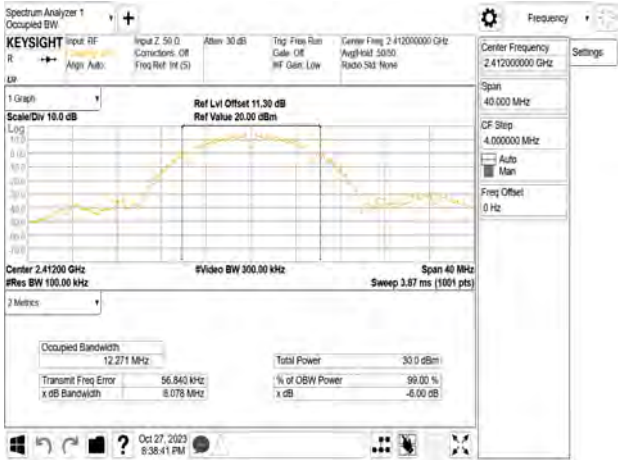

802.11b_20MHz_Chain3_2412MHz



802.11b_20MHz_Chain2_2437MHz



802.11b_20MHz_Chain3_2437MHz



802.11b_20MHz_Chain2_2462MHz



802.11b_20MHz_Chain3_2462MHz



Unless otherwise stated the results shown in this test report refer only to the sample(s) tested and such sample(s) are retained for 90 days only.

除非另有說明，此報告結果僅對測試之樣品負責，同時此樣品僅保留90天。本報告未經本公司書面許可，不可部份複製。

This document is issued by the Company subject to its General Conditions of Service printed overleaf, available on request or accessible at <http://www.sgs.com.tw/Terms-and-Conditions> and for electronic format documents, subject to Terms and Conditions for Electronic Documents at <http://www.sgs.com.tw/Terms-and-Conditions>. Attention is drawn to the limitation of liability, indemnification and jurisdiction issues defined therein. Any holder of this document is advised that information contained hereon reflects the Company's findings at the time of its intervention only and within the limits of Client's instructions, if any. The Company's sole responsibility is to its Client and this document does not exonerate parties to a transaction from exercising all their rights and obligations under the transaction documents. This document cannot be reproduced except in full, without prior written approval of the Company. Any unauthorized alteration, forgery or falsification of the content or appearance of this document is unlawful and offenders may be prosecuted to the fullest extent of the law.

802.11g_20MHz_Chain0_2412MHz

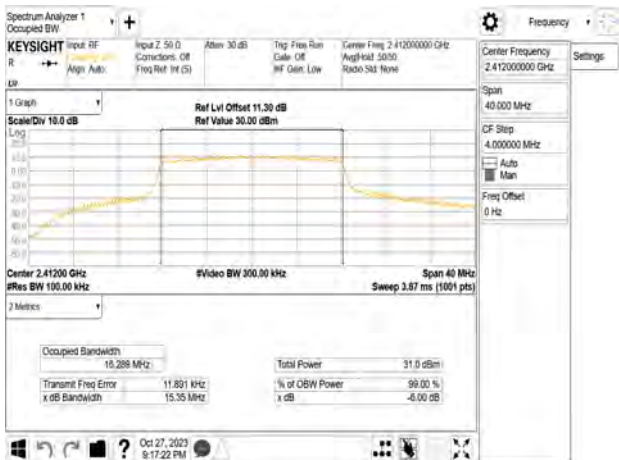

802.11g_20MHz_Chain1_2412MHz

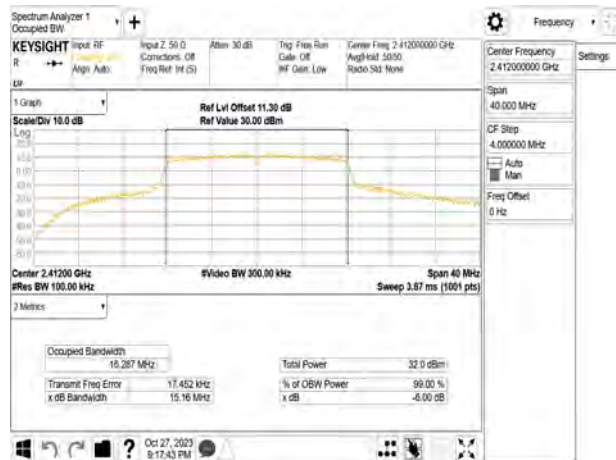

802.11g_20MHz_Chain0_2437MHz

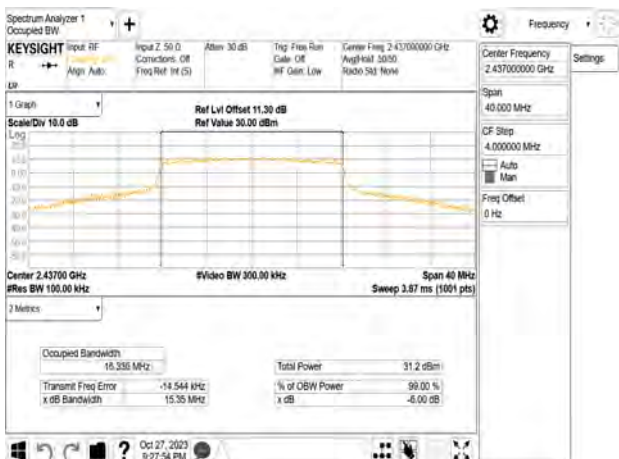

802.11g_20MHz_Chain1_2437MHz

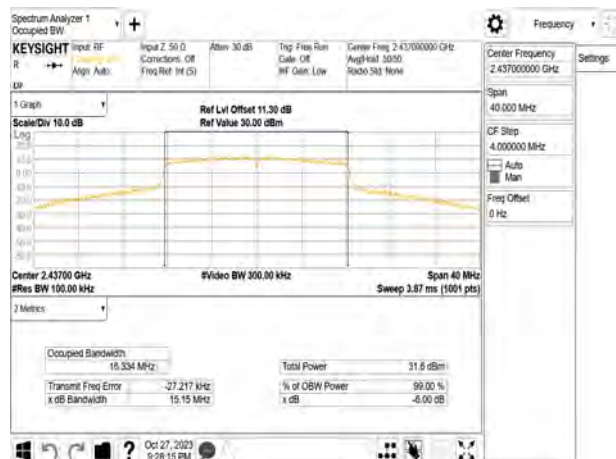

802.11g_20MHz_Chain0_2462MHz

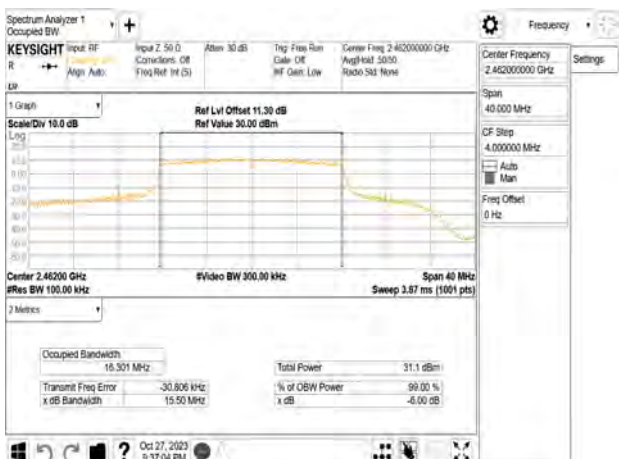

802.11g_20MHz_Chain1_2462MHz



Unless otherwise stated the results shown in this test report refer only to the sample(s) tested and such sample(s) are retained for 90 days only.

除非另有說明，此報告結果僅對測試之樣品負責，同時此樣品僅保留90天。本報告未經本公司書面許可，不可部份複製。

This document is issued by the Company subject to its General Conditions of Service printed overleaf, available on request or accessible at <http://www.sgs.com.tw/Terms-and-Conditions> and for electronic format documents, subject to Terms and Conditions for Electronic Documents at <http://www.sgs.com.tw/Terms-and-Conditions>. Attention is drawn to the limitation of liability, indemnification and jurisdiction issues defined therein. Any holder of this document is advised that information contained hereon reflects the Company's findings at the time of its intervention only and within the limits of Client's instructions, if any. The Company's sole responsibility is to its Client and this document does not exonerate parties to a transaction from exercising all their rights and obligations under the transaction documents. This document cannot be reproduced except in full, without prior written approval of the Company. Any unauthorized alteration, forgery or falsification of the content or appearance of this document is unlawful and offenders may be prosecuted to the fullest extent of the law.

802.11g_20MHz_Chain2_2412MHz

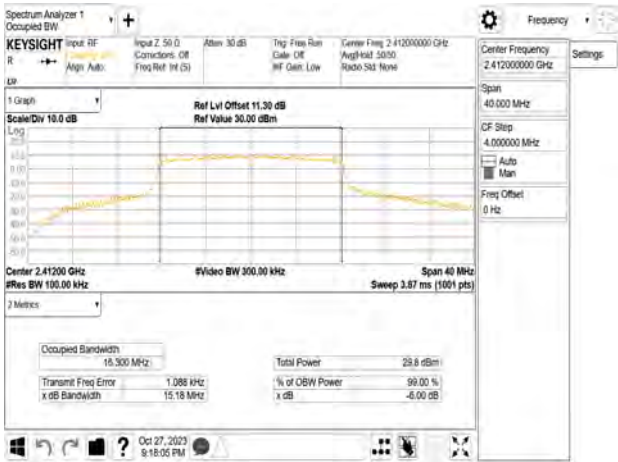

802.11g_20MHz_Chain3_2412MHz



802.11g_20MHz_Chain2_2437MHz

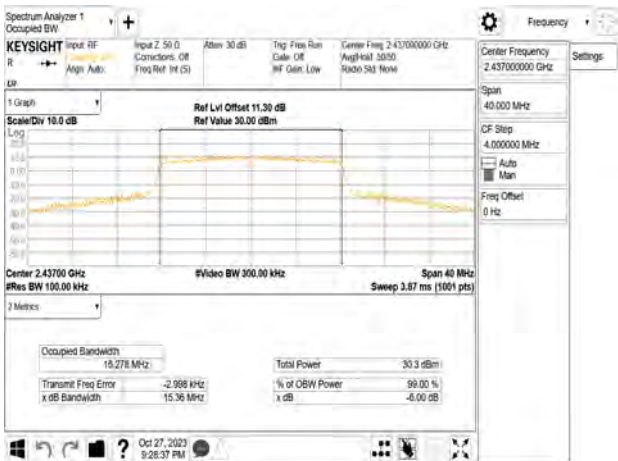

802.11g_20MHz_Chain3_2437MHz

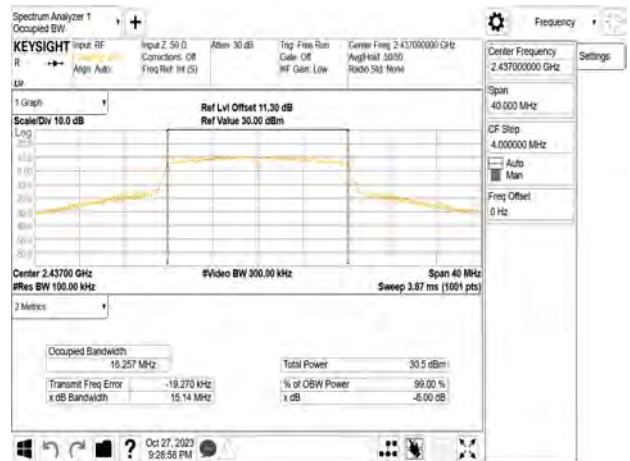

802.11g_20MHz_Chain2_2462MHz

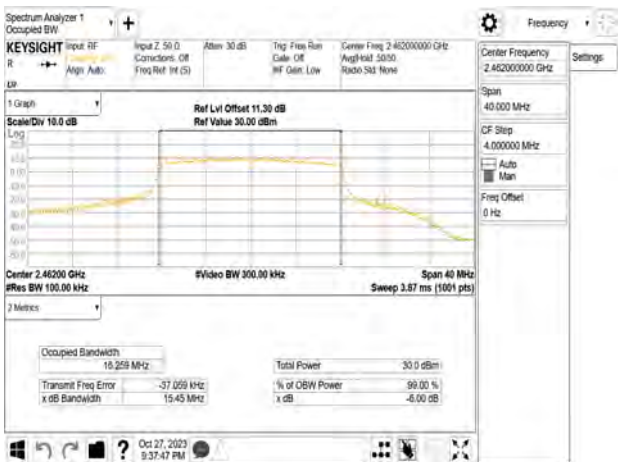

802.11g_20MHz_Chain3_2462MHz



Unless otherwise stated the results shown in this test report refer only to the sample(s) tested and such sample(s) are retained for 90 days only.

除非另有說明，此報告結果僅對測試之樣品負責，同時此樣品僅保留90天。本報告未經本公司書面許可，不可部份複製。

This document is issued by the Company subject to its General Conditions of Service printed overleaf, available on request or accessible at <http://www.sgs.com.tw/Terms-and-Conditions> and for electronic format documents, subject to Terms and Conditions for Electronic Documents at <http://www.sgs.com.tw/Terms-and-Conditions>. Attention is drawn to the limitation of liability, indemnification and jurisdiction issues defined therein. Any holder of this document is advised that information contained hereon reflects the Company's findings at the time of its intervention only and within the limits of Client's instructions, if any. The Company's sole responsibility is to its Client and this document does not exonerate parties to a transaction from exercising all their rights and obligations under the transaction documents. This document cannot be reproduced except in full, without prior written approval of the Company. Any unauthorized alteration, forgery or falsification of the content or appearance of this document is unlawful and offenders may be prosecuted to the fullest extent of the law.

802.11n_20MHz_Chain0_2412MHz



802.11n_20MHz_Chain1_2412MHz



802.11n_20MHz_Chain0_2437MHz



802.11n_20MHz_Chain1_2437MHz



802.11n_20MHz_Chain0_2462MHz



802.11n_20MHz_Chain1_2462MHz



Unless otherwise stated the results shown in this test report refer only to the sample(s) tested and such sample(s) are retained for 90 days only.

除非另有說明，此報告結果僅對測試之樣品負責，同時此樣品僅保留90天。本報告未經本公司書面許可，不可部份複製。

This document is issued by the Company subject to its General Conditions of Service printed overleaf, available on request or accessible at <http://www.sgs.com.tw/Terms-and-Conditions> and for electronic format documents, subject to Terms and Conditions for Electronic Documents at <http://www.sgs.com.tw/Terms-and-Conditions>. Attention is drawn to the limitation of liability, indemnification and jurisdiction issues defined therein. Any holder of this document is advised that information contained hereon reflects the Company's findings at the time of its intervention only and within the limits of Client's instructions, if any. The Company's sole responsibility is to its Client and this document does not exonerate parties to a transaction from exercising all their rights and obligations under the transaction documents. This document cannot be reproduced except in full, without prior written approval of the Company. Any unauthorized alteration, forgery or falsification of the content or appearance of this document is unlawful and offenders may be prosecuted to the fullest extent of the law.

802.11n_20MHz_Chain2_2412MHz



802.11n_20MHz_Chain3_2412MHz



802.11n_20MHz_Chain2_2437MHz

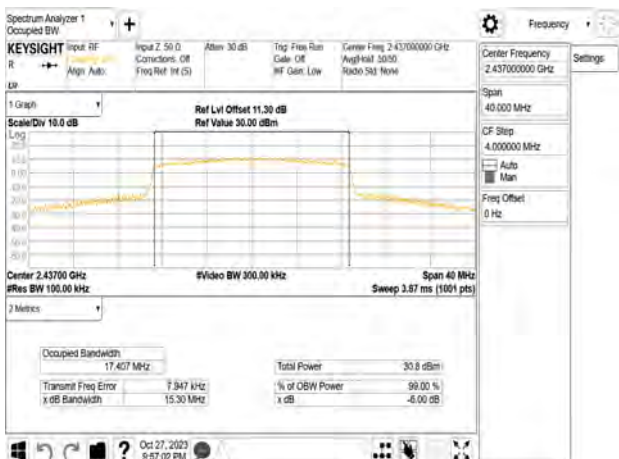

802.11n_20MHz_Chain3_2437MHz



802.11n_20MHz_Chain2_2462MHz



802.11n_20MHz_Chain3_2462MHz



Unless otherwise stated the results shown in this test report refer only to the sample(s) tested and such sample(s) are retained for 90 days only.

除非另有說明，此報告結果僅對測試之樣品負責，同時此樣品僅保留90天。本報告未經本公司書面許可，不可部份複製。

This document is issued by the Company subject to its General Conditions of Service printed overleaf, available on request or accessible at <http://www.sgs.com.tw/Terms-and-Conditions> and for electronic format documents, subject to Terms and Conditions for Electronic Documents at <http://www.sgs.com.tw/Terms-and-Conditions>. Attention is drawn to the limitation of liability, indemnification and jurisdiction issues defined therein. Any holder of this document is advised that information contained hereon reflects the Company's findings at the time of its intervention only and within the limits of Client's instructions, if any. The Company's sole responsibility is to its Client and this document does not exonerate parties to a transaction from exercising all their rights and obligations under the transaction documents. This document cannot be reproduced except in full, without prior written approval of the Company. Any unauthorized alteration, forgery or falsification of the content or appearance of this document is unlawful and offenders may be prosecuted to the fullest extent of the law.

802.11n_40MHz_Chain0_2422MHz

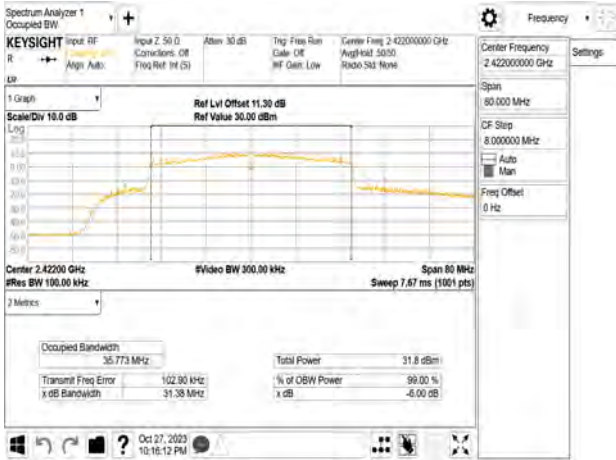

802.11n_40MHz_Chain1_2422MHz



802.11n_40MHz_Chain0_2437MHz

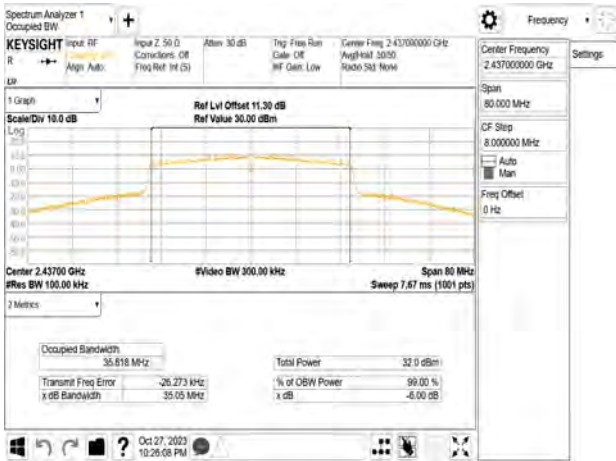

802.11n_40MHz_Chain1_2437MHz



802.11n_40MHz_Chain0_2452MHz

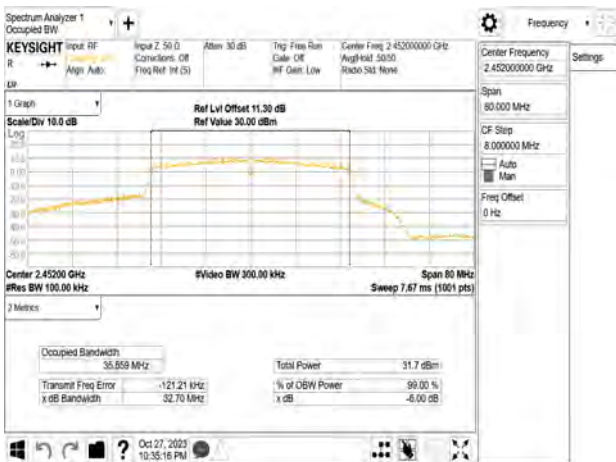

802.11n_40MHz_Chain1_2452MHz

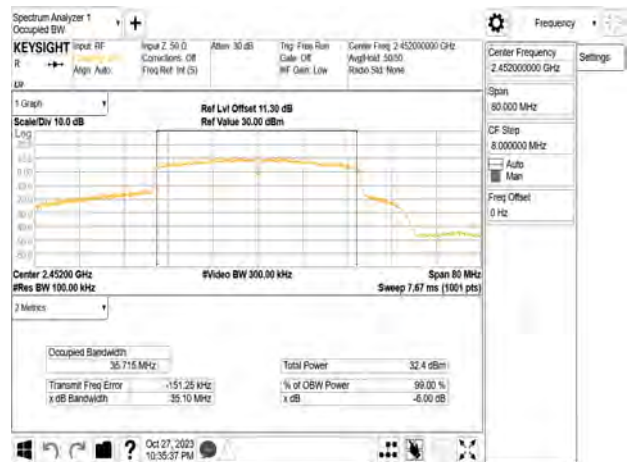

Unless otherwise stated the results shown in this test report refer only to the sample(s) tested and such sample(s) are retained for 90 days only.

除非另有說明，此報告結果僅對測試之樣品負責，同時此樣品僅保留90天。本報告未經本公司書面許可，不可部份複製。

This document is issued by the Company subject to its General Conditions of Service printed overleaf, available on request or accessible at <http://www.sgs.com.tw/Terms-and-Conditions> and for electronic format documents, subject to Terms and Conditions for Electronic Documents at <http://www.sgs.com.tw/Terms-and-Conditions>. Attention is drawn to the limitation of liability, indemnification and jurisdiction issues defined therein. Any holder of this document is advised that information contained hereon reflects the Company's findings at the time of its intervention only and within the limits of Client's instructions, if any. The Company's sole responsibility is to its Client and this document does not exonerate parties to a transaction from exercising all their rights and obligations under the transaction documents. This document cannot be reproduced except in full, without prior written approval of the Company. Any unauthorized alteration, forgery or falsification of the content or appearance of this document is unlawful and offenders may be prosecuted to the fullest extent of the law.

802.11n_40MHz_Chain2_2422MHz

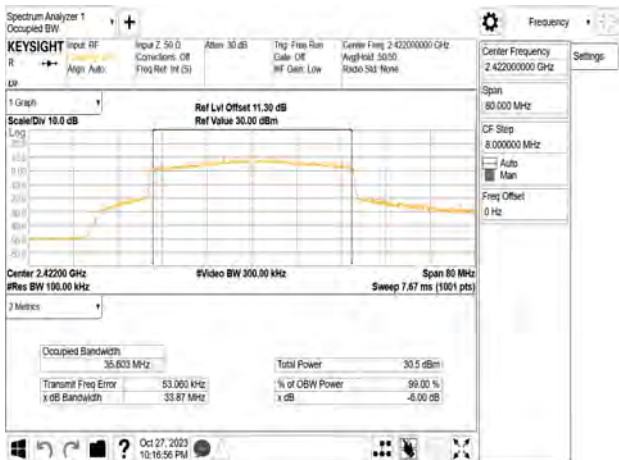

802.11n_40MHz_Chain3_2422MHz

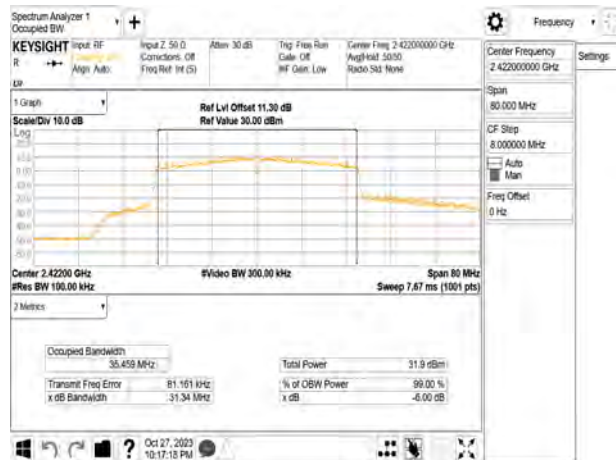

802.11n_40MHz_Chain2_2437MHz

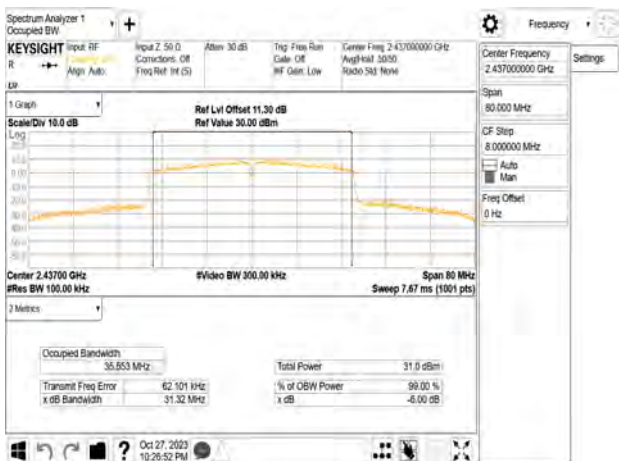

802.11n_40MHz_Chain3_2437MHz

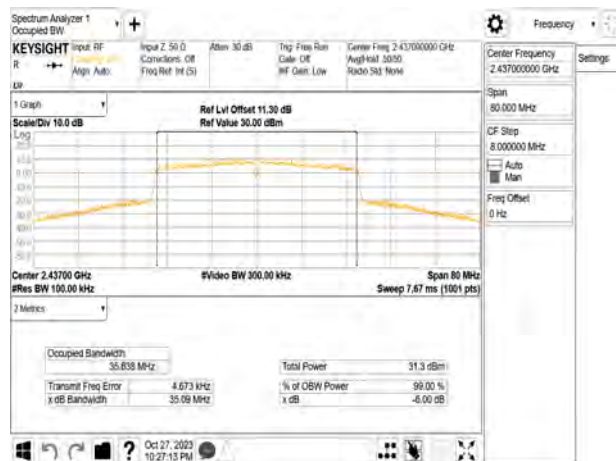

802.11n_40MHz_Chain2_2452MHz

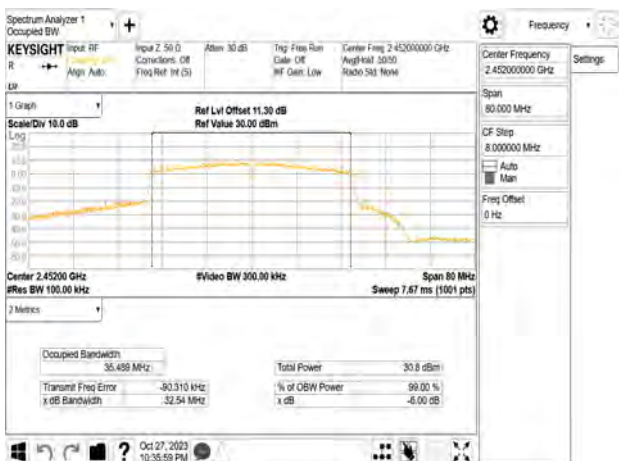

802.11n_40MHz_Chain3_2452MHz

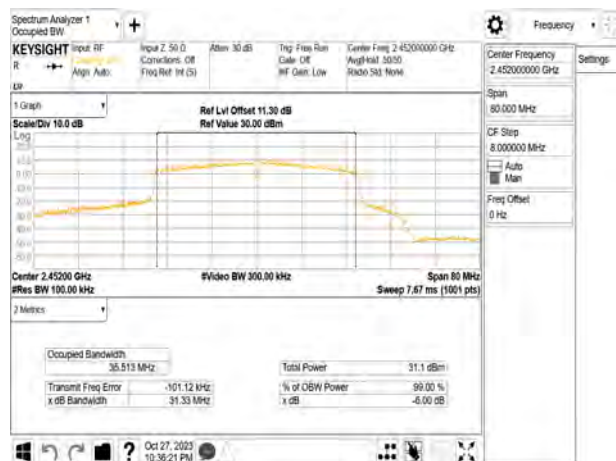

Unless otherwise stated the results shown in this test report refer only to the sample(s) tested and such sample(s) are retained for 90 days only.

除非另有說明，此報告結果僅對測試之樣品負責，同時此樣品僅保留90天。本報告未經本公司書面許可，不可部份複製。

This document is issued by the Company subject to its General Conditions of Service printed overleaf, available on request or accessible at <http://www.sgs.com.tw/Terms-and-Conditions> and for electronic format documents, subject to Terms and Conditions for Electronic Documents at <http://www.sgs.com.tw/Terms-and-Conditions>. Attention is drawn to the limitation of liability, indemnification and jurisdiction issues defined therein. Any holder of this document is advised that information contained hereon reflects the Company's findings at the time of its intervention only and within the limits of Client's instructions, if any. The Company's sole responsibility is to its Client and this document does not exonerate parties to a transaction from exercising all their rights and obligations under the transaction documents. This document cannot be reproduced except in full, without prior written approval of the Company. Any unauthorized alteration, forgery or falsification of the content or appearance of this document is unlawful and offenders may be prosecuted to the fullest extent of the law.

802.11be_20MHz_Chain0_2412MHz

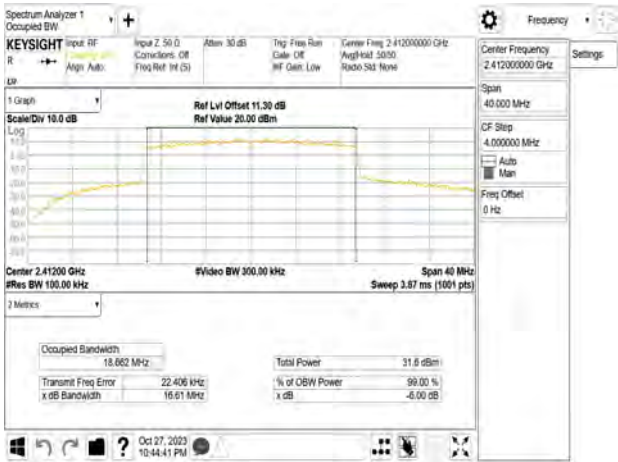

802.11be_20MHz_Chain1_2412MHz



802.11be_20MHz_Chain0_2437MHz



802.11be_20MHz_Chain1_2437MHz



802.11be_20MHz_Chain0_2462MHz



802.11be_20MHz_Chain1_2462MHz



Unless otherwise stated the results shown in this test report refer only to the sample(s) tested and such sample(s) are retained for 90 days only.

除非另有說明，此報告結果僅對測試之樣品負責，同時此樣品僅保留90天。本報告未經本公司書面許可，不可部份複製。

This document is issued by the Company subject to its General Conditions of Service printed overleaf, available on request or accessible at <http://www.sgs.com.tw/Terms-and-Conditions> and for electronic format documents, subject to Terms and Conditions for Electronic Documents at <http://www.sgs.com.tw/Terms-and-Conditions>. Attention is drawn to the limitation of liability, indemnification and jurisdiction issues defined therein. Any holder of this document is advised that information contained hereon reflects the Company's findings at the time of its intervention only and within the limits of Client's instructions, if any. The Company's sole responsibility is to its Client and this document does not exonerate parties to a transaction from exercising all their rights and obligations under the transaction documents. This document cannot be reproduced except in full, without prior written approval of the Company. Any unauthorized alteration, forgery or falsification of the content or appearance of this document is unlawful and offenders may be prosecuted to the fullest extent of the law.

802.11be_20MHz_Chain2_2412MHz

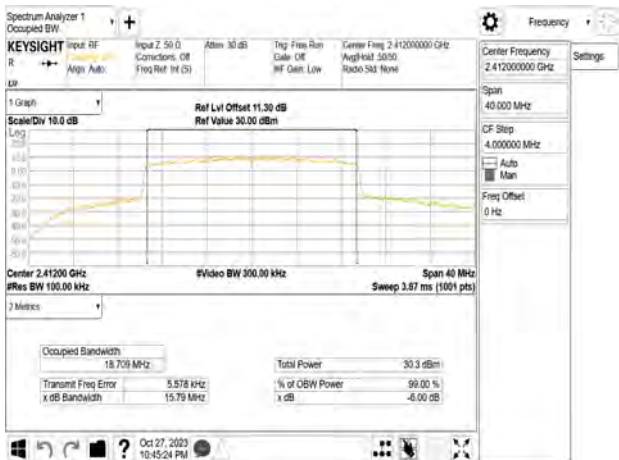

802.11be_20MHz_Chain3_2412MHz



802.11be_20MHz_Chain2_2437MHz

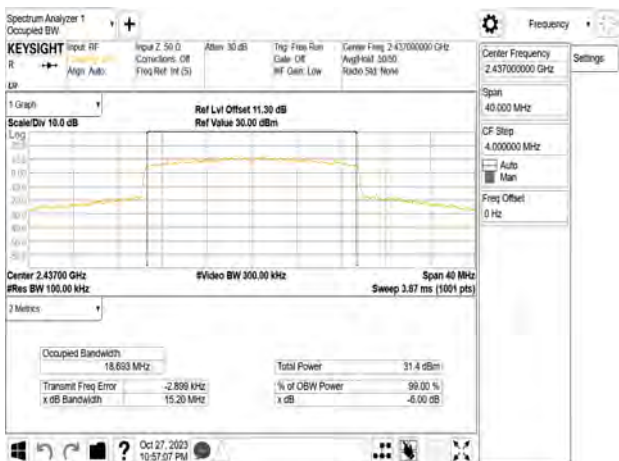

802.11be_20MHz_Chain3_2437MHz

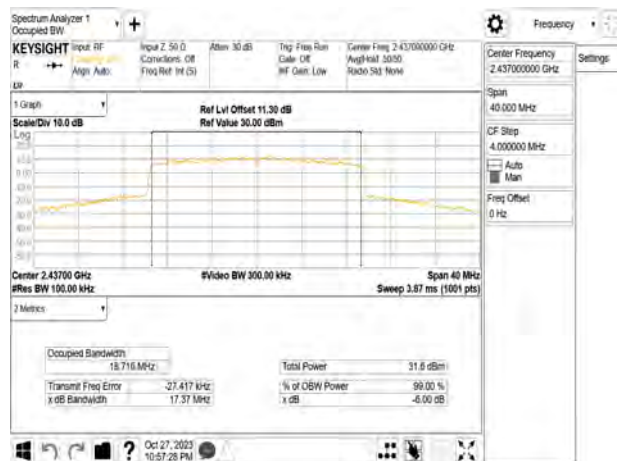

802.11be_20MHz_Chain2_2462MHz

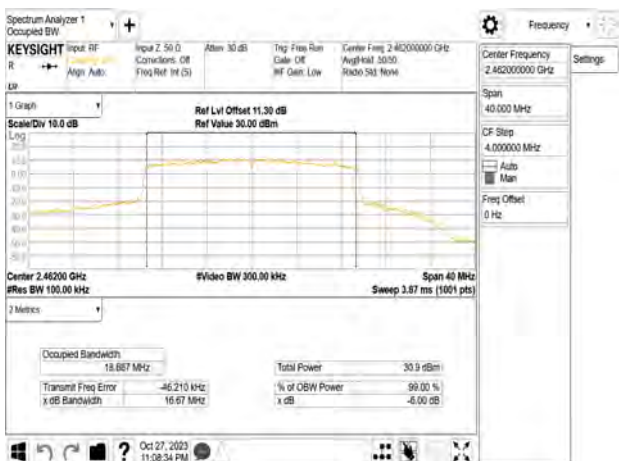

802.11be_20MHz_Chain3_2462MHz

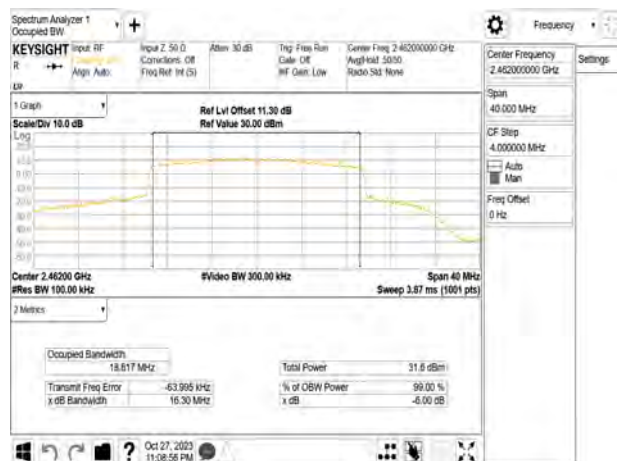

Unless otherwise stated the results shown in this test report refer only to the sample(s) tested and such sample(s) are retained for 90 days only.

除非另有說明，此報告結果僅對測試之樣品負責，同時此樣品僅保留90天。本報告未經本公司書面許可，不可部份複製。

This document is issued by the Company subject to its General Conditions of Service printed overleaf, available on request or accessible at <http://www.sgs.com.tw/Terms-and-Conditions> and for electronic format documents, subject to Terms and Conditions for Electronic Documents at <http://www.sgs.com.tw/Terms-and-Conditions>. Attention is drawn to the limitation of liability, indemnification and jurisdiction issues defined therein. Any holder of this document is advised that information contained hereon reflects the Company's findings at the time of its intervention only and within the limits of Client's instructions, if any. The Company's sole responsibility is to its Client and this document does not exonerate parties to a transaction from exercising all their rights and obligations under the transaction documents. This document cannot be reproduced except in full, without prior written approval of the Company. Any unauthorized alteration, forgery or falsification of the content or appearance of this document is unlawful and offenders may be prosecuted to the fullest extent of the law.

802.11be_40MHz_Chain0_2422MHz

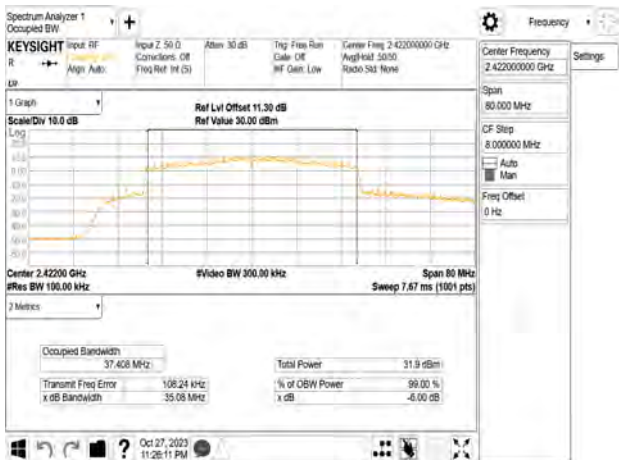

802.11be_40MHz_Chain1_2422MHz



802.11be_40MHz_Chain0_2437MHz

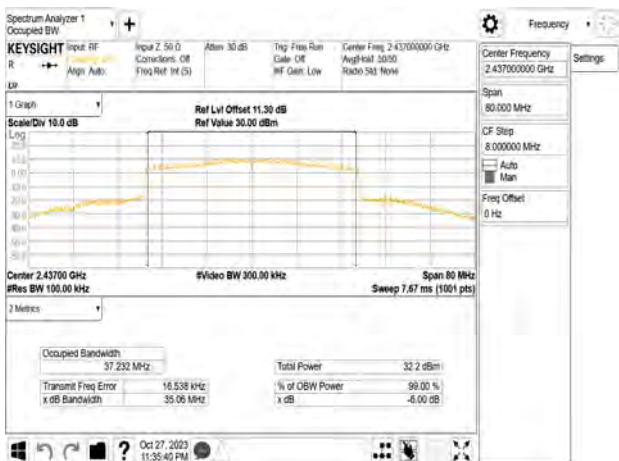

802.11be_40MHz_Chain1_2437MHz

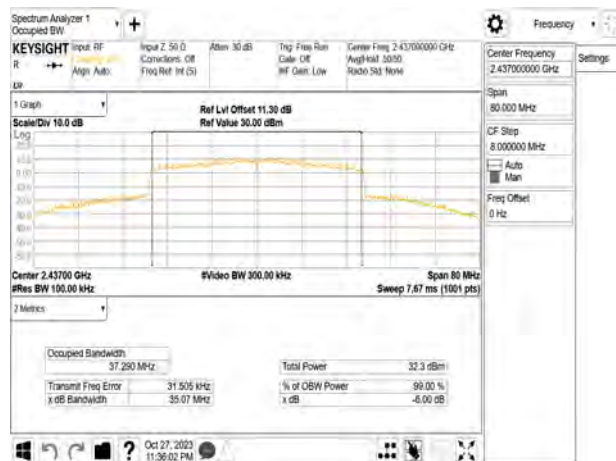

802.11be_40MHz_Chain0_2452MHz



802.11be_40MHz_Chain1_2452MHz



Unless otherwise stated the results shown in this test report refer only to the sample(s) tested and such sample(s) are retained for 90 days only.

除非另有說明，此報告結果僅對測試之樣品負責，同時此樣品僅保留90天。本報告未經本公司書面許可，不可部份複製。

This document is issued by the Company subject to its General Conditions of Service printed overleaf, available on request or accessible at <http://www.sgs.com.tw/Terms-and-Conditions> and for electronic format documents, subject to Terms and Conditions for Electronic Documents at <http://www.sgs.com.tw/Terms-and-Conditions>. Attention is drawn to the limitation of liability, indemnification and jurisdiction issues defined therein. Any holder of this document is advised that information contained hereon reflects the Company's findings at the time of its intervention only and within the limits of Client's instructions, if any. The Company's sole responsibility is to its Client and this document does not exonerate parties to a transaction from exercising all their rights and obligations under the transaction documents. This document cannot be reproduced except in full, without prior written approval of the Company. Any unauthorized alteration, forgery or falsification of the content or appearance of this document is unlawful and offenders may be prosecuted to the fullest extent of the law.

802.11be_40MHz_Chain2_2422MHz

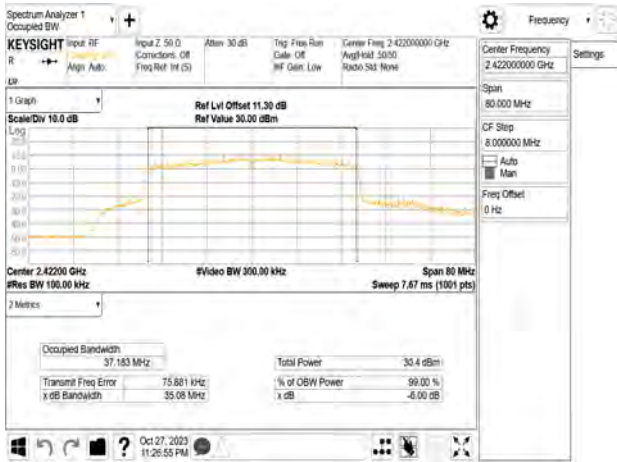

802.11be_40MHz_Chain3_2422MHz

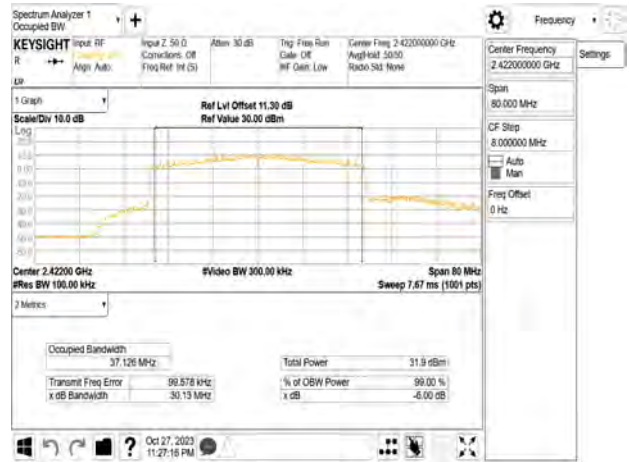

802.11be_40MHz_Chain2_2437MHz

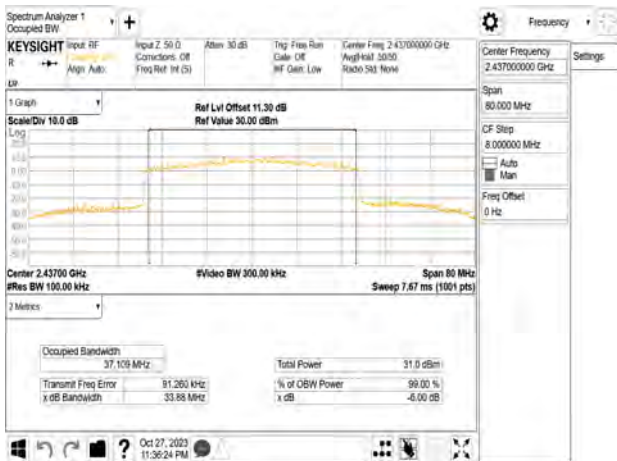

802.11be_40MHz_Chain3_2437MHz

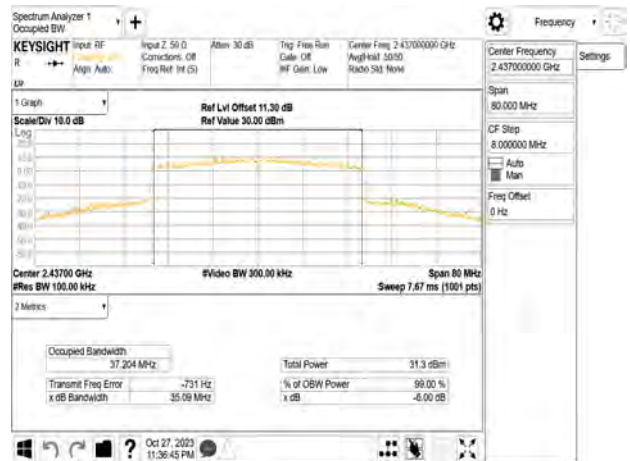

802.11be_40MHz_Chain2_2452MHz



802.11be_40MHz_Chain3_2452MHz



Unless otherwise stated the results shown in this test report refer only to the sample(s) tested and such sample(s) are retained for 90 days only.

除非另有說明，此報告結果僅對測試之樣品負責，同時此樣品僅保留90天。本報告未經本公司書面許可，不可部份複製。

This document is issued by the Company subject to its General Conditions of Service printed overleaf, available on request or accessible at <http://www.sgs.com.tw/Terms-and-Conditions> and for electronic format documents, subject to Terms and Conditions for Electronic Documents at <http://www.sgs.com.tw/Terms-and-Conditions>. Attention is drawn to the limitation of liability, indemnification and jurisdiction issues defined therein. Any holder of this document is advised that information contained hereon reflects the Company's findings at the time of its intervention only and within the limits of Client's instructions, if any. The Company's sole responsibility is to its Client and this document does not exonerate parties to a transaction from exercising all their rights and obligations under the transaction documents. This document cannot be reproduced except in full, without prior written approval of the Company. Any unauthorized alteration, forgery or falsification of the content or appearance of this document is unlawful and offenders may be prosecuted to the fullest extent of the law.

10 CONDUCTED BAND EDGES AND SPURIOUS EMISSION MEASUREMENT

10.1 Standard Applicable

In any 100 kHz bandwidth outside the frequency band in which the spread spectrum or digitally modulated intentional radiator is operating, the radio frequency power that is produced by the intentional radiator shall be at least 20 dB below for that in the 100 kHz bandwidth within the band that contains the highest level of the desired power, based on either an RF conducted or a radiated measurement, provided the transmitter demonstrates compliance with the peak conducted power limits or If the transmitter complies with the conducted power limits based on the use of RMS averaging over a time interval the attenuation required under this paragraph shall be 30 dB instead of 20 dB.

In addition, radiated emissions which fall in the restricted bands, as defined in §15.205(a), must also comply with the radiated emission limits specified in §15.209(a).

10.2 Test Setup

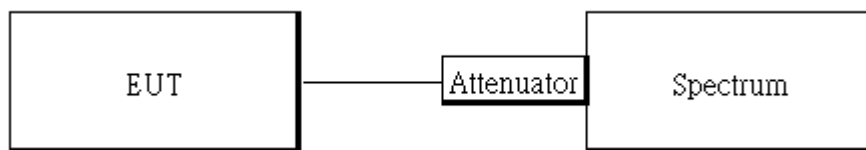

10.3 Measurement Procedure

10.3.1 Reference Level of Emission Limit:

1. Set analyzer center frequency to DTS channel center frequency.
2. The testing follows the Measurement Procedure of FCC KDB 558074 D01 DTS Meas. Guidance .
3. Set the span to 1.5 times the DTS channel bandwidth.
4. Set the RBW = 100kHz & VBW = 300 kHz.
5. Detector = peak.
6. Sweep time = auto couple.
7. Trace mode = max hold.
8. Allow trace to fully stabilize.
9. Use the peak marker function to determine the maximum amplitude level.
10. MIMO mode: offset is set following “measure and add 10 Log (N)” on spectrum to measure for MIMO mode. Offset = cable loss + 10 log (N), where N is number of transmitting antenna.

Unless otherwise stated the results shown in this test report refer only to the sample(s) tested and such sample(s) are retained for 90 days only.
除非另有說明，此報告結果僅對測試之樣品負責，同時此樣品僅保留90天。本報告未經本公司書面許可，不可部份複製。

This document is issued by the Company subject to its General Conditions of Service printed overleaf, available on request or accessible at <http://www.sgs.com.tw/Terms-and-Conditions> and for electronic format documents, subject to Terms and Conditions for Electronic Documents at <http://www.sgs.com.tw/Terms-and-Conditions>. Attention is drawn to the limitation of liability, indemnification and jurisdiction issues defined therein. Any holder of this document is advised that information contained hereon reflects the Company's findings at the time of its intervention only and within the limits of Client's instructions, if any. The Company's sole responsibility is to its Client and this document does not exonerate parties to a transaction from exercising all their rights and obligations under the transaction documents. This document cannot be reproduced except in full, without prior written approval of the Company. Any unauthorized alteration, forgery or falsification of the content or appearance of this document is unlawful and offenders may be prosecuted to the fullest extent of the law.

10.3.2 Conducted Band Edge:

1. To connect Antenna Port of EUT to Spectrum.
2. The testing follows the Measurement Procedure of FCC KDB 558074 D01 DTS Meas. Guidance.
3. Remove the antenna from the EUT and then connect a low loss RF cable from the antenna port to the spectrum analyzer.
4. Set start to edge frequency, and stop frequency of spectrum analyzer so as to encompass the spectrum to be examined.
5. Set the spectrum analyzer as RBW=100 kHz, VBW=300 kHz, Detector = Peak, Sweep = auto
6. Mark the highest reading of the emission as the reference level measurement.
7. Set DL as the limit = reading on marker of reference level measurement – 30dBm
8. Mark the highest readings of the emissions outside of 2400MHz~2483.5MHz.
9. Repeat above procedures until all default test channel (low, middle, and high) was complete.
10. MIMO mode: offset is set following “measure and add 10 Log (N)” on spectrum to measure for MIMO mode. Offset = cable loss + 10 log (N), where N is number of transmitting antenna.

Unless otherwise stated the results shown in this test report refer only to the sample(s) tested and such sample(s) are retained for 90 days only.
除非另有說明，此報告結果僅對測試之樣品負責，同時此樣品僅保留90天。本報告未經本公司書面許可，不可部份複製。

This document is issued by the Company subject to its General Conditions of Service printed overleaf, available on request or accessible at <http://www.sgs.com.tw/Terms-and-Conditions> and for electronic format documents, subject to Terms and Conditions for Electronic Documents at <http://www.sgs.com.tw/Terms-and-Conditions>. Attention is drawn to the limitation of liability, indemnification and jurisdiction issues defined therein. Any holder of this document is advised that information contained hereon reflects the Company's findings at the time of its intervention only and within the limits of Client's instructions, if any. The Company's sole responsibility is to its Client and this document does not exonerate parties to a transaction from exercising all their rights and obligations under the transaction documents. This document cannot be reproduced except in full, without prior written approval of the Company. Any unauthorized alteration, forgery or falsification of the content or appearance of this document is unlawful and offenders may be prosecuted to the fullest extent of the law.

Conducted Spurious Emission:

1. To connect Antenna Port of EUT to Spectrum
2. The testing follows the Measurement Procedure of FCC KDB 558074 D01 DTS Meas. Guidance .
3. Set RBW = 100 kHz & VBW= 300 kHz, Detector =Peak, Sweep = Auto.
4. Allow trace to fully stabilize.
5. Use the peak marker function to determine the maximum power level in any 100 kHz band segment within the fundamental EBW.
6. Repeat above procedures until all default test channel measured were complete.
7. MIMO mode: offset is set following “measure and add 10 Log (N)” on spectrum to measure for MIMO mode. Offset = cable loss + 10 log (N), where N is number of transmitting antenna.

Note:

For test of MIMO mode, the highest emission of worst case employing Measure and add 10 log (N) technical is reported on this report after the comparison between Main Antenna at single transmitting mode and Aux that yields the higher value. The MIMO transmitting mode produces higher value of outcome.

Unless otherwise stated the results shown in this test report refer only to the sample(s) tested and such sample(s) are retained for 90 days only.
除非另有說明，此報告結果僅對測試之樣品負責，同時此樣品僅保留90天。本報告未經本公司書面許可，不可部份複製。

This document is issued by the Company subject to its General Conditions of Service printed overleaf, available on request or accessible at <http://www.sgs.com.tw/Terms-and-Conditions> and for electronic format documents, subject to Terms and Conditions for Electronic Documents at <http://www.sgs.com.tw/Terms-and-Conditions>. Attention is drawn to the limitation of liability, indemnification and jurisdiction issues defined therein. Any holder of this document is advised that information contained hereon reflects the Company's findings at the time of its intervention only and within the limits of Client's instructions, if any. The Company's sole responsibility is to its Client and this document does not exonerate parties to a transaction from exercising all their rights and obligations under the transaction documents. This document cannot be reproduced except in full, without prior written approval of the Company. Any unauthorized alteration, forgery or falsification of the content or appearance of this document is unlawful and offenders may be prosecuted to the fullest extent of the law.

10.4 Measurement Result

Mode: CDD

802.11b Ch0

Reference Level of Limit		
Freq. (MHz)	PSD (dBm)	Reference Level of Limit (dBm)
2412	15.80	-14.20
2437	16.74	-13.26
2462	15.77	-14.23

802.11b Ch1

Reference Level of Limit		
Freq. (MHz)	PSD (dBm)	Reference Level of Limit (dBm)
2412	17.01	-12.99
2437	17.01	-12.99
2462	16.72	-13.28

802.11b Ch2

Reference Level of Limit		
Freq. (MHz)	PSD (dBm)	Reference Level of Limit (dBm)
2412	14.76	-15.24
2437	15.69	-14.31
2462	15.04	-14.96

802.11b Ch3

Reference Level of Limit		
Freq. (MHz)	PSD (dBm)	Reference Level of Limit (dBm)
2412	16.51	-13.49
2437	15.66	-14.34
2462	15.71	-14.29

802.11g Ch0

Reference Level of Limit		
Freq. (MHz)	PSD (dBm)	Reference Level of Limit (dBm)
2412	13.54	-16.46
2437	13.72	-16.28
2462	13.49	-16.51

802.11g Ch1

Reference Level of Limit		
Freq. (MHz)	PSD (dBm)	Reference Level of Limit (dBm)
2412	14.74	-15.26
2437	14.40	-15.60
2462	14.54	-15.46

802.11g Ch2

Reference Level of Limit		
Freq. (MHz)	PSD (dBm)	Reference Level of Limit (dBm)
2412	12.10	-17.90
2437	12.30	-17.70
2462	12.24	-17.76

802.11g Ch3

Reference Level of Limit		
Freq. (MHz)	PSD (dBm)	Reference Level of Limit (dBm)
2412	14.47	-15.53
2437	13.09	-16.91
2462	13.32	-16.68

Unless otherwise stated the results shown in this test report refer only to the sample(s) tested and such sample(s) are retained for 90 days only.

除非另有說明，此報告結果僅對測試之樣品負責，同時此樣品僅保留90天。本報告未經本公司書面許可，不可部份複製。

This document is issued by the Company subject to its General Conditions of Service printed overleaf, available on request or accessible at <http://www.sgs.com.tw/Terms-and-Conditions> and for electronic format documents, subject to Terms and Conditions for Electronic Documents at <http://www.sgs.com.tw/Terms-and-Conditions>. Attention is drawn to the limitation of liability, indemnification and jurisdiction issues defined therein. Any holder of this document is advised that information contained hereon reflects the Company's findings at the time of its intervention only and within the limits of Client's instructions, if any. The Company's sole responsibility is to its Client and this document does not exonerate parties to a transaction from exercising all their rights and obligations under the transaction documents. This document cannot be reproduced except in full, without prior written approval of the Company. Any unauthorized alteration, forgery or falsification of the content or appearance of this document is unlawful and offenders may be prosecuted to the fullest extent of the law.

802.11n_HT_20M Ch0

Reference Level of Limit			Reference Level of Limit		
Freq. (MHz)	PSD (dBm)	Reference Level of Limit (dBm)	Freq. (MHz)	PSD (dBm)	Reference Level of Limit (dBm)
2412	14.56	-15.44	2412	15.06	-14.94
2437	14.77	-15.23	2437	14.19	-15.81
2462	13.54	-16.46	2462	14.21	-15.79

802.11n_HT_20M Ch1

802.11n_HT_20M Ch2

Reference Level of Limit			Reference Level of Limit		
Freq. (MHz)	PSD (dBm)	Reference Level of Limit (dBm)	Freq. (MHz)	PSD (dBm)	Reference Level of Limit (dBm)
2412	12.91	-17.09	2412	14.61	-15.39
2437	13.34	-16.66	2437	13.45	-16.55
2462	12.84	-17.16	2462	13.91	-16.09

802.11n_HT_20M Ch3

802.11n_HT_40M Ch0

Reference Level of Limit			Reference Level of Limit		
Freq. (MHz)	PSD (dBm)	Reference Level of Limit (dBm)	Freq. (MHz)	PSD (dBm)	Reference Level of Limit (dBm)
2422	11.78	-18.22	2422	12.9	-17.10
2437	11.53	-18.47	2437	12.49	-17.51
2452	11.53	-18.47	2452	12.04	-17.96

802.11n_HT_40M Ch1

802.11n_HT_40M Ch2

Reference Level of Limit			Reference Level of Limit		
Freq. (MHz)	PSD (dBm)	Reference Level of Limit (dBm)	Freq. (MHz)	PSD (dBm)	Reference Level of Limit (dBm)
2422	10.32	-19.68	2422	12.05	-17.95
2437	11.34	-18.66	2437	10.80	-19.20
2452	10.53	-19.47	2452	11.14	-18.86

802.11n_HT_40M Ch3

802.11be_EHT_20M Ch0

Reference Level of Limit			Reference Level of Limit		
Freq. (MHz)	PSD (dBm)	Reference Level of Limit (dBm)	Freq. (MHz)	PSD (dBm)	Reference Level of Limit (dBm)
2412	12.77	-17.23	2412	14.76	-15.24
2437	13.99	-16.01	2437	14.88	-15.12
2462	14.54	-15.46	2462	14.94	-15.06

802.11be_EHT_20M Ch1

Unless otherwise stated the results shown in this test report refer only to the sample(s) tested and such sample(s) are retained for 90 days only.

除非另有說明，此報告結果僅對測試之樣品負責，同時此樣品僅保留90天。本報告未經本公司書面許可，不可部份複製。

This document is issued by the Company subject to its General Conditions of Service printed overleaf, available on request or accessible at <http://www.sgs.com.tw/Terms-and-Conditions>, and for electronic format documents, subject to Terms and Conditions for Electronic Documents at <http://www.sgs.com.tw/Terms-and-Conditions>. Attention is drawn to the limitation of liability, indemnification and jurisdiction issues defined therein. Any holder of this document is advised that information contained hereon reflects the Company's findings at the time of its intervention only and within the limits of Client's instructions, if any. The Company's sole responsibility is to its Client and this document does not exonerate parties to a transaction from exercising all their rights and obligations under the transaction documents. This document cannot be reproduced except in full, without prior written approval of the Company. Any unauthorized alteration, forgery or falsification of the content or appearance of this document is unlawful and offenders may be prosecuted to the fullest extent of the law.

802.11be_EHT_20M Ch2

Reference Level of Limit			Reference Level of Limit		
Freq. (MHz)	PSD (dBm)	Reference Level of Limit (dBm)	Freq. (MHz)	PSD (dBm)	Reference Level of Limit (dBm)
2412	12.30	-17.70	2412	13.70	-16.30
2437	13.78	-16.22	2437	13.42	-16.58
2462	13.05	-16.95	2462	13.70	-16.30

802.11be_EHT_20M Ch3

802.11be_EHT_40M Ch0

Reference Level of Limit			Reference Level of Limit		
Freq. (MHz)	PSD (dBm)	Reference Level of Limit (dBm)	Freq. (MHz)	PSD (dBm)	Reference Level of Limit (dBm)
2422	11	-19.00	2422	12.37	-17.63
2437	11.25	-18.75	2437	11.80	-18.20
2452	11.81	-18.19	2452	11.71	-18.29

802.11be_EHT_40M Ch1

802.11be_EHT_40M Ch2

Reference Level of Limit			Reference Level of Limit		
Freq. (MHz)	PSD (dBm)	Reference Level of Limit (dBm)	Freq. (MHz)	PSD (dBm)	Reference Level of Limit (dBm)
2422	9.56	-20.44	2422	11.83	-18.17
2437	10.30	-19.70	2437	10.96	-19.04
2452	10.92	-19.08	2452	11.37	-18.63

802.11be_EHT_40M Ch3

Unless otherwise stated the results shown in this test report refer only to the sample(s) tested and such sample(s) are retained for 90 days only.

除非另有說明，此報告結果僅對測試之樣品負責，同時此樣品僅保留90天。本報告未經本公司書面許可，不可部份複製。

This document is issued by the Company subject to its General Conditions of Service printed overleaf, available on request or accessible at <http://www.sgs.com.tw/Terms-and-Conditions> and for electronic format documents, subject to Terms and Conditions for Electronic Documents at <http://www.sgs.com.tw/Terms-and-Conditions>. Attention is drawn to the limitation of liability, indemnification and jurisdiction issues defined therein. Any holder of this document is advised that information contained hereon reflects the Company's findings at the time of its intervention only and within the limits of Client's instructions, if any. The Company's sole responsibility is to its Client and this document does not exonerate parties to a transaction from exercising all their rights and obligations under the transaction documents. This document cannot be reproduced except in full, without prior written approval of the Company. Any unauthorized alteration, forgery or falsification of the content or appearance of this document is unlawful and offenders may be prosecuted to the fullest extent of the law.

CDD_802.11b_20MHz_Chain0_2412MHz

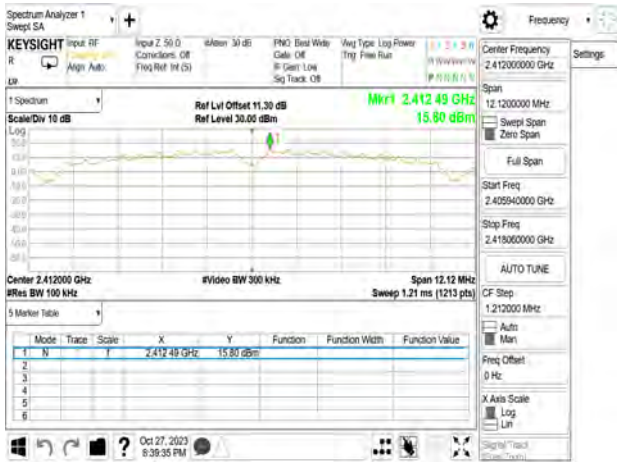

802.11b_20MHz_Chain1_2412MHz

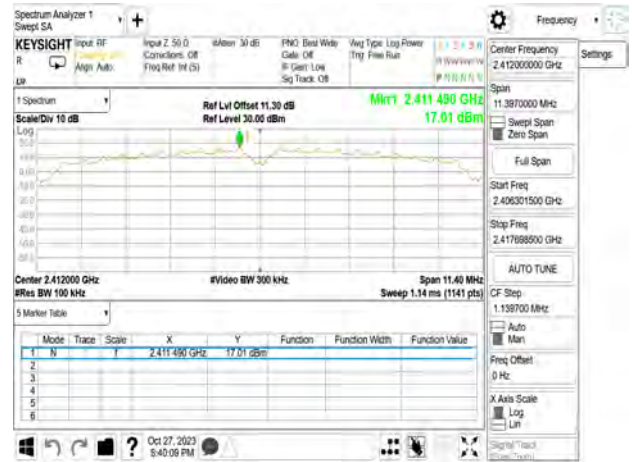

802.11b_20MHz_Chain0_2437MHz

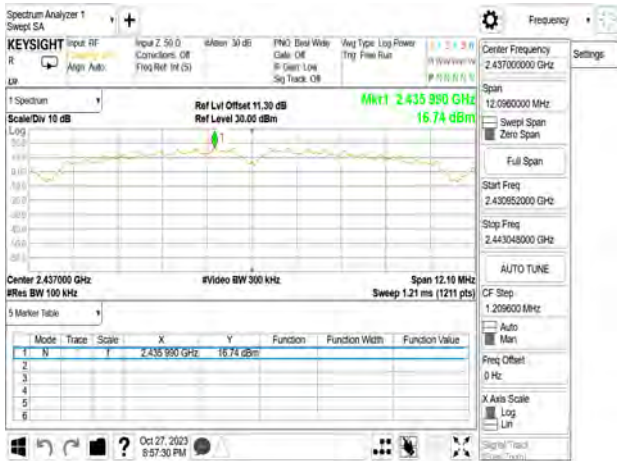

802.11b_20MHz_Chain1_2437MHz



802.11b_20MHz_Chain0_2462MHz

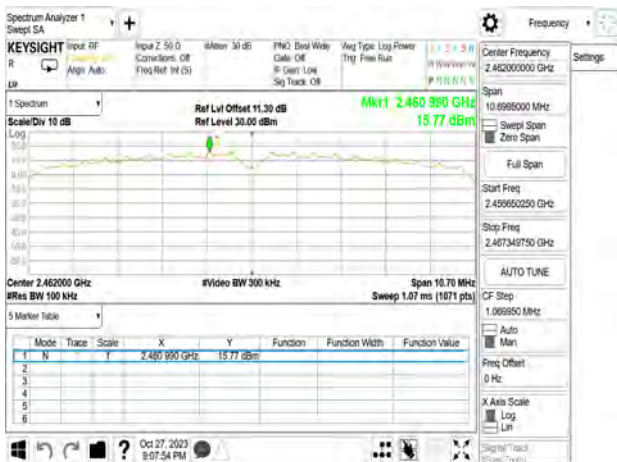

802.11b_20MHz_Chain1_2462MHz



Unless otherwise stated the results shown in this test report refer only to the sample(s) tested and such sample(s) are retained for 90 days only.

除非另有說明，此報告結果僅對測試之樣品負責，同時此樣品僅保留90天。本報告未經本公司書面許可，不可部份複製。

This document is issued by the Company subject to its General Conditions of Service printed overleaf, available on request or accessible at <http://www.sgs.com.tw/Terms-and-Conditions> and for electronic format documents, subject to Terms and Conditions for Electronic Documents at <http://www.sgs.com.tw/Terms-and-Conditions>. Attention is drawn to the limitation of liability, indemnification and jurisdiction issues defined therein. Any holder of this document is advised that information contained hereon reflects the Company's findings at the time of its intervention only and within the limits of Client's instructions, if any. The Company's sole responsibility is to its Client and this document does not exonerate parties to a transaction from exercising all their rights and obligations under the transaction documents. This document cannot be reproduced except in full, without prior written approval of the Company. Any unauthorized alteration, forgery or falsification of the content or appearance of this document is unlawful and offenders may be prosecuted to the fullest extent of the law.

802.11b_20MHz_Chain2_2412MHz

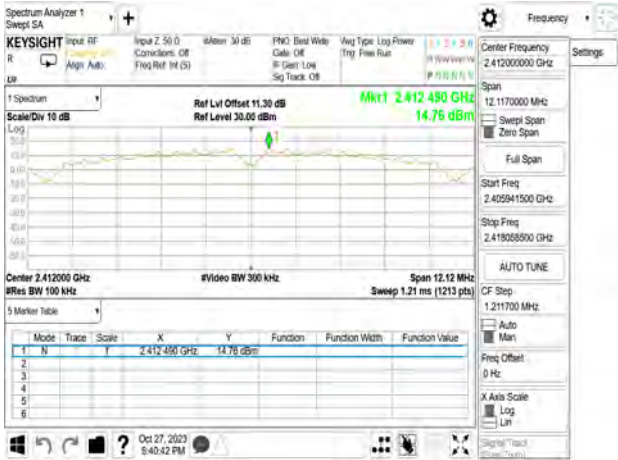

802.11b_20MHz_Chain3_2412MHz



802.11b_20MHz_Chain2_2437MHz

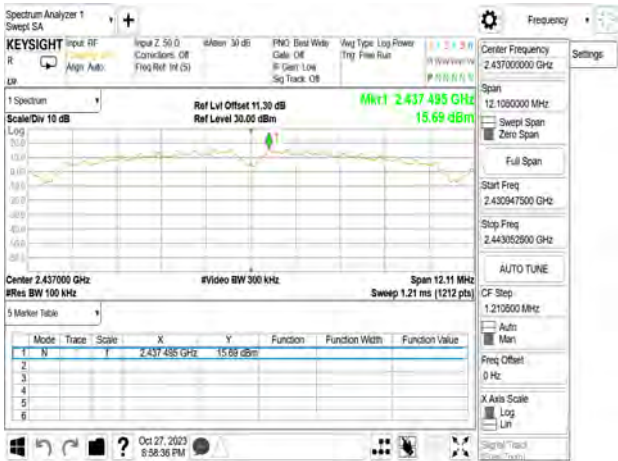

802.11b_20MHz_Chain3_2437MHz

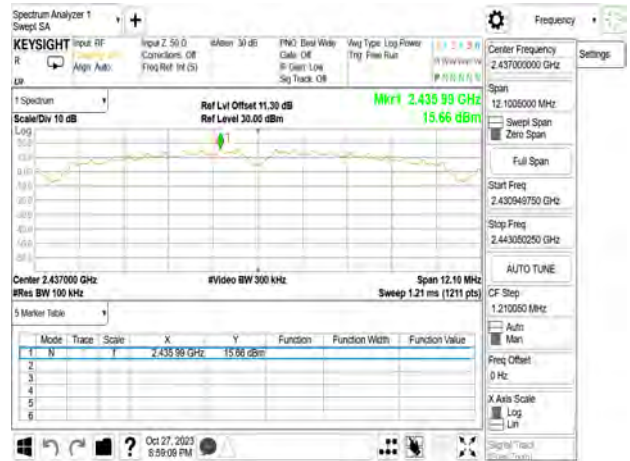

802.11b_20MHz_Chain2_2462MHz

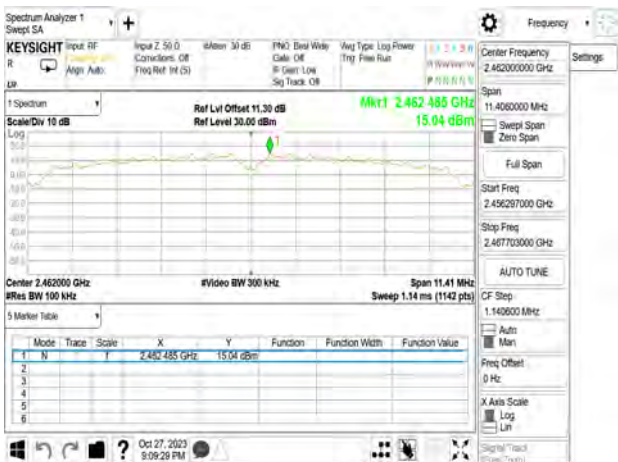

802.11b_20MHz_Chain3_2462MHz

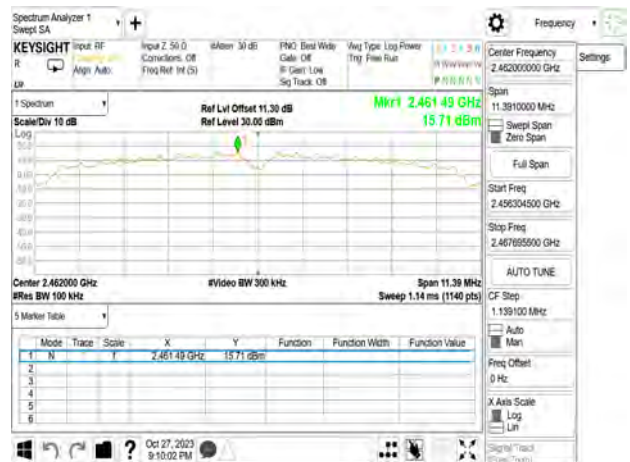

Unless otherwise stated the results shown in this test report refer only to the sample(s) tested and such sample(s) are retained for 90 days only.

除非另有說明，此報告結果僅對測試之樣品負責，同時此樣品僅保留90天。本報告未經本公司書面許可，不可部份複製。

This document is issued by the Company subject to its General Conditions of Service printed overleaf, available on request or accessible at <http://www.sgs.com.tw/Terms-and-Conditions> and for electronic format documents, subject to Terms and Conditions for Electronic Documents at <http://www.sgs.com.tw/Terms-and-Conditions>. Attention is drawn to the limitation of liability, indemnification and jurisdiction issues defined therein. Any holder of this document is advised that information contained hereon reflects the Company's findings at the time of its intervention only and within the limits of Client's instructions, if any. The Company's sole responsibility is to its Client and this document does not exonerate parties to a transaction from exercising all their rights and obligations under the transaction documents. This document cannot be reproduced except in full, without prior written approval of the Company. Any unauthorized alteration, forgery or falsification of the content or appearance of this document is unlawful and offenders may be prosecuted to the fullest extent of the law.

802.11g_20MHz_Chain0_2412MHz



802.11g_20MHz_Chain1_2412MHz



802.11g_20MHz_Chain0_2437MHz

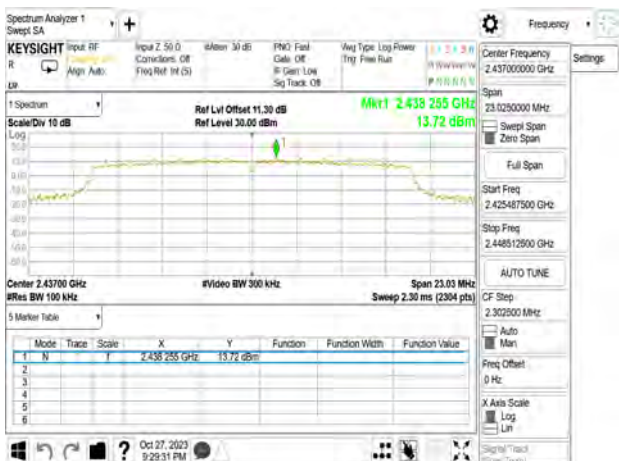

802.11g_20MHz_Chain1_2437MHz



802.11g_20MHz_Chain0_2462MHz



802.11g_20MHz_Chain1_2462MHz



Unless otherwise stated the results shown in this test report refer only to the sample(s) tested and such sample(s) are retained for 90 days only.

除非另有說明，此報告結果僅對測試之樣品負責，同時此樣品僅保留90天。本報告未經本公司書面許可，不可部份複製。

This document is issued by the Company subject to its General Conditions of Service printed overleaf, available on request or accessible at <http://www.sgs.com.tw/Terms-and-Conditions> and for electronic format documents, subject to Terms and Conditions for Electronic Documents at <http://www.sgs.com.tw/Terms-and-Conditions>. Attention is drawn to the limitation of liability, indemnification and jurisdiction issues defined therein. Any holder of this document is advised that information contained hereon reflects the Company's findings at the time of its intervention only and within the limits of Client's instructions, if any. The Company's sole responsibility is to its Client and this document does not exonerate parties to a transaction from exercising all their rights and obligations under the transaction documents. This document cannot be reproduced except in full, without prior written approval of the Company. Any unauthorized alteration, forgery or falsification of the content or appearance of this document is unlawful and offenders may be prosecuted to the fullest extent of the law.

802.11g_20MHz_Chain2_2412MHz

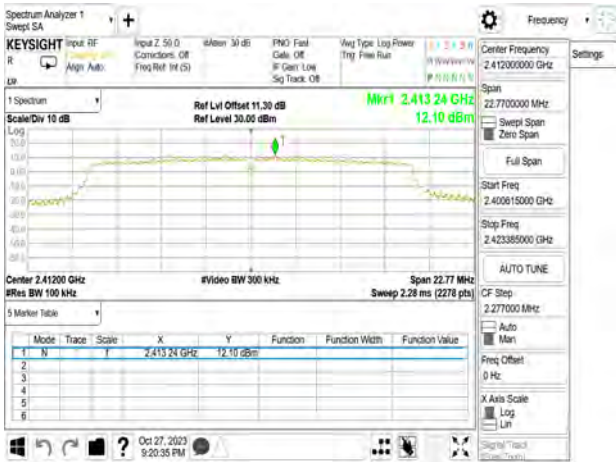

802.11g_20MHz_Chain3_2412MHz

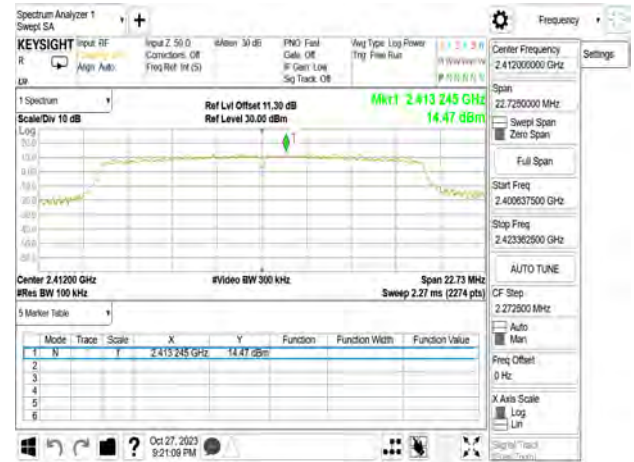

802.11g_20MHz_Chain2_2437MHz

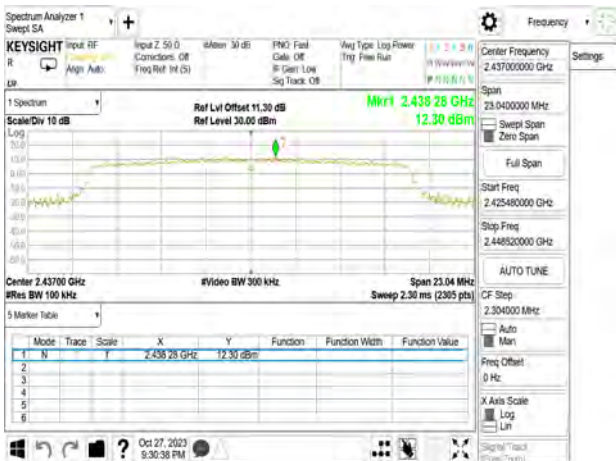

802.11g_20MHz_Chain3_2437MHz



802.11g_20MHz_Chain2_2462MHz

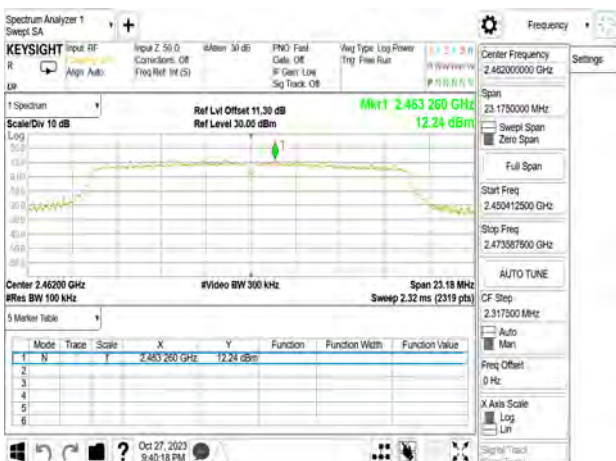

802.11g_20MHz_Chain3_2462MHz



Unless otherwise stated the results shown in this test report refer only to the sample(s) tested and such sample(s) are retained for 90 days only.

除非另有說明，此報告結果僅對測試之樣品負責，同時此樣品僅保留90天。本報告未經本公司書面許可，不可部份複製。

This document is issued by the Company subject to its General Conditions of Service printed overleaf, available on request or accessible at <http://www.sgs.com.tw/Terms-and-Conditions> and for electronic format documents, subject to Terms and Conditions for Electronic Documents at <http://www.sgs.com.tw/Terms-and-Conditions>. Attention is drawn to the limitation of liability, indemnification and jurisdiction issues defined therein. Any holder of this document is advised that information contained hereon reflects the Company's findings at the time of its intervention only and within the limits of Client's instructions, if any. The Company's sole responsibility is to its Client and this document does not exonerate parties to a transaction from exercising all their rights and obligations under the transaction documents. This document cannot be reproduced except in full, without prior written approval of the Company. Any unauthorized alteration, forgery or falsification of the content or appearance of this document is unlawful and offenders may be prosecuted to the fullest extent of the law.

802.11n_20MHz_Chain0_2412MHz



802.11n_20MHz_Chain1_2412MHz



802.11n_20MHz_Chain0_2437MHz

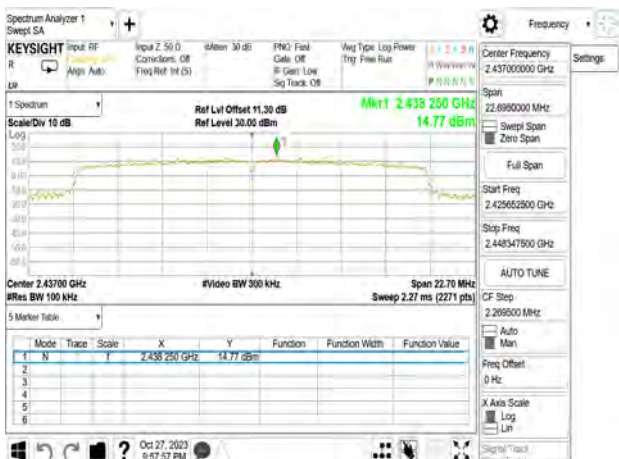

802.11n_20MHz_Chain1_2437MHz



802.11n_20MHz_Chain0_2462MHz

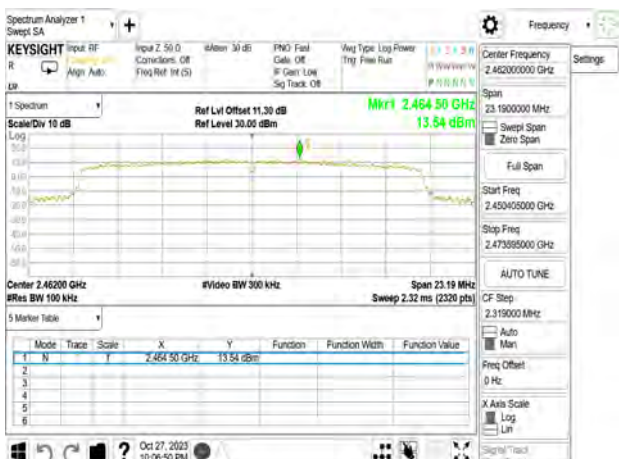

802.11n_20MHz_Chain1_2462MHz

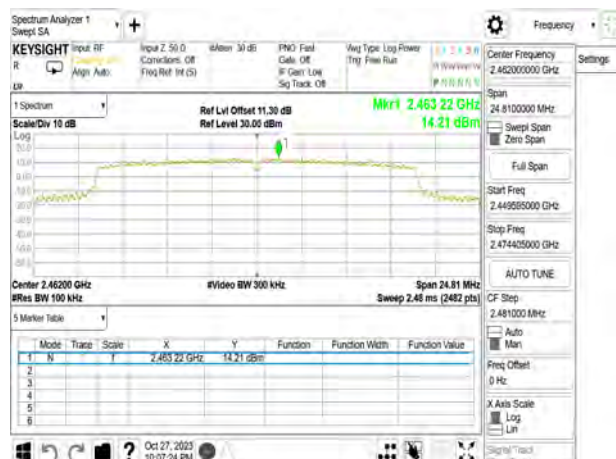

Unless otherwise stated the results shown in this test report refer only to the sample(s) tested and such sample(s) are retained for 90 days only.

除非另有說明，此報告結果僅對測試之樣品負責，同時此樣品僅保留90天。本報告未經本公司書面許可，不可部份複製。

This document is issued by the Company subject to its General Conditions of Service printed overleaf, available on request or accessible at <http://www.sgs.com.tw/Terms-and-Conditions> and for electronic format documents, subject to Terms and Conditions for Electronic Documents at <http://www.sgs.com.tw/Terms-and-Conditions>. Attention is drawn to the limitation of liability, indemnification and jurisdiction issues defined therein. Any holder of this document is advised that information contained hereon reflects the Company's findings at the time of its intervention only and within the limits of Client's instructions, if any. The Company's sole responsibility is to its Client and this document does not exonerate parties to a transaction from exercising all their rights and obligations under the transaction documents. This document cannot be reproduced except in full, without prior written approval of the Company. Any unauthorized alteration, forgery or falsification of the content or appearance of this document is unlawful and offenders may be prosecuted to the fullest extent of the law.

802.11n_20MHz_Chain2_2412MHz

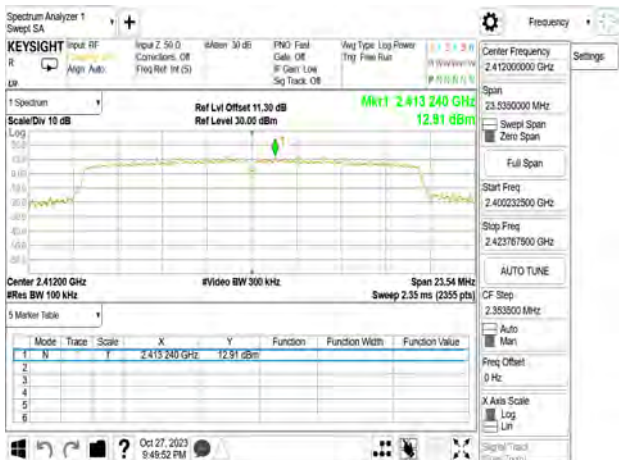

802.11n_20MHz_Chain3_2412MHz



802.11n_20MHz_Chain2_2437MHz

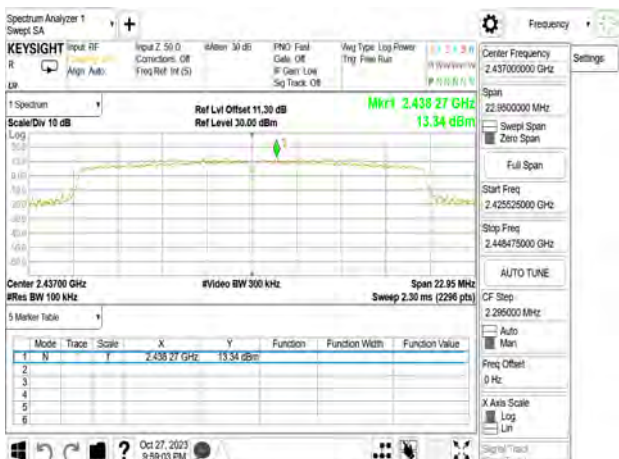

802.11n_20MHz_Chain3_2437MHz

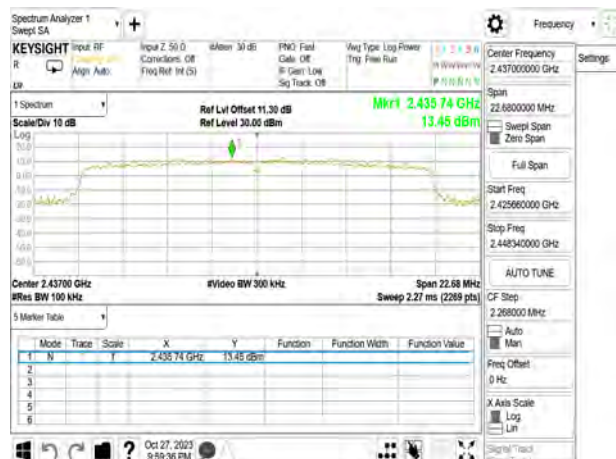

802.11n_20MHz_Chain2_2462MHz

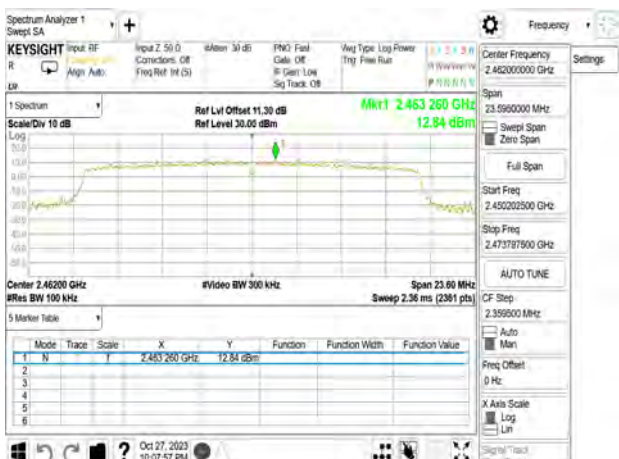

802.11n_20MHz_Chain3_2462MHz

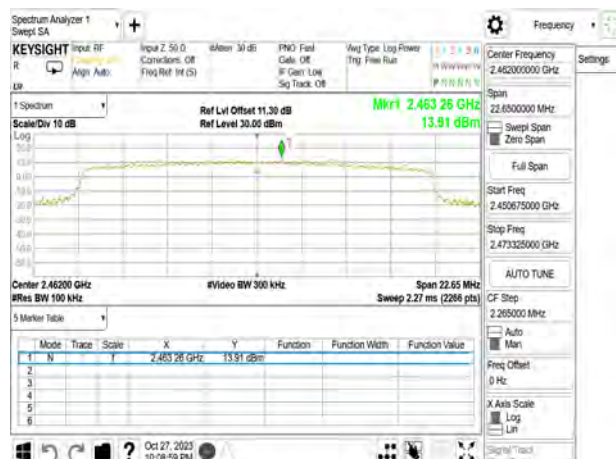

Unless otherwise stated the results shown in this test report refer only to the sample(s) tested and such sample(s) are retained for 90 days only.

除非另有說明，此報告結果僅對測試之樣品負責，同時此樣品僅保留90天。本報告未經本公司書面許可，不可部份複製。

This document is issued by the Company subject to its General Conditions of Service printed overleaf, available on request or accessible at <http://www.sgs.com.tw/Terms-and-Conditions> and for electronic format documents, subject to Terms and Conditions for Electronic Documents at <http://www.sgs.com.tw/Terms-and-Conditions>. Attention is drawn to the limitation of liability, indemnification and jurisdiction issues defined therein. Any holder of this document is advised that information contained hereon reflects the Company's findings at the time of its intervention only and within the limits of Client's instructions, if any. The Company's sole responsibility is to its Client and this document does not exonerate parties to a transaction from exercising all their rights and obligations under the transaction documents. This document cannot be reproduced except in full, without prior written approval of the Company. Any unauthorized alteration, forgery or falsification of the content or appearance of this document is unlawful and offenders may be prosecuted to the fullest extent of the law.

802.11n_40MHz_Chain0_2422MHz



802.11n_40MHz_Chain1_2422MHz



802.11n_40MHz_Chain0_2437MHz



802.11n_40MHz_Chain1_2437MHz



802.11n_40MHz_Chain0_2452MHz

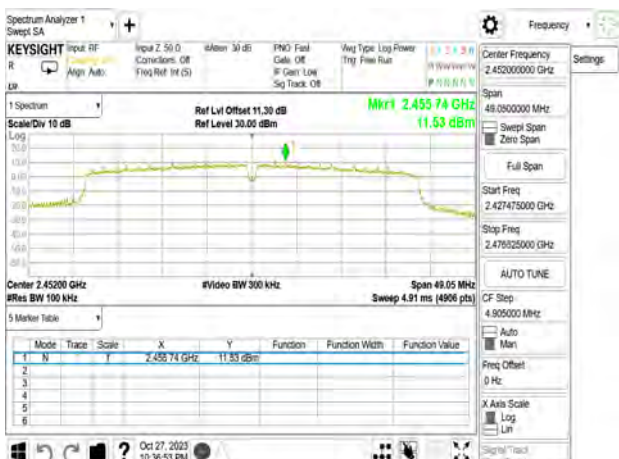

802.11n_40MHz_Chain1_2452MHz



Unless otherwise stated the results shown in this test report refer only to the sample(s) tested and such sample(s) are retained for 90 days only.

除非另有說明，此報告結果僅對測試之樣品負責，同時此樣品僅保留90天。本報告未經本公司書面許可，不可部份複製。

This document is issued by the Company subject to its General Conditions of Service printed overleaf, available on request or accessible at <http://www.sgs.com.tw/Terms-and-Conditions> and for electronic format documents, subject to Terms and Conditions for Electronic Documents at <http://www.sgs.com.tw/Terms-and-Conditions>. Attention is drawn to the limitation of liability, indemnification and jurisdiction issues defined therein. Any holder of this document is advised that information contained hereon reflects the Company's findings at the time of its intervention only and within the limits of Client's instructions, if any. The Company's sole responsibility is to its Client and this document does not exonerate parties to a transaction from exercising all their rights and obligations under the transaction documents. This document cannot be reproduced except in full, without prior written approval of the Company. Any unauthorized alteration, forgery or falsification of the content or appearance of this document is unlawful and offenders may be prosecuted to the fullest extent of the law.

802.11n_40MHz_Chain2_2422MHz



802.11n_40MHz_Chain3_2422MHz

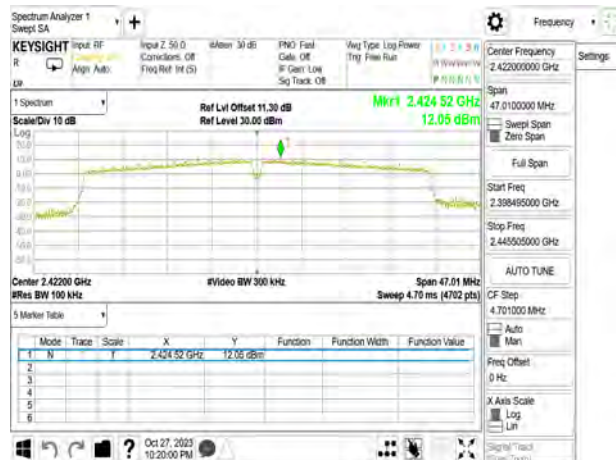

802.11n_40MHz_Chain2_2437MHz



802.11n_40MHz_Chain3_2437MHz

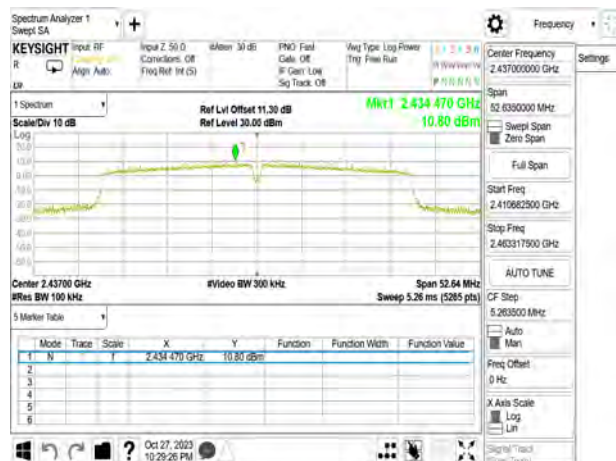

802.11n_40MHz_Chain2_2452MHz

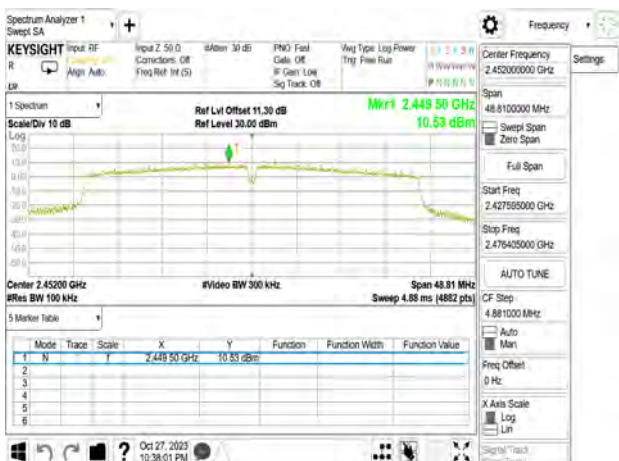

802.11n_40MHz_Chain3_2452MHz



Unless otherwise stated the results shown in this test report refer only to the sample(s) tested and such sample(s) are retained for 90 days only.

除非另有說明，此報告結果僅對測試之樣品負責，同時此樣品僅保留90天。本報告未經本公司書面許可，不可部份複製。

This document is issued by the Company subject to its General Conditions of Service printed overleaf, available on request or accessible at <http://www.sgs.com.tw/Terms-and-Conditions> and for electronic format documents, subject to Terms and Conditions for Electronic Documents at <http://www.sgs.com.tw/Terms-and-Conditions>. Attention is drawn to the limitation of liability, indemnification and jurisdiction issues defined therein. Any holder of this document is advised that information contained hereon reflects the Company's findings at the time of its intervention only and within the limits of Client's instructions, if any. The Company's sole responsibility is to its Client and this document does not exonerate parties to a transaction from exercising all their rights and obligations under the transaction documents. This document cannot be reproduced except in full, without prior written approval of the Company. Any unauthorized alteration, forgery or falsification of the content or appearance of this document is unlawful and offenders may be prosecuted to the fullest extent of the law.

802.11be_20MHz_Chain0_2412MHz



802.11be_20MHz_Chain1_2412MHz

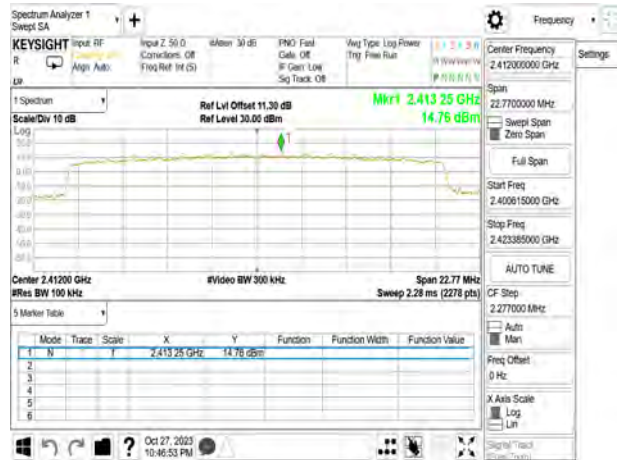

802.11be_20MHz_Chain0_2437MHz

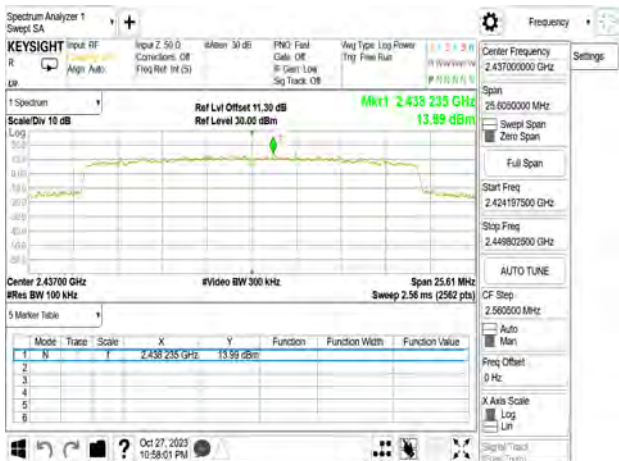

802.11be_20MHz_Chain1_2437MHz



802.11be_20MHz_Chain0_2462MHz

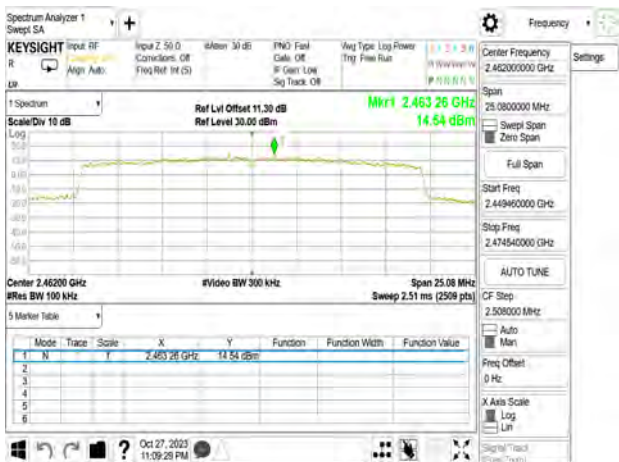

802.11be_20MHz_Chain1_2462MHz

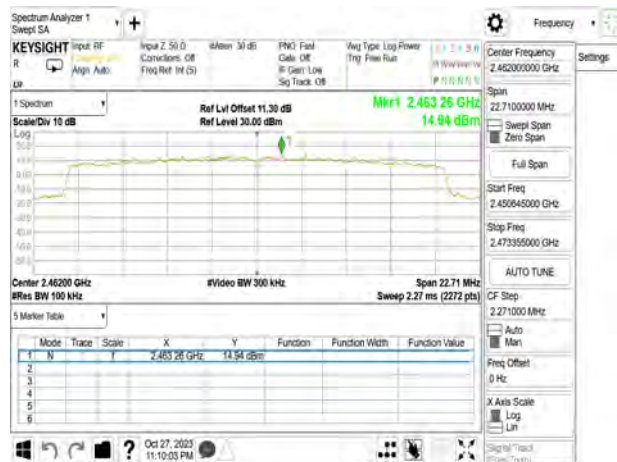

Unless otherwise stated the results shown in this test report refer only to the sample(s) tested and such sample(s) are retained for 90 days only.

除非另有說明，此報告結果僅對測試之樣品負責，同時此樣品僅保留90天。本報告未經本公司書面許可，不可部份複製。

This document is issued by the Company subject to its General Conditions of Service printed overleaf, available on request or accessible at <http://www.sgs.com.tw/Terms-and-Conditions> and for electronic format documents, subject to Terms and Conditions for Electronic Documents at <http://www.sgs.com.tw/Terms-and-Conditions>. Attention is drawn to the limitation of liability, indemnification and jurisdiction issues defined therein. Any holder of this document is advised that information contained hereon reflects the Company's findings at the time of its intervention only and within the limits of Client's instructions, if any. The Company's sole responsibility is to its Client and this document does not exonerate parties to a transaction from exercising all their rights and obligations under the transaction documents. This document cannot be reproduced except in full, without prior written approval of the Company. Any unauthorized alteration, forgery or falsification of the content or appearance of this document is unlawful and offenders may be prosecuted to the fullest extent of the law.

802.11be_20MHz_Chain2_2412MHz

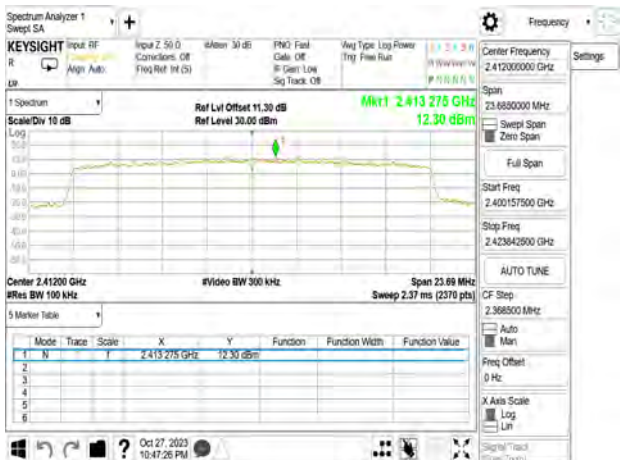

802.11be_20MHz_Chain3_2412MHz



802.11be_20MHz_Chain2_2437MHz

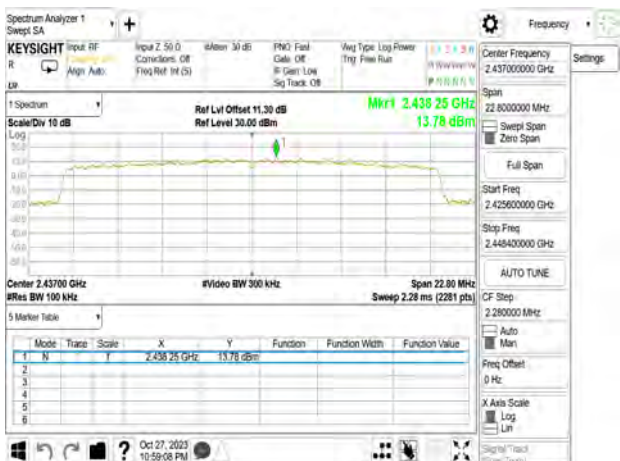

802.11be_20MHz_Chain3_2437MHz

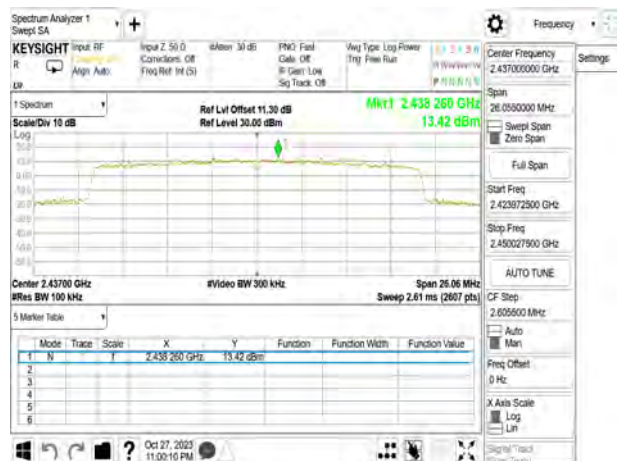

802.11be_20MHz_Chain2_2462MHz

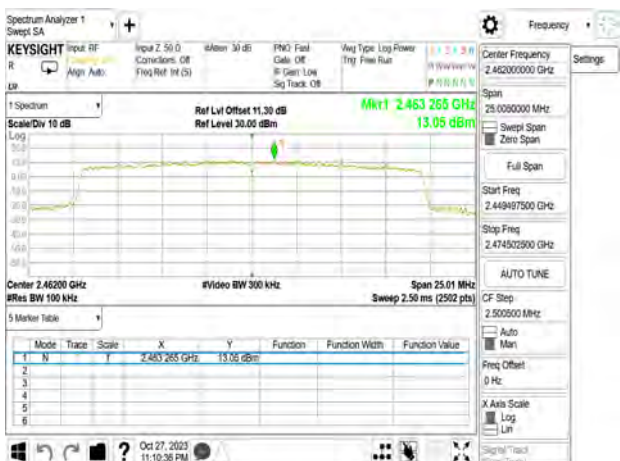

802.11be_20MHz_Chain3_2462MHz

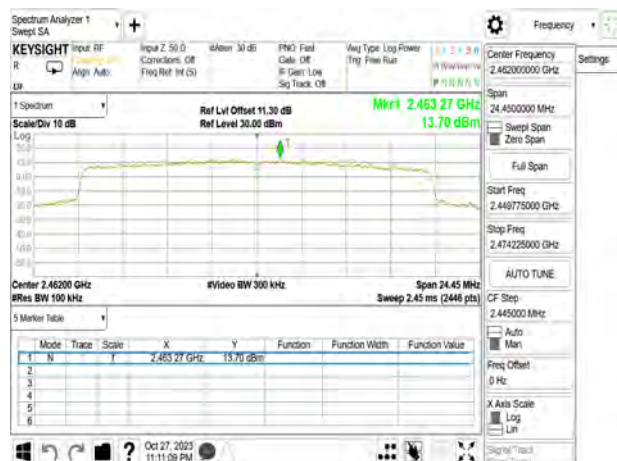

Unless otherwise stated the results shown in this test report refer only to the sample(s) tested and such sample(s) are retained for 90 days only.

除非另有說明，此報告結果僅對測試之樣品負責，同時此樣品僅保留90天。本報告未經本公司書面許可，不可部份複製。

This document is issued by the Company subject to its General Conditions of Service printed overleaf, available on request or accessible at <http://www.sgs.com.tw/Terms-and-Conditions> and for electronic format documents, subject to Terms and Conditions for Electronic Documents at <http://www.sgs.com.tw/Terms-and-Conditions>. Attention is drawn to the limitation of liability, indemnification and jurisdiction issues defined therein. Any holder of this document is advised that information contained hereon reflects the Company's findings at the time of its intervention only and within the limits of Client's instructions, if any. The Company's sole responsibility is to its Client and this document does not exonerate parties to a transaction from exercising all their rights and obligations under the transaction documents. This document cannot be reproduced except in full, without prior written approval of the Company. Any unauthorized alteration, forgery or falsification of the content or appearance of this document is unlawful and offenders may be prosecuted to the fullest extent of the law.

802.11be_40MHz_Chain0_2422MHz



802.11be_40MHz_Chain1_2422MHz

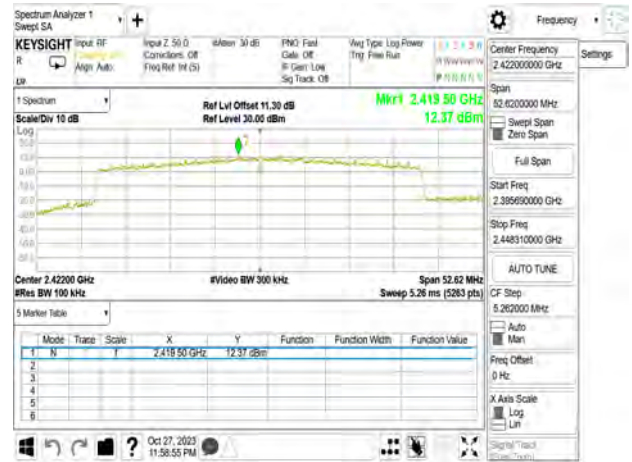

802.11be_40MHz_Chain0_2437MHz

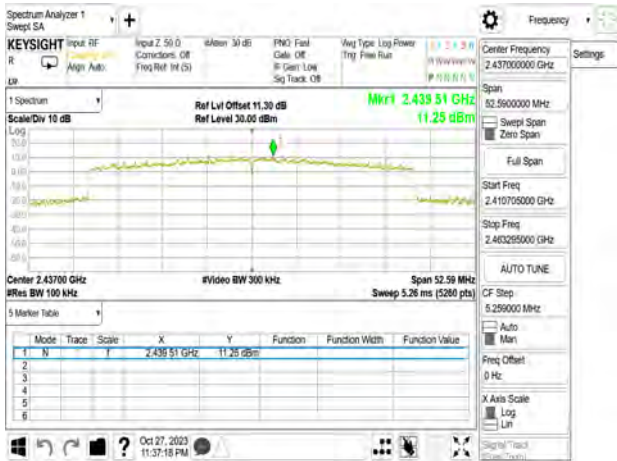

802.11be_40MHz_Chain1_2437MHz

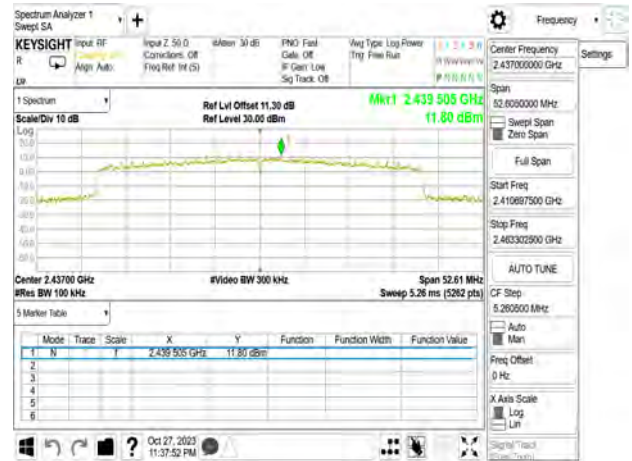

802.11be_40MHz_Chain0_2452MHz



802.11be_40MHz_Chain1_2452MHz



Unless otherwise stated the results shown in this test report refer only to the sample(s) tested and such sample(s) are retained for 90 days only.

除非另有說明，此報告結果僅對測試之樣品負責，同時此樣品僅保留90天。本報告未經本公司書面許可，不可部份複製。

This document is issued by the Company subject to its General Conditions of Service printed overleaf, available on request or accessible at <http://www.sgs.com.tw/Terms-and-Conditions> and for electronic format documents, subject to Terms and Conditions for Electronic Documents at <http://www.sgs.com.tw/Terms-and-Conditions>. Attention is drawn to the limitation of liability, indemnification and jurisdiction issues defined therein. Any holder of this document is advised that information contained hereon reflects the Company's findings at the time of its intervention only and within the limits of Client's instructions, if any. The Company's sole responsibility is to its Client and this document does not exonerate parties to a transaction from exercising all their rights and obligations under the transaction documents. This document cannot be reproduced except in full, without prior written approval of the Company. Any unauthorized alteration, forgery or falsification of the content or appearance of this document is unlawful and offenders may be prosecuted to the fullest extent of the law.

802.11be_40MHz_Chain2_2422MHz

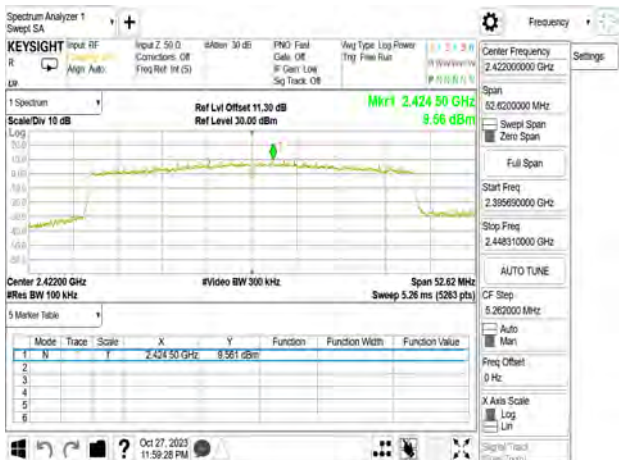

802.11be_40MHz_Chain3_2422MHz

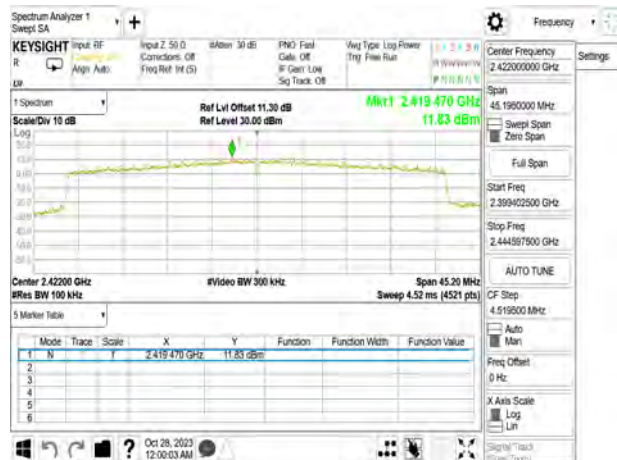

802.11be_40MHz_Chain2_2437MHz

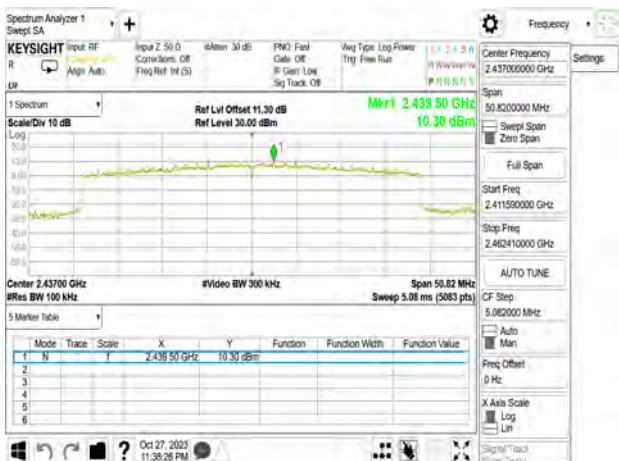

802.11be_40MHz_Chain3_2437MHz



802.11be_40MHz_Chain2_2452MHz

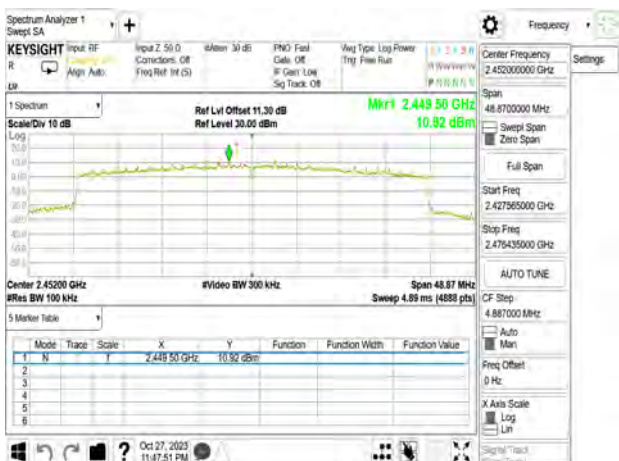

802.11be_40MHz_Chain3_2452MHz

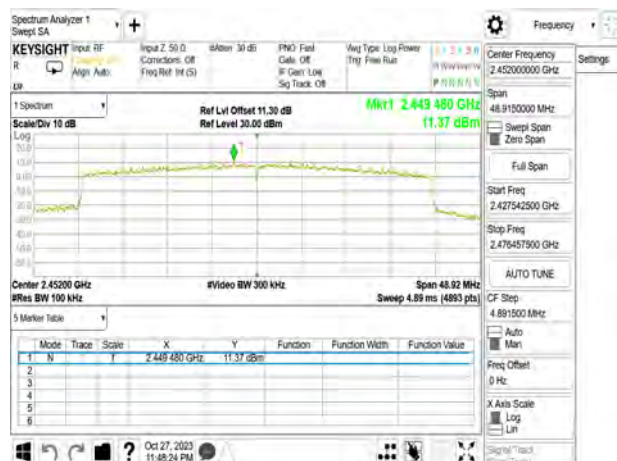

Unless otherwise stated the results shown in this test report refer only to the sample(s) tested and such sample(s) are retained for 90 days only.

除非另有說明，此報告結果僅對測試之樣品負責，同時此樣品僅保留90天。本報告未經本公司書面許可，不可部份複製。

This document is issued by the Company subject to its General Conditions of Service printed overleaf, available on request or accessible at <http://www.sgs.com.tw/Terms-and-Conditions> and for electronic format documents, subject to Terms and Conditions for Electronic Documents at <http://www.sgs.com.tw/Terms-and-Conditions>. Attention is drawn to the limitation of liability, indemnification and jurisdiction issues defined therein. Any holder of this document is advised that information contained hereon reflects the Company's findings at the time of its intervention only and within the limits of Client's instructions, if any. The Company's sole responsibility is to its Client and this document does not exonerate parties to a transaction from exercising all their rights and obligations under the transaction documents. This document cannot be reproduced except in full, without prior written approval of the Company. Any unauthorized alteration, forgery or falsification of the content or appearance of this document is unlawful and offenders may be prosecuted to the fullest extent of the law.

802.11b_20MHz_Chain0_2412MHz

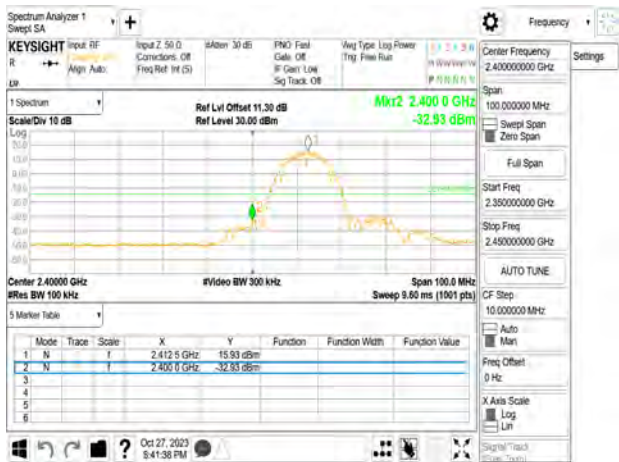

802.11b_20MHz_Chain1_2462MHz

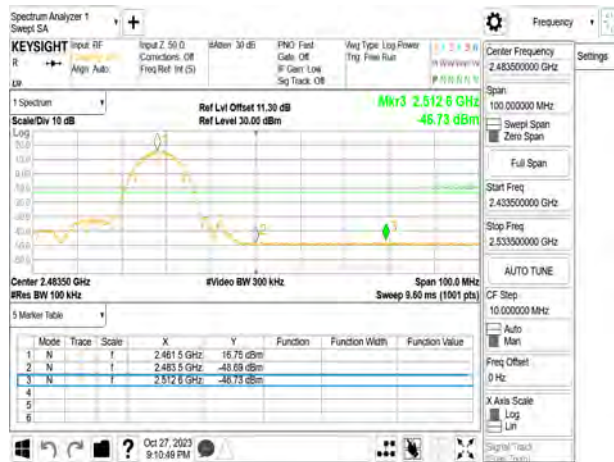

802.11b_20MHz_Chain0_2462MHz

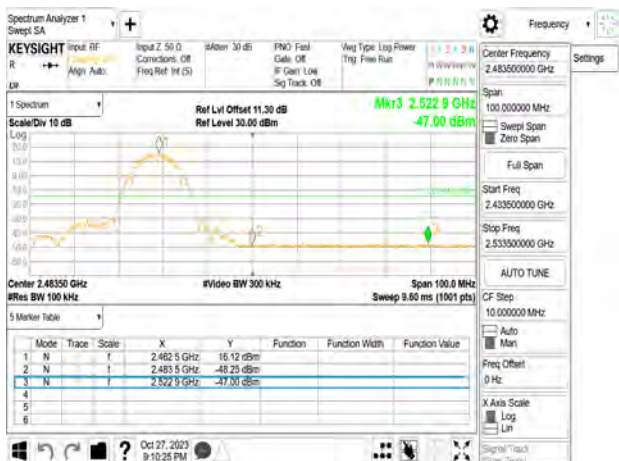

802.11b_20MHz_Chain2_2412MHz

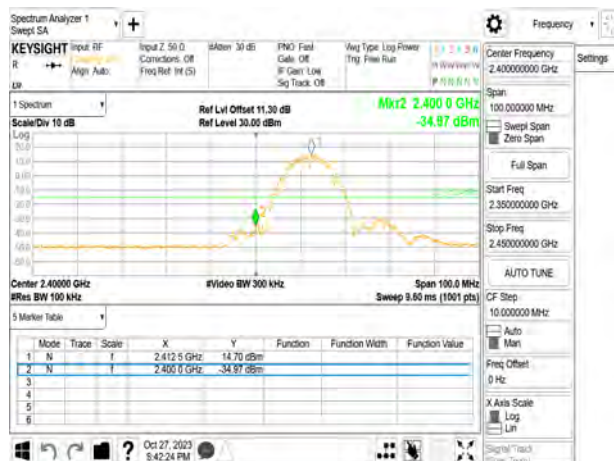

802.11b_20MHz_Chain1_2412MHz

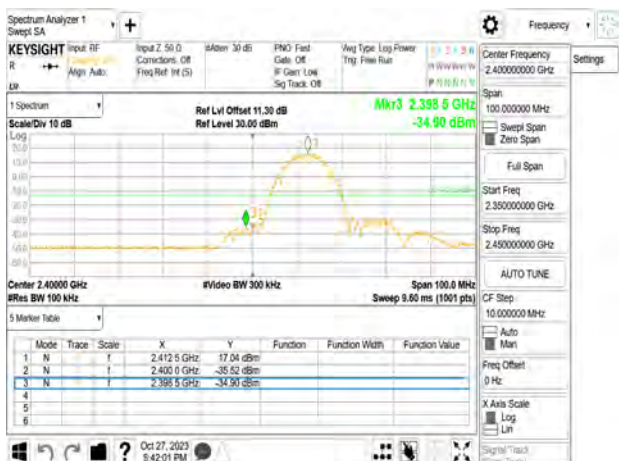

802.11b_20MHz_Chain2_2462MHz

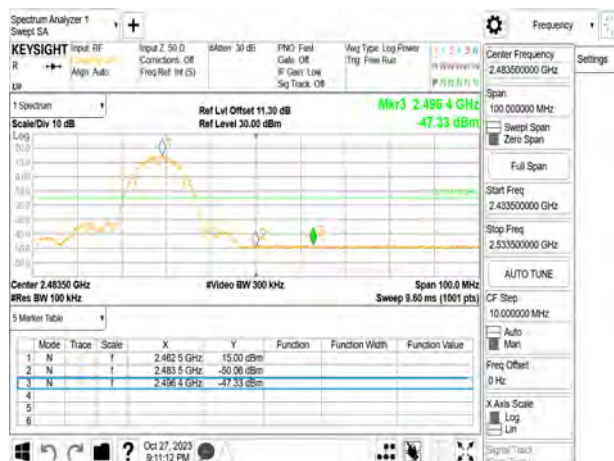

Unless otherwise stated the results shown in this test report refer only to the sample(s) tested and such sample(s) are retained for 90 days only.

除非另有說明，此報告結果僅對測試之樣品負責，同時此樣品僅保留90天。本報告未經本公司書面許可，不可部份複製。

This document is issued by the Company subject to its General Conditions of Service printed overleaf, available on request or accessible at <http://www.sgs.com.tw/Terms-and-Conditions> and for electronic format documents, subject to Terms and Conditions for Electronic Documents at <http://www.sgs.com.tw/Terms-and-Conditions>. Attention is drawn to the limitation of liability, indemnification and jurisdiction issues defined therein. Any holder of this document is advised that information contained hereon reflects the Company's findings at the time of its intervention only and within the limits of Client's instructions, if any. The Company's sole responsibility is to its Client and this document does not exonerate parties to a transaction from exercising all their rights and obligations under the transaction documents. This document cannot be reproduced except in full, without prior written approval of the Company. Any unauthorized alteration, forgery or falsification of the content or appearance of this document is unlawful and offenders may be prosecuted to the fullest extent of the law.

802.11b_20MHz_Chain3_2412MHz

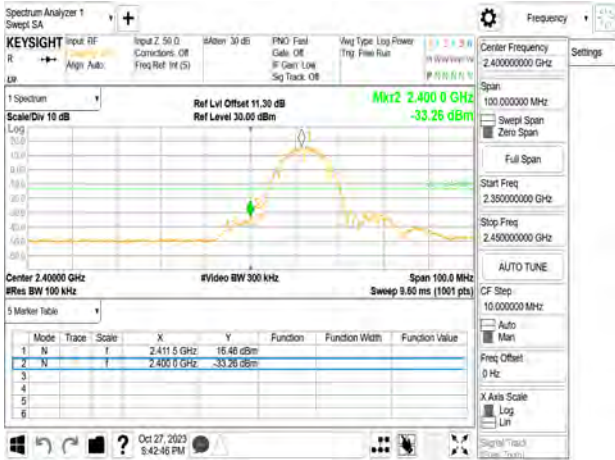

802.11g_20MHz_Chain0_2462MHz



802.11b_20MHz_Chain3_2462MHz



802.11g_20MHz_Chain1_2412MHz

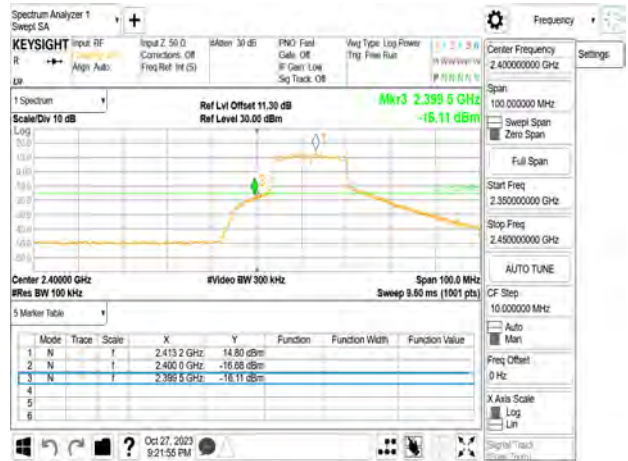

802.11g_20MHz_Chain0_2412MHz

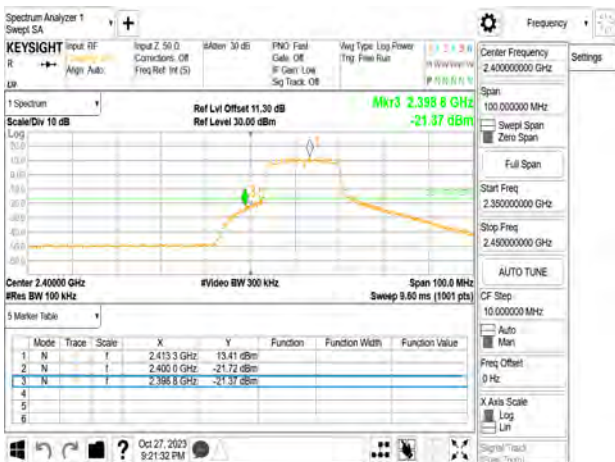

802.11g_20MHz_Chain1_2462MHz



Unless otherwise stated the results shown in this test report refer only to the sample(s) tested and such sample(s) are retained for 90 days only.

除非另有說明，此報告結果僅對測試之樣品負責，同時此樣品僅保留90天。本報告未經本公司書面許可，不可部份複製。

This document is issued by the Company subject to its General Conditions of Service printed overleaf, available on request or accessible at <http://www.sgs.com.tw/Terms-and-Conditions> and for electronic format documents, subject to Terms and Conditions for Electronic Documents at <http://www.sgs.com.tw/Terms-and-Conditions>. Attention is drawn to the limitation of liability, indemnification and jurisdiction issues defined therein. Any holder of this document is advised that information contained hereon reflects the Company's findings at the time of its intervention only and within the limits of Client's instructions, if any. The Company's sole responsibility is to its Client and this document does not exonerate parties to a transaction from exercising all their rights and obligations under the transaction documents. This document cannot be reproduced except in full, without prior written approval of the Company. Any unauthorized alteration, forgery or falsification of the content or appearance of this document is unlawful and offenders may be prosecuted to the fullest extent of the law.

802.11g_20MHz_Chain2_2412MHz

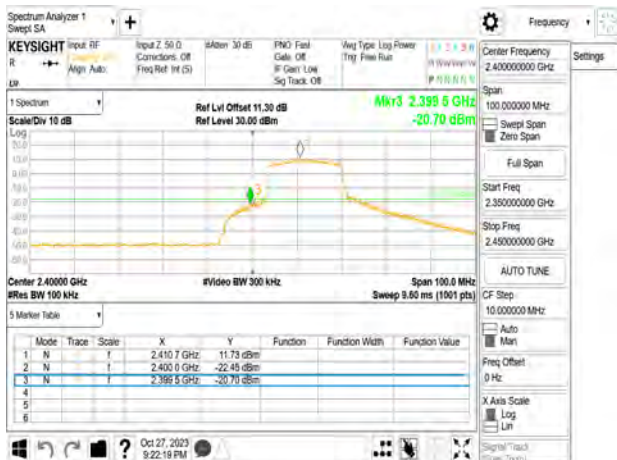

802.11g_20MHz_Chain3_2462MHz



802.11g_20MHz_Chain2_2462MHz



802.11n_20MHz_Chain0_2412MHz

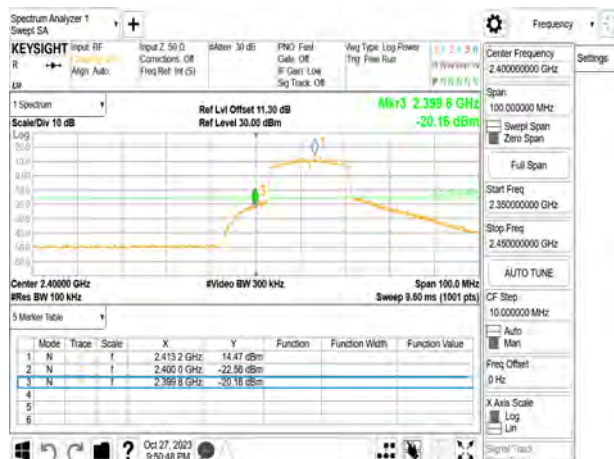

802.11g_20MHz_Chain3_2412MHz

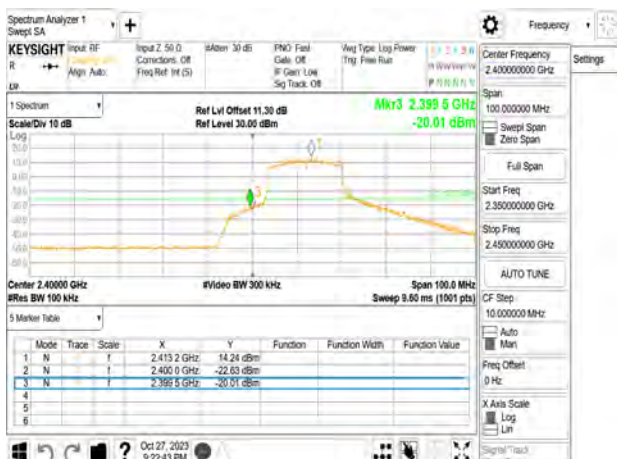

802.11n_20MHz_Chain0_2462MHz

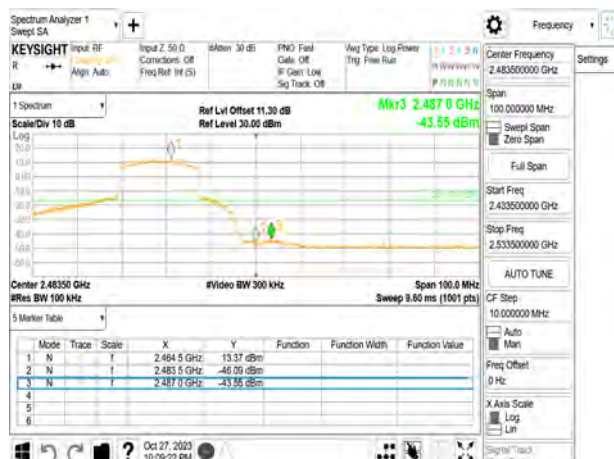

Unless otherwise stated the results shown in this test report refer only to the sample(s) tested and such sample(s) are retained for 90 days only.

除非另有說明，此報告結果僅對測試之樣品負責，同時此樣品僅保留90天。本報告未經本公司書面許可，不可部份複製。

This document is issued by the Company subject to its General Conditions of Service printed overleaf, available on request or accessible at <http://www.sgs.com.tw/Terms-and-Conditions> and for electronic format documents, subject to Terms and Conditions for Electronic Documents at <http://www.sgs.com.tw/Terms-and-Conditions>. Attention is drawn to the limitation of liability, indemnification and jurisdiction issues defined therein. Any holder of this document is advised that information contained hereon reflects the Company's findings at the time of its intervention only and within the limits of Client's instructions, if any. The Company's sole responsibility is to its Client and this document does not exonerate parties to a transaction from exercising all their rights and obligations under the transaction documents. This document cannot be reproduced except in full, without prior written approval of the Company. Any unauthorized alteration, forgery or falsification of the content or appearance of this document is unlawful and offenders may be prosecuted to the fullest extent of the law.

802.11n_20MHz_Chain1_2412MHz



802.11n_20MHz_Chain2_2462MHz



802.11n_20MHz_Chain1_2462MHz

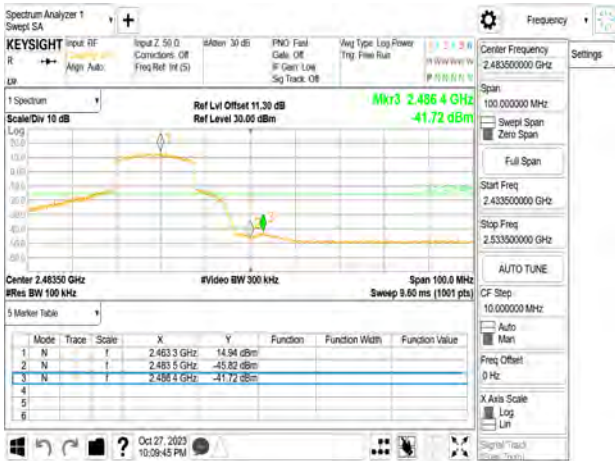

802.11n_20MHz_Chain3_2412MHz

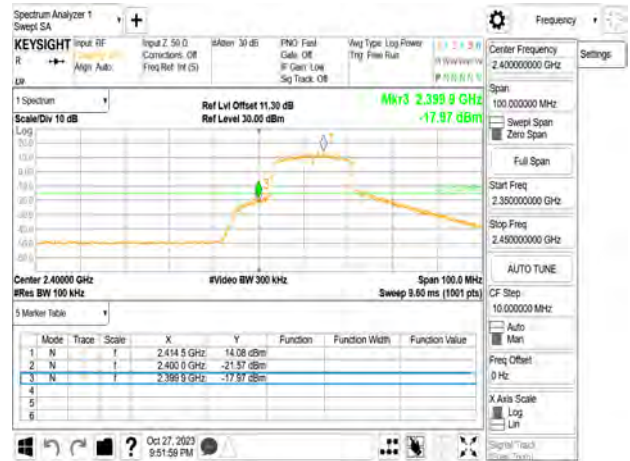

802.11n_20MHz_Chain2_2412MHz

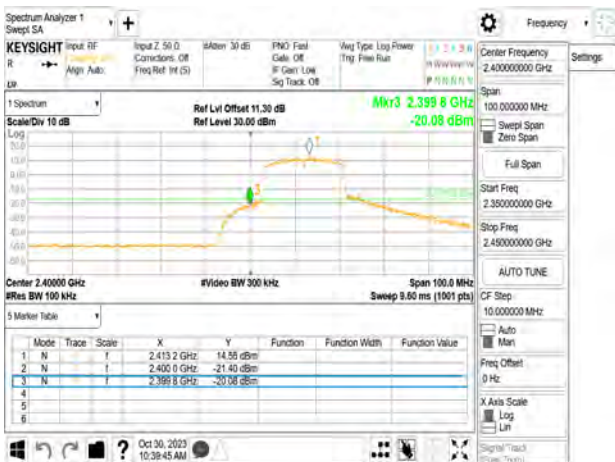

802.11n_20MHz_Chain3_2462MHz



Unless otherwise stated the results shown in this test report refer only to the sample(s) tested and such sample(s) are retained for 90 days only.

除非另有說明，此報告結果僅對測試之樣品負責，同時此樣品僅保留90天。本報告未經本公司書面許可，不可部份複製。

This document is issued by the Company subject to its General Conditions of Service printed overleaf, available on request or accessible at <http://www.sgs.com.tw/Terms-and-Conditions> and for electronic format documents, subject to Terms and Conditions for Electronic Documents at <http://www.sgs.com.tw/Terms-and-Conditions>. Attention is drawn to the limitation of liability, indemnification and jurisdiction issues defined therein. Any holder of this document is advised that information contained hereon reflects the Company's findings at the time of its intervention only and within the limits of Client's instructions, if any. The Company's sole responsibility is to its Client and this document does not exonerate parties to a transaction from exercising all their rights and obligations under the transaction documents. This document cannot be reproduced except in full, without prior written approval of the Company. Any unauthorized alteration, forgery or falsification of the content or appearance of this document is unlawful and offenders may be prosecuted to the fullest extent of the law.

802.11n_40MHz_Chain0_2422MHz



802.11n_40MHz_Chain1_2452MHz

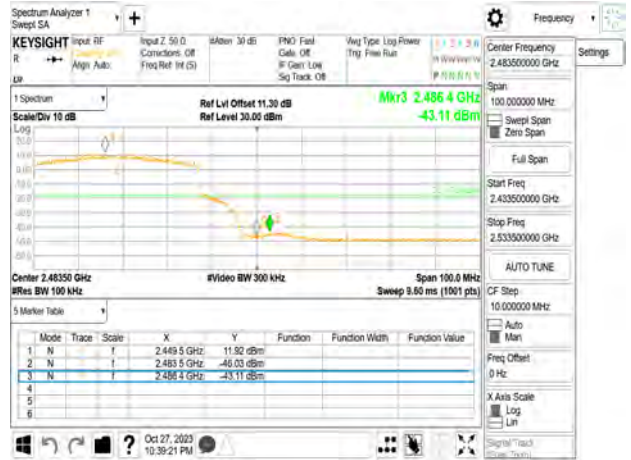

802.11n_40MHz_Chain0_2452MHz

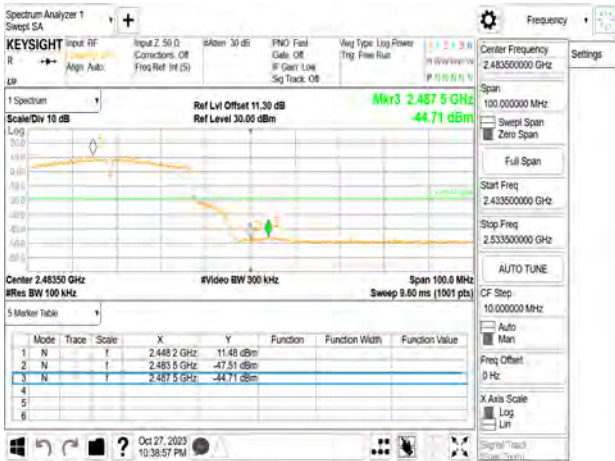

802.11n_40MHz_Chain2_2422MHz

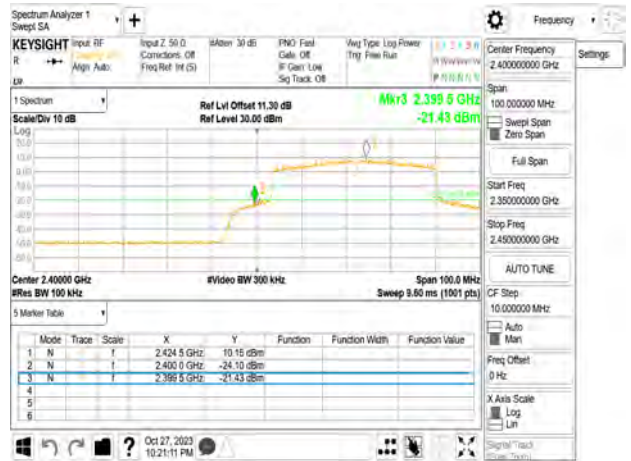

802.11n_40MHz_Chain1_2422MHz

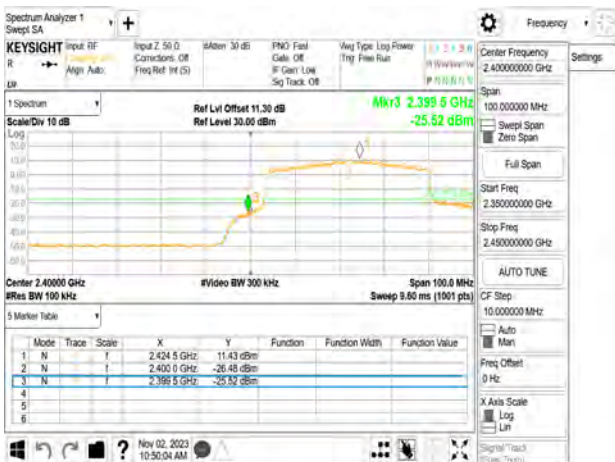

802.11n_40MHz_Chain2_2452MHz



Unless otherwise stated the results shown in this test report refer only to the sample(s) tested and such sample(s) are retained for 90 days only.

除非另有說明，此報告結果僅對測試之樣品負責，同時此樣品僅保留90天。本報告未經本公司書面許可，不可部份複製。

This document is issued by the Company subject to its General Conditions of Service printed overleaf, available on request or accessible at <http://www.sgs.com.tw/Terms-and-Conditions> and for electronic format documents, subject to Terms and Conditions for Electronic Documents at <http://www.sgs.com.tw/Terms-and-Conditions>. Attention is drawn to the limitation of liability, indemnification and jurisdiction issues defined therein. Any holder of this document is advised that information contained hereon reflects the Company's findings at the time of its intervention only and within the limits of Client's instructions, if any. The Company's sole responsibility is to its Client and this document does not exonerate parties to a transaction from exercising all their rights and obligations under the transaction documents. This document cannot be reproduced except in full, without prior written approval of the Company. Any unauthorized alteration, forgery or falsification of the content or appearance of this document is unlawful and offenders may be prosecuted to the fullest extent of the law.

802.11n_40MHz_Chain3_2422MHz



802.11be_20MHz_Chain0_2462MHz

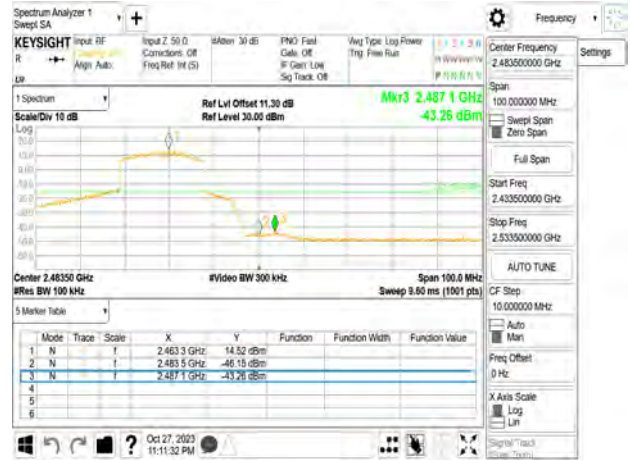

802.11n_40MHz_Chain3_2452MHz



802.11be_20MHz_Chain1_2412MHz

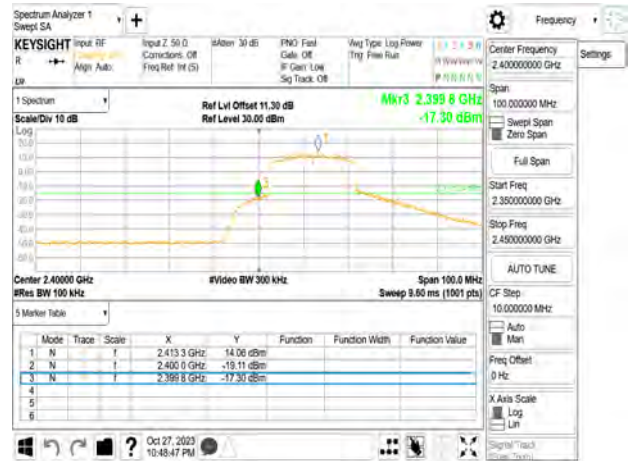

802.11be_20MHz_Chain0_2412MHz

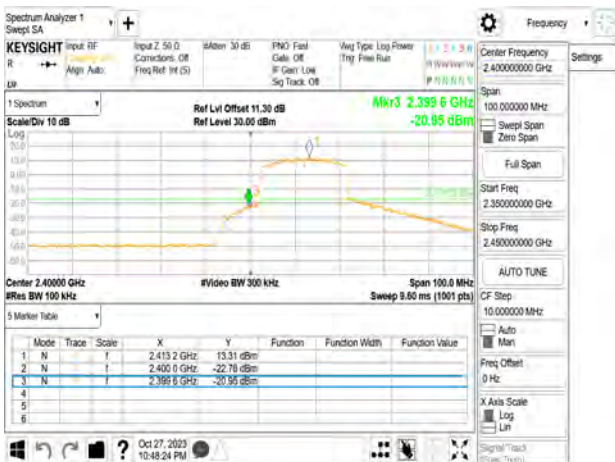

802.11be_20MHz_Chain1_2462MHz



Unless otherwise stated the results shown in this test report refer only to the sample(s) tested and such sample(s) are retained for 90 days only.

除非另有說明，此報告結果僅對測試之樣品負責，同時此樣品僅保留90天。本報告未經本公司書面許可，不可部份複製。

This document is issued by the Company subject to its General Conditions of Service printed overleaf, available on request or accessible at <http://www.sgs.com.tw/Terms-and-Conditions> and for electronic format documents, subject to Terms and Conditions for Electronic Documents at <http://www.sgs.com.tw/Terms-and-Conditions>. Attention is drawn to the limitation of liability, indemnification and jurisdiction issues defined therein. Any holder of this document is advised that information contained hereon reflects the Company's findings at the time of its intervention only and within the limits of Client's instructions, if any. The Company's sole responsibility is to its Client and this document does not exonerate parties to a transaction from exercising all their rights and obligations under the transaction documents. This document cannot be reproduced except in full, without prior written approval of the Company. Any unauthorized alteration, forgery or falsification of the content or appearance of this document is unlawful and offenders may be prosecuted to the fullest extent of the law.

802.11be_20MHz_Chain2_2412MHz



802.11be_20MHz_Chain3_2462MHz



802.11be_20MHz_Chain2_2462MHz



802.11be_40MHz_Chain0_2422MHz

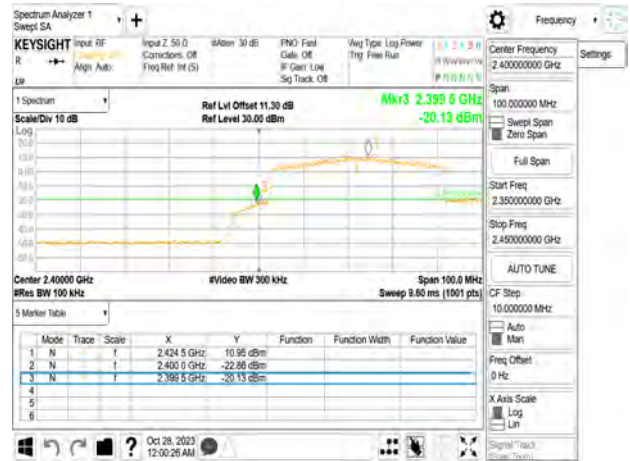

802.11be_20MHz_Chain3_2412MHz

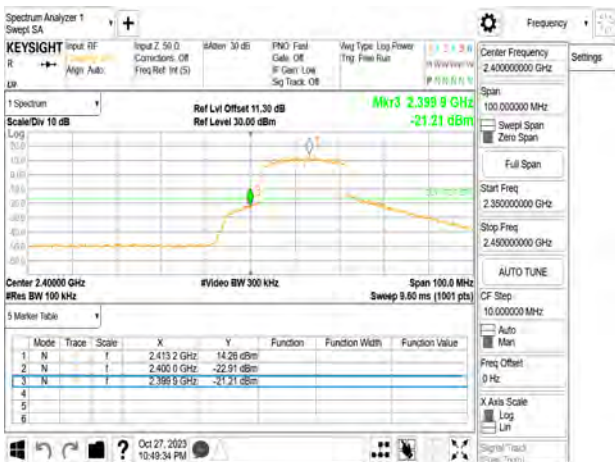

802.11be_40MHz_Chain0_2452MHz



Unless otherwise stated the results shown in this test report refer only to the sample(s) tested and such sample(s) are retained for 90 days only.

除非另有說明，此報告結果僅對測試之樣品負責，同時此樣品僅保留90天。本報告未經本公司書面許可，不可部份複製。

This document is issued by the Company subject to its General Conditions of Service printed overleaf, available on request or accessible at <http://www.sgs.com.tw/Terms-and-Conditions> and for electronic format documents, subject to Terms and Conditions for Electronic Documents at <http://www.sgs.com.tw/Terms-and-Conditions>. Attention is drawn to the limitation of liability, indemnification and jurisdiction issues defined therein. Any holder of this document is advised that information contained hereon reflects the Company's findings at the time of its intervention only and within the limits of Client's instructions, if any. The Company's sole responsibility is to its Client and this document does not exonerate parties to a transaction from exercising all their rights and obligations under the transaction documents. This document cannot be reproduced except in full, without prior written approval of the Company. Any unauthorized alteration, forgery or falsification of the content or appearance of this document is unlawful and offenders may be prosecuted to the fullest extent of the law.

802.11be_40MHz_Chain1_2422MHz

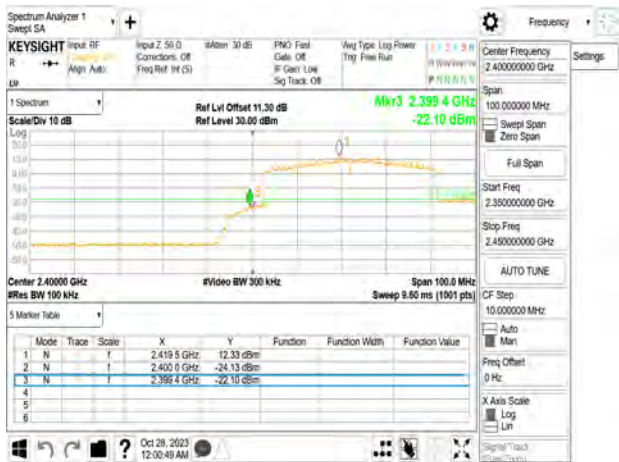

802.11be_40MHz_Chain2_2452MHz

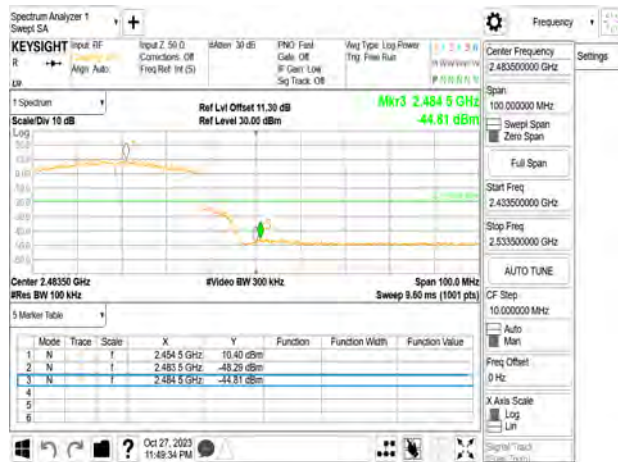

802.11be_40MHz_Chain1_2452MHz



802.11be_40MHz_Chain3_2422MHz

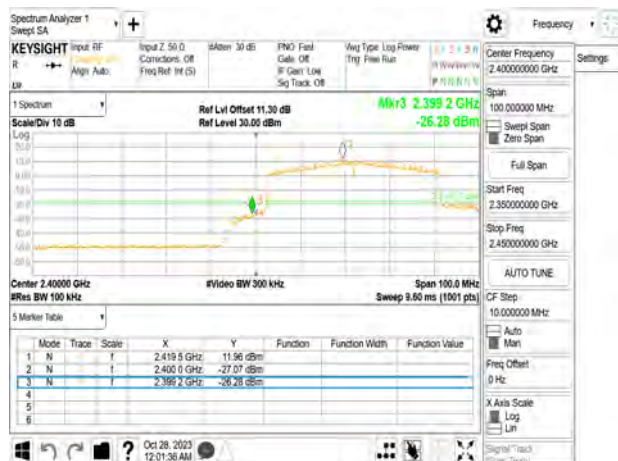

802.11be_40MHz_Chain2_2422MHz



802.11be_40MHz_Chain3_2452MHz

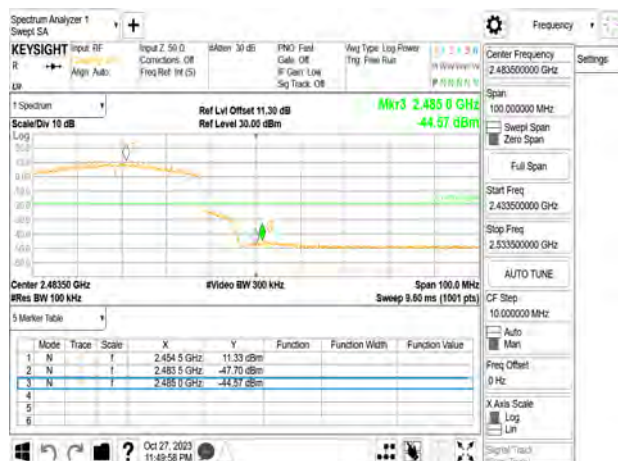

Unless otherwise stated the results shown in this test report refer only to the sample(s) tested and such sample(s) are retained for 90 days only.

除非另有說明，此報告結果僅對測試之樣品負責，同時此樣品僅保留90天。本報告未經本公司書面許可，不可部份複製。

This document is issued by the Company subject to its General Conditions of Service printed overleaf, available on request or accessible at <http://www.sgs.com.tw/Terms-and-Conditions> and for electronic format documents, subject to Terms and Conditions for Electronic Documents at <http://www.sgs.com.tw/Terms-and-Conditions>. Attention is drawn to the limitation of liability, indemnification and jurisdiction issues defined therein. Any holder of this document is advised that information contained hereon reflects the Company's findings at the time of its intervention only and within the limits of Client's instructions, if any. The Company's sole responsibility is to its Client and this document does not exonerate parties to a transaction from exercising all their rights and obligations under the transaction documents. This document cannot be reproduced except in full, without prior written approval of the Company. Any unauthorized alteration, forgery or falsification of the content or appearance of this document is unlawful and offenders may be prosecuted to the fullest extent of the law.

802.11b_20MHz_Chain0_2412MHz

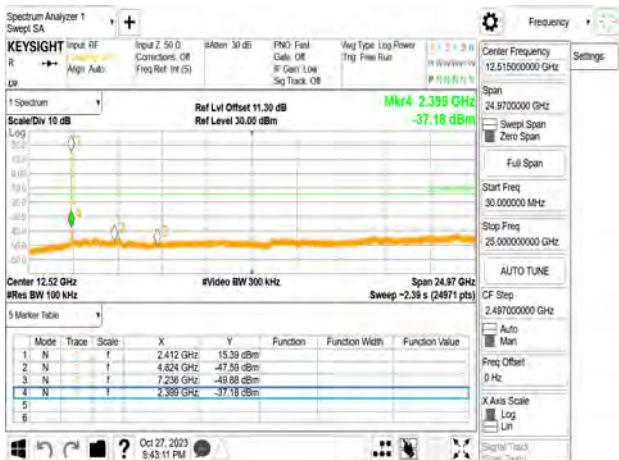

802.11b_20MHz_Chain1_2412MHz



802.11b_20MHz_Chain0_2437MHz

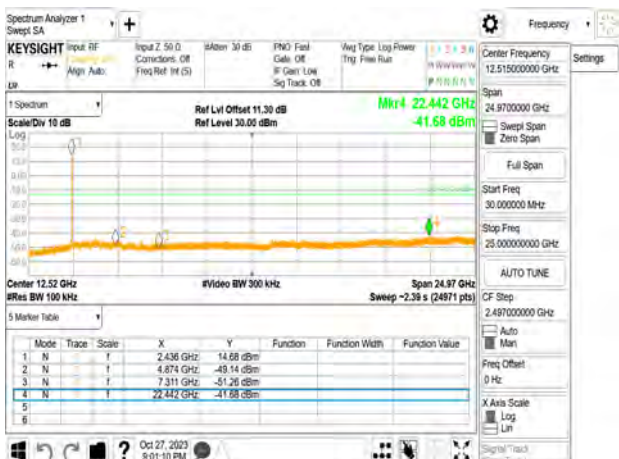

802.11b_20MHz_Chain1_2437MHz

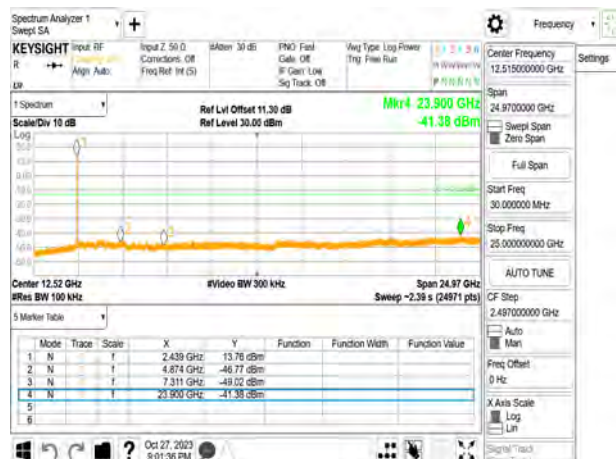

802.11b_20MHz_Chain0_2462MHz

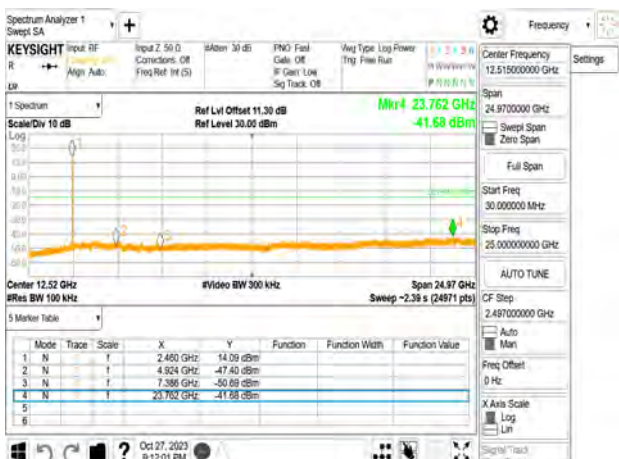

802.11b_20MHz_Chain1_2462MHz

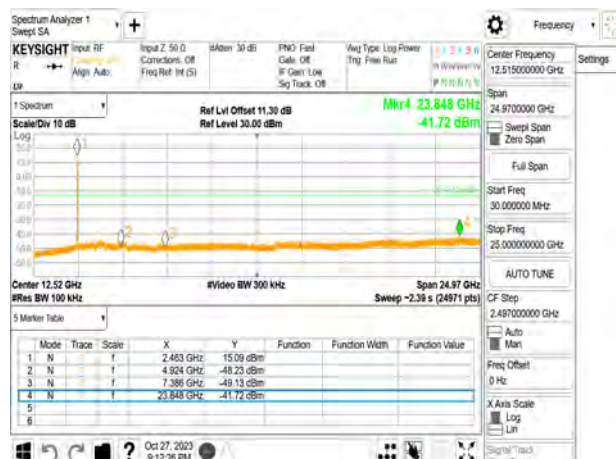

Unless otherwise stated the results shown in this test report refer only to the sample(s) tested and such sample(s) are retained for 90 days only.

除非另有說明，此報告結果僅對測試之樣品負責，同時此樣品僅保留90天。本報告未經本公司書面許可，不可部份複製。

This document is issued by the Company subject to its General Conditions of Service printed overleaf, available on request or accessible at <http://www.sgs.com.tw/Terms-and-Conditions> and for electronic format documents, subject to Terms and Conditions for Electronic Documents at <http://www.sgs.com.tw/Terms-and-Conditions>. Attention is drawn to the limitation of liability, indemnification and jurisdiction issues defined therein. Any holder of this document is advised that information contained hereon reflects the Company's findings at the time of its intervention only and within the limits of Client's instructions, if any. The Company's sole responsibility is to its Client and this document does not exonerate parties to a transaction from exercising all their rights and obligations under the transaction documents. This document cannot be reproduced except in full, without prior written approval of the Company. Any unauthorized alteration, forgery or falsification of the content or appearance of this document is unlawful and offenders may be prosecuted to the fullest extent of the law.

802.11b_20MHz_Chain2_2412MHz

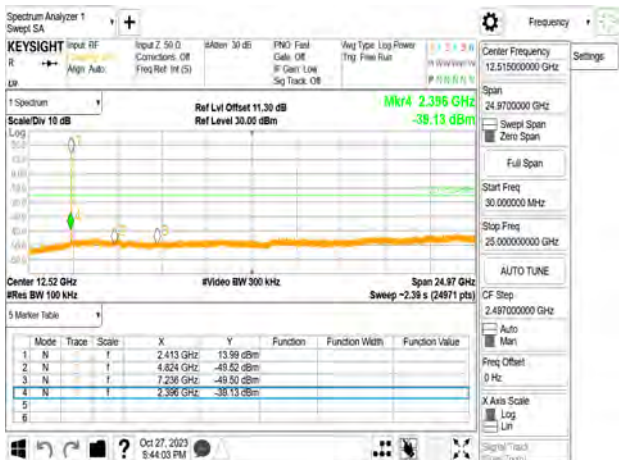

802.11b_20MHz_Chain3_2412MHz

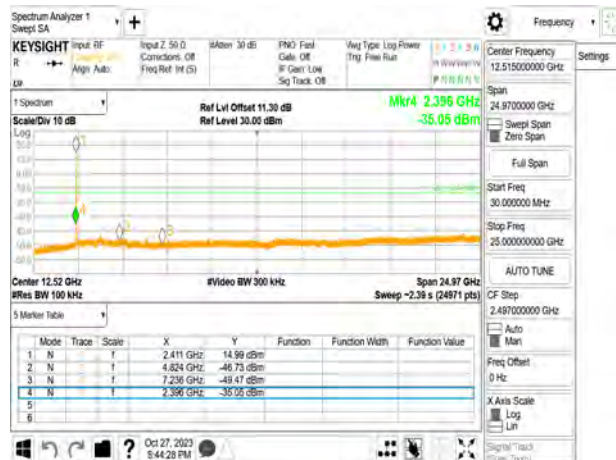

802.11b_20MHz_Chain2_2437MHz

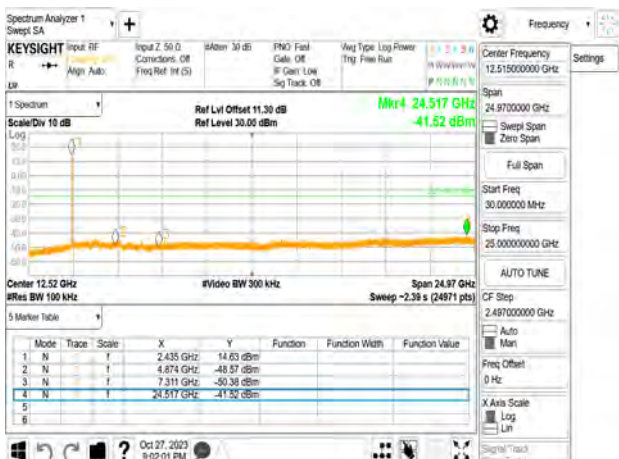

802.11b_20MHz_Chain3_2437MHz

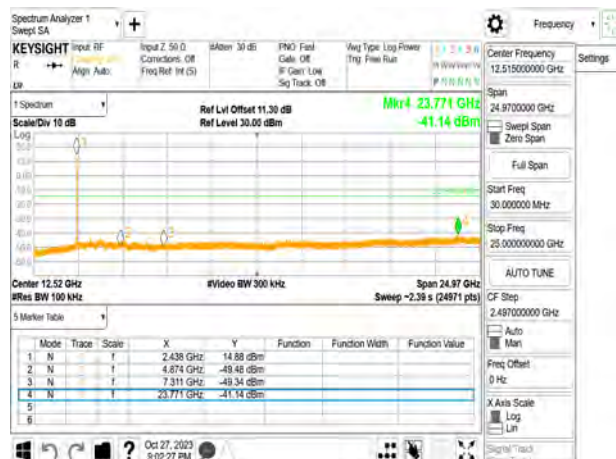

802.11b_20MHz_Chain2_2462MHz

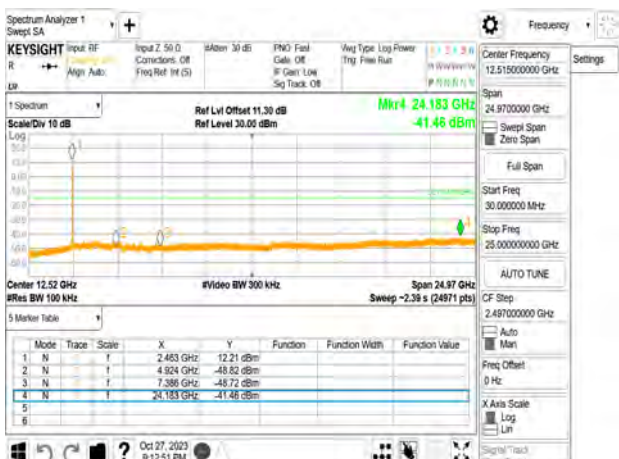

802.11b_20MHz_Chain3_2462MHz



Unless otherwise stated the results shown in this test report refer only to the sample(s) tested and such sample(s) are retained for 90 days only.

除非另有說明，此報告結果僅對測試之樣品負責，同時此樣品僅保留90天。本報告未經本公司書面許可，不可部份複製。

This document is issued by the Company subject to its General Conditions of Service printed overleaf, available on request or accessible at <http://www.sgs.com.tw/Terms-and-Conditions> and for electronic format documents, subject to Terms and Conditions for Electronic Documents at <http://www.sgs.com.tw/Terms-and-Conditions>. Attention is drawn to the limitation of liability, indemnification and jurisdiction issues defined therein. Any holder of this document is advised that information contained hereon reflects the Company's findings at the time of its intervention only and within the limits of Client's instructions, if any. The Company's sole responsibility is to its Client and this document does not exonerate parties to a transaction from exercising all their rights and obligations under the transaction documents. This document cannot be reproduced except in full, without prior written approval of the Company. Any unauthorized alteration, forgery or falsification of the content or appearance of this document is unlawful and offenders may be prosecuted to the fullest extent of the law.

802.11g_20MHz_Chain0_2412MHz

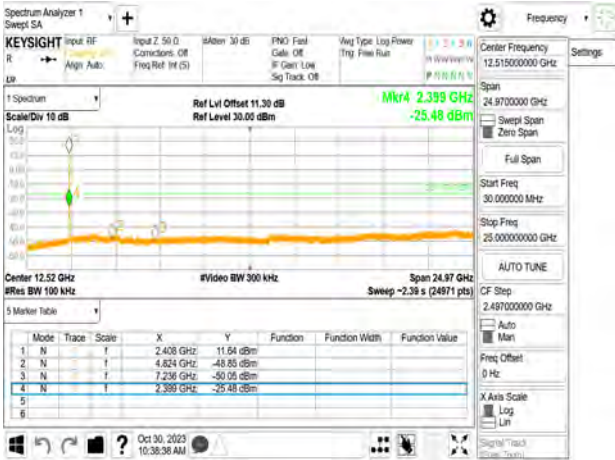

802.11g_20MHz_Chain1_2412MHz

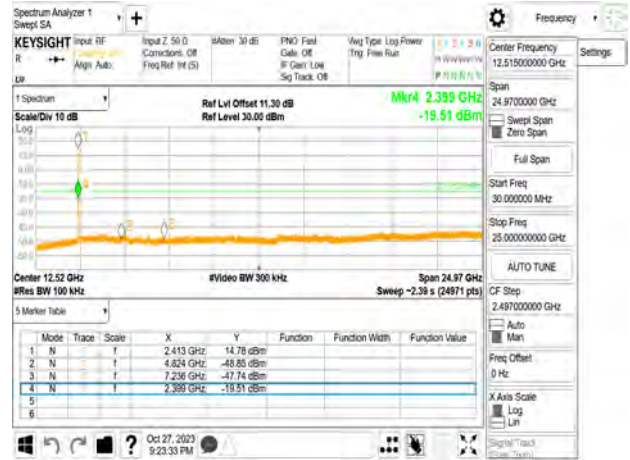

802.11g_20MHz_Chain0_2437MHz

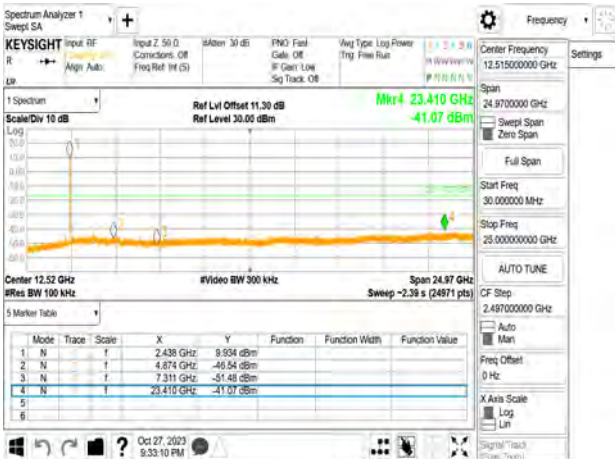

802.11g_20MHz_Chain1_2437MHz

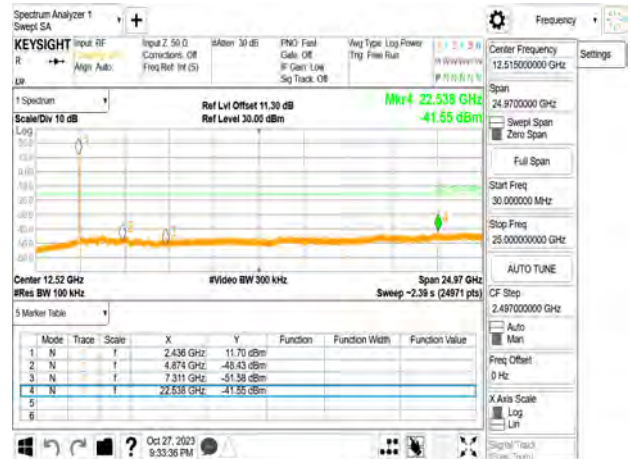

802.11g_20MHz_Chain0_2462MHz

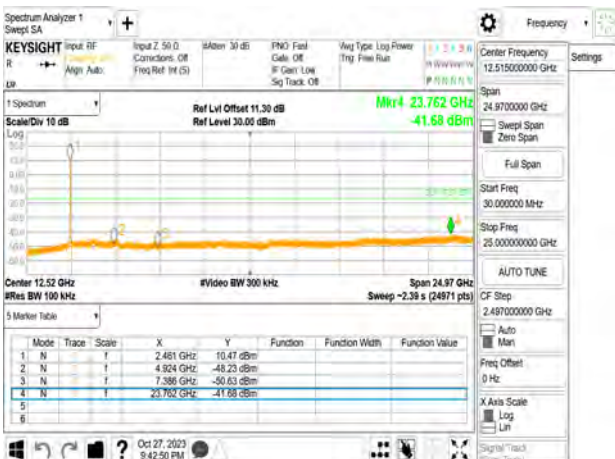

802.11g_20MHz_Chain1_2462MHz



Unless otherwise stated the results shown in this test report refer only to the sample(s) tested and such sample(s) are retained for 90 days only.

除非另有說明，此報告結果僅對測試之樣品負責，同時此樣品僅保留90天。本報告未經本公司書面許可，不可部份複製。

This document is issued by the Company subject to its General Conditions of Service printed overleaf, available on request or accessible at <http://www.sgs.com.tw/Terms-and-Conditions> and for electronic format documents, subject to Terms and Conditions for Electronic Documents at <http://www.sgs.com.tw/Terms-and-Conditions>. Attention is drawn to the limitation of liability, indemnification and jurisdiction issues defined therein. Any holder of this document is advised that information contained hereon reflects the Company's findings at the time of its intervention only and within the limits of Client's instructions, if any. The Company's sole responsibility is to its Client and this document does not exonerate parties to a transaction from exercising all their rights and obligations under the transaction documents. This document cannot be reproduced except in full, without prior written approval of the Company. Any unauthorized alteration, forgery or falsification of the content or appearance of this document is unlawful and offenders may be prosecuted to the fullest extent of the law.

802.11g_20MHz_Chain2_2412MHz

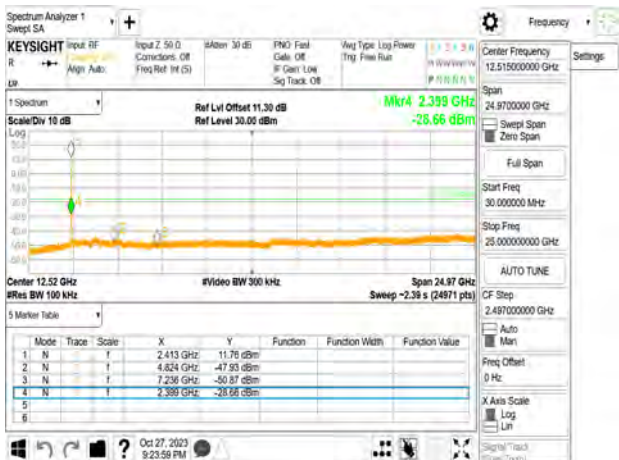

802.11g_20MHz_Chain3_2412MHz



802.11g_20MHz_Chain2_2437MHz

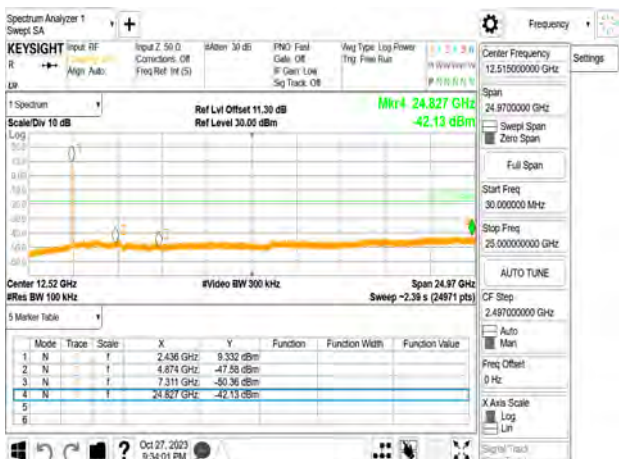

802.11g_20MHz_Chain3_2437MHz

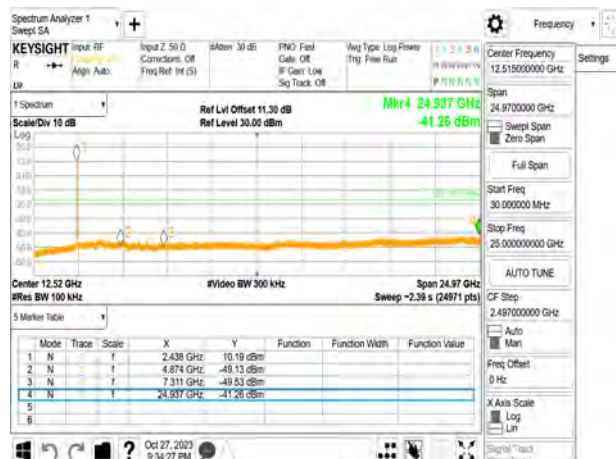

802.11g_20MHz_Chain2_2462MHz

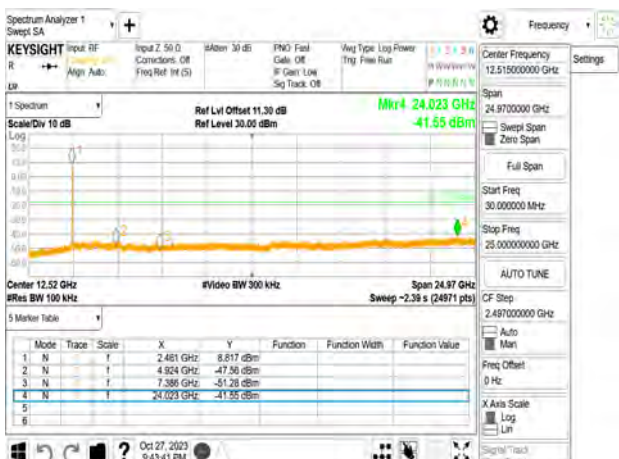

802.11g_20MHz_Chain3_2462MHz



Unless otherwise stated the results shown in this test report refer only to the sample(s) tested and such sample(s) are retained for 90 days only.

除非另有說明，此報告結果僅對測試之樣品負責，同時此樣品僅保留90天。本報告未經本公司書面許可，不可部份複製。

This document is issued by the Company subject to its General Conditions of Service printed overleaf, available on request or accessible at <http://www.sgs.com.tw/Terms-and-Conditions> and for electronic format documents, subject to Terms and Conditions for Electronic Documents at <http://www.sgs.com.tw/Terms-and-Conditions>. Attention is drawn to the limitation of liability, indemnification and jurisdiction issues defined therein. Any holder of this document is advised that information contained hereon reflects the Company's findings at the time of its intervention only and within the limits of Client's instructions, if any. The Company's sole responsibility is to its Client and this document does not exonerate parties to a transaction from exercising all their rights and obligations under the transaction documents. This document cannot be reproduced except in full, without prior written approval of the Company. Any unauthorized alteration, forgery or falsification of the content or appearance of this document is unlawful and offenders may be prosecuted to the fullest extent of the law.

802.11n_20MHz_Chain0_2412MHz

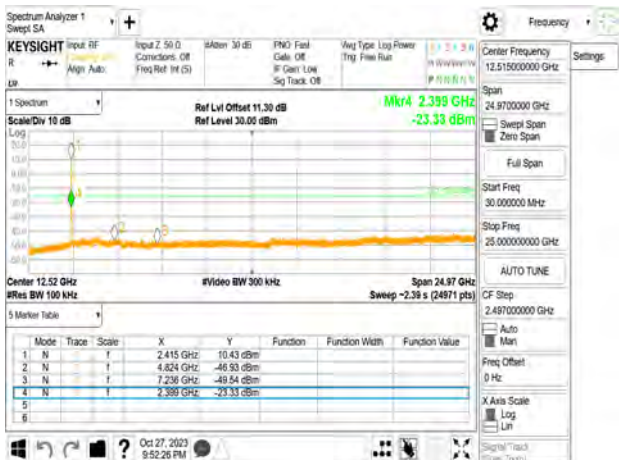

802.11n_20MHz_Chain1_2412MHz



802.11n_20MHz_Chain0_2437MHz



802.11n_20MHz_Chain1_2437MHz

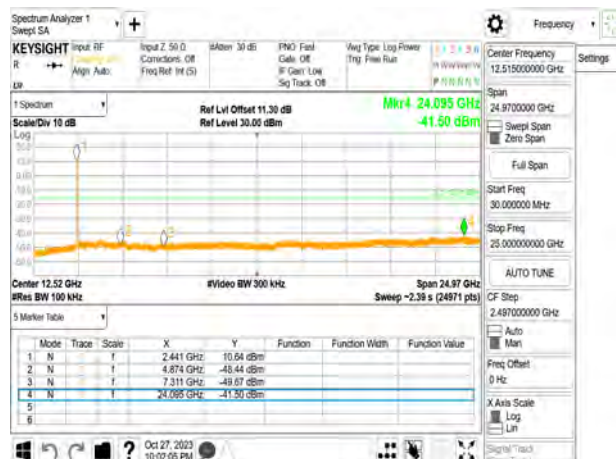

802.11n_20MHz_Chain0_2462MHz

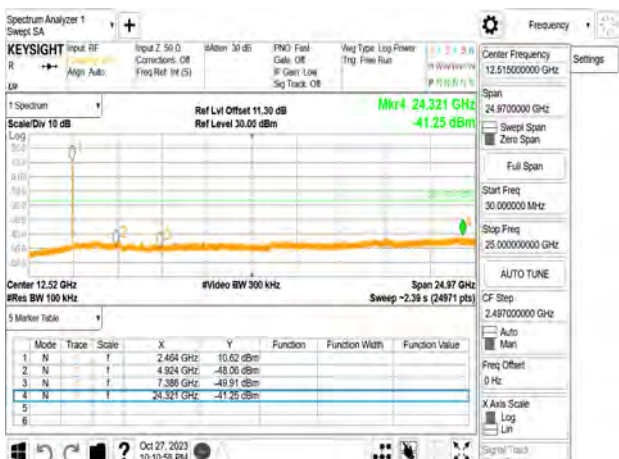

802.11n_20MHz_Chain1_2462MHz

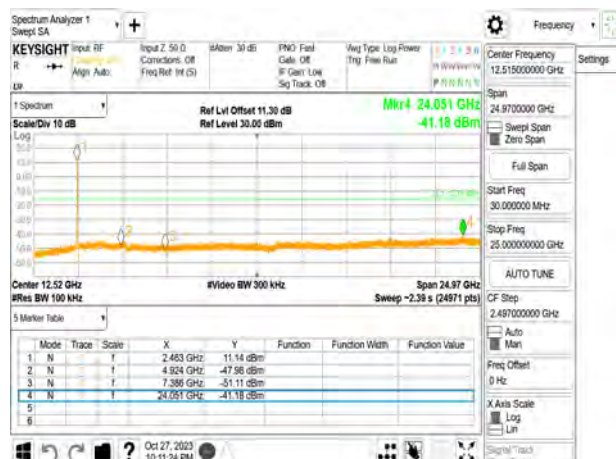

Unless otherwise stated the results shown in this test report refer only to the sample(s) tested and such sample(s) are retained for 90 days only.

除非另有說明，此報告結果僅對測試之樣品負責，同時此樣品僅保留90天。本報告未經本公司書面許可，不可部份複製。

This document is issued by the Company subject to its General Conditions of Service printed overleaf, available on request or accessible at <http://www.sgs.com.tw/Terms-and-Conditions> and for electronic format documents, subject to Terms and Conditions for Electronic Documents at <http://www.sgs.com.tw/Terms-and-Conditions>. Attention is drawn to the limitation of liability, indemnification and jurisdiction issues defined therein. Any holder of this document is advised that information contained hereon reflects the Company's findings at the time of its intervention only and within the limits of Client's instructions, if any. The Company's sole responsibility is to its Client and this document does not exonerate parties to a transaction from exercising all their rights and obligations under the transaction documents. This document cannot be reproduced except in full, without prior written approval of the Company. Any unauthorized alteration, forgery or falsification of the content or appearance of this document is unlawful and offenders may be prosecuted to the fullest extent of the law.

802.11n_20MHz_Chain2_2412MHz

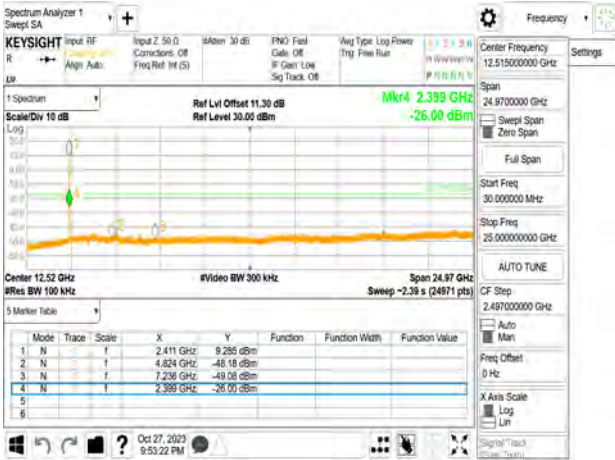

802.11n_20MHz_Chain3_2412MHz

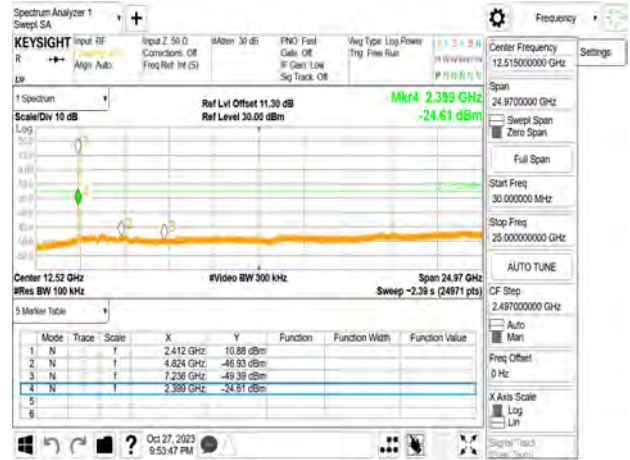

802.11n_20MHz_Chain2_2437MHz



802.11n_20MHz_Chain3_2437MHz



802.11n_20MHz_Chain2_2462MHz



802.11n_20MHz_Chain3_2462MHz

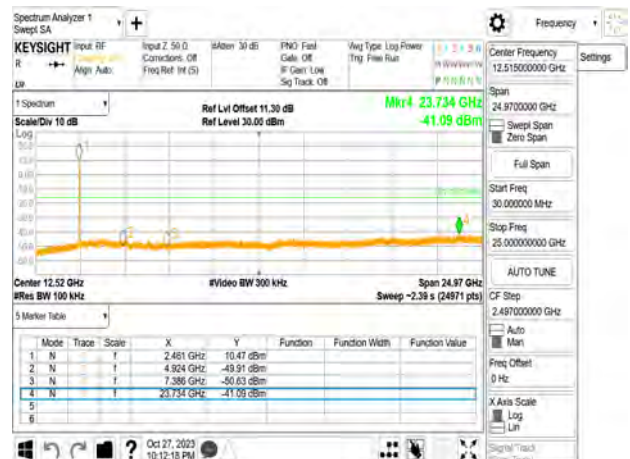

Unless otherwise stated the results shown in this test report refer only to the sample(s) tested and such sample(s) are retained for 90 days only.

除非另有說明，此報告結果僅對測試之樣品負責，同時此樣品僅保留90天。本報告未經本公司書面許可，不可部份複製。

This document is issued by the Company subject to its General Conditions of Service printed overleaf, available on request or accessible at <http://www.sgs.com.tw/Terms-and-Conditions> and for electronic format documents, subject to Terms and Conditions for Electronic Documents at <http://www.sgs.com.tw/Terms-and-Conditions>. Attention is drawn to the limitation of liability, indemnification and jurisdiction issues defined therein. Any holder of this document is advised that information contained hereon reflects the Company's findings at the time of its intervention only and within the limits of Client's instructions, if any. The Company's sole responsibility is to its Client and this document does not exonerate parties to a transaction from exercising all their rights and obligations under the transaction documents. This document cannot be reproduced except in full, without prior written approval of the Company. Any unauthorized alteration, forgery or falsification of the content or appearance of this document is unlawful and offenders may be prosecuted to the fullest extent of the law.

802.11n_40MHz_Chain0_2422MHz

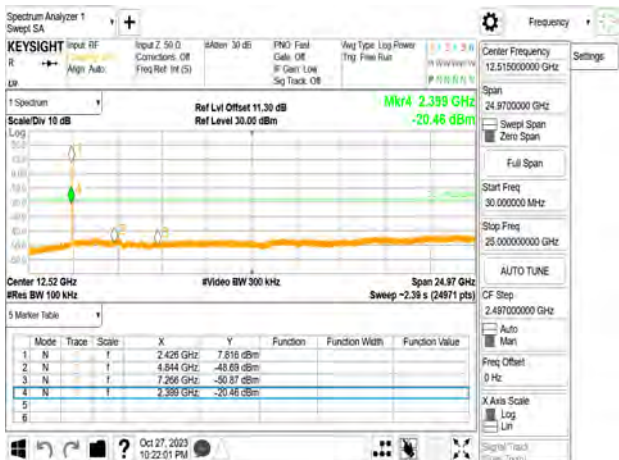

802.11n_40MHz_Chain1_2422MHz



802.11n_40MHz_Chain0_2437MHz

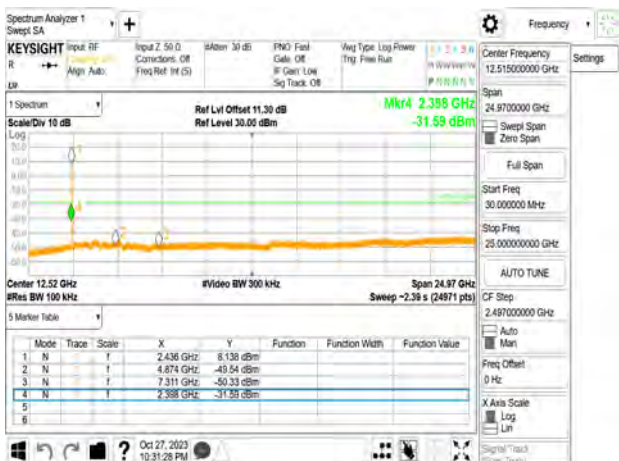

802.11n_40MHz_Chain1_2437MHz

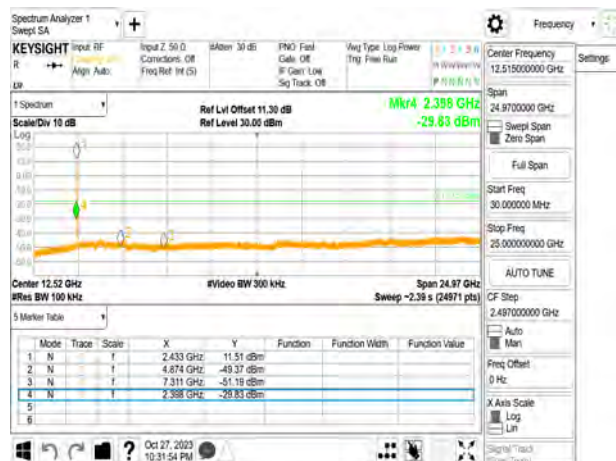

802.11n_40MHz_Chain0_2452MHz

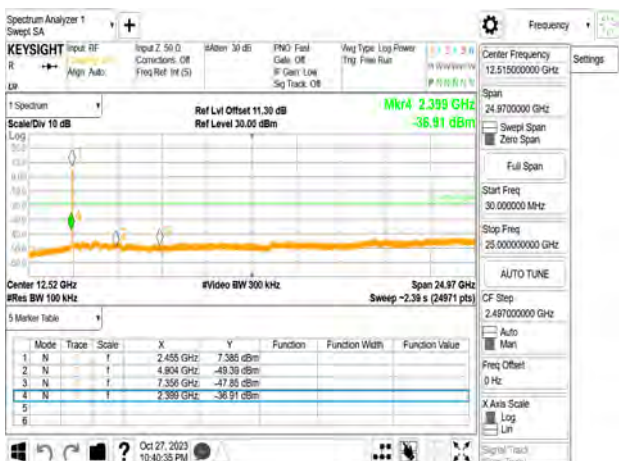

802.11n_40MHz_Chain1_2452MHz

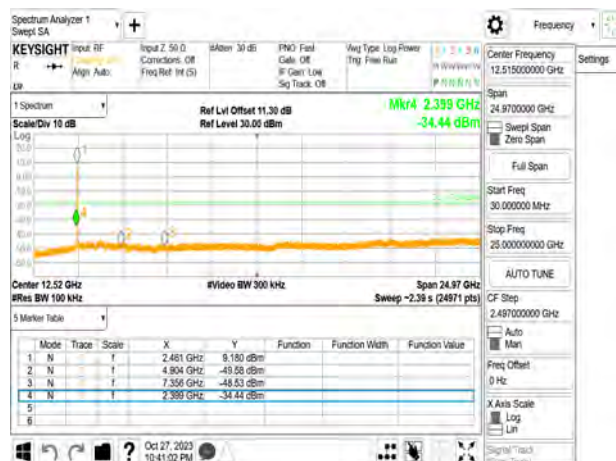

Unless otherwise stated the results shown in this test report refer only to the sample(s) tested and such sample(s) are retained for 90 days only.

除非另有說明，此報告結果僅對測試之樣品負責，同時此樣品僅保留90天。本報告未經本公司書面許可，不可部份複製。

This document is issued by the Company subject to its General Conditions of Service printed overleaf, available on request or accessible at <http://www.sgs.com.tw/Terms-and-Conditions> and for electronic format documents, subject to Terms and Conditions for Electronic Documents at <http://www.sgs.com.tw/Terms-and-Conditions>. Attention is drawn to the limitation of liability, indemnification and jurisdiction issues defined therein. Any holder of this document is advised that information contained hereon reflects the Company's findings at the time of its intervention only and within the limits of Client's instructions, if any. The Company's sole responsibility is to its Client and this document does not exonerate parties to a transaction from exercising all their rights and obligations under the transaction documents. This document cannot be reproduced except in full, without prior written approval of the Company. Any unauthorized alteration, forgery or falsification of the content or appearance of this document is unlawful and offenders may be prosecuted to the fullest extent of the law.

802.11n_40MHz_Chain2_2422MHz

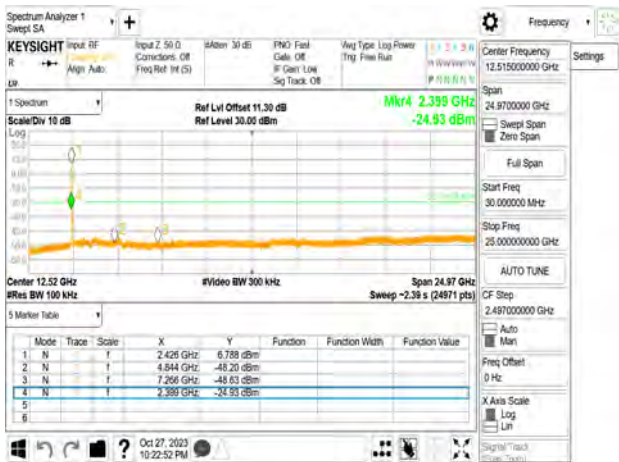

802.11n_40MHz_Chain3_2422MHz



802.11n_40MHz_Chain2_2437MHz

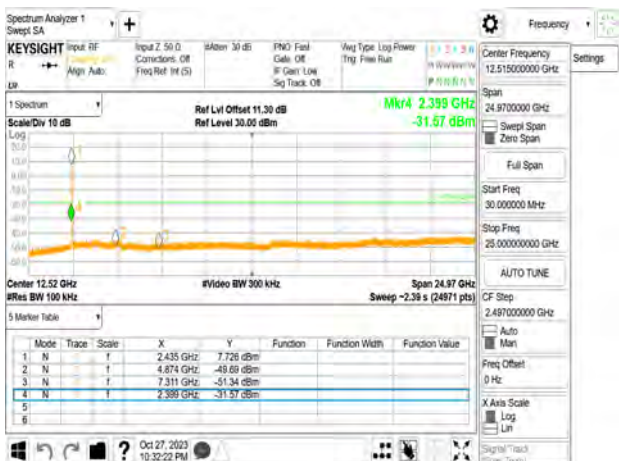

802.11n_40MHz_Chain3_2437MHz

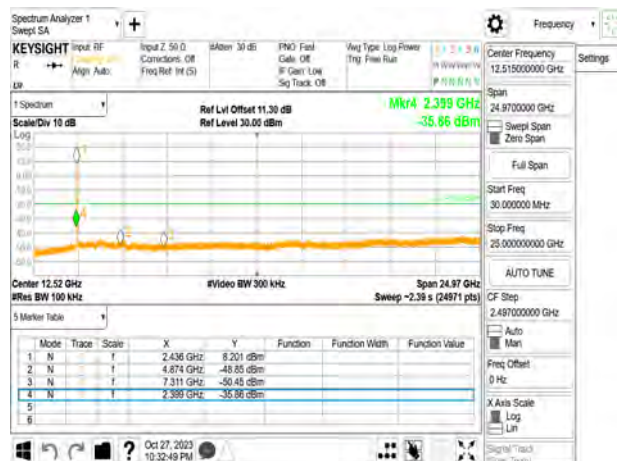

802.11n_40MHz_Chain2_2452MHz

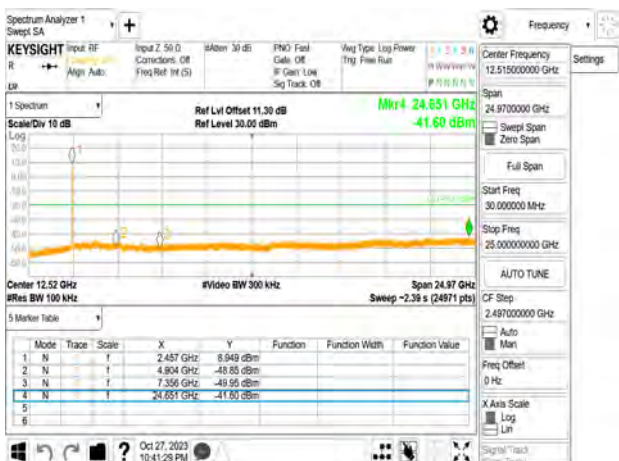

802.11n_40MHz_Chain3_2452MHz

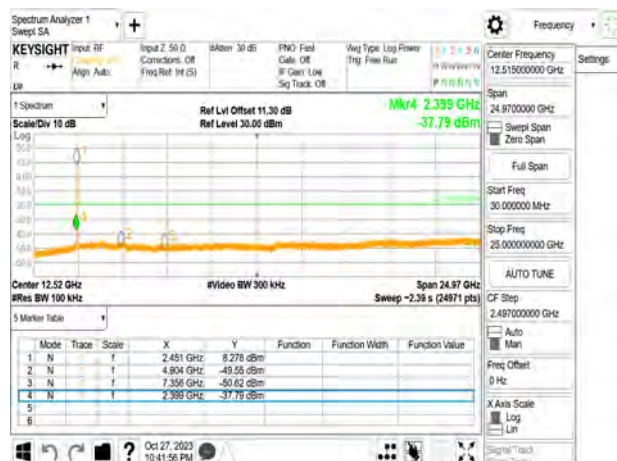

Unless otherwise stated the results shown in this test report refer only to the sample(s) tested and such sample(s) are retained for 90 days only.

除非另有說明，此報告結果僅對測試之樣品負責，同時此樣品僅保留90天。本報告未經本公司書面許可，不可部份複製。

This document is issued by the Company subject to its General Conditions of Service printed overleaf, available on request or accessible at <http://www.sgs.com.tw/Terms-and-Conditions> and for electronic format documents, subject to Terms and Conditions for Electronic Documents at <http://www.sgs.com.tw/Terms-and-Conditions>. Attention is drawn to the limitation of liability, indemnification and jurisdiction issues defined therein. Any holder of this document is advised that information contained hereon reflects the Company's findings at the time of its intervention only and within the limits of Client's instructions, if any. The Company's sole responsibility is to its Client and this document does not exonerate parties to a transaction from exercising all their rights and obligations under the transaction documents. This document cannot be reproduced except in full, without prior written approval of the Company. Any unauthorized alteration, forgery or falsification of the content or appearance of this document is unlawful and offenders may be prosecuted to the fullest extent of the law.

802.11be_20MHz_Chain0_2412MHz

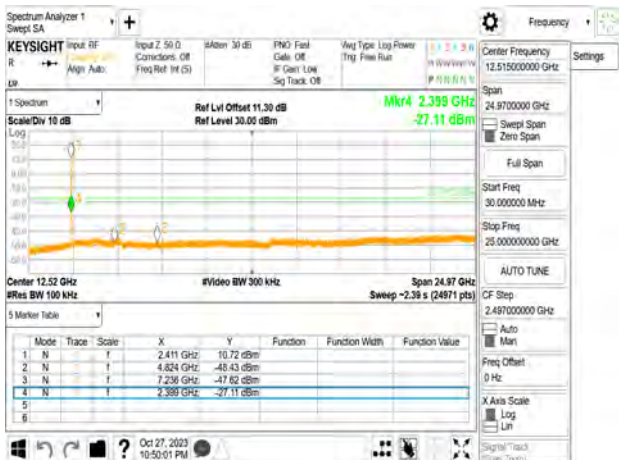

802.11be_20MHz_Chain1_2412MHz

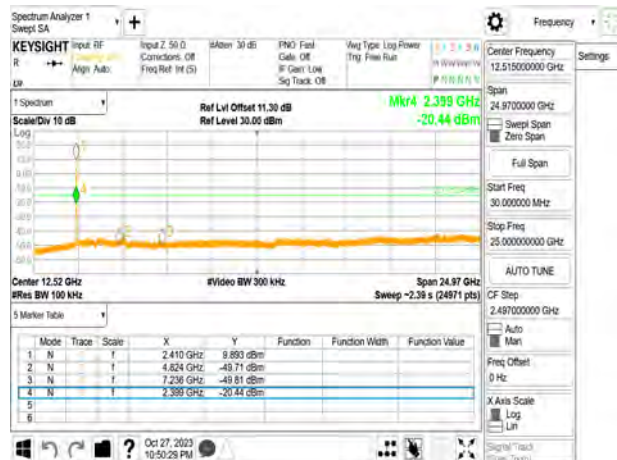

802.11be_20MHz_Chain0_2437MHz



802.11be_20MHz_Chain1_2437MHz

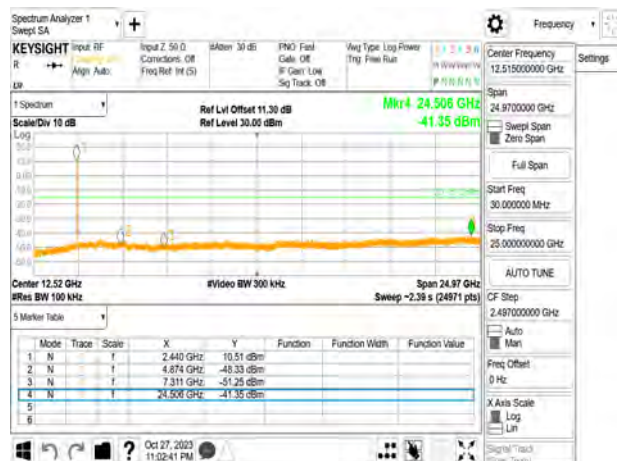

802.11be_20MHz_Chain0_2462MHz



802.11be_20MHz_Chain1_2462MHz



Unless otherwise stated the results shown in this test report refer only to the sample(s) tested and such sample(s) are retained for 90 days only.

除非另有說明，此報告結果僅對測試之樣品負責，同時此樣品僅保留90天。本報告未經本公司書面許可，不可部份複製。

This document is issued by the Company subject to its General Conditions of Service printed overleaf, available on request or accessible at <http://www.sgs.com.tw/Terms-and-Conditions> and for electronic format documents, subject to Terms and Conditions for Electronic Documents at <http://www.sgs.com.tw/Terms-and-Conditions>. Attention is drawn to the limitation of liability, indemnification and jurisdiction issues defined therein. Any holder of this document is advised that information contained hereon reflects the Company's findings at the time of its intervention only and within the limits of Client's instructions, if any. The Company's sole responsibility is to its Client and this document does not exonerate parties to a transaction from exercising all their rights and obligations under the transaction documents. This document cannot be reproduced except in full, without prior written approval of the Company. Any unauthorized alteration, forgery or falsification of the content or appearance of this document is unlawful and offenders may be prosecuted to the fullest extent of the law.

802.11be_20MHz_Chain2_2412MHz

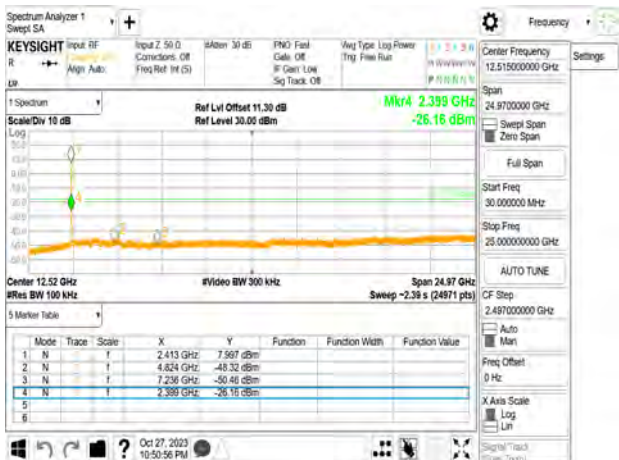

802.11be_20MHz_Chain3_2412MHz

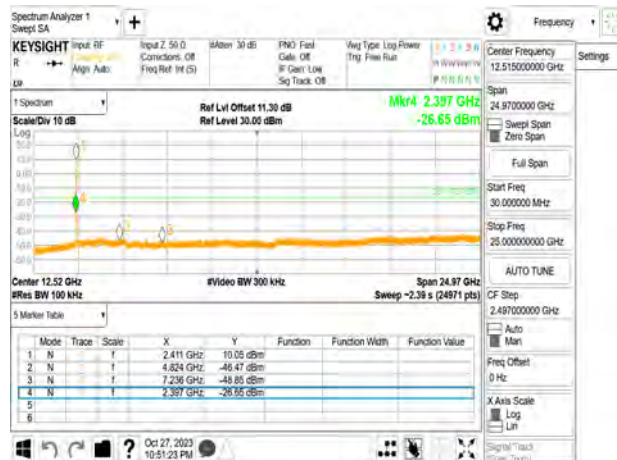

802.11be_20MHz_Chain2_2437MHz

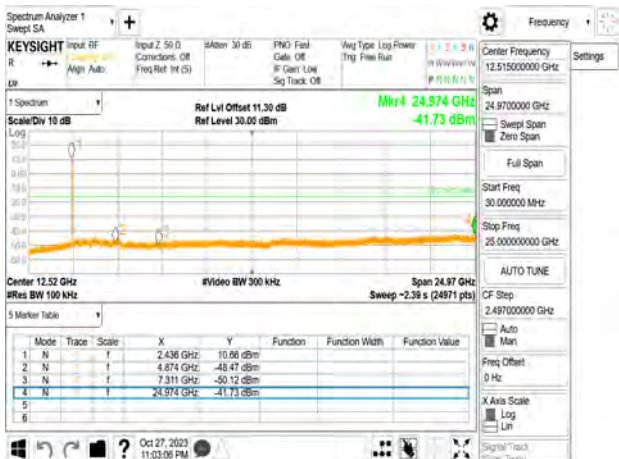

802.11be_20MHz_Chain3_2437MHz

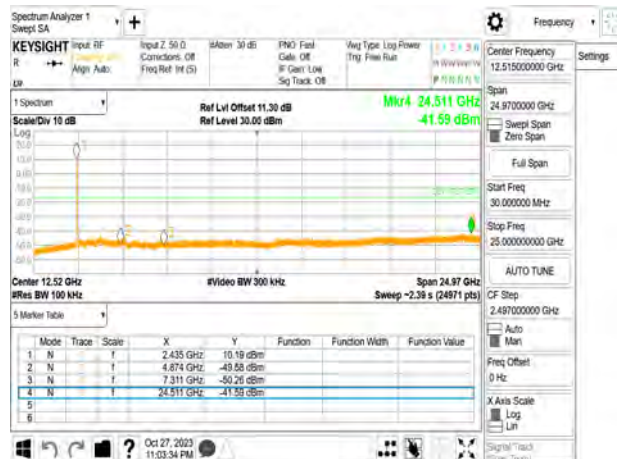

802.11be_20MHz_Chain2_2462MHz



802.11be_20MHz_Chain3_2462MHz

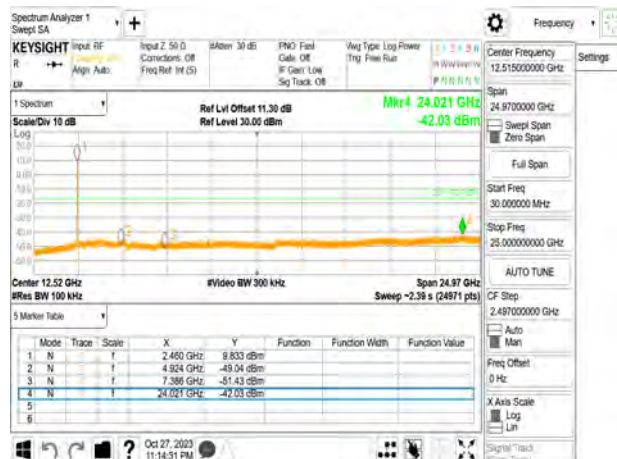

Unless otherwise stated the results shown in this test report refer only to the sample(s) tested and such sample(s) are retained for 90 days only.

除非另有說明，此報告結果僅對測試之樣品負責，同時此樣品僅保留90天。本報告未經本公司書面許可，不可部份複製。

This document is issued by the Company subject to its General Conditions of Service printed overleaf, available on request or accessible at <http://www.sgs.com.tw/Terms-and-Conditions> and for electronic format documents, subject to Terms and Conditions for Electronic Documents at <http://www.sgs.com.tw/Terms-and-Conditions>. Attention is drawn to the limitation of liability, indemnification and jurisdiction issues defined therein. Any holder of this document is advised that information contained hereon reflects the Company's findings at the time of its intervention only and within the limits of Client's instructions, if any. The Company's sole responsibility is to its Client and this document does not exonerate parties to a transaction from exercising all their rights and obligations under the transaction documents. This document cannot be reproduced except in full, without prior written approval of the Company. Any unauthorized alteration, forgery or falsification of the content or appearance of this document is unlawful and offenders may be prosecuted to the fullest extent of the law.

802.11be_40MHz_Chain0_2422MHz



802.11be_40MHz_Chain1_2422MHz

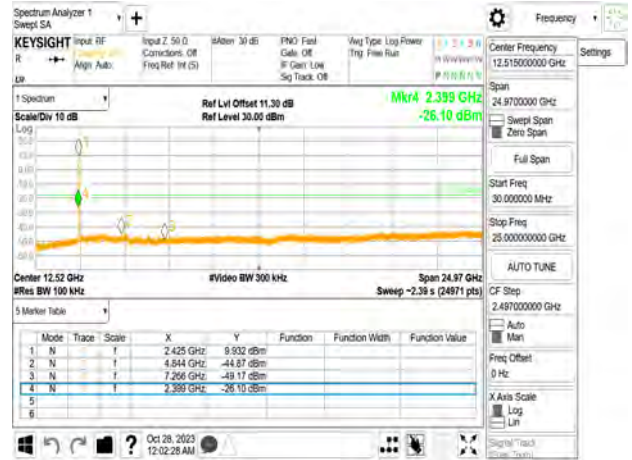

802.11be_40MHz_Chain0_2437MHz



802.11be_40MHz_Chain1_2437MHz

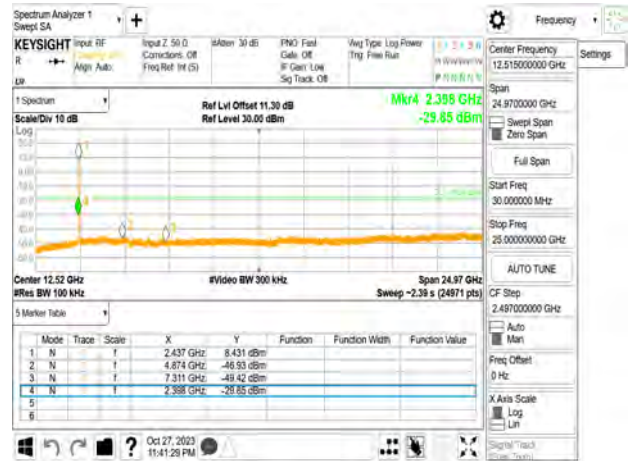

802.11be_40MHz_Chain0_2452MHz

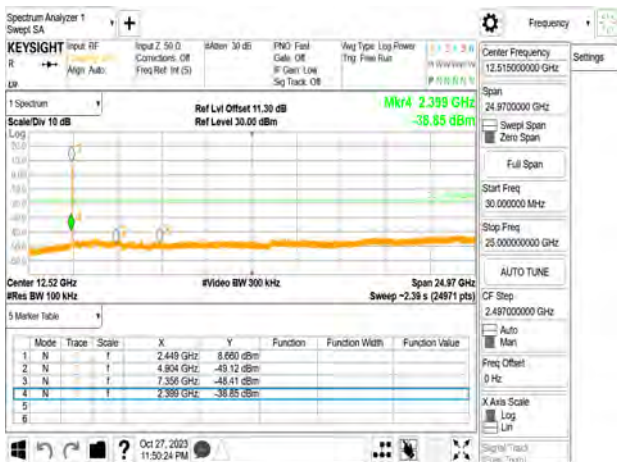

802.11be_40MHz_Chain1_2452MHz

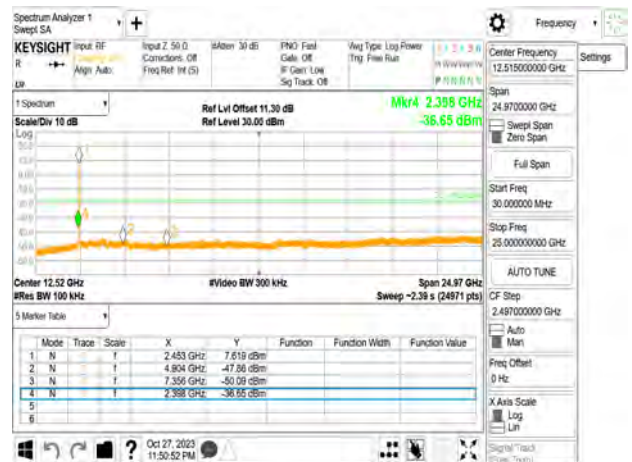

Unless otherwise stated the results shown in this test report refer only to the sample(s) tested and such sample(s) are retained for 90 days only.

除非另有說明，此報告結果僅對測試之樣品負責，同時此樣品僅保留90天。本報告未經本公司書面許可，不可部份複製。

This document is issued by the Company subject to its General Conditions of Service printed overleaf, available on request or accessible at <http://www.sgs.com.tw/Terms-and-Conditions> and for electronic format documents, subject to Terms and Conditions for Electronic Documents at <http://www.sgs.com.tw/Terms-and-Conditions>. Attention is drawn to the limitation of liability, indemnification and jurisdiction issues defined therein. Any holder of this document is advised that information contained hereon reflects the Company's findings at the time of its intervention only and within the limits of Client's instructions, if any. The Company's sole responsibility is to its Client and this document does not exonerate parties to a transaction from exercising all their rights and obligations under the transaction documents. This document cannot be reproduced except in full, without prior written approval of the Company. Any unauthorized alteration, forgery or falsification of the content or appearance of this document is unlawful and offenders may be prosecuted to the fullest extent of the law.

802.11be_40MHz_Chain2_2422MHz



802.11be_40MHz_Chain3_2422MHz

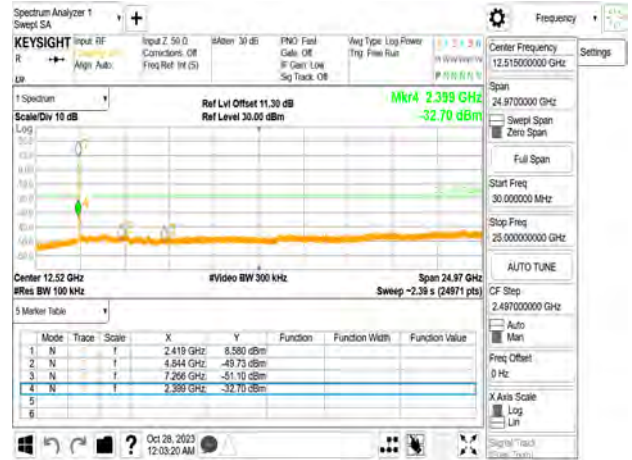

802.11be_40MHz_Chain2_2437MHz

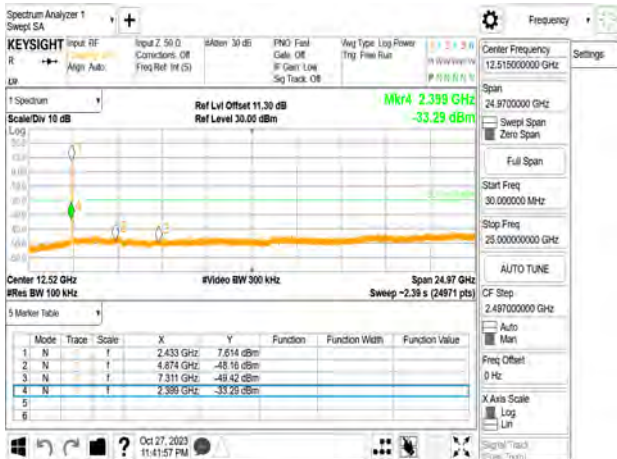

802.11be_40MHz_Chain3_2437MHz

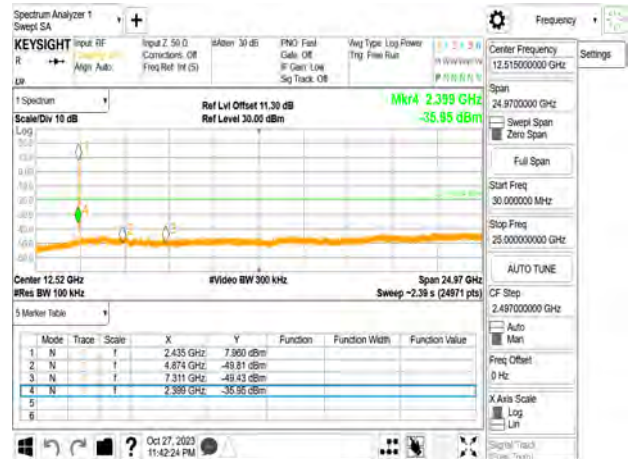

802.11be_40MHz_Chain2_2452MHz

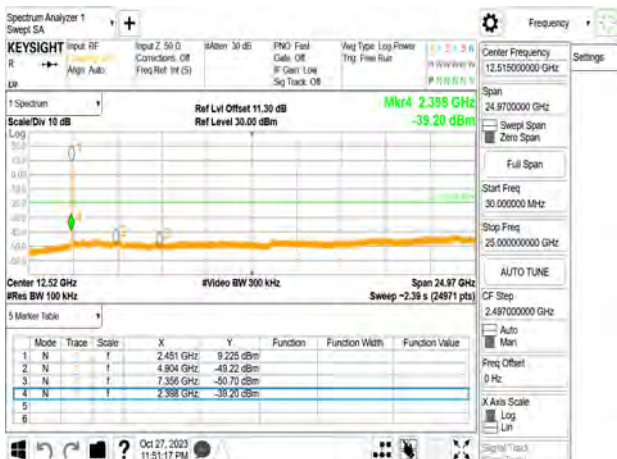

802.11be_40MHz_Chain3_2452MHz

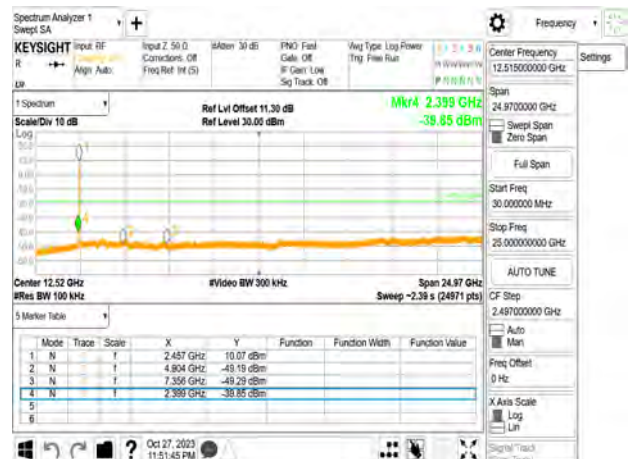

Unless otherwise stated the results shown in this test report refer only to the sample(s) tested and such sample(s) are retained for 90 days only.

除非另有說明，此報告結果僅對測試之樣品負責，同時此樣品僅保留90天。本報告未經本公司書面許可，不可部份複製。

This document is issued by the Company subject to its General Conditions of Service printed overleaf, available on request or accessible at <http://www.sgs.com.tw/Terms-and-Conditions> and for electronic format documents, subject to Terms and Conditions for Electronic Documents at <http://www.sgs.com.tw/Terms-and-Conditions>. Attention is drawn to the limitation of liability, indemnification and jurisdiction issues defined therein. Any holder of this document is advised that information contained hereon reflects the Company's findings at the time of its intervention only and within the limits of Client's instructions, if any. The Company's sole responsibility is to its Client and this document does not exonerate parties to a transaction from exercising all their rights and obligations under the transaction documents. This document cannot be reproduced except in full, without prior written approval of the Company. Any unauthorized alteration, forgery or falsification of the content or appearance of this document is unlawful and offenders may be prosecuted to the fullest extent of the law.

11 RADIATED BANDEDGE AND SPURIOUS EMISSION MEASUREMENT

11.1 Standard Applicable

In any 100 kHz bandwidth outside the frequency band in which the spread spectrum or digitally modulated intentional radiator is operating, the radio frequency power that is produced by the intentional radiator shall be at least 20 dB below that in the 100 kHz bandwidth within the band that contains the highest level of the desired power, based on either an RF conducted or a radiated measurement, provided the transmitter demonstrates compliance with the peak conducted power limits or if the transmitter complies with the conducted power limits based on the use of RMS averaging over a time interval the attenuation required under this paragraph shall be 30 dB instead of 20 dB. In addition, radiated emissions which fall in the restricted bands must also comply with the §15.209 limit as below.

And according to §15.33(a) (1), for an intentional radiator operates below 10GHz, the frequency range of measurements: to the tenth harmonic of the highest fundamental frequency or to 40GHz, whichever is lower.

Frequency (MHz)	Field strength (microvolts/meter)	Distance (meters)
0.009-0.490	2400/F(kHz)	300
0.490-1.705	24000/F(kHz)	30
1.705-30	30	30
30-88	100	3
88-216	150	3
216-960	200	3
Above 960	500	3

Note:

1. The lower limit shall apply at the transition frequencies.

Unless otherwise stated the results shown in this test report refer only to the sample(s) tested and such sample(s) are retained for 90 days only.

除非另有說明，此報告結果僅對測試之樣品負責，同時此樣品僅保留90天。本報告未經本公司書面許可，不可部份複製。

This document is issued by the Company subject to its General Conditions of Service printed overleaf, available on request or accessible at <http://www.sgs.com.tw/Terms-and-Conditions> and for electronic format documents, subject to Terms and Conditions for Electronic Documents at <http://www.sgs.com.tw/Terms-and-Conditions>. Attention is drawn to the limitation of liability, indemnification and jurisdiction issues defined therein. Any holder of this document is advised that information contained hereon reflects the Company's findings at the time of its intervention only and within the limits of Client's instructions, if any. The Company's sole responsibility is to its Client and this document does not exonerate parties to a transaction from exercising all their rights and obligations under the transaction documents. This document cannot be reproduced except in full, without prior written approval of the Company. Any unauthorized alteration, forgery or falsification of the content or appearance of this document is unlawful and offenders may be prosecuted to the fullest extent of the law.

11.2 Test Setup

(A) Radiated Emission Test Set-Up, Frequency Below 30MHz.

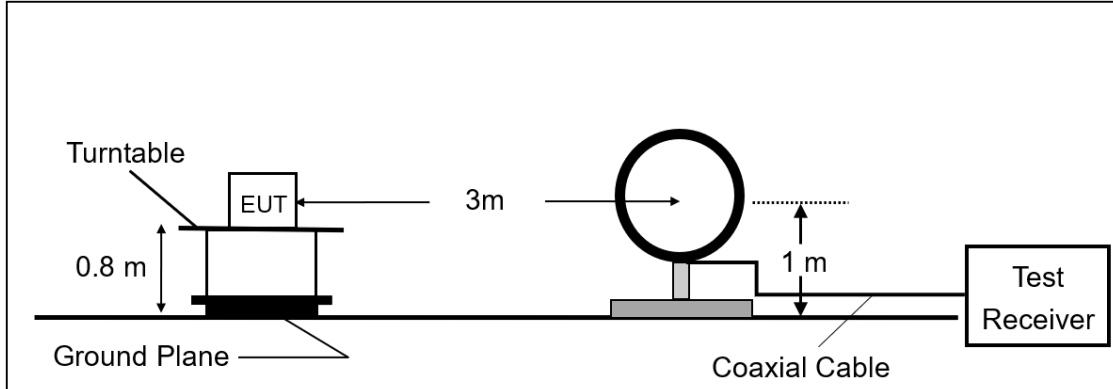

(B) Radiated Emission Test Set-Up, Frequency From 30MHz to 1000MHz.

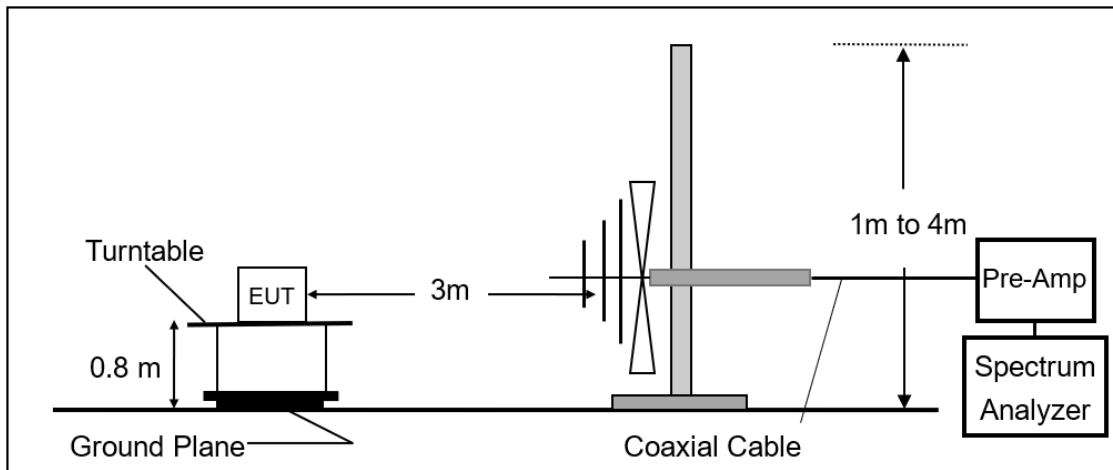

(C) Radiated Emission Test Set-Up, Frequency Above 1GHz.

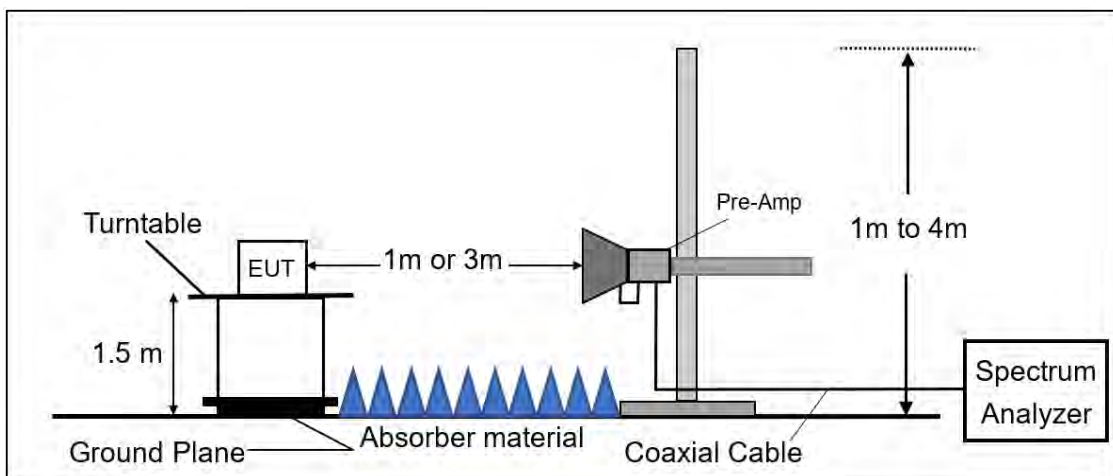

Unless otherwise stated the results shown in this test report refer only to the sample(s) tested and such sample(s) are retained for 90 days only.
 除非另有說明，此報告結果僅對測試之樣品負責，同時此樣品僅保留90天。本報告未經本公司書面許可，不可部份複製。

This document is issued by the Company subject to its General Conditions of Service printed overleaf, available on request or accessible at <http://www.sgs.com.tw/Terms-and-Conditions> and for electronic format documents, subject to Terms and Conditions for Electronic Documents at <http://www.sgs.com.tw/Terms-and-Conditions>. Attention is drawn to the limitation of liability, indemnification and jurisdiction issues defined therein. Any holder of this document is advised that information contained hereon reflects the Company's findings at the time of its intervention only and within the limits of Client's instructions, if any. The Company's sole responsibility is to its Client and this document does not exonerate parties to a transaction from exercising all their rights and obligations under the transaction documents. This document cannot be reproduced except in full, without prior written approval of the Company. Any unauthorized alteration, forgery or falsification of the content or appearance of this document is unlawful and offenders may be prosecuted to the fullest extent of the law.

11.3 Measurement Procedure

1. The testing follows the Measurement Procedure of FCC KDB 558074 D01 DTS Meas. Guidance and C63.10 section 11.11 Emissions in non-restricted frequency bands and section 11.12 Emissions in restricted frequency bands.
2. The EUT was placed on a turn table with 0.8m for frequency < 1GHz and 1.5m for frequency > 1GHz above ground plane.
3. The turn table shall rotate 360 degrees to determine the position of maximum emission level.
4. EUT is set 3m away from the receiving antenna which varied from 1m to 4m to find out the highest emissions.
5. Set the spectrum analyzer as RBW=100 kHz and VBW=300 kHz for Peak Detector at frequency between 30MHz and 1 GHz.
6. Use receiver mode as RBW=120 kHz for Quasi-peak (QP) at frequency between 30MHz and 1 GHz.
7. Set the spectrum analyzer as RBW=1 MHz, VBW=3 MHz for Maximum Emission Measurements at frequency above 1 GHz.
8. Set the spectrum analyzer as RBW=1 MHz, VBW=10 Hz (Duty cycle > 98%) or VBW ≥ 1/T (Duty cycle < 98%) for Average Emission Measurements at frequency above 1 GHz.
9. When measurement procedures for electric field radiated emissions above 1 GHz the EUT measurement is to be made “while keeping the antenna in the ‘cone of radiation’ from that area and pointed at the area both in azimuth and elevation, with polarization oriented for maximum response.” is still within the 3dB illumination BW of the measurement antenna.
10. Maximum procedure was performed on the six highest emissions to ensure EUT compliance.
11. And also, each emission was to be maximized by changing the polarization of receiving antenna both horizontal and vertical.
12. Repeat above procedures until all default test channel measured were complete.

11.4 Field Strength Calculation

The field strength is calculated by adding the Antenna Factor and Cable Factor and subtracting the Amplifier Gain and Duty Cycle Correction Factor (if any) from the measured reading.

The basic equation with a sample calculation is as follows:

$$FS = RA + AF + CL - AG$$

Where *FS = Field Strength*

CL = Cable Attenuation Factor (Cable Loss)

RA = Reading Amplitude

AG = Amplifier Gain

AF = Antenna Factor

Unless otherwise stated the results shown in this test report refer only to the sample(s) tested and such sample(s) are retained for 90 days only.

除非另有說明，此報告結果僅對測試之樣品負責，同時此樣品僅保留90天。本報告未經本公司書面許可，不可部份複製。

This document is issued by the Company subject to its General Conditions of Service printed overleaf, available on request or accessible at <http://www.sgs.com.tw/Terms-and-Conditions> and for electronic format documents, subject to Terms and Conditions for Electronic Documents at <http://www.sgs.com.tw/Terms-and-Conditions>. Attention is drawn to the limitation of liability, indemnification and jurisdiction issues defined therein. Any holder of this document is advised that information contained hereon reflects the Company's findings at the time of its intervention only and within the limits of Client's instructions, if any. The Company's sole responsibility is to its Client and this document does not exonerate parties to a transaction from exercising all their rights and obligations under the transaction documents. This document cannot be reproduced except in full, without prior written approval of the Company. Any unauthorized alteration, forgery or falsification of the content or appearance of this document is unlawful and offenders may be prosecuted to the fullest extent of the law.

The limit of the emission level is expressed in dB μ V/m, which converts $20 \cdot \log(uV/m)$

$Actual\ FS(dB\mu V/m) = SPA.\ Reading\ level(dB\mu V) + Factor(dB)$

$Factor(dB) = Antenna\ Factor(dB\mu V/m) + Cable\ Loss(dB) - Pre_Amplifier\ Gain(dB)$

11.5 Test Results of Radiated Spurious Emissions from 9 kHz to 30 MHz

The low frequency, which started from 9 kHz to 30MHz, was pre-scanned and the result which was 20dB lower than the limit per 15.31(o) was not reported.

11.6 Measurement Result

Note:

1. Refer to next page spectrum analyzer data chart and tabular data sheets.
2. Measurements are completed at peak and average level, the mark of average is the highest emission in restricted bands

Unless otherwise stated the results shown in this test report refer only to the sample(s) tested and such sample(s) are retained for 90 days only.
除非另有說明，此報告結果僅對測試之樣品負責，同時此樣品僅保留90天。本報告未經本公司書面許可，不可部份複製。

This document is issued by the Company subject to its General Conditions of Service printed overleaf, available on request or accessible at <http://www.sgs.com.tw/Terms-and-Conditions> and for electronic format documents, subject to Terms and Conditions for Electronic Documents at <http://www.sgs.com.tw/Terms-and-Conditions>. Attention is drawn to the limitation of liability, indemnification and jurisdiction issues defined therein. Any holder of this document is advised that information contained hereon reflects the Company's findings at the time of its intervention only and within the limits of Client's instructions, if any. The Company's sole responsibility is to its Client and this document does not exonerate parties to a transaction from exercising all their rights and obligations under the transaction documents. This document cannot be reproduced except in full, without prior written approval of the Company. Any unauthorized alteration, forgery or falsification of the content or appearance of this document is unlawful and offenders may be prosecuted to the fullest extent of the law.

11.6.1 Radiated Band Edge Measurement Result

Mode: CDD

Report Number	:TERF2308001922E2	Test Site	:SAC G Chamber
Operation Mode	:802.11b	Test Date	:2023-08-14
Test Frequency	:2412 MHz	Temp./Humi.	:25.6°C/55%
Test Mode	:Bandedge	Antenna Pol.	:Vertical
EUT Pol	:E2 Plane	Engineer	:Temo Chen

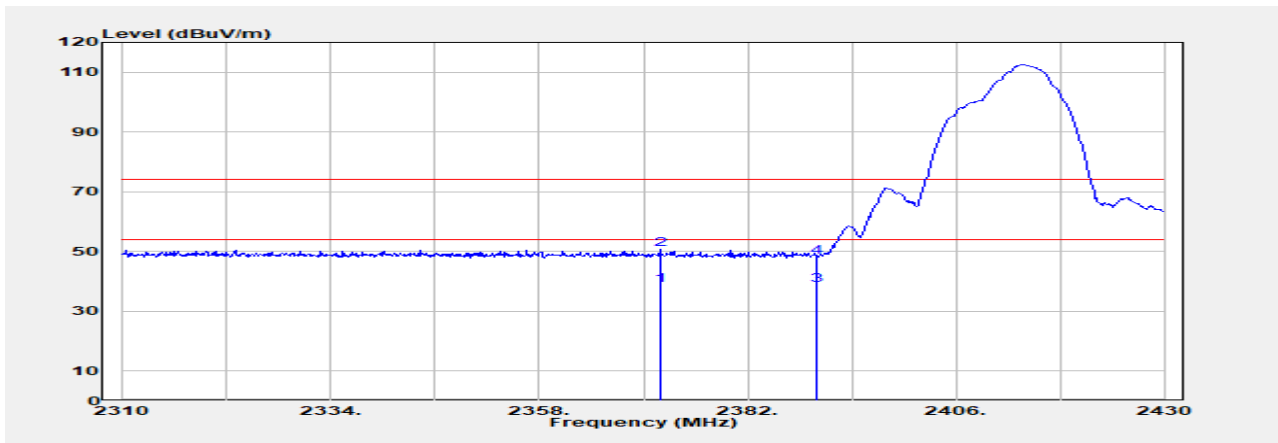

Freq.	Detector	Spectrum	Factor	Actual	Limit	Margin
MHz	PK/QP/AVG	Reading Level	dB	FS	@3m	dB
2371.920	Average	42.13	-3.42	38.72	54.00	-15.28
2371.920	Peak	54.06	-3.42	50.64	74.00	-23.36
2390.000	Average	42.17	-3.51	38.66	54.00	-15.34
2390.000	Peak	51.71	-3.51	48.20	74.00	-25.80

Unless otherwise stated the results shown in this test report refer only to the sample(s) tested and such sample(s) are retained for 90 days only.

除非另有說明，此報告結果僅對測試之樣品負責，同時此樣品僅保留90天。本報告未經本公司書面許可，不可部份複製。

This document is issued by the Company subject to its General Conditions of Service printed overleaf, available on request or accessible at <http://www.sgs.com.tw/Terms-and-Conditions> and for electronic format documents, subject to Terms and Conditions for Electronic Documents at <http://www.sgs.com.tw/Terms-and-Conditions>. Attention is drawn to the limitation of liability, indemnification and jurisdiction issues defined therein. Any holder of this document is advised that information contained hereon reflects the Company's findings at the time of its intervention only and within the limits of Client's instructions, if any. The Company's sole responsibility is to its Client and this document does not exonerate parties to a transaction from exercising all their rights and obligations under the transaction documents. This document cannot be reproduced except in full, without prior written approval of the Company. Any unauthorized alteration, forgery or falsification of the content or appearance of this document is unlawful and offenders may be prosecuted to the fullest extent of the law.

Report Number :TERF2308001922E2
 Operation Mode :802.11b
 Test Frequency :2412 MHz
 Test Mode :Bandedge
 EUT Pol :E2 Plane

Test Site :SAC G Chamber
 Test Date :2023-08-14
 Temp./Humi. :25.6°C/55%
 Antenna Pol. :Horizontal
 Engineer :Temo Chen

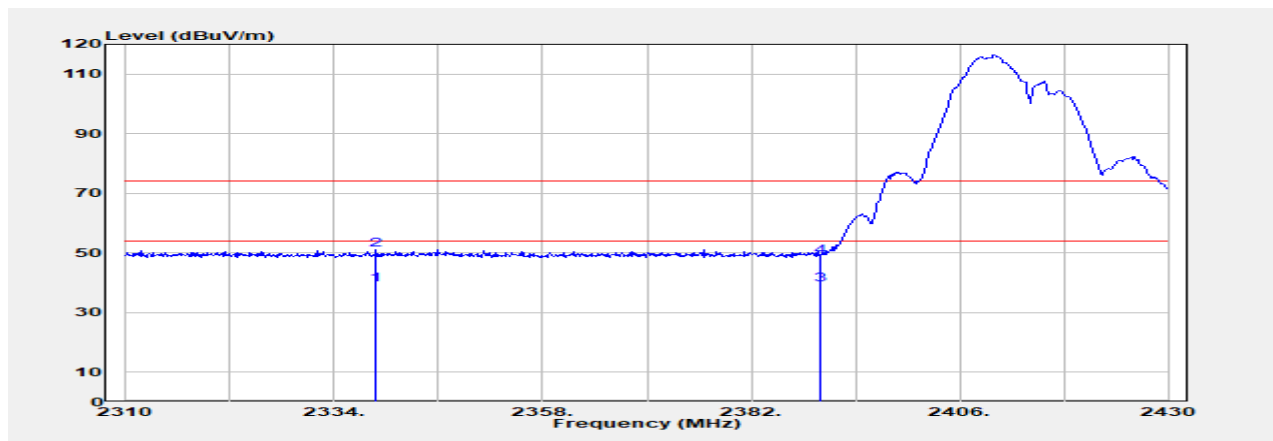

Freq. MHz	Detector Mode PK/QP/AVG	Spectrum Reading Level dBμV	Factor dB	Actual FS dBμV/m	Limit @3m dBμV/m	Margin dB
2338.800	Average	42.50	-3.29	39.21	54.00	-14.79
2338.800	Peak	54.44	-3.29	51.15	74.00	-22.85
2390.000	Average	42.91	-3.51	39.40	54.00	-14.60
2390.000	Peak	52.43	-3.51	48.92	74.00	-25.08

Unless otherwise stated the results shown in this test report refer only to the sample(s) tested and such sample(s) are retained for 90 days only.

除非另有說明，此報告結果僅對測試之樣品負責，同時此樣品僅保留90天。本報告未經本公司書面許可，不可部份複製。
 This document is issued by the Company subject to its General Conditions of Service printed overleaf, available on request or accessible at <http://www.sgs.com.tw/Terms-and-Conditions> and for electronic format documents, subject to Terms and Conditions for Electronic Documents at <http://www.sgs.com.tw/Terms-and-Conditions>. Attention is drawn to the limitation of liability, indemnification and jurisdiction issues defined therein. Any holder of this document is advised that information contained hereon reflects the Company's findings at the time of its intervention only and within the limits of Client's instructions, if any. The Company's sole responsibility is to its Client and this document does not exonerate parties to a transaction from exercising all their rights and obligations under the transaction documents. This document cannot be reproduced except in full, without prior written approval of the Company. Any unauthorized alteration, forgery or falsification of the content or appearance of this document is unlawful and offenders may be prosecuted to the fullest extent of the law.

Report Number :TERF2308001922E2
 Operation Mode :802.11b
 Test Frequency :2462 MHz
 Test Mode :Bandedge
 EUT Pol :E2 Plane

Test Site :SAC G Chamber
 Test Date :2023-08-07
 Temp./Humi. :26.0°C/54%
 Antenna Pol. :Vertical
 Engineer :Temo Chen

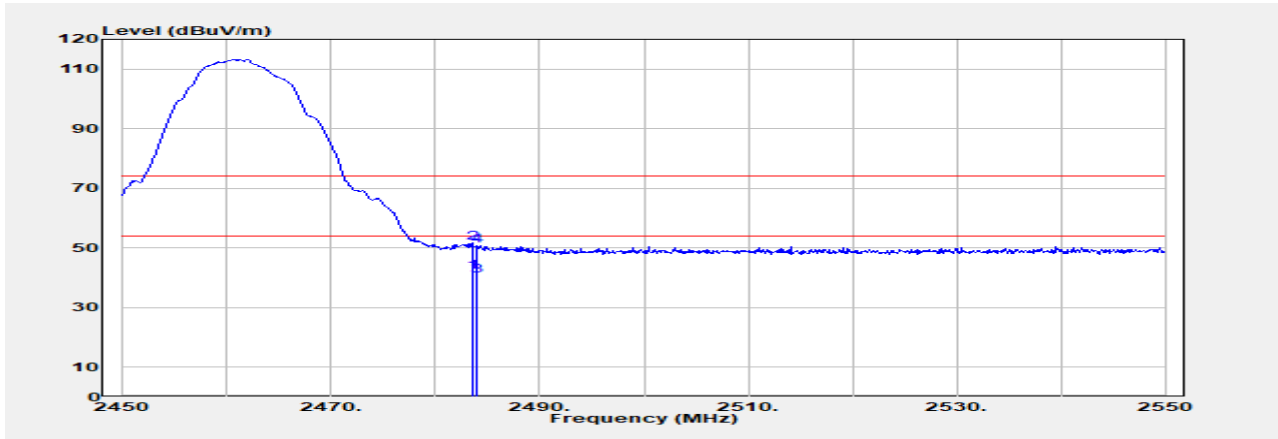

Freq. MHz	Detector Mode PK/QP/AVG	Spectrum Reading Level dBµV	Factor dB	Actual FS dBµV/m	Limit @3m dBµV/m	Margin dB
2483.500	Average	45.56	-3.54	42.02	54.00	-11.98
2483.500	Peak	55.26	-3.54	51.72	74.00	-22.28
2484.000	Average	44.19	-3.54	40.65	54.00	-13.35
2484.000	Peak	54.32	-3.54	50.77	74.00	-23.23

Unless otherwise stated the results shown in this test report refer only to the sample(s) tested and such sample(s) are retained for 90 days only.

除非另有說明，此報告結果僅對測試之樣品負責，同時此樣品僅保留90天。本報告未經本公司書面許可，不可部份複製。
 This document is issued by the Company subject to its General Conditions of Service printed overleaf, available on request or accessible at <http://www.sgs.com.tw/Terms-and-Conditions> and for electronic format documents, subject to Terms and Conditions for Electronic Documents at <http://www.sgs.com.tw/Terms-and-Conditions>. Attention is drawn to the limitation of liability, indemnification and jurisdiction issues defined therein. Any holder of this document is advised that information contained hereon reflects the Company's findings at the time of its intervention only and within the limits of Client's instructions, if any. The Company's sole responsibility is to its Client and this document does not exonerate parties to a transaction from exercising all their rights and obligations under the transaction documents. This document cannot be reproduced except in full, without prior written approval of the Company. Any unauthorized alteration, forgery or falsification of the content or appearance of this document is unlawful and offenders may be prosecuted to the fullest extent of the law.

Report Number :TERF2308001922E2
 Operation Mode :802.11b
 Test Frequency :2462 MHz
 Test Mode :Bandedge
 EUT Pol :E2 Plane

Test Site :SAC G Chamber
 Test Date :2023-08-07
 Temp./Humi. :26.0°C/54%
 Antenna Pol. :Horizontal
 Engineer :Temo Chen

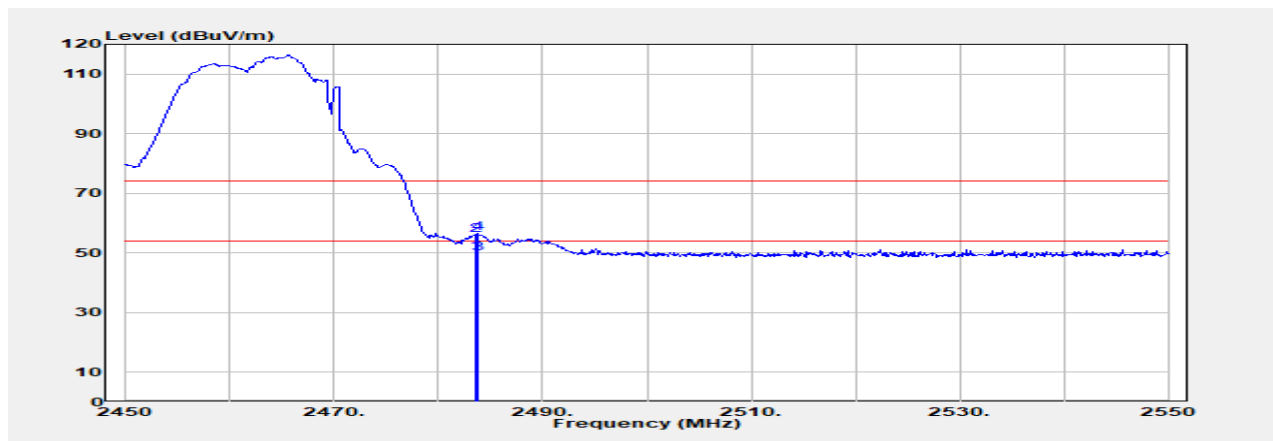

Freq. MHz	Detector Mode PK/QP/AVG	Spectrum Reading Level dB μ V	Factor dB	Actual FS dB μ V/m	Limit @3m dB μ V/m	Margin dB
2483.500	Average	53.68	-3.54	50.14	54.00	-3.86
2483.500	Peak	59.41	-3.54	55.87	74.00	-18.13
2483.700	Average	53.26	-3.54	49.71	54.00	-4.29
2483.700	Peak	60.25	-3.54	56.71	74.00	-17.29

Unless otherwise stated the results shown in this test report refer only to the sample(s) tested and such sample(s) are retained for 90 days only.

除非另有說明，此報告結果僅對測試之樣品負責，同時此樣品僅保留90天。本報告未經本公司書面許可，不可部份複製。
 This document is issued by the Company subject to its General Conditions of Service printed overleaf, available on request or accessible at <http://www.sgs.com.tw/Terms-and-Conditions> and for electronic format documents, subject to Terms and Conditions for Electronic Documents at <http://www.sgs.com.tw/Terms-and-Conditions>. Attention is drawn to the limitation of liability, indemnification and jurisdiction issues defined therein. Any holder of this document is advised that information contained hereon reflects the Company's findings at the time of its intervention only and within the limits of Client's instructions, if any. The Company's sole responsibility is to its Client and this document does not exonerate parties to a transaction from exercising all their rights and obligations under the transaction documents. This document cannot be reproduced except in full, without prior written approval of the Company. Any unauthorized alteration, forgery or falsification of the content or appearance of this document is unlawful and offenders may be prosecuted to the fullest extent of the law.

Report Number :TERF2308001922E2
 Operation Mode :802.11g
 Test Frequency :2412 MHz
 Test Mode :Bandedge
 EUT Pol :E2 Plane

Test Site :SAC G Chamber
 Test Date :2023-08-22
 Temp./Humi. :25.1°C/57%
 Antenna Pol. :Vertical
 Engineer :Temo Chen

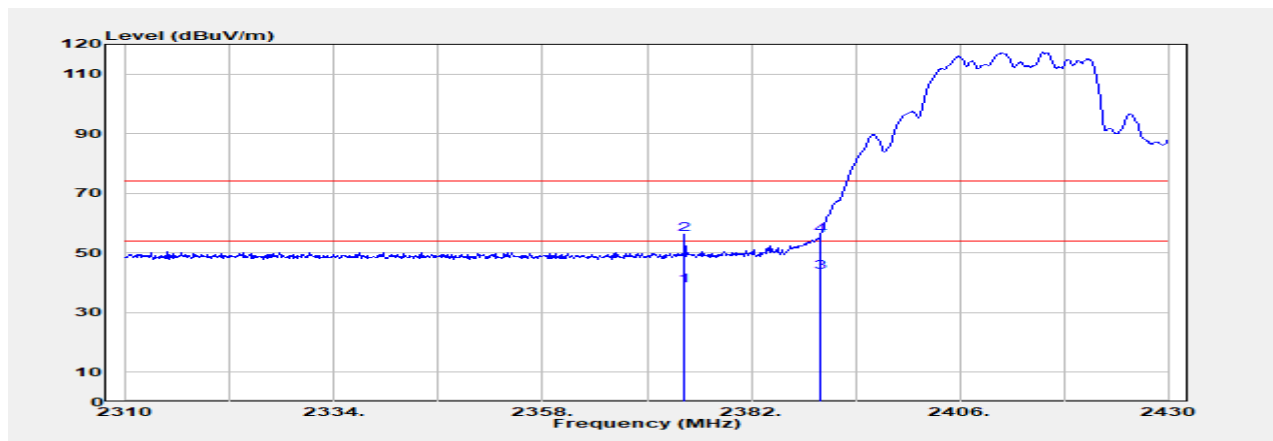

Freq. MHz	Detector Mode PK/QP/AVG	Spectrum Reading Level dBμV	Factor dB	Actual FS dBμV/m	Limit @3m dBμV/m	Margin dB
2374.320	Average	42.38	-3.43	38.95	54.00	-15.05
2374.320	Peak	59.66	-3.43	56.23	74.00	-17.77
2390.000	Average	47.25	-3.51	43.74	54.00	-10.26
2390.000	Peak	59.37	-3.51	55.86	74.00	-18.14

Unless otherwise stated the results shown in this test report refer only to the sample(s) tested and such sample(s) are retained for 90 days only.

除非另有說明，此報告結果僅對測試之樣品負責，同時此樣品僅保留90天。本報告未經本公司書面許可，不可部份複製。
 This document is issued by the Company subject to its General Conditions of Service printed overleaf, available on request or accessible at <http://www.sgs.com.tw/Terms-and-Conditions> and for electronic format documents, subject to Terms and Conditions for Electronic Documents at <http://www.sgs.com.tw/Terms-and-Conditions>. Attention is drawn to the limitation of liability, indemnification and jurisdiction issues defined therein. Any holder of this document is advised that information contained hereon reflects the Company's findings at the time of its intervention only and within the limits of Client's instructions, if any. The Company's sole responsibility is to its Client and this document does not exonerate parties to a transaction from exercising all their rights and obligations under the transaction documents. This document cannot be reproduced except in full, without prior written approval of the Company. Any unauthorized alteration, forgery or falsification of the content or appearance of this document is unlawful and offenders may be prosecuted to the fullest extent of the law.

Report Number :TERF2308001922E2
 Operation Mode :802.11g
 Test Frequency :2412 MHz
 Test Mode :Bandedge
 EUT Pol :E2 Plane

Test Site :SAC G Chamber
 Test Date :2023-08-22
 Temp./Humi. :25.1°C/57%
 Antenna Pol. :Horizontal
 Engineer :Temo Chen

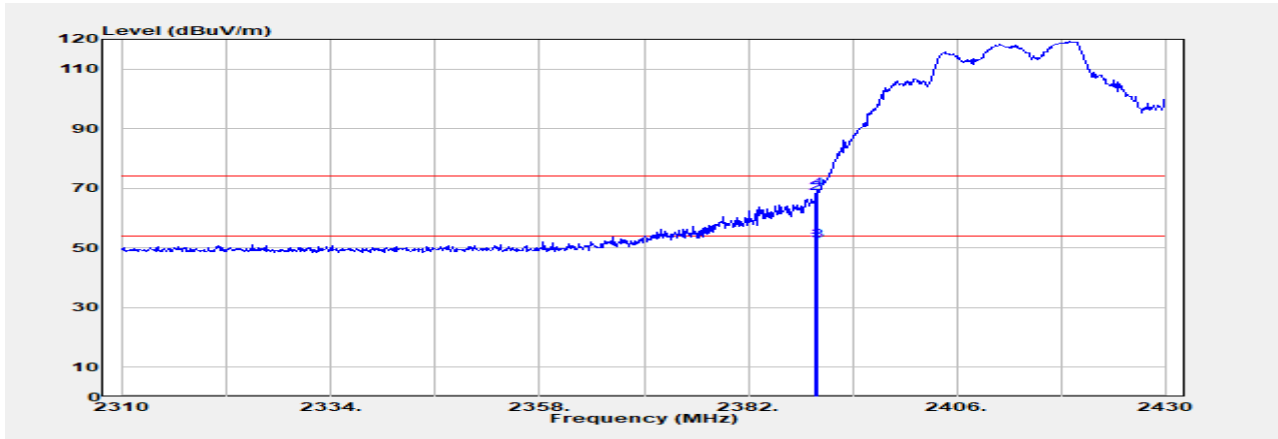

Freq. MHz	Detector Mode PK/QP/AVG	Spectrum Reading Level dB μ V	Factor dB	Actual FS dB μ V/m	Limit @3m dB μ V/m	Margin dB
2389.800	Average	55.12	-3.51	51.61	54.00	-2.39
2389.800	Peak	71.82	-3.51	68.31	74.00	-5.69
2390.000	Average	55.77	-3.51	52.26	54.00	-1.74
2390.000	Peak	72.97	-3.51	69.46	74.00	-4.54

Unless otherwise stated the results shown in this test report refer only to the sample(s) tested and such sample(s) are retained for 90 days only.

除非另有說明，此報告結果僅對測試之樣品負責，同時此樣品僅保留90天。本報告未經本公司書面許可，不可部份複製。
 This document is issued by the Company subject to its General Conditions of Service printed overleaf, available on request or accessible at <http://www.sgs.com.tw/Terms-and-Conditions> and for electronic format documents, subject to Terms and Conditions for Electronic Documents at <http://www.sgs.com.tw/Terms-and-Conditions>. Attention is drawn to the limitation of liability, indemnification and jurisdiction issues defined therein. Any holder of this document is advised that information contained hereon reflects the Company's findings at the time of its intervention only and within the limits of Client's instructions, if any. The Company's sole responsibility is to its Client and this document does not exonerate parties to a transaction from exercising all their rights and obligations under the transaction documents. This document cannot be reproduced except in full, without prior written approval of the Company. Any unauthorized alteration, forgery or falsification of the content or appearance of this document is unlawful and offenders may be prosecuted to the fullest extent of the law.

Report Number :TERF2308001922E2
 Operation Mode :802.11g
 Test Frequency :2462 MHz
 Test Mode :Bandedge
 EUT Pol :E2 Plane

Test Site :SAC G Chamber
 Test Date :2023-08-22
 Temp./Humi. :25.1°C/57%
 Antenna Pol. :Vertical
 Engineer :Temo Chen

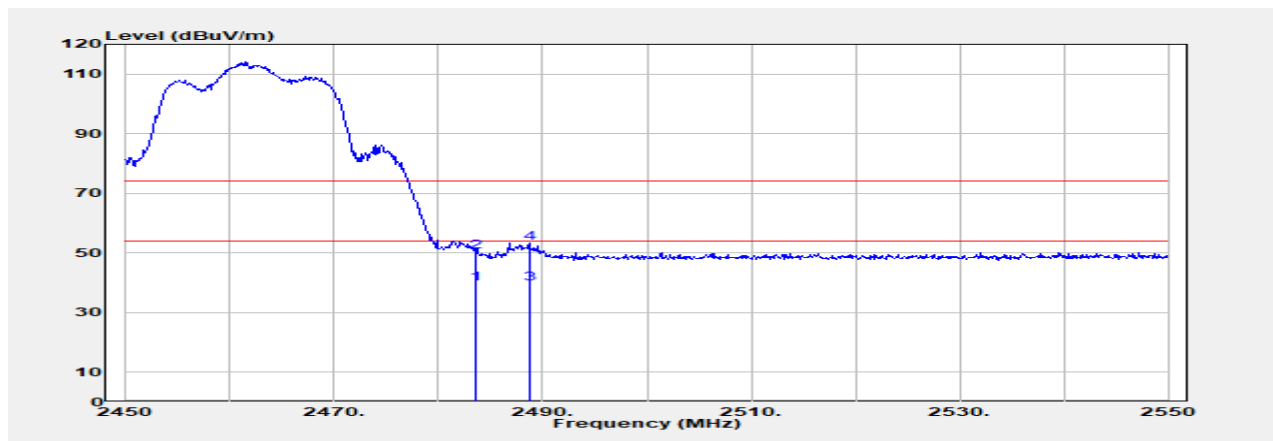

Freq. MHz	Detector Mode PK/QP/AVG	Spectrum Reading Level dB μ V	Factor dB	Actual FS dB μ V/m	Limit @3m dB μ V/m	Margin dB
2483.500	Average	43.20	-3.54	39.65	54.00	-14.35
2483.500	Peak	53.95	-3.54	50.40	74.00	-23.60
2488.700	Average	43.27	-3.54	39.73	54.00	-14.27
2488.700	Peak	56.81	-3.54	53.27	74.00	-20.73

Unless otherwise stated the results shown in this test report refer only to the sample(s) tested and such sample(s) are retained for 90 days only.

除非另有說明，此報告結果僅對測試之樣品負責，同時此樣品僅保留90天。本報告未經本公司書面許可，不可部份複製。
 This document is issued by the Company subject to its General Conditions of Service printed overleaf, available on request or accessible at <http://www.sgs.com.tw/Terms-and-Conditions> and for electronic format documents, subject to Terms and Conditions for Electronic Documents at <http://www.sgs.com.tw/Terms-and-Conditions>. Attention is drawn to the limitation of liability, indemnification and jurisdiction issues defined therein. Any holder of this document is advised that information contained hereon reflects the Company's findings at the time of its intervention only and within the limits of Client's instructions, if any. The Company's sole responsibility is to its Client and this document does not exonerate parties to a transaction from exercising all their rights and obligations under the transaction documents. This document cannot be reproduced except in full, without prior written approval of the Company. Any unauthorized alteration, forgery or falsification of the content or appearance of this document is unlawful and offenders may be prosecuted to the fullest extent of the law.

Report Number :TERF2308001922E2
 Operation Mode :802.11g
 Test Frequency :2462 MHz
 Test Mode :Bandedge
 EUT Pol :E2 Plane

Test Site :SAC G Chamber
 Test Date :2023-08-22
 Temp./Humi. :25.1°C/57%
 Antenna Pol. :Horizontal
 Engineer :Temo Chen

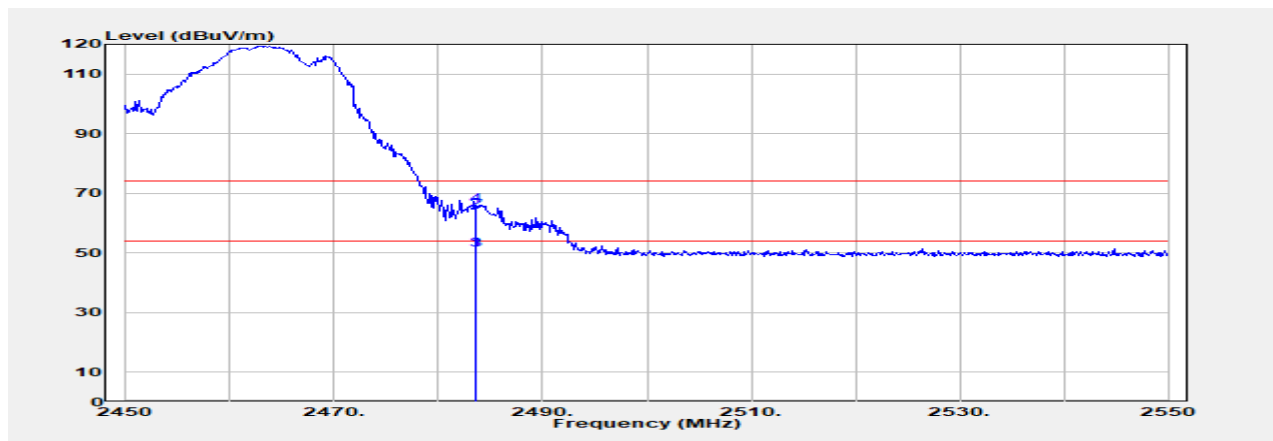

Freq. MHz	Detector Mode PK/QP/AVG	Spectrum Reading Level dBμV	Factor dB	Actual FS dBμV/m	Limit @3m dBμV/m	Margin dB
2483.500	Average	54.53	-3.54	50.98	54.00	-3.02
2483.500	Peak	67.91	-3.54	64.37	74.00	-9.63
2483.600	Average	54.59	-3.54	51.04	54.00	-2.96
2483.600	Peak	69.56	-3.54	66.01	74.00	-7.99

Unless otherwise stated the results shown in this test report refer only to the sample(s) tested and such sample(s) are retained for 90 days only.
 除非另有說明，此報告結果僅對測試之樣品負責，同時此樣品僅保留90天。本報告未經本公司書面許可，不可部份複製。

This document is issued by the Company subject to its General Conditions of Service printed overleaf, available on request or accessible at <http://www.sgs.com.tw/Terms-and-Conditions> and for electronic format documents, subject to Terms and Conditions for Electronic Documents at <http://www.sgs.com.tw/Terms-and-Conditions>. Attention is drawn to the limitation of liability, indemnification and jurisdiction issues defined therein. Any holder of this document is advised that information contained hereon reflects the Company's findings at the time of its intervention only and within the limits of Client's instructions, if any. The Company's sole responsibility is to its Client and this document does not exonerate parties to a transaction from exercising all their rights and obligations under the transaction documents. This document cannot be reproduced except in full, without prior written approval of the Company. Any unauthorized alteration, forgery or falsification of the content or appearance of this document is unlawful and offenders may be prosecuted to the fullest extent of the law.

Report Number :TERF2308001922E2
 Operation Mode :802.11n20
 Test Frequency :2412 MHz
 Test Mode :Bandedge
 EUT Pol :E2 Plane

Test Site :SAC G Chamber
 Test Date :2023-08-22
 Temp./Humi. :25.1°C/57%
 Antenna Pol. :Vertical
 Engineer :Temo Chen

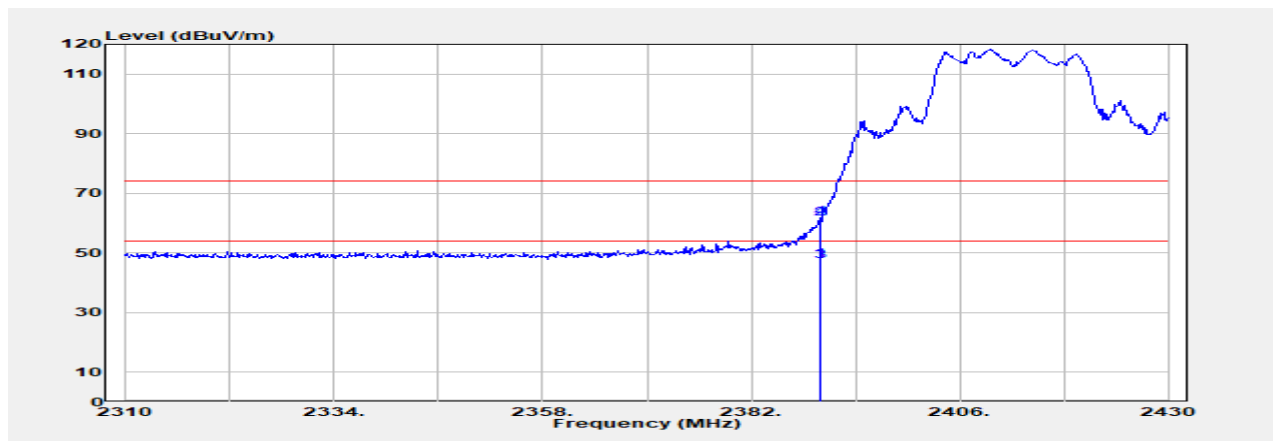

Freq. MHz	Detector Mode PK/QP/AVG	Spectrum Reading Level dB μ V	Factor dB	Actual FS dB μ V/m	Limit @3m dB μ V/m	Margin dB
2389.920	Average	50.98	-3.51	47.47	54.00	-6.53
2389.920	Peak	65.12	-3.51	61.62	74.00	-12.38
2390.000	Average	50.58	-3.51	47.07	54.00	-6.93
2390.000	Peak	65.42	-3.51	61.91	74.00	-12.09

Unless otherwise stated the results shown in this test report refer only to the sample(s) tested and such sample(s) are retained for 90 days only.
 除非另有說明，此報告結果僅對測試之樣品負責，同時此樣品僅保留90天。本報告未經本公司書面許可，不可部份複製。

This document is issued by the Company subject to its General Conditions of Service printed overleaf, available on request or accessible at <http://www.sgs.com.tw/Terms-and-Conditions> and for electronic format documents, subject to Terms and Conditions for Electronic Documents at <http://www.sgs.com.tw/Terms-and-Conditions>. Attention is drawn to the limitation of liability, indemnification and jurisdiction issues defined therein. Any holder of this document is advised that information contained hereon reflects the Company's findings at the time of its intervention only and within the limits of Client's instructions, if any. The Company's sole responsibility is to its Client and this document does not exonerate parties to a transaction from exercising all their rights and obligations under the transaction documents. This document cannot be reproduced except in full, without prior written approval of the Company. Any unauthorized alteration, forgery or falsification of the content or appearance of this document is unlawful and offenders may be prosecuted to the fullest extent of the law.

Report Number :TERF2308001922E2
 Operation Mode :802.11n20
 Test Frequency :2412 MHz
 Test Mode :Bandedge
 EUT Pol :E2 Plane

Test Site :SAC G Chamber
 Test Date :2023-08-22
 Temp./Humi. :25.1°C/57%
 Antenna Pol. :Horizontal
 Engineer :Temo Chen

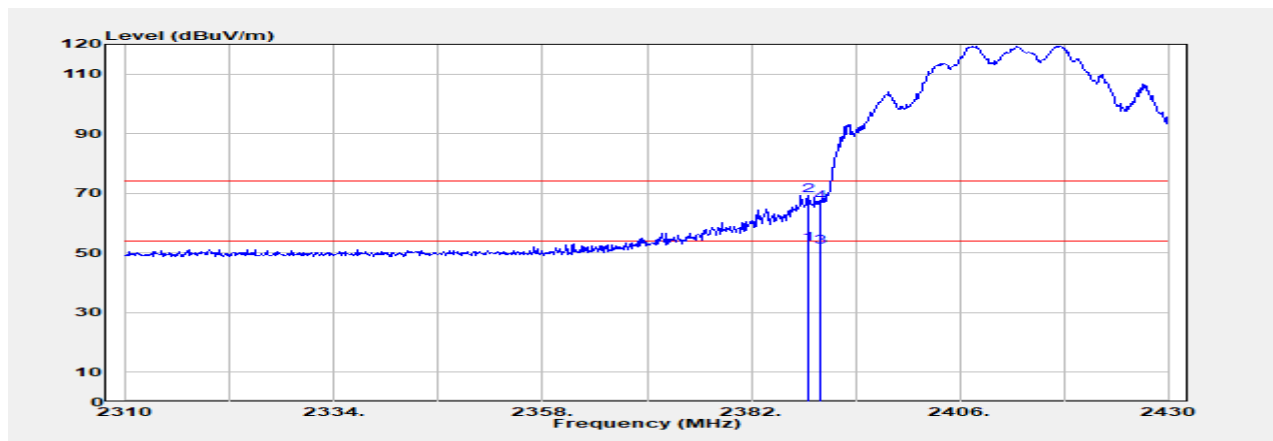

Freq. MHz	Detector Mode PK/QP/AVG	Spectrum Reading Level dB μ V	Factor dB	Actual FS dB μ V/m	Limit @3m dB μ V/m	Margin dB
2388.480	Average	56.54	-3.50	53.04	54.00	-0.96
2388.480	Peak	72.73	-3.50	69.23	74.00	-4.77
2390.000	Average	55.58	-3.51	52.07	54.00	-1.93
2390.000	Peak	70.55	-3.51	67.04	74.00	-6.96

Unless otherwise stated the results shown in this test report refer only to the sample(s) tested and such sample(s) are retained for 90 days only.

除非另有說明，此報告結果僅對測試之樣品負責，同時此樣品僅保留90天。本報告未經本公司書面許可，不可部份複製。

This document is issued by the Company subject to its General Conditions of Service printed overleaf, available on request or accessible at <http://www.sgs.com.tw/Terms-and-Conditions> and for electronic format documents, subject to Terms and Conditions for Electronic Documents at <http://www.sgs.com.tw/Terms-and-Conditions>. Attention is drawn to the limitation of liability, indemnification and jurisdiction issues defined therein. Any holder of this document is advised that information contained hereon reflects the Company's findings at the time of its intervention only and within the limits of Client's instructions, if any. The Company's sole responsibility is to its Client and this document does not exonerate parties to a transaction from exercising all their rights and obligations under the transaction documents. This document cannot be reproduced except in full, without prior written approval of the Company. Any unauthorized alteration, forgery or falsification of the content or appearance of this document is unlawful and offenders may be prosecuted to the fullest extent of the law.

Report Number :TERF2308001922E2
 Operation Mode :802.11n20
 Test Frequency :2462 MHz
 Test Mode :Bandedge
 EUT Pol :E2 Plane

Test Site :SAC G Chamber
 Test Date :2023-08-22
 Temp./Humi. :25.1°C/57%
 Antenna Pol. :Vertical
 Engineer :Temo Chen

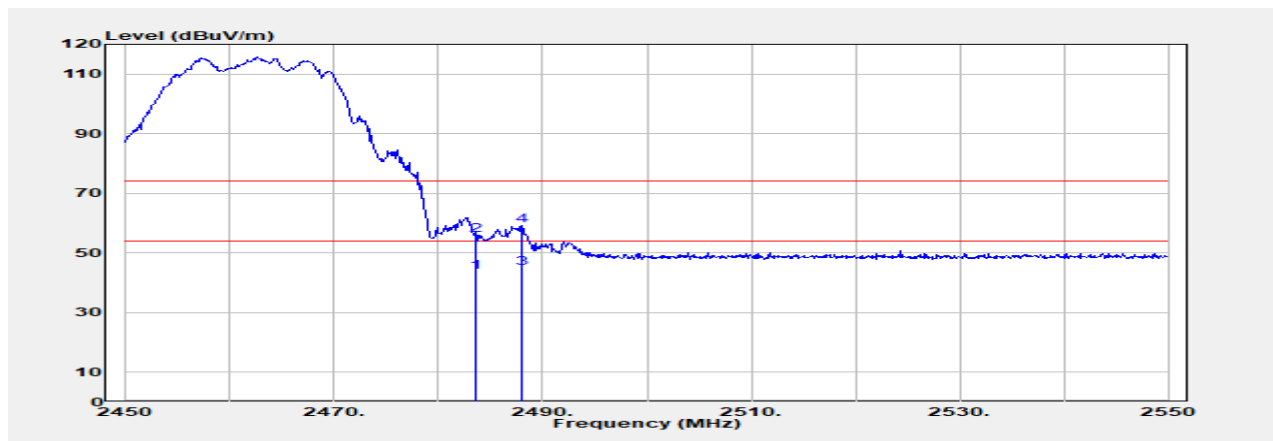

Freq. MHz	Detector Mode PK/QP/AVG	Spectrum Reading Level dBμV	Factor dB	Actual FS dBμV/m	Limit @3m dBμV/m	Margin dB
2483.500	Average	47.17	-3.54	43.63	54.00	-10.37
2483.500	Peak	59.55	-3.54	56.00	74.00	-18.00
2488.000	Average	48.54	-3.54	45.00	54.00	-9.00
2488.000	Peak	62.67	-3.54	59.13	74.00	-14.87

Unless otherwise stated the results shown in this test report refer only to the sample(s) tested and such sample(s) are retained for 90 days only.
 除非另有說明，此報告結果僅對測試之樣品負責，同時此樣品僅保留90天。本報告未經本公司書面許可，不可部份複製。

This document is issued by the Company subject to its General Conditions of Service printed overleaf, available on request or accessible at <http://www.sgs.com.tw/Terms-and-Conditions> and for electronic format documents, subject to Terms and Conditions for Electronic Documents at <http://www.sgs.com.tw/Terms-and-Conditions>. Attention is drawn to the limitation of liability, indemnification and jurisdiction issues defined therein. Any holder of this document is advised that information contained hereon reflects the Company's findings at the time of its intervention only and within the limits of Client's instructions, if any. The Company's sole responsibility is to its Client and this document does not exonerate parties to a transaction from exercising all their rights and obligations under the transaction documents. This document cannot be reproduced except in full, without prior written approval of the Company. Any unauthorized alteration, forgery or falsification of the content or appearance of this document is unlawful and offenders may be prosecuted to the fullest extent of the law.

Report Number	:TERF2308001922E2	Test Site	:SAC G Chamber
Operation Mode	:802.11n20	Test Date	:2023-08-22
Test Frequency	:2462 MHz	Temp./Humi.	:25.1°C/57%
Test Mode	:Bandedge	Antenna Pol.	:Horizontal
EUT Pol	:E2 Plane	Engineer	:Temo Chen

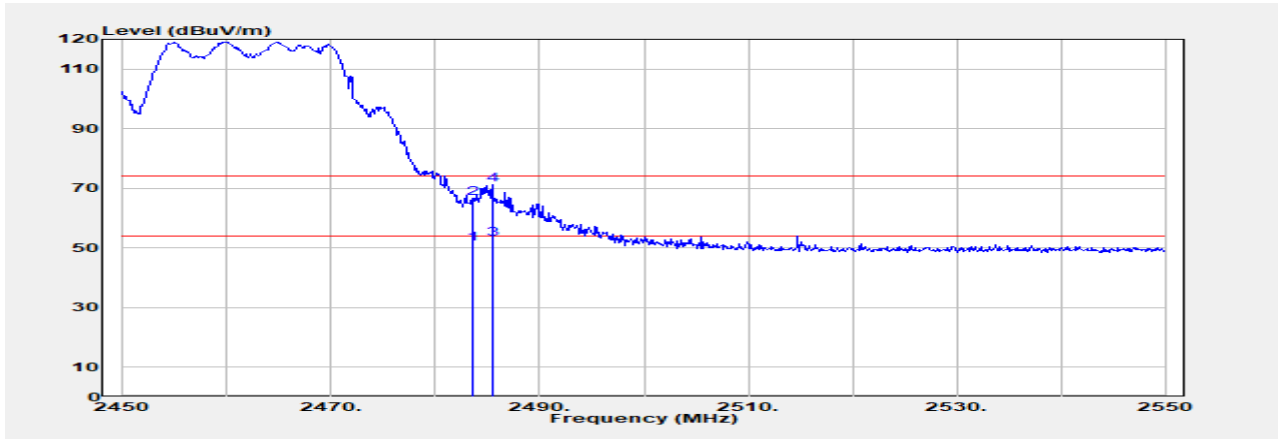

Freq. MHz	Detector Mode PK/QP/AVG	Spectrum Reading Level dBµV	Factor dB	Actual FS dBµV/m	Limit @3m dBµV/m	Margin dB
2483.500	Average	54.83	-3.54	51.28	54.00	-2.72
2483.500	Peak	70.20	-3.54	66.66	74.00	-7.34
2485.400	Average	56.43	-3.54	52.89	54.00	-1.11
2485.400	Peak	74.70	-3.54	71.16	74.00	-2.84

Unless otherwise stated the results shown in this test report refer only to the sample(s) tested and such sample(s) are retained for 90 days only.

除非另有說明，此報告結果僅對測試之樣品負責，同時此樣品僅保留90天。本報告未經本公司書面許可，不可部份複製。

This document is issued by the Company subject to its General Conditions of Service printed overleaf, available on request or accessible at <http://www.sgs.com.tw/Terms-and-Conditions> and for electronic format documents, subject to Terms and Conditions for Electronic Documents at <http://www.sgs.com.tw/Terms-and-Conditions>. Attention is drawn to the limitation of liability, indemnification and jurisdiction issues defined therein. Any holder of this document is advised that information contained hereon reflects the Company's findings at the time of its intervention only and within the limits of Client's instructions, if any. The Company's sole responsibility is to its Client and this document does not exonerate parties to a transaction from exercising all their rights and obligations under the transaction documents. This document cannot be reproduced except in full, without prior written approval of the Company. Any unauthorized alteration, forgery or falsification of the content or appearance of this document is unlawful and offenders may be prosecuted to the fullest extent of the law.

Report Number :TERF2308001922E2
 Operation Mode :802.11n40
 Test Frequency :2422 MHz
 Test Mode :Bandedge
 EUT Pol :E2 Plane

Test Site :SAC G Chamber
 Test Date :2023-08-22
 Temp./Humi. :25.1°C/57%
 Antenna Pol. :Vertical
 Engineer :Temo Chen

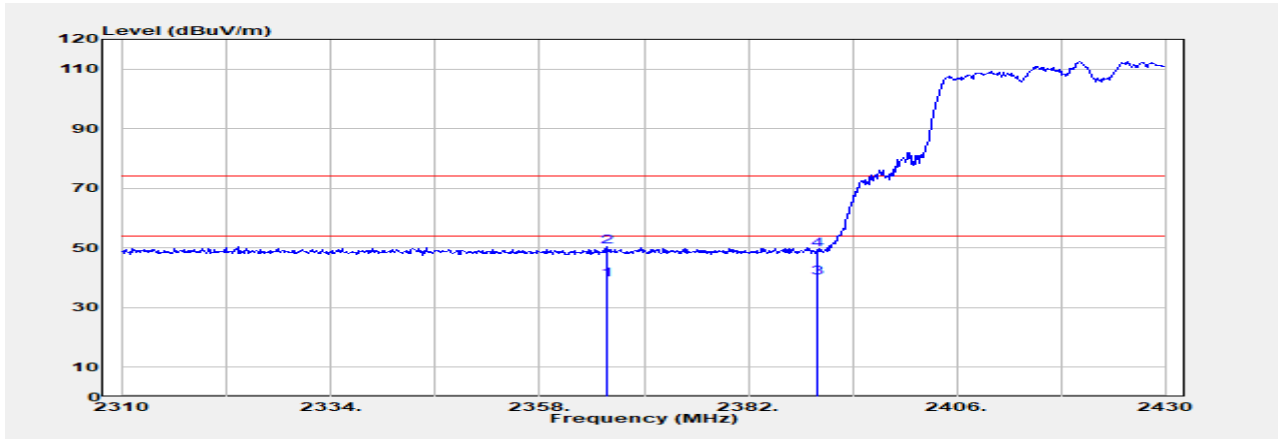

Freq. MHz	Detector Mode PK/QP/AVG	Spectrum Reading Level dBµV	Factor dB	Actual FS dBµV/m	Limit @3m dBµV/m	Margin dB
2365.680	Average	42.77	-3.39	39.38	54.00	-14.62
2365.680	Peak	53.81	-3.39	50.43	74.00	-23.57
2390.000	Average	43.35	-3.51	39.84	54.00	-14.16
2390.000	Peak	52.89	-3.51	49.38	74.00	-24.62

Unless otherwise stated the results shown in this test report refer only to the sample(s) tested and such sample(s) are retained for 90 days only.

除非另有說明，此報告結果僅對測試之樣品負責，同時此樣品僅保留90天。本報告未經本公司書面許可，不可部份複製。
 This document is issued by the Company subject to its General Conditions of Service printed overleaf, available on request or accessible at <http://www.sgs.com.tw/Terms-and-Conditions> and for electronic format documents, subject to Terms and Conditions for Electronic Documents at <http://www.sgs.com.tw/Terms-and-Conditions>. Attention is drawn to the limitation of liability, indemnification and jurisdiction issues defined therein. Any holder of this document is advised that information contained hereon reflects the Company's findings at the time of its intervention only and within the limits of Client's instructions, if any. The Company's sole responsibility is to its Client and this document does not exonerate parties to a transaction from exercising all their rights and obligations under the transaction documents. This document cannot be reproduced except in full, without prior written approval of the Company. Any unauthorized alteration, forgery or falsification of the content or appearance of this document is unlawful and offenders may be prosecuted to the fullest extent of the law.

Report Number	:TERF2308001922E2	Test Site	:SAC G Chamber
Operation Mode	:802.11n40	Test Date	:2023-08-22
Test Frequency	:2422 MHz	Temp./Humi.	:25.1°C/57%
Test Mode	:Bandedge	Antenna Pol.	:Horizontal
EUT Pol	:E2 Plane	Engineer	:Temo Chen

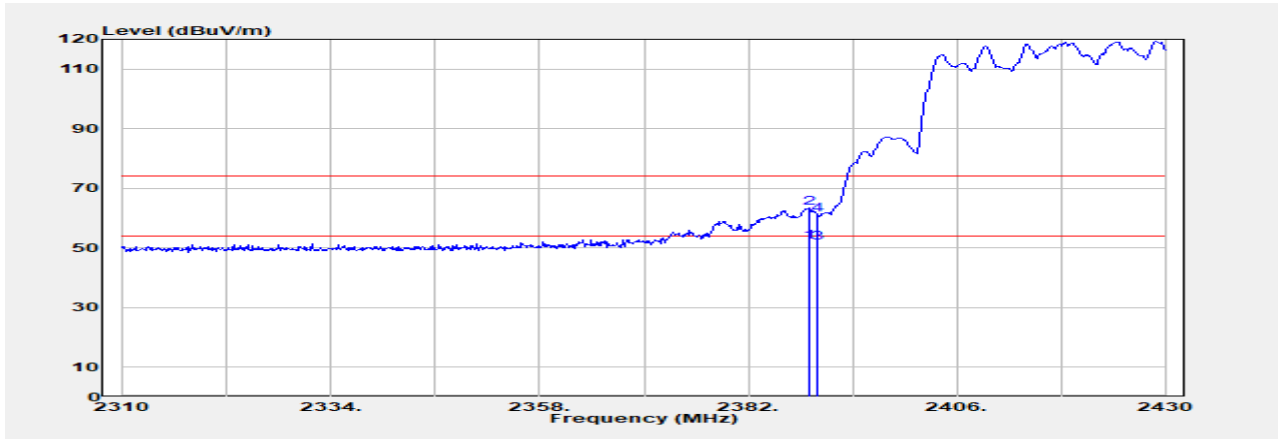

Freq. MHz	Detector Mode	Spectrum Reading Level dB μ V	Factor dB	Actual FS dB μ V/m	Limit @3m dB μ V/m	Margin dB
2388.960	Average	55.42	-3.50	51.92	54.00	-2.08
2388.960	Peak	66.77	-3.50	63.27	74.00	-10.73
2390.000	Average	55.18	-3.51	51.67	54.00	-2.33
2390.000	Peak	64.51	-3.51	61.00	74.00	-13.00

Unless otherwise stated the results shown in this test report refer only to the sample(s) tested and such sample(s) are retained for 90 days only.

除非另有說明，此報告結果僅對測試之樣品負責，同時此樣品僅保留90天。本報告未經本公司書面許可，不可部份複製。

This document is issued by the Company subject to its General Conditions of Service printed overleaf, available on request or accessible at <http://www.sgs.com.tw/Terms-and-Conditions> and for electronic format documents, subject to Terms and Conditions for Electronic Documents at <http://www.sgs.com.tw/Terms-and-Conditions>. Attention is drawn to the limitation of liability, indemnification and jurisdiction issues defined therein. Any holder of this document is advised that information contained hereon reflects the Company's findings at the time of its intervention only and within the limits of Client's instructions, if any. The Company's sole responsibility is to its Client and this document does not exonerate parties to a transaction from exercising all their rights and obligations under the transaction documents. This document cannot be reproduced except in full, without prior written approval of the Company. Any unauthorized alteration, forgery or falsification of the content or appearance of this document is unlawful and offenders may be prosecuted to the fullest extent of the law.

Report Number :TERF2308001922E2
 Operation Mode :802.11n40
 Test Frequency :2452 MHz
 Test Mode :Bandedge
 EUT Pol :E2 Plane

Test Site :SAC G Chamber
 Test Date :2023-08-21
 Temp./Humi. :25.1°C/57%
 Antenna Pol. :Vertical
 Engineer :Temo Chen

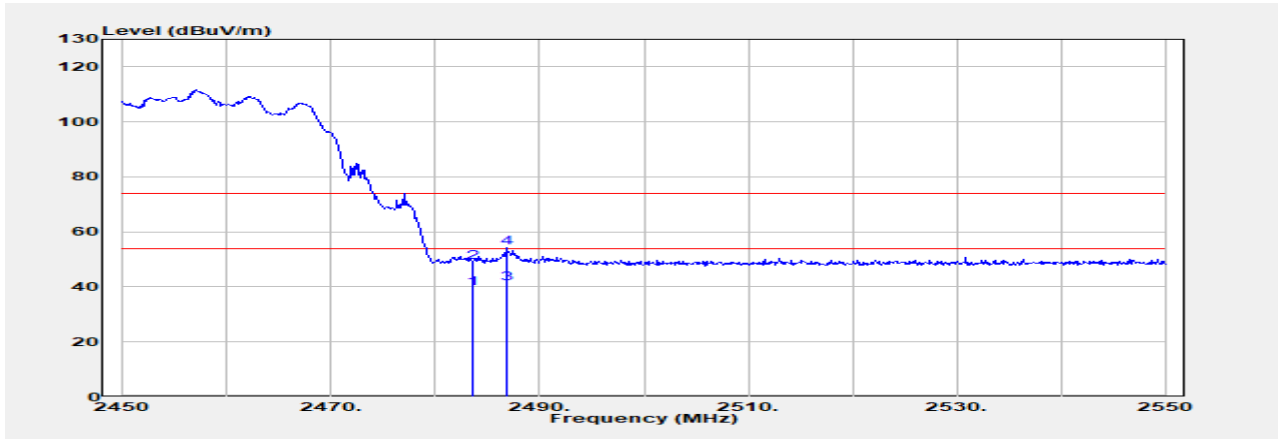

Freq. MHz	Detector Mode PK/QP/AVG	Spectrum Reading Level dBµV	Factor dB	Actual FS dBµV/m	Limit @3m dBµV/m	Margin dB
2483.500	Average	42.94	-3.54	39.39	54.00	-14.61
2483.500	Peak	52.46	-3.54	48.92	74.00	-25.08
2486.800	Average	44.74	-3.54	41.20	54.00	-12.80
2486.800	Peak	57.63	-3.54	54.09	74.00	-19.91

Unless otherwise stated the results shown in this test report refer only to the sample(s) tested and such sample(s) are retained for 90 days only.

除非另有說明，此報告結果僅對測試之樣品負責，同時此樣品僅保留90天。本報告未經本公司書面許可，不可部份複製。
 This document is issued by the Company subject to its General Conditions of Service printed overleaf, available on request or accessible at <http://www.sgs.com.tw/Terms-and-Conditions> and for electronic format documents, subject to Terms and Conditions for Electronic Documents at <http://www.sgs.com.tw/Terms-and-Conditions>. Attention is drawn to the limitation of liability, indemnification and jurisdiction issues defined therein. Any holder of this document is advised that information contained hereon reflects the Company's findings at the time of its intervention only and within the limits of Client's instructions, if any. The Company's sole responsibility is to its Client and this document does not exonerate parties to a transaction from exercising all their rights and obligations under the transaction documents. This document cannot be reproduced except in full, without prior written approval of the Company. Any unauthorized alteration, forgery or falsification of the content or appearance of this document is unlawful and offenders may be prosecuted to the fullest extent of the law.

Report Number :TERF2308001922E2
 Operation Mode :802.11n40
 Test Frequency :2452 MHz
 Test Mode :Bandedge
 EUT Pol :E2 Plane

Test Site :SAC G Chamber
 Test Date :2023-08-21
 Temp./Humi. :25.1°C/57%
 Antenna Pol. :Horizontal
 Engineer :Temo Chen

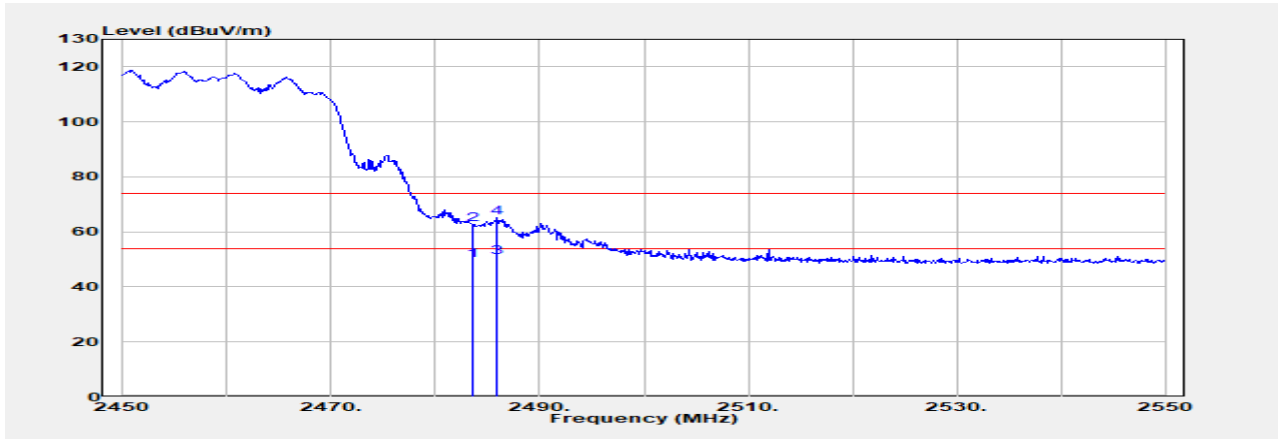

Freq. MHz	Detector Mode PK/QP/AVG	Spectrum Reading Level dBµV	Factor dB	Actual FS dBµV/m	Limit @3m dBµV/m	Margin dB
2483.500	Average	53.25	-3.54	49.71	54.00	-4.29
2483.500	Peak	66.25	-3.54	62.70	74.00	-11.30
2485.900	Average	54.40	-3.54	50.86	54.00	-3.14
2485.900	Peak	68.63	-3.54	65.09	74.00	-8.91

Unless otherwise stated the results shown in this test report refer only to the sample(s) tested and such sample(s) are retained for 90 days only.

除非另有說明，此報告結果僅對測試之樣品負責，同時此樣品僅保留90天。本報告未經本公司書面許可，不可部份複製。
 This document is issued by the Company subject to its General Conditions of Service printed overleaf, available on request or accessible at <http://www.sgs.com.tw/Terms-and-Conditions> and for electronic format documents, subject to Terms and Conditions for Electronic Documents at <http://www.sgs.com.tw/Terms-and-Conditions>. Attention is drawn to the limitation of liability, indemnification and jurisdiction issues defined therein. Any holder of this document is advised that information contained hereon reflects the Company's findings at the time of its intervention only and within the limits of Client's instructions, if any. The Company's sole responsibility is to its Client and this document does not exonerate parties to a transaction from exercising all their rights and obligations under the transaction documents. This document cannot be reproduced except in full, without prior written approval of the Company. Any unauthorized alteration, forgery or falsification of the content or appearance of this document is unlawful and offenders may be prosecuted to the fullest extent of the law.

Report Number :TERF2308001922E2
 Operation Mode :802.11be20
 Test Frequency :2412 MHz
 Test Mode :Bandedge
 EUT Pol :E2 Plane

Test Site :SAC G Chamber
 Test Date :2023-08-22
 Temp./Humi. :25.1°C/57%
 Antenna Pol. :Vertical
 Engineer :Temo Chen

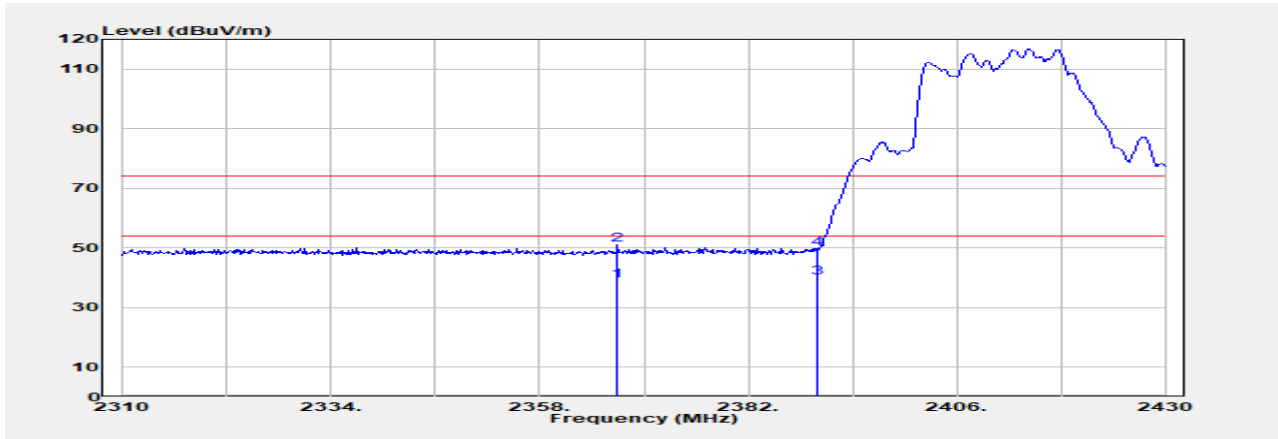

Freq. MHz	Detector Mode PK/QP/AVG	Spectrum Reading Level dBµV	Factor dB	Actual FS dBµV/m	Limit @3m dBµV/m	Margin dB
2367.000	Average	42.43	-3.39	39.04	54.00	-14.96
2367.000	Peak	54.57	-3.39	51.18	74.00	-22.82
2390.000	Average	43.49	-3.51	39.98	54.00	-14.02
2390.000	Peak	53.39	-3.51	49.88	74.00	-24.12

Unless otherwise stated the results shown in this test report refer only to the sample(s) tested and such sample(s) are retained for 90 days only.

除非另有說明，此報告結果僅對測試之樣品負責，同時此樣品僅保留90天。本報告未經本公司書面許可，不可部份複製。
 This document is issued by the Company subject to its General Conditions of Service printed overleaf, available on request or accessible at <http://www.sgs.com.tw/Terms-and-Conditions> and for electronic format documents, subject to Terms and Conditions for Electronic Documents at <http://www.sgs.com.tw/Terms-and-Conditions>. Attention is drawn to the limitation of liability, indemnification and jurisdiction issues defined therein. Any holder of this document is advised that information contained hereon reflects the Company's findings at the time of its intervention only and within the limits of Client's instructions, if any. The Company's sole responsibility is to its Client and this document does not exonerate parties to a transaction from exercising all their rights and obligations under the transaction documents. This document cannot be reproduced except in full, without prior written approval of the Company. Any unauthorized alteration, forgery or falsification of the content or appearance of this document is unlawful and offenders may be prosecuted to the fullest extent of the law.

Report Number :TERF2308001922E2
 Operation Mode :802.11be20
 Test Frequency :2412 MHz
 Test Mode :Bandedge
 EUT Pol :E2 Plane

Test Site :SAC G Chamber
 Test Date :2023-08-22
 Temp./Humi. :25.1°C/57%
 Antenna Pol. :Horizontal
 Engineer :Temo Chen

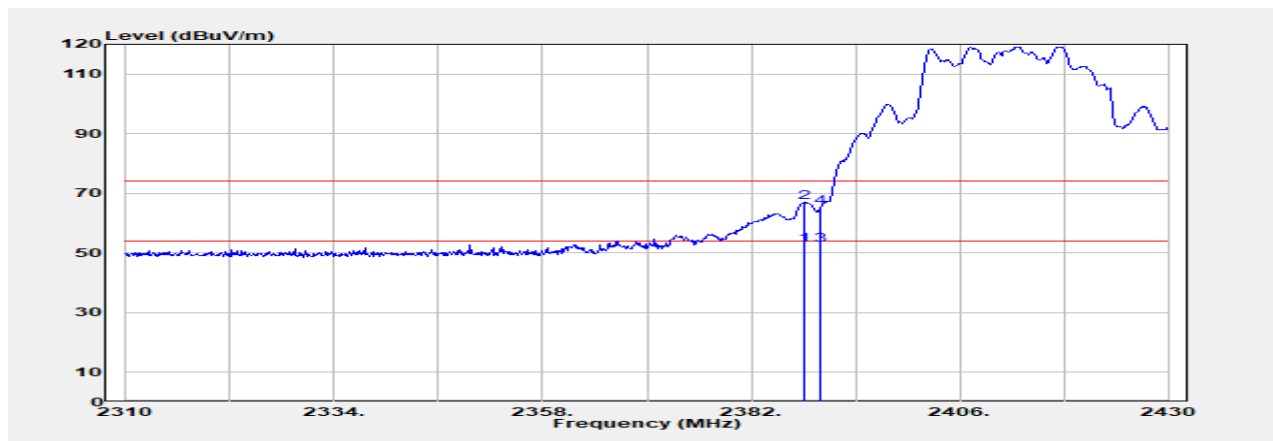

Freq. MHz	Detector Mode PK/QP/AVG	Spectrum Reading Level dB μ V	Factor dB	Actual FS dB μ V/m	Limit @3m dB μ V/m	Margin dB
2388.120	Average	56.21	-3.50	52.71	54.00	-1.29
2388.120	Peak	70.40	-3.50	66.90	74.00	-7.10
2390.000	Average	56.20	-3.51	52.69	54.00	-1.31
2390.000	Peak	68.73	-3.51	65.22	74.00	-8.78

Unless otherwise stated the results shown in this test report refer only to the sample(s) tested and such sample(s) are retained for 90 days only.

除非另有說明，此報告結果僅對測試之樣品負責，同時此樣品僅保留90天。本報告未經本公司書面許可，不可部份複製。
 This document is issued by the Company subject to its General Conditions of Service printed overleaf, available on request or accessible at <http://www.sgs.com.tw/Terms-and-Conditions> and for electronic format documents, subject to Terms and Conditions for Electronic Documents at <http://www.sgs.com.tw/Terms-and-Conditions>. Attention is drawn to the limitation of liability, indemnification and jurisdiction issues defined therein. Any holder of this document is advised that information contained hereon reflects the Company's findings at the time of its intervention only and within the limits of Client's instructions, if any. The Company's sole responsibility is to its Client and this document does not exonerate parties to a transaction from exercising all their rights and obligations under the transaction documents. This document cannot be reproduced except in full, without prior written approval of the Company. Any unauthorized alteration, forgery or falsification of the content or appearance of this document is unlawful and offenders may be prosecuted to the fullest extent of the law.

Report Number :TERF2308001922E2
 Operation Mode :802.11be20
 Test Frequency :2462 MHz
 Test Mode :Bandedge
 EUT Pol :E2 Plane

Test Site :SAC G Chamber
 Test Date :2023-08-22
 Temp./Humi. :25.1°C/57%
 Antenna Pol. :Vertical
 Engineer :Temo Chen

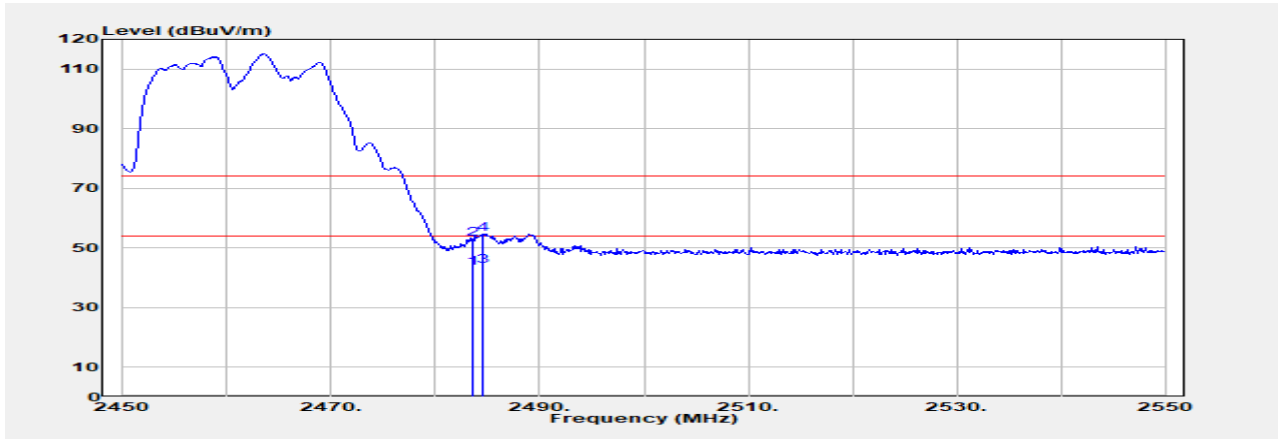

Freq. MHz	Detector Mode PK/QP/AVG	Spectrum Reading Level dB μ V	Factor dB	Actual FS dB μ V/m	Limit @3m dB μ V/m	Margin dB
2483.500	Average	46.89	-3.54	43.35	54.00	-10.65
2483.500	Peak	56.68	-3.54	53.13	74.00	-20.87
2484.500	Average	47.43	-3.54	43.89	54.00	-10.11
2484.500	Peak	58.28	-3.54	54.74	74.00	-19.26

Unless otherwise stated the results shown in this test report refer only to the sample(s) tested and such sample(s) are retained for 90 days only.

除非另有說明，此報告結果僅對測試之樣品負責，同時此樣品僅保留90天。本報告未經本公司書面許可，不可部份複製。
 This document is issued by the Company subject to its General Conditions of Service printed overleaf, available on request or accessible at <http://www.sgs.com.tw/Terms-and-Conditions> and for electronic format documents, subject to Terms and Conditions for Electronic Documents at <http://www.sgs.com.tw/Terms-and-Conditions>. Attention is drawn to the limitation of liability, indemnification and jurisdiction issues defined therein. Any holder of this document is advised that information contained hereon reflects the Company's findings at the time of its intervention only and within the limits of Client's instructions, if any. The Company's sole responsibility is to its Client and this document does not exonerate parties to a transaction from exercising all their rights and obligations under the transaction documents. This document cannot be reproduced except in full, without prior written approval of the Company. Any unauthorized alteration, forgery or falsification of the content or appearance of this document is unlawful and offenders may be prosecuted to the fullest extent of the law.

Report Number :TERF2308001922E2
 Operation Mode :802.11be20
 Test Frequency :2462 MHz
 Test Mode :Bandedge
 EUT Pol :E2 Plane

Test Site :SAC G Chamber
 Test Date :2023-08-22
 Temp./Humi. :25.1°C/57%
 Antenna Pol. :Horizontal
 Engineer :Temo Chen

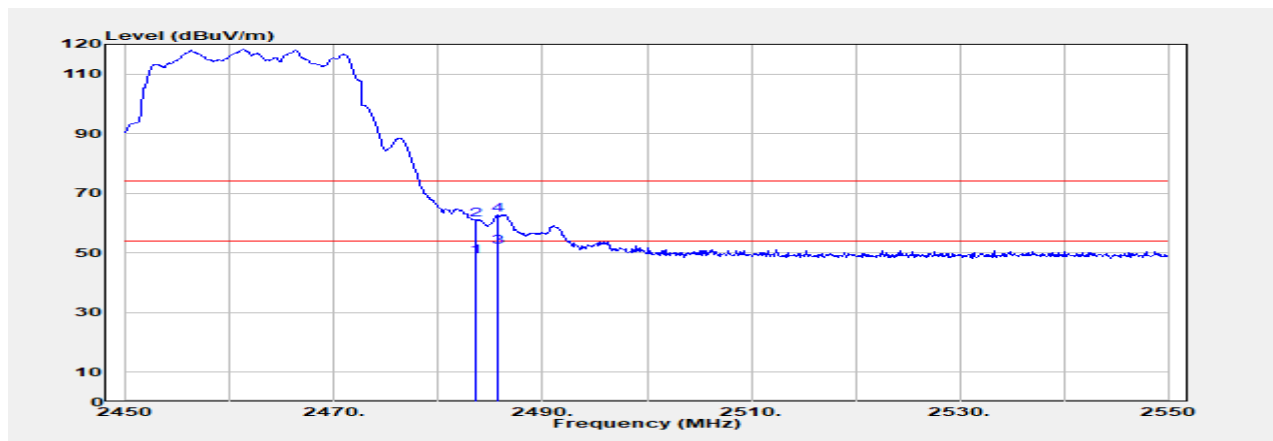

Freq. MHz	Detector Mode PK/QP/AVG	Spectrum Reading Level dBµV	Factor dB	Actual FS dBUV/m	Limit @3m dBUV/m	Margin dB
2483.500	Average	52.42	-3.54	48.87	54.00	-5.13
2483.500	Peak	64.55	-3.54	61.01	74.00	-12.99
2485.600	Average	55.66	-3.54	52.12	54.00	-1.88
2485.600	Peak	66.44	-3.54	62.90	74.00	-11.10

Unless otherwise stated the results shown in this test report refer only to the sample(s) tested and such sample(s) are retained for 90 days only.

除非另有說明，此報告結果僅對測試之樣品負責，同時此樣品僅保留90天。本報告未經本公司書面許可，不可部份複製。

This document is issued by the Company subject to its General Conditions of Service printed overleaf, available on request or accessible at <http://www.sgs.com.tw/Terms-and-Conditions> and for electronic format documents, subject to Terms and Conditions for Electronic Documents at <http://www.sgs.com.tw/Terms-and-Conditions>. Attention is drawn to the limitation of liability, indemnification and jurisdiction issues defined therein. Any holder of this document is advised that information contained hereon reflects the Company's findings at the time of its intervention only and within the limits of Client's instructions, if any. The Company's sole responsibility is to its Client and this document does not exonerate parties to a transaction from exercising all their rights and obligations under the transaction documents. This document cannot be reproduced except in full, without prior written approval of the Company. Any unauthorized alteration, forgery or falsification of the content or appearance of this document is unlawful and offenders may be prosecuted to the fullest extent of the law.

Report Number :TERF2308001922E2
 Operation Mode :802.11be40
 Test Frequency :2422 MHz
 Test Mode :Bandedge
 EUT Pol :E2 Plane

Test Site :SAC G Chamber
 Test Date :2023-08-22
 Temp./Humi. :25.1°C/57%
 Antenna Pol. :Vertical
 Engineer :Temo Chen

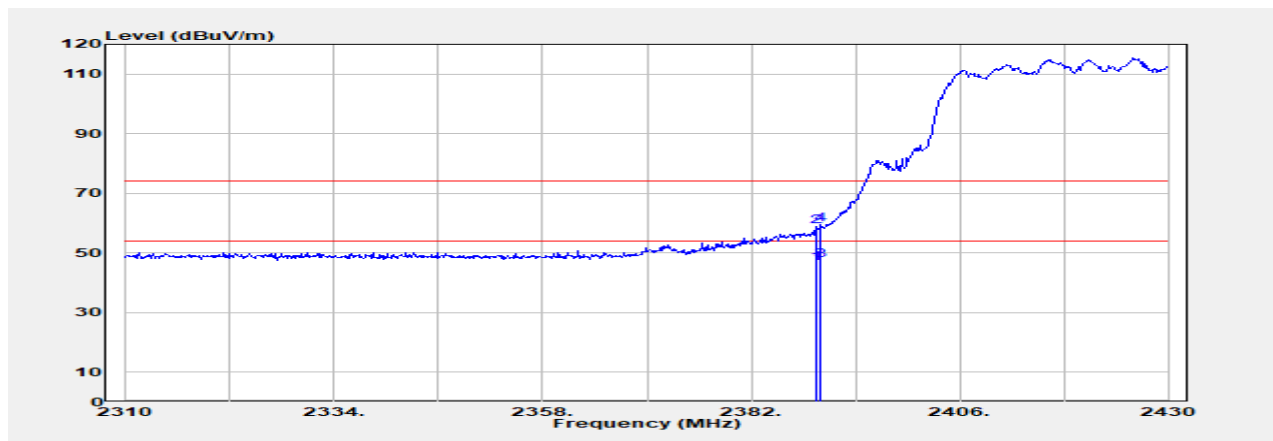

Freq. MHz	Detector Mode PK/QP/AVG	Spectrum Reading Level dB μ V	Factor dB	Actual FS dB μ V/m	Limit @3m dB μ V/m	Margin dB
2389.560	Average	50.06	-3.51	46.56	54.00	-7.44
2389.560	Peak	62.48	-3.51	58.98	74.00	-15.02
2390.000	Average	50.86	-3.51	47.35	54.00	-6.65
2390.000	Peak	63.04	-3.51	59.53	74.00	-14.47

Unless otherwise stated the results shown in this test report refer only to the sample(s) tested and such sample(s) are retained for 90 days only.

除非另有說明，此報告結果僅對測試之樣品負責，同時此樣品僅保留90天。本報告未經本公司書面許可，不可部份複製。
 This document is issued by the Company subject to its General Conditions of Service printed overleaf, available on request or accessible at <http://www.sgs.com.tw/Terms-and-Conditions> and for electronic format documents, subject to Terms and Conditions for Electronic Documents at <http://www.sgs.com.tw/Terms-and-Conditions>. Attention is drawn to the limitation of liability, indemnification and jurisdiction issues defined therein. Any holder of this document is advised that information contained hereon reflects the Company's findings at the time of its intervention only and within the limits of Client's instructions, if any. The Company's sole responsibility is to its Client and this document does not exonerate parties to a transaction from exercising all their rights and obligations under the transaction documents. This document cannot be reproduced except in full, without prior written approval of the Company. Any unauthorized alteration, forgery or falsification of the content or appearance of this document is unlawful and offenders may be prosecuted to the fullest extent of the law.

Report Number :TERF2308001922E2
 Operation Mode :802.11be40
 Test Frequency :2422 MHz
 Test Mode :Bandedge
 EUT Pol :E2 Plane

Test Site :SAC G Chamber
 Test Date :2023-08-22
 Temp./Humi. :25.1°C/57%
 Antenna Pol. :Horizontal
 Engineer :Temo Chen

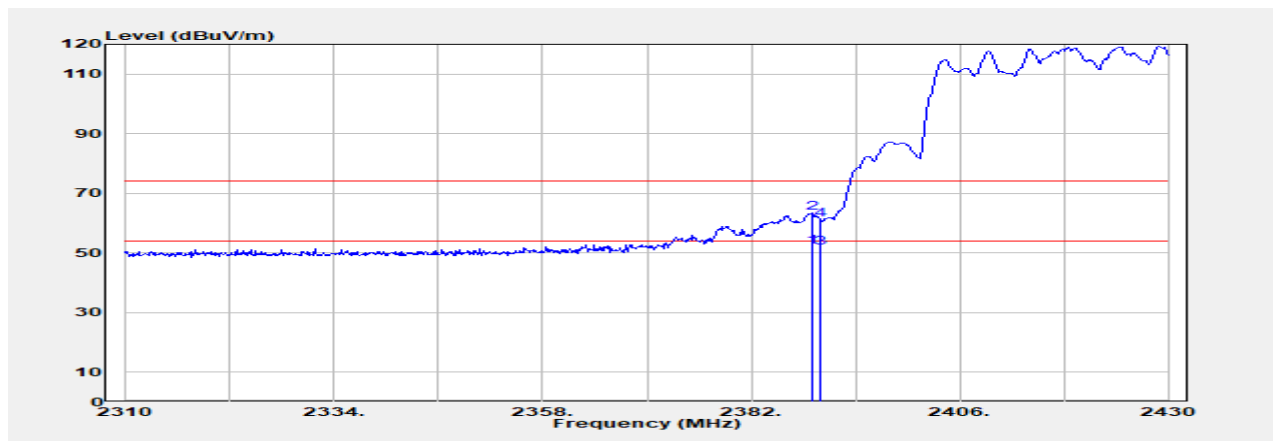

Freq. MHz	Detector Mode PK/QP/AVG	Spectrum Reading Level dB μ V	Factor dB	Actual FS dB μ V/m	Limit @3m dB μ V/m	Margin dB
2388.960	Average	55.42	-3.50	51.92	54.00	-2.08
2388.960	Peak	66.77	-3.50	63.27	74.00	-10.73
2390.000	Average	55.18	-3.51	51.67	54.00	-2.33
2390.000	Peak	64.51	-3.51	61.00	74.00	-13.00

Unless otherwise stated the results shown in this test report refer only to the sample(s) tested and such sample(s) are retained for 90 days only.
 除非另有說明，此報告結果僅對測試之樣品負責，同時此樣品僅保留90天。本報告未經本公司書面許可，不可部份複製。

This document is issued by the Company subject to its General Conditions of Service printed overleaf, available on request or accessible at <http://www.sgs.com.tw/Terms-and-Conditions> and for electronic format documents, subject to Terms and Conditions for Electronic Documents at <http://www.sgs.com.tw/Terms-and-Conditions>. Attention is drawn to the limitation of liability, indemnification and jurisdiction issues defined therein. Any holder of this document is advised that information contained hereon reflects the Company's findings at the time of its intervention only and within the limits of Client's instructions, if any. The Company's sole responsibility is to its Client and this document does not exonerate parties to a transaction from exercising all their rights and obligations under the transaction documents. This document cannot be reproduced except in full, without prior written approval of the Company. Any unauthorized alteration, forgery or falsification of the content or appearance of this document is unlawful and offenders may be prosecuted to the fullest extent of the law.

Report Number :TERF2308001922E2
 Operation Mode :802.11be40
 Test Frequency :2452 MHz
 Test Mode :Bandedge
 EUT Pol :E2 Plane

Test Site :SAC G Chamber
 Test Date :2023-08-22
 Temp./Humi. :25.1°C/57%
 Antenna Pol. :Vertical
 Engineer :Temo Chen

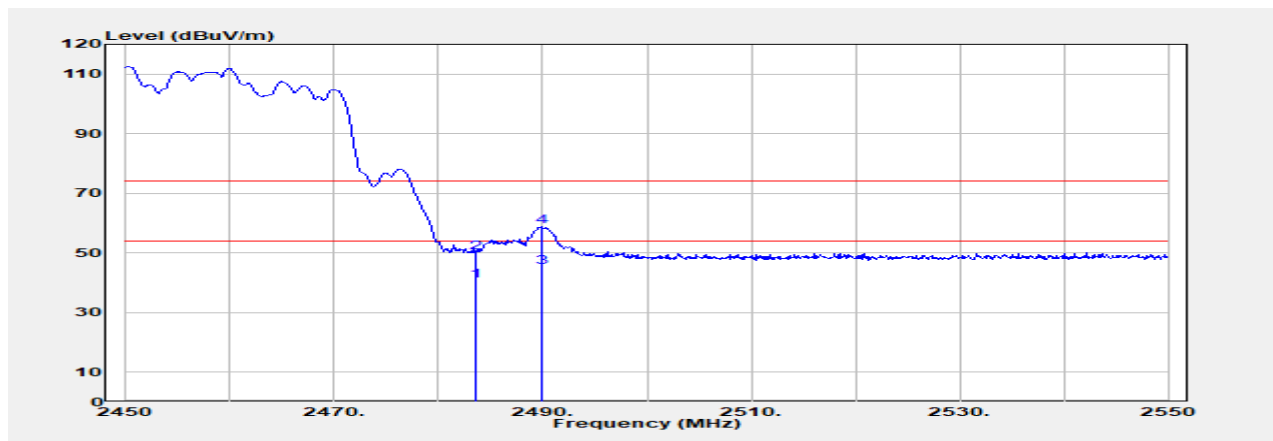

Freq. MHz	Detector Mode PK/QP/AVG	Spectrum Reading Level dB μ V	Factor dB	Actual FS dB μ V/m	Limit @3m dB μ V/m	Margin dB
2483.500	Average	44.20	-3.54	40.65	54.00	-13.35
2483.500	Peak	53.78	-3.54	50.24	74.00	-23.76
2489.900	Average	48.75	-3.53	45.22	54.00	-8.78
2489.900	Peak	62.43	-3.53	58.89	74.00	-15.11

Unless otherwise stated the results shown in this test report refer only to the sample(s) tested and such sample(s) are retained for 90 days only.
 除非另有說明，此報告結果僅對測試之樣品負責，同時此樣品僅保留90天。本報告未經本公司書面許可，不可部份複製。

This document is issued by the Company subject to its General Conditions of Service printed overleaf, available on request or accessible at <http://www.sgs.com.tw/Terms-and-Conditions> and for electronic format documents, subject to Terms and Conditions for Electronic Documents at <http://www.sgs.com.tw/Terms-and-Conditions>. Attention is drawn to the limitation of liability, indemnification and jurisdiction issues defined therein. Any holder of this document is advised that information contained hereon reflects the Company's findings at the time of its intervention only and within the limits of Client's instructions, if any. The Company's sole responsibility is to its Client and this document does not exonerate parties to a transaction from exercising all their rights and obligations under the transaction documents. This document cannot be reproduced except in full, without prior written approval of the Company. Any unauthorized alteration, forgery or falsification of the content or appearance of this document is unlawful and offenders may be prosecuted to the fullest extent of the law.

Report Number :TERF2308001922E2
 Operation Mode :802.11be40
 Test Frequency :2452 MHz
 Test Mode :Bandedge
 EUT Pol :E2 Plane

Test Site :SAC G Chamber
 Test Date :2023-08-22
 Temp./Humi. :25.1°C/57%
 Antenna Pol. :Horizontal
 Engineer :Temo Chen

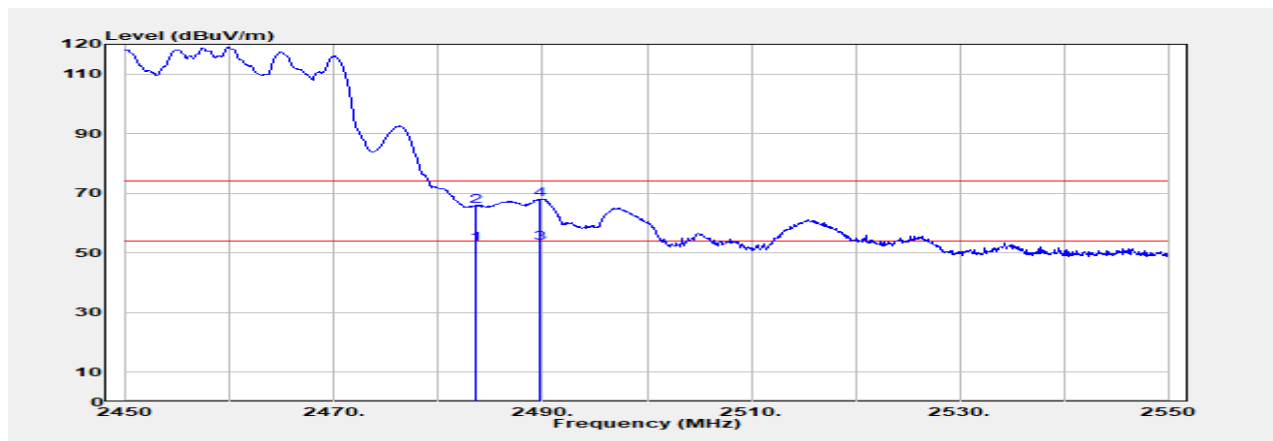

Freq. MHz	Detector Mode PK/QP/AVG	Spectrum Reading Level dBμV	Factor dB	Actual FS dBμV/m	Limit @3m dBμV/m	Margin dB
2483.500	Average	56.44	-3.54	52.89	54.00	-1.11
2483.500	Peak	69.20	-3.54	65.65	74.00	-8.35
2489.700	Average	57.03	-3.53	53.50	54.00	-0.50
2489.700	Peak	71.59	-3.53	68.06	74.00	-5.94

Unless otherwise stated the results shown in this test report refer only to the sample(s) tested and such sample(s) are retained for 90 days only.

除非另有說明，此報告結果僅對測試之樣品負責，同時此樣品僅保留90天。本報告未經本公司書面許可，不可部份複製。
 This document is issued by the Company subject to its General Conditions of Service printed overleaf, available on request or accessible at <http://www.sgs.com.tw/Terms-and-Conditions> and for electronic format documents, subject to Terms and Conditions for Electronic Documents at <http://www.sgs.com.tw/Terms-and-Conditions>. Attention is drawn to the limitation of liability, indemnification and jurisdiction issues defined therein. Any holder of this document is advised that information contained hereon reflects the Company's findings at the time of its intervention only and within the limits of Client's instructions, if any. The Company's sole responsibility is to its Client and this document does not exonerate parties to a transaction from exercising all their rights and obligations under the transaction documents. This document cannot be reproduced except in full, without prior written approval of the Company. Any unauthorized alteration, forgery or falsification of the content or appearance of this document is unlawful and offenders may be prosecuted to the fullest extent of the law.

Mode: Beamforming

Report Number	:TERF2308001922E2	Test Site	:SAC G Chamber
Operation Mode	:802.11n20	Test Date	:2023-09-15
Test Frequency	:2412 MHz	Temp./Humi.	:23.1°C/59%
Test Mode	:Bandedge	Antenna Pol.	:Vertical
EUT Pol	:E2 Plane	Engineer	:Temo Chen

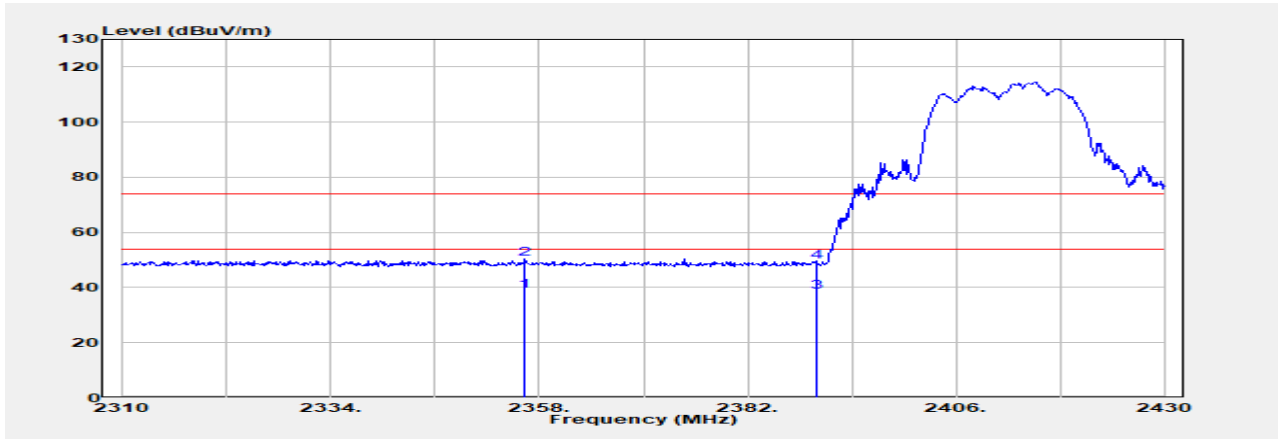

Freq. MHz	Detector Mode PK/QP/AVG	Spectrum Reading Level dBuV	Factor dB	Actual FS dBuV/m	Limit @3m dBuV/m	Margin dB
2356.320	Average	41.93	-3.34	38.59	54.00	-15.41
2356.320	Peak	53.68	-3.34	50.34	74.00	-23.66
2390.000	Average	42.06	-3.51	38.55	54.00	-15.45
2390.000	Peak	52.72	-3.51	49.21	74.00	-24.79

Unless otherwise stated the results shown in this test report refer only to the sample(s) tested and such sample(s) are retained for 90 days only.

除非另有說明，此報告結果僅對測試之樣品負責，同時此樣品僅保留90天。本報告未經本公司書面許可，不可部份複製。

This document is issued by the Company subject to its General Conditions of Service printed overleaf, available on request or accessible at <http://www.sgs.com.tw/Terms-and-Conditions> and for electronic format documents, subject to Terms and Conditions for Electronic Documents at <http://www.sgs.com.tw/Terms-and-Conditions>. Attention is drawn to the limitation of liability, indemnification and jurisdiction issues defined therein. Any holder of this document is advised that information contained hereon reflects the Company's findings at the time of its intervention only and within the limits of Client's instructions, if any. The Company's sole responsibility is to its Client and this document does not exonerate parties to a transaction from exercising all their rights and obligations under the transaction documents. This document cannot be reproduced except in full, without prior written approval of the Company. Any unauthorized alteration, forgery or falsification of the content or appearance of this document is unlawful and offenders may be prosecuted to the fullest extent of the law.

Report Number	:TERF2308001922E2	Test Site	:SAC G Chamber
Operation Mode	:802.11n20	Test Date	:2023-09-15
Test Frequency	:2412 MHz	Temp./Humi.	:23.1°C/59%
Test Mode	:Bandedge	Antenna Pol.	:Horizontal
EUT Pol	:E2 Plane	Engineer	:Temo Chen

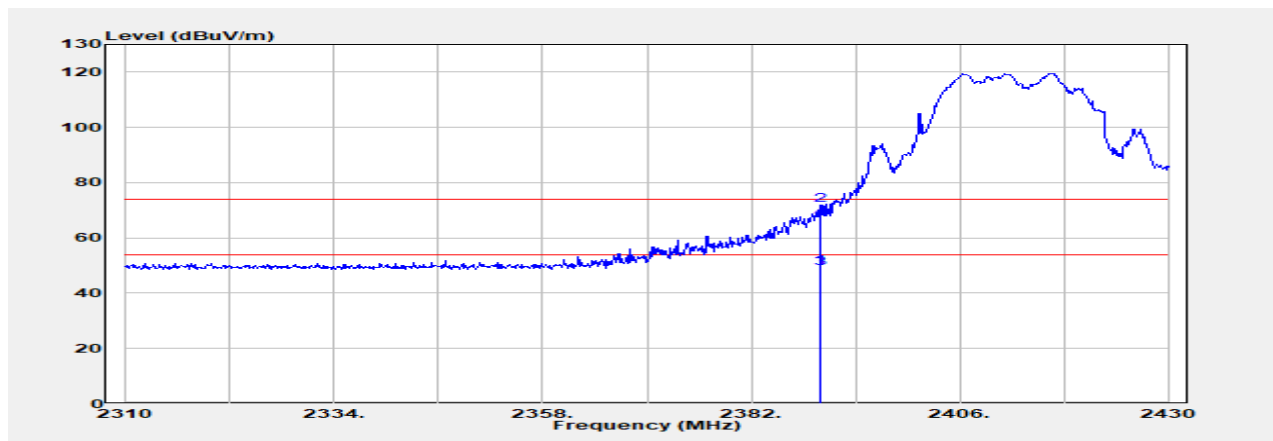

Freq. MHz	Detector Mode PK/QP/AVG	Spectrum Reading Level dBuV	Factor dB	Actual FS dBuV/m	Limit @3m dBuV/m	Margin dB
2389.920	Average	52.72	-3.51	49.21	54.00	-4.79
2389.920	Peak	75.31	-3.51	71.80	74.00	-2.20
2390.000	Average	52.32	-3.51	48.81	54.00	-5.19
2390.000	Peak	70.42	-3.51	66.91	74.00	-7.09

Unless otherwise stated the results shown in this test report refer only to the sample(s) tested and such sample(s) are retained for 90 days only.
 除非另有說明，此報告結果僅對測試之樣品負責，同時此樣品僅保留90天。本報告未經本公司書面許可，不可部份複製。

This document is issued by the Company subject to its General Conditions of Service printed overleaf, available on request or accessible at <http://www.sgs.com.tw/Terms-and-Conditions> and for electronic format documents, subject to Terms and Conditions for Electronic Documents at <http://www.sgs.com.tw/Terms-and-Conditions>. Attention is drawn to the limitation of liability, indemnification and jurisdiction issues defined therein. Any holder of this document is advised that information contained hereon reflects the Company's findings at the time of its intervention only and within the limits of Client's instructions, if any. The Company's sole responsibility is to its Client and this document does not exonerate parties to a transaction from exercising all their rights and obligations under the transaction documents. This document cannot be reproduced except in full, without prior written approval of the Company. Any unauthorized alteration, forgery or falsification of the content or appearance of this document is unlawful and offenders may be prosecuted to the fullest extent of the law.

Report Number	:TERF2308001922E2	Test Site	:SAC G Chamber
Operation Mode	:802.11n20	Test Date	:2023-09-15
Test Frequency	:2462 MHz	Temp./Humi.	:23.1°C/59%
Test Mode	:Bandedge	Antenna Pol.	:Vertical
EUT Pol	:E2 Plane	Engineer	:Temo Chen

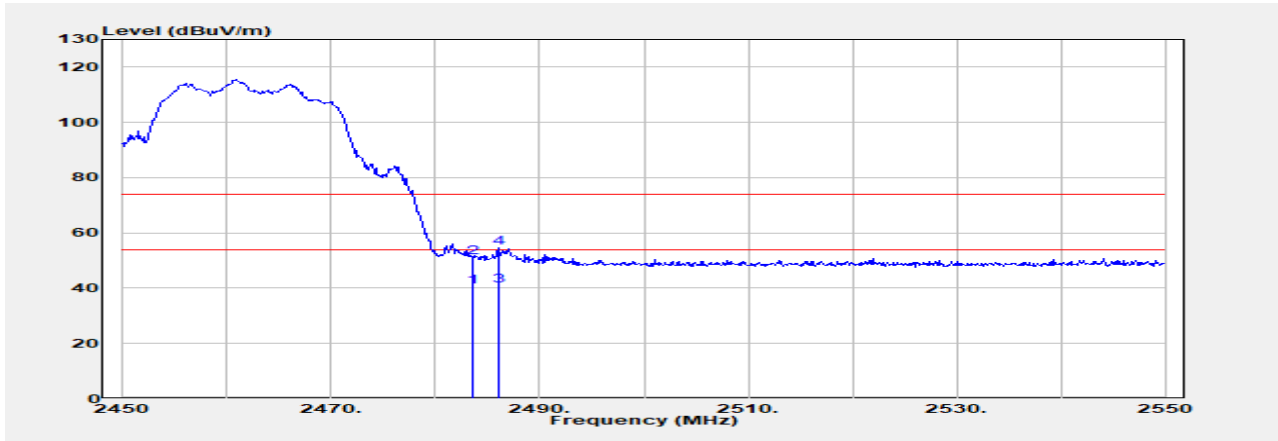

Freq. MHz	Detector Mode PK/QP/AVG	Spectrum Reading Level dBuV	Factor dB	Actual FS dBuV/m	Limit @3m dBuV/m	Margin dB
2483.500	Average	44.09	-3.54	40.55	54.00	-13.45
2483.500	Peak	54.67	-3.54	51.13	74.00	-22.87
2486.000	Average	44.56	-3.54	41.03	54.00	-12.97
2486.000	Peak	58.18	-3.54	54.65	74.00	-19.35

Unless otherwise stated the results shown in this test report refer only to the sample(s) tested and such sample(s) are retained for 90 days only.

除非另有說明，此報告結果僅對測試之樣品負責，同時此樣品僅保留90天。本報告未經本公司書面許可，不可部份複製。

This document is issued by the Company subject to its General Conditions of Service printed overleaf, available on request or accessible at <http://www.sgs.com.tw/Terms-and-Conditions> and for electronic format documents, subject to Terms and Conditions for Electronic Documents at <http://www.sgs.com.tw/Terms-and-Conditions>. Attention is drawn to the limitation of liability, indemnification and jurisdiction issues defined therein. Any holder of this document is advised that information contained hereon reflects the Company's findings at the time of its intervention only and within the limits of Client's instructions, if any. The Company's sole responsibility is to its Client and this document does not exonerate parties to a transaction from exercising all their rights and obligations under the transaction documents. This document cannot be reproduced except in full, without prior written approval of the Company. Any unauthorized alteration, forgery or falsification of the content or appearance of this document is unlawful and offenders may be prosecuted to the fullest extent of the law.

Report Number	:TERF2308001922E2	Test Site	:SAC G Chamber
Operation Mode	:802.11n20	Test Date	:2023-09-15
Test Frequency	:2462 MHz	Temp./Humi.	:23.1°C/59%
Test Mode	:Bandedge	Antenna Pol.	:Horizontal
EUT Pol	:E2 Plane	Engineer	:Temo Chen

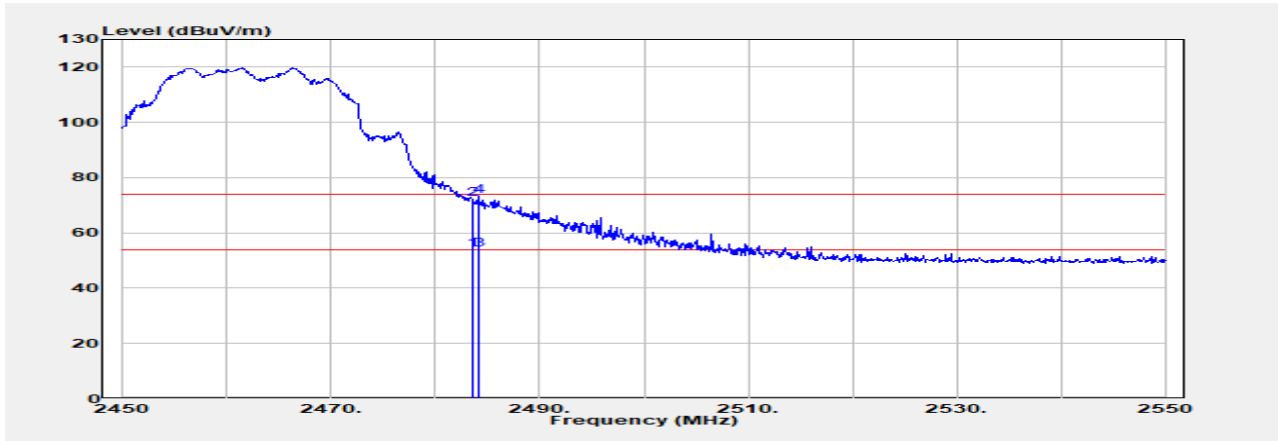

Freq. MHz	Detector Mode PK/QP/AVG	Spectrum Reading Level dBuV	Factor dB	Actual FS dBuV/m	Limit @3m dBuV/m	Margin dB
2483.500	Average	57.34	-3.54	53.80	54.00	-0.20
2483.500	Peak	75.92	-3.54	72.38	74.00	-1.62
2484.100	Average	57.32	-3.54	53.77	54.00	-0.23
2484.100	Peak	76.76	-3.54	73.22	74.00	-0.78

Unless otherwise stated the results shown in this test report refer only to the sample(s) tested and such sample(s) are retained for 90 days only.

除非另有說明，此報告結果僅對測試之樣品負責，同時此樣品僅保留90天。本報告未經本公司書面許可，不可部份複製。

This document is issued by the Company subject to its General Conditions of Service printed overleaf, available on request or accessible at <http://www.sgs.com.tw/Terms-and-Conditions> and for electronic format documents, subject to Terms and Conditions for Electronic Documents at <http://www.sgs.com.tw/Terms-and-Conditions>. Attention is drawn to the limitation of liability, indemnification and jurisdiction issues defined therein. Any holder of this document is advised that information contained hereon reflects the Company's findings at the time of its intervention only and within the limits of Client's instructions, if any. The Company's sole responsibility is to its Client and this document does not exonerate parties to a transaction from exercising all their rights and obligations under the transaction documents. This document cannot be reproduced except in full, without prior written approval of the Company. Any unauthorized alteration, forgery or falsification of the content or appearance of this document is unlawful and offenders may be prosecuted to the fullest extent of the law.

Report Number :TERF2308001922E2
 Operation Mode :802.11n40
 Test Frequency :2422 MHz
 Test Mode :Bandedge
 EUT Pol :E2 Plane

Test Site :SAC G Chamber
 Test Date :2023-09-15
 Temp./Humi. :24.5°C/67%
 Antenna Pol. :Vertical
 Engineer :Temo Chen

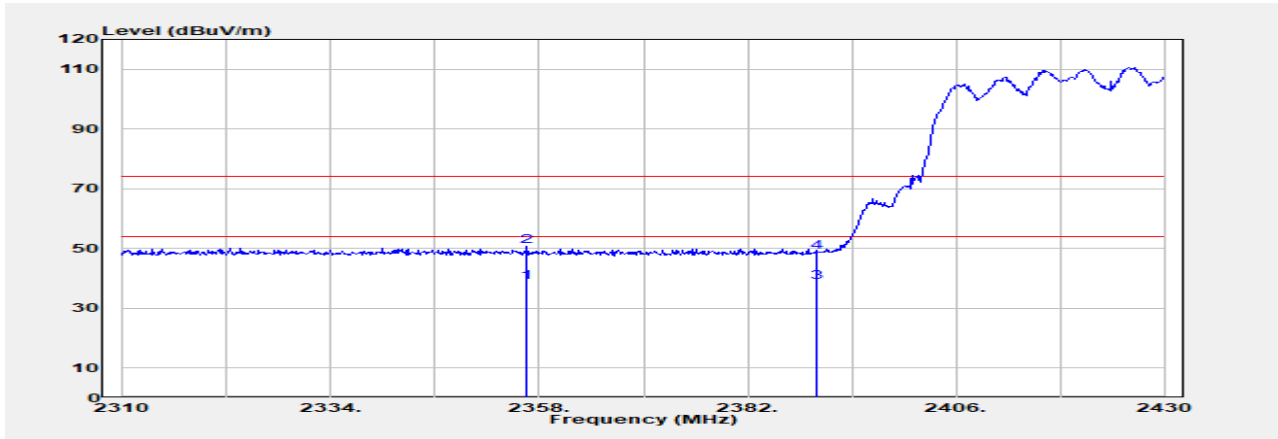

Freq. MHz	Detector Mode PK/QP/AVG	Spectrum Reading Level dBuV	Factor dB	Actual FS dBuV/m	Limit @3m dBuV/m	Margin dB
2356.560	Average	42.16	-3.34	38.82	54.00	-15.18
2356.560	Peak	54.11	-3.34	50.77	74.00	-23.23
2390.000	Average	42.11	-3.51	38.60	54.00	-15.40
2390.000	Peak	52.35	-3.51	48.84	74.00	-25.16

Unless otherwise stated the results shown in this test report refer only to the sample(s) tested and such sample(s) are retained for 90 days only.

除非另有說明，此報告結果僅對測試之樣品負責，同時此樣品僅保留90天。本報告未經本公司書面許可，不可部份複製。

This document is issued by the Company subject to its General Conditions of Service printed overleaf, available on request or accessible at <http://www.sgs.com.tw/Terms-and-Conditions> and for electronic format documents, subject to Terms and Conditions for Electronic Documents at <http://www.sgs.com.tw/Terms-and-Conditions>. Attention is drawn to the limitation of liability, indemnification and jurisdiction issues defined therein. Any holder of this document is advised that information contained hereon reflects the Company's findings at the time of its intervention only and within the limits of Client's instructions, if any. The Company's sole responsibility is to its Client and this document does not exonerate parties to a transaction from exercising all their rights and obligations under the transaction documents. This document cannot be reproduced except in full, without prior written approval of the Company. Any unauthorized alteration, forgery or falsification of the content or appearance of this document is unlawful and offenders may be prosecuted to the fullest extent of the law.

Report Number	:TERF2308001922E2	Test Site	:SAC G Chamber
Operation Mode	:802.11n40	Test Date	:2023-09-15
Test Frequency	:2422 MHz	Temp./Humi.	:24.5°C/67%
Test Mode	:Bandedge	Antenna Pol.	:Horizontal
EUT Pol	:E2 Plane	Engineer	:Temo Chen

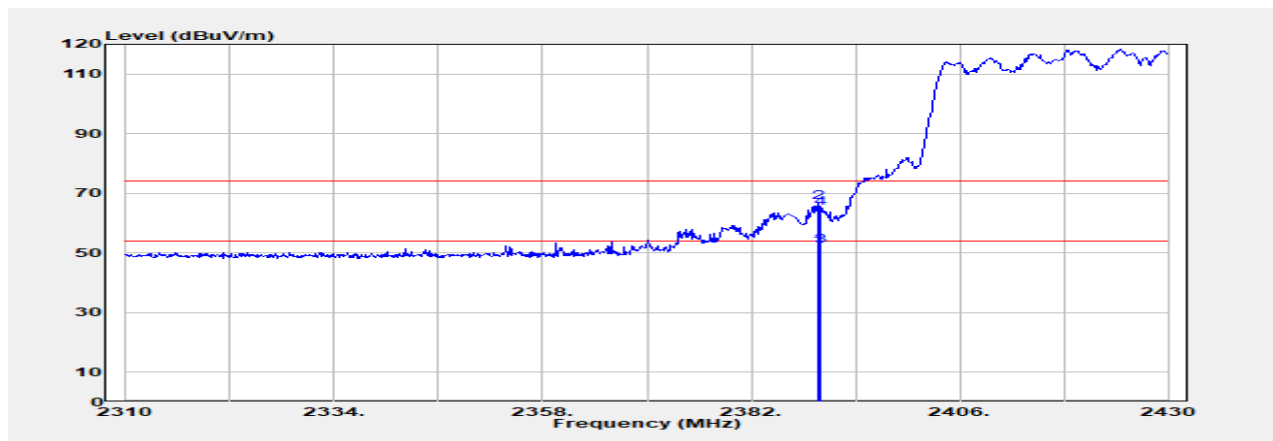

Freq. MHz	Detector Mode PK/QP/AVG	Spectrum Reading Level dBuV	Factor dB	Actual FS dBuV/m	Limit @3m dBuV/m	Margin dB
2389.800	Average	55.48	-3.51	51.97	54.00	-2.03
2389.800	Peak	70.35	-3.51	66.84	74.00	-7.16
2390.000	Average	56.01	-3.51	52.50	54.00	-1.50
2390.000	Peak	68.65	-3.51	65.14	74.00	-8.86

Unless otherwise stated the results shown in this test report refer only to the sample(s) tested and such sample(s) are retained for 90 days only.
 除非另有說明，此報告結果僅對測試之樣品負責，同時此樣品僅保留90天。本報告未經本公司書面許可，不可部份複製。

This document is issued by the Company subject to its General Conditions of Service printed overleaf, available on request or accessible at <http://www.sgs.com.tw/Terms-and-Conditions> and for electronic format documents, subject to Terms and Conditions for Electronic Documents at <http://www.sgs.com.tw/Terms-and-Conditions>. Attention is drawn to the limitation of liability, indemnification and jurisdiction issues defined therein. Any holder of this document is advised that information contained hereon reflects the Company's findings at the time of its intervention only and within the limits of Client's instructions, if any. The Company's sole responsibility is to its Client and this document does not exonerate parties to a transaction from exercising all their rights and obligations under the transaction documents. This document cannot be reproduced except in full, without prior written approval of the Company. Any unauthorized alteration, forgery or falsification of the content or appearance of this document is unlawful and offenders may be prosecuted to the fullest extent of the law.

Report Number :TERF2308001922E2
 Operation Mode :802.11n40
 Test Frequency :2452 MHz
 Test Mode :Bandedge
 EUT Pol :E2 Plane

Test Site :SAC G Chamber
 Test Date :2023-09-15
 Temp./Humi. :23.1°C/59%
 Antenna Pol. :Vertical
 Engineer :Temo Chen

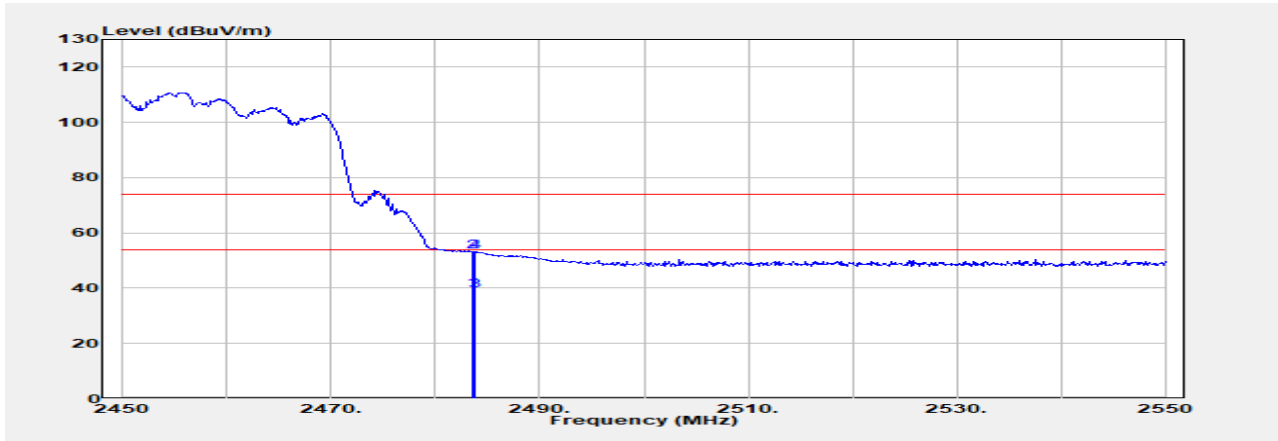

Freq. MHz	Detector Mode PK/QP/AVG	Spectrum Reading Level dBuV	Factor dB	Actual FS dBuV/m	Limit @3m dBuV/m	Margin dB
2483.500	Average	42.85	-3.54	39.31	54.00	-14.69
2483.500	Peak	56.74	-3.54	53.20	74.00	-20.80
2483.700	Average	42.78	-3.54	39.24	54.00	-14.76
2483.700	Peak	56.87	-3.54	53.33	74.00	-20.67

Unless otherwise stated the results shown in this test report refer only to the sample(s) tested and such sample(s) are retained for 90 days only.

除非另有說明，此報告結果僅對測試之樣品負責，同時此樣品僅保留90天。本報告未經本公司書面許可，不可部份複製。

This document is issued by the Company subject to its General Conditions of Service printed overleaf, available on request or accessible at <http://www.sgs.com.tw/Terms-and-Conditions> and for electronic format documents, subject to Terms and Conditions for Electronic Documents at <http://www.sgs.com.tw/Terms-and-Conditions>. Attention is drawn to the limitation of liability, indemnification and jurisdiction issues defined therein. Any holder of this document is advised that information contained hereon reflects the Company's findings at the time of its intervention only and within the limits of Client's instructions, if any. The Company's sole responsibility is to its Client and this document does not exonerate parties to a transaction from exercising all their rights and obligations under the transaction documents. This document cannot be reproduced except in full, without prior written approval of the Company. Any unauthorized alteration, forgery or falsification of the content or appearance of this document is unlawful and offenders may be prosecuted to the fullest extent of the law.

Report Number	:TERF2308001922E2	Test Site	:SAC G Chamber
Operation Mode	:802.11n40	Test Date	:2023-09-15
Test Frequency	:2452 MHz	Temp./Humi.	:23.1°C/59%
Test Mode	:Bandedge	Antenna Pol.	:Horizontal
EUT Pol	:E2 Plane	Engineer	:Temo Chen

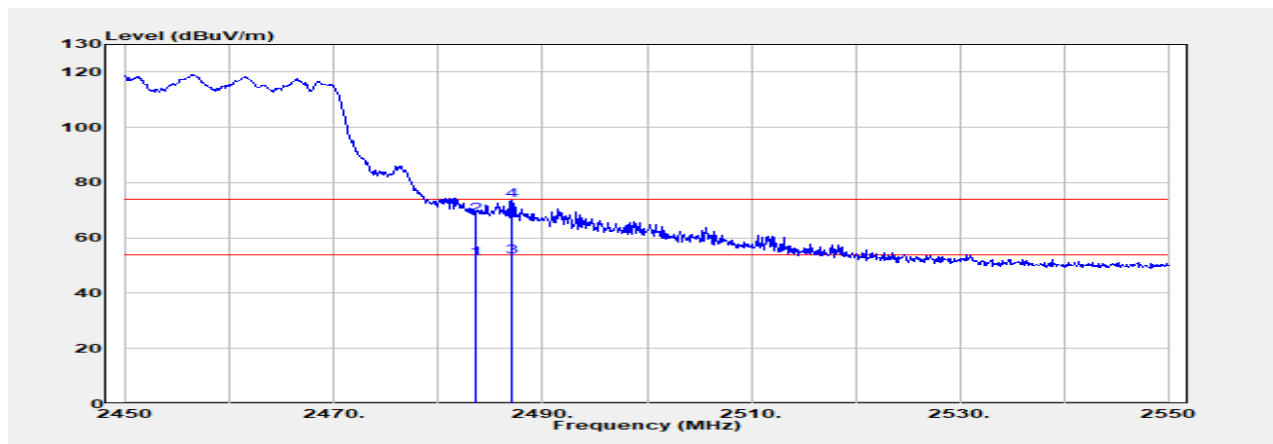

Freq. MHz	Detector Mode PK/QP/AVG	Spectrum Reading Level dBuV	Factor dB	Actual FS dBuV/m	Limit @3m dBuV/m	Margin dB
2483.500	Average	56.10	-3.54	52.55	54.00	-1.45
2483.500	Peak	71.90	-3.54	68.36	74.00	-5.64
2487.100	Average	56.89	-3.54	53.35	54.00	-0.65
2487.100	Peak	77.11	-3.54	73.57	74.00	-0.43

Unless otherwise stated the results shown in this test report refer only to the sample(s) tested and such sample(s) are retained for 90 days only.
 除非另有說明，此報告結果僅對測試之樣品負責，同時此樣品僅保留90天。本報告未經本公司書面許可，不可部份複製。

This document is issued by the Company subject to its General Conditions of Service printed overleaf, available on request or accessible at <http://www.sgs.com.tw/Terms-and-Conditions> and for electronic format documents, subject to Terms and Conditions for Electronic Documents at <http://www.sgs.com.tw/Terms-and-Conditions>. Attention is drawn to the limitation of liability, indemnification and jurisdiction issues defined therein. Any holder of this document is advised that information contained hereon reflects the Company's findings at the time of its intervention only and within the limits of Client's instructions, if any. The Company's sole responsibility is to its Client and this document does not exonerate parties to a transaction from exercising all their rights and obligations under the transaction documents. This document cannot be reproduced except in full, without prior written approval of the Company. Any unauthorized alteration, forgery or falsification of the content or appearance of this document is unlawful and offenders may be prosecuted to the fullest extent of the law.

Report Number :TERF2308001922E2

Test Site :SAC G Chamber

Operation Mode :802.11be20

Test Date :2023-11-09

Test Frequency :2412 MHz

Temp./Humi. :25.2°C/52%

Test Mode :Bandedge

Antenna Pol. :Vertical

EUT Pol :E2 Plane

Engineer :Temo Chen

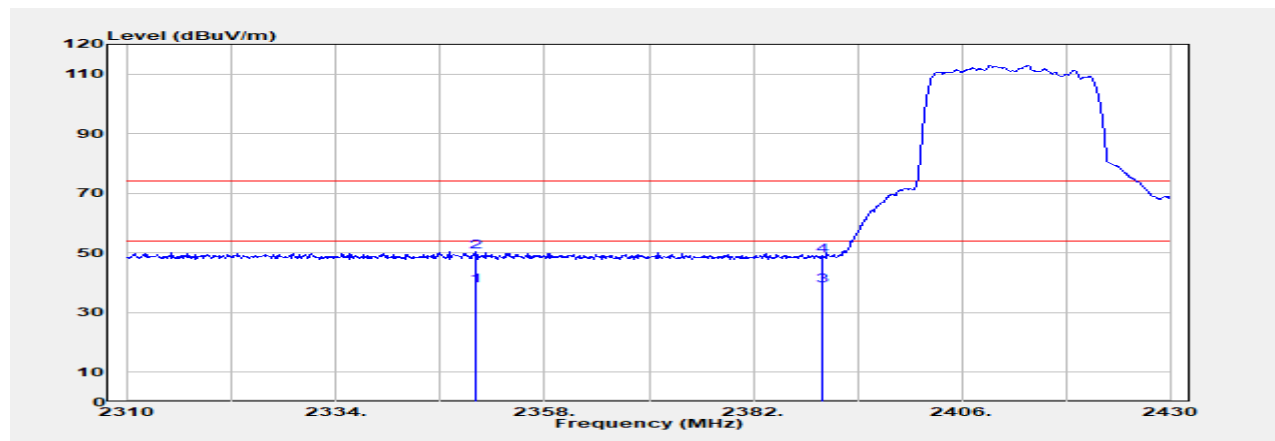

Freq. MHz	Detector Mode PK/QP/AVG	Spectrum Reading Level dBuV	Factor dB	Actual FS dBuV/m	Limit @3m dBuV/m	Margin dB
2350.080	Average	42.21	-3.31	38.90	54.00	-15.10
2350.080	Peak	53.80	-3.31	50.50	74.00	-23.50
2390.000	Average	42.38	-3.51	38.87	54.00	-15.13
2390.000	Peak	52.46	-3.51	48.95	74.00	-25.05

Unless otherwise stated the results shown in this test report refer only to the sample(s) tested and such sample(s) are retained for 90 days only.
 除非另有說明，此報告結果僅對測試之樣品負責，同時此樣品僅保留90天。本報告未經本公司書面許可，不可部份複製。

This document is issued by the Company subject to its General Conditions of Service printed overleaf, available on request or accessible at <http://www.sgs.com.tw/Terms-and-Conditions> and for electronic format documents, subject to Terms and Conditions for Electronic Documents at <http://www.sgs.com.tw/Terms-and-Conditions>. Attention is drawn to the limitation of liability, indemnification and jurisdiction issues defined therein. Any holder of this document is advised that information contained hereon reflects the Company's findings at the time of its intervention only and within the limits of Client's instructions, if any. The Company's sole responsibility is to its Client and this document does not exonerate parties to a transaction from exercising all their rights and obligations under the transaction documents. This document cannot be reproduced except in full, without prior written approval of the Company. Any unauthorized alteration, forgery or falsification of the content or appearance of this document is unlawful and offenders may be prosecuted to the fullest extent of the law.

Report Number	:TERF2308001922E2	Test Site	:SAC G Chamber
Operation Mode	:802.11be20	Test Date	:2023-11-09
Test Frequency	:2412 MHz	Temp./Humi.	:25.2°C/52%
Test Mode	:Bandedge	Antenna Pol.	:Horizontal
EUT Pol	:E2 Plane	Engineer	:Temo Chen

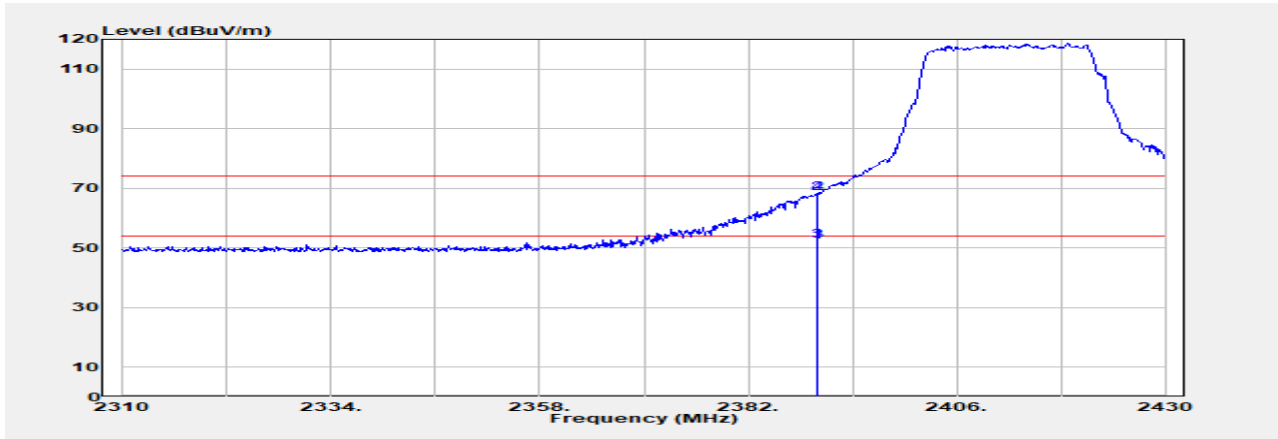

Freq. MHz	Detector Mode PK/QP/AVG	Spectrum Reading Level dBuV	Factor dB	Actual FS dBuV/m	Limit @3m dBuV/m	Margin dB
2389.920	Average	55.63	-3.51	52.12	54.00	-1.88
2389.920	Peak	71.75	-3.51	68.24	74.00	-5.76
2390.000	Average	55.73	-3.51	52.22	54.00	-1.78
2390.000	Peak	71.78	-3.51	68.27	74.00	-5.73

Unless otherwise stated the results shown in this test report refer only to the sample(s) tested and such sample(s) are retained for 90 days only.

除非另有說明，此報告結果僅對測試之樣品負責，同時此樣品僅保留90天。本報告未經本公司書面許可，不可部份複製。

This document is issued by the Company subject to its General Conditions of Service printed overleaf, available on request or accessible at <http://www.sgs.com.tw/Terms-and-Conditions> and for electronic format documents, subject to Terms and Conditions for Electronic Documents at <http://www.sgs.com.tw/Terms-and-Conditions>. Attention is drawn to the limitation of liability, indemnification and jurisdiction issues defined therein. Any holder of this document is advised that information contained hereon reflects the Company's findings at the time of its intervention only and within the limits of Client's instructions, if any. The Company's sole responsibility is to its Client and this document does not exonerate parties to a transaction from exercising all their rights and obligations under the transaction documents. This document cannot be reproduced except in full, without prior written approval of the Company. Any unauthorized alteration, forgery or falsification of the content or appearance of this document is unlawful and offenders may be prosecuted to the fullest extent of the law.

Report Number	:TERF2308001922E2	Test Site	:SAC G Chamber
Operation Mode	:802.11be20	Test Date	:2023-10-02
Test Frequency	:2462 MHz	Temp./Humi.	:21.6°C/63%
Test Mode	:Bandedge	Antenna Pol.	:Vertical
EUT Pol	:E2 Plane	Engineer	:Temo Chen

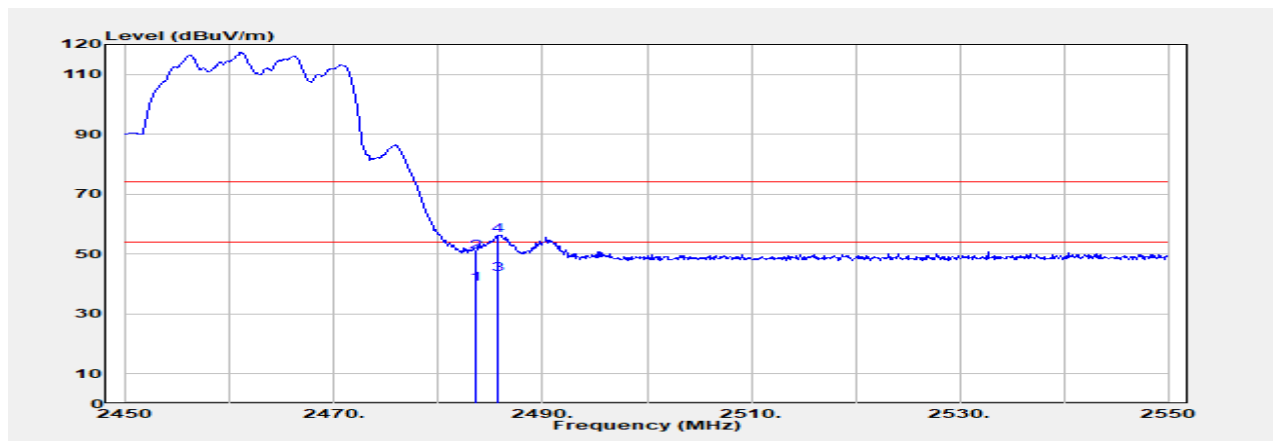

Freq. MHz	Detector Mode PK/QP/AVG	Spectrum Reading Level dBuV	Factor dB	Actual FS dBuV/m	Limit @3m dBuV/m	Margin dB
2483.500	Average	43.62	-3.54	40.08	54.00	-13.92
2483.500	Peak	54.44	-3.54	50.89	74.00	-23.11
2485.700	Average	46.83	-3.54	43.29	54.00	-10.71
2485.700	Peak	59.88	-3.54	56.34	74.00	-17.66

Unless otherwise stated the results shown in this test report refer only to the sample(s) tested and such sample(s) are retained for 90 days only.
 除非另有說明，此報告結果僅對測試之樣品負責，同時此樣品僅保留90天。本報告未經本公司書面許可，不可部份複製。

This document is issued by the Company subject to its General Conditions of Service printed overleaf, available on request or accessible at <http://www.sgs.com.tw/Terms-and-Conditions> and for electronic format documents, subject to Terms and Conditions for Electronic Documents at <http://www.sgs.com.tw/Terms-and-Conditions>. Attention is drawn to the limitation of liability, indemnification and jurisdiction issues defined therein. Any holder of this document is advised that information contained hereon reflects the Company's findings at the time of its intervention only and within the limits of Client's instructions, if any. The Company's sole responsibility is to its Client and this document does not exonerate parties to a transaction from exercising all their rights and obligations under the transaction documents. This document cannot be reproduced except in full, without prior written approval of the Company. Any unauthorized alteration, forgery or falsification of the content or appearance of this document is unlawful and offenders may be prosecuted to the fullest extent of the law.

Report Number	:TERF2308001922E2	Test Site	:SAC G Chamber
Operation Mode	:802.11be20	Test Date	:2023-10-02
Test Frequency	:2462 MHz	Temp./Humi.	:21.6°C/63%
Test Mode	:Bandedge	Antenna Pol.	:Horizontal
EUT Pol	:E2 Plane	Engineer	:Temo Chen

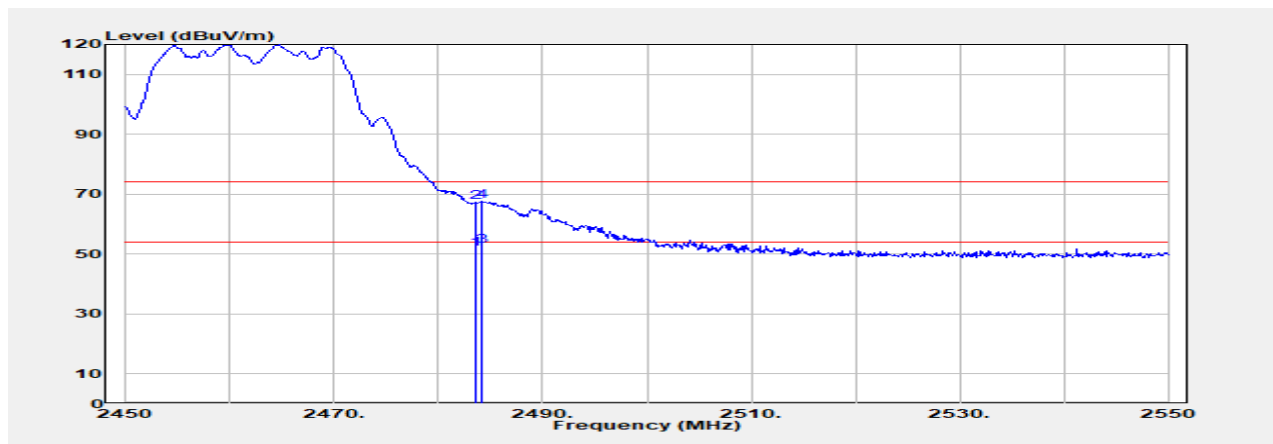

Freq. MHz	Detector Mode PK/QP/AVG	Spectrum Reading Level dBuV	Factor dB	Actual FS dBuV/m	Limit @3m dBuV/m	Margin dB
2483.500	Average	55.14	-3.54	51.59	54.00	-2.41
2483.500	Peak	70.70	-3.54	67.16	74.00	-6.84
2484.200	Average	56.30	-3.54	52.76	54.00	-1.24
2484.200	Peak	71.14	-3.54	67.59	74.00	-6.41

Unless otherwise stated the results shown in this test report refer only to the sample(s) tested and such sample(s) are retained for 90 days only.

除非另有說明，此報告結果僅對測試之樣品負責，同時此樣品僅保留90天。本報告未經本公司書面許可，不可部份複製。

This document is issued by the Company subject to its General Conditions of Service printed overleaf, available on request or accessible at <http://www.sgs.com.tw/Terms-and-Conditions> and for electronic format documents, subject to Terms and Conditions for Electronic Documents at <http://www.sgs.com.tw/Terms-and-Conditions>. Attention is drawn to the limitation of liability, indemnification and jurisdiction issues defined therein. Any holder of this document is advised that information contained hereon reflects the Company's findings at the time of its intervention only and within the limits of Client's instructions, if any. The Company's sole responsibility is to its Client and this document does not exonerate parties to a transaction from exercising all their rights and obligations under the transaction documents. This document cannot be reproduced except in full, without prior written approval of the Company. Any unauthorized alteration, forgery or falsification of the content or appearance of this document is unlawful and offenders may be prosecuted to the fullest extent of the law.

Report Number	:TERF2308001922E2	Test Site	:SAC G Chamber
Operation Mode	:802.11be40	Test Date	:2023-09-14
Test Frequency	:2422 MHz	Temp./Humi.	:24.7°C/62%
Test Mode	:Bandedge	Antenna Pol.	:Vertical
EUT Pol	:E2 Plane	Engineer	:Temo Chen

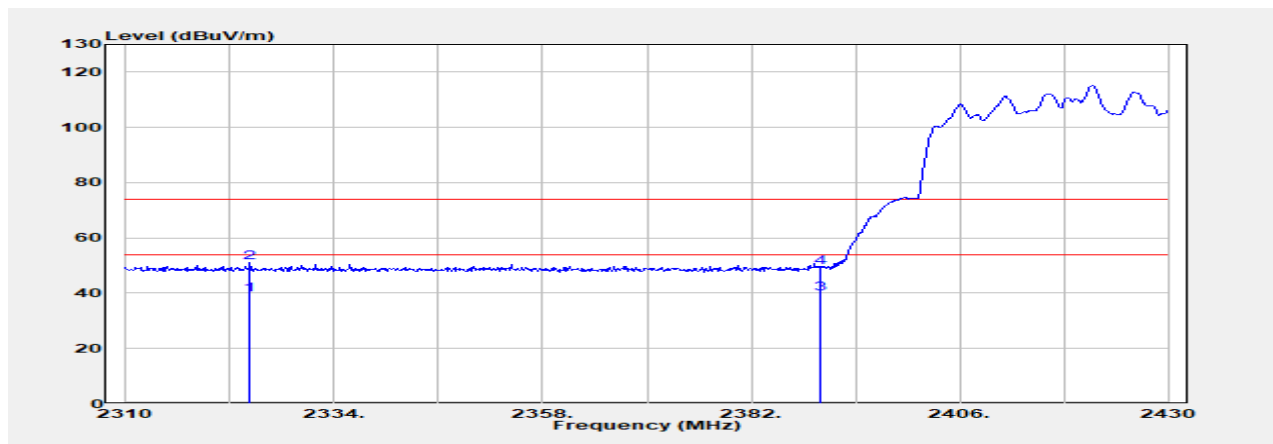

Freq. MHz	Detector Mode PK/QP/AVG	Spectrum Reading Level dBuV	Factor dB	Actual FS dBuV/m	Limit @3m dBuV/m	Margin dB
2324.280	Average	42.77	-3.28	39.50	54.00	-14.50
2324.280	Peak	54.19	-3.28	50.91	74.00	-23.09
2390.000	Average	43.22	-3.51	39.71	54.00	-14.29
2390.000	Peak	52.89	-3.51	49.39	74.00	-24.61

Unless otherwise stated the results shown in this test report refer only to the sample(s) tested and such sample(s) are retained for 90 days only.
 除非另有說明，此報告結果僅對測試之樣品負責，同時此樣品僅保留90天。本報告未經本公司書面許可，不可部份複製。

This document is issued by the Company subject to its General Conditions of Service printed overleaf, available on request or accessible at <http://www.sgs.com.tw/Terms-and-Conditions> and for electronic format documents, subject to Terms and Conditions for Electronic Documents at <http://www.sgs.com.tw/Terms-and-Conditions>. Attention is drawn to the limitation of liability, indemnification and jurisdiction issues defined therein. Any holder of this document is advised that information contained hereon reflects the Company's findings at the time of its intervention only and within the limits of Client's instructions, if any. The Company's sole responsibility is to its Client and this document does not exonerate parties to a transaction from exercising all their rights and obligations under the transaction documents. This document cannot be reproduced except in full, without prior written approval of the Company. Any unauthorized alteration, forgery or falsification of the content or appearance of this document is unlawful and offenders may be prosecuted to the fullest extent of the law.

Report Number	:TERF2308001922E2	Test Site	:SAC G Chamber
Operation Mode	:802.11be40	Test Date	:2023-09-14
Test Frequency	:2422 MHz	Temp./Humi.	:24.7°C/62%
Test Mode	:Bandedge	Antenna Pol.	:Horizontal
EUT Pol	:E2 Plane	Engineer	:Temo Chen

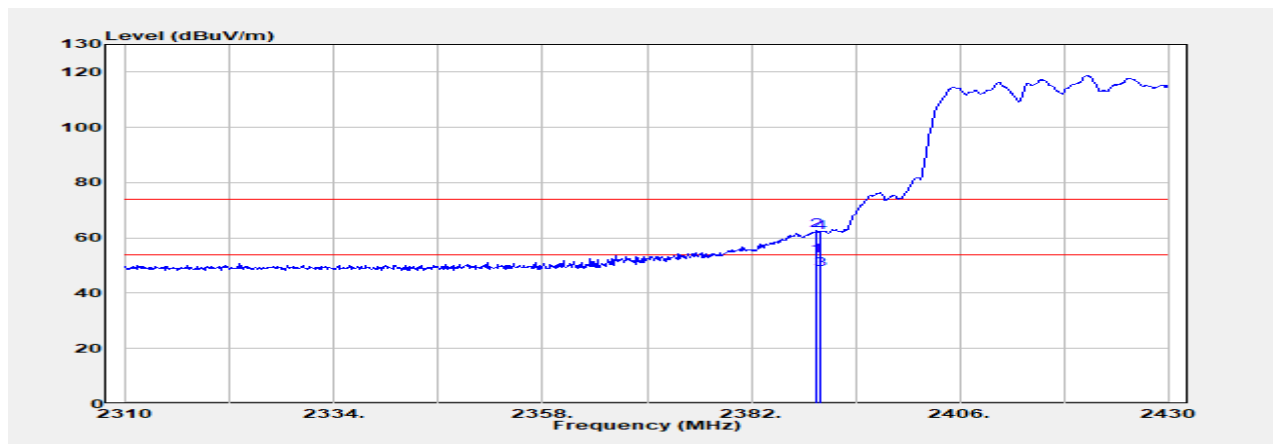

Freq. MHz	Detector Mode PK/QP/AVG	Spectrum Reading Level dBuV	Factor dB	Actual FS dBuV/m	Limit @3m dBuV/m	Margin dB
2389.560	Average	56.92	-3.51	53.41	54.00	-0.59
2389.560	Peak	66.14	-3.51	62.63	74.00	-11.37
2390.000	Average	52.29	-3.51	48.78	54.00	-5.22
2390.000	Peak	65.68	-3.51	62.17	74.00	-11.83

Unless otherwise stated the results shown in this test report refer only to the sample(s) tested and such sample(s) are retained for 90 days only.

除非另有說明，此報告結果僅對測試之樣品負責，同時此樣品僅保留90天。本報告未經本公司書面許可，不可部份複製。

This document is issued by the Company subject to its General Conditions of Service printed overleaf, available on request or accessible at <http://www.sgs.com.tw/Terms-and-Conditions> and for electronic format documents, subject to Terms and Conditions for Electronic Documents at <http://www.sgs.com.tw/Terms-and-Conditions>. Attention is drawn to the limitation of liability, indemnification and jurisdiction issues defined therein. Any holder of this document is advised that information contained hereon reflects the Company's findings at the time of its intervention only and within the limits of Client's instructions, if any. The Company's sole responsibility is to its Client and this document does not exonerate parties to a transaction from exercising all their rights and obligations under the transaction documents. This document cannot be reproduced except in full, without prior written approval of the Company. Any unauthorized alteration, forgery or falsification of the content or appearance of this document is unlawful and offenders may be prosecuted to the fullest extent of the law.

Report Number	:TERF2308001922E2	Test Site	:SAC G Chamber
Operation Mode	:802.11be40	Test Date	:2023-09-14
Test Frequency	:2452 MHz	Temp./Humi.	:24.7°C/62%
Test Mode	:Bandedge	Antenna Pol.	:Vertical
EUT Pol	:E2 Plane	Engineer	:Temo Chen

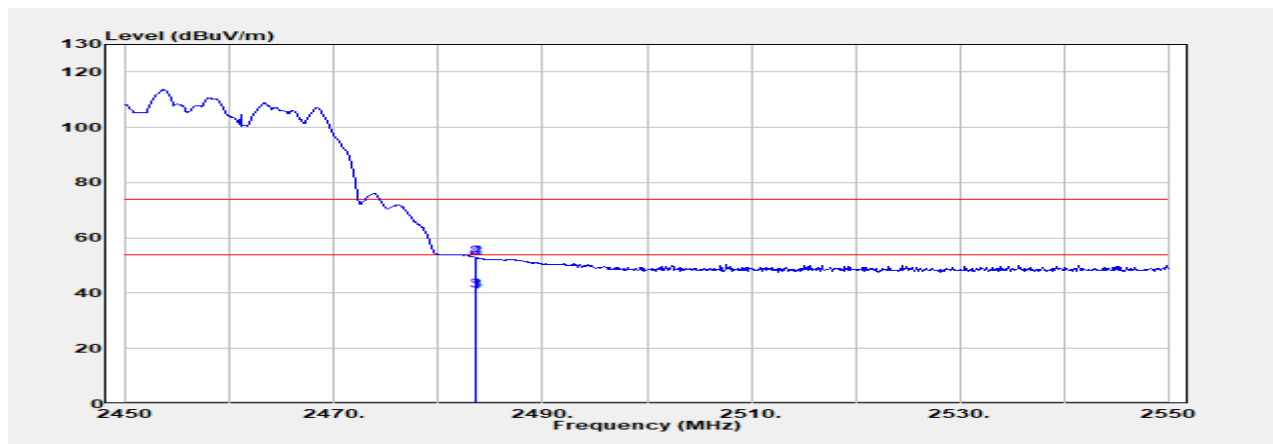

Freq. MHz	Detector Mode PK/QP/AVG	Spectrum Reading Level dBuV	Factor dB	Actual FS dBuV/m	Limit @3m dBuV/m	Margin dB
2483.500	Average	44.23	-3.54	40.69	54.00	-13.31
2483.500	Peak	56.53	-3.54	52.99	74.00	-21.01
2483.600	Average	44.34	-3.54	40.79	54.00	-13.21
2483.600	Peak	56.51	-3.54	52.97	74.00	-21.03

Unless otherwise stated the results shown in this test report refer only to the sample(s) tested and such sample(s) are retained for 90 days only.

除非另有說明，此報告結果僅對測試之樣品負責，同時此樣品僅保留90天。本報告未經本公司書面許可，不可部份複製。

This document is issued by the Company subject to its General Conditions of Service printed overleaf, available on request or accessible at <http://www.sgs.com.tw/Terms-and-Conditions> and for electronic format documents, subject to Terms and Conditions for Electronic Documents at <http://www.sgs.com.tw/Terms-and-Conditions>. Attention is drawn to the limitation of liability, indemnification and jurisdiction issues defined therein. Any holder of this document is advised that information contained hereon reflects the Company's findings at the time of its intervention only and within the limits of Client's instructions, if any. The Company's sole responsibility is to its Client and this document does not exonerate parties to a transaction from exercising all their rights and obligations under the transaction documents. This document cannot be reproduced except in full, without prior written approval of the Company. Any unauthorized alteration, forgery or falsification of the content or appearance of this document is unlawful and offenders may be prosecuted to the fullest extent of the law.

Report Number	:TERF2308001922E2	Test Site	:SAC G Chamber
Operation Mode	:802.11be40	Test Date	:2023-09-14
Test Frequency	:2452 MHz	Temp./Humi.	:24.7°C/62%
Test Mode	:Bandedge	Antenna Pol.	:Horizontal
EUT Pol	:E2 Plane	Engineer	:Temo Chen

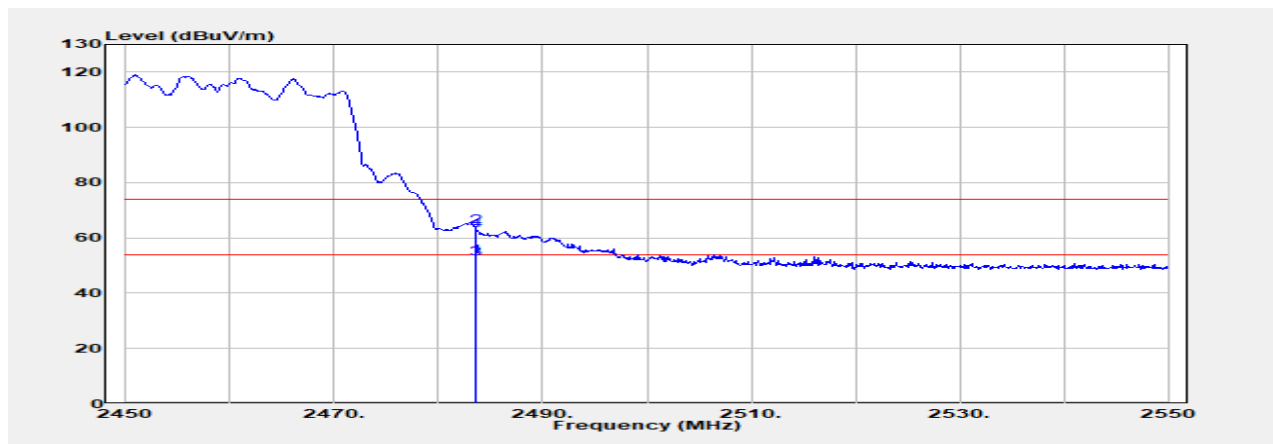

Freq. MHz	Detector Mode PK/QP/AVG	Spectrum Reading Level dBuV	Factor dB	Actual FS dBuV/m	Limit @3m dBuV/m	Margin dB
2483.500	Average	56.83	-3.54	53.29	54.00	-0.71
2483.500	Peak	67.53	-3.54	63.99	74.00	-10.01
2483.600	Average	56.09	-3.54	52.54	54.00	-1.46
2483.600	Peak	66.38	-3.54	62.84	74.00	-11.16

Unless otherwise stated the results shown in this test report refer only to the sample(s) tested and such sample(s) are retained for 90 days only.
 除非另有說明，此報告結果僅對測試之樣品負責，同時此樣品僅保留90天。本報告未經本公司書面許可，不可部份複製。

This document is issued by the Company subject to its General Conditions of Service printed overleaf, available on request or accessible at <http://www.sgs.com.tw/Terms-and-Conditions> and for electronic format documents, subject to Terms and Conditions for Electronic Documents at <http://www.sgs.com.tw/Terms-and-Conditions>. Attention is drawn to the limitation of liability, indemnification and jurisdiction issues defined therein. Any holder of this document is advised that information contained hereon reflects the Company's findings at the time of its intervention only and within the limits of Client's instructions, if any. The Company's sole responsibility is to its Client and this document does not exonerate parties to a transaction from exercising all their rights and obligations under the transaction documents. This document cannot be reproduced except in full, without prior written approval of the Company. Any unauthorized alteration, forgery or falsification of the content or appearance of this document is unlawful and offenders may be prosecuted to the fullest extent of the law.

11.6.2 Spurious Emission:

Mode: CDD

Report Number	:TERF2308001922E2	Test Site	:SAC G Chamber
Operation Mode	:802.11g	Test Date	:2023-10-26
Test Frequency	:2437 MHz	Temp./Humi.	:23.7°C/57%
Test Mode	:Tx	Antenna Pol.	:Vertical
EUT Pol	:E2 Plane	Engineer	:Temo Chen

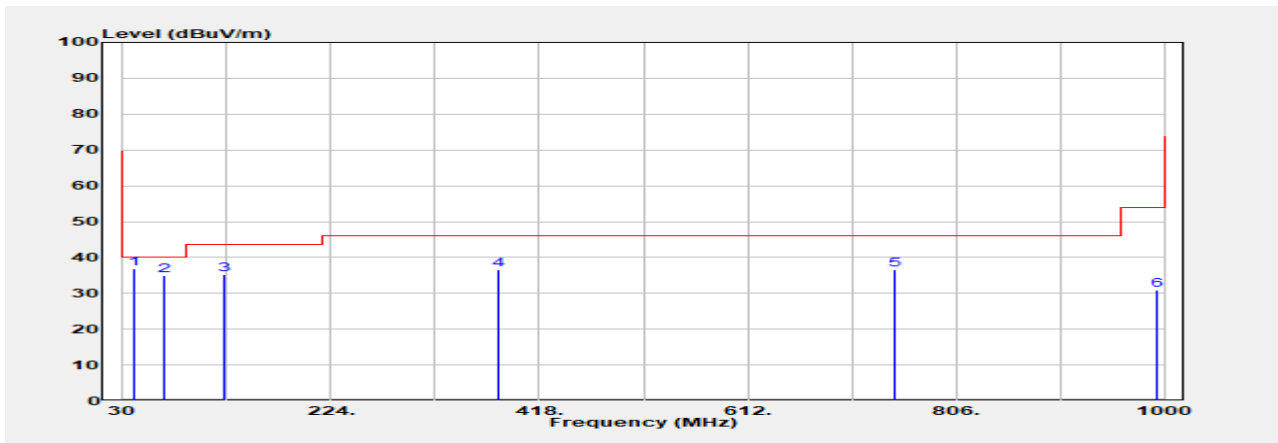

Freq.	Detector	Spectrum	Factor	Actual	Limit	Margin
MHz	Mode	Reading Level	dB	FS	@3m	dB
	PK/QP/AVG	dBuV		dBuV/m	dBuV/m	
39.700	QP	50.30	-13.47	36.83	40.00	-3.17
68.800	QP	49.70	-14.80	34.90	40.00	-5.10
125.060	Peak	50.17	-14.99	35.18	43.50	-8.32
380.170	Peak	46.23	-9.74	36.49	46.00	-9.51
749.740	Peak	38.57	-2.06	36.50	46.00	-9.50
993.210	Peak	30.33	0.65	30.98	54.00	-23.02

Unless otherwise stated the results shown in this test report refer only to the sample(s) tested and such sample(s) are retained for 90 days only.

除非另有說明，此報告結果僅對測試之樣品負責，同時此樣品僅保留90天。本報告未經本公司書面許可，不可部份複製。

This document is issued by the Company subject to its General Conditions of Service printed overleaf, available on request or accessible at <http://www.sgs.com.tw/Terms-and-Conditions> and for electronic format documents, subject to Terms and Conditions for Electronic Documents at <http://www.sgs.com.tw/Terms-and-Conditions>. Attention is drawn to the limitation of liability, indemnification and jurisdiction issues defined therein. Any holder of this document is advised that information contained hereon reflects the Company's findings at the time of its intervention only and within the limits of Client's instructions, if any. The Company's sole responsibility is to its Client and this document does not exonerate parties to a transaction from exercising all their rights and obligations under the transaction documents. This document cannot be reproduced except in full, without prior written approval of the Company. Any unauthorized alteration, forgery or falsification of the content or appearance of this document is unlawful and offenders may be prosecuted to the fullest extent of the law.

Report Number :TERF2308001922E2
 Operation Mode :802.11g
 Test Frequency :2437 MHz
 Test Mode :Tx
 EUT Pol :E2 Plane

Test Site :SAC G Chamber
 Test Date :2023-10-26
 Temp./Humi. :23.7°C/57%
 Antenna Pol. :Horizontal
 Engineer :Temo Chen

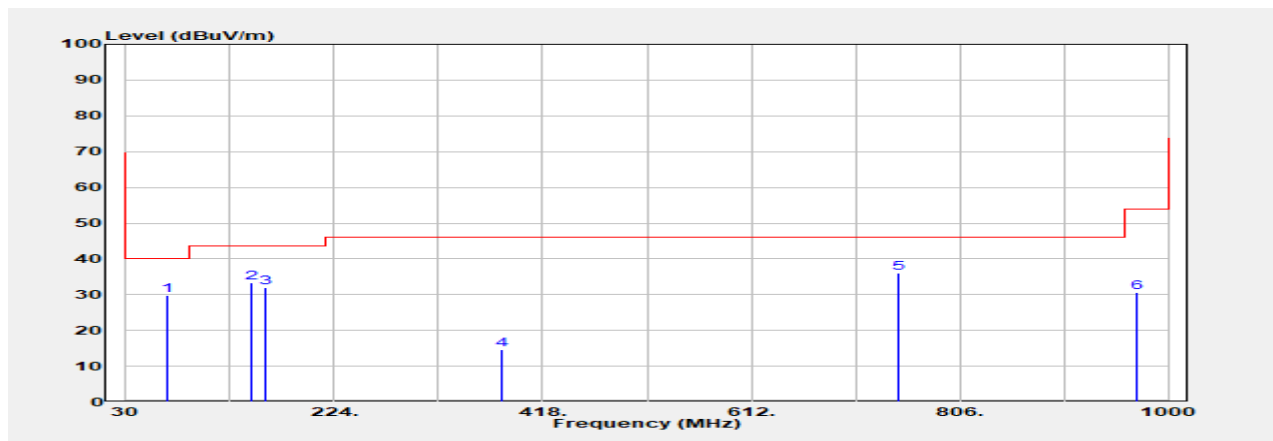

Freq. MHz	Detector Mode PK/QP/AVG	Spectrum Reading Level dBµV	Factor dB	Actual FS dBµV/m	Limit @3m dBµV/m	Margin dB
68.800	QP	44.70	-14.80	29.90	40.00	-10.10
147.370	Peak	46.17	-12.78	33.39	43.50	-10.11
159.010	Peak	44.54	-12.52	32.02	43.50	-11.48
380.170	QP	24.30	-9.74	14.56	46.00	-31.44
749.740	Peak	38.21	-2.06	36.15	46.00	-9.85
970.900	Peak	29.62	0.92	30.54	54.00	-23.46

Unless otherwise stated the results shown in this test report refer only to the sample(s) tested and such sample(s) are retained for 90 days only.

除非另有說明，此報告結果僅對測試之樣品負責，同時此樣品僅保留90天。本報告未經本公司書面許可，不可部份複製。

This document is issued by the Company subject to its General Conditions of Service printed overleaf, available on request or accessible at <http://www.sgs.com.tw/Terms-and-Conditions> and for electronic format documents, subject to Terms and Conditions for Electronic Documents at <http://www.sgs.com.tw/Terms-and-Conditions>. Attention is drawn to the limitation of liability, indemnification and jurisdiction issues defined therein. Any holder of this document is advised that information contained hereon reflects the Company's findings at the time of its intervention only and within the limits of Client's instructions, if any. The Company's sole responsibility is to its Client and this document does not exonerate parties to a transaction from exercising all their rights and obligations under the transaction documents. This document cannot be reproduced except in full, without prior written approval of the Company. Any unauthorized alteration, forgery or falsification of the content or appearance of this document is unlawful and offenders may be prosecuted to the fullest extent of the law.

Report Number :TERF2308001922E2
 Operation Mode :802.11be40
 Test Frequency :2437 MHz
 Test Mode :Tx
 EUT Pol :E2 Plane

Test Site :SAC G Chamber
 Test Date :2023-10-26
 Temp./Humi. :23.7°C/57%
 Antenna Pol. :Vertical
 Engineer :Temo Chen

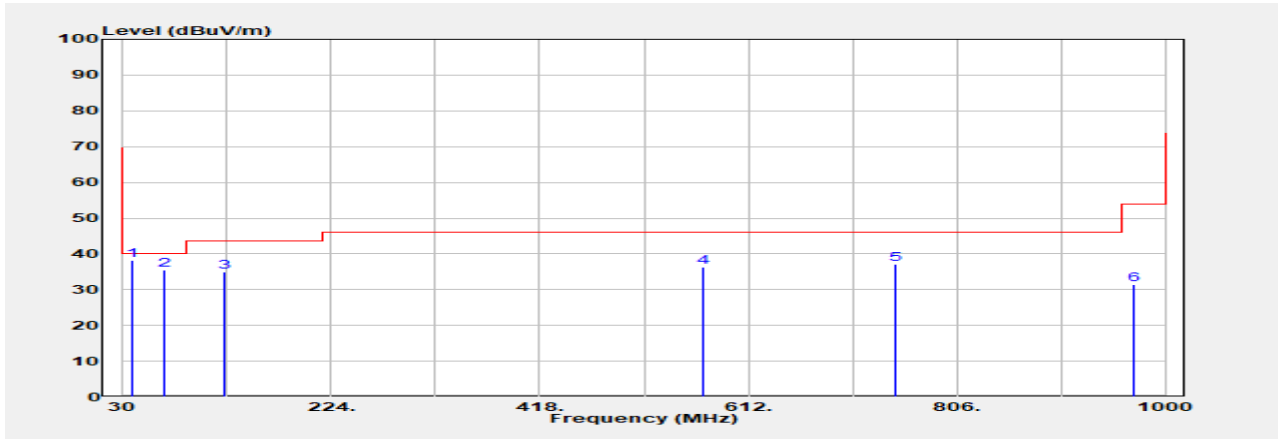

Freq. MHz	Detector Mode PK/QP/AVG	Spectrum Reading Level dBμV	Factor dB	Actual FS dBμV/m	Limit @3m dBμV/m	Margin dB
38.730	QP	51.70	-13.59	38.11	40.00	-1.89
68.800	QP	50.40	-14.80	35.60	40.00	-4.40
125.060	Peak	49.95	-14.99	34.96	43.50	-8.54
570.290	Peak	42.17	-5.90	36.27	46.00	-9.73
749.740	Peak	39.07	-2.06	37.01	46.00	-8.99
970.900	Peak	30.48	0.92	31.40	54.00	-22.60

Unless otherwise stated the results shown in this test report refer only to the sample(s) tested and such sample(s) are retained for 90 days only.

除非另有說明，此報告結果僅對測試之樣品負責，同時此樣品僅保留90天。本報告未經本公司書面許可，不可部份複製。

This document is issued by the Company subject to its General Conditions of Service printed overleaf, available on request or accessible at <http://www.sgs.com.tw/Terms-and-Conditions> and for electronic format documents, subject to Terms and Conditions for Electronic Documents at <http://www.sgs.com.tw/Terms-and-Conditions>. Attention is drawn to the limitation of liability, indemnification and jurisdiction issues defined therein. Any holder of this document is advised that information contained hereon reflects the Company's findings at the time of its intervention only and within the limits of Client's instructions, if any. The Company's sole responsibility is to its Client and this document does not exonerate parties to a transaction from exercising all their rights and obligations under the transaction documents. This document cannot be reproduced except in full, without prior written approval of the Company. Any unauthorized alteration, forgery or falsification of the content or appearance of this document is unlawful and offenders may be prosecuted to the fullest extent of the law.

Report Number :TERF2308001922E2
 Operation Mode :802.11be40
 Test Frequency :2437 MHz
 Test Mode :Tx
 EUT Pol :E2 Plane

Test Site :SAC G Chamber
 Test Date :2023-10-26
 Temp./Humi. :23.7°C/57%
 Antenna Pol. :Horizontal
 Engineer :Temo Chen

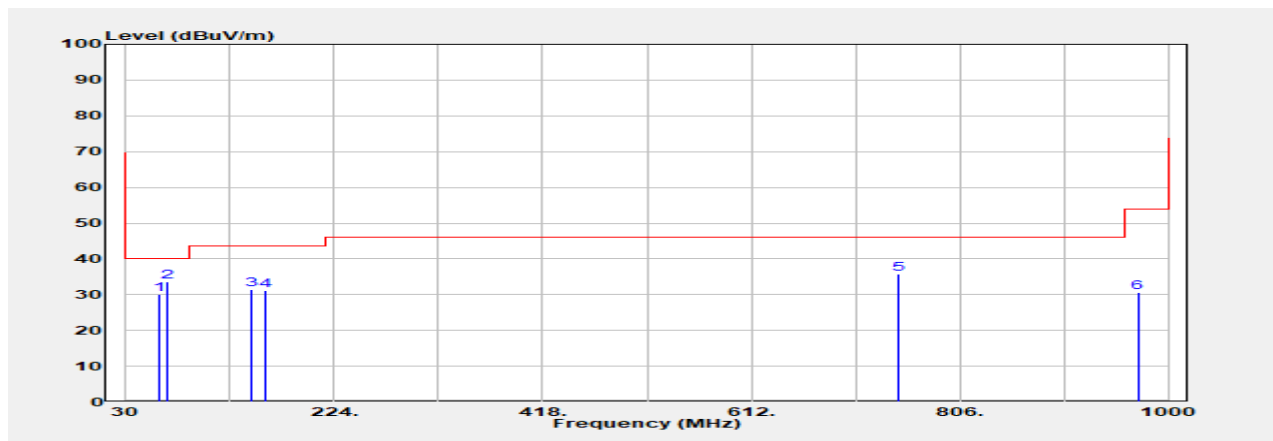

Freq. MHz	Detector Mode PK/QP/AVG	Spectrum Reading Level dBµV	Factor dB	Actual FS dBµV/m	Limit @3m dBµV/m	Margin dB
61.040	Peak	43.62	-13.45	30.18	40.00	-9.82
68.800	Peak	48.40	-14.80	33.60	40.00	-6.40
146.400	Peak	44.29	-12.92	31.38	43.50	-12.12
159.010	Peak	43.59	-12.52	31.07	43.50	-12.43
749.740	Peak	37.77	-2.06	35.71	46.00	-10.29
971.870	Peak	29.64	0.92	30.56	54.00	-23.44

Unless otherwise stated the results shown in this test report refer only to the sample(s) tested and such sample(s) are retained for 90 days only.

除非另有說明，此報告結果僅對測試之樣品負責，同時此樣品僅保留90天。本報告未經本公司書面許可，不可部份複製。

This document is issued by the Company subject to its General Conditions of Service printed overleaf, available on request or accessible at <http://www.sgs.com.tw/Terms-and-Conditions> and for electronic format documents, subject to Terms and Conditions for Electronic Documents at <http://www.sgs.com.tw/Terms-and-Conditions>. Attention is drawn to the limitation of liability, indemnification and jurisdiction issues defined therein. Any holder of this document is advised that information contained hereon reflects the Company's findings at the time of its intervention only and within the limits of Client's instructions, if any. The Company's sole responsibility is to its Client and this document does not exonerate parties to a transaction from exercising all their rights and obligations under the transaction documents. This document cannot be reproduced except in full, without prior written approval of the Company. Any unauthorized alteration, forgery or falsification of the content or appearance of this document is unlawful and offenders may be prosecuted to the fullest extent of the law.

Report Number :TERF2308001922E2
 Operation Mode :802.11b
 Test Frequency :2412 MHz
 Test Mode :Tx
 EUT Pol :E2 Plane

Test Site :SAC G Chamber
 Test Date :2023-08-23
 Temp./Humi. :23.6°C/59%
 Antenna Pol. :Vertical
 Engineer :Temo Chen

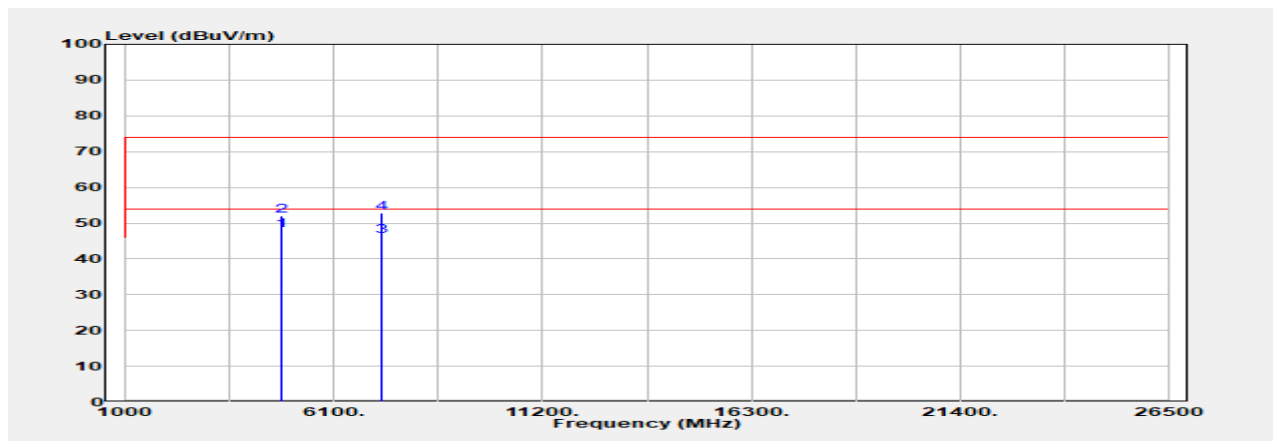

Freq. MHz	Detector Mode PK/QP/AVG	Spectrum Reading Level dB μ V	Factor dB	Actual FS dB μ V/m	Limit @3m dB μ V/m	Margin dB
4824.000	Average	44.78	3.28	48.07	54.00	-5.93
4824.000	Peak	48.80	3.28	52.08	74.00	-21.92
7236.000	Average	37.68	8.54	46.21	54.00	-7.79
7236.000	Peak	44.28	8.54	52.82	74.00	-21.18

Unless otherwise stated the results shown in this test report refer only to the sample(s) tested and such sample(s) are retained for 90 days only.
 除非另有說明，此報告結果僅對測試之樣品負責，同時此樣品僅保留90天。本報告未經本公司書面許可，不可部份複製。

This document is issued by the Company subject to its General Conditions of Service printed overleaf, available on request or accessible at <http://www.sgs.com.tw/Terms-and-Conditions> and for electronic format documents, subject to Terms and Conditions for Electronic Documents at <http://www.sgs.com.tw/Terms-and-Conditions>. Attention is drawn to the limitation of liability, indemnification and jurisdiction issues defined therein. Any holder of this document is advised that information contained hereon reflects the Company's findings at the time of its intervention only and within the limits of Client's instructions, if any. The Company's sole responsibility is to its Client and this document does not exonerate parties to a transaction from exercising all their rights and obligations under the transaction documents. This document cannot be reproduced except in full, without prior written approval of the Company. Any unauthorized alteration, forgery or falsification of the content or appearance of this document is unlawful and offenders may be prosecuted to the fullest extent of the law.

Report Number :TERF2308001922E2
 Operation Mode :802.11b
 Test Frequency :2412 MHz
 Test Mode :Tx
 EUT Pol :E2 Plane

Test Site :SAC G Chamber
 Test Date :2023-08-23
 Temp./Humi. :23.6°C/59%
 Antenna Pol. :Horizontal
 Engineer :Temo Chen

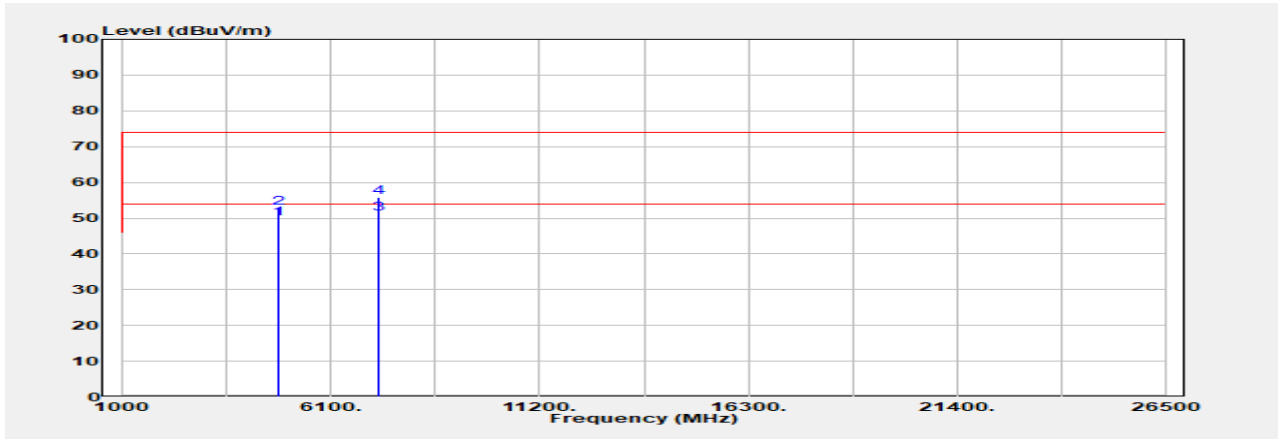

Freq. MHz	Detector Mode PK/QP/AVG	Spectrum Reading Level dBµV	Factor dB	Actual FS dBµV/m	Limit @3m dBµV/m	Margin dB
4824.000	Average	46.52	3.28	49.81	54.00	-4.19
4824.000	Peak	49.44	3.28	52.72	74.00	-21.28
7236.000	Average	42.66	8.54	51.20	54.00	-2.80
7236.000	Peak	47.25	8.54	55.78	74.00	-18.22

Unless otherwise stated the results shown in this test report refer only to the sample(s) tested and such sample(s) are retained for 90 days only.

除非另有說明，此報告結果僅對測試之樣品負責，同時此樣品僅保留90天。本報告未經本公司書面許可，不可部份複製。
 This document is issued by the Company subject to its General Conditions of Service printed overleaf, available on request or accessible at <http://www.sgs.com.tw/Terms-and-Conditions> and for electronic format documents, subject to Terms and Conditions for Electronic Documents at <http://www.sgs.com.tw/Terms-and-Conditions>. Attention is drawn to the limitation of liability, indemnification and jurisdiction issues defined therein. Any holder of this document is advised that information contained hereon reflects the Company's findings at the time of its intervention only and within the limits of Client's instructions, if any. The Company's sole responsibility is to its Client and this document does not exonerate parties to a transaction from exercising all their rights and obligations under the transaction documents. This document cannot be reproduced except in full, without prior written approval of the Company. Any unauthorized alteration, forgery or falsification of the content or appearance of this document is unlawful and offenders may be prosecuted to the fullest extent of the law.

Report Number :TERF2308001922E2
 Operation Mode :802.11b
 Test Frequency :2437 MHz
 Test Mode :Tx
 EUT Pol :E2 Plane

Test Site :SAC G Chamber
 Test Date :2023-08-23
 Temp./Humi. :23.6°C/59%
 Antenna Pol. :Vertical
 Engineer :Temo Chen

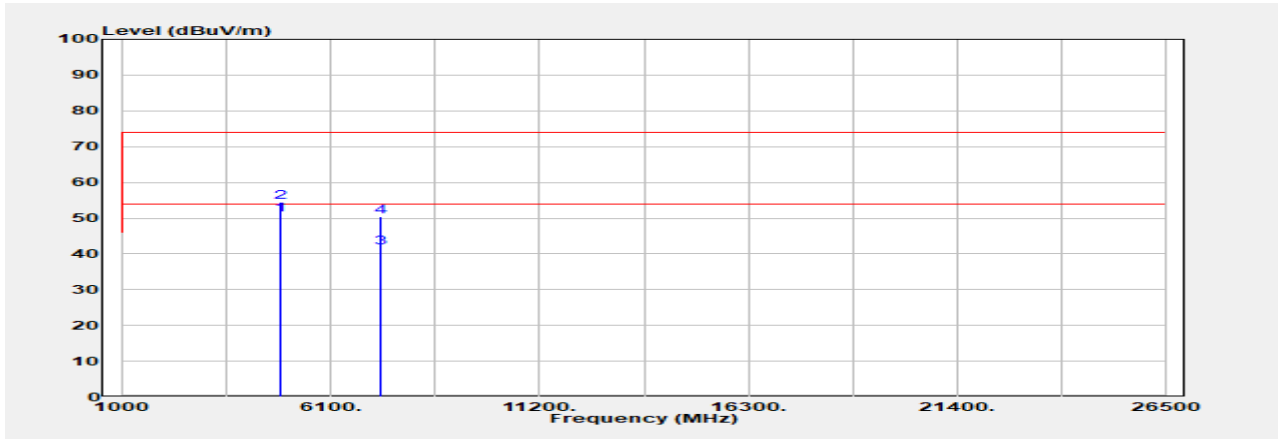

Freq. MHz	Detector Mode PK/QP/AVG	Spectrum Reading Level dB μ V	Factor dB	Actual FS dB μ V/m	Limit @3m dB μ V/m	Margin dB
4874.000	Average	47.53	3.35	50.88	54.00	-3.12
4874.000	Peak	51.02	3.35	54.37	74.00	-19.63
7311.000	Average	33.09	8.58	41.67	54.00	-12.33
7311.000	Peak	41.78	8.58	50.35	74.00	-23.65

Unless otherwise stated the results shown in this test report refer only to the sample(s) tested and such sample(s) are retained for 90 days only.

除非另有說明，此報告結果僅對測試之樣品負責，同時此樣品僅保留90天。本報告未經本公司書面許可，不可部份複製。
 This document is issued by the Company subject to its General Conditions of Service printed overleaf, available on request or accessible at <http://www.sgs.com.tw/Terms-and-Conditions> and for electronic format documents, subject to Terms and Conditions for Electronic Documents at <http://www.sgs.com.tw/Terms-and-Conditions>. Attention is drawn to the limitation of liability, indemnification and jurisdiction issues defined therein. Any holder of this document is advised that information contained hereon reflects the Company's findings at the time of its intervention only and within the limits of Client's instructions, if any. The Company's sole responsibility is to its Client and this document does not exonerate parties to a transaction from exercising all their rights and obligations under the transaction documents. This document cannot be reproduced except in full, without prior written approval of the Company. Any unauthorized alteration, forgery or falsification of the content or appearance of this document is unlawful and offenders may be prosecuted to the fullest extent of the law.

Report Number :TERF2308001922E2
 Operation Mode :802.11b
 Test Frequency :2437 MHz
 Test Mode :Tx
 EUT Pol :E2 Plane

Test Site :SAC G Chamber
 Test Date :2023-08-23
 Temp./Humi. :23.6°C/59%
 Antenna Pol. :Horizontal
 Engineer :Temo Chen

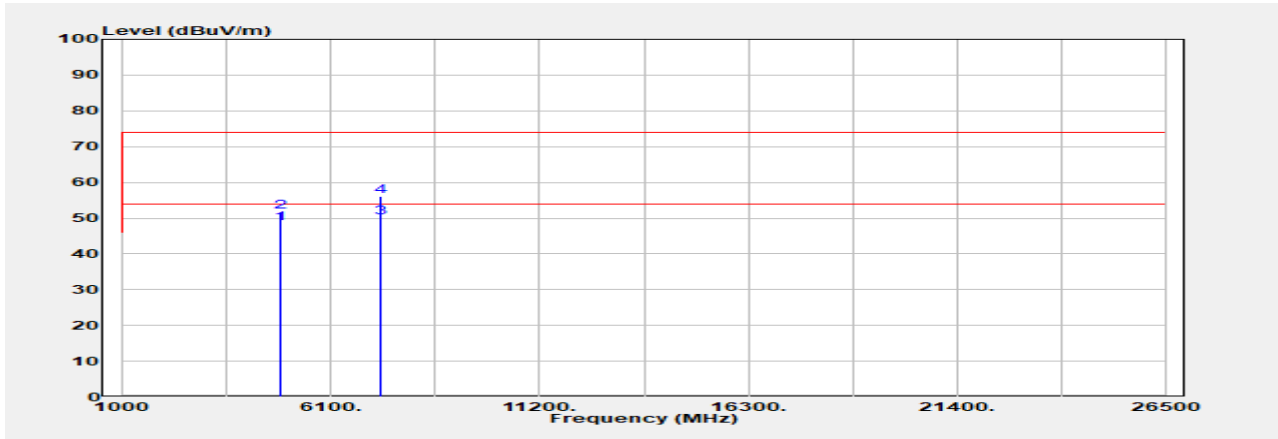

Freq. MHz	Detector Mode PK/QP/AVG	Spectrum Reading Level dBµV	Factor dB	Actual FS dBµV/m	Limit @3m dBµV/m	Margin dB
4874.000	Average	45.16	3.35	48.51	54.00	-5.49
4874.000	Peak	48.53	3.35	51.89	74.00	-22.11
7311.000	Average	41.68	8.58	50.26	54.00	-3.74
7311.000	Peak	47.50	8.58	56.07	74.00	-17.93

Unless otherwise stated the results shown in this test report refer only to the sample(s) tested and such sample(s) are retained for 90 days only.

除非另有說明，此報告結果僅對測試之樣品負責，同時此樣品僅保留90天。本報告未經本公司書面許可，不可部份複製。
 This document is issued by the Company subject to its General Conditions of Service printed overleaf, available on request or accessible at <http://www.sgs.com.tw/Terms-and-Conditions> and for electronic format documents, subject to Terms and Conditions for Electronic Documents at <http://www.sgs.com.tw/Terms-and-Conditions>. Attention is drawn to the limitation of liability, indemnification and jurisdiction issues defined therein. Any holder of this document is advised that information contained hereon reflects the Company's findings at the time of its intervention only and within the limits of Client's instructions, if any. The Company's sole responsibility is to its Client and this document does not exonerate parties to a transaction from exercising all their rights and obligations under the transaction documents. This document cannot be reproduced except in full, without prior written approval of the Company. Any unauthorized alteration, forgery or falsification of the content or appearance of this document is unlawful and offenders may be prosecuted to the fullest extent of the law.

Report Number :TERF2308001922E2
 Operation Mode :802.11b
 Test Frequency :2462 MHz
 Test Mode :Tx
 EUT Pol :E2 Plane

Test Site :SAC G Chamber
 Test Date :2023-08-23
 Temp./Humi. :23.6°C/59%
 Antenna Pol. :Vertical
 Engineer :Temo Chen

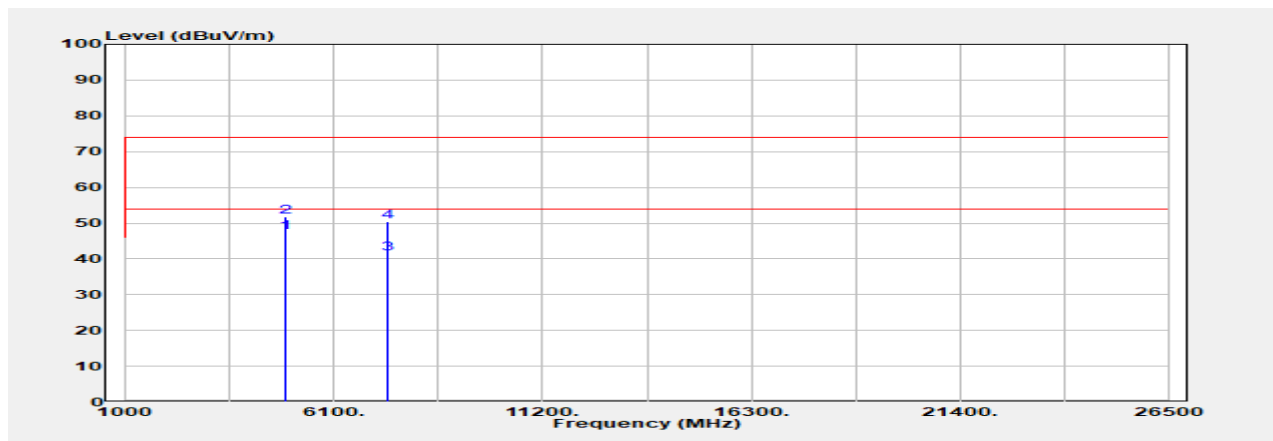

Freq. MHz	Detector Mode PK/QP/AVG	Spectrum Reading Level dB μ V	Factor dB	Actual FS dB μ V/m	Limit @3m dB μ V/m	Margin dB
4924.000	Average	43.91	3.46	47.37	54.00	-6.63
4924.000	Peak	48.32	3.46	51.78	74.00	-22.22
7386.000	Average	32.34	9.03	41.37	54.00	-12.63
7386.000	Peak	41.48	9.03	50.52	74.00	-23.48

Unless otherwise stated the results shown in this test report refer only to the sample(s) tested and such sample(s) are retained for 90 days only.
 除非另有說明，此報告結果僅對測試之樣品負責，同時此樣品僅保留90天。本報告未經本公司書面許可，不可部份複製。

This document is issued by the Company subject to its General Conditions of Service printed overleaf, available on request or accessible at <http://www.sgs.com.tw/Terms-and-Conditions> and for electronic format documents, subject to Terms and Conditions for Electronic Documents at <http://www.sgs.com.tw/Terms-and-Conditions>. Attention is drawn to the limitation of liability, indemnification and jurisdiction issues defined therein. Any holder of this document is advised that information contained hereon reflects the Company's findings at the time of its intervention only and within the limits of Client's instructions, if any. The Company's sole responsibility is to its Client and this document does not exonerate parties to a transaction from exercising all their rights and obligations under the transaction documents. This document cannot be reproduced except in full, without prior written approval of the Company. Any unauthorized alteration, forgery or falsification of the content or appearance of this document is unlawful and offenders may be prosecuted to the fullest extent of the law.

Report Number :TERF2308001922E2
 Operation Mode :802.11b
 Test Frequency :2462 MHz
 Test Mode :Tx
 EUT Pol :E2 Plane

Test Site :SAC G Chamber
 Test Date :2023-08-23
 Temp./Humi. :23.6°C/59%
 Antenna Pol. :Horizontal
 Engineer :Temo Chen

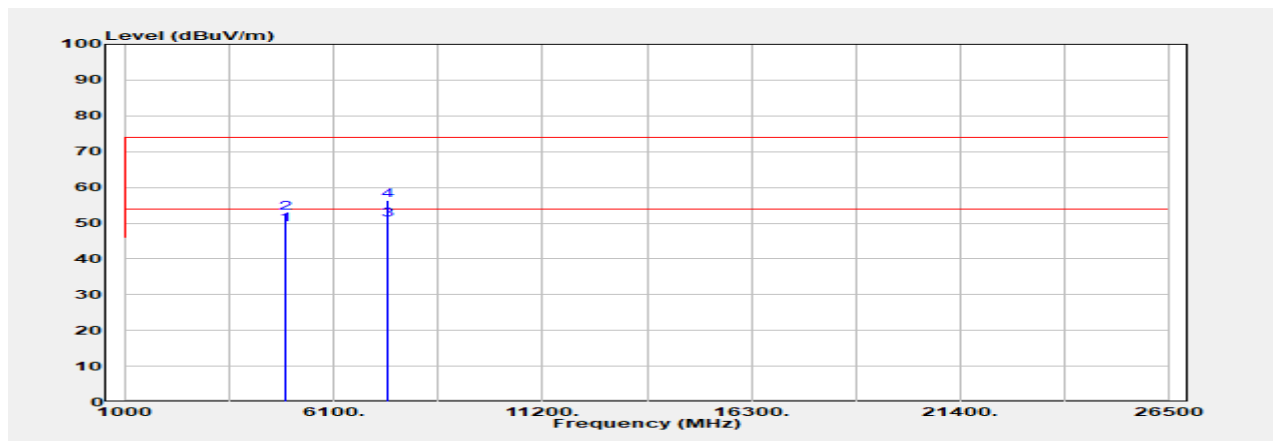

Freq. MHz	Detector Mode PK/QP/AVG	Spectrum Reading Level dB μ V	Factor dB	Actual FS dB μ V/m	Limit @3m dB μ V/m	Margin dB
4924.000	Average	46.14	3.46	49.61	54.00	-4.39
4924.000	Peak	49.37	3.46	52.83	74.00	-21.17
7386.000	Average	41.83	9.03	50.86	54.00	-3.14
7386.000	Peak	47.22	9.03	56.25	74.00	-17.75

Unless otherwise stated the results shown in this test report refer only to the sample(s) tested and such sample(s) are retained for 90 days only.

除非另有說明，此報告結果僅對測試之樣品負責，同時此樣品僅保留90天。本報告未經本公司書面許可，不可部份複製。

This document is issued by the Company subject to its General Conditions of Service printed overleaf, available on request or accessible at <http://www.sgs.com.tw/Terms-and-Conditions> and for electronic format documents, subject to Terms and Conditions for Electronic Documents at <http://www.sgs.com.tw/Terms-and-Conditions>. Attention is drawn to the limitation of liability, indemnification and jurisdiction issues defined therein. Any holder of this document is advised that information contained hereon reflects the Company's findings at the time of its intervention only and within the limits of Client's instructions, if any. The Company's sole responsibility is to its Client and this document does not exonerate parties to a transaction from exercising all their rights and obligations under the transaction documents. This document cannot be reproduced except in full, without prior written approval of the Company. Any unauthorized alteration, forgery or falsification of the content or appearance of this document is unlawful and offenders may be prosecuted to the fullest extent of the law.

Report Number :TERF2308001922E2
 Operation Mode :802.11g
 Test Frequency :2412 MHz
 Test Mode :Tx
 EUT Pol :E2 Plane

Test Site :SAC G Chamber
 Test Date :2023-08-23
 Temp./Humi. :23.6°C/59%
 Antenna Pol. :Vertical
 Engineer :Temo Chen

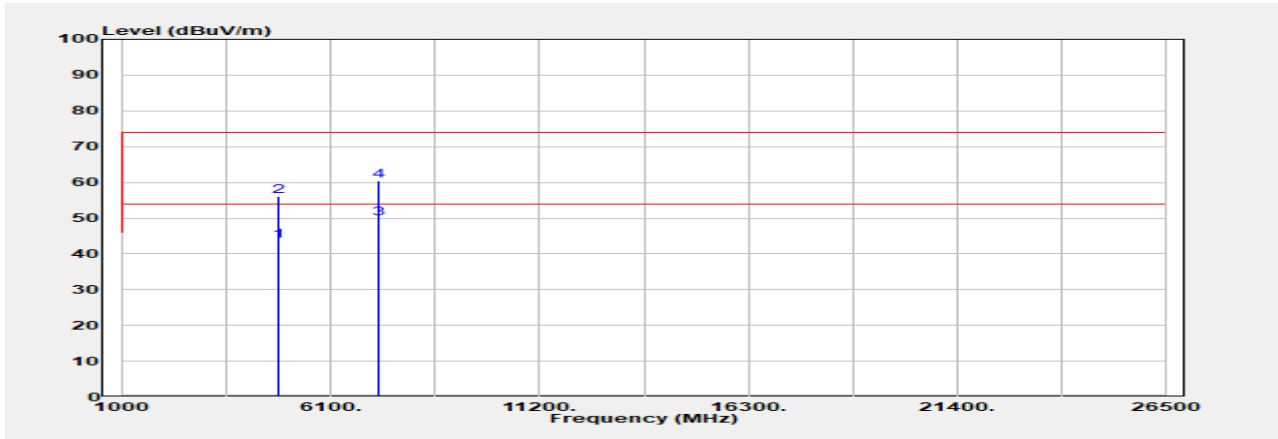

Freq. MHz	Detector Mode PK/QP/AVG	Spectrum Reading Level dB μ V	Factor dB	Actual FS dB μ V/m	Limit @3m dB μ V/m	Margin dB
4824.000	Average	40.32	3.28	43.60	54.00	-10.40
4824.000	Peak	52.71	3.28	55.99	74.00	-18.01
7236.000	Average	41.38	8.54	49.91	54.00	-4.09
7236.000	Peak	51.95	8.54	60.48	74.00	-13.52

Unless otherwise stated the results shown in this test report refer only to the sample(s) tested and such sample(s) are retained for 90 days only.

除非另有說明，此報告結果僅對測試之樣品負責，同時此樣品僅保留90天。本報告未經本公司書面許可，不可部份複製。
 This document is issued by the Company subject to its General Conditions of Service printed overleaf, available on request or accessible at <http://www.sgs.com.tw/Terms-and-Conditions> and for electronic format documents, subject to Terms and Conditions for Electronic Documents at <http://www.sgs.com.tw/Terms-and-Conditions>. Attention is drawn to the limitation of liability, indemnification and jurisdiction issues defined therein. Any holder of this document is advised that information contained hereon reflects the Company's findings at the time of its intervention only and within the limits of Client's instructions, if any. The Company's sole responsibility is to its Client and this document does not exonerate parties to a transaction from exercising all their rights and obligations under the transaction documents. This document cannot be reproduced except in full, without prior written approval of the Company. Any unauthorized alteration, forgery or falsification of the content or appearance of this document is unlawful and offenders may be prosecuted to the fullest extent of the law.

Report Number :TERF2308001922E2
 Operation Mode :802.11g
 Test Frequency :2412 MHz
 Test Mode :Tx
 EUT Pol :E2 Plane

Test Site :SAC G Chamber
 Test Date :2023-08-23
 Temp./Humi. :23.6°C/59%
 Antenna Pol. :Horizontal
 Engineer :Temo Chen

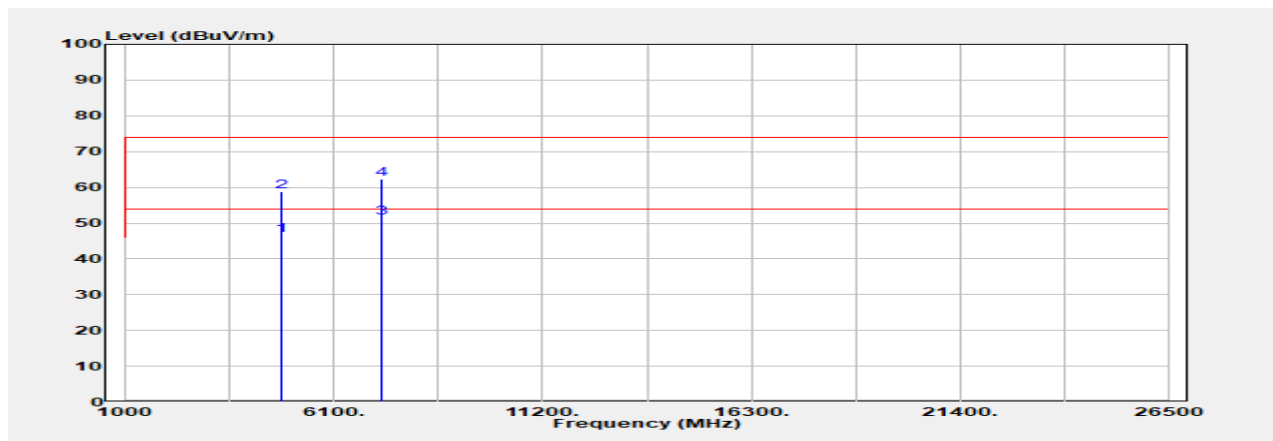

Freq. MHz	Detector Mode PK/QP/AVG	Spectrum Reading Level dBµV	Factor dB	Actual FS dBUV/m	Limit @3m dBUV/m	Margin dB
4824.000	Average	43.36	3.28	46.64	54.00	-7.36
4824.000	Peak	55.43	3.28	58.71	74.00	-15.29
7236.000	Average	42.97	8.54	51.51	54.00	-2.49
7236.000	Peak	53.67	8.54	62.21	74.00	-11.79

Unless otherwise stated the results shown in this test report refer only to the sample(s) tested and such sample(s) are retained for 90 days only.

除非另有說明，此報告結果僅對測試之樣品負責，同時此樣品僅保留90天。本報告未經本公司書面許可，不可部份複製。
 This document is issued by the Company subject to its General Conditions of Service printed overleaf, available on request or accessible at <http://www.sgs.com.tw/Terms-and-Conditions> and for electronic format documents, subject to Terms and Conditions for Electronic Documents at <http://www.sgs.com.tw/Terms-and-Conditions>. Attention is drawn to the limitation of liability, indemnification and jurisdiction issues defined therein. Any holder of this document is advised that information contained hereon reflects the Company's findings at the time of its intervention only and within the limits of Client's instructions, if any. The Company's sole responsibility is to its Client and this document does not exonerate parties to a transaction from exercising all their rights and obligations under the transaction documents. This document cannot be reproduced except in full, without prior written approval of the Company. Any unauthorized alteration, forgery or falsification of the content or appearance of this document is unlawful and offenders may be prosecuted to the fullest extent of the law.

Report Number :TERF2308001922E2
 Operation Mode :802.11g
 Test Frequency :2437 MHz
 Test Mode :Tx
 EUT Pol :E2 Plane

Test Site :SAC G Chamber
 Test Date :2023-08-23
 Temp./Humi. :23.6°C/59%
 Antenna Pol. :Vertical
 Engineer :Temo Chen

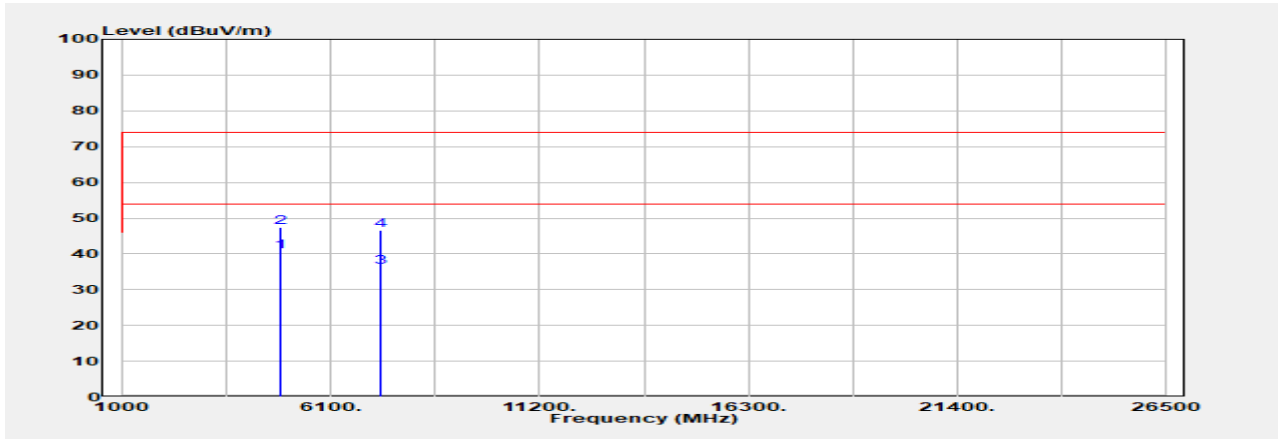

Freq. MHz	Detector Mode PK/QP/AVG	Spectrum Reading Level dBμV	Factor dB	Actual FS dBμV/m	Limit @3m dBμV/m	Margin dB
4874.000	Average	37.28	3.35	40.63	54.00	-13.37
4874.000	Peak	44.09	3.35	47.44	74.00	-26.56
7311.000	Average	27.80	8.58	36.38	54.00	-17.62
7311.000	Peak	38.08	8.58	46.65	74.00	-27.35

Unless otherwise stated the results shown in this test report refer only to the sample(s) tested and such sample(s) are retained for 90 days only.

除非另有說明，此報告結果僅對測試之樣品負責，同時此樣品僅保留90天。本報告未經本公司書面許可，不可部份複製。
 This document is issued by the Company subject to its General Conditions of Service printed overleaf, available on request or accessible at <http://www.sgs.com.tw/Terms-and-Conditions> and for electronic format documents, subject to Terms and Conditions for Electronic Documents at <http://www.sgs.com.tw/Terms-and-Conditions>. Attention is drawn to the limitation of liability, indemnification and jurisdiction issues defined therein. Any holder of this document is advised that information contained hereon reflects the Company's findings at the time of its intervention only and within the limits of Client's instructions, if any. The Company's sole responsibility is to its Client and this document does not exonerate parties to a transaction from exercising all their rights and obligations under the transaction documents. This document cannot be reproduced except in full, without prior written approval of the Company. Any unauthorized alteration, forgery or falsification of the content or appearance of this document is unlawful and offenders may be prosecuted to the fullest extent of the law.

Report Number :TERF2308001922E2
 Operation Mode :802.11g
 Test Frequency :2437 MHz
 Test Mode :Tx
 EUT Pol :E2 Plane

Test Site :SAC G Chamber
 Test Date :2023-08-23
 Temp./Humi. :23.6°C/59%
 Antenna Pol. :Horizontal
 Engineer :Temo Chen

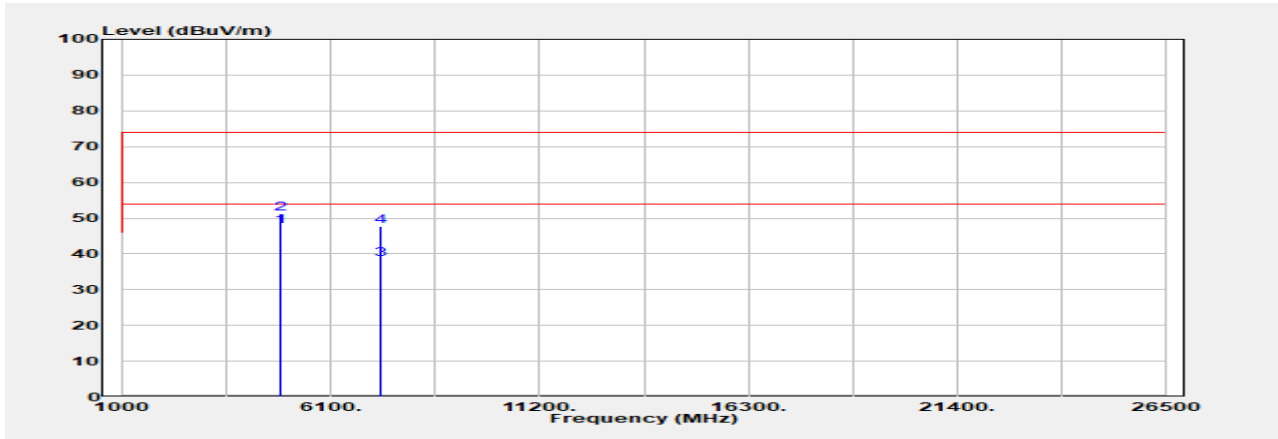

Freq. MHz	Detector Mode PK/QP/AVG	Spectrum Reading Level dB μ V	Factor dB	Actual FS dB μ V/m	Limit @3m dB μ V/m	Margin dB
4874.000	Average	44.34	3.35	47.69	54.00	-6.31
4874.000	Peak	47.98	3.35	51.33	74.00	-22.67
7311.000	Average	29.94	8.58	38.52	54.00	-15.48
7311.000	Peak	38.99	8.58	47.57	74.00	-26.43

Unless otherwise stated the results shown in this test report refer only to the sample(s) tested and such sample(s) are retained for 90 days only.

除非另有說明，此報告結果僅對測試之樣品負責，同時此樣品僅保留90天。本報告未經本公司書面許可，不可部份複製。
 This document is issued by the Company subject to its General Conditions of Service printed overleaf, available on request or accessible at <http://www.sgs.com.tw/Terms-and-Conditions> and for electronic format documents, subject to Terms and Conditions for Electronic Documents at <http://www.sgs.com.tw/Terms-and-Conditions>. Attention is drawn to the limitation of liability, indemnification and jurisdiction issues defined therein. Any holder of this document is advised that information contained hereon reflects the Company's findings at the time of its intervention only and within the limits of Client's instructions, if any. The Company's sole responsibility is to its Client and this document does not exonerate parties to a transaction from exercising all their rights and obligations under the transaction documents. This document cannot be reproduced except in full, without prior written approval of the Company. Any unauthorized alteration, forgery or falsification of the content or appearance of this document is unlawful and offenders may be prosecuted to the fullest extent of the law.

Report Number :TERF2308001922E2
 Operation Mode :802.11g
 Test Frequency :2462 MHz
 Test Mode :Tx
 EUT Pol :E2 Plane

Test Site :SAC G Chamber
 Test Date :2023-08-23
 Temp./Humi. :23.6°C/59%
 Antenna Pol. :Vertical
 Engineer :Temo Chen

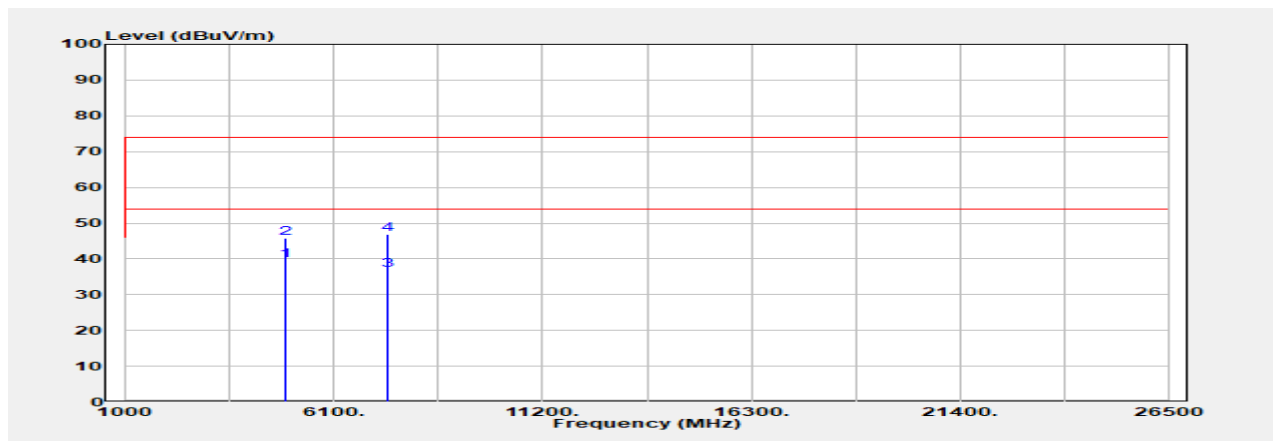

Freq. MHz	Detector Mode PK/QP/AVG	Spectrum Reading Level dB μ V	Factor dB	Actual FS dB μ V/m	Limit @3m dB μ V/m	Margin dB
4924.000	Average	36.06	3.46	39.53	54.00	-14.47
4924.000	Peak	42.37	3.46	45.83	74.00	-28.17
7386.000	Average	27.96	9.03	36.99	54.00	-17.01
7386.000	Peak	37.89	9.03	46.92	74.00	-27.08

Unless otherwise stated the results shown in this test report refer only to the sample(s) tested and such sample(s) are retained for 90 days only.
 除非另有說明，此報告結果僅對測試之樣品負責，同時此樣品僅保留90天。本報告未經本公司書面許可，不可部份複製。

This document is issued by the Company subject to its General Conditions of Service printed overleaf, available on request or accessible at <http://www.sgs.com.tw/Terms-and-Conditions> and for electronic format documents, subject to Terms and Conditions for Electronic Documents at <http://www.sgs.com.tw/Terms-and-Conditions>. Attention is drawn to the limitation of liability, indemnification and jurisdiction issues defined therein. Any holder of this document is advised that information contained hereon reflects the Company's findings at the time of its intervention only and within the limits of Client's instructions, if any. The Company's sole responsibility is to its Client and this document does not exonerate parties to a transaction from exercising all their rights and obligations under the transaction documents. This document cannot be reproduced except in full, without prior written approval of the Company. Any unauthorized alteration, forgery or falsification of the content or appearance of this document is unlawful and offenders may be prosecuted to the fullest extent of the law.

Report Number :TERF2308001922E2
 Operation Mode :802.11g
 Test Frequency :2462 MHz
 Test Mode :Tx
 EUT Pol :E2 Plane

Test Site :SAC G Chamber
 Test Date :2023-08-23
 Temp./Humi. :23.6°C/59%
 Antenna Pol. :Horizontal
 Engineer :Temo Chen

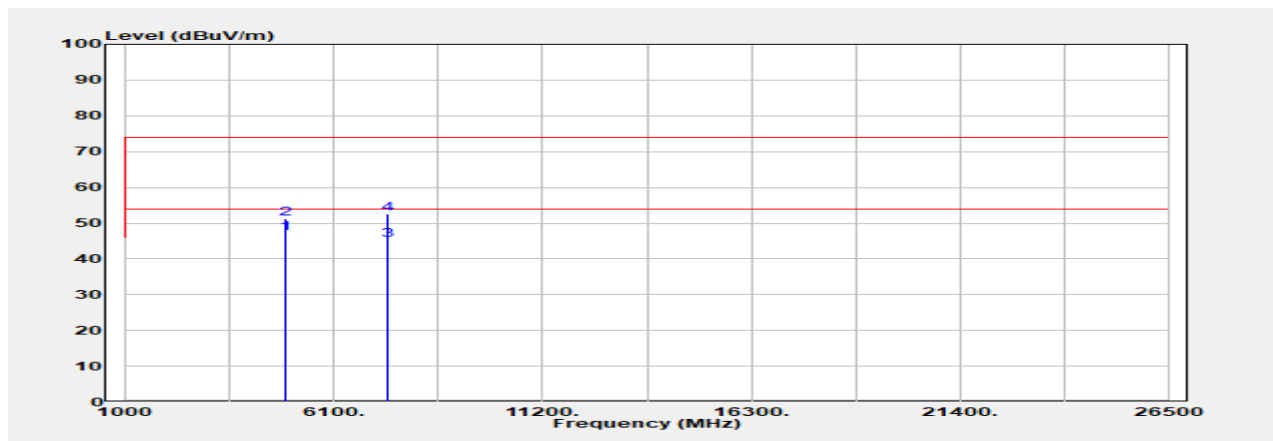

Freq. MHz	Detector Mode PK/QP/AVG	Spectrum Reading Level dBµV	Factor dB	Actual FS dBµV/m	Limit @3m dBµV/m	Margin dB
4924.000	Average	43.71	3.46	47.18	54.00	-6.82
4924.000	Peak	47.72	3.46	51.18	74.00	-22.82
7386.000	Average	36.22	9.03	45.25	54.00	-8.75
7386.000	Peak	43.64	9.03	52.67	74.00	-21.33

Unless otherwise stated the results shown in this test report refer only to the sample(s) tested and such sample(s) are retained for 90 days only.

除非另有說明，此報告結果僅對測試之樣品負責，同時此樣品僅保留90天。本報告未經本公司書面許可，不可部份複製。

This document is issued by the Company subject to its General Conditions of Service printed overleaf, available on request or accessible at <http://www.sgs.com.tw/Terms-and-Conditions> and for electronic format documents, subject to Terms and Conditions for Electronic Documents at <http://www.sgs.com.tw/Terms-and-Conditions>. Attention is drawn to the limitation of liability, indemnification and jurisdiction issues defined therein. Any holder of this document is advised that information contained hereon reflects the Company's findings at the time of its intervention only and within the limits of Client's instructions, if any. The Company's sole responsibility is to its Client and this document does not exonerate parties to a transaction from exercising all their rights and obligations under the transaction documents. This document cannot be reproduced except in full, without prior written approval of the Company. Any unauthorized alteration, forgery or falsification of the content or appearance of this document is unlawful and offenders may be prosecuted to the fullest extent of the law.

Report Number :TERF2308001922E2
 Operation Mode :802.11n20
 Test Frequency :2412 MHz
 Test Mode :Tx
 EUT Pol :E2 Plane

Test Site :SAC G Chamber
 Test Date :2023-08-23
 Temp./Humi. :23.6°C/59%
 Antenna Pol. :Vertical
 Engineer :Temo Chen

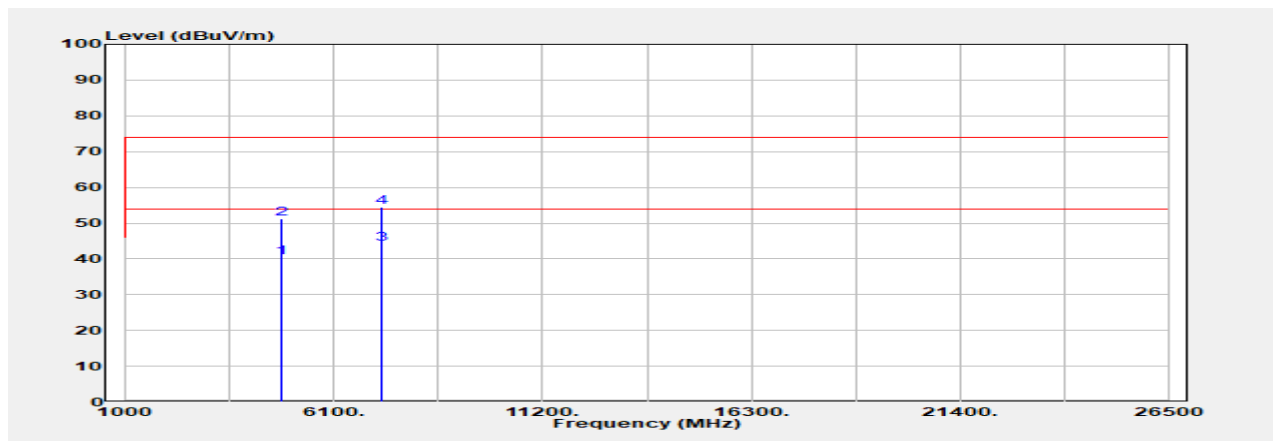

Freq. MHz	Detector Mode PK/QP/AVG	Spectrum Reading Level dB μ V	Factor dB	Actual FS dB μ V/m	Limit @3m dB μ V/m	Margin dB
4824.000	Average	37.00	3.28	40.29	54.00	-13.71
4824.000	Peak	47.87	3.28	51.16	74.00	-22.84
7236.000	Average	35.68	8.54	44.22	54.00	-9.78
7236.000	Peak	45.91	8.54	54.44	74.00	-19.56

Unless otherwise stated the results shown in this test report refer only to the sample(s) tested and such sample(s) are retained for 90 days only.

除非另有說明，此報告結果僅對測試之樣品負責，同時此樣品僅保留90天。本報告未經本公司書面許可，不可部份複製。

This document is issued by the Company subject to its General Conditions of Service printed overleaf, available on request or accessible at <http://www.sgs.com.tw/Terms-and-Conditions> and for electronic format documents, subject to Terms and Conditions for Electronic Documents at <http://www.sgs.com.tw/Terms-and-Conditions>. Attention is drawn to the limitation of liability, indemnification and jurisdiction issues defined therein. Any holder of this document is advised that information contained hereon reflects the Company's findings at the time of its intervention only and within the limits of Client's instructions, if any. The Company's sole responsibility is to its Client and this document does not exonerate parties to a transaction from exercising all their rights and obligations under the transaction documents. This document cannot be reproduced except in full, without prior written approval of the Company. Any unauthorized alteration, forgery or falsification of the content or appearance of this document is unlawful and offenders may be prosecuted to the fullest extent of the law.

Report Number :TERF2308001922E2
 Operation Mode :802.11n20
 Test Frequency :2412 MHz
 Test Mode :Tx
 EUT Pol :E2 Plane

Test Site :SAC G Chamber
 Test Date :2023-08-23
 Temp./Humi. :23.6°C/59%
 Antenna Pol. :Horizontal
 Engineer :Temo Chen

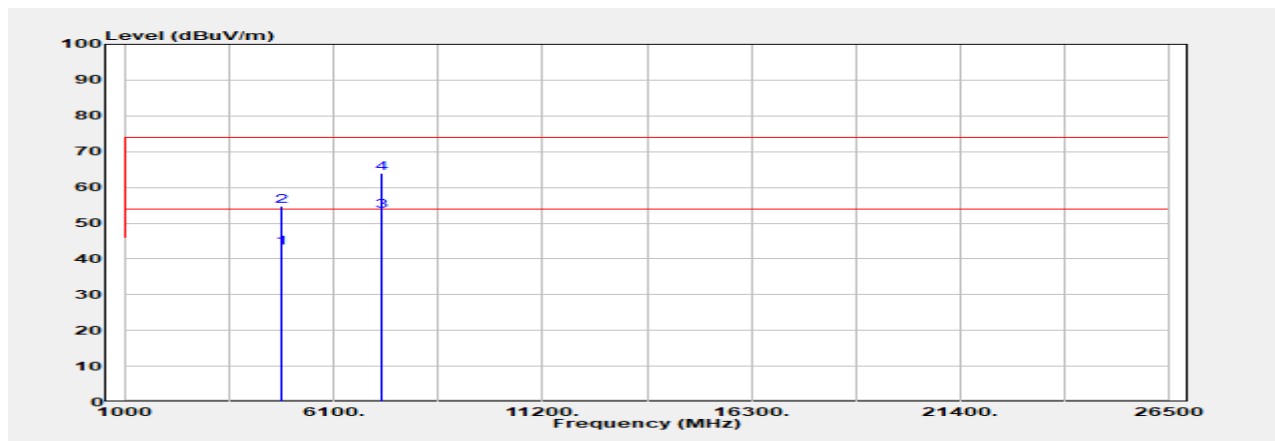

Freq. MHz	Detector Mode PK/QP/AVG	Spectrum Reading Level dBµV	Factor dB	Actual FS dBUV/m	Limit @3m dBUV/m	Margin dB
4824.000	Average	39.81	3.28	43.10	54.00	-10.90
4824.000	Peak	51.35	3.28	54.63	74.00	-19.37
7236.000	Average	44.91	8.54	53.44	54.00	-0.56
7236.000	Peak	55.46	8.54	64.00	74.00	-10.00

Unless otherwise stated the results shown in this test report refer only to the sample(s) tested and such sample(s) are retained for 90 days only.

除非另有說明，此報告結果僅對測試之樣品負責，同時此樣品僅保留90天。本報告未經本公司書面許可，不可部份複製。
 This document is issued by the Company subject to its General Conditions of Service printed overleaf, available on request or accessible at <http://www.sgs.com.tw/Terms-and-Conditions> and for electronic format documents, subject to Terms and Conditions for Electronic Documents at <http://www.sgs.com.tw/Terms-and-Conditions>. Attention is drawn to the limitation of liability, indemnification and jurisdiction issues defined therein. Any holder of this document is advised that information contained hereon reflects the Company's findings at the time of its intervention only and within the limits of Client's instructions, if any. The Company's sole responsibility is to its Client and this document does not exonerate parties to a transaction from exercising all their rights and obligations under the transaction documents. This document cannot be reproduced except in full, without prior written approval of the Company. Any unauthorized alteration, forgery or falsification of the content or appearance of this document is unlawful and offenders may be prosecuted to the fullest extent of the law.

Report Number :TERF2308001922E2
 Operation Mode :802.11n20
 Test Frequency :2437 MHz
 Test Mode :Tx
 EUT Pol :E2 Plane

Test Site :SAC G Chamber
 Test Date :2023-08-23
 Temp./Humi. :23.6°C/59%
 Antenna Pol. :Vertical
 Engineer :Temo Chen

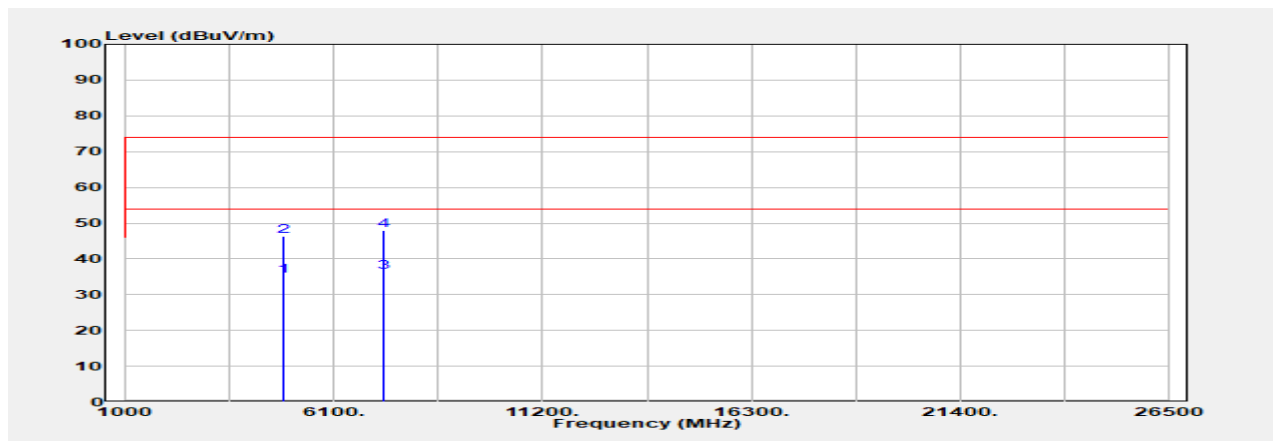

Freq. MHz	Detector Mode PK/QP/AVG	Spectrum Reading Level dB μ V	Factor dB	Actual FS dB μ V/m	Limit @3m dB μ V/m	Margin dB
4874.000	Average	31.95	3.35	35.31	54.00	-18.69
4874.000	Peak	42.89	3.35	46.24	74.00	-27.76
7311.000	Average	27.72	8.58	36.30	54.00	-17.70
7311.000	Peak	39.51	8.58	48.09	74.00	-25.91

Unless otherwise stated the results shown in this test report refer only to the sample(s) tested and such sample(s) are retained for 90 days only.
 除非另有說明，此報告結果僅對測試之樣品負責，同時此樣品僅保留90天。本報告未經本公司書面許可，不可部份複製。

This document is issued by the Company subject to its General Conditions of Service printed overleaf, available on request or accessible at <http://www.sgs.com.tw/Terms-and-Conditions> and for electronic format documents, subject to Terms and Conditions for Electronic Documents at <http://www.sgs.com.tw/Terms-and-Conditions>. Attention is drawn to the limitation of liability, indemnification and jurisdiction issues defined therein. Any holder of this document is advised that information contained hereon reflects the Company's findings at the time of its intervention only and within the limits of Client's instructions, if any. The Company's sole responsibility is to its Client and this document does not exonerate parties to a transaction from exercising all their rights and obligations under the transaction documents. This document cannot be reproduced except in full, without prior written approval of the Company. Any unauthorized alteration, forgery or falsification of the content or appearance of this document is unlawful and offenders may be prosecuted to the fullest extent of the law.

Report Number :TERF2308001922E2
 Operation Mode :802.11n20
 Test Frequency :2437 MHz
 Test Mode :Tx
 EUT Pol :E2 Plane

Test Site :SAC G Chamber
 Test Date :2023-08-23
 Temp./Humi. :23.6°C/59%
 Antenna Pol. :Horizontal
 Engineer :Temo Chen

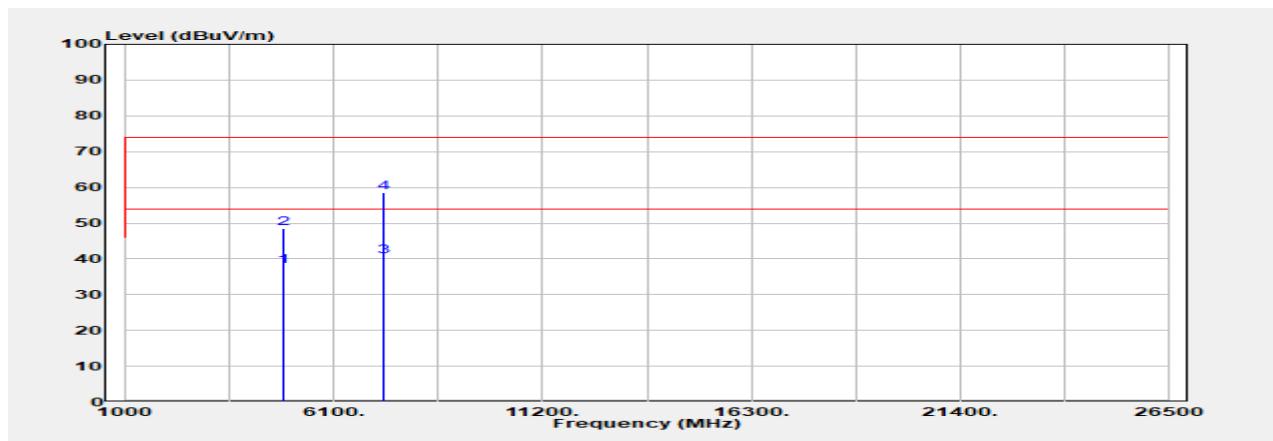

Freq. MHz	Detector Mode PK/QP/AVG	Spectrum Reading Level dB μ V	Factor dB	Actual FS dB μ V/m	Limit @3m dB μ V/m	Margin dB
4874.000	Average	34.65	3.35	38.00	54.00	-16.00
4874.000	Peak	45.09	3.35	48.44	74.00	-25.56
7311.000	Average	31.98	8.58	40.55	54.00	-13.45
7311.000	Peak	49.87	8.58	58.45	74.00	-15.55

Unless otherwise stated the results shown in this test report refer only to the sample(s) tested and such sample(s) are retained for 90 days only.

除非另有說明，此報告結果僅對測試之樣品負責，同時此樣品僅保留90天。本報告未經本公司書面許可，不可部份複製。

This document is issued by the Company subject to its General Conditions of Service printed overleaf, available on request or accessible at <http://www.sgs.com.tw/Terms-and-Conditions> and for electronic format documents, subject to Terms and Conditions for Electronic Documents at <http://www.sgs.com.tw/Terms-and-Conditions>. Attention is drawn to the limitation of liability, indemnification and jurisdiction issues defined therein. Any holder of this document is advised that information contained hereon reflects the Company's findings at the time of its intervention only and within the limits of Client's instructions, if any. The Company's sole responsibility is to its Client and this document does not exonerate parties to a transaction from exercising all their rights and obligations under the transaction documents. This document cannot be reproduced except in full, without prior written approval of the Company. Any unauthorized alteration, forgery or falsification of the content or appearance of this document is unlawful and offenders may be prosecuted to the fullest extent of the law.

Report Number :TERF2308001922E2
 Operation Mode :802.11n20
 Test Frequency :2462 MHz
 Test Mode :Tx
 EUT Pol :E2 Plane

Test Site :SAC G Chamber
 Test Date :2023-08-23
 Temp./Humi. :23.6°C/59%
 Antenna Pol. :Vertical
 Engineer :Temo Chen

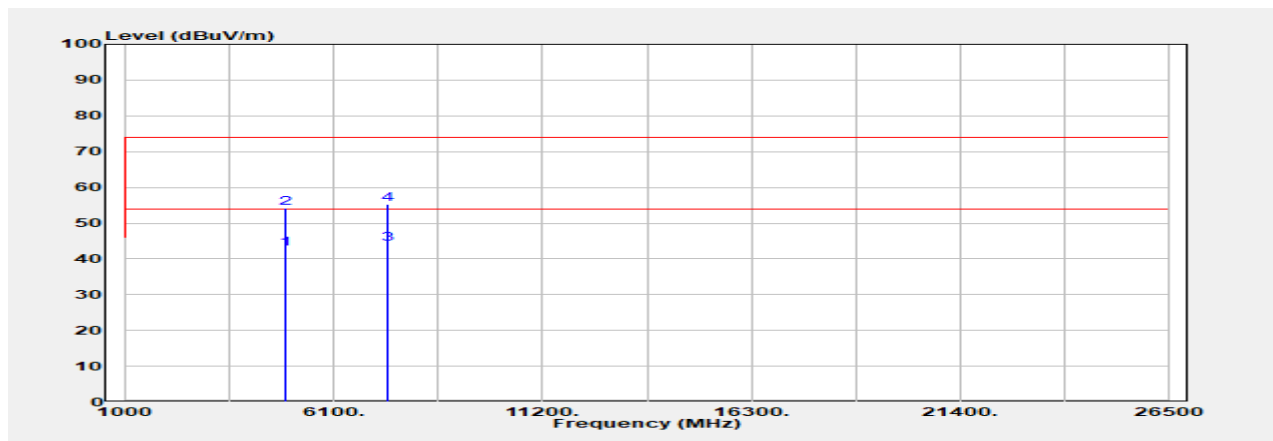

Freq. MHz	Detector Mode PK/QP/AVG	Spectrum Reading Level dB μ V	Factor dB	Actual FS dB μ V/m	Limit @3m dB μ V/m	Margin dB
4924.000	Average	39.38	3.46	42.84	54.00	-11.16
4924.000	Peak	50.70	3.46	54.17	74.00	-19.83
7386.000	Average	35.15	9.03	44.18	54.00	-9.82
7386.000	Peak	46.37	9.03	55.40	74.00	-18.60

Unless otherwise stated the results shown in this test report refer only to the sample(s) tested and such sample(s) are retained for 90 days only.

除非另有說明，此報告結果僅對測試之樣品負責，同時此樣品僅保留90天。本報告未經本公司書面許可，不可部份複製。
 This document is issued by the Company subject to its General Conditions of Service printed overleaf, available on request or accessible at <http://www.sgs.com.tw/Terms-and-Conditions> and for electronic format documents, subject to Terms and Conditions for Electronic Documents at <http://www.sgs.com.tw/Terms-and-Conditions>. Attention is drawn to the limitation of liability, indemnification and jurisdiction issues defined therein. Any holder of this document is advised that information contained hereon reflects the Company's findings at the time of its intervention only and within the limits of Client's instructions, if any. The Company's sole responsibility is to its Client and this document does not exonerate parties to a transaction from exercising all their rights and obligations under the transaction documents. This document cannot be reproduced except in full, without prior written approval of the Company. Any unauthorized alteration, forgery or falsification of the content or appearance of this document is unlawful and offenders may be prosecuted to the fullest extent of the law.

Report Number :TERF2308001922E2
 Operation Mode :802.11n20
 Test Frequency :2462 MHz
 Test Mode :Tx
 EUT Pol :E2 Plane

Test Site :SAC G Chamber
 Test Date :2023-08-23
 Temp./Humi. :23.6°C/59%
 Antenna Pol. :Horizontal
 Engineer :Temo Chen

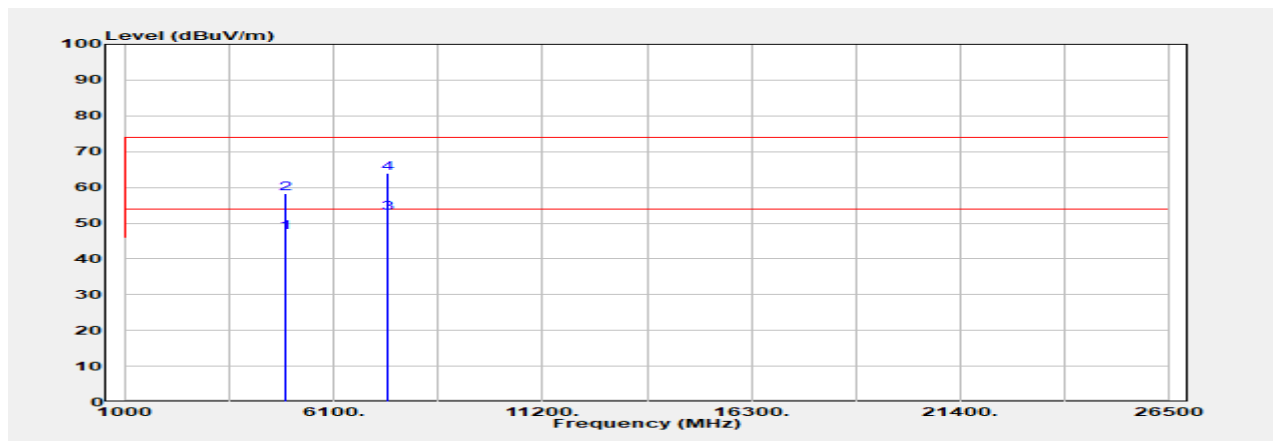

Freq. MHz	Detector Mode PK/QP/AVG	Spectrum Reading Level dB μ V	Factor dB	Actual FS dB μ V/m	Limit @3m dB μ V/m	Margin dB
4924.000	Average	43.92	3.46	47.38	54.00	-6.62
4924.000	Peak	54.71	3.46	58.18	74.00	-15.82
7386.000	Average	43.88	9.03	52.91	54.00	-1.09
7386.000	Peak	54.88	9.03	63.91	74.00	-10.09

Unless otherwise stated the results shown in this test report refer only to the sample(s) tested and such sample(s) are retained for 90 days only.
 除非另有說明，此報告結果僅對測試之樣品負責，同時此樣品僅保留90天。本報告未經本公司書面許可，不可部份複製。

This document is issued by the Company subject to its General Conditions of Service printed overleaf, available on request or accessible at <http://www.sgs.com.tw/Terms-and-Conditions> and for electronic format documents, subject to Terms and Conditions for Electronic Documents at <http://www.sgs.com.tw/Terms-and-Conditions>. Attention is drawn to the limitation of liability, indemnification and jurisdiction issues defined therein. Any holder of this document is advised that information contained hereon reflects the Company's findings at the time of its intervention only and within the limits of Client's instructions, if any. The Company's sole responsibility is to its Client and this document does not exonerate parties to a transaction from exercising all their rights and obligations under the transaction documents. This document cannot be reproduced except in full, without prior written approval of the Company. Any unauthorized alteration, forgery or falsification of the content or appearance of this document is unlawful and offenders may be prosecuted to the fullest extent of the law.

Report Number :TERF2308001922E2
 Operation Mode :802.11n40
 Test Frequency :2422 MHz
 Test Mode :Tx
 EUT Pol :E2 Plane

Test Site :SAC G Chamber
 Test Date :2023-08-23
 Temp./Humi. :23.6°C/59%
 Antenna Pol. :Vertical
 Engineer :Temo Chen

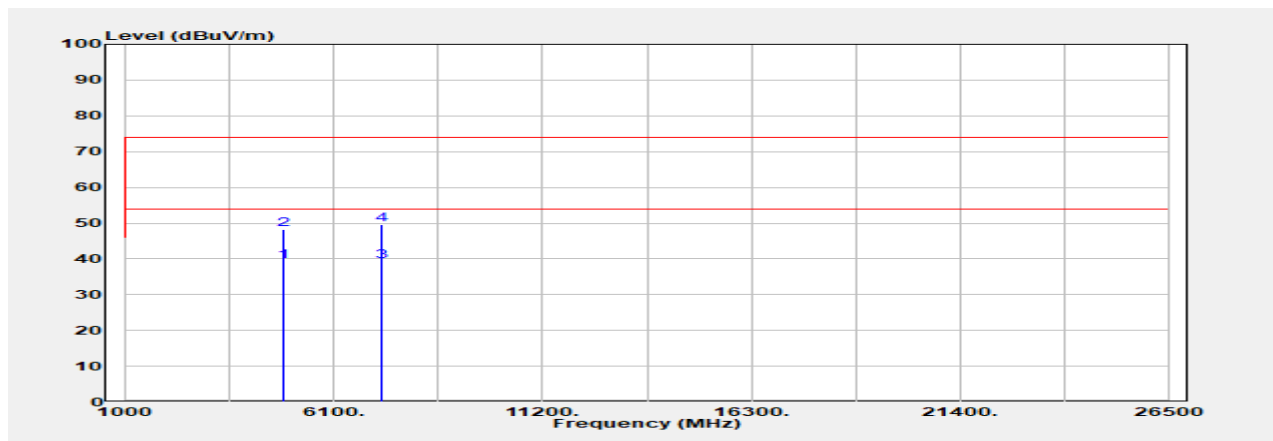

Freq. MHz	Detector Mode PK/QP/AVG	Spectrum Reading Level dB μ V	Factor dB	Actual FS dB μ V/m	Limit @3m dB μ V/m	Margin dB
4844.000	Average	36.06	3.31	39.37	54.00	-14.63
4844.000	Peak	44.86	3.31	48.17	74.00	-25.83
7266.000	Average	30.88	8.53	39.42	54.00	-14.58
7266.000	Peak	41.04	8.53	49.58	74.00	-24.42

Unless otherwise stated the results shown in this test report refer only to the sample(s) tested and such sample(s) are retained for 90 days only.
 除非另有說明，此報告結果僅對測試之樣品負責，同時此樣品僅保留90天。本報告未經本公司書面許可，不可部份複製。

This document is issued by the Company subject to its General Conditions of Service printed overleaf, available on request or accessible at <http://www.sgs.com.tw/Terms-and-Conditions> and for electronic format documents, subject to Terms and Conditions for Electronic Documents at <http://www.sgs.com.tw/Terms-and-Conditions>. Attention is drawn to the limitation of liability, indemnification and jurisdiction issues defined therein. Any holder of this document is advised that information contained hereon reflects the Company's findings at the time of its intervention only and within the limits of Client's instructions, if any. The Company's sole responsibility is to its Client and this document does not exonerate parties to a transaction from exercising all their rights and obligations under the transaction documents. This document cannot be reproduced except in full, without prior written approval of the Company. Any unauthorized alteration, forgery or falsification of the content or appearance of this document is unlawful and offenders may be prosecuted to the fullest extent of the law.

Report Number :TERF2308001922E2
 Operation Mode :802.11n40
 Test Frequency :2422 MHz
 Test Mode :Tx
 EUT Pol :E2 Plane

Test Site :SAC G Chamber
 Test Date :2023-08-23
 Temp./Humi. :23.6°C/59%
 Antenna Pol. :Horizontal
 Engineer :Temo Chen

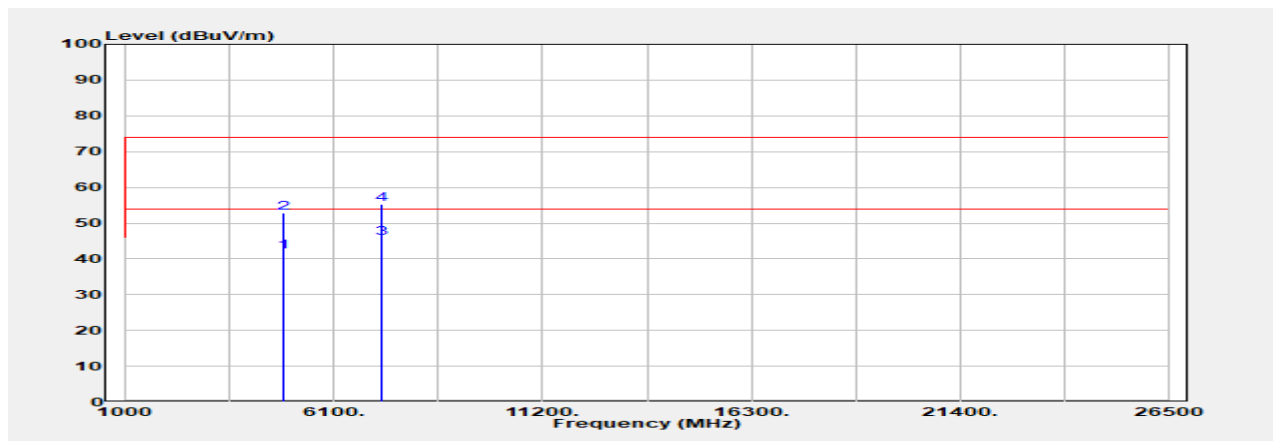

Freq. MHz	Detector Mode PK/QP/AVG	Spectrum Reading Level dB μ V	Factor dB	Actual FS dB μ V/m	Limit @3m dB μ V/m	Margin dB
4844.000	Average	38.80	3.31	42.11	54.00	-11.89
4844.000	Peak	49.50	3.31	52.81	74.00	-21.19
7266.000	Average	37.13	8.53	45.67	54.00	-8.33
7266.000	Peak	46.71	8.53	55.25	74.00	-18.75

Unless otherwise stated the results shown in this test report refer only to the sample(s) tested and such sample(s) are retained for 90 days only.
 除非另有說明，此報告結果僅對測試之樣品負責，同時此樣品僅保留90天。本報告未經本公司書面許可，不可部份複製。

This document is issued by the Company subject to its General Conditions of Service printed overleaf, available on request or accessible at <http://www.sgs.com.tw/Terms-and-Conditions> and for electronic format documents, subject to Terms and Conditions for Electronic Documents at <http://www.sgs.com.tw/Terms-and-Conditions>. Attention is drawn to the limitation of liability, indemnification and jurisdiction issues defined therein. Any holder of this document is advised that information contained hereon reflects the Company's findings at the time of its intervention only and within the limits of Client's instructions, if any. The Company's sole responsibility is to its Client and this document does not exonerate parties to a transaction from exercising all their rights and obligations under the transaction documents. This document cannot be reproduced except in full, without prior written approval of the Company. Any unauthorized alteration, forgery or falsification of the content or appearance of this document is unlawful and offenders may be prosecuted to the fullest extent of the law.

Report Number :TERF2308001922E2
 Operation Mode :802.11n40
 Test Frequency :2437 MHz
 Test Mode :Tx
 EUT Pol :E2 Plane

Test Site :SAC G Chamber
 Test Date :2023-08-23
 Temp./Humi. :23.6°C/59%
 Antenna Pol. :Vertical
 Engineer :Temo Chen

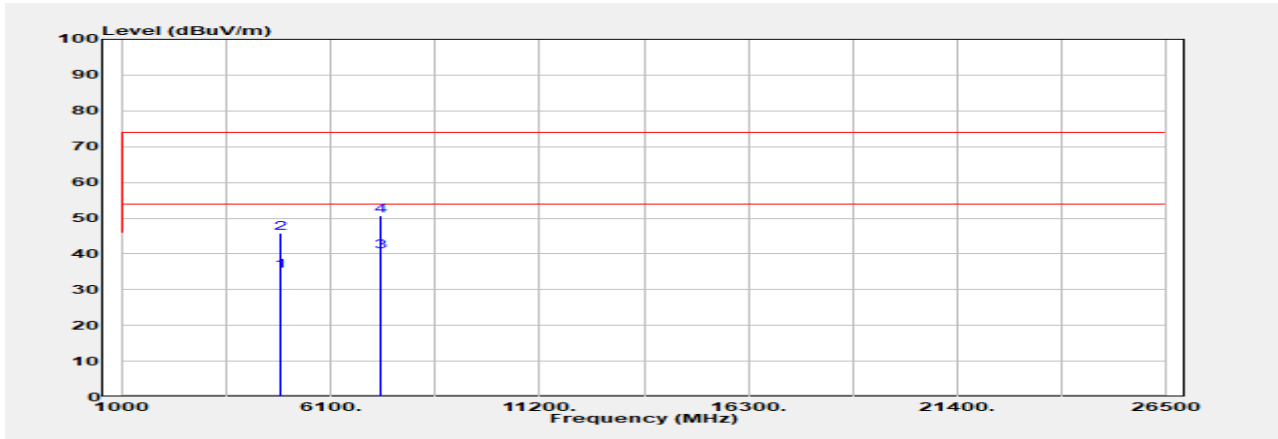

Freq. MHz	Detector Mode PK/QP/AVG	Spectrum Reading Level dBµV	Factor dB	Actual FS dBUV/m	Limit @3m dBUV/m	Margin dB
4874.000	Average	31.97	3.35	35.32	54.00	-18.68
4874.000	Peak	42.51	3.35	45.86	74.00	-28.14
7311.000	Average	32.01	8.58	40.58	54.00	-13.42
7311.000	Peak	42.08	8.58	50.66	74.00	-23.34

Unless otherwise stated the results shown in this test report refer only to the sample(s) tested and such sample(s) are retained for 90 days only.

除非另有說明，此報告結果僅對測試之樣品負責，同時此樣品僅保留90天。本報告未經本公司書面許可，不可部份複製。
 This document is issued by the Company subject to its General Conditions of Service printed overleaf, available on request or accessible at <http://www.sgs.com.tw/Terms-and-Conditions> and for electronic format documents, subject to Terms and Conditions for Electronic Documents at <http://www.sgs.com.tw/Terms-and-Conditions>. Attention is drawn to the limitation of liability, indemnification and jurisdiction issues defined therein. Any holder of this document is advised that information contained hereon reflects the Company's findings at the time of its intervention only and within the limits of Client's instructions, if any. The Company's sole responsibility is to its Client and this document does not exonerate parties to a transaction from exercising all their rights and obligations under the transaction documents. This document cannot be reproduced except in full, without prior written approval of the Company. Any unauthorized alteration, forgery or falsification of the content or appearance of this document is unlawful and offenders may be prosecuted to the fullest extent of the law.

Report Number :TERF2308001922E2
 Operation Mode :802.11n40
 Test Frequency :2437 MHz
 Test Mode :Tx
 EUT Pol :E2 Plane

Test Site :SAC G Chamber
 Test Date :2023-08-23
 Temp./Humi. :23.6°C/59%
 Antenna Pol. :Horizontal
 Engineer :Temo Chen

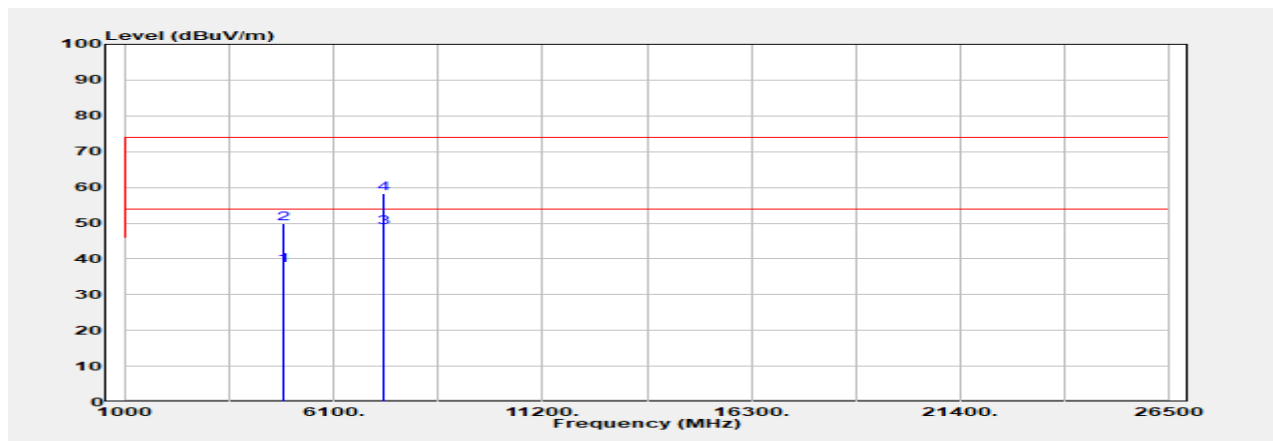

Freq. MHz	Detector Mode PK/QP/AVG	Spectrum Reading Level dBμV	Factor dB	Actual FS dBUV/m	Limit @3m dBUV/m	Margin dB
4874.000	Average	34.79	3.35	38.15	54.00	-15.85
4874.000	Peak	46.53	3.35	49.88	74.00	-24.12
7311.000	Average	40.11	8.58	48.69	54.00	-5.31
7311.000	Peak	49.79	8.58	58.36	74.00	-15.64

Unless otherwise stated the results shown in this test report refer only to the sample(s) tested and such sample(s) are retained for 90 days only.

除非另有說明，此報告結果僅對測試之樣品負責，同時此樣品僅保留90天。本報告未經本公司書面許可，不可部份複製。

This document is issued by the Company subject to its General Conditions of Service printed overleaf, available on request or accessible at <http://www.sgs.com.tw/Terms-and-Conditions> and for electronic format documents, subject to Terms and Conditions for Electronic Documents at <http://www.sgs.com.tw/Terms-and-Conditions>. Attention is drawn to the limitation of liability, indemnification and jurisdiction issues defined therein. Any holder of this document is advised that information contained hereon reflects the Company's findings at the time of its intervention only and within the limits of Client's instructions, if any. The Company's sole responsibility is to its Client and this document does not exonerate parties to a transaction from exercising all their rights and obligations under the transaction documents. This document cannot be reproduced except in full, without prior written approval of the Company. Any unauthorized alteration, forgery or falsification of the content or appearance of this document is unlawful and offenders may be prosecuted to the fullest extent of the law.

Report Number :TERF2308001922E2
 Operation Mode :802.11n40
 Test Frequency :2452 MHz
 Test Mode :Tx
 EUT Pol :E2 Plane

Test Site :SAC G Chamber
 Test Date :2023-08-23
 Temp./Humi. :23.6°C/59%
 Antenna Pol. :Vertical
 Engineer :Temo Chen

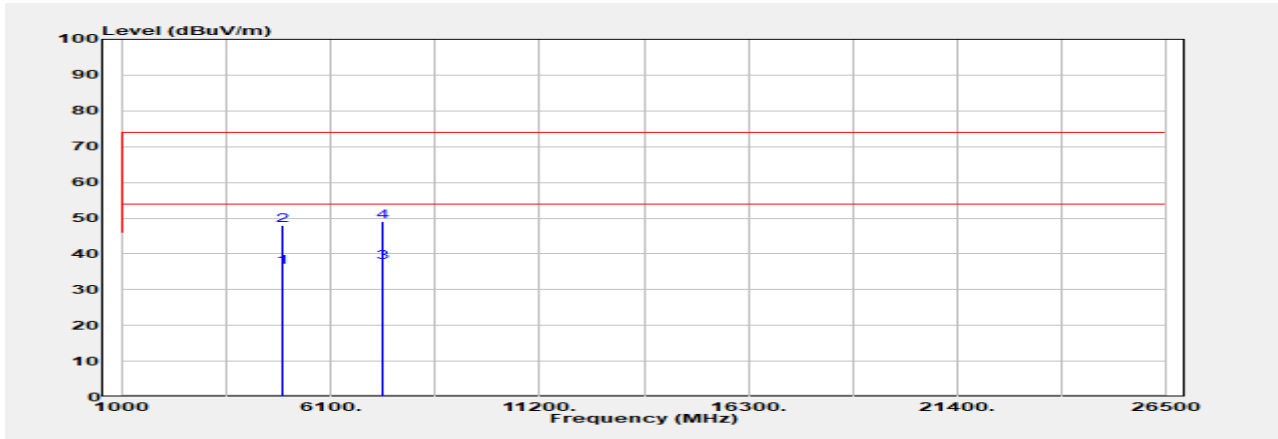

Freq. MHz	Detector Mode PK/QP/AVG	Spectrum Reading Level dBµV	Factor dB	Actual FS dBµV/m	Limit @3m dBµV/m	Margin dB
4904.000	Average	32.95	3.40	36.35	54.00	-17.65
4904.000	Peak	44.68	3.40	48.08	74.00	-25.92
7356.000	Average	28.89	8.88	37.77	54.00	-16.23
7356.000	Peak	40.12	8.88	49.00	74.00	-25.00

Unless otherwise stated the results shown in this test report refer only to the sample(s) tested and such sample(s) are retained for 90 days only.

除非另有說明，此報告結果僅對測試之樣品負責，同時此樣品僅保留90天。本報告未經本公司書面許可，不可部份複製。
 This document is issued by the Company subject to its General Conditions of Service printed overleaf, available on request or accessible at <http://www.sgs.com.tw/Terms-and-Conditions> and for electronic format documents, subject to Terms and Conditions for Electronic Documents at <http://www.sgs.com.tw/Terms-and-Conditions>. Attention is drawn to the limitation of liability, indemnification and jurisdiction issues defined therein. Any holder of this document is advised that information contained hereon reflects the Company's findings at the time of its intervention only and within the limits of Client's instructions, if any. The Company's sole responsibility is to its Client and this document does not exonerate parties to a transaction from exercising all their rights and obligations under the transaction documents. This document cannot be reproduced except in full, without prior written approval of the Company. Any unauthorized alteration, forgery or falsification of the content or appearance of this document is unlawful and offenders may be prosecuted to the fullest extent of the law.

Report Number :TERF2308001922E2
 Operation Mode :802.11n40
 Test Frequency :2452 MHz
 Test Mode :Tx
 EUT Pol :E2 Plane

Test Site :SAC G Chamber
 Test Date :2023-08-23
 Temp./Humi. :23.6°C/59%
 Antenna Pol. :Horizontal
 Engineer :Temo Chen

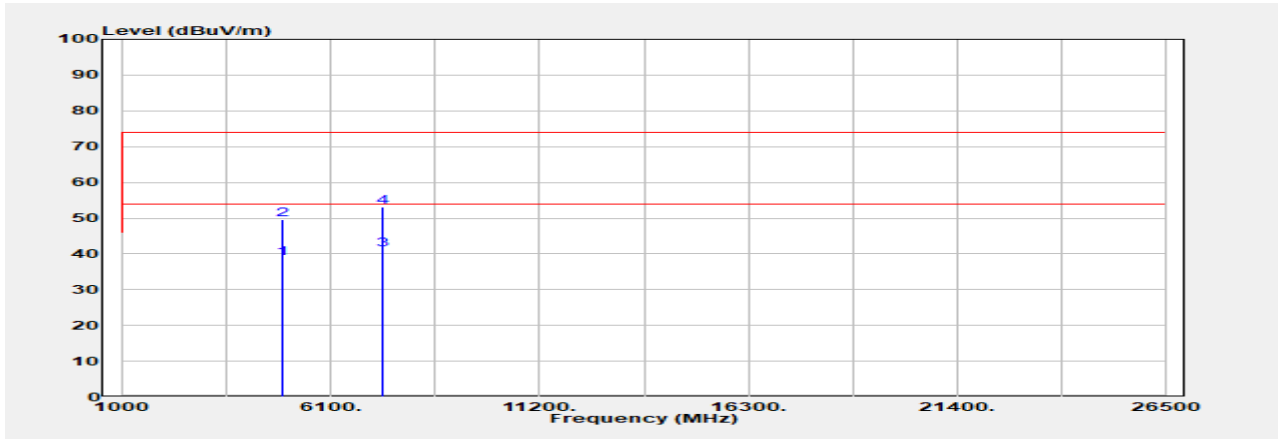

Freq. MHz	Detector Mode PK/QP/AVG	Spectrum Reading Level dB μ V	Factor dB	Actual FS dB μ V/m	Limit @3m dB μ V/m	Margin dB
4904.000	Average	35.41	3.40	38.81	54.00	-15.19
4904.000	Peak	46.32	3.40	49.72	74.00	-24.28
7356.000	Average	32.20	8.88	41.08	54.00	-12.92
7356.000	Peak	44.34	8.88	53.22	74.00	-20.78

Unless otherwise stated the results shown in this test report refer only to the sample(s) tested and such sample(s) are retained for 90 days only.

除非另有說明，此報告結果僅對測試之樣品負責，同時此樣品僅保留90天。本報告未經本公司書面許可，不可部份複製。
 This document is issued by the Company subject to its General Conditions of Service printed overleaf, available on request or accessible at <http://www.sgs.com.tw/Terms-and-Conditions> and for electronic format documents, subject to Terms and Conditions for Electronic Documents at <http://www.sgs.com.tw/Terms-and-Conditions>. Attention is drawn to the limitation of liability, indemnification and jurisdiction issues defined therein. Any holder of this document is advised that information contained hereon reflects the Company's findings at the time of its intervention only and within the limits of Client's instructions, if any. The Company's sole responsibility is to its Client and this document does not exonerate parties to a transaction from exercising all their rights and obligations under the transaction documents. This document cannot be reproduced except in full, without prior written approval of the Company. Any unauthorized alteration, forgery or falsification of the content or appearance of this document is unlawful and offenders may be prosecuted to the fullest extent of the law.

Report Number :TERF2308001922E2
 Operation Mode :802.11be20
 Test Frequency :2412 MHz
 Test Mode :Tx
 EUT Pol :E2 Plane

Test Site :SAC G Chamber
 Test Date :2023-08-23
 Temp./Humi. :23.6°C/59%
 Antenna Pol. :Vertical
 Engineer :Temo Chen

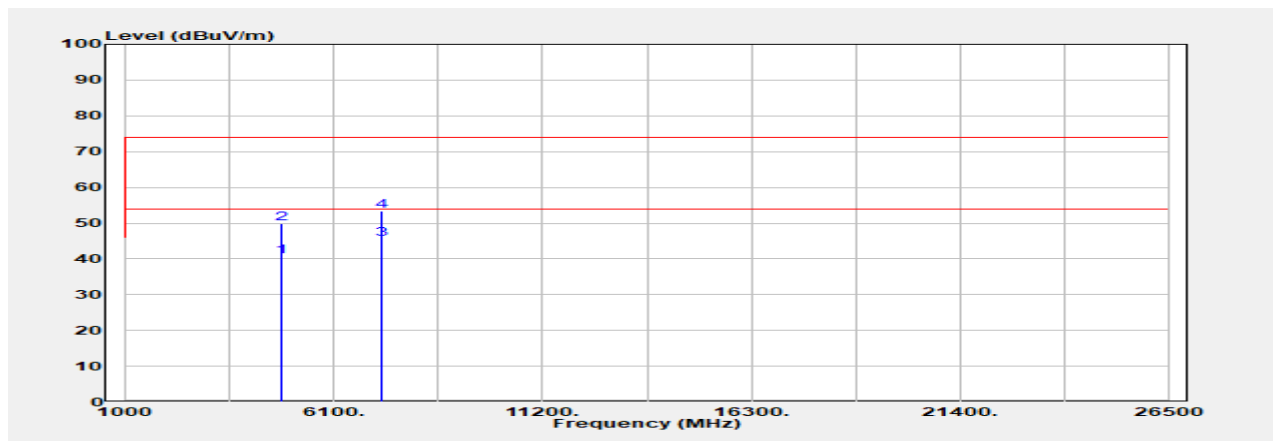

Freq. MHz	Detector Mode PK/QP/AVG	Spectrum Reading Level dB μ V	Factor dB	Actual FS dB μ V/m	Limit @3m dB μ V/m	Margin dB
4824.000	Average	37.37	3.28	40.65	54.00	-13.35
4824.000	Peak	46.52	3.28	49.80	74.00	-24.20
7236.000	Average	36.97	8.54	45.51	54.00	-8.49
7236.000	Peak	44.93	8.54	53.47	74.00	-20.53

Unless otherwise stated the results shown in this test report refer only to the sample(s) tested and such sample(s) are retained for 90 days only.

除非另有說明，此報告結果僅對測試之樣品負責，同時此樣品僅保留90天。本報告未經本公司書面許可，不可部份複製。

This document is issued by the Company subject to its General Conditions of Service printed overleaf, available on request or accessible at <http://www.sgs.com.tw/Terms-and-Conditions> and for electronic format documents, subject to Terms and Conditions for Electronic Documents at <http://www.sgs.com.tw/Terms-and-Conditions>. Attention is drawn to the limitation of liability, indemnification and jurisdiction issues defined therein. Any holder of this document is advised that information contained hereon reflects the Company's findings at the time of its intervention only and within the limits of Client's instructions, if any. The Company's sole responsibility is to its Client and this document does not exonerate parties to a transaction from exercising all their rights and obligations under the transaction documents. This document cannot be reproduced except in full, without prior written approval of the Company. Any unauthorized alteration, forgery or falsification of the content or appearance of this document is unlawful and offenders may be prosecuted to the fullest extent of the law.

Report Number :TERF2308001922E2
 Operation Mode :802.11be20
 Test Frequency :2412 MHz
 Test Mode :Tx
 EUT Pol :E2 Plane

Test Site :SAC G Chamber
 Test Date :2023-08-23
 Temp./Humi. :23.6°C/59%
 Antenna Pol. :Horizontal
 Engineer :Temo Chen

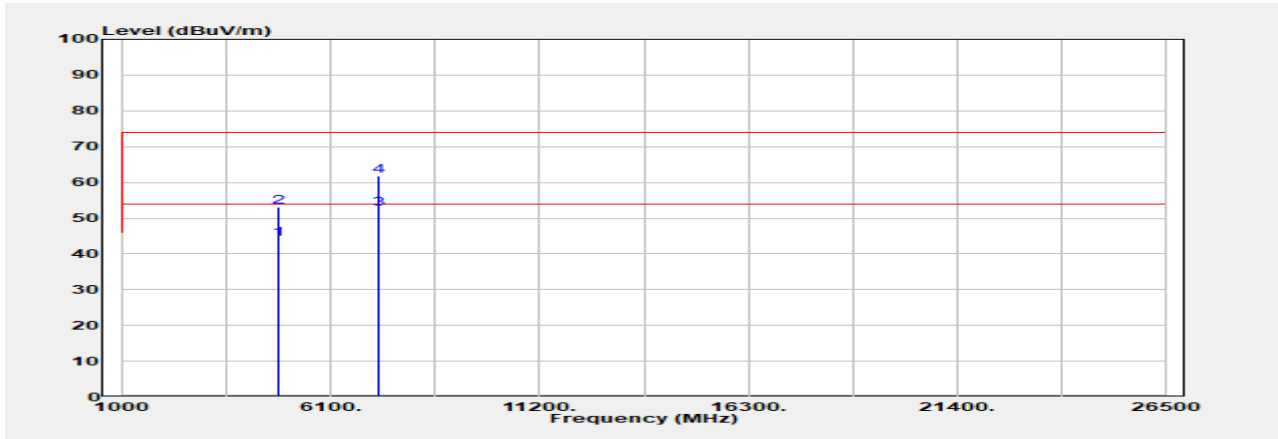

Freq. MHz	Detector Mode PK/QP/AVG	Spectrum Reading Level dBμV	Factor dB	Actual FS dBUV/m	Limit @3m dBUV/m	Margin dB
4824.000	Average	40.86	3.28	44.15	54.00	-9.85
4824.000	Peak	49.73	3.28	53.01	74.00	-20.99
7236.000	Average	44.04	8.54	52.58	54.00	-1.42
7236.000	Peak	53.20	8.54	61.74	74.00	-12.26

Unless otherwise stated the results shown in this test report refer only to the sample(s) tested and such sample(s) are retained for 90 days only.

除非另有說明，此報告結果僅對測試之樣品負責，同時此樣品僅保留90天。本報告未經本公司書面許可，不可部份複製。
 This document is issued by the Company subject to its General Conditions of Service printed overleaf, available on request or accessible at <http://www.sgs.com.tw/Terms-and-Conditions> and for electronic format documents, subject to Terms and Conditions for Electronic Documents at <http://www.sgs.com.tw/Terms-and-Conditions>. Attention is drawn to the limitation of liability, indemnification and jurisdiction issues defined therein. Any holder of this document is advised that information contained hereon reflects the Company's findings at the time of its intervention only and within the limits of Client's instructions, if any. The Company's sole responsibility is to its Client and this document does not exonerate parties to a transaction from exercising all their rights and obligations under the transaction documents. This document cannot be reproduced except in full, without prior written approval of the Company. Any unauthorized alteration, forgery or falsification of the content or appearance of this document is unlawful and offenders may be prosecuted to the fullest extent of the law.

Report Number :TERF2308001922E2
 Operation Mode :802.11be20
 Test Frequency :2437 MHz
 Test Mode :Tx
 EUT Pol :E2 Plane

Test Site :SAC G Chamber
 Test Date :2023-08-23
 Temp./Humi. :23.6°C/59%
 Antenna Pol. :Vertical
 Engineer :Temo Chen

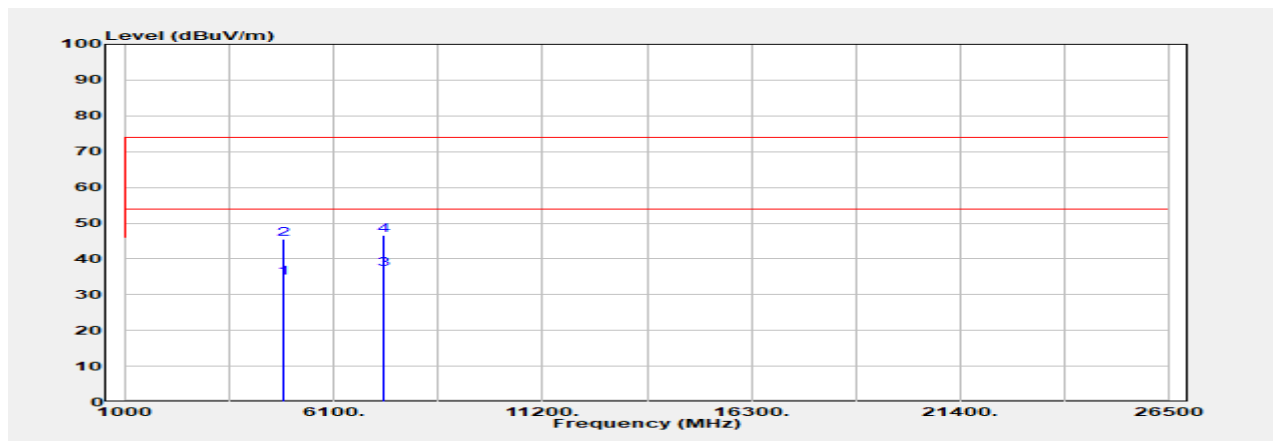

Freq. MHz	Detector Mode PK/QP/AVG	Spectrum Reading Level dB μ V	Factor dB	Actual FS dB μ V/m	Limit @3m dB μ V/m	Margin dB
4874.000	Average	31.38	3.35	34.74	54.00	-19.26
4874.000	Peak	42.10	3.35	45.46	74.00	-28.54
7311.000	Average	28.61	8.58	37.18	54.00	-16.82
7311.000	Peak	38.07	8.58	46.64	74.00	-27.36

Unless otherwise stated the results shown in this test report refer only to the sample(s) tested and such sample(s) are retained for 90 days only.

除非另有說明，此報告結果僅對測試之樣品負責，同時此樣品僅保留90天。本報告未經本公司書面許可，不可部份複製。

This document is issued by the Company subject to its General Conditions of Service printed overleaf, available on request or accessible at <http://www.sgs.com.tw/Terms-and-Conditions> and for electronic format documents, subject to Terms and Conditions for Electronic Documents at <http://www.sgs.com.tw/Terms-and-Conditions>. Attention is drawn to the limitation of liability, indemnification and jurisdiction issues defined therein. Any holder of this document is advised that information contained hereon reflects the Company's findings at the time of its intervention only and within the limits of Client's instructions, if any. The Company's sole responsibility is to its Client and this document does not exonerate parties to a transaction from exercising all their rights and obligations under the transaction documents. This document cannot be reproduced except in full, without prior written approval of the Company. Any unauthorized alteration, forgery or falsification of the content or appearance of this document is unlawful and offenders may be prosecuted to the fullest extent of the law.

Report Number :TERF2308001922E2
 Operation Mode :802.11be20
 Test Frequency :2437 MHz
 Test Mode :Tx
 EUT Pol :E2 Plane

Test Site :SAC G Chamber
 Test Date :2023-08-23
 Temp./Humi. :23.6°C/59%
 Antenna Pol. :Horizontal
 Engineer :Temo Chen

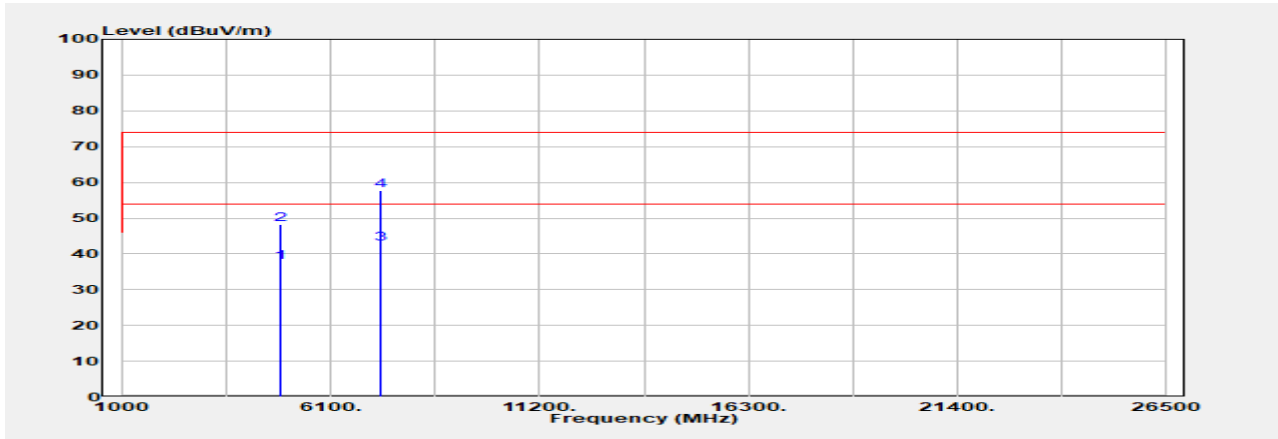

Freq. MHz	Detector Mode PK/QP/AVG	Spectrum Reading Level dB μ V	Factor dB	Actual FS dB μ V/m	Limit @3m dB μ V/m	Margin dB
4874.000	Average	34.30	3.35	37.66	54.00	-16.34
4874.000	Peak	44.89	3.35	48.25	74.00	-25.75
7311.000	Average	34.35	8.58	42.93	54.00	-11.07
7311.000	Peak	49.04	8.58	57.62	74.00	-16.38

Unless otherwise stated the results shown in this test report refer only to the sample(s) tested and such sample(s) are retained for 90 days only.

除非另有說明，此報告結果僅對測試之樣品負責，同時此樣品僅保留90天。本報告未經本公司書面許可，不可部份複製。
 This document is issued by the Company subject to its General Conditions of Service printed overleaf, available on request or accessible at <http://www.sgs.com.tw/Terms-and-Conditions> and for electronic format documents, subject to Terms and Conditions for Electronic Documents at <http://www.sgs.com.tw/Terms-and-Conditions>. Attention is drawn to the limitation of liability, indemnification and jurisdiction issues defined therein. Any holder of this document is advised that information contained hereon reflects the Company's findings at the time of its intervention only and within the limits of Client's instructions, if any. The Company's sole responsibility is to its Client and this document does not exonerate parties to a transaction from exercising all their rights and obligations under the transaction documents. This document cannot be reproduced except in full, without prior written approval of the Company. Any unauthorized alteration, forgery or falsification of the content or appearance of this document is unlawful and offenders may be prosecuted to the fullest extent of the law.

Report Number :TERF2308001922E2
 Operation Mode :802.11be20
 Test Frequency :2462 MHz
 Test Mode :Tx
 EUT Pol :E2 Plane

Test Site :SAC G Chamber
 Test Date :2023-08-23
 Temp./Humi. :23.6°C/59%
 Antenna Pol. :Vertical
 Engineer :Temo Chen

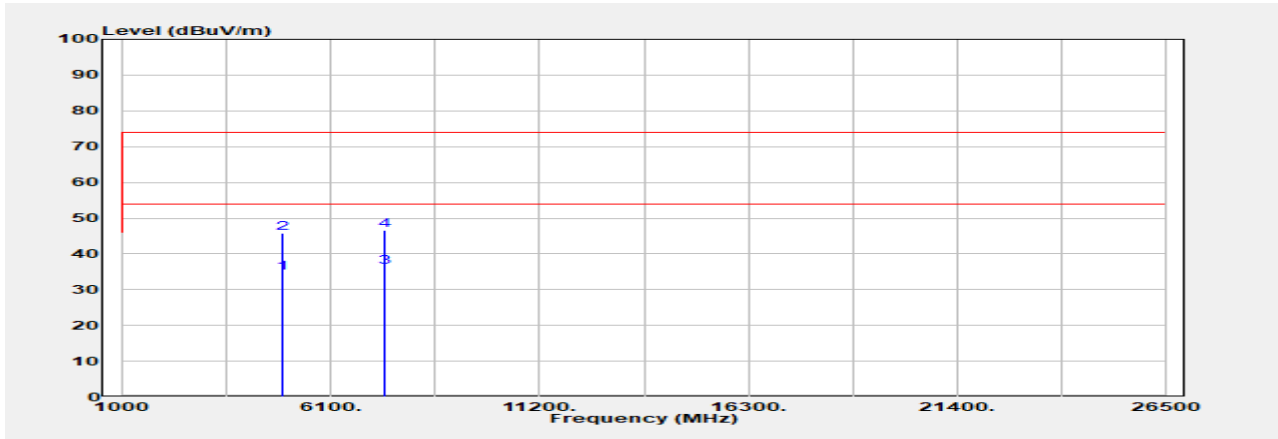

Freq. MHz	Detector Mode PK/QP/AVG	Spectrum Reading Level dB μ V	Factor dB	Actual FS dB μ V/m	Limit @3m dB μ V/m	Margin dB
4924.000	Average	31.20	3.46	34.67	54.00	-19.33
4924.000	Peak	42.33	3.46	45.80	74.00	-28.20
7386.000	Average	27.31	9.03	36.34	54.00	-17.66
7386.000	Peak	37.54	9.03	46.57	74.00	-27.43

Unless otherwise stated the results shown in this test report refer only to the sample(s) tested and such sample(s) are retained for 90 days only.

除非另有說明，此報告結果僅對測試之樣品負責，同時此樣品僅保留90天。本報告未經本公司書面許可，不可部份複製。
 This document is issued by the Company subject to its General Conditions of Service printed overleaf, available on request or accessible at <http://www.sgs.com.tw/Terms-and-Conditions> and for electronic format documents, subject to Terms and Conditions for Electronic Documents at <http://www.sgs.com.tw/Terms-and-Conditions>. Attention is drawn to the limitation of liability, indemnification and jurisdiction issues defined therein. Any holder of this document is advised that information contained hereon reflects the Company's findings at the time of its intervention only and within the limits of Client's instructions, if any. The Company's sole responsibility is to its Client and this document does not exonerate parties to a transaction from exercising all their rights and obligations under the transaction documents. This document cannot be reproduced except in full, without prior written approval of the Company. Any unauthorized alteration, forgery or falsification of the content or appearance of this document is unlawful and offenders may be prosecuted to the fullest extent of the law.

Report Number :TERF2308001922E2
 Operation Mode :802.11be20
 Test Frequency :2462 MHz
 Test Mode :Tx
 EUT Pol :E2 Plane

Test Site :SAC G Chamber
 Test Date :2023-08-23
 Temp./Humi. :23.6°C/59%
 Antenna Pol. :Horizontal
 Engineer :Temo Chen

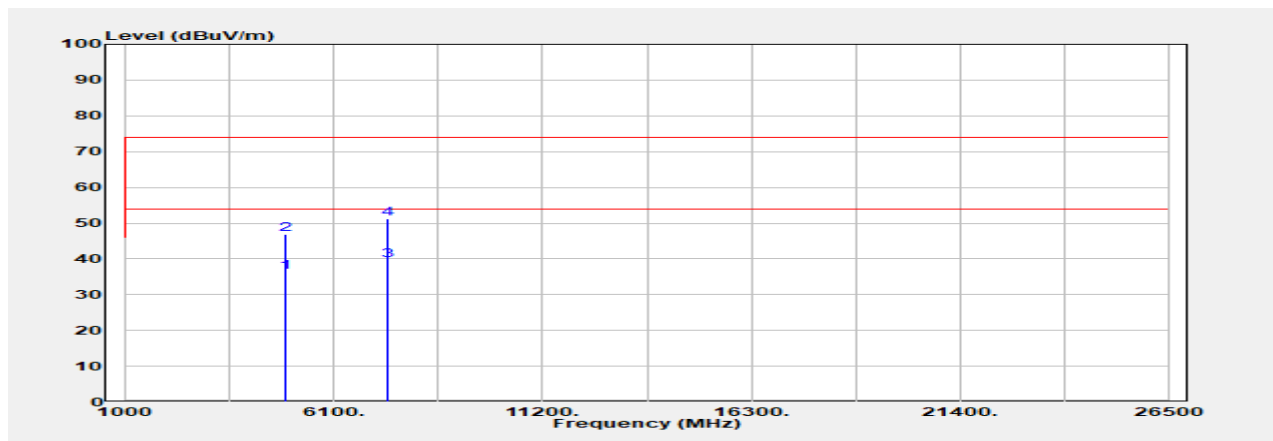

Freq. MHz	Detector Mode PK/QP/AVG	Spectrum Reading Level dB μ V	Factor dB	Actual FS dB μ V/m	Limit @3m dB μ V/m	Margin dB
4924.000	Average	32.92	3.46	36.39	54.00	-17.61
4924.000	Peak	43.46	3.46	46.93	74.00	-27.07
7386.000	Average	30.53	9.03	39.56	54.00	-14.44
7386.000	Peak	42.17	9.03	51.20	74.00	-22.80

Unless otherwise stated the results shown in this test report refer only to the sample(s) tested and such sample(s) are retained for 90 days only.
 除非另有說明，此報告結果僅對測試之樣品負責，同時此樣品僅保留90天。本報告未經本公司書面許可，不可部份複製。

This document is issued by the Company subject to its General Conditions of Service printed overleaf, available on request or accessible at <http://www.sgs.com.tw/Terms-and-Conditions> and for electronic format documents, subject to Terms and Conditions for Electronic Documents at <http://www.sgs.com.tw/Terms-and-Conditions>. Attention is drawn to the limitation of liability, indemnification and jurisdiction issues defined therein. Any holder of this document is advised that information contained hereon reflects the Company's findings at the time of its intervention only and within the limits of Client's instructions, if any. The Company's sole responsibility is to its Client and this document does not exonerate parties to a transaction from exercising all their rights and obligations under the transaction documents. This document cannot be reproduced except in full, without prior written approval of the Company. Any unauthorized alteration, forgery or falsification of the content or appearance of this document is unlawful and offenders may be prosecuted to the fullest extent of the law.

Report Number :TERF2308001922E2
 Operation Mode :802.11be40
 Test Frequency :2422 MHz
 Test Mode :Tx
 EUT Pol :E2 Plane

Test Site :SAC G Chamber
 Test Date :2023-08-23
 Temp./Humi. :23.6°C/59%
 Antenna Pol. :Vertical
 Engineer :Temo Chen

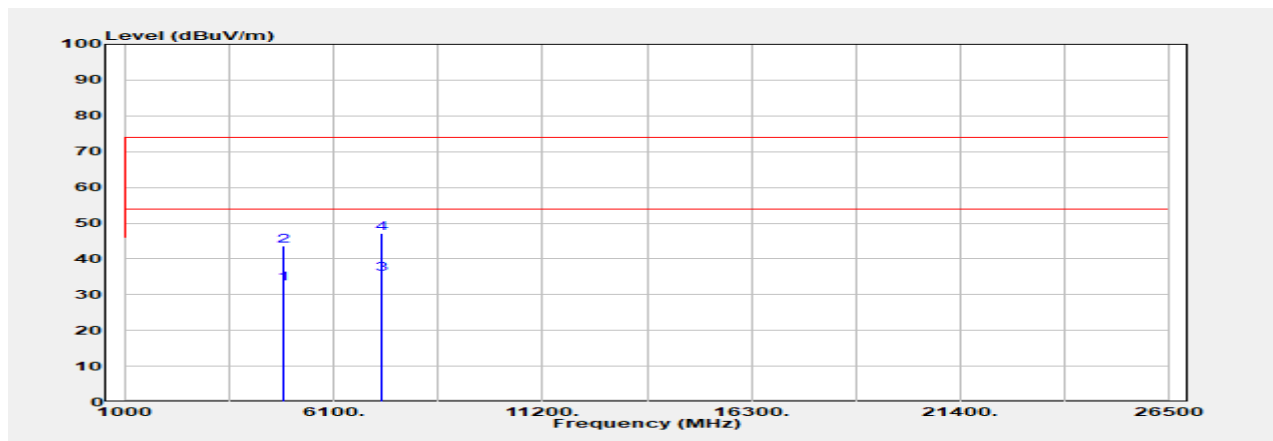

Freq. MHz	Detector Mode PK/QP/AVG	Spectrum Reading Level dB μ V	Factor dB	Actual FS dB μ V/m	Limit @3m dB μ V/m	Margin dB
4844.000	Average	29.71	3.31	33.02	54.00	-20.98
4844.000	Peak	40.37	3.31	43.68	74.00	-30.32
7266.000	Average	27.18	8.53	35.72	54.00	-18.28
7266.000	Peak	38.51	8.53	47.04	74.00	-26.96

Unless otherwise stated the results shown in this test report refer only to the sample(s) tested and such sample(s) are retained for 90 days only.
 除非另有說明，此報告結果僅對測試之樣品負責，同時此樣品僅保留90天。本報告未經本公司書面許可，不可部份複製。

This document is issued by the Company subject to its General Conditions of Service printed overleaf, available on request or accessible at <http://www.sgs.com.tw/Terms-and-Conditions> and for electronic format documents, subject to Terms and Conditions for Electronic Documents at <http://www.sgs.com.tw/Terms-and-Conditions>. Attention is drawn to the limitation of liability, indemnification and jurisdiction issues defined therein. Any holder of this document is advised that information contained hereon reflects the Company's findings at the time of its intervention only and within the limits of Client's instructions, if any. The Company's sole responsibility is to its Client and this document does not exonerate parties to a transaction from exercising all their rights and obligations under the transaction documents. This document cannot be reproduced except in full, without prior written approval of the Company. Any unauthorized alteration, forgery or falsification of the content or appearance of this document is unlawful and offenders may be prosecuted to the fullest extent of the law.

Report Number :TERF2308001922E2
 Operation Mode :802.11be40
 Test Frequency :2422 MHz
 Test Mode :Tx
 EUT Pol :E2 Plane

Test Site :SAC G Chamber
 Test Date :2023-08-23
 Temp./Humi. :23.6°C/59%
 Antenna Pol. :Horizontal
 Engineer :Temo Chen

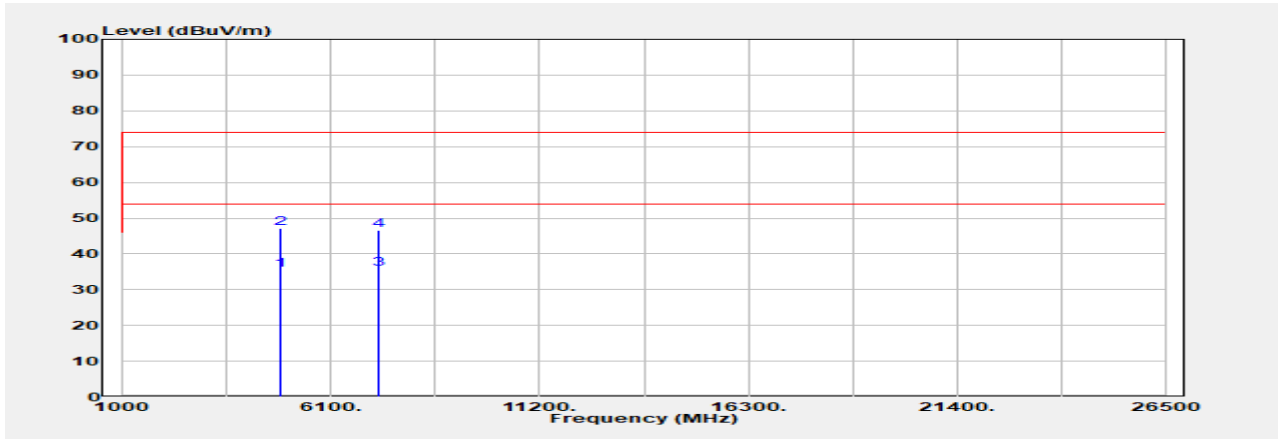

Freq. MHz	Detector Mode PK/QP/AVG	Spectrum Reading Level dB μ V	Factor dB	Actual FS dB μ V/m	Limit @3m dB μ V/m	Margin dB
4844.000	Average	32.26	3.31	35.57	54.00	-18.43
4844.000	Peak	43.87	3.31	47.18	74.00	-26.82
7266.000	Average	27.17	8.53	35.71	54.00	-18.29
7266.000	Peak	38.13	8.53	46.67	74.00	-27.33

Unless otherwise stated the results shown in this test report refer only to the sample(s) tested and such sample(s) are retained for 90 days only.

除非另有說明，此報告結果僅對測試之樣品負責，同時此樣品僅保留90天。本報告未經本公司書面許可，不可部份複製。
 This document is issued by the Company subject to its General Conditions of Service printed overleaf, available on request or accessible at <http://www.sgs.com.tw/Terms-and-Conditions> and for electronic format documents, subject to Terms and Conditions for Electronic Documents at <http://www.sgs.com.tw/Terms-and-Conditions>. Attention is drawn to the limitation of liability, indemnification and jurisdiction issues defined therein. Any holder of this document is advised that information contained hereon reflects the Company's findings at the time of its intervention only and within the limits of Client's instructions, if any. The Company's sole responsibility is to its Client and this document does not exonerate parties to a transaction from exercising all their rights and obligations under the transaction documents. This document cannot be reproduced except in full, without prior written approval of the Company. Any unauthorized alteration, forgery or falsification of the content or appearance of this document is unlawful and offenders may be prosecuted to the fullest extent of the law.

Report Number :TERF2308001922E2
 Operation Mode :802.11be40
 Test Frequency :2437 MHz
 Test Mode :Tx
 EUT Pol :E2 Plane

Test Site :SAC G Chamber
 Test Date :2023-08-23
 Temp./Humi. :23.6°C/59%
 Antenna Pol. :Vertical
 Engineer :Temo Chen

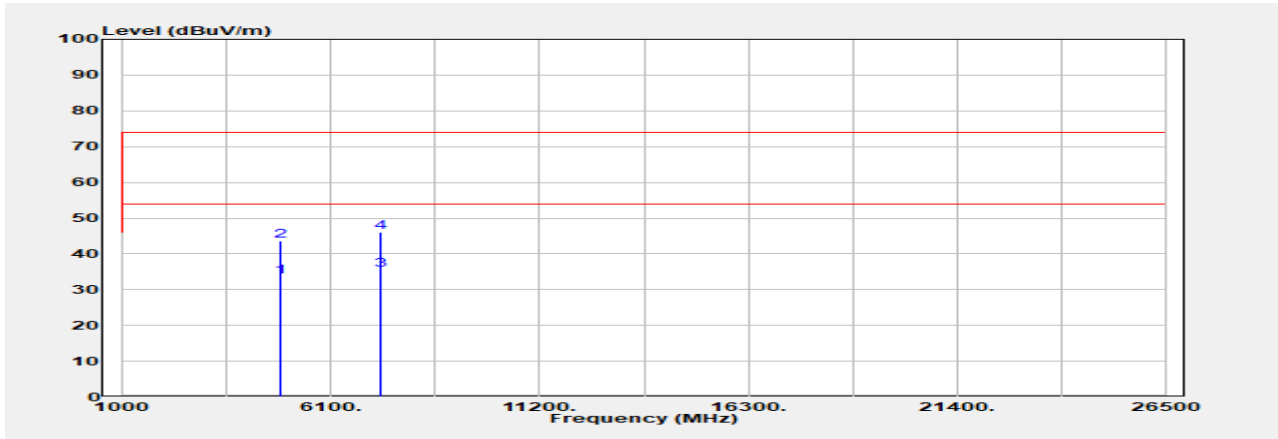

Freq. MHz	Detector Mode PK/QP/AVG	Spectrum Reading Level dB μ V	Factor dB	Actual FS dB μ V/m	Limit @3m dB μ V/m	Margin dB
4874.000	Average	30.30	3.35	33.65	54.00	-20.35
4874.000	Peak	40.17	3.35	43.52	74.00	-30.48
7311.000	Average	27.00	8.58	35.58	54.00	-18.42
7311.000	Peak	37.48	8.58	46.06	74.00	-27.94

Unless otherwise stated the results shown in this test report refer only to the sample(s) tested and such sample(s) are retained for 90 days only.

除非另有說明，此報告結果僅對測試之樣品負責，同時此樣品僅保留90天。本報告未經本公司書面許可，不可部份複製。
 This document is issued by the Company subject to its General Conditions of Service printed overleaf, available on request or accessible at <http://www.sgs.com.tw/Terms-and-Conditions> and for electronic format documents, subject to Terms and Conditions for Electronic Documents at <http://www.sgs.com.tw/Terms-and-Conditions>. Attention is drawn to the limitation of liability, indemnification and jurisdiction issues defined therein. Any holder of this document is advised that information contained hereon reflects the Company's findings at the time of its intervention only and within the limits of Client's instructions, if any. The Company's sole responsibility is to its Client and this document does not exonerate parties to a transaction from exercising all their rights and obligations under the transaction documents. This document cannot be reproduced except in full, without prior written approval of the Company. Any unauthorized alteration, forgery or falsification of the content or appearance of this document is unlawful and offenders may be prosecuted to the fullest extent of the law.

Report Number :TERF2308001922E2
 Operation Mode :802.11be40
 Test Frequency :2437 MHz
 Test Mode :Tx
 EUT Pol :E2 Plane

Test Site :SAC G Chamber
 Test Date :2023-08-23
 Temp./Humi. :23.6°C/59%
 Antenna Pol. :Horizontal
 Engineer :Temo Chen

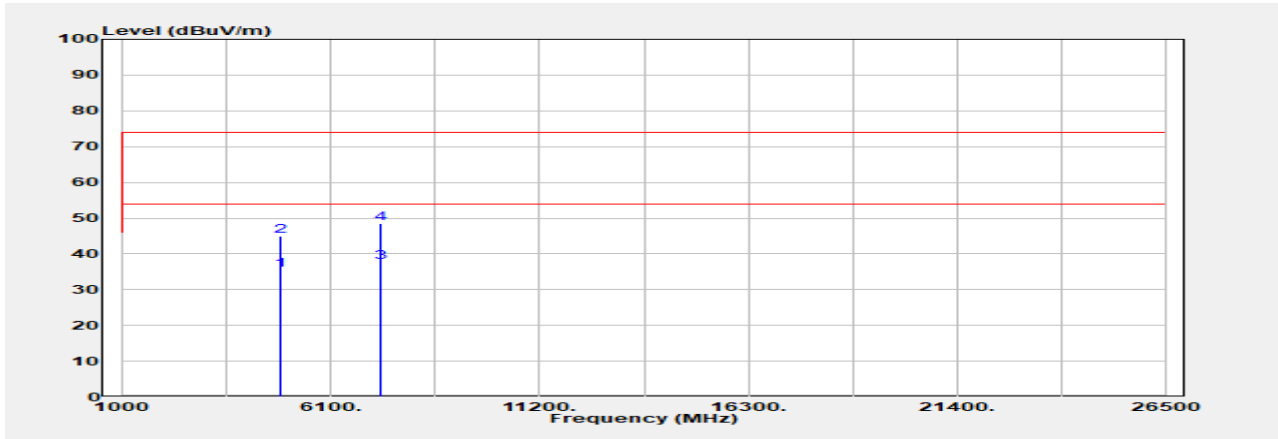

Freq. MHz	Detector Mode PK/QP/AVG	Spectrum Reading Level dBµV	Factor dB	Actual FS dBµV/m	Limit @3m dBµV/m	Margin dB
4874.000	Average	32.15	3.35	35.50	54.00	-18.50
4874.000	Peak	41.61	3.35	44.96	74.00	-29.04
7311.000	Average	29.07	8.58	37.65	54.00	-16.35
7311.000	Peak	40.02	8.58	48.59	74.00	-25.41

Unless otherwise stated the results shown in this test report refer only to the sample(s) tested and such sample(s) are retained for 90 days only.

除非另有說明，此報告結果僅對測試之樣品負責，同時此樣品僅保留90天。本報告未經本公司書面許可，不可部份複製。
 This document is issued by the Company subject to its General Conditions of Service printed overleaf, available on request or accessible at <http://www.sgs.com.tw/Terms-and-Conditions> and for electronic format documents, subject to Terms and Conditions for Electronic Documents at <http://www.sgs.com.tw/Terms-and-Conditions>. Attention is drawn to the limitation of liability, indemnification and jurisdiction issues defined therein. Any holder of this document is advised that information contained hereon reflects the Company's findings at the time of its intervention only and within the limits of Client's instructions, if any. The Company's sole responsibility is to its Client and this document does not exonerate parties to a transaction from exercising all their rights and obligations under the transaction documents. This document cannot be reproduced except in full, without prior written approval of the Company. Any unauthorized alteration, forgery or falsification of the content or appearance of this document is unlawful and offenders may be prosecuted to the fullest extent of the law.

Report Number :TERF2308001922E2
 Operation Mode :802.11be40
 Test Frequency :2452 MHz
 Test Mode :Tx
 EUT Pol :E2 Plane

Test Site :SAC G Chamber
 Test Date :2023-08-23
 Temp./Humi. :23.6°C/59%
 Antenna Pol. :Vertical
 Engineer :Temo Chen

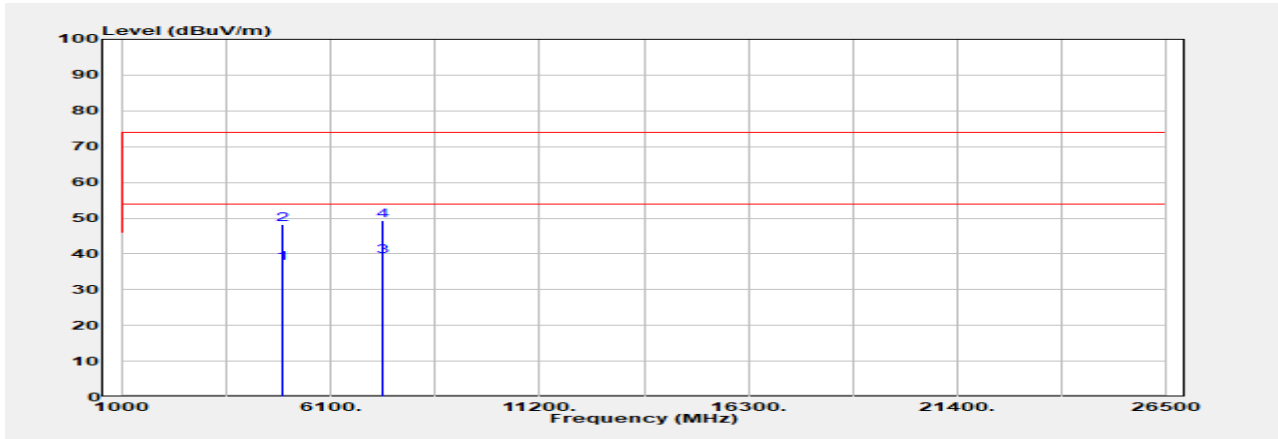

Freq. MHz	Detector Mode PK/QP/AVG	Spectrum Reading Level dBµV	Factor dB	Actual FS dBUV/m	Limit @3m dBUV/m	Margin dB
4904.000	Average	33.96	3.40	37.37	54.00	-16.63
4904.000	Peak	44.86	3.40	48.26	74.00	-25.74
7356.000	Average	30.48	8.88	39.36	54.00	-14.64
7356.000	Peak	40.58	8.88	49.46	74.00	-24.54

Unless otherwise stated the results shown in this test report refer only to the sample(s) tested and such sample(s) are retained for 90 days only.

除非另有說明，此報告結果僅對測試之樣品負責，同時此樣品僅保留90天。本報告未經本公司書面許可，不可部份複製。
 This document is issued by the Company subject to its General Conditions of Service printed overleaf, available on request or accessible at <http://www.sgs.com.tw/Terms-and-Conditions> and for electronic format documents, subject to Terms and Conditions for Electronic Documents at <http://www.sgs.com.tw/Terms-and-Conditions>. Attention is drawn to the limitation of liability, indemnification and jurisdiction issues defined therein. Any holder of this document is advised that information contained hereon reflects the Company's findings at the time of its intervention only and within the limits of Client's instructions, if any. The Company's sole responsibility is to its Client and this document does not exonerate parties to a transaction from exercising all their rights and obligations under the transaction documents. This document cannot be reproduced except in full, without prior written approval of the Company. Any unauthorized alteration, forgery or falsification of the content or appearance of this document is unlawful and offenders may be prosecuted to the fullest extent of the law.

Report Number :TERF2308001922E2
 Operation Mode :802.11be40
 Test Frequency :2452 MHz
 Test Mode :Tx
 EUT Pol :E2 Plane

Test Site :SAC G Chamber
 Test Date :2023-08-23
 Temp./Humi. :23.6°C/59%
 Antenna Pol. :Horizontal
 Engineer :Temo Chen

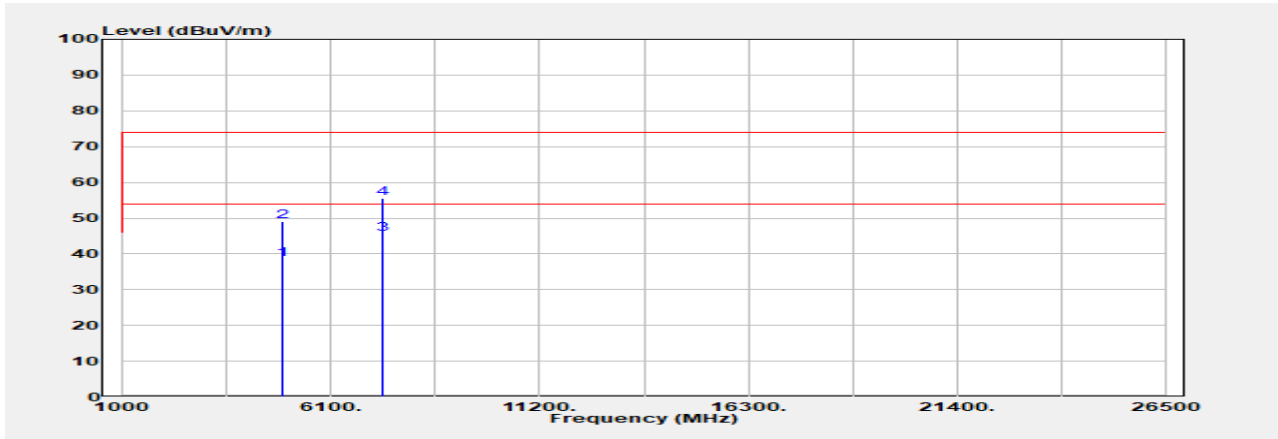

Freq. MHz	Detector Mode PK/QP/AVG	Spectrum Reading Level dB μ V	Factor dB	Actual FS dB μ V/m	Limit @3m dB μ V/m	Margin dB
4904.000	Average	35.04	3.40	38.44	54.00	-15.56
4904.000	Peak	45.64	3.40	49.04	74.00	-24.96
7356.000	Average	36.66	8.88	45.54	54.00	-8.46
7356.000	Peak	46.69	8.88	55.58	74.00	-18.42

Unless otherwise stated the results shown in this test report refer only to the sample(s) tested and such sample(s) are retained for 90 days only.

除非另有說明，此報告結果僅對測試之樣品負責，同時此樣品僅保留90天。本報告未經本公司書面許可，不可部份複製。
 This document is issued by the Company subject to its General Conditions of Service printed overleaf, available on request or accessible at <http://www.sgs.com.tw/Terms-and-Conditions> and for electronic format documents, subject to Terms and Conditions for Electronic Documents at <http://www.sgs.com.tw/Terms-and-Conditions>. Attention is drawn to the limitation of liability, indemnification and jurisdiction issues defined therein. Any holder of this document is advised that information contained hereon reflects the Company's findings at the time of its intervention only and within the limits of Client's instructions, if any. The Company's sole responsibility is to its Client and this document does not exonerate parties to a transaction from exercising all their rights and obligations under the transaction documents. This document cannot be reproduced except in full, without prior written approval of the Company. Any unauthorized alteration, forgery or falsification of the content or appearance of this document is unlawful and offenders may be prosecuted to the fullest extent of the law.

Mode: Beamforming

Report Number	:TERF2308001922E2	Test Site	:SAC G Chamber
Operation Mode	:802.11n20	Test Date	:2023-11-02
Test Frequency	:2437 MHz	Temp./Humi.	:22.6°C/56%
Test Mode	:Tx	Antenna Pol.	:Vertical
EUT Pol	:E2 Plane	Engineer	:Temo Chen

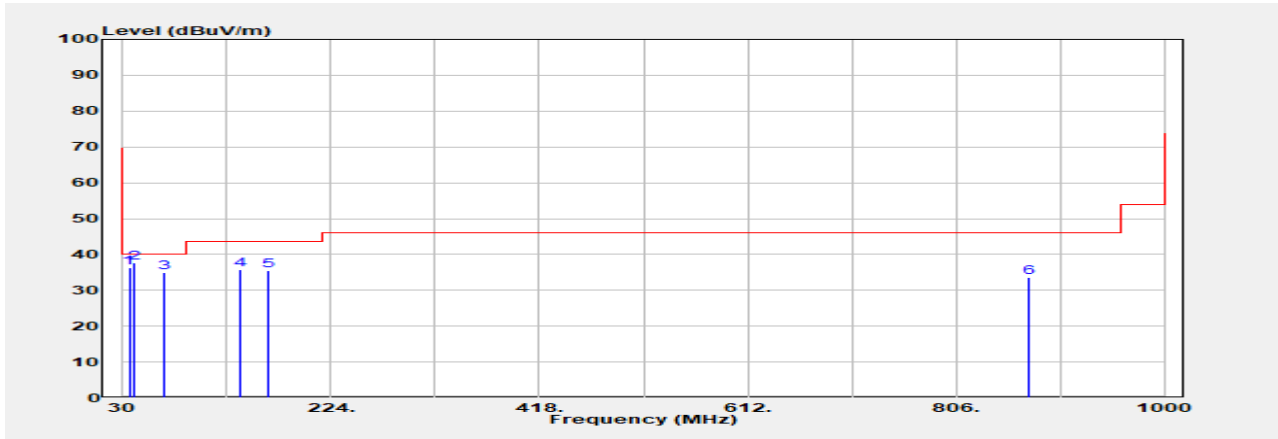

Freq. MHz	Detector Mode PK/QP/AVG	Spectrum Reading Level dBuV	Factor dB	Actual FS dBuV/m	Limit @3m dBuV/m	Margin dB
35.820	QP	50.43	-14.19	36.24	40.00	-3.76
39.700	QP	51.03	-13.47	37.56	40.00	-2.44
68.800	QP	49.67	-14.80	34.87	40.00	-5.13
139.610	Peak	49.20	-13.42	35.78	43.50	-7.72
165.800	Peak	48.60	-13.05	35.55	43.50	-7.95
874.870	Peak	33.80	-0.11	33.69	46.00	-12.31

Unless otherwise stated the results shown in this test report refer only to the sample(s) tested and such sample(s) are retained for 90 days only.

除非另有說明，此報告結果僅對測試之樣品負責，同時此樣品僅保留90天。本報告未經本公司書面許可，不可部份複製。

This document is issued by the Company subject to its General Conditions of Service printed overleaf, available on request or accessible at <http://www.sgs.com.tw/Terms-and-Conditions> and for electronic format documents, subject to Terms and Conditions for Electronic Documents at <http://www.sgs.com.tw/Terms-and-Conditions>. Attention is drawn to the limitation of liability, indemnification and jurisdiction issues defined therein. Any holder of this document is advised that information contained hereon reflects the Company's findings at the time of its intervention only and within the limits of Client's instructions, if any. The Company's sole responsibility is to its Client and this document does not exonerate parties to a transaction from exercising all their rights and obligations under the transaction documents. This document cannot be reproduced except in full, without prior written approval of the Company. Any unauthorized alteration, forgery or falsification of the content or appearance of this document is unlawful and offenders may be prosecuted to the fullest extent of the law.

Report Number :TERF2308001922E2
 Operation Mode :802.11n20
 Test Frequency :2437 MHz
 Test Mode :Tx
 EUT Pol :E2 Plane

Test Site :SAC G Chamber
 Test Date :2023-11-02
 Temp./Humi. :22.6°C/56%
 Antenna Pol. :Horizontal
 Engineer :Temo Chen

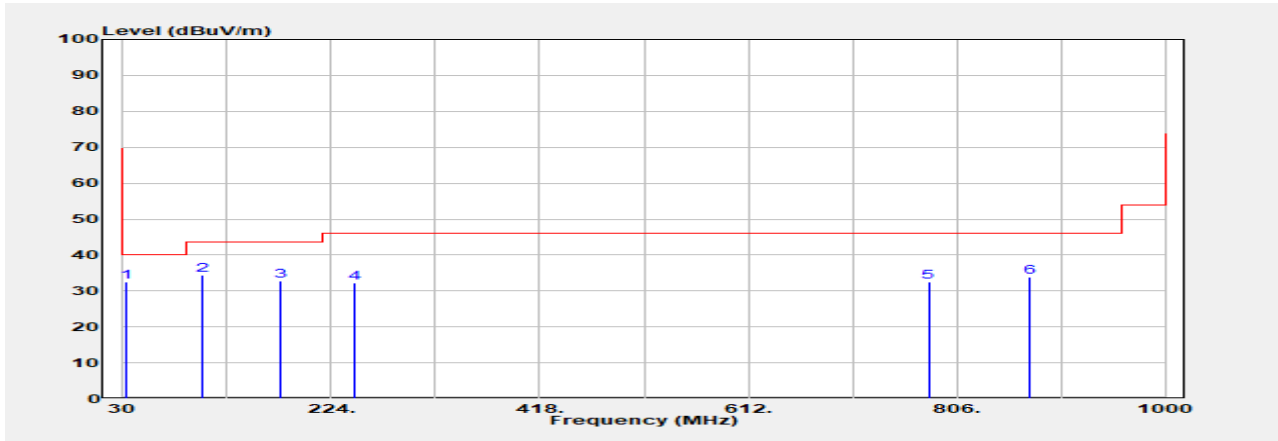

Freq. MHz	Detector Mode PK/QP/AVG	Spectrum Reading Level dBuV	Factor dB	Actual FS dBuV/m	Limit @3m dBuV/m	Margin dB
33.880	Peak	46.78	-14.14	32.64	40.00	-7.36
104.690	Peak	51.15	-16.66	34.48	43.50	-9.02
176.470	Peak	46.69	-13.99	32.70	43.50	-10.80
246.310	Peak	46.23	-13.92	32.31	46.00	-13.69
779.810	Peak	34.37	-1.76	32.62	46.00	-13.38
874.870	Peak	33.98	-0.11	33.87	46.00	-12.13

Unless otherwise stated the results shown in this test report refer only to the sample(s) tested and such sample(s) are retained for 90 days only.

除非另有說明，此報告結果僅對測試之樣品負責，同時此樣品僅保留90天。本報告未經本公司書面許可，不可部份複製。
 This document is issued by the Company subject to its General Conditions of Service printed overleaf, available on request or accessible at <http://www.sgs.com.tw/Terms-and-Conditions> and for electronic format documents, subject to Terms and Conditions for Electronic Documents at <http://www.sgs.com.tw/Terms-and-Conditions>. Attention is drawn to the limitation of liability, indemnification and jurisdiction issues defined therein. Any holder of this document is advised that information contained hereon reflects the Company's findings at the time of its intervention only and within the limits of Client's instructions, if any. The Company's sole responsibility is to its Client and this document does not exonerate parties to a transaction from exercising all their rights and obligations under the transaction documents. This document cannot be reproduced except in full, without prior written approval of the Company. Any unauthorized alteration, forgery or falsification of the content or appearance of this document is unlawful and offenders may be prosecuted to the fullest extent of the law.

Report Number :TERF2308001922E2
 Operation Mode :802.11be40
 Test Frequency :2437 MHz
 Test Mode :Tx
 EUT Pol :E2 Plane

Test Site :SAC G Chamber
 Test Date :2023-11-02
 Temp./Humi. :22.6°C/56%
 Antenna Pol. :Vertical
 Engineer :Temo Chen

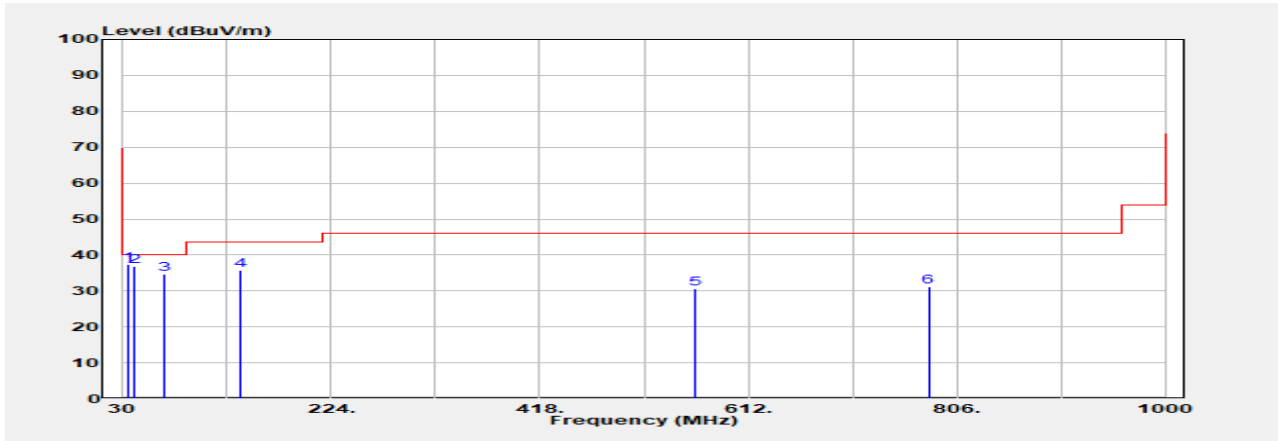

Freq. MHz	Detector Mode PK/QP/AVG	Spectrum Reading Level dBuV	Factor dB	Actual FS dBuV/m	Limit @3m dBuV/m	Margin dB
34.850	QP	51.52	-14.03	37.49	40.00	-2.51
39.700	QP	50.37	-13.47	36.90	40.00	-3.10
68.800	QP	49.61	-14.80	34.81	40.00	-5.19
139.610	Peak	49.15	-13.42	35.73	43.50	-7.77
562.530	Peak	36.74	-6.13	30.61	46.00	-15.39
779.810	Peak	32.83	-1.76	31.07	46.00	-14.93

Unless otherwise stated the results shown in this test report refer only to the sample(s) tested and such sample(s) are retained for 90 days only.

除非另有說明，此報告結果僅對測試之樣品負責，同時此樣品僅保留90天。本報告未經本公司書面許可，不可部份複製。
 This document is issued by the Company subject to its General Conditions of Service printed overleaf, available on request or accessible at <http://www.sgs.com.tw/Terms-and-Conditions> and for electronic format documents, subject to Terms and Conditions for Electronic Documents at <http://www.sgs.com.tw/Terms-and-Conditions>. Attention is drawn to the limitation of liability, indemnification and jurisdiction issues defined therein. Any holder of this document is advised that information contained hereon reflects the Company's findings at the time of its intervention only and within the limits of Client's instructions, if any. The Company's sole responsibility is to its Client and this document does not exonerate parties to a transaction from exercising all their rights and obligations under the transaction documents. This document cannot be reproduced except in full, without prior written approval of the Company. Any unauthorized alteration, forgery or falsification of the content or appearance of this document is unlawful and offenders may be prosecuted to the fullest extent of the law.

Report Number :TERF2308001922E2
 Operation Mode :802.11be40
 Test Frequency :2437 MHz
 Test Mode :Tx
 EUT Pol :E2 Plane

Test Site :SAC G Chamber
 Test Date :2023-11-02
 Temp./Humi. :22.6°C/56%
 Antenna Pol. :Horizontal
 Engineer :Temo Chen

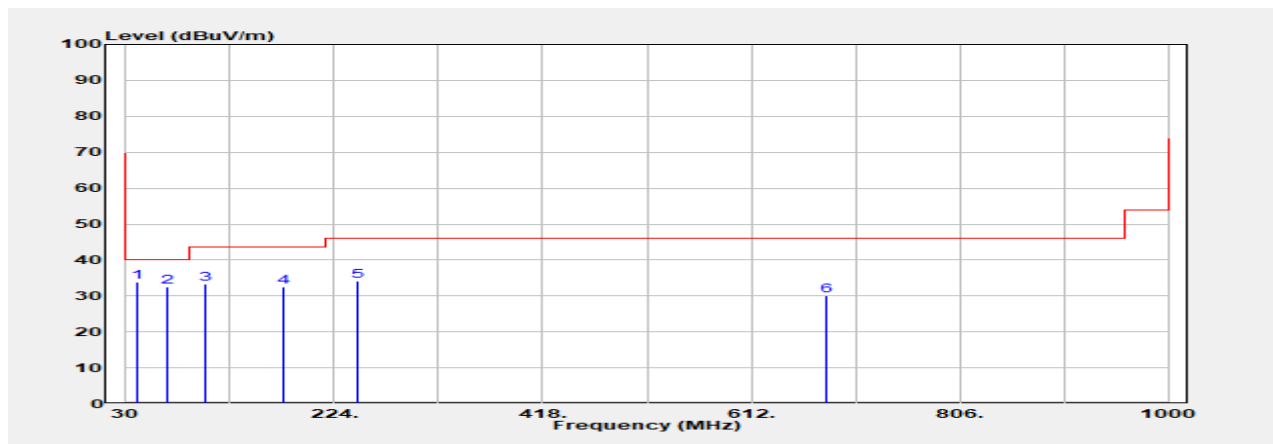

Freq. MHz	Detector Mode PK/QP/AVG	Spectrum Reading Level dBuV	Factor dB	Actual FS dBuV/m	Limit @3m dBuV/m	Margin dB
39.700	Peak	47.35	-13.47	33.88	40.00	-6.12
67.830	Peak	46.92	-14.39	32.53	40.00	-7.47
104.690	Peak	49.88	-16.66	33.21	43.50	-10.29
176.470	Peak	46.61	-13.99	32.61	43.50	-10.89
246.310	Peak	48.15	-13.92	34.23	46.00	-11.77
682.810	Peak	33.55	-3.36	30.19	46.00	-15.81

Unless otherwise stated the results shown in this test report refer only to the sample(s) tested and such sample(s) are retained for 90 days only.

除非另有說明，此報告結果僅對測試之樣品負責，同時此樣品僅保留90天。本報告未經本公司書面許可，不可部份複製。
 This document is issued by the Company subject to its General Conditions of Service printed overleaf, available on request or accessible at <http://www.sgs.com.tw/Terms-and-Conditions> and for electronic format documents, subject to Terms and Conditions for Electronic Documents at <http://www.sgs.com.tw/Terms-and-Conditions>. Attention is drawn to the limitation of liability, indemnification and jurisdiction issues defined therein. Any holder of this document is advised that information contained hereon reflects the Company's findings at the time of its intervention only and within the limits of Client's instructions, if any. The Company's sole responsibility is to its Client and this document does not exonerate parties to a transaction from exercising all their rights and obligations under the transaction documents. This document cannot be reproduced except in full, without prior written approval of the Company. Any unauthorized alteration, forgery or falsification of the content or appearance of this document is unlawful and offenders may be prosecuted to the fullest extent of the law.

Report Number :TERF2308001922E2
 Operation Mode :802.11n20
 Test Frequency :2412 MHz
 Test Mode :Tx
 EUT Pol :E2 Plane

Test Site :SAC G Chamber
 Test Date :2023-09-15
 Temp./Humi. :23.1°C/59%
 Antenna Pol. :Vertical
 Engineer :Temo Chen

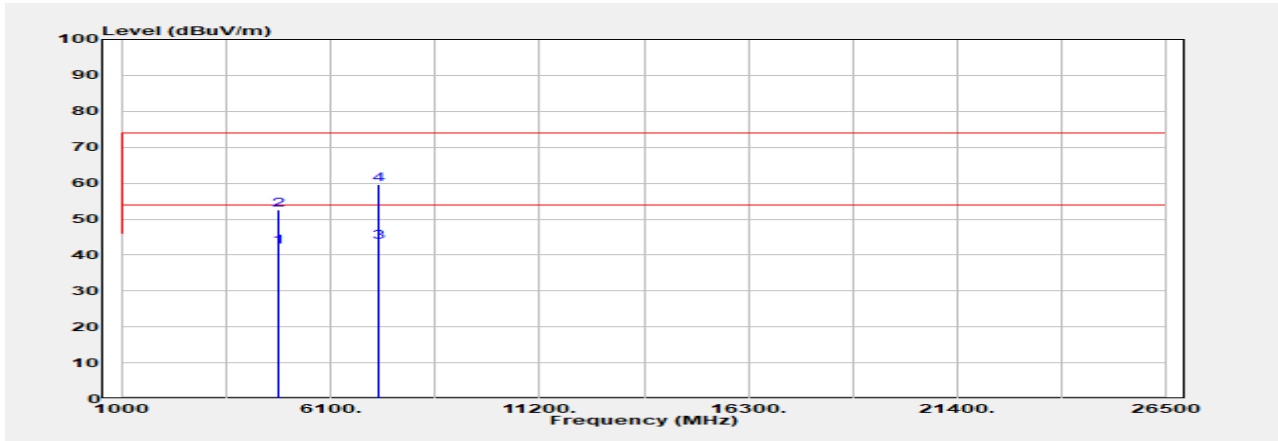

Freq. MHz	Detector Mode PK/QP/AVG	Spectrum Reading Level dBuV	Factor dB	Actual FS dBuV/m	Limit @3m dBuV/m	Margin dB
4824.000	Average	39.05	3.28	42.33	54.00	-11.67
4824.000	Peak	49.28	3.28	52.57	74.00	-21.43
7236.000	Average	35.06	8.54	43.59	54.00	-10.41
7236.000	Peak	51.00	8.54	59.54	74.00	-14.46

Unless otherwise stated the results shown in this test report refer only to the sample(s) tested and such sample(s) are retained for 90 days only.

除非另有說明，此報告結果僅對測試之樣品負責，同時此樣品僅保留90天。本報告未經本公司書面許可，不可部份複製。

This document is issued by the Company subject to its General Conditions of Service printed overleaf, available on request or accessible at <http://www.sgs.com.tw/Terms-and-Conditions> and for electronic format documents, subject to Terms and Conditions for Electronic Documents at <http://www.sgs.com.tw/Terms-and-Conditions>. Attention is drawn to the limitation of liability, indemnification and jurisdiction issues defined therein. Any holder of this document is advised that information contained hereon reflects the Company's findings at the time of its intervention only and within the limits of Client's instructions, if any. The Company's sole responsibility is to its Client and this document does not exonerate parties to a transaction from exercising all their rights and obligations under the transaction documents. This document cannot be reproduced except in full, without prior written approval of the Company. Any unauthorized alteration, forgery or falsification of the content or appearance of this document is unlawful and offenders may be prosecuted to the fullest extent of the law.

Report Number	:TERF2308001922E2	Test Site	:SAC G Chamber
Operation Mode	:802.11n20	Test Date	:2023-09-15
Test Frequency	:2412 MHz	Temp./Humi.	:23.1°C/59%
Test Mode	:Tx	Antenna Pol.	:Horizontal
EUT Pol	:E2 Plane	Engineer	:Temo Chen

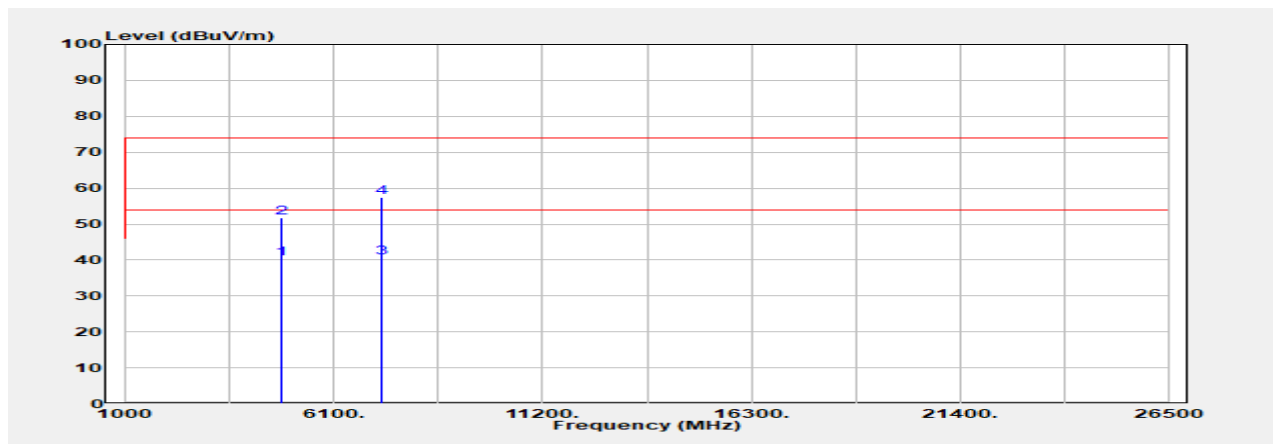

Freq. MHz	Detector Mode PK/QP/AVG	Spectrum Reading Level dBuV	Factor dB	Actual FS dBuV/m	Limit @3m dBuV/m	Margin dB
4824.000	Average	36.98	3.28	40.27	54.00	-13.73
4824.000	Peak	48.57	3.28	51.86	74.00	-22.14
7236.000	Average	32.16	8.54	40.69	54.00	-13.31
7236.000	Peak	48.88	8.54	57.41	74.00	-16.59

Unless otherwise stated the results shown in this test report refer only to the sample(s) tested and such sample(s) are retained for 90 days only.

除非另有說明，此報告結果僅對測試之樣品負責，同時此樣品僅保留90天。本報告未經本公司書面許可，不可部份複製。

This document is issued by the Company subject to its General Conditions of Service printed overleaf, available on request or accessible at <http://www.sgs.com.tw/Terms-and-Conditions> and for electronic format documents, subject to Terms and Conditions for Electronic Documents at <http://www.sgs.com.tw/Terms-and-Conditions>. Attention is drawn to the limitation of liability, indemnification and jurisdiction issues defined therein. Any holder of this document is advised that information contained hereon reflects the Company's findings at the time of its intervention only and within the limits of Client's instructions, if any. The Company's sole responsibility is to its Client and this document does not exonerate parties to a transaction from exercising all their rights and obligations under the transaction documents. This document cannot be reproduced except in full, without prior written approval of the Company. Any unauthorized alteration, forgery or falsification of the content or appearance of this document is unlawful and offenders may be prosecuted to the fullest extent of the law.

Report Number :TERF2308001922E2
 Operation Mode :802.11n20
 Test Frequency :2437 MHz
 Test Mode :Tx
 EUT Pol :E2 Plane

Test Site :SAC G Chamber
 Test Date :2023-09-15
 Temp./Humi. :23.1°C/59%
 Antenna Pol. :Vertical
 Engineer :Temo Chen

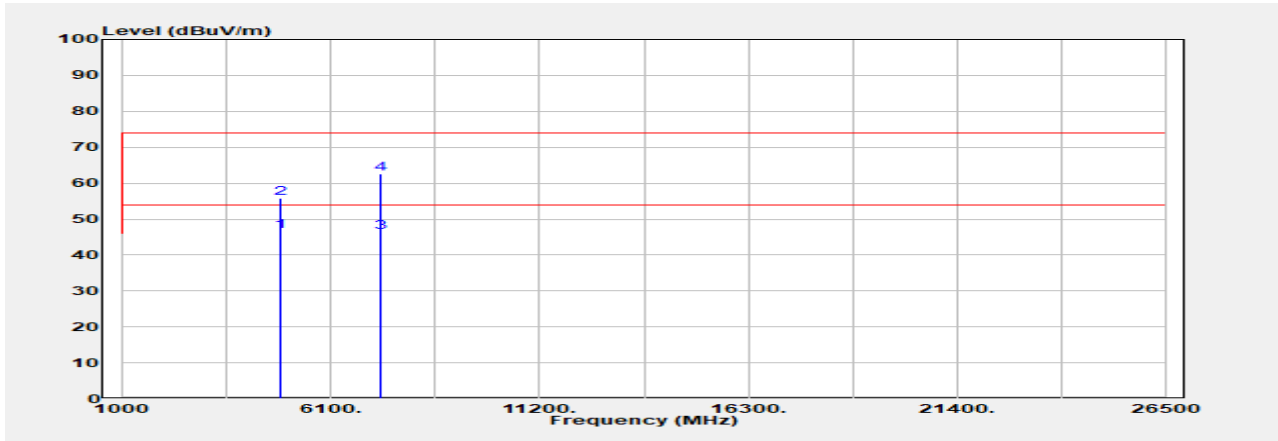

Freq. MHz	Detector Mode PK/QP/AVG	Spectrum Reading Level dBuV	Factor dB	Actual FS dBuV/m	Limit @3m dBuV/m	Margin dB
4874.000	Average	43.29	3.35	46.64	54.00	-7.36
4874.000	Peak	52.60	3.35	55.95	74.00	-18.05
7311.000	Average	37.82	8.58	46.40	54.00	-7.60
7311.000	Peak	53.99	8.58	62.57	74.00	-11.43

Unless otherwise stated the results shown in this test report refer only to the sample(s) tested and such sample(s) are retained for 90 days only.

除非另有說明，此報告結果僅對測試之樣品負責，同時此樣品僅保留90天。本報告未經本公司書面許可，不可部份複製。

This document is issued by the Company subject to its General Conditions of Service printed overleaf, available on request or accessible at <http://www.sgs.com.tw/Terms-and-Conditions> and for electronic format documents, subject to Terms and Conditions for Electronic Documents at <http://www.sgs.com.tw/Terms-and-Conditions>. Attention is drawn to the limitation of liability, indemnification and jurisdiction issues defined therein. Any holder of this document is advised that information contained hereon reflects the Company's findings at the time of its intervention only and within the limits of Client's instructions, if any. The Company's sole responsibility is to its Client and this document does not exonerate parties to a transaction from exercising all their rights and obligations under the transaction documents. This document cannot be reproduced except in full, without prior written approval of the Company. Any unauthorized alteration, forgery or falsification of the content or appearance of this document is unlawful and offenders may be prosecuted to the fullest extent of the law.

Report Number	:TERF2308001922E2	Test Site	:SAC G Chamber
Operation Mode	:802.11n20	Test Date	:2023-09-15
Test Frequency	:2437 MHz	Temp./Humi.	:23.1°C/59%
Test Mode	:Tx	Antenna Pol.	:Horizontal
EUT Pol	:E2 Plane	Engineer	:Temo Chen

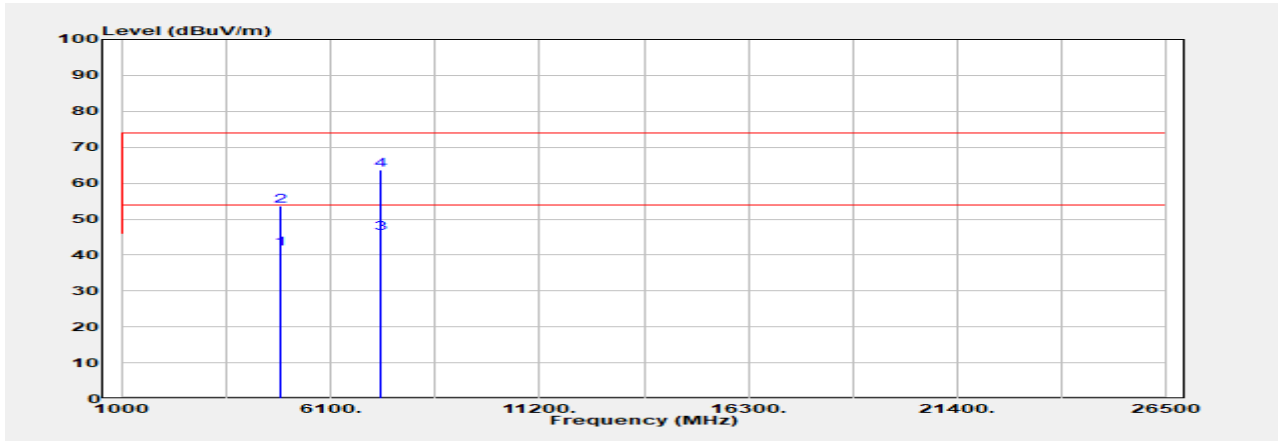

Freq. MHz	Detector Mode PK/QP/AVG	Spectrum Reading Level dBuV	Factor dB	Actual FS dBuV/m	Limit @3m dBuV/m	Margin dB
4874.000	Average	38.29	3.35	41.65	54.00	-12.35
4874.000	Peak	50.34	3.35	53.69	74.00	-20.31
7311.000	Average	37.48	8.58	46.06	54.00	-7.94
7311.000	Peak	55.22	8.58	63.80	74.00	-10.20

Unless otherwise stated the results shown in this test report refer only to the sample(s) tested and such sample(s) are retained for 90 days only.

除非另有說明，此報告結果僅對測試之樣品負責，同時此樣品僅保留90天。本報告未經本公司書面許可，不可部份複製。

This document is issued by the Company subject to its General Conditions of Service printed overleaf, available on request or accessible at <http://www.sgs.com.tw/Terms-and-Conditions> and for electronic format documents, subject to Terms and Conditions for Electronic Documents at <http://www.sgs.com.tw/Terms-and-Conditions>. Attention is drawn to the limitation of liability, indemnification and jurisdiction issues defined therein. Any holder of this document is advised that information contained hereon reflects the Company's findings at the time of its intervention only and within the limits of Client's instructions, if any. The Company's sole responsibility is to its Client and this document does not exonerate parties to a transaction from exercising all their rights and obligations under the transaction documents. This document cannot be reproduced except in full, without prior written approval of the Company. Any unauthorized alteration, forgery or falsification of the content or appearance of this document is unlawful and offenders may be prosecuted to the fullest extent of the law.

Report Number	:TERF2308001922E2	Test Site	:SAC G Chamber
Operation Mode	:802.11n20	Test Date	:2023-09-15
Test Frequency	:2462 MHz	Temp./Humi.	:23.1°C/59%
Test Mode	:Tx	Antenna Pol.	:Vertical
EUT Pol	:E2 Plane	Engineer	:Temo Chen

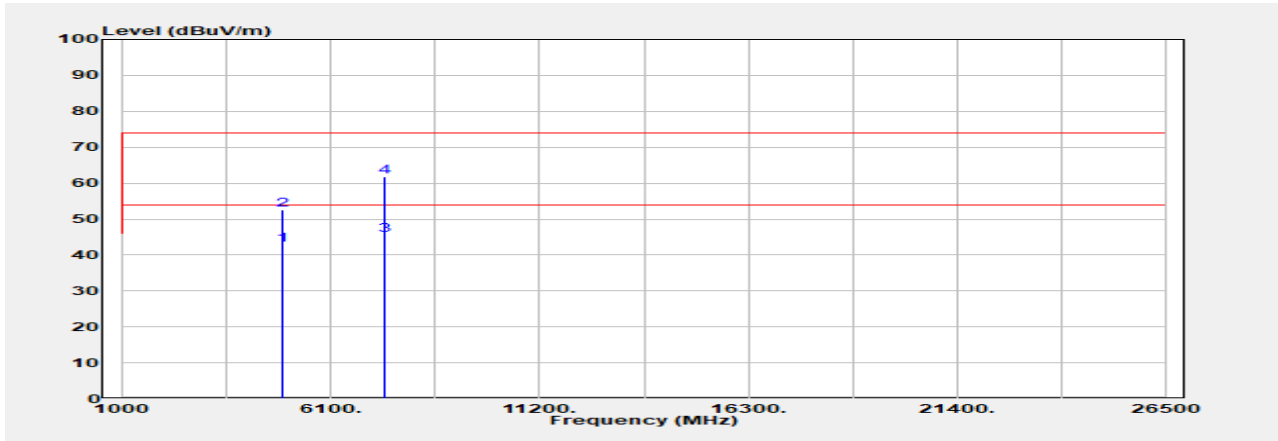

Freq. MHz	Detector Mode PK/QP/AVG	Spectrum Reading Level dBuV	Factor dB	Actual FS dBuV/m	Limit @3m dBuV/m	Margin dB
4924.000	Average	39.32	3.46	42.78	54.00	-11.22
4924.000	Peak	49.13	3.46	52.59	74.00	-21.41
7386.000	Average	36.56	9.03	45.59	54.00	-8.41
7386.000	Peak	52.66	9.03	61.69	74.00	-12.31

Unless otherwise stated the results shown in this test report refer only to the sample(s) tested and such sample(s) are retained for 90 days only.

除非另有說明，此報告結果僅對測試之樣品負責，同時此樣品僅保留90天。本報告未經本公司書面許可，不可部份複製。

This document is issued by the Company subject to its General Conditions of Service printed overleaf, available on request or accessible at <http://www.sgs.com.tw/Terms-and-Conditions> and for electronic format documents, subject to Terms and Conditions for Electronic Documents at <http://www.sgs.com.tw/Terms-and-Conditions>. Attention is drawn to the limitation of liability, indemnification and jurisdiction issues defined therein. Any holder of this document is advised that information contained hereon reflects the Company's findings at the time of its intervention only and within the limits of Client's instructions, if any. The Company's sole responsibility is to its Client and this document does not exonerate parties to a transaction from exercising all their rights and obligations under the transaction documents. This document cannot be reproduced except in full, without prior written approval of the Company. Any unauthorized alteration, forgery or falsification of the content or appearance of this document is unlawful and offenders may be prosecuted to the fullest extent of the law.

Report Number	:TERF2308001922E2	Test Site	:SAC G Chamber
Operation Mode	:802.11n20	Test Date	:2023-09-15
Test Frequency	:2462 MHz	Temp./Humi.	:23.1°C/59%
Test Mode	:Tx	Antenna Pol.	:Horizontal
EUT Pol	:E2 Plane	Engineer	:Temo Chen

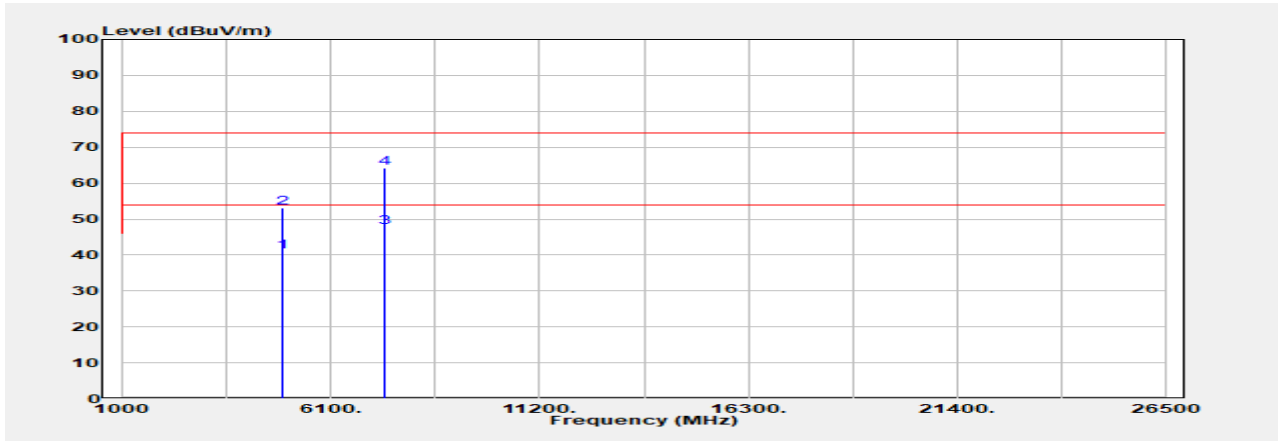

Freq. MHz	Detector Mode PK/QP/AVG	Spectrum Reading Level dBuV	Factor dB	Actual FS dBuV/m	Limit @3m dBuV/m	Margin dB
4924.000	Average	37.58	3.46	41.05	54.00	-12.95
4924.000	Peak	49.57	3.46	53.03	74.00	-20.97
7386.000	Average	38.75	9.03	47.78	54.00	-6.22
7386.000	Peak	55.30	9.03	64.33	74.00	-9.67

Unless otherwise stated the results shown in this test report refer only to the sample(s) tested and such sample(s) are retained for 90 days only.

除非另有說明，此報告結果僅對測試之樣品負責，同時此樣品僅保留90天。本報告未經本公司書面許可，不可部份複製。

This document is issued by the Company subject to its General Conditions of Service printed overleaf, available on request or accessible at <http://www.sgs.com.tw/Terms-and-Conditions> and for electronic format documents, subject to Terms and Conditions for Electronic Documents at <http://www.sgs.com.tw/Terms-and-Conditions>. Attention is drawn to the limitation of liability, indemnification and jurisdiction issues defined therein. Any holder of this document is advised that information contained hereon reflects the Company's findings at the time of its intervention only and within the limits of Client's instructions, if any. The Company's sole responsibility is to its Client and this document does not exonerate parties to a transaction from exercising all their rights and obligations under the transaction documents. This document cannot be reproduced except in full, without prior written approval of the Company. Any unauthorized alteration, forgery or falsification of the content or appearance of this document is unlawful and offenders may be prosecuted to the fullest extent of the law.

Report Number	:TERF2308001922E2	Test Site	:SAC G Chamber
Operation Mode	:802.11n40	Test Date	:2023-09-18
Test Frequency	:2422 MHz	Temp./Humi.	:23.5°C/55%
Test Mode	:Tx	Antenna Pol.	:Vertical
EUT Pol	:E2 Plane	Engineer	:Temo Chen

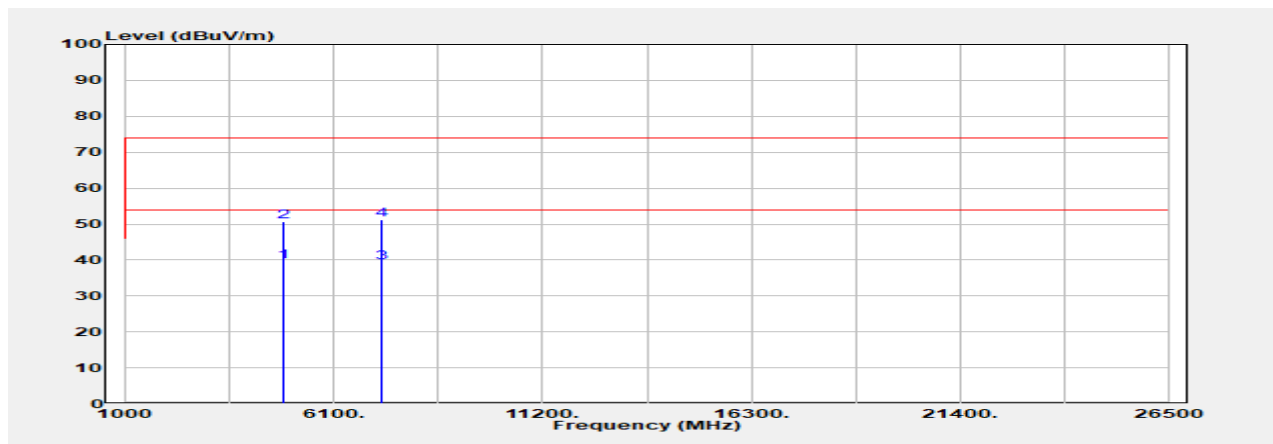

Freq. MHz	Detector Mode PK/QP/AVG	Spectrum Reading Level dBuV	Factor dB	Actual FS dBuV/m	Limit @3m dBuV/m	Margin dB
4844.000	Average	36.19	3.31	39.50	54.00	-14.50
4844.000	Peak	47.40	3.31	50.71	74.00	-23.29
7266.000	Average	30.81	8.53	39.34	54.00	-14.66
7266.000	Peak	42.78	8.53	51.31	74.00	-22.69

Unless otherwise stated the results shown in this test report refer only to the sample(s) tested and such sample(s) are retained for 90 days only.

除非另有說明，此報告結果僅對測試之樣品負責，同時此樣品僅保留90天。本報告未經本公司書面許可，不可部份複製。

This document is issued by the Company subject to its General Conditions of Service printed overleaf, available on request or accessible at <http://www.sgs.com.tw/Terms-and-Conditions> and for electronic format documents, subject to Terms and Conditions for Electronic Documents at <http://www.sgs.com.tw/Terms-and-Conditions>. Attention is drawn to the limitation of liability, indemnification and jurisdiction issues defined therein. Any holder of this document is advised that information contained hereon reflects the Company's findings at the time of its intervention only and within the limits of Client's instructions, if any. The Company's sole responsibility is to its Client and this document does not exonerate parties to a transaction from exercising all their rights and obligations under the transaction documents. This document cannot be reproduced except in full, without prior written approval of the Company. Any unauthorized alteration, forgery or falsification of the content or appearance of this document is unlawful and offenders may be prosecuted to the fullest extent of the law.

Report Number	:TERF2308001922E2	Test Site	:SAC G Chamber
Operation Mode	:802.11n40	Test Date	:2023-09-18
Test Frequency	:2422 MHz	Temp./Humi.	:23.5°C/55%
Test Mode	:Tx	Antenna Pol.	:Horizontal
EUT Pol	:E2 Plane	Engineer	:Temo Chen

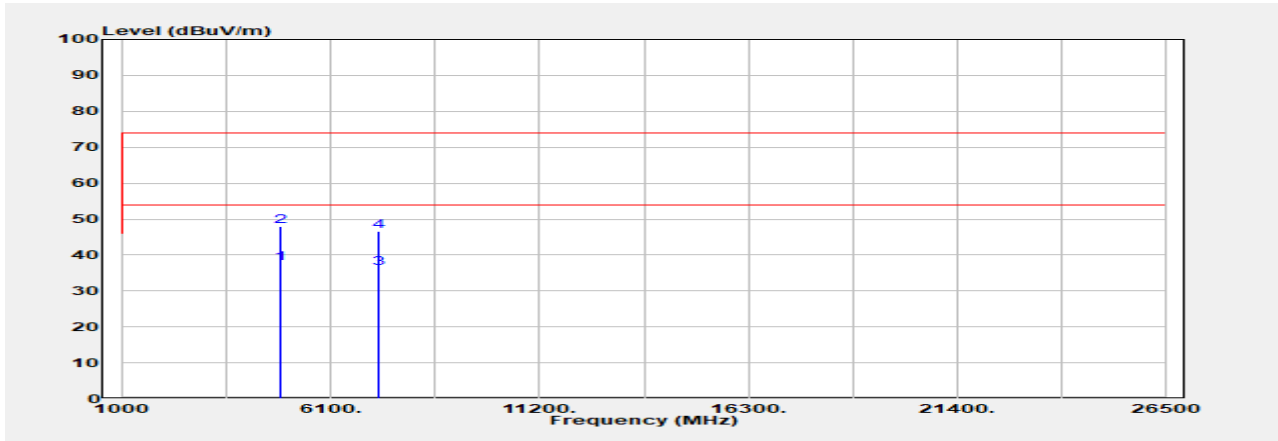

Freq. MHz	Detector Mode PK/QP/AVG	Spectrum Reading Level dBuV	Factor dB	Actual FS dBuV/m	Limit @3m dBuV/m	Margin dB
4844.000	Average	34.24	3.31	37.55	54.00	-16.45
4844.000	Peak	44.71	3.31	48.02	74.00	-25.98
7266.000	Average	27.74	8.53	36.27	54.00	-17.73
7266.000	Peak	38.17	8.53	46.70	74.00	-27.30

Unless otherwise stated the results shown in this test report refer only to the sample(s) tested and such sample(s) are retained for 90 days only.

除非另有說明，此報告結果僅對測試之樣品負責，同時此樣品僅保留90天。本報告未經本公司書面許可，不可部份複製。

This document is issued by the Company subject to its General Conditions of Service printed overleaf, available on request or accessible at <http://www.sgs.com.tw/Terms-and-Conditions> and for electronic format documents, subject to Terms and Conditions for Electronic Documents at <http://www.sgs.com.tw/Terms-and-Conditions>. Attention is drawn to the limitation of liability, indemnification and jurisdiction issues defined therein. Any holder of this document is advised that information contained hereon reflects the Company's findings at the time of its intervention only and within the limits of Client's instructions, if any. The Company's sole responsibility is to its Client and this document does not exonerate parties to a transaction from exercising all their rights and obligations under the transaction documents. This document cannot be reproduced except in full, without prior written approval of the Company. Any unauthorized alteration, forgery or falsification of the content or appearance of this document is unlawful and offenders may be prosecuted to the fullest extent of the law.

Report Number :TERF2308001922E2
 Operation Mode :802.11n40
 Test Frequency :2437 MHz
 Test Mode :Tx
 EUT Pol :E2 Plane

Test Site :SAC G Chamber
 Test Date :2023-09-18
 Temp./Humi. :23.5°C/55%
 Antenna Pol. :Vertical
 Engineer :Temo Chen

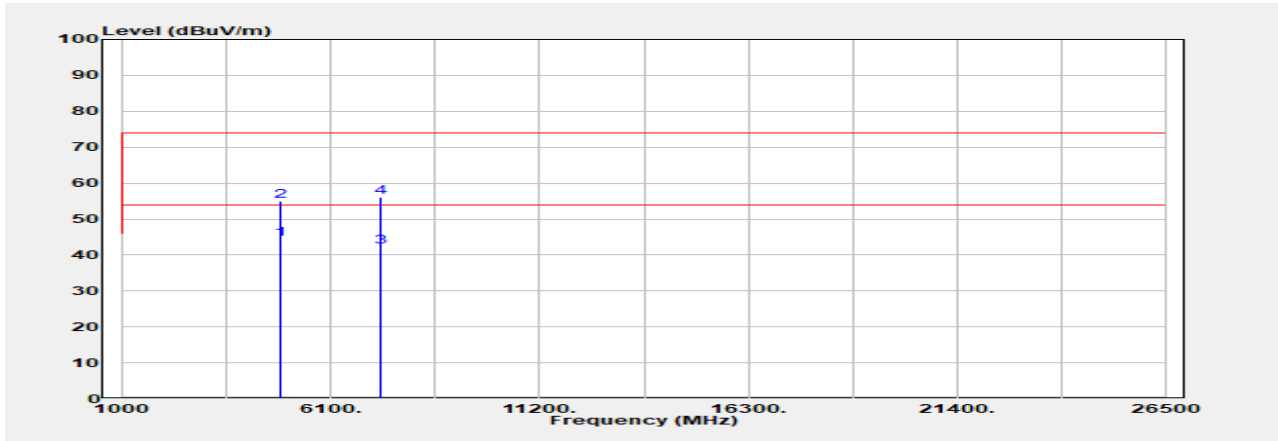

Freq. MHz	Detector Mode PK/QP/AVG	Spectrum Reading Level dBuV	Factor dB	Actual FS dBuV/m	Limit @3m dBuV/m	Margin dB
4874.000	Average	40.96	3.35	44.31	54.00	-9.69
4874.000	Peak	51.69	3.35	55.04	74.00	-18.96
7311.000	Average	33.81	8.58	42.39	54.00	-11.61
7311.000	Peak	47.55	8.58	56.13	74.00	-17.87

Unless otherwise stated the results shown in this test report refer only to the sample(s) tested and such sample(s) are retained for 90 days only.

除非另有說明，此報告結果僅對測試之樣品負責，同時此樣品僅保留90天。本報告未經本公司書面許可，不可部份複製。

This document is issued by the Company subject to its General Conditions of Service printed overleaf, available on request or accessible at <http://www.sgs.com.tw/Terms-and-Conditions> and for electronic format documents, subject to Terms and Conditions for Electronic Documents at <http://www.sgs.com.tw/Terms-and-Conditions>. Attention is drawn to the limitation of liability, indemnification and jurisdiction issues defined therein. Any holder of this document is advised that information contained hereon reflects the Company's findings at the time of its intervention only and within the limits of Client's instructions, if any. The Company's sole responsibility is to its Client and this document does not exonerate parties to a transaction from exercising all their rights and obligations under the transaction documents. This document cannot be reproduced except in full, without prior written approval of the Company. Any unauthorized alteration, forgery or falsification of the content or appearance of this document is unlawful and offenders may be prosecuted to the fullest extent of the law.

Report Number	:TERF2308001922E2	Test Site	:SAC G Chamber
Operation Mode	:802.11n40	Test Date	:2023-09-18
Test Frequency	:2437 MHz	Temp./Humi.	:23.5°C/55%
Test Mode	:Tx	Antenna Pol.	:Horizontal
EUT Pol	:E2 Plane	Engineer	:Temo Chen

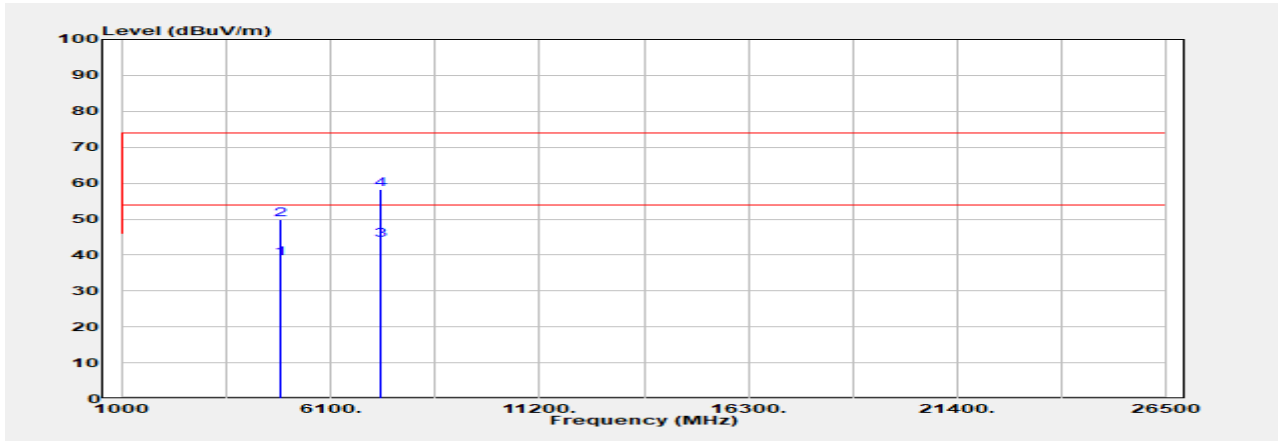

Freq. MHz	Detector Mode PK/QP/AVG	Spectrum Reading Level dBuV	Factor dB	Actual FS dBuV/m	Limit @3m dBuV/m	Margin dB
4874.000	Average	35.74	3.35	39.09	54.00	-14.91
4874.000	Peak	46.44	3.35	49.79	74.00	-24.21
7311.000	Average	35.48	8.58	44.06	54.00	-9.94
7311.000	Peak	49.59	8.58	58.17	74.00	-15.83

Unless otherwise stated the results shown in this test report refer only to the sample(s) tested and such sample(s) are retained for 90 days only.

除非另有說明，此報告結果僅對測試之樣品負責，同時此樣品僅保留90天。本報告未經本公司書面許可，不可部份複製。

This document is issued by the Company subject to its General Conditions of Service printed overleaf, available on request or accessible at <http://www.sgs.com.tw/Terms-and-Conditions> and for electronic format documents, subject to Terms and Conditions for Electronic Documents at <http://www.sgs.com.tw/Terms-and-Conditions>. Attention is drawn to the limitation of liability, indemnification and jurisdiction issues defined therein. Any holder of this document is advised that information contained hereon reflects the Company's findings at the time of its intervention only and within the limits of Client's instructions, if any. The Company's sole responsibility is to its Client and this document does not exonerate parties to a transaction from exercising all their rights and obligations under the transaction documents. This document cannot be reproduced except in full, without prior written approval of the Company. Any unauthorized alteration, forgery or falsification of the content or appearance of this document is unlawful and offenders may be prosecuted to the fullest extent of the law.

Report Number :TERF2308001922E2
 Operation Mode :802.11n40
 Test Frequency :2452 MHz
 Test Mode :Tx
 EUT Pol :E2 Plane

Test Site :SAC G Chamber
 Test Date :2023-09-18
 Temp./Humi. :23.5°C/55%
 Antenna Pol. :Vertical
 Engineer :Temo Chen

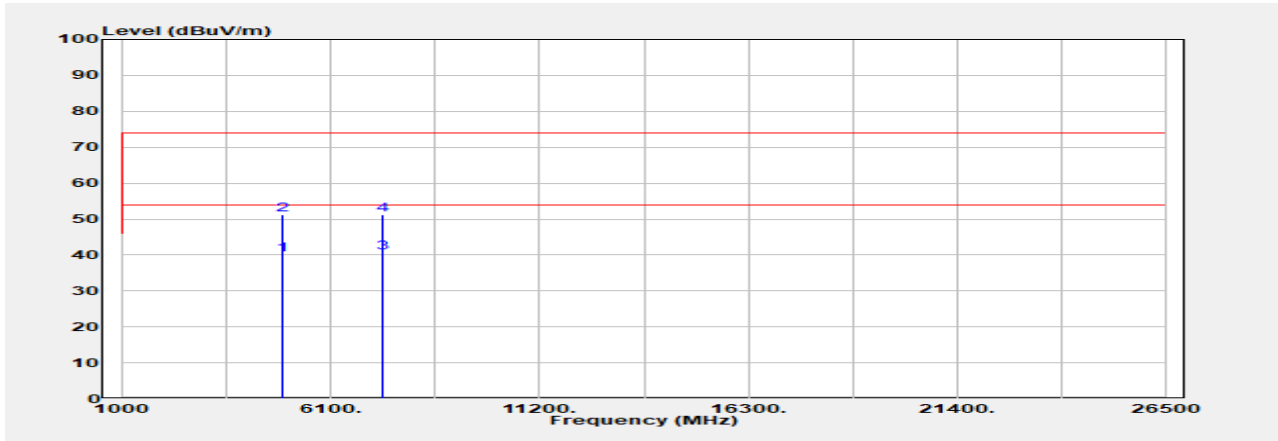

Freq. MHz	Detector Mode PK/QP/AVG	Spectrum Reading Level dBuV	Factor dB	Actual FS dBuV/m	Limit @3m dBuV/m	Margin dB
4904.000	Average	36.72	3.40	40.12	54.00	-13.88
4904.000	Peak	47.73	3.40	51.14	74.00	-22.86
7356.000	Average	31.87	8.88	40.75	54.00	-13.25
7356.000	Peak	42.30	8.88	51.18	74.00	-22.82

Unless otherwise stated the results shown in this test report refer only to the sample(s) tested and such sample(s) are retained for 90 days only.

除非另有說明，此報告結果僅對測試之樣品負責，同時此樣品僅保留90天。本報告未經本公司書面許可，不可部份複製。

This document is issued by the Company subject to its General Conditions of Service printed overleaf, available on request or accessible at <http://www.sgs.com.tw/Terms-and-Conditions> and for electronic format documents, subject to Terms and Conditions for Electronic Documents at <http://www.sgs.com.tw/Terms-and-Conditions>. Attention is drawn to the limitation of liability, indemnification and jurisdiction issues defined therein. Any holder of this document is advised that information contained hereon reflects the Company's findings at the time of its intervention only and within the limits of Client's instructions, if any. The Company's sole responsibility is to its Client and this document does not exonerate parties to a transaction from exercising all their rights and obligations under the transaction documents. This document cannot be reproduced except in full, without prior written approval of the Company. Any unauthorized alteration, forgery or falsification of the content or appearance of this document is unlawful and offenders may be prosecuted to the fullest extent of the law.

Report Number	:TERF2308001922E2	Test Site	:SAC G Chamber
Operation Mode	:802.11n40	Test Date	:2023-09-18
Test Frequency	:2452 MHz	Temp./Humi.	:23.5°C/55%
Test Mode	:Tx	Antenna Pol.	:Horizontal
EUT Pol	:E2 Plane	Engineer	:Temo Chen

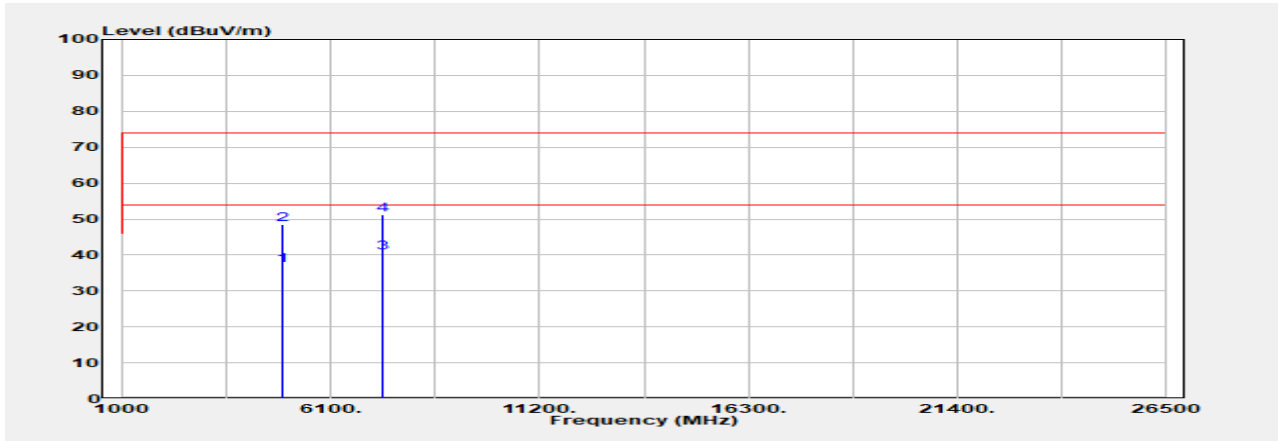

Freq. MHz	Detector Mode PK/QP/AVG	Spectrum Reading Level dBuV	Factor dB	Actual FS dBuV/m	Limit @3m dBuV/m	Margin dB
4904.000	Average	33.65	3.40	37.05	54.00	-16.95
4904.000	Peak	45.01	3.40	48.41	74.00	-25.59
7356.000	Average	31.64	8.88	40.52	54.00	-13.48
7356.000	Peak	42.42	8.88	51.31	74.00	-22.69

Unless otherwise stated the results shown in this test report refer only to the sample(s) tested and such sample(s) are retained for 90 days only.

除非另有說明，此報告結果僅對測試之樣品負責，同時此樣品僅保留90天。本報告未經本公司書面許可，不可部份複製。

This document is issued by the Company subject to its General Conditions of Service printed overleaf, available on request or accessible at <http://www.sgs.com.tw/Terms-and-Conditions> and for electronic format documents, subject to Terms and Conditions for Electronic Documents at <http://www.sgs.com.tw/Terms-and-Conditions>. Attention is drawn to the limitation of liability, indemnification and jurisdiction issues defined therein. Any holder of this document is advised that information contained hereon reflects the Company's findings at the time of its intervention only and within the limits of Client's instructions, if any. The Company's sole responsibility is to its Client and this document does not exonerate parties to a transaction from exercising all their rights and obligations under the transaction documents. This document cannot be reproduced except in full, without prior written approval of the Company. Any unauthorized alteration, forgery or falsification of the content or appearance of this document is unlawful and offenders may be prosecuted to the fullest extent of the law.

Report Number :TERF2308001922E2
 Operation Mode :802.11be20
 Test Frequency :2412 MHz
 Test Mode :Tx
 EUT Pol :E2 Plane

Test Site :SAC G Chamber
 Test Date :2023-09-18
 Temp./Humi. :23.5°C/55%
 Antenna Pol. :Vertical
 Engineer :Temo Chen

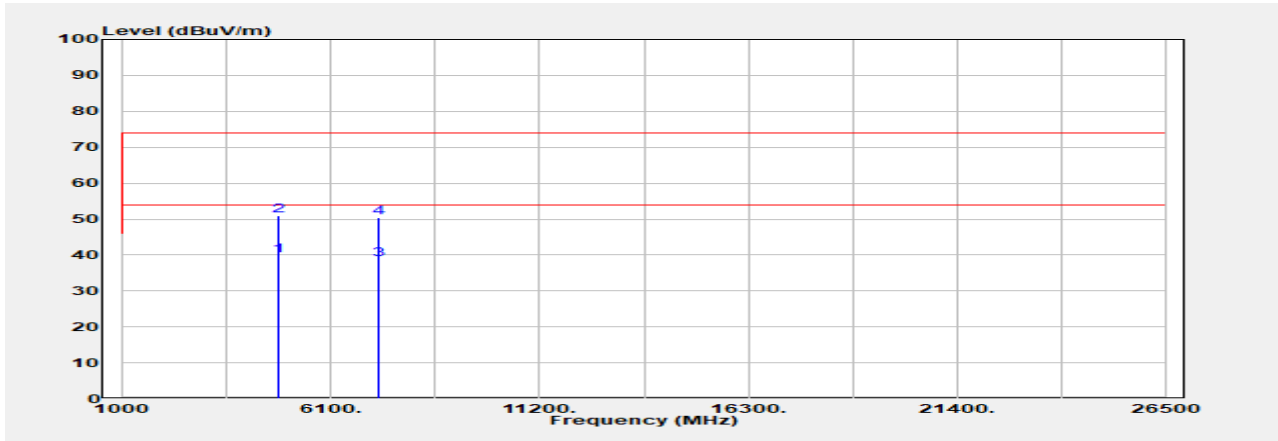

Freq. MHz	Detector Mode PK/QP/AVG	Spectrum Reading Level dBuV	Factor dB	Actual FS dBuV/m	Limit @3m dBuV/m	Margin dB
4824.000	Average	36.51	3.28	39.79	54.00	-14.21
4824.000	Peak	47.79	3.28	51.08	74.00	-22.92
7236.000	Average	30.22	8.54	38.76	54.00	-15.24
7236.000	Peak	41.79	8.54	50.33	74.00	-23.67

Unless otherwise stated the results shown in this test report refer only to the sample(s) tested and such sample(s) are retained for 90 days only.

除非另有說明，此報告結果僅對測試之樣品負責，同時此樣品僅保留90天。本報告未經本公司書面許可，不可部份複製。

This document is issued by the Company subject to its General Conditions of Service printed overleaf, available on request or accessible at <http://www.sgs.com.tw/Terms-and-Conditions> and for electronic format documents, subject to Terms and Conditions for Electronic Documents at <http://www.sgs.com.tw/Terms-and-Conditions>. Attention is drawn to the limitation of liability, indemnification and jurisdiction issues defined therein. Any holder of this document is advised that information contained hereon reflects the Company's findings at the time of its intervention only and within the limits of Client's instructions, if any. The Company's sole responsibility is to its Client and this document does not exonerate parties to a transaction from exercising all their rights and obligations under the transaction documents. This document cannot be reproduced except in full, without prior written approval of the Company. Any unauthorized alteration, forgery or falsification of the content or appearance of this document is unlawful and offenders may be prosecuted to the fullest extent of the law.

Report Number	:TERF2308001922E2	Test Site	:SAC G Chamber
Operation Mode	:802.11be20	Test Date	:2023-09-18
Test Frequency	:2412 MHz	Temp./Humi.	:23.5°C/55%
Test Mode	:Tx	Antenna Pol.	:Horizontal
EUT Pol	:E2 Plane	Engineer	:Temo Chen

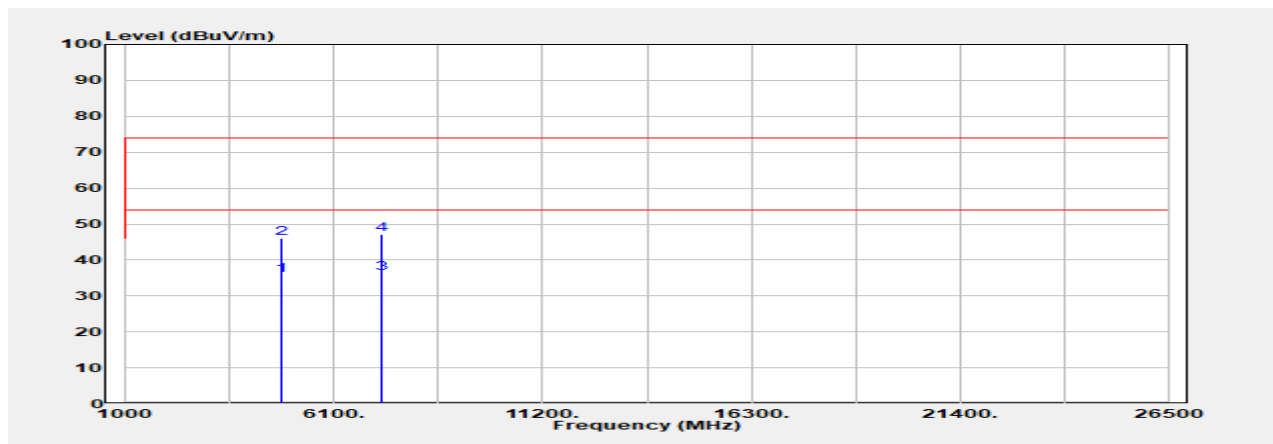

Freq. MHz	Detector Mode PK/QP/AVG	Spectrum Reading Level dBuV	Factor dB	Actual FS dBuV/m	Limit @3m dBuV/m	Margin dB
4824.000	Average	32.45	3.28	35.73	54.00	-18.27
4824.000	Peak	42.82	3.28	46.10	74.00	-27.90
7236.000	Average	27.87	8.54	36.41	54.00	-17.59
7236.000	Peak	38.60	8.54	47.14	74.00	-26.86

Unless otherwise stated the results shown in this test report refer only to the sample(s) tested and such sample(s) are retained for 90 days only.
 除非另有說明，此報告結果僅對測試之樣品負責，同時此樣品僅保留90天。本報告未經本公司書面許可，不可部份複製。

This document is issued by the Company subject to its General Conditions of Service printed overleaf, available on request or accessible at <http://www.sgs.com.tw/Terms-and-Conditions> and for electronic format documents, subject to Terms and Conditions for Electronic Documents at <http://www.sgs.com.tw/Terms-and-Conditions>. Attention is drawn to the limitation of liability, indemnification and jurisdiction issues defined therein. Any holder of this document is advised that information contained hereon reflects the Company's findings at the time of its intervention only and within the limits of Client's instructions, if any. The Company's sole responsibility is to its Client and this document does not exonerate parties to a transaction from exercising all their rights and obligations under the transaction documents. This document cannot be reproduced except in full, without prior written approval of the Company. Any unauthorized alteration, forgery or falsification of the content or appearance of this document is unlawful and offenders may be prosecuted to the fullest extent of the law.

Report Number	:TERF2308001922E2	Test Site	:SAC G Chamber
Operation Mode	:802.11be20	Test Date	:2023-09-18
Test Frequency	:2437 MHz	Temp./Humi.	:23.5°C/55%
Test Mode	:Tx	Antenna Pol.	:Vertical
EUT Pol	:E2 Plane	Engineer	:Temo Chen

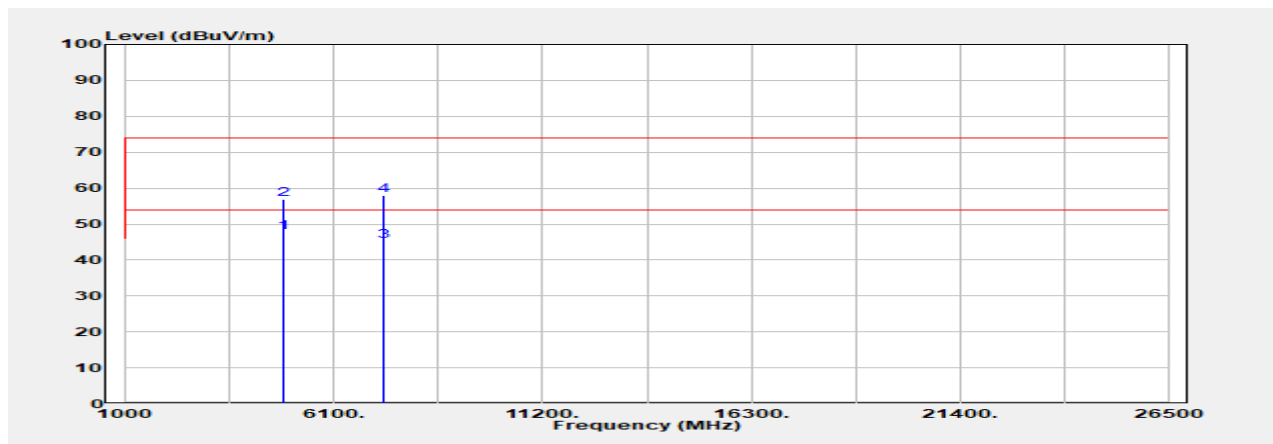

Freq. MHz	Detector Mode PK/QP/AVG	Spectrum Reading Level dBuV	Factor dB	Actual FS dBuV/m	Limit @3m dBuV/m	Margin dB
4874.000	Average	44.46	3.35	47.81	54.00	-6.19
4874.000	Peak	53.64	3.35	56.99	74.00	-17.01
7311.000	Average	36.75	8.58	45.33	54.00	-8.67
7311.000	Peak	49.47	8.58	58.05	74.00	-15.95

Unless otherwise stated the results shown in this test report refer only to the sample(s) tested and such sample(s) are retained for 90 days only.
 除非另有說明，此報告結果僅對測試之樣品負責，同時此樣品僅保留90天。本報告未經本公司書面許可，不可部份複製。

This document is issued by the Company subject to its General Conditions of Service printed overleaf, available on request or accessible at <http://www.sgs.com.tw/Terms-and-Conditions> and for electronic format documents, subject to Terms and Conditions for Electronic Documents at <http://www.sgs.com.tw/Terms-and-Conditions>. Attention is drawn to the limitation of liability, indemnification and jurisdiction issues defined therein. Any holder of this document is advised that information contained hereon reflects the Company's findings at the time of its intervention only and within the limits of Client's instructions, if any. The Company's sole responsibility is to its Client and this document does not exonerate parties to a transaction from exercising all their rights and obligations under the transaction documents. This document cannot be reproduced except in full, without prior written approval of the Company. Any unauthorized alteration, forgery or falsification of the content or appearance of this document is unlawful and offenders may be prosecuted to the fullest extent of the law.

Report Number	:TERF2308001922E2	Test Site	:SAC G Chamber
Operation Mode	:802.11be20	Test Date	:2023-09-18
Test Frequency	:2437 MHz	Temp./Humi.	:23.5°C/55%
Test Mode	:Tx	Antenna Pol.	:Horizontal
EUT Pol	:E2 Plane	Engineer	:Temo Chen

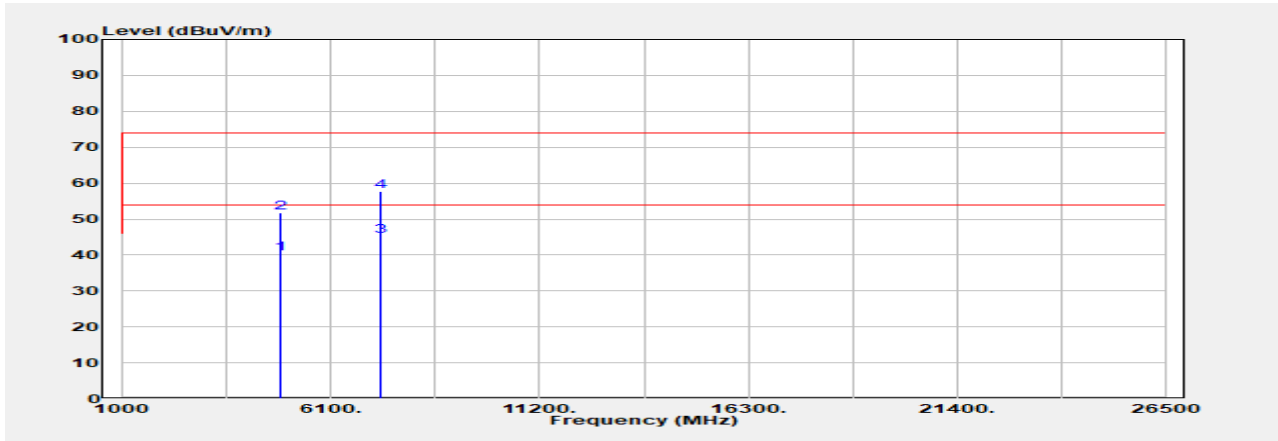

Freq. MHz	Detector Mode PK/QP/AVG	Spectrum Reading Level dBuV	Factor dB	Actual FS dBuV/m	Limit @3m dBuV/m	Margin dB
4874.000	Average	36.90	3.35	40.26	54.00	-13.74
4874.000	Peak	48.28	3.35	51.64	74.00	-22.36
7311.000	Average	36.58	8.58	45.16	54.00	-8.84
7311.000	Peak	49.25	8.58	57.83	74.00	-16.17

Unless otherwise stated the results shown in this test report refer only to the sample(s) tested and such sample(s) are retained for 90 days only.

除非另有說明，此報告結果僅對測試之樣品負責，同時此樣品僅保留90天。本報告未經本公司書面許可，不可部份複製。

This document is issued by the Company subject to its General Conditions of Service printed overleaf, available on request or accessible at <http://www.sgs.com.tw/Terms-and-Conditions> and for electronic format documents, subject to Terms and Conditions for Electronic Documents at <http://www.sgs.com.tw/Terms-and-Conditions>. Attention is drawn to the limitation of liability, indemnification and jurisdiction issues defined therein. Any holder of this document is advised that information contained hereon reflects the Company's findings at the time of its intervention only and within the limits of Client's instructions, if any. The Company's sole responsibility is to its Client and this document does not exonerate parties to a transaction from exercising all their rights and obligations under the transaction documents. This document cannot be reproduced except in full, without prior written approval of the Company. Any unauthorized alteration, forgery or falsification of the content or appearance of this document is unlawful and offenders may be prosecuted to the fullest extent of the law.

Report Number	:TERF2308001922E2	Test Site	:SAC G Chamber
Operation Mode	:802.11be20	Test Date	:2023-09-18
Test Frequency	:2462 MHz	Temp./Humi.	:23.5°C/55%
Test Mode	:Tx	Antenna Pol.	:Vertical
EUT Pol	:E2 Plane	Engineer	:Temo Chen

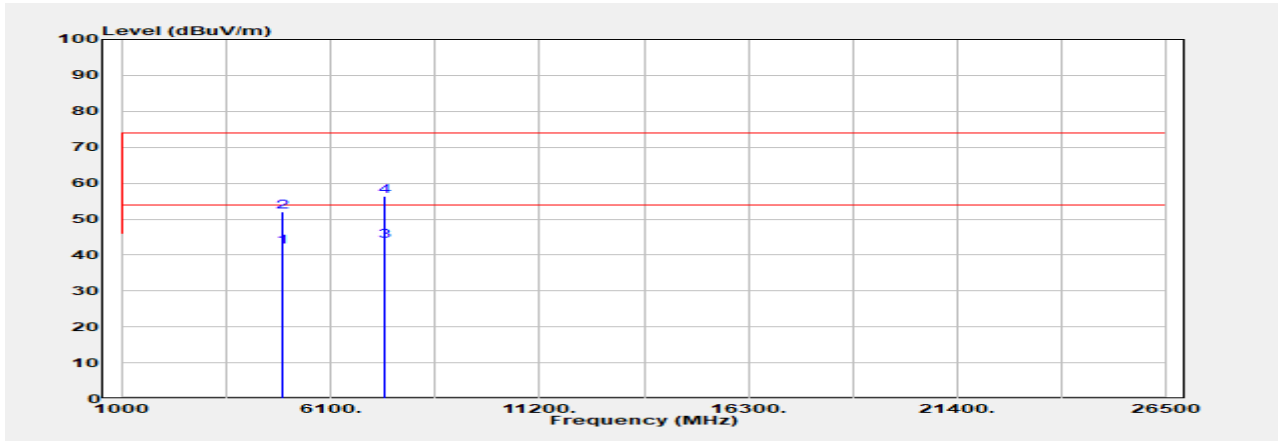

Freq. MHz	Detector Mode PK/QP/AVG	Spectrum Reading Level dBuV	Factor dB	Actual FS dBuV/m	Limit @3m dBuV/m	Margin dB
4924.000	Average	38.94	3.46	42.40	54.00	-11.60
4924.000	Peak	48.66	3.46	52.13	74.00	-21.87
7386.000	Average	34.74	9.03	43.77	54.00	-10.23
7386.000	Peak	47.39	9.03	56.42	74.00	-17.58

Unless otherwise stated the results shown in this test report refer only to the sample(s) tested and such sample(s) are retained for 90 days only.

除非另有說明，此報告結果僅對測試之樣品負責，同時此樣品僅保留90天。本報告未經本公司書面許可，不可部份複製。

This document is issued by the Company subject to its General Conditions of Service printed overleaf, available on request or accessible at <http://www.sgs.com.tw/Terms-and-Conditions> and for electronic format documents, subject to Terms and Conditions for Electronic Documents at <http://www.sgs.com.tw/Terms-and-Conditions>. Attention is drawn to the limitation of liability, indemnification and jurisdiction issues defined therein. Any holder of this document is advised that information contained hereon reflects the Company's findings at the time of its intervention only and within the limits of Client's instructions, if any. The Company's sole responsibility is to its Client and this document does not exonerate parties to a transaction from exercising all their rights and obligations under the transaction documents. This document cannot be reproduced except in full, without prior written approval of the Company. Any unauthorized alteration, forgery or falsification of the content or appearance of this document is unlawful and offenders may be prosecuted to the fullest extent of the law.

Report Number	:TERF2308001922E2	Test Site	:SAC G Chamber
Operation Mode	:802.11be20	Test Date	:2023-09-18
Test Frequency	:2462 MHz	Temp./Humi.	:23.5°C/55%
Test Mode	:Tx	Antenna Pol.	:Horizontal
EUT Pol	:E2 Plane	Engineer	:Temo Chen

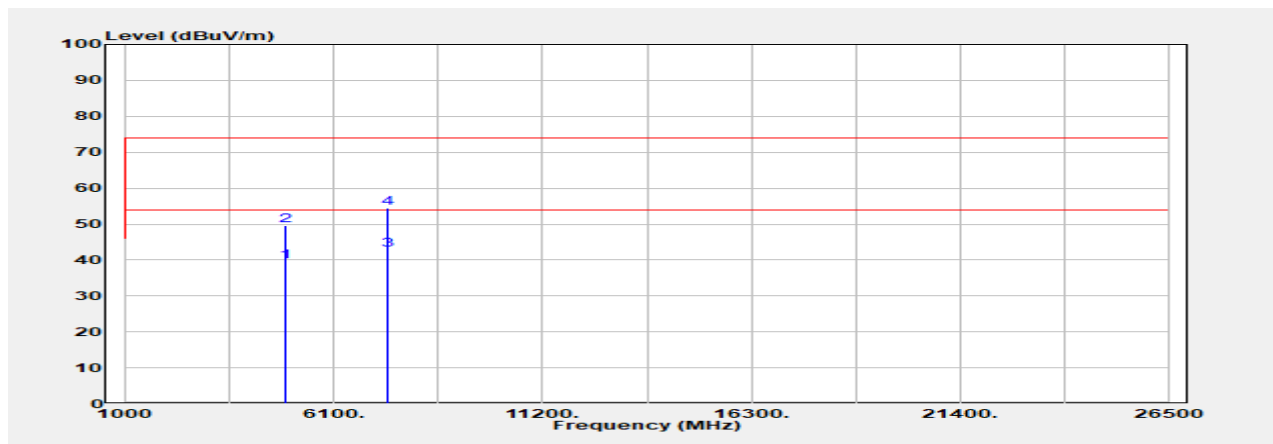

Freq. MHz	Detector Mode PK/QP/AVG	Spectrum Reading Level dBuV	Factor dB	Actual FS dBuV/m	Limit @3m dBuV/m	Margin dB
4924.000	Average	36.17	3.46	39.64	54.00	-14.36
4924.000	Peak	46.15	3.46	49.62	74.00	-24.38
7386.000	Average	33.87	9.03	42.90	54.00	-11.10
7386.000	Peak	45.39	9.03	54.43	74.00	-19.57

Unless otherwise stated the results shown in this test report refer only to the sample(s) tested and such sample(s) are retained for 90 days only.

除非另有說明，此報告結果僅對測試之樣品負責，同時此樣品僅保留90天。本報告未經本公司書面許可，不可部份複製。

This document is issued by the Company subject to its General Conditions of Service printed overleaf, available on request or accessible at <http://www.sgs.com.tw/Terms-and-Conditions> and for electronic format documents, subject to Terms and Conditions for Electronic Documents at <http://www.sgs.com.tw/Terms-and-Conditions>. Attention is drawn to the limitation of liability, indemnification and jurisdiction issues defined therein. Any holder of this document is advised that information contained hereon reflects the Company's findings at the time of its intervention only and within the limits of Client's instructions, if any. The Company's sole responsibility is to its Client and this document does not exonerate parties to a transaction from exercising all their rights and obligations under the transaction documents. This document cannot be reproduced except in full, without prior written approval of the Company. Any unauthorized alteration, forgery or falsification of the content or appearance of this document is unlawful and offenders may be prosecuted to the fullest extent of the law.

Report Number	:TERF2308001922E2	Test Site	:SAC G Chamber
Operation Mode	:802.11be40	Test Date	:2023-09-18
Test Frequency	:2422 MHz	Temp./Humi.	:23.5°C/55%
Test Mode	:Tx	Antenna Pol.	:Vertical
EUT Pol	:E2 Plane	Engineer	:Temo Chen

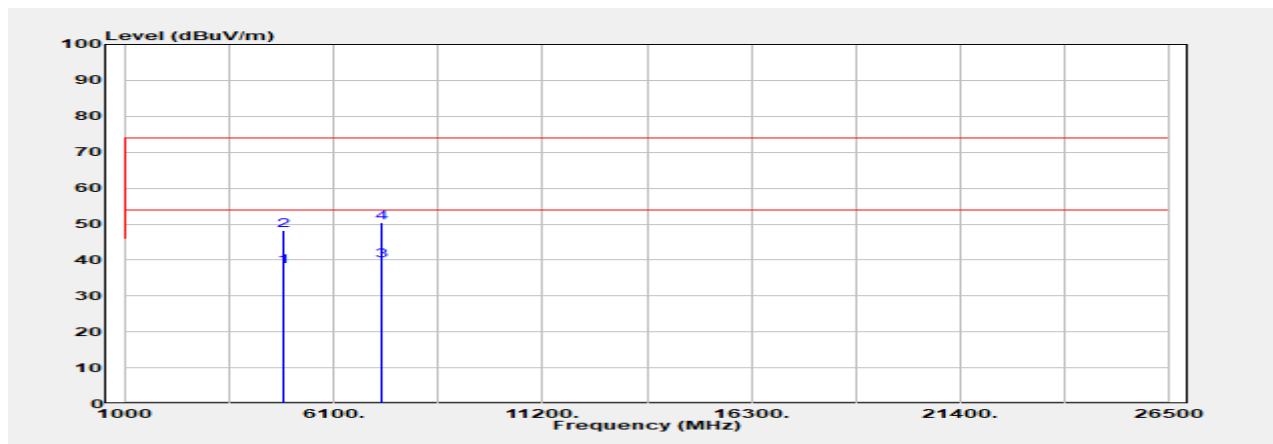

Freq. MHz	Detector Mode PK/QP/AVG	Spectrum Reading Level dBuV	Factor dB	Actual FS dBuV/m	Limit @3m dBuV/m	Margin dB
4844.000	Average	34.97	3.31	38.28	54.00	-15.72
4844.000	Peak	45.03	3.31	48.34	74.00	-25.66
7266.000	Average	31.29	8.53	39.82	54.00	-14.18
7266.000	Peak	41.88	8.53	50.42	74.00	-23.58

Unless otherwise stated the results shown in this test report refer only to the sample(s) tested and such sample(s) are retained for 90 days only.
 除非另有說明，此報告結果僅對測試之樣品負責，同時此樣品僅保留90天。本報告未經本公司書面許可，不可部份複製。

This document is issued by the Company subject to its General Conditions of Service printed overleaf, available on request or accessible at <http://www.sgs.com.tw/Terms-and-Conditions> and for electronic format documents, subject to Terms and Conditions for Electronic Documents at <http://www.sgs.com.tw/Terms-and-Conditions>. Attention is drawn to the limitation of liability, indemnification and jurisdiction issues defined therein. Any holder of this document is advised that information contained hereon reflects the Company's findings at the time of its intervention only and within the limits of Client's instructions, if any. The Company's sole responsibility is to its Client and this document does not exonerate parties to a transaction from exercising all their rights and obligations under the transaction documents. This document cannot be reproduced except in full, without prior written approval of the Company. Any unauthorized alteration, forgery or falsification of the content or appearance of this document is unlawful and offenders may be prosecuted to the fullest extent of the law.

Report Number	:TERF2308001922E2	Test Site	:SAC G Chamber
Operation Mode	:802.11be40	Test Date	:2023-09-18
Test Frequency	:2422 MHz	Temp./Humi.	:23.5°C/55%
Test Mode	:Tx	Antenna Pol.	:Horizontal
EUT Pol	:E2 Plane	Engineer	:Temo Chen

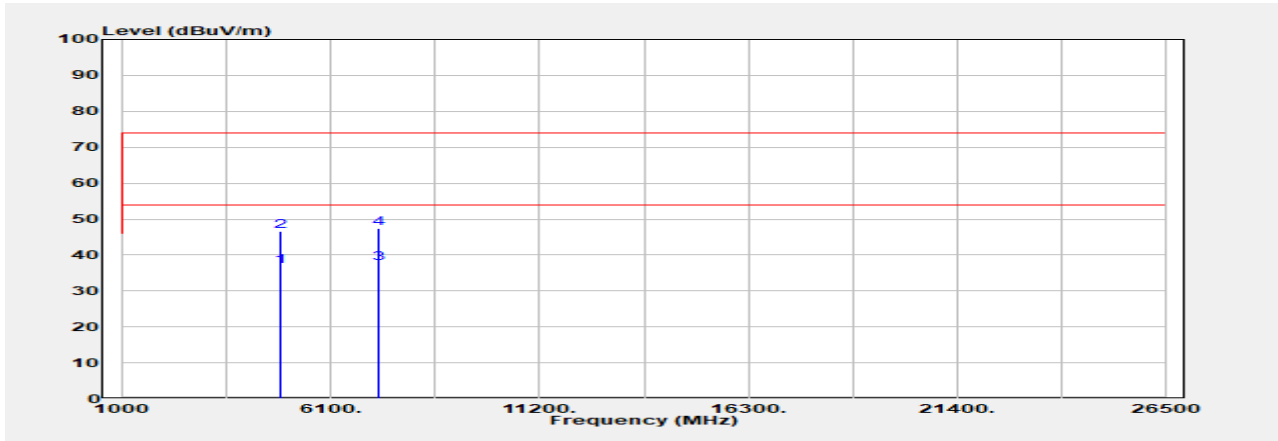

Freq. MHz	Detector Mode PK/QP/AVG	Spectrum Reading Level dBuV	Factor dB	Actual FS dBuV/m	Limit @3m dBuV/m	Margin dB
4844.000	Average	33.48	3.31	36.80	54.00	-17.20
4844.000	Peak	43.37	3.31	46.68	74.00	-27.32
7266.000	Average	29.15	8.53	37.68	54.00	-16.32
7266.000	Peak	39.00	8.53	47.53	74.00	-26.47

Unless otherwise stated the results shown in this test report refer only to the sample(s) tested and such sample(s) are retained for 90 days only.

除非另有說明，此報告結果僅對測試之樣品負責，同時此樣品僅保留90天。本報告未經本公司書面許可，不可部份複製。

This document is issued by the Company subject to its General Conditions of Service printed overleaf, available on request or accessible at <http://www.sgs.com.tw/Terms-and-Conditions> and for electronic format documents, subject to Terms and Conditions for Electronic Documents at <http://www.sgs.com.tw/Terms-and-Conditions>. Attention is drawn to the limitation of liability, indemnification and jurisdiction issues defined therein. Any holder of this document is advised that information contained hereon reflects the Company's findings at the time of its intervention only and within the limits of Client's instructions, if any. The Company's sole responsibility is to its Client and this document does not exonerate parties to a transaction from exercising all their rights and obligations under the transaction documents. This document cannot be reproduced except in full, without prior written approval of the Company. Any unauthorized alteration, forgery or falsification of the content or appearance of this document is unlawful and offenders may be prosecuted to the fullest extent of the law.

Report Number	:TERF2308001922E2	Test Site	:SAC G Chamber
Operation Mode	:802.11be40	Test Date	:2023-09-18
Test Frequency	:2437 MHz	Temp./Humi.	:23.5°C/55%
Test Mode	:Tx	Antenna Pol.	:Vertical
EUT Pol	:E2 Plane	Engineer	:Temo Chen

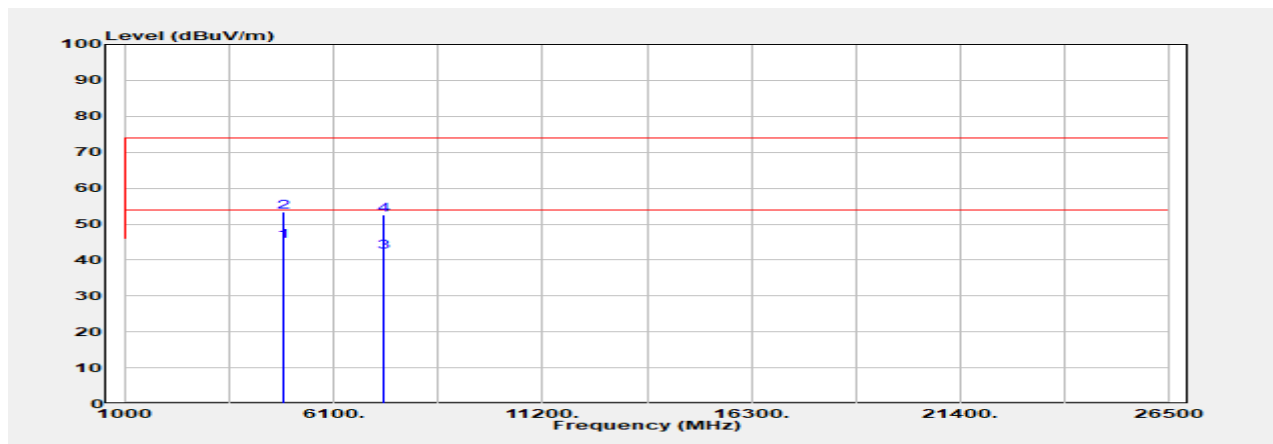

Freq. MHz	Detector Mode PK/QP/AVG	Spectrum Reading Level dBuV	Factor dB	Actual FS dBuV/m	Limit @3m dBuV/m	Margin dB
4874.000	Average	41.82	3.35	45.18	54.00	-8.82
4874.000	Peak	50.06	3.35	53.42	74.00	-20.58
7311.000	Average	33.69	8.58	42.27	54.00	-11.73
7311.000	Peak	43.87	8.58	52.44	74.00	-21.56

Unless otherwise stated the results shown in this test report refer only to the sample(s) tested and such sample(s) are retained for 90 days only.

除非另有說明，此報告結果僅對測試之樣品負責，同時此樣品僅保留90天。本報告未經本公司書面許可，不可部份複製。

This document is issued by the Company subject to its General Conditions of Service printed overleaf, available on request or accessible at <http://www.sgs.com.tw/Terms-and-Conditions> and for electronic format documents, subject to Terms and Conditions for Electronic Documents at <http://www.sgs.com.tw/Terms-and-Conditions>. Attention is drawn to the limitation of liability, indemnification and jurisdiction issues defined therein. Any holder of this document is advised that information contained hereon reflects the Company's findings at the time of its intervention only and within the limits of Client's instructions, if any. The Company's sole responsibility is to its Client and this document does not exonerate parties to a transaction from exercising all their rights and obligations under the transaction documents. This document cannot be reproduced except in full, without prior written approval of the Company. Any unauthorized alteration, forgery or falsification of the content or appearance of this document is unlawful and offenders may be prosecuted to the fullest extent of the law.

Report Number	:TERF2308001922E2	Test Site	:SAC G Chamber
Operation Mode	:802.11be40	Test Date	:2023-09-18
Test Frequency	:2437 MHz	Temp./Humi.	:23.5°C/55%
Test Mode	:Tx	Antenna Pol.	:Horizontal
EUT Pol	:E2 Plane	Engineer	:Temo Chen

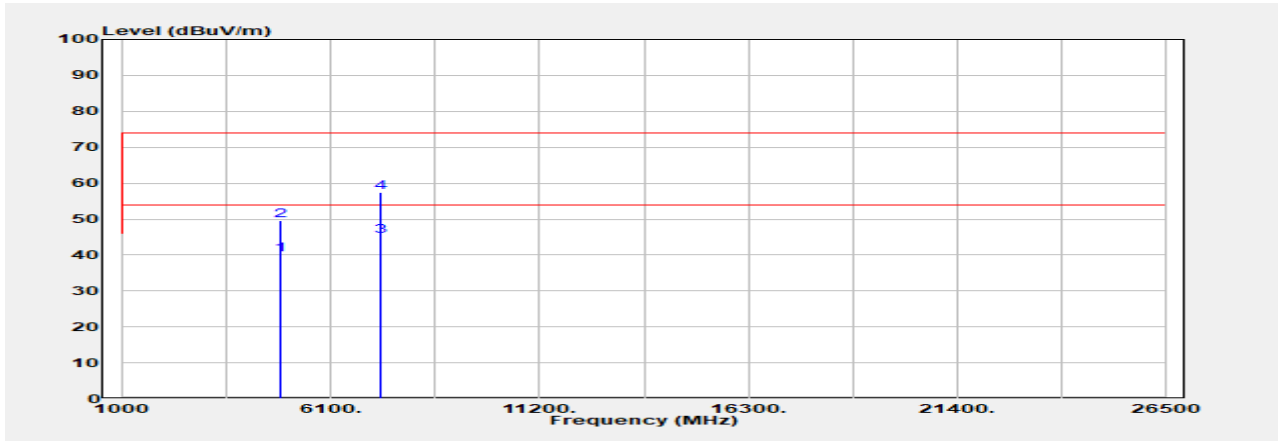

Freq. MHz	Detector Mode PK/QP/AVG	Spectrum Reading Level dBuV	Factor dB	Actual FS dBuV/m	Limit @3m dBuV/m	Margin dB
4874.000	Average	36.83	3.35	40.18	54.00	-13.82
4874.000	Peak	46.27	3.35	49.62	74.00	-24.38
7311.000	Average	36.65	8.58	45.23	54.00	-8.77
7311.000	Peak	48.96	8.58	57.54	74.00	-16.46

Unless otherwise stated the results shown in this test report refer only to the sample(s) tested and such sample(s) are retained for 90 days only.

除非另有說明，此報告結果僅對測試之樣品負責，同時此樣品僅保留90天。本報告未經本公司書面許可，不可部份複製。

This document is issued by the Company subject to its General Conditions of Service printed overleaf, available on request or accessible at <http://www.sgs.com.tw/Terms-and-Conditions> and for electronic format documents, subject to Terms and Conditions for Electronic Documents at <http://www.sgs.com.tw/Terms-and-Conditions>. Attention is drawn to the limitation of liability, indemnification and jurisdiction issues defined therein. Any holder of this document is advised that information contained hereon reflects the Company's findings at the time of its intervention only and within the limits of Client's instructions, if any. The Company's sole responsibility is to its Client and this document does not exonerate parties to a transaction from exercising all their rights and obligations under the transaction documents. This document cannot be reproduced except in full, without prior written approval of the Company. Any unauthorized alteration, forgery or falsification of the content or appearance of this document is unlawful and offenders may be prosecuted to the fullest extent of the law.

Report Number	:TERF2308001922E2	Test Site	:SAC G Chamber
Operation Mode	:802.11be40	Test Date	:2023-09-18
Test Frequency	:2452 MHz	Temp./Humi.	:23.5°C/55%
Test Mode	:Tx	Antenna Pol.	:Vertical
EUT Pol	:E2 Plane	Engineer	:Temo Chen

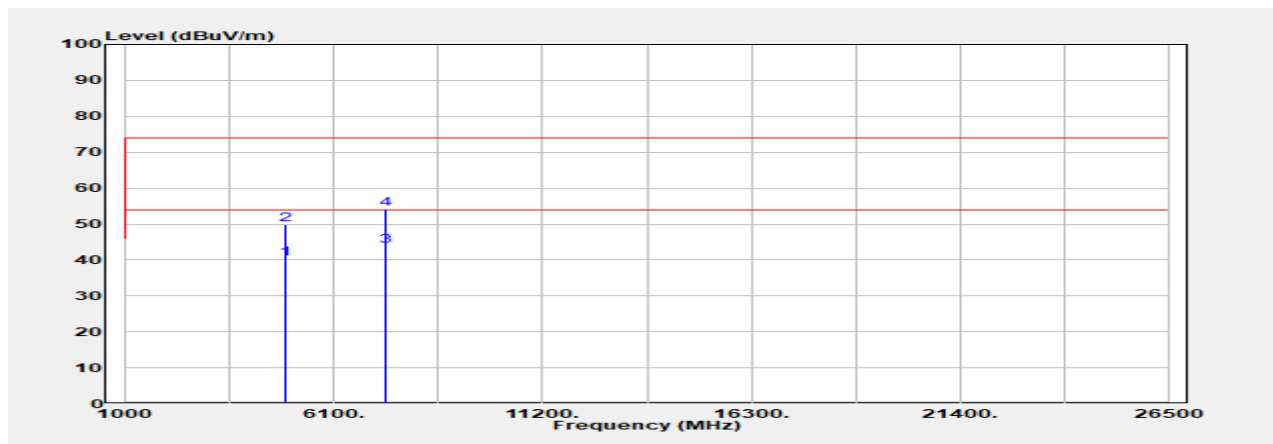

Freq. MHz	Detector Mode PK/QP/AVG	Spectrum Reading Level dBuV	Factor dB	Actual FS dBuV/m	Limit @3m dBuV/m	Margin dB
4904.000	Average	36.87	3.40	40.28	54.00	-13.72
4904.000	Peak	46.59	3.40	49.99	74.00	-24.01
7356.000	Average	34.89	8.88	43.77	54.00	-10.23
7356.000	Peak	45.25	8.88	54.13	74.00	-19.87

Unless otherwise stated the results shown in this test report refer only to the sample(s) tested and such sample(s) are retained for 90 days only.
 除非另有說明，此報告結果僅對測試之樣品負責，同時此樣品僅保留90天。本報告未經本公司書面許可，不可部份複製。

This document is issued by the Company subject to its General Conditions of Service printed overleaf, available on request or accessible at <http://www.sgs.com.tw/Terms-and-Conditions> and for electronic format documents, subject to Terms and Conditions for Electronic Documents at <http://www.sgs.com.tw/Terms-and-Conditions>. Attention is drawn to the limitation of liability, indemnification and jurisdiction issues defined therein. Any holder of this document is advised that information contained hereon reflects the Company's findings at the time of its intervention only and within the limits of Client's instructions, if any. The Company's sole responsibility is to its Client and this document does not exonerate parties to a transaction from exercising all their rights and obligations under the transaction documents. This document cannot be reproduced except in full, without prior written approval of the Company. Any unauthorized alteration, forgery or falsification of the content or appearance of this document is unlawful and offenders may be prosecuted to the fullest extent of the law.

Report Number	:TERF2308001922E2	Test Site	:SAC G Chamber
Operation Mode	:802.11be40	Test Date	:2023-09-18
Test Frequency	:2452 MHz	Temp./Humi.	:23.5°C/55%
Test Mode	:Tx	Antenna Pol.	:Horizontal
EUT Pol	:E2 Plane	Engineer	:Temo Chen

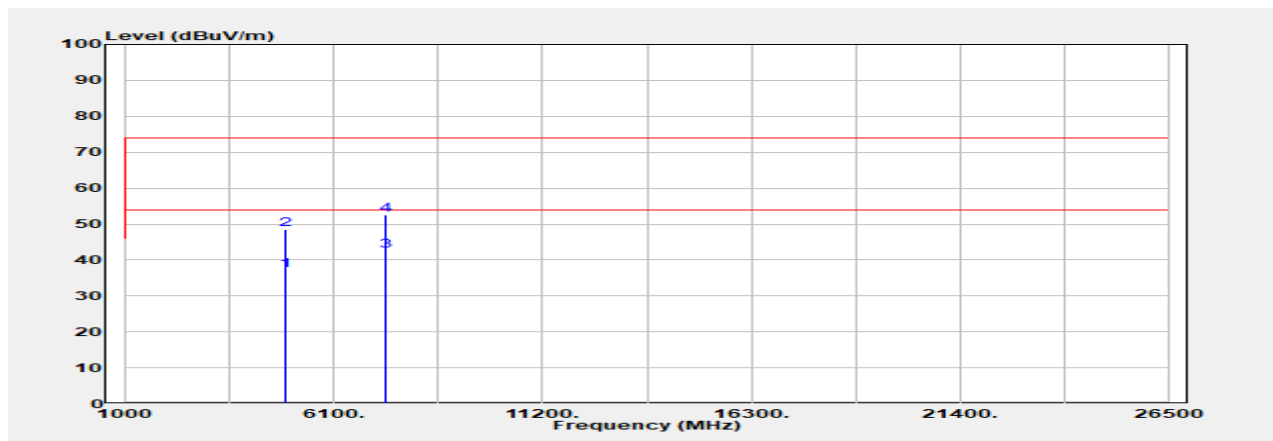

Freq. MHz	Detector Mode PK/QP/AVG	Spectrum Reading Level dBuV	Factor dB	Actual FS dBuV/m	Limit @3m dBuV/m	Margin dB
4904.000	Average	33.71	3.40	37.11	54.00	-16.89
4904.000	Peak	45.01	3.40	48.41	74.00	-25.59
7356.000	Average	33.62	8.88	42.50	54.00	-11.50
7356.000	Peak	43.79	8.88	52.67	74.00	-21.33

Unless otherwise stated the results shown in this test report refer only to the sample(s) tested and such sample(s) are retained for 90 days only.
 除非另有說明，此報告結果僅對測試之樣品負責，同時此樣品僅保留90天。本報告未經本公司書面許可，不可部份複製。

This document is issued by the Company subject to its General Conditions of Service printed overleaf, available on request or accessible at <http://www.sgs.com.tw/Terms-and-Conditions> and for electronic format documents, subject to Terms and Conditions for Electronic Documents at <http://www.sgs.com.tw/Terms-and-Conditions>. Attention is drawn to the limitation of liability, indemnification and jurisdiction issues defined therein. Any holder of this document is advised that information contained hereon reflects the Company's findings at the time of its intervention only and within the limits of Client's instructions, if any. The Company's sole responsibility is to its Client and this document does not exonerate parties to a transaction from exercising all their rights and obligations under the transaction documents. This document cannot be reproduced except in full, without prior written approval of the Company. Any unauthorized alteration, forgery or falsification of the content or appearance of this document is unlawful and offenders may be prosecuted to the fullest extent of the law.

12 POWER SPECTRAL DENSITY

12.1 Standard Applicable

Per Part 15.247 (e) The power spectral density conducted from the intentional radiator to the antenna shall not be greater than 8dBm in any 3 kHz band during any time interval of continuous transmission.

12.2 Test Setup

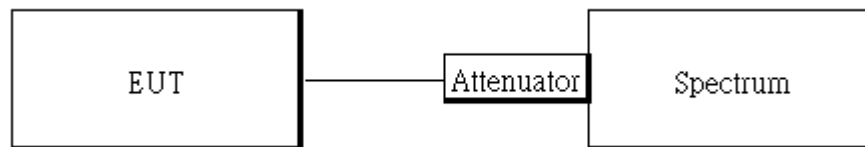

12.3 Measurement Procedure

1. Set analyzer center frequency to DTS channel center frequency.
2. The testing follows the Measurement Procedure of FCC KDB 558074 D01 DTS Meas. Guidance and C63.10 section 11.10.1(a)(b)(c) Method AVGPSD or section 11.10.2 Method PKPSD
3. Set the span to 1.5 times the DTS channel bandwidth.
4. Set the RBW = 3 kHz & VBW = 10 kHz.
5. Detector = PEAK for PKPSD procedure or RMS for AVGPSD Procedure
6. Sweep time = auto couple.
7. Trace mode = max hold for PKPSD procedure or according to AVGPSD Procedure relevant method
8. Allow trace to fully stabilize.
9. Use the peak marker function to determine the maximum amplitude level.

Note:

For the test of MIMO mode, the highest emission of worst case employing Measure and add 10 log (N) technical is reported on this report after the comparison between Main Antenna at single transmitting mode and Aux that yields the higher value. The MIMO transmitting mode produces higher value of outcome.

Unless otherwise stated the results shown in this test report refer only to the sample(s) tested and such sample(s) are retained for 90 days only.
除非另有說明，此報告結果僅對測試之樣品負責，同時此樣品僅保留90天。本報告未經本公司書面許可，不可部份複製。

This document is issued by the Company subject to its General Conditions of Service printed overleaf, available on request or accessible at <http://www.sgs.com.tw/Terms-and-Conditions> and for electronic format documents, subject to Terms and Conditions for Electronic Documents at <http://www.sgs.com.tw/Terms-and-Conditions>. Attention is drawn to the limitation of liability, indemnification and jurisdiction issues defined therein. Any holder of this document is advised that information contained hereon reflects the Company's findings at the time of its intervention only and within the limits of Client's instructions, if any. The Company's sole responsibility is to its Client and this document does not exonerate parties to a transaction from exercising all their rights and obligations under the transaction documents. This document cannot be reproduced except in full, without prior written approval of the Company. Any unauthorized alteration, forgery or falsification of the content or appearance of this document is unlawful and offenders may be prosecuted to the fullest extent of the law.

12.4 As per FCC KDB 662911 D01

As per section F. 2). e). (ii) of FCC KDB 662911 D01

If antenna gains are not equal and each transmit antenna is driven by only one spatial stream, directional gain may be calculated by either of the following formulas.

$$\bullet \quad \text{DirectionalGain} = 10 \cdot \log \left[\frac{\sum_{j=1}^{N_{SS}} \left\{ \sum_{k=1}^{N_{ANT}} g_{j,k} \right\}^2}{N_{ANT}} \right]$$

where

Each antenna is driven by no more than one spatial stream;

NSS = the number of independent spatial streams of data;

NANT = the total number of antennas

$g_{j,k} = / 20 \text{ 10Gk}$ if the kth antenna is being fed by spatial stream j, or zero if it is not;

G_k is the gain in dBi of the kth antenna.

The antenna gain is not greater than 6 dBi. Therefore, reduction of power is not required.

Unless otherwise stated the results shown in this test report refer only to the sample(s) tested and such sample(s) are retained for 90 days only.
 除非另有說明，此報告結果僅對測試之樣品負責，同時此樣品僅保留90天。本報告未經本公司書面許可，不可部份複製。

This document is issued by the Company subject to its General Conditions of Service printed overleaf, available on request or accessible at <http://www.sgs.com.tw/Terms-and-Conditions> and for electronic format documents, subject to Terms and Conditions for Electronic Documents at <http://www.sgs.com.tw/Terms-and-Conditions>. Attention is drawn to the limitation of liability, indemnification and jurisdiction issues defined therein. Any holder of this document is advised that information contained hereon reflects the Company's findings at the time of its intervention only and within the limits of Client's instructions, if any. The Company's sole responsibility is to its Client and this document does not exonerate parties to a transaction from exercising all their rights and obligations under the transaction documents. This document cannot be reproduced except in full, without prior written approval of the Company. Any unauthorized alteration, forgery or falsification of the content or appearance of this document is unlawful and offenders may be prosecuted to the fullest extent of the law.

12.5 Power spectral density

Mode: CDD

POWER DENSITY 802.11b							
Freq. (MHz)	Ch0 PSD	Ch1 PSD	Ch2 PSD	Ch3 PSD	PSD (dBm/3kHz)	Limit (dBm/3kHz)	Result
2412	0.06	0.58	0.08	0.07	6.22	8.00	PASS
2437	-0.93	-0.92	-0.47	-0.66	5.28	8.00	PASS
2462	-0.46	-0.21	-0.26	-0.21	5.74	8.00	PASS

POWER DENSITY 802.11g							
Freq. (MHz)	Ch0 PSD	Ch1 PSD	Ch2 PSD	Ch3 PSD	PSD (dBm/3kHz)	Limit (dBm/3kHz)	Result
2412	-1.83	-1.31	-2.68	-1.99	4.10	8.00	PASS
2437	-3.56	-2.86	-2.87	-2.02	3.23	8.00	PASS
2462	-2.28	-1.98	-2.49	-2.22	3.78	8.00	PASS

POWER DENSITY 802.11n HT20							
Freq. (MHz)	Ch0 PSD	Ch1 PSD	Ch2 PSD	Ch3 PSD	PSD (dBm/3kHz)	Limit (dBm/3kHz)	Result
2412	-1.06	-0.91	-0.98	0.06	5.32	8.00	PASS
2437	-3.1	-1.27	-1.27	-1.82	4.22	8.00	PASS
2462	-1.72	-1.1	-1.62	-0.78	4.73	8.00	PASS

POWER DENSITY 802.11n HT40							
Freq. (MHz)	Ch0 PSD	Ch1 PSD	Ch2 PSD	Ch3 PSD	PSD (dBm/3kHz)	Limit (dBm/3kHz)	Result
2422	-4.64	-3.83	-4.65	-3.42	1.92	8.00	PASS
2437	-5.42	-4.75	-4.95	-5.73	0.83	8.00	PASS
2452	-4.97	-5.81	-5.2	-5.34	0.70	8.00	PASS

POWER DENSITY 802.11be EHT20								
Freq. (MHz)	RU Config	Ch0 PSD	Ch1 PSD	Ch2 PSD	Ch3 PSD	PSD (dBm/3kHz)	Limit (dBm/3kHz)	Result
2412	full	-2.57	-2.34	-3.25	-2.95	3.26	8.00	PASS
2437	full	-4.02	-2.91	-3.15	-3.22	2.72	8.00	PASS
2462	full	-2.29	-2.5	-2.51	-1.81	3.75	8.00	PASS

Unless otherwise stated the results shown in this test report refer only to the sample(s) tested and such sample(s) are retained for 90 days only.

除非另有說明，此報告結果僅對測試之樣品負責，同時此樣品僅保留90天。本報告未經本公司書面許可，不可部份複製。

This document is issued by the Company subject to its General Conditions of Service printed overleaf, available on request or accessible at <http://www.sgs.com.tw/Terms-and-Conditions> and for electronic format documents, subject to Terms and Conditions for Electronic Documents at <http://www.sgs.com.tw/Terms-and-Conditions>. Attention is drawn to the limitation of liability, indemnification and jurisdiction issues defined therein. Any holder of this document is advised that information contained hereon reflects the Company's findings at the time of its intervention only and within the limits of Client's instructions, if any. The Company's sole responsibility is to its Client and this document does not exonerate parties to a transaction from exercising all their rights and obligations under the transaction documents. This document cannot be reproduced except in full, without prior written approval of the Company. Any unauthorized alteration, forgery or falsification of the content or appearance of this document is unlawful and offenders may be prosecuted to the fullest extent of the law.

POWER DENSITY 802.11be EHT40								
Freq. (MHz)	RU Config	Ch0 PSD	Ch1 PSD	Ch2 PSD	Ch3 PSD	PSD (dBm/3kHz)	Limit (dBm/3kHz)	Result
2422	full	-5.46	-4.61	-5.28	-5.8	0.76	8.00	PASS
2437	full	-6.48	-6.23	-6.26	-6.61	-0.37	8.00	PASS
2452	full	-5.97	-5.49	-5.88	-5.76	0.25	8.00	PASS

Unless otherwise stated the results shown in this test report refer only to the sample(s) tested and such sample(s) are retained for 90 days only.
 除非另有說明，此報告結果僅對測試之樣品負責，同時此樣品僅保留90天。本報告未經本公司書面許可，不可部份複製。

This document is issued by the Company subject to its General Conditions of Service printed overleaf, available on request or accessible at <http://www.sgs.com.tw/Terms-and-Conditions> and for electronic format documents, subject to Terms and Conditions for Electronic Documents at <http://www.sgs.com.tw/Terms-and-Conditions>. Attention is drawn to the limitation of liability, indemnification and jurisdiction issues defined therein. Any holder of this document is advised that information contained hereon reflects the Company's findings at the time of its intervention only and within the limits of Client's instructions, if any. The Company's sole responsibility is to its Client and this document does not exonerate parties to a transaction from exercising all their rights and obligations under the transaction documents. This document cannot be reproduced except in full, without prior written approval of the Company. Any unauthorized alteration, forgery or falsification of the content or appearance of this document is unlawful and offenders may be prosecuted to the fullest extent of the law.

CDD_802.11b_20MHz_Chain0_2412MHz



802.11b_20MHz_Chain1_2412MHz



802.11b_20MHz_Chain0_2437MHz



802.11b_20MHz_Chain1_2437MHz



802.11b_20MHz_Chain0_2462MHz



802.11b_20MHz_Chain1_2462MHz



Unless otherwise stated the results shown in this test report refer only to the sample(s) tested and such sample(s) are retained for 90 days only.

除非另有說明，此報告結果僅對測試之樣品負責，同時此樣品僅保留90天。本報告未經本公司書面許可，不可部份複製。

This document is issued by the Company subject to its General Conditions of Service printed overleaf, available on request or accessible at <http://www.sgs.com.tw/Terms-and-Conditions> and for electronic format documents, subject to Terms and Conditions for Electronic Documents at <http://www.sgs.com.tw/Terms-and-Conditions>. Attention is drawn to the limitation of liability, indemnification and jurisdiction issues defined therein. Any holder of this document is advised that information contained hereon reflects the Company's findings at the time of its intervention only and within the limits of Client's instructions, if any. The Company's sole responsibility is to its Client and this document does not exonerate parties to a transaction from exercising all their rights and obligations under the transaction documents. This document cannot be reproduced except in full, without prior written approval of the Company. Any unauthorized alteration, forgery or falsification of the content or appearance of this document is unlawful and offenders may be prosecuted to the fullest extent of the law.

802.11b_20MHz_Chain2_2412MHz



802.11b_20MHz_Chain3_2412MHz



802.11b_20MHz_Chain2_2437MHz



802.11b_20MHz_Chain3_2437MHz



802.11b_20MHz_Chain2_2462MHz



802.11b_20MHz_Chain3_2462MHz



Unless otherwise stated the results shown in this test report refer only to the sample(s) tested and such sample(s) are retained for 90 days only.

除非另有說明，此報告結果僅對測試之樣品負責，同時此樣品僅保留90天。本報告未經本公司書面許可，不可部份複製。

This document is issued by the Company subject to its General Conditions of Service printed overleaf, available on request or accessible at <http://www.sgs.com.tw/Terms-and-Conditions> and for electronic format documents, subject to Terms and Conditions for Electronic Documents at <http://www.sgs.com.tw/Terms-and-Conditions>. Attention is drawn to the limitation of liability, indemnification and jurisdiction issues defined therein. Any holder of this document is advised that information contained hereon reflects the Company's findings at the time of its intervention only and within the limits of Client's instructions, if any. The Company's sole responsibility is to its Client and this document does not exonerate parties to a transaction from exercising all their rights and obligations under the transaction documents. This document cannot be reproduced except in full, without prior written approval of the Company. Any unauthorized alteration, forgery or falsification of the content or appearance of this document is unlawful and offenders may be prosecuted to the fullest extent of the law.

802.11g_20MHz_Chain0_2412MHz



802.11g_20MHz_Chain1_2412MHz



802.11g_20MHz_Chain0_2437MHz



802.11g_20MHz_Chain1_2437MHz



802.11g_20MHz_Chain0_2462MHz



802.11g_20MHz_Chain1_2462MHz

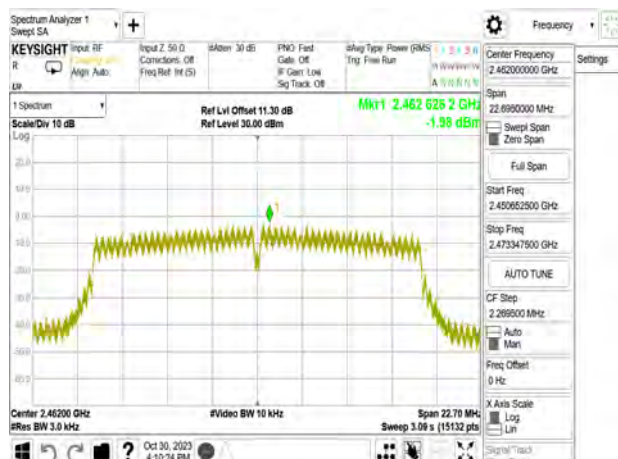

Unless otherwise stated the results shown in this test report refer only to the sample(s) tested and such sample(s) are retained for 90 days only.

除非另有說明，此報告結果僅對測試之樣品負責，同時此樣品僅保留90天。本報告未經本公司書面許可，不可部份複製。

This document is issued by the Company subject to its General Conditions of Service printed overleaf, available on request or accessible at <http://www.sgs.com.tw/Terms-and-Conditions> and for electronic format documents, subject to Terms and Conditions for Electronic Documents at <http://www.sgs.com.tw/Terms-and-Conditions>. Attention is drawn to the limitation of liability, indemnification and jurisdiction issues defined therein. Any holder of this document is advised that information contained hereon reflects the Company's findings at the time of its intervention only and within the limits of Client's instructions, if any. The Company's sole responsibility is to its Client and this document does not exonerate parties to a transaction from exercising all their rights and obligations under the transaction documents. This document cannot be reproduced except in full, without prior written approval of the Company. Any unauthorized alteration, forgery or falsification of the content or appearance of this document is unlawful and offenders may be prosecuted to the fullest extent of the law.

802.11g_20MHz_Chain2_2412MHz

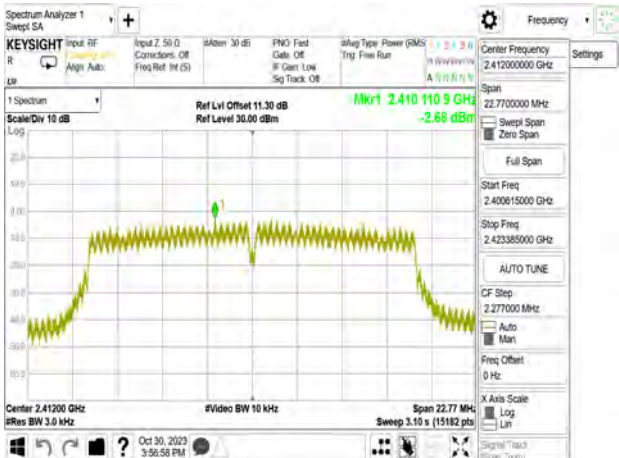

802.11g_20MHz_Chain3_2412MHz

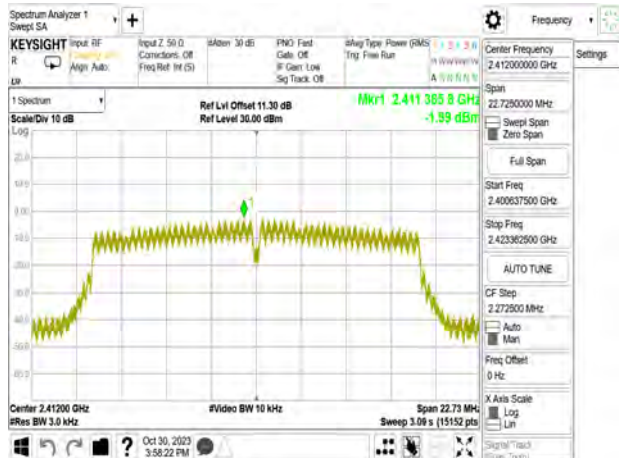

802.11g_20MHz_Chain2_2437MHz



802.11g_20MHz_Chain3_2437MHz

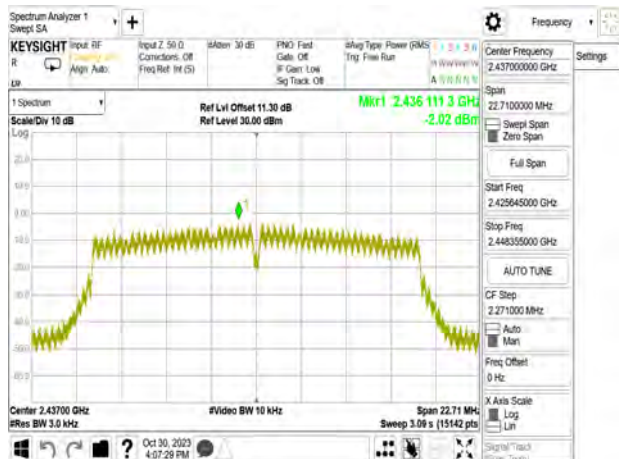

802.11g_20MHz_Chain2_2462MHz



802.11g_20MHz_Chain3_2462MHz



Unless otherwise stated the results shown in this test report refer only to the sample(s) tested and such sample(s) are retained for 90 days only.

除非另有說明，此報告結果僅對測試之樣品負責，同時此樣品僅保留90天。本報告未經本公司書面許可，不可部份複製。

This document is issued by the Company subject to its General Conditions of Service printed overleaf, available on request or accessible at <http://www.sgs.com.tw/Terms-and-Conditions> and for electronic format documents, subject to Terms and Conditions for Electronic Documents at <http://www.sgs.com.tw/Terms-and-Conditions>. Attention is drawn to the limitation of liability, indemnification and jurisdiction issues defined therein. Any holder of this document is advised that information contained hereon reflects the Company's findings at the time of its intervention only and within the limits of Client's instructions, if any. The Company's sole responsibility is to its Client and this document does not exonerate parties to a transaction from exercising all their rights and obligations under the transaction documents. This document cannot be reproduced except in full, without prior written approval of the Company. Any unauthorized alteration, forgery or falsification of the content or appearance of this document is unlawful and offenders may be prosecuted to the fullest extent of the law.