

# MEASUREMENT REPORT

## FCC Part 15B

---

**FCC ID:** H8N-ASK-MAE311  
**Applicant:** Askey Computer Corporation  
**Application Type:** Certification  
**Product:** Stream TV MoCA Ethernet Adapter  
**Model Number:** ASK-MAE311  
**Brand Name:** verizon  
**FCC Rule Part(s):** FCC Part 15 Subpart B: 2021 (Class B)  
**Test Procedure(s):** ANSI C63.4: 2014, ANSI C63.4a: 2017  
**Received Date:** February 19, 2021  
**Test Date:** February 24 ~ 26, 2021

**Tested By:** Fran Chen

(Fran Chen)

**Reviewed By:** Paddy Chen

(Paddy Chen )

**Approved By:** Chenz Ker

(Chenz Ker)



Testing Laboratory

3261

The test results only relate to the tested sample.

This equipment has been shown to be capable of compliance with the applicable technical standards as indicated in the measurement report and was tested in accordance with the measurement procedures specified in ANSI C63.4. Test results reported herein relate only to the item(s) tested.

The test report shall not be reproduced except in full without the written approval of MRT Technology (Taiwan) Co., Ltd.

---

## Revision History

Report No.	Version	Description	Issue Date	Note
2102TW0102-U1	0.0	Original Report	2021-03-17	Valid

---

## CONTENTS

Description	Page
<b>1. INTRODUCTION .....</b>	<b>5</b>
1.1 Scope .....	5
1.2 MRT Test Location .....	5
<b>2. PRODUCT INFORMATION .....</b>	<b>6</b>
2.1 Equipment Description.....	6
2.2 Test Mode.....	6
2.3 Test Configuration .....	7
2.4 Test System Details.....	8
2.5 Test Software .....	8
2.6 EMI Suppression Device(s)/Modifications.....	8
<b>3. DESCRIPTION OF TEST .....</b>	<b>9</b>
3.1 Evaluation Procedure .....	9
3.2 AC Line Conducted Emissions .....	9
3.3 Radiated Emissions.....	10
<b>4. TEST EQUIPMENT CALIBRATION DATE.....</b>	<b>11</b>
<b>5. MEASUREMENT UNCERTAINTY.....</b>	<b>12</b>
<b>6. TEST RESULT .....</b>	<b>13</b>
6.1 Summary .....	13
6.2 Conducted Emission Measurement .....	14
6.2.1 Test Limit .....	14
6.2.2 Test Setup .....	14
6.2.3 Test Result.....	15
6.3 Radiated Emission Measurement .....	17
6.3.1 Test Limit .....	17
6.3.1 Test Setup .....	18
6.3.2 Test Result.....	20
<b>7. CONCLUSION.....</b>	<b>24</b>
<b>Appendix A - Test Photograph .....</b>	<b>25</b>
<b>Appendix B - External Photograph.....</b>	<b>27</b>
<b>Appendix C - Internal Photograph .....</b>	<b>32</b>

## §2.1033 General Information

<b>Applicant</b>	Askey Computer Corporation
<b>Applicant Address</b>	10F, No. 119, Jiankang Rd., Zhonghe Dist., New Taipei City, Taiwan
<b>Manufacturer</b>	Askey Computer Corporation
<b>Manufacturer Address</b>	10F, No. 119, Jiankang Rd., Zhonghe Dist., New Taipei City, Taiwan
<b>Test Site</b>	MRT Technology (Taiwan) Co., Ltd
<b>Test Site Address</b>	No. 38, Fuxing Second Rd., Guishan Dist., Taoyuan City 333, Taiwan (R.O.C)
<b>MRT FCC Registration No.</b>	153292
<b>Test Device Serial No.</b>	N/A <input type="checkbox"/> Production <input checked="" type="checkbox"/> Pre-Production <input type="checkbox"/> Engineering

### Test Facility / Accreditations

Measurements were performed at MRT Laboratory located in Fuxing Rd., Taoyuan, Taiwan ( R.O.C )

- MRT facility is a FCC registered (Reg. No. 153292) test facility with the site description report on file and is designated by the FCC as an Accredited Test Firm.
- MRT facility is an IC registered (MRT Reg. No. 21723) test laboratory with the site description on file at Industry Canada.
- MRT Lab is accredited to ISO 17025 by the Taiwan Accreditation Foundation (TAF Cert. No. 3261) in EMC, Telecommunications and Radio testing for FCC (Designation Number: TW3261), Industry Taiwan, EU and TELEC Rules.

## 1. INTRODUCTION

### 1.1 Scope

Measurement and determination of electromagnetic emissions (EMC) of radio frequency devices including intentional and/or unintentional radiators for compliance with the technical rules and regulations of the Federal Communications Commission and the Industry Canada Certification and Engineering Bureau.

### 1.2 MRT Test Location

The map below shows the location of the MRT LABORATORY, its proximity to the Taoyuan City. These measurement tests were conducted at the MRT Technology (Taiwan) Co., Ltd. Facility located at No.38, Fuxing 2nd Rd., Guishan Dist., Taoyuan City 33377, Taiwan (R.O.C).

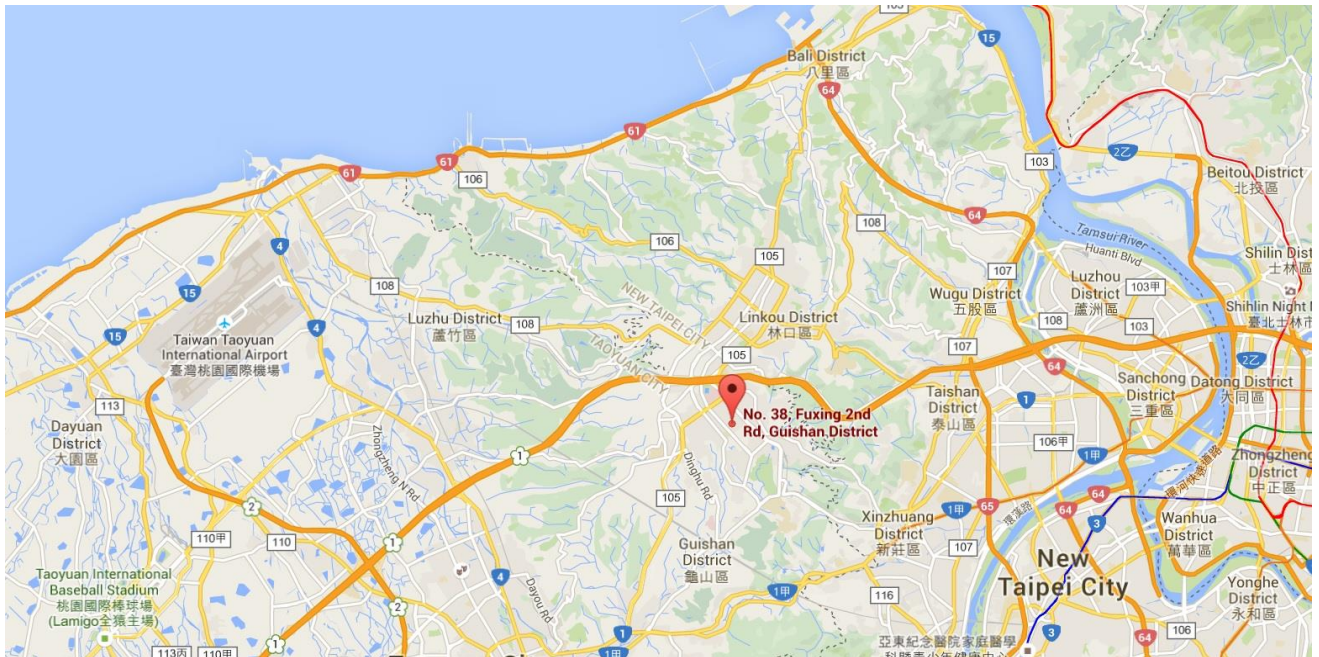

## 2. PRODUCT INFORMATION

### 2.1 Equipment Description

Product Name	Stream TV MoCA Ethernet Adapter
Brand Name	verizon
Model Number	ASK-MAE311
Highest Operating Frequency	1675MHz

### 2.2 Test Mode

Pre-Test Mode	
EMI Mode	Mode1: Normal Operation
Final Test Mode	
EMI Mode	Mode1: Normal Operation

### 2.3 Test Configuration

The **Stream TV MoCA Ethernet Adapter** was tested per the guidance FCC Part 15 Subpart B: 2021 and ANSI C63.4: 2014 / ANSI C63.4a: 2017 was used to reference the appropriate EUT setup for radiated spurious emissions testing and AC line conducted testing.

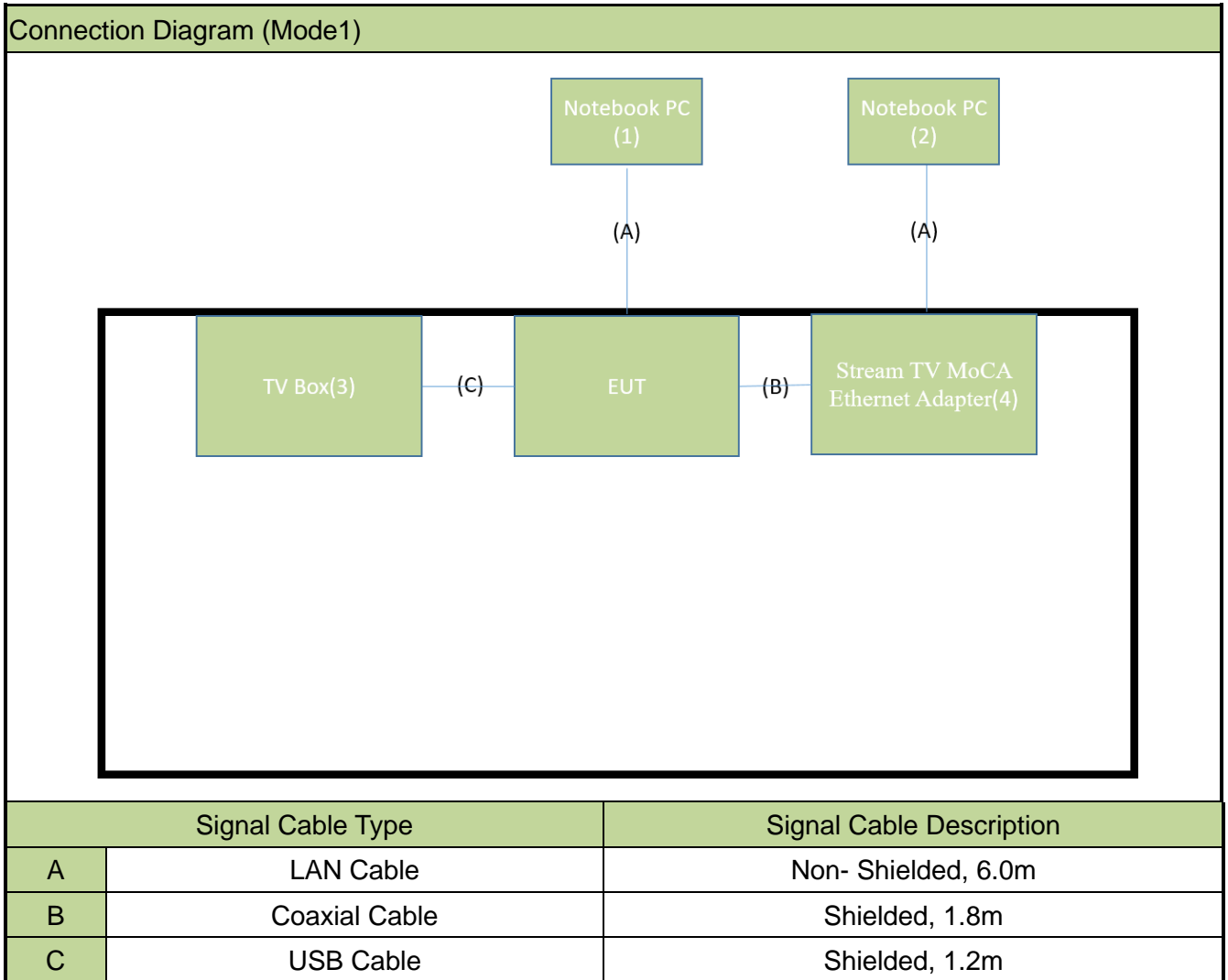

## 2.4 Test System Details

The types for all equipment, and descriptions of all cables used in the tested system (including inserted cards) are:

### Mode1:

	Product	Manufacturer	Model No.	Serial No.	Power Cord
1	Notebook PC	Lenovo	ThinkPad T450	PC0BH4FR	Non-shielded, 0.8m
2	Notebook PC	Lenovo	ThinkPad T450	PC0BH4FA	Non-shielded, 0.8m
3	TV Box	Verizon	ASK-STI6220	N/A	N/A
4	Stream TV MoCA Ethernet Adapter	ASKEY	AE1	N/A	Non-shielded, 1.8m

## 2.5 Test Software

Normal Operation

## 2.6 EMI Suppression Device(s)/Modifications

No EMI suppression device(s) were added and/or no modifications were made during testing.



### 3. DESCRIPTION OF TEST

#### 3.1 Evaluation Procedure

The measurement procedures described in the American National Standard for Methods of Measurement of Radio-Noise Emission from Low-Voltage Electrical Equipment in the Range of 9kHz to 18GHz (ANSI C63.4-2014 & ANSI C63.4a-2017) was used in the measurement of the device.

**Deviation from measurement procedure.....None**

#### 3.2 AC Line Conducted Emissions

The line-conducted facility is located inside an 9'x4'x3' shielded enclosure. A 1m x 2m wooden table 80cm high is placed 40cm away from the vertical wall and 80cm away from the sidewall of the shielded room. Two 10kHz-30MHz, 50Ω/50uH Line-Impedance Stabilization Networks (LISNs) are bonded to the shielded room floor. Power to the LISNs is filtered by external high-current high-insertion loss power line filters. These filters attenuate ambient signal noise from entering the measurement lines. These filters are also bonded to the shielded enclosure.

The EUT is powered from one LISN and the support equipment is powered from the second LISN. If the EUT is a DC-powered device, power will be derived from the source power supply it normally will be powered from and this supply line(s) will be connected to the second LISN. All interconnecting cables more than 1 meter were shortened to a 1 meter length by non-inductive bundling (serpentine fashion) and draped over the back edge of the test table. All cables were at least 40cm above the horizontal reference ground-plane. Power cables for support equipment were routed down to the second LISN while ensuring that that cables were not draped over the second LISN.

Sufficient time for the EUT, support equipment, and test equipment was allowed in order for them to warm up to their normal operating condition. The RF output of the LISN was connected to the receiver and exploratory measurements were made to determine the frequencies producing the maximum emission from the EUT. The receiver was scanned from 150 kHz to 30 MHz. The detector function was set to peak mode for exploratory measurements while the bandwidth of the analyzer was set to 9 kHz. The EUT, support equipment, and interconnecting cables were arranged and manipulated to maximize each emission. Each emission was also maximized by varying: power lines, the mode of operation or resolution, clock or data exchange speed, scrolling H pattern to the EUT and/or support equipment whichever determined the worst-case emission. Once the worst case emissions have been identified, the one EUT cable configuration/arrangement and mode of operation that produced these emissions are used for final measurements on the same test site. Line conducted emissions test results are shown in Section 6.2.

### 3.3 Radiated Emissions

The radiated test facilities consisted of an indoor 3 meter semi-anechoic chamber used for final measurements and exploratory measurements, when necessary. The measurement area is contained within the semi-anechoic chamber which is shielded from any ambient interference. For measurements above 1GHz absorbers are arranged on the floor between the turn table and the antenna mast in such a way so as to maximize the reduction of reflections. For measurements below 1GHz, the absorbers are removed. An MF Model 210SS turntable is used for radiated measurement. It is a continuously rotatable, remote controlled, metallic turntable and 2 meters (6.56 ft.) in diameter. The turn table is flush with the raised floor of the chamber in order to maintain its function as a ground plane. An 80cm high PVC support structure is placed on top of the turntable.

For all measurements, the spectrum was scanned through all EUT azimuths and from 1 to 4 meter receive antenna height using a broadband antenna from 30 MHz up to the upper frequency shown in 15.33(b)(1) depending on the highest frequency generated or used in the device or on which the device operates or tunes. For frequencies above 1GHz, linearly polarized double ridge horn antennas were used. For frequencies below 30 MHz, a calibrated loop antenna was used. When exploratory measurements were necessary, they were performed at 1 meter test distance inside the semi-anechoic chamber using broadband antennas, broadband amplifiers, and spectrum analyzers to determine the frequencies and modes producing the maximum emissions. Sufficient time for the EUT, support equipment, and test equipment was allowed in order for them to warm up to their normal operating condition. The test set-up was placed on top of the 0.8 meter high, 1 x 1.5 meter table. The EUT, support equipment, and interconnecting cables were arranged and manipulated to maximize each emission. Appropriate precaution was taken to ensure that all emissions from the EUT were maximized and investigated. The system configuration, mode of operation, if applicable, turntable azimuth, and receive antenna height was noted for each frequency found.

Final measurements were made in the semi-anechoic chamber using calibrated, linearly polarized broadband and horn antennas. The test setup was configured to the setup that produced the worst case emissions. The spectrum analyzer was set to investigate all frequencies required for testing to compare the highest radiated disturbances with respect to the specified limits. The turntable containing the EUT was rotated through 360 degrees and the height of the boresight antenna was varied 1 to 4 meters and stopped at the azimuth and height producing the maximum emission. Each emission was maximized by changing the orientation of the EUT through three orthogonal planes and changing the polarity of the receive antenna, whichever produced the worst-case emissions. According to 3dB beam-width of horn antenna, the horn antenna should be always directed to the EUT when rising height.

Radiated emissions test results are shown in Section 6.3.

#### 4. TEST EQUIPMENT CALIBRATION DATE

##### Conducted Emissions - SR2

Instrument	Manufacturer	Type No.	Asset No.	Cali. Interval	Cali. Due Date
EMI Test Receiver	R&S	ESR3	MRTTWA00009	1 year	2021/3/25
Two-Line V-Network	R&S	ENV216	MRTTWA00019	1 year	2021/3/26
Two-Line V-Network	R&S	ENV216	MRTTWA00020	1 year	2021/4/24

##### Radiated Emissions – AC1

Instrument	Manufacturer	Type No.	Asset No.	Cali. Interval	Cali. Due Date
EMI Test Receiver	R&S	ESR3	MRTTWA00009	1 year	2021/3/25
Signal Analyzer	R&S	FSV40	MRTTWA00007	1 year	2021/3/24
Broadband Preamplifier	Schwarzbeck	BBV 9718	MRTTWA00005	1 year	2021/4/24
Broadband TRILOG Antenna	Schwarzbeck	VULB 9162	MRTTWA00001	1 year	2021/10/5
Broadband Horn antenna	Schwarzbeck	BBHA 9120D	MRTTWA00003	1 year	2021/4/24
Bore-Sight Antenna Tower	Max-Full	MF-7802	1308210	N/A	N/A

##### Test Software

Software	Version	Function
e3	9.160520a	EMI Test Software
EMI	V3	EMI Test Software

## 5. MEASUREMENT UNCERTAINTY

Where relevant, the following test uncertainty levels have been estimated for tests performed on the EUT as specified in CISPR 16-4-2. This uncertainty represents an expanded uncertainty expressed at approximately the 95% confidence level using a coverage factor of  $k = 2$ .

<b>AC Conducted Emission Measurement – SR2</b>
Measuring Uncertainty for a Level of Confidence of 95% ( $U=2Uc(y)$ ): 0.15MHz~30MHz: $\pm 2.53\text{dB}$
<b>Radiated disturbance Measurement – AC1</b>
Measuring Uncertainty for a Level of Confidence of 95% ( $U=2Uc(y)$ ): 9kHz~30MHz: $\pm 3.92\text{dB}$ 30MHz~1GHz: $\pm 4.25\text{dB}$ 1GHz~18GHz: $\pm 4.40\text{dB}$ 18GHz~40GHz: $\pm 4.45\text{dB}$

## 6. TEST RESULT

### 6.1 Summary

**Product Name:** Stream TV MoCA Ethernet Adapter

**Applicant:** ASKEY COMPUTER CORP

**Test Mode:** Mode 1

FCC Part Section(s)	Test Description	Test Result
15.107	Conducted Emissions	Pass
15.109	Radiated Emissions	Pass

Note 1: Determining compliance is based on the test results met the regulation limits or requirements declared by clients, and the test results don't take into account the value of measurement uncertainty.

## 6.2 Conducted Emission Measurement

### 6.2.1 Test Limit

FCC Part 15.107 Limits				
Frequency (MHz)	Class A (dB $\mu$ V)		Class B (dB $\mu$ V)	
	QP	AV	QP	AV
0.15 - 0.50	79	66	66 - 56	56 - 46
0.50 ~ 5.0	73	60	56	46
5.0 - 30	73	60	60	50

Note 1: The lower limit shall apply at the transition frequencies.

Note 2: The limit decreases linearly with the logarithm of the frequency in the range 0.15MHz to 0.5MHz.

### 6.2.2 Test Setup

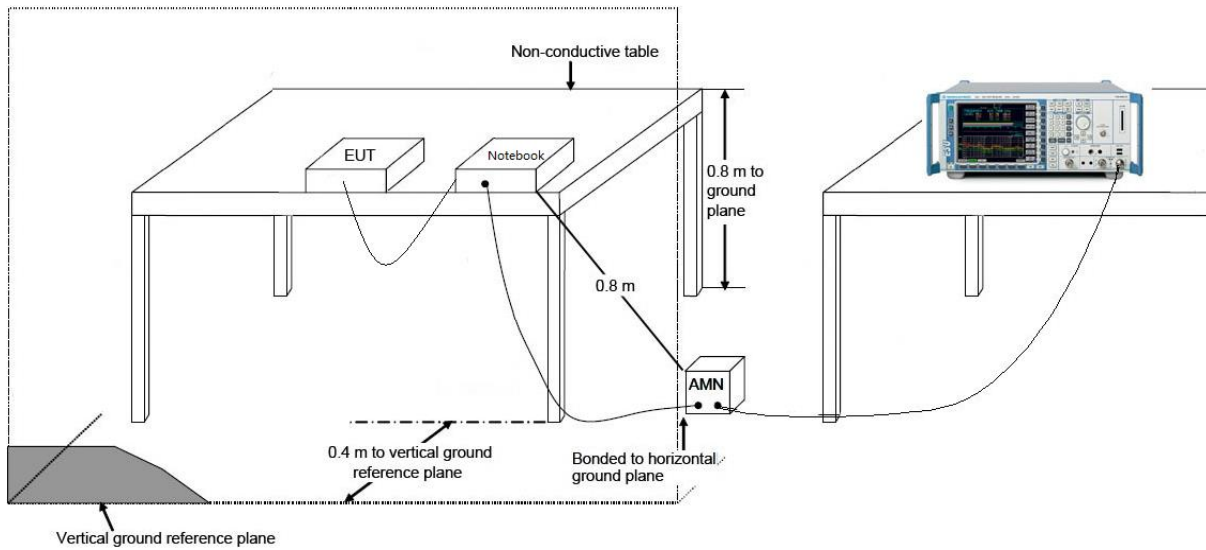

### 6.2.3 Test Result

EUT	Stream TV MoCA Ethernet Adapter	Date of Test	2021-02-24
Factor	CE_ENV216-L1 (Filter ON)	Temp. / Humidity	26.9°C /52%
Polarity	Line1	Site / Test Engineer	SR2 / Tim
Test Mode	Mode1	Test Voltage	AC 120V/60Hz

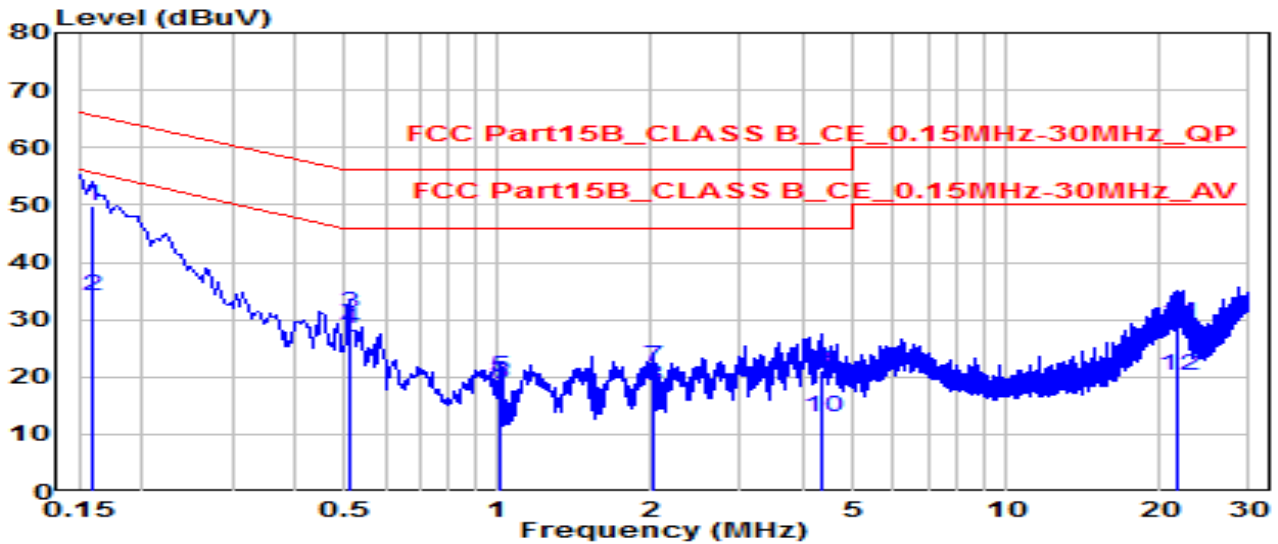

No	Frequency (MHz)	Reading (dBUV)	C.F (dB)	Measurement (dBUV/m)	Margin (dB)	Limit (dBUV/m)	Remark (QP/PK/AV)
1	* 0.159	40.22	9.61	49.83	-15.69	65.52	QP
2	0.159	24.61	9.61	34.22	-21.30	55.52	Average
3	0.510	21.36	9.63	30.99	-25.01	56.00	QP
4	* 0.510	18.87	9.63	28.51	-17.49	46.00	Average
5	1.014	10.34	9.66	20.00	-36.00	56.00	QP
6	1.014	8.91	9.66	18.57	-27.43	46.00	Average
7	2.031	11.99	9.69	21.68	-34.32	56.00	QP
8	2.031	8.81	9.69	18.50	-27.50	46.00	Average
9	4.317	11.51	9.73	21.23	-34.77	56.00	QP
10	4.317	3.12	9.73	12.85	-33.15	46.00	Average
11	21.833	19.15	10.01	29.16	-30.84	60.00	QP
12	21.833	10.23	10.01	20.24	-29.76	50.00	Average

Note:

1. " \*", means this data is the worst emission level.
2. C.F (Correction Factor) = Antenna Factor (dB)+ Cable Loss (dB).
3. Measurement (dBUV/m) = Reading(dBUV) + C.F (Correction Factor).

EUT	Stream TV MoCA Ethernet Adapter	Date of Test	2021-02-24
Factor	CE_ENV216-N (Filter ON)	Temp. / Humidity	26.9°C /52%
Polarity	Neutral	Site / Test Engineer	SR2 / Tim
Test Mode	Mode1	Test Voltage	AC 120V/60Hz

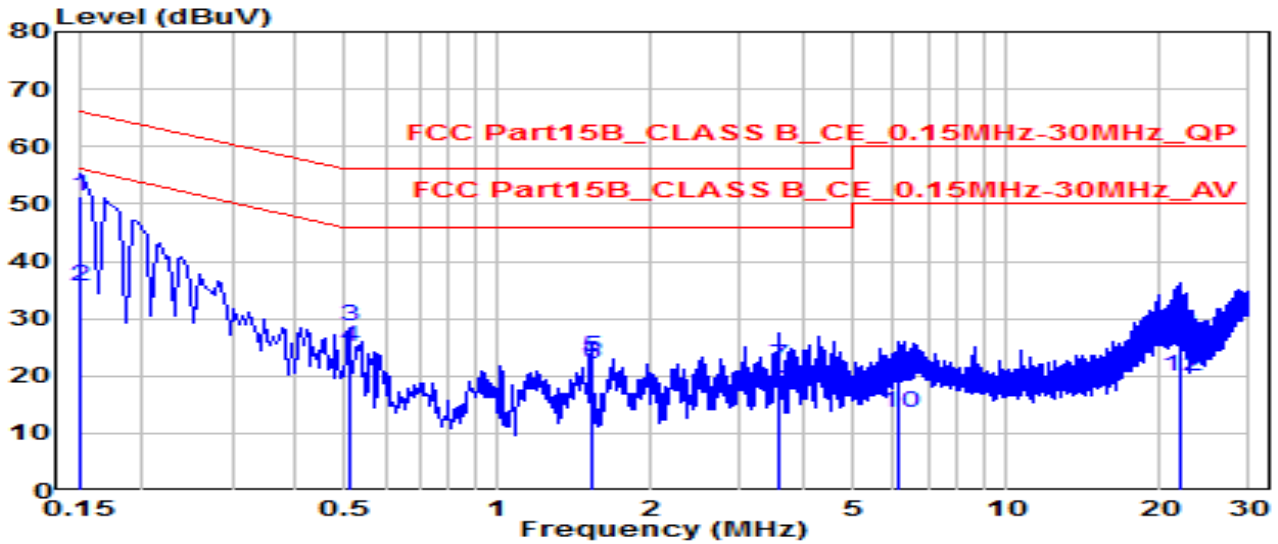

No	Frequency (MHz)	Reading (dBuV)	C.F (dB)	Measurement (dBuV/m)	Margin (dB)	Limit (dBuV/m)	Remark (QP/PK/AV)
1	* 0.150	41.81	9.62	51.43	-14.57	66.00	QP
2	* 0.150	26.00	9.62	35.62	-20.38	56.00	Average
3	0.510	18.91	9.64	28.55	-27.45	56.00	QP
4	0.510	15.43	9.64	25.07	-20.93	46.00	Average
5	1.522	13.71	9.68	23.39	-32.61	56.00	QP
6	1.522	12.36	9.68	22.04	-23.96	46.00	Average
7	3.552	11.88	9.72	21.60	-34.40	56.00	QP
8	3.552	7.56	9.72	17.28	-28.72	46.00	Average
9	6.175	9.75	9.78	19.53	-40.47	60.00	QP
10	6.175	3.88	9.78	13.67	-36.33	50.00	Average
11	21.964	16.76	10.10	26.86	-33.14	60.00	QP
12	21.964	9.98	10.10	20.07	-29.93	50.00	Average

Note:

1. " \*", means this data is the worst emission level.
2. C.F (Correction Factor) = Antenna Factor (dB)+ Cable Loss (dB).
3. Measurement (dBuV/m) = Reading(dBuV) + C.F (Correction Factor).



### 6.3 Radiated Emission Measurement

#### 6.3.1 Test Limit

FCC Part 15.109 Limits			
Frequency (MHz)	Distance (m)	Class A Level (dB $\mu$ V/m)	Class B Level (dB $\mu$ V/m)
30 - 88	3	49.5	40
88 - 216	3	54	43.5
216 - 960	3	56.9	46
Above 960	3	60	54
Note 1: The lower limit shall apply at the transition frequency. Note 2: Distance refers to the distance in meters between the measuring instrument antenna and the closed point of any part of the device or system. Note 3: E field strength (dB $\mu$ V/m) = 20 log E field strength (uV/m)			
Highest frequency generated or used in the device or on which the device operates or tunes (MHz)		Upper frequency of measurement range (MHz)	
Below 1.705		30.	
1.705-108		1000.	
108-500		2000.	
500-1000		5000.	
Above 1000		5th harmonic of the highest frequency or 40 GHz, whichever is lower.	

### 6.3.1 Test Setup

#### 30MHz ~ 1GHz Test Setup:

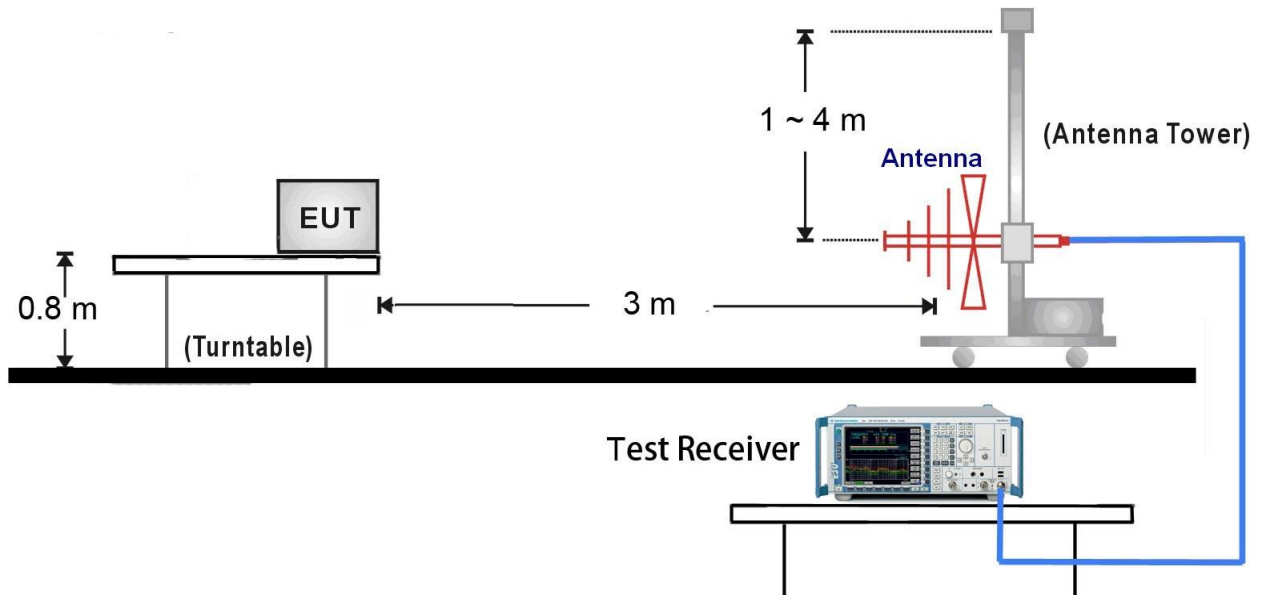

#### 1GHz ~18GHz Test Setup:

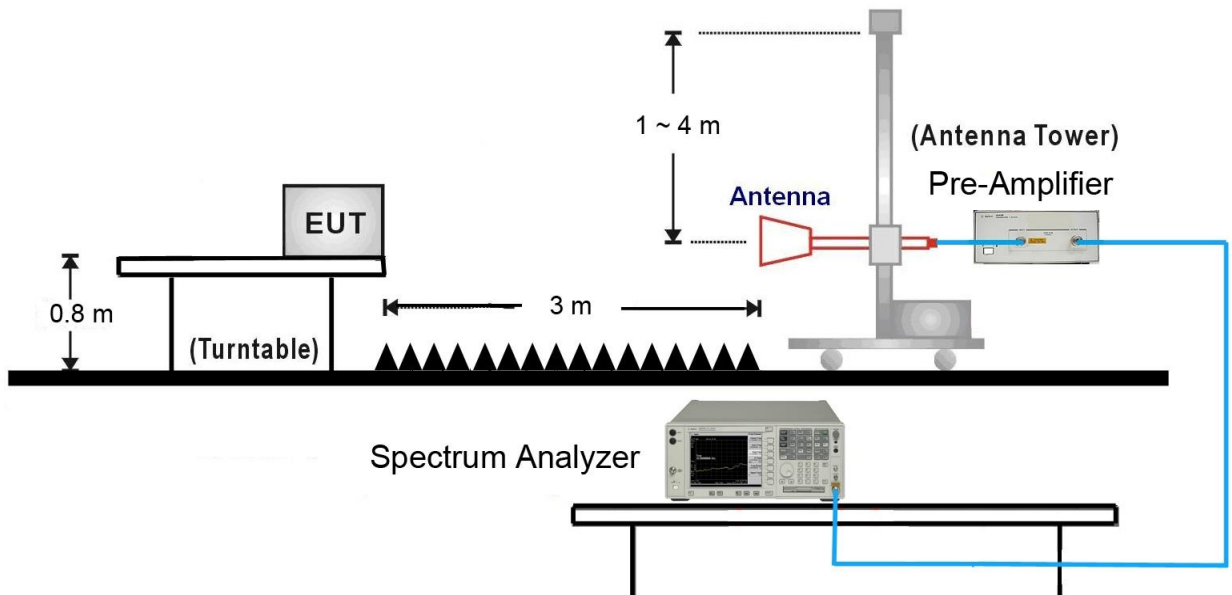

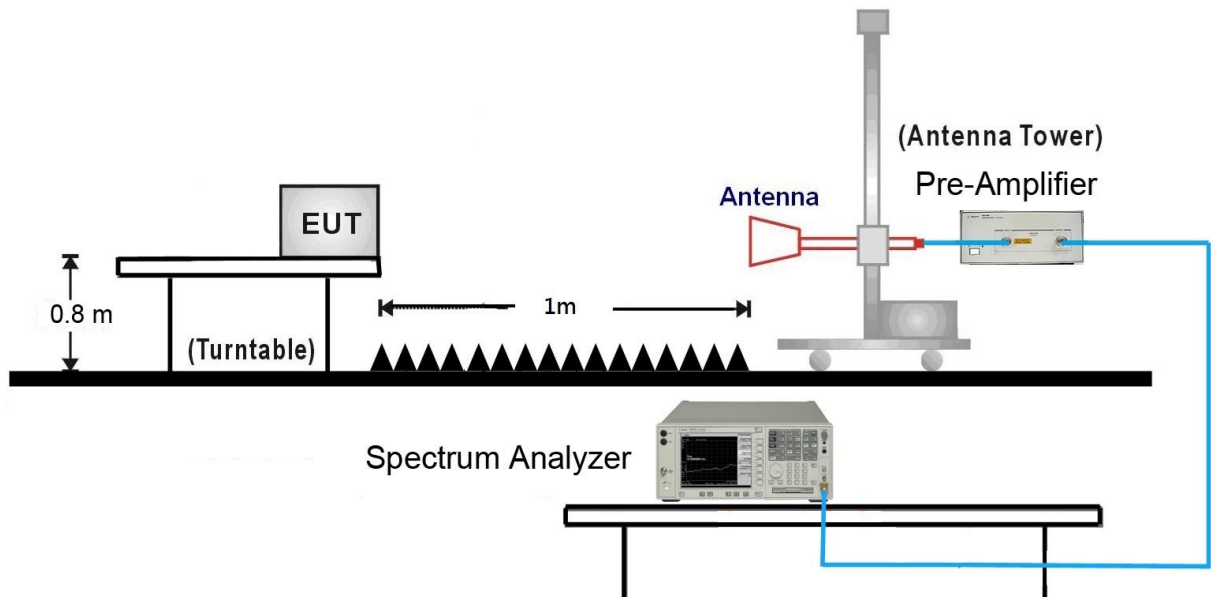
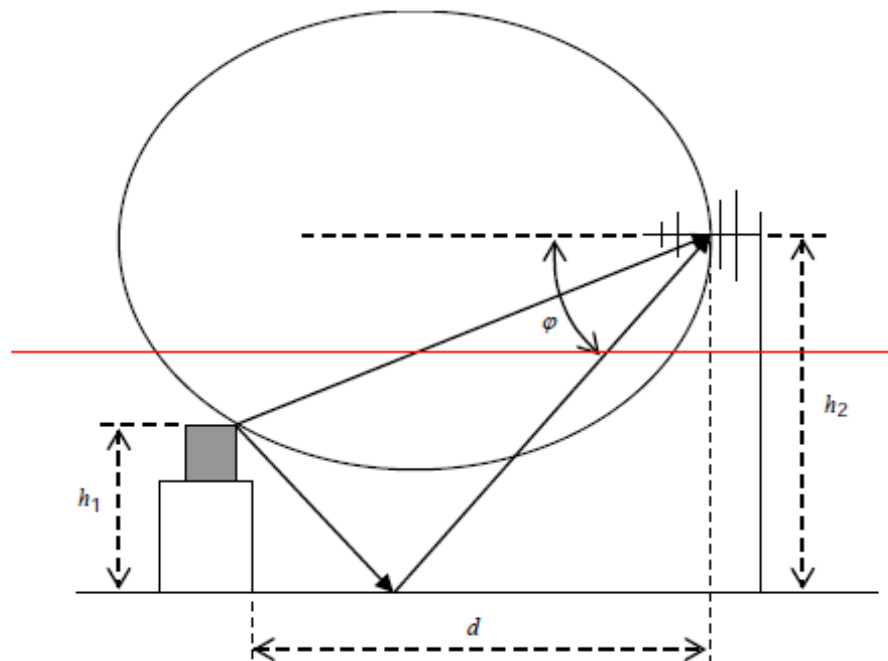
18GHz ~40GHz Test Setup:Boresight Test Setup:

### 6.3.2 Test Result

EUT	Stream TV MoCA Ethernet Adapter	Date of Test	2021-02-26
Factor	VULB 9162	Temp. / Humidity	23°C /58%
Polarity	Horizontal	Site / Test Engineer	AC1 / Howard
Test Mode	Mode1	Test Voltage	AC 120V/60Hz

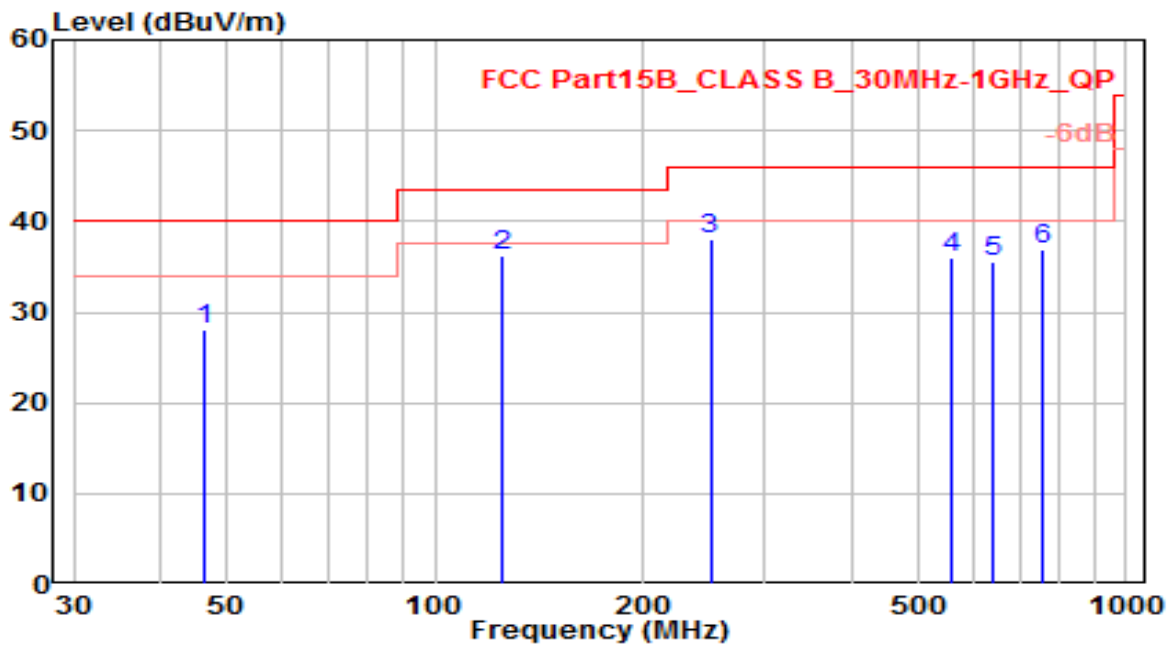

No	Frequency (MHz)	Reading (dBuV)	C.F (dB)	Measurement (dBuV/m)	Margin (dB)	Limit (dBuV/m)	Height (cm)	Angle (deg)	Remark (QP/PK/AV)
1	46.490	6.10	21.88	27.98	-12.02	40.00	100	10	QP
2	* 125.060	19.49	16.76	36.25	-7.25	43.50	100	100	QP
3	250.190	17.43	20.54	37.97	-8.03	46.00	100	120	QP
4	559.620	8.97	27.00	35.97	-10.03	46.00	100	200	QP
5	640.130	7.15	28.45	35.60	-10.40	46.00	100	320	QP
6	759.440	6.67	30.18	36.85	-9.15	46.00	100	200	QP

Note:

1. " \*", means this data is the worst emission level.
2. C.F (Correction Factor) = Antenna Factor (dB)+ Cable Loss (dB).
3. Measurement (dBuV/m) = Reading(dBuV) + C.F (Correction Factor).
4. The emission levels of other frequencies are very lower than the limit and not show in test report.

EUT	Stream TV MoCA Ethernet Adapter	Date of Test	2021-02-26
Factor	VULB 9162	Temp. / Humidity	23°C /58%
Polarity	Vertical	Site / Test Engineer	AC1 / Howard
Test Mode	Mode1	Test Voltage	AC 120V/60Hz

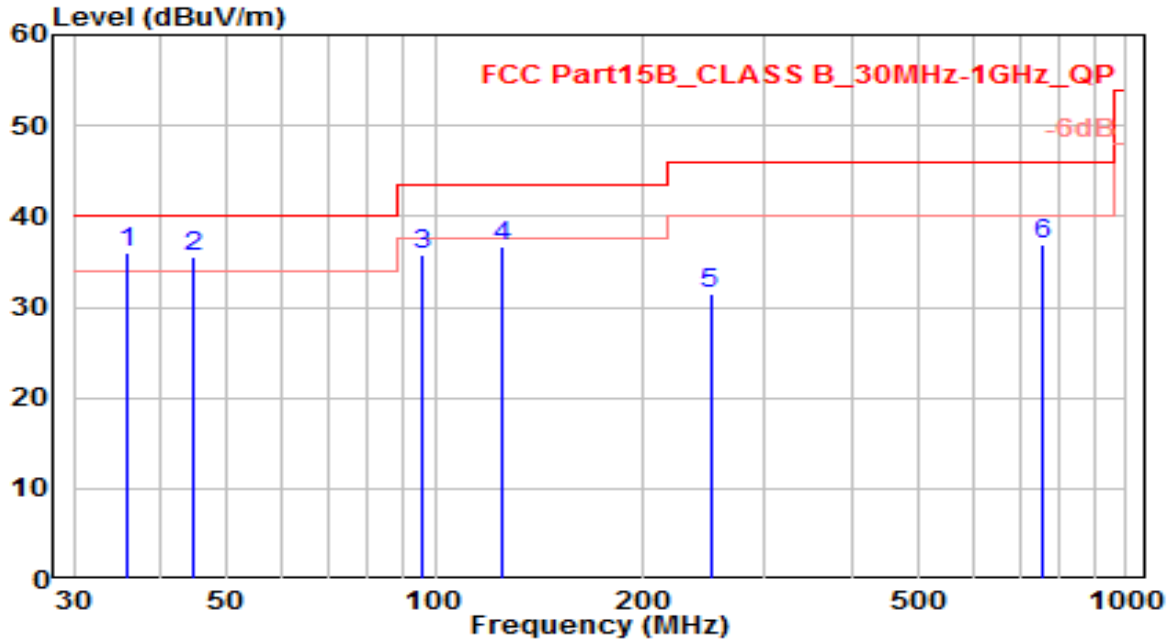

No	Frequency (MHz)	Reading (dBuV)	C.F (dB)	Measurement (dBuV/m)	Margin (dB)	Limit (dBuV/m)	Height (cm)	Angle (deg)	Remark (QP/PK/AV)
1	35.820	16.30	19.61	35.91	-4.09	40.00	100	360	QP
2	44.550	13.70	21.74	35.44	-4.56	40.00	100	0	QP
3	95.960	17.61	18.25	35.87	-7.63	43.50	100	320	QP
4	125.060	19.90	16.76	36.66	-6.84	43.50	100	280	QP
5	250.190	10.95	20.54	31.49	-14.51	46.00	100	350	QP
6	759.440	6.74	30.18	36.93	-9.07	46.00	100	220	QP

Note:

1. " \*", means this data is the worst emission level.
2. C.F (Correction Factor) = Antenna Factor (dB)+ Cable Loss (dB).
3. Measurement (dBuV/m) = Reading(dBuV) + C.F (Correction Factor).
4. The emission levels of other frequencies are very lower than the limit and not show in test report.

EUT	Stream TV MoCA Ethernet Adapter	Date of Test	2021-02-24
Factor	BBHA 9120D	Temp. / Humidity	23°C /58%
Polarity	Horizontal	Site / Test Engineer	AC1 / Kaunaz
Test Mode	Mode1	Test Voltage	AC 120V/60Hz

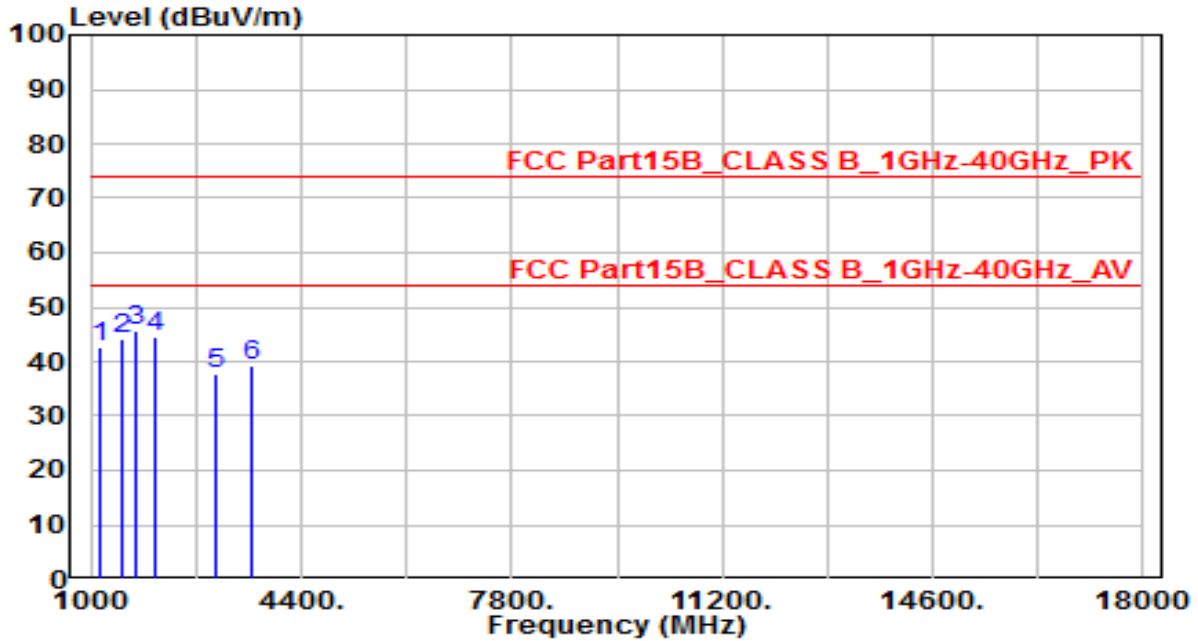

No	Frequency (MHz)	Reading (dBuV)	C.F (dB)	Measurement (dBuV/m)	Margin (dB)	Limit (dBuV/m)	Height (cm)	Angle (deg)	Remark (QP/PK/AV)
1	1172.125	49.72	-7.19	42.53	-31.47	74.00	100	360	Peak
2	1526.469	49.87	-5.66	44.21	-29.79	74.00	100	360	Peak
3	* 1718.781	50.81	-5.16	45.65	-28.35	74.00	100	360	Peak
4	2042.313	48.83	-4.23	44.60	-29.40	74.00	100	360	Peak
5	3028.844	40.17	-2.43	37.73	-36.27	74.00	100	360	Peak
6	3605.781	39.88	-0.48	39.40	-34.60	74.00	100	360	Peak

Note:

1. " \*", means this data is the worst emission level.
2. C.F (Correction Factor) = Antenna Factor (dB)+ Cable Loss (dB) – Preamplifier(dB).
3. Measurement (dBuV/m) = Reading(dBuV) + C.F (Correction Factor).
4. The emission levels of other frequencies are very lower than the limit and not show in test report.

EUT	Stream TV MoCA Ethernet Adapter	Date of Test	2021-02-24
Factor	BBHA 9120D	Temp. / Humidity	23°C /58%
Polarity	Vertical	Site / Test Engineer	AC1 / Kaunaz
Test Mode	Mode1	Test Voltage	AC 120V/60Hz

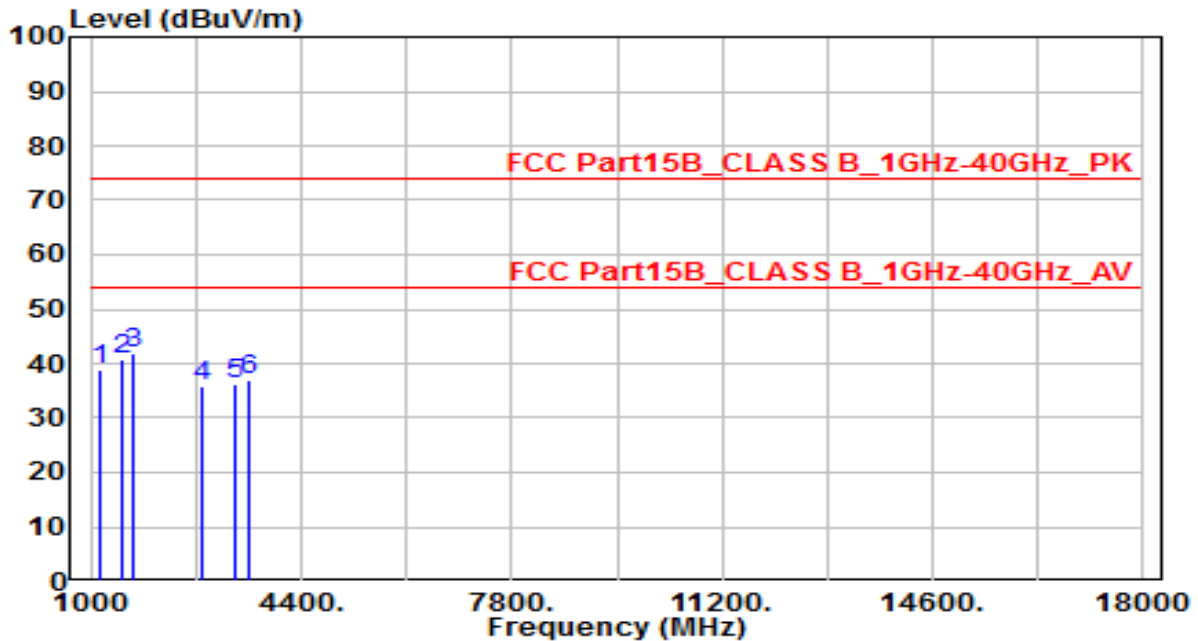

No	Frequency (MHz)	Reading (dBuV)	C.F (dB)	Measurement (dBuV/m)	Margin (dB)	Limit (dBuV/m)	Height (cm)	Angle (deg)	Remark (QP/PK/AV)
1	1131.219	46.29	-7.37	38.92	-35.08	74.00	100	360	Peak
2	1519.563	46.44	-5.68	40.76	-33.24	74.00	100	360	Peak
3	* 1683.719	46.99	-5.25	41.74	-32.26	74.00	100	360	Peak
4	2800.938	38.35	-2.41	35.94	-38.06	74.00	100	360	Peak
5	3329.531	37.66	-1.42	36.25	-37.75	74.00	100	360	Peak
6	3542.031	37.84	-0.70	37.14	-36.86	74.00	100	360	Peak

Note:

1. " \*", means this data is the worst emission level.
2. C.F (Correction Factor) = Antenna Factor (dB)+ Cable Loss (dB) – Preamplifier(dB).
3. Measurement (dBuV/m) = Reading(dBuV) + C.F (Correction Factor).
4. The emission levels of other frequencies are very lower than the limit and not show in test report.

## 7. CONCLUSION

The data collected relate only the item(s) tested and show that the **Stream TV MoCA Ethernet Adapter, Model No: ASK-MAE311** has been tested to comply with the requirements specified in §15.107 and §15.109 of the FCC Rules.



## Appendix A - Test Photograph

Test Mode 1

Description: Front View of Conducted Emission Test Setup



Test Mode 1

Description: Back View of Conducted Emission Test Setup

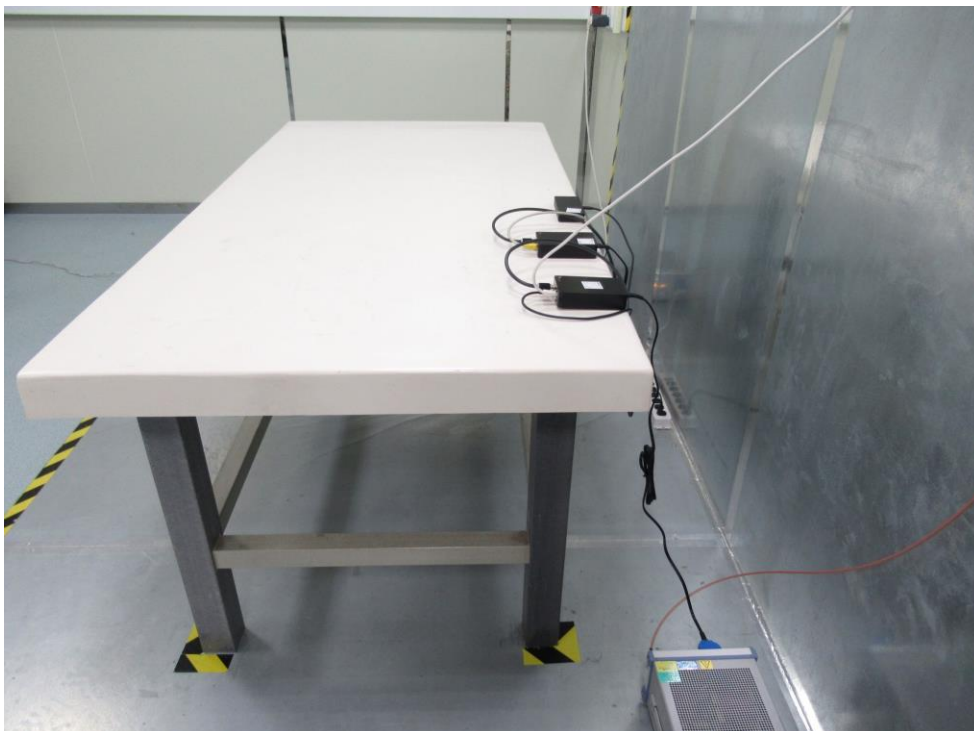

Test Mode 1

Description: Radiated Emission Test Setup for 30MHz ~ 1GHz



Test Mode 1

Description: Radiated Emission Test Setup for 1GHz ~ 18GHz



## Appendix B - External Photograph

(1) EUT Photo



(2) EUT Photo



(3) EUT Photo

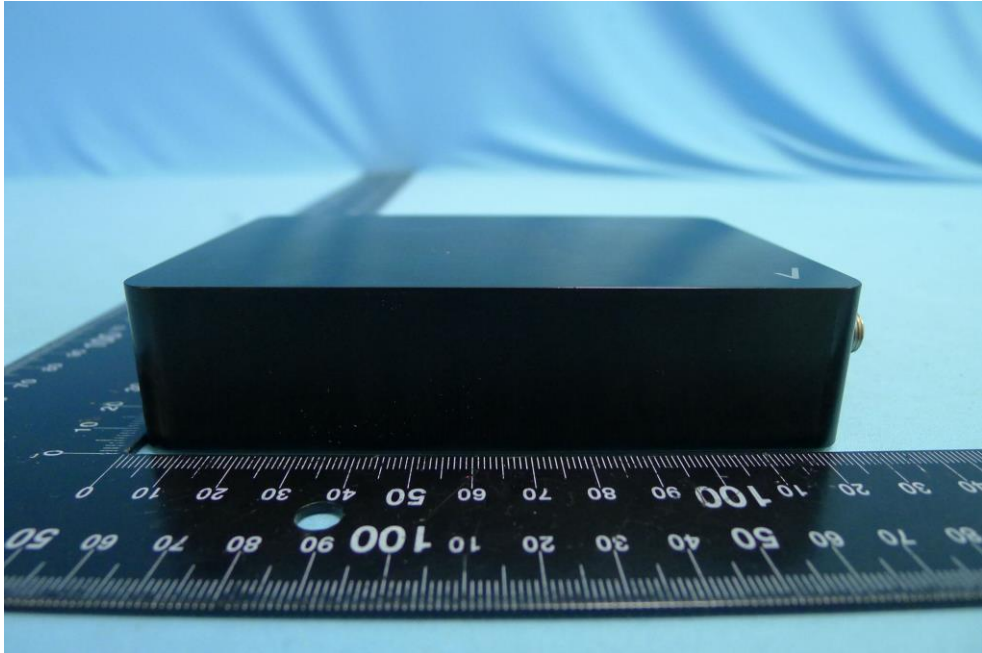

(4) EUT Photo



(5) EUT Photo

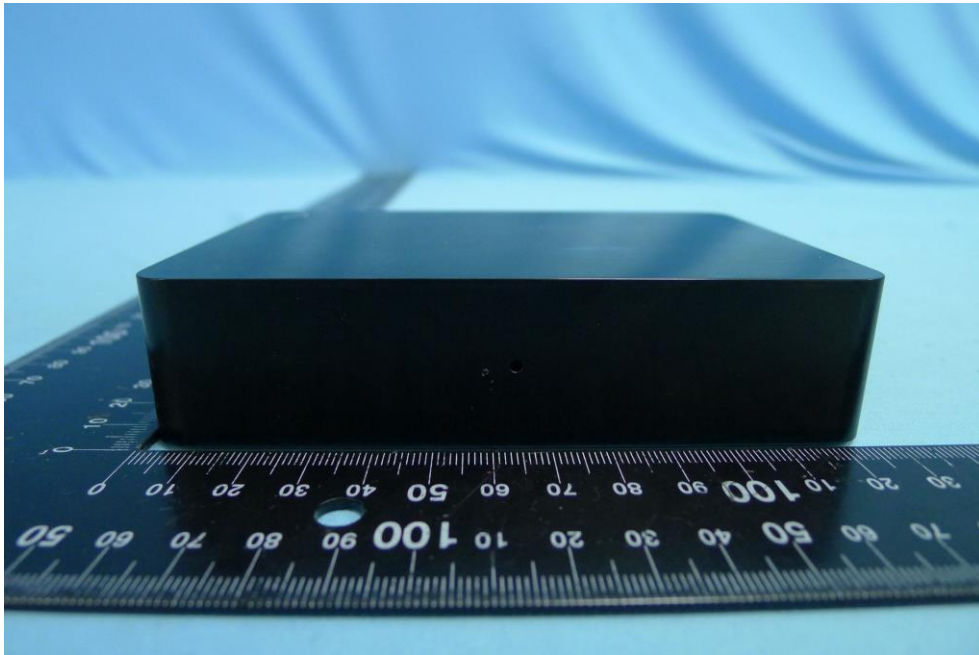

(6) EUT Photo



(7) EUT Photo



(8) EUT Photo



(9) EUT Photo



## Appendix C - Internal Photograph

(1) EUT Photo



(2) EUT Photo





(3) EUT Photo

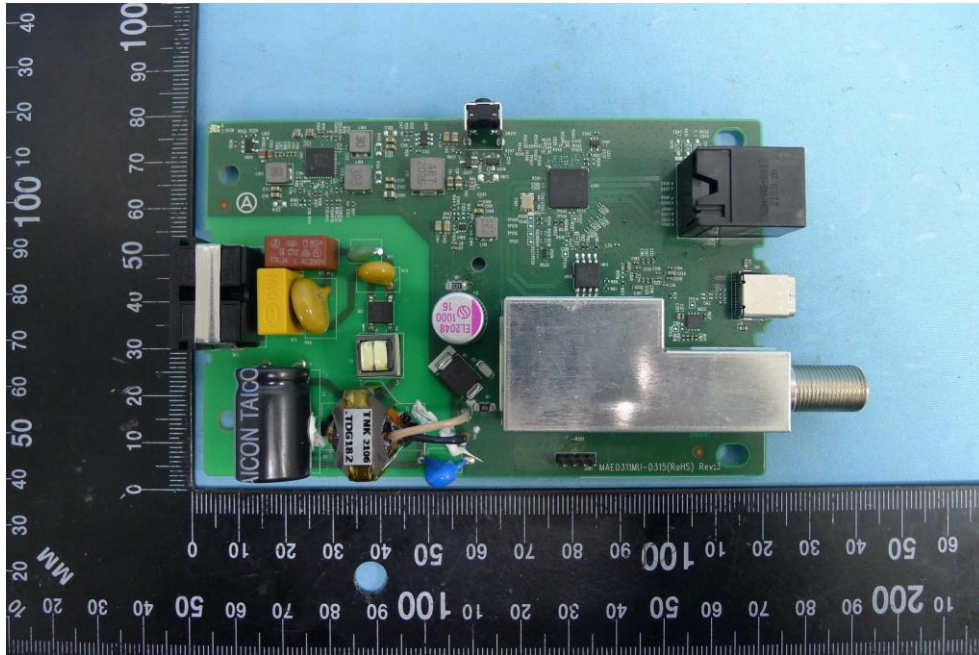

(4) EUT Photo

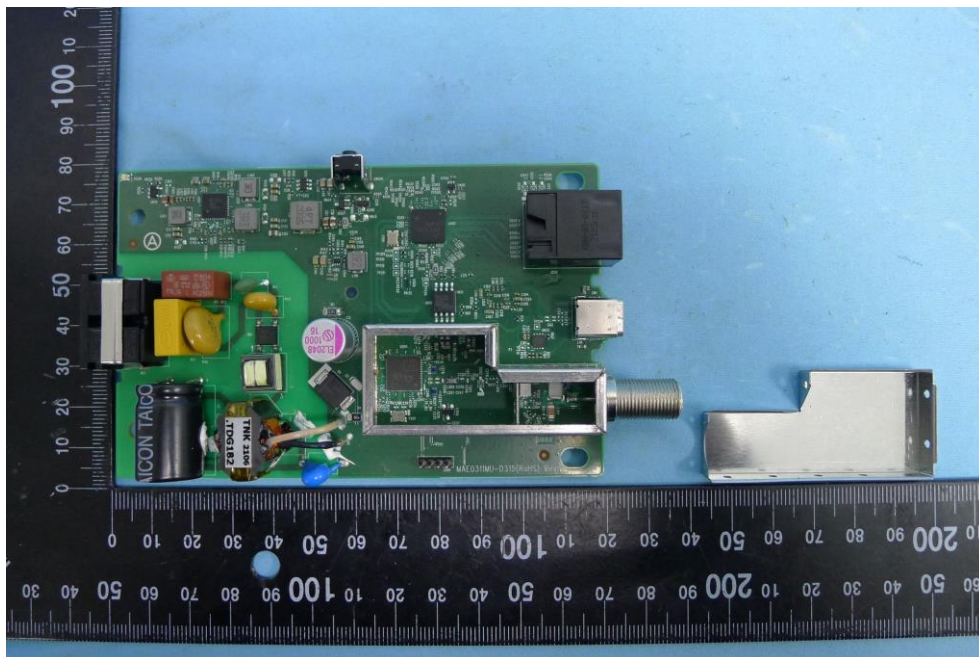

(5) EUT Photo

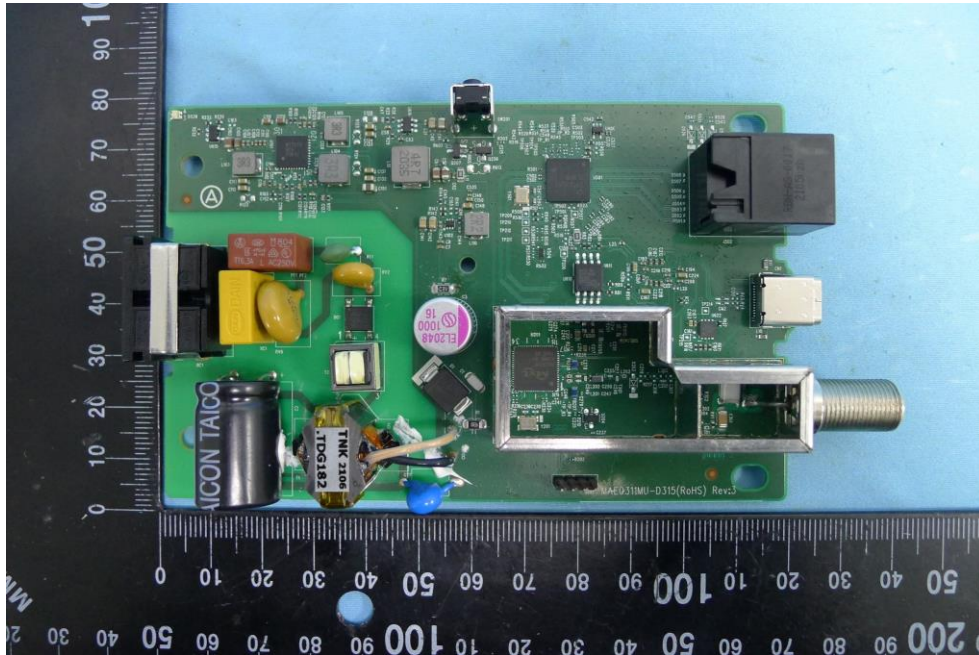

(6) EUT Photo

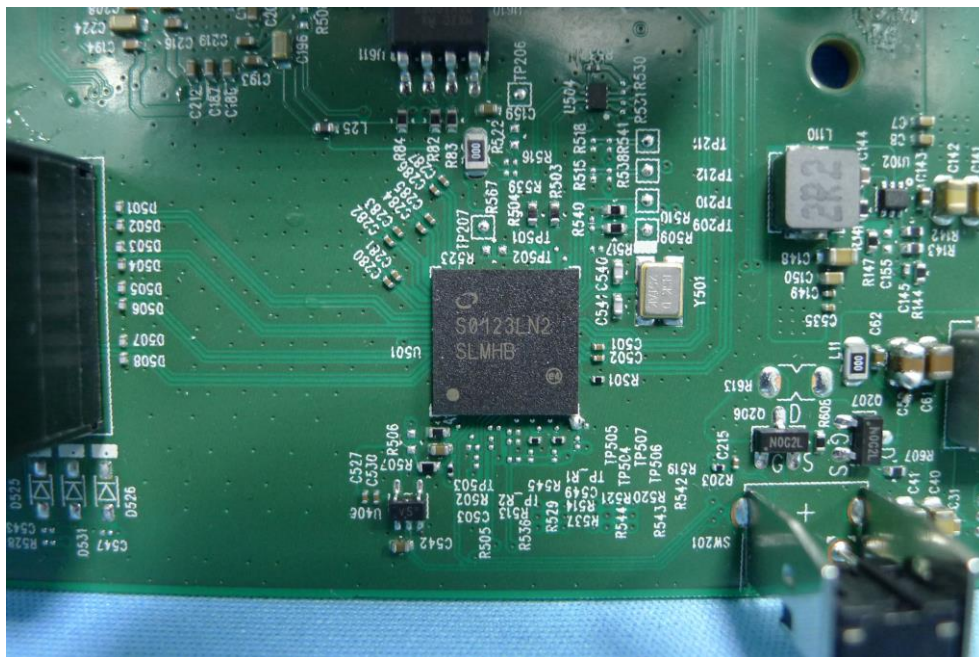

(7) EUT Photo

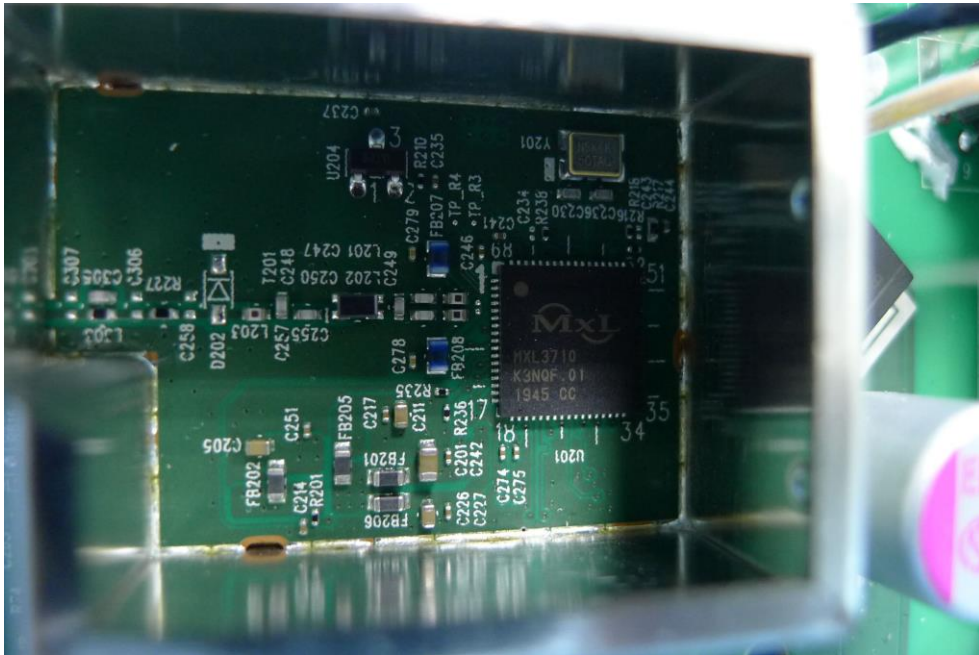

(8) EUT Photo

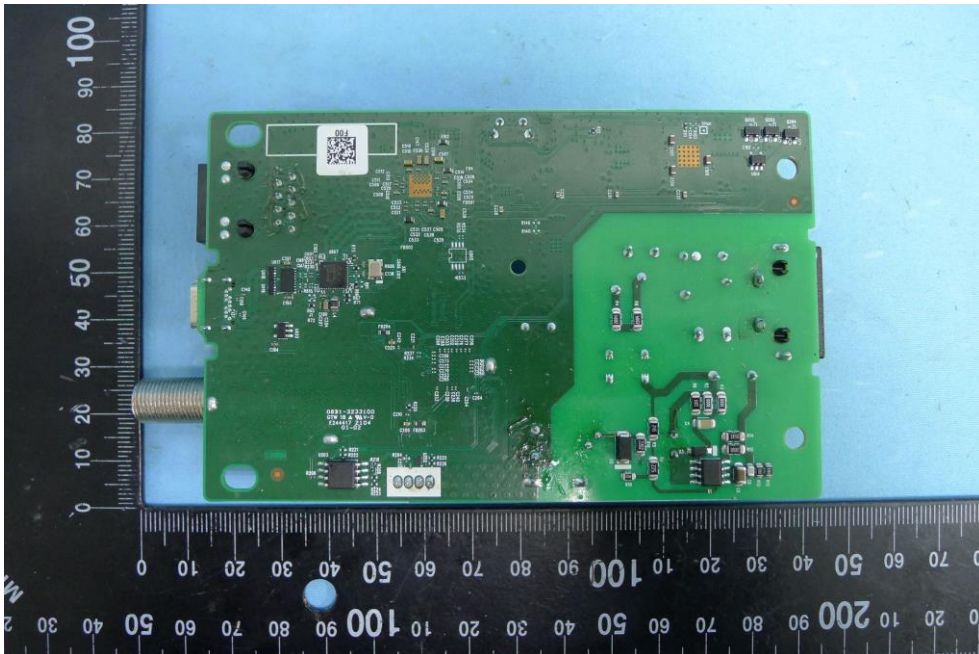

(9) EUT Photo

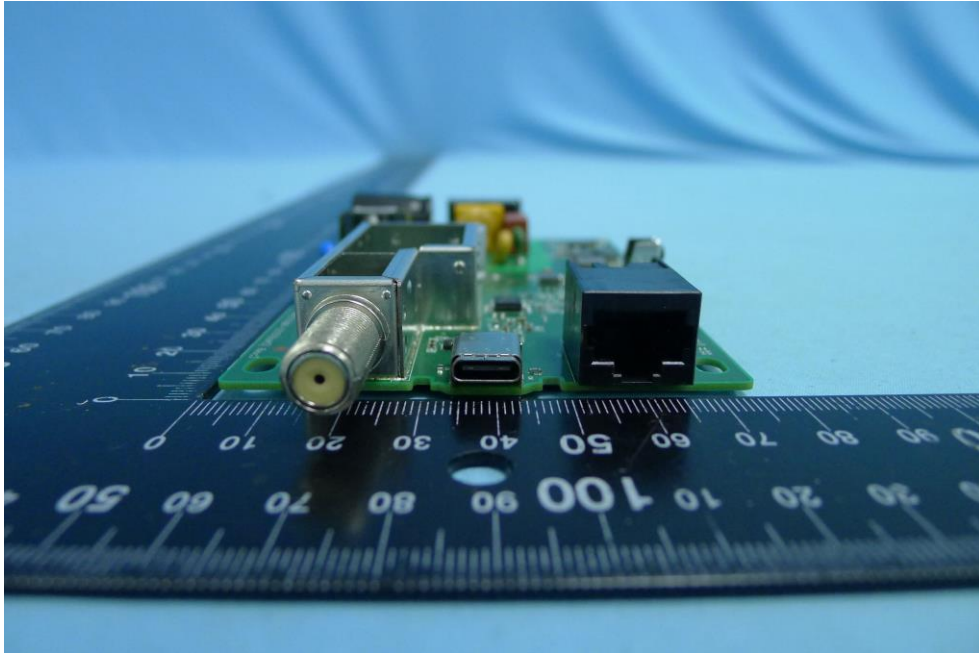

---

The End