

802.11ax-HE40 Power Spectral Density - Ant 1 / Ant 0 + 1

Channel 151 (5755MHz)

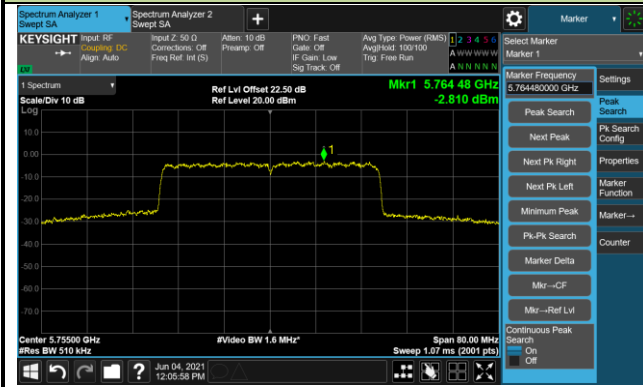

Channel 159 (5795MHz)

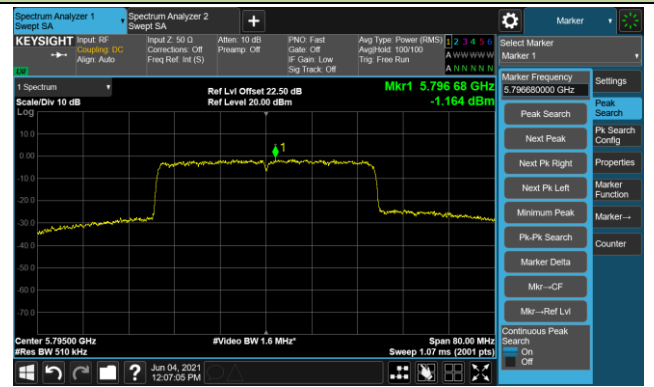

802.11ax-HE80 Power Spectral Density - Ant 1 / Ant 0 + 1

Channel 42 (5210MHz)

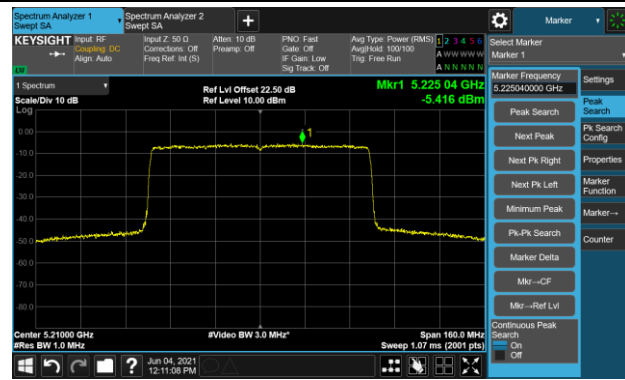

Channel 58 (5290MHz)

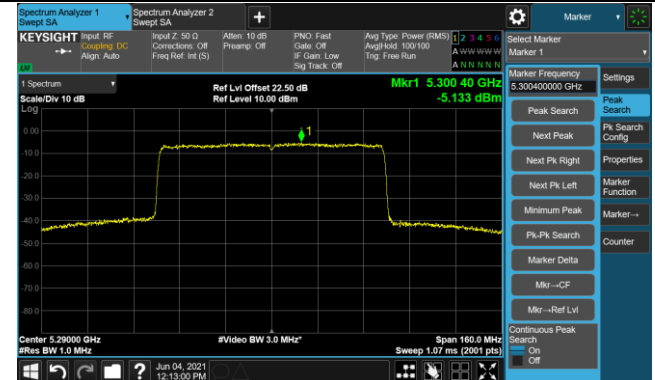

Channel 106 (5530MHz)

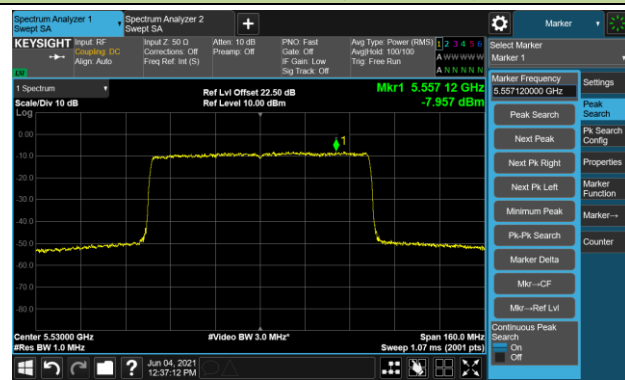

Channel 122 (5610MHz)



Channel 138 (5690MHz)

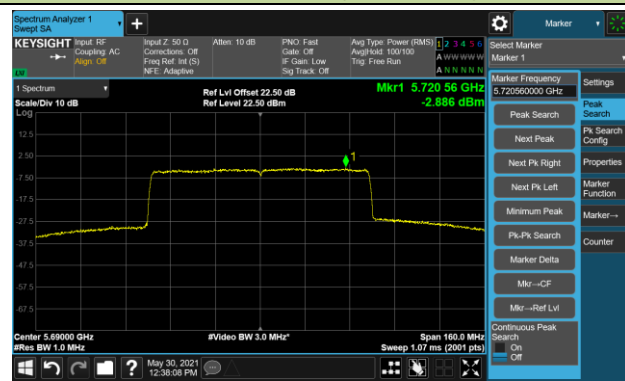

Channel 155 (5775MHz)



6.7. Frequency Stability Measurement

6.7.1. Test Limit

Fundamental emissions must be contained within the frequency bands specified in this section during all conditions of operation.

The transmitter center frequency tolerance shall be ± 20 ppm maximum for the 5GHz band (IEEE 802.11 specification).

6.7.2. Test Procedure Used

Frequency Stability Under Temperature Variations:

The equipment under test was connected to an external AC or DC power supply and input rated voltage. RF output was connected to a frequency counter or spectrum analyzer via feed through attenuators. The EUT was placed inside the temperature chamber. Set the spectrum analyzer RBW low enough to obtain the desired frequency resolution and measure EUT 20°C operating frequency as reference frequency. Turn EUT off and set the chamber temperature to highest. After the temperature stabilized for approximately 30 minutes recorded the frequency. Repeat step measure with 10°C decreased per stage until the lowest temperature reached.

Frequency Stability Under Voltage Variations:

Set chamber temperature to 20°C. Use a variable AC power supply / DC power source to power the EUT and set the voltage to rated voltage. Set the spectrum analyzer RBW low enough to obtain the desired frequency resolution and recorded the frequency.

Reduce the input voltage to specify extreme voltage variation ($\pm 15\%$) and endpoint, record the maximum frequency change.

6.7.3. Test Setup

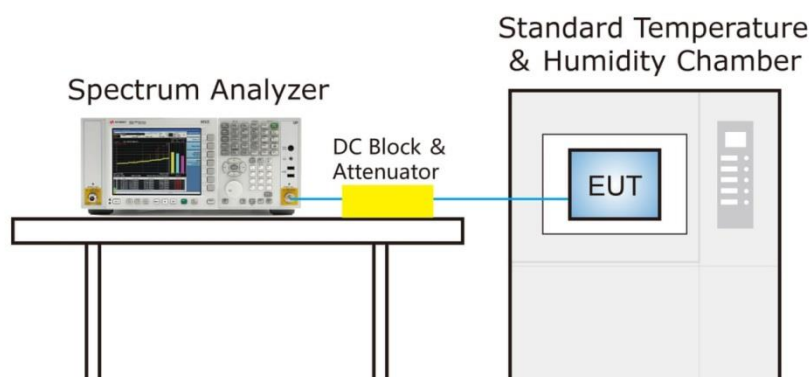

6.7.4. Test Result

Test Site	WZ-TR3	Test Engineer	Luis Yang
Test Date	2021/06/04		

Voltage (%)	Power (VAC)	Temp (°C)	Frequency Tolerance (ppm)			
			0 min	2 min	5 min	10 min
100%	120	- 30	3.85	3.77	3.80	3.80
		- 20	3.82	3.80	3.81	3.83
		- 10	3.83	3.80	3.80	3.86
		0	3.83	3.78	3.79	3.82
		+ 10	3.80	3.76	3.80	3.83
		+ 20 (Ref)	3.80	3.76	3.80	3.83
		+ 30	3.79	3.79	3.82	3.84
		+ 40	3.80	3.77	3.81	3.84
		+ 50	3.80	3.78	3.82	3.87
115%	138	+ 20	3.79	3.76	3.80	3.85
85%	102	+ 20	3.78	3.81	3.83	3.87

Note: Frequency Tolerance (ppm) = $\{[\text{Measured Frequency (Hz)} - \text{Declared Frequency (Hz)}] / \text{Declared Frequency (Hz)}\} * 10^6$.

6.8. Unwanted Emission Measurement

6.8.1. Test Limit

All out of band emissions appearing in a restricted band as specified in Section 15.205 of the Title 47CFR must not exceed the limits shown in Table per Section 15.209.

FCC Part 15 Subpart C Paragraph 15.209 & RSS-Gen Section 8.9		
Frequency [MHz]	Field Strength [uV/m]	Measured Distance [Meters]
0.009 - 0.490	2400/F (kHz)	300
0.490 - 1.705	24000/F (kHz)	30
1.705 - 30	30	30
30 - 88	100	3
88 - 216	150	3
216 - 960	200	3
Above 960	500	3

Unwanted Emission in 5250MHz~5350MHz Band (RSS-247 Issue 2 section 6.2.1.2)

Any unwanted emissions that fall into the band 5250-5350 MHz shall be attenuated below the channel power by at least 26 dB, when measured using a resolution bandwidth between 1 and 5% of the occupied bandwidth (i.e. 99% bandwidth), above 5250MHz.

6.8.2. Test Procedure Used

KDB 789033 D02v02r01 – Section G

6.8.3. Test Setting

Table 1 - RBW as a function of frequency

Frequency	RBW
9 ~ 150 kHz	200 ~ 300 Hz
0.15 ~ 30 MHz	9 ~ 10 kHz
30 ~ 1000 MHz	100 ~ 120 kHz
> 1000 MHz	1 MHz

Quasi-Peak Measurements below 1GHz

1. Analyzer center frequency was set to the frequency of the radiated spurious emission of interest
2. Span was set greater than 1MHz
3. RBW = as specified in Table 1
4. Detector = CISPR quasi-peak
5. Sweep time = auto couple
6. Trace was allowed to stabilize

Peak Measurements above 1GHz

1. Analyzer center frequency was set to the frequency of the radiated spurious emission of interest
2. RBW = 1MHz
3. VBW = 3MHz
4. Detector = peak
5. Sweep time = auto couple
6. Trace mode = max hold
7. Trace was allowed to stabilize

Average Measurements above 1GHz (Method VB)

1. Analyzer center frequency was set to the frequency of the radiated spurious emission of interest
2. RBW = 1MHz
3. VBW; If the EUT is configured to transmit with duty cycle $\geq 98\%$, set VBW = 10 Hz.
If the EUT duty cycle is $< 98\%$, set VBW $\geq 1/T$. T is the minimum transmission duration.
4. Detector = Peak
5. Sweep time = auto
6. Trace mode = max hold
7. Trace was allowed to stabilize

Unwanted Emission in 5250MHz~5350MHz Band

1. Set test frequency range from 5250MHz to 5350MHz
2. Set RBW = 1~5% OBW (99%)
3. Set VBW ≥ 3 times RBW
4. Set Detector = RMS
5. Trace mode = Max hold
6. Sweep time = auto couple
7. The trace was allowed to stabilize
8. Repeat the step 1 to 7 at other antenna chain.

6.8.4. Test Setup

Below 1GHz Test Setup:

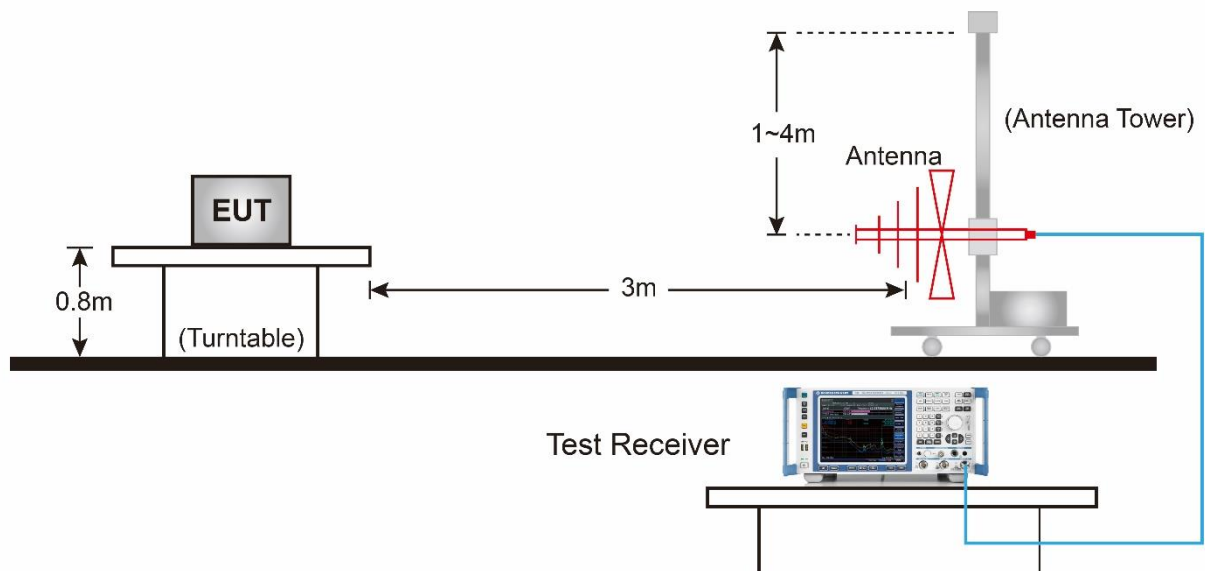

Above 1G Test Setup:

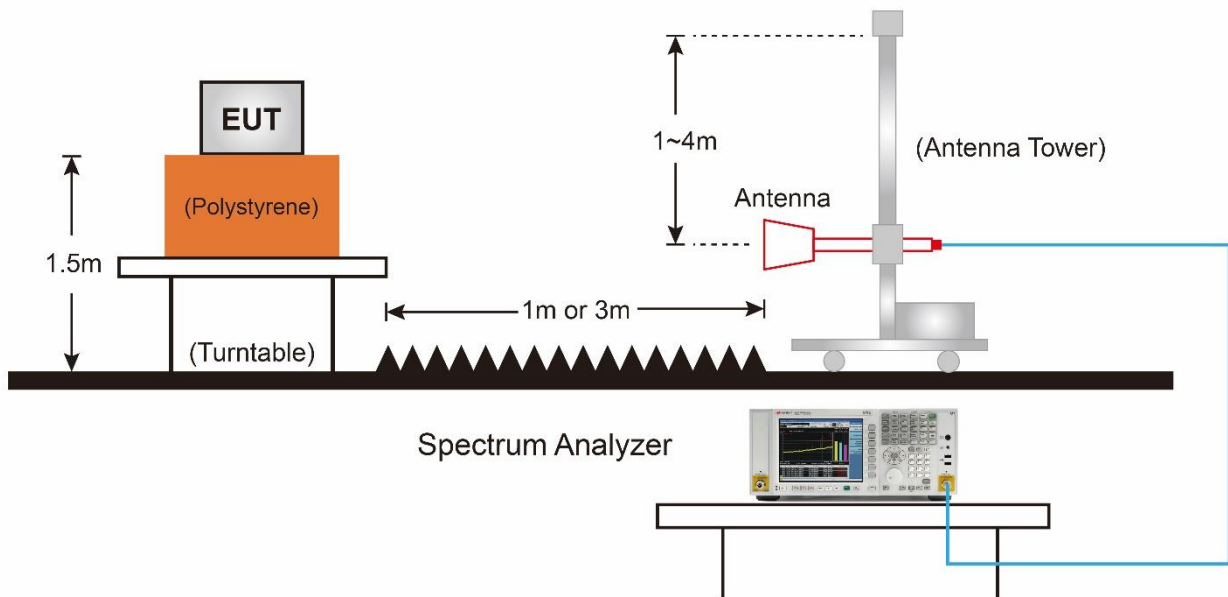

Unwanted Emission in 5250MHz~5350MHz Band Test Setup:

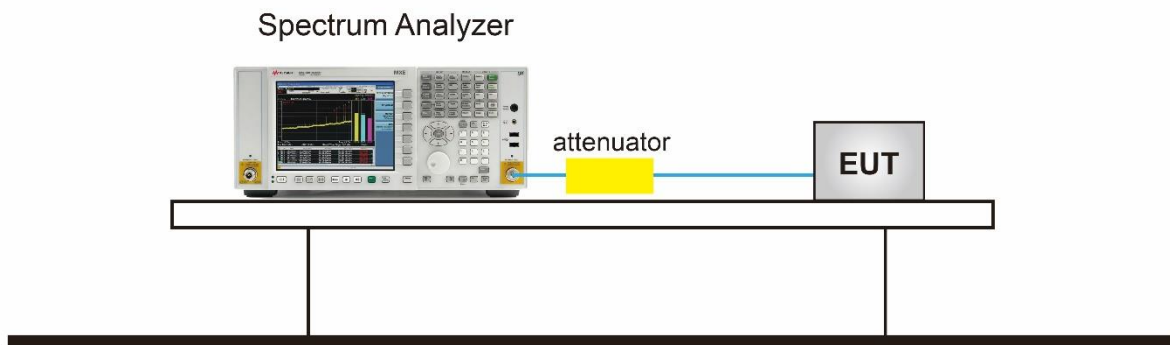

6.8.5. Test Result

Test Site	SIP-AC1	Test Engineer	Edward Zhang
Test Date	2021/06/04	Test Mode	802.11a - Ant 0 + 1 (CDD Mode)
Test Channel	36		
Remark:	1. Average measurement was not performed if peak level lower than average limit. 2. Other frequency was 20dB below limit line within 1-18GHz, there is not show in the report.		

Mark	Frequency (MHz)	Reading Level (dB μ V)	Factor (dB)	Measure Level (dB μ V/m)	Limit (dB μ V/m)	Margin (dB)	Detector	Polarization
*	9916.5	50.8	-5.2	45.6	68.2	-22.6	Peak	Horizontal
	11735.5	50.0	-4.5	45.5	74.0	-28.5	Peak	Horizontal
	15543.5	53.7	1.8	55.5	74.0	-18.5	Peak	Horizontal
	15543.5	36.3	1.8	38.1	54.0	-15.9	Average	Horizontal
*	17226.5	46.9	4.4	51.3	68.2	-16.9	Peak	Horizontal
*	10095.0	50.5	-5.3	45.2	68.2	-23.0	Peak	Vertical
	11421.0	50.8	-4.9	45.9	74.0	-28.1	Peak	Vertical
	15645.5	46.8	1.5	48.3	74.0	-25.7	Peak	Vertical
*	16937.5	46.9	4.0	50.9	68.2	-17.3	Peak	Vertical

Note 1: "*" is not in restricted band, its limit is -27dBm/MHz. At a distance of 3 meters, the field strength limit in dB μ V/m can be determined by adding a "conversion" factor of 95.2dB to the EIRP limit of -27dBm/MHz to obtain the limit for out of band spurious emissions.

Note 2: Measure Level (dB μ V/m) = Reading Level (dB μ V) + Factor (dB)

Factor (dB) = Cable Loss (dB) + Antenna Factor (dB/m) - Pre_Amplifier Gain (dB)

Test Site	SIP-AC1	Test Engineer	Edward Zhang
Test Date	2021/06/04	Test Mode	802.11a - Ant 0 + 1 (CDD Mode)
Test Channel	44		
Remark:	1. Average measurement was not performed if peak level lower than average limit. 2. Other frequency was 20dB below limit line within 1-18GHz, there is not show in the report.		

Mark	Frequency (MHz)	Reading Level (dBμV)	Factor (dB)	Measure Level (dBμV/m)	Limit (dBμV/m)	Margin (dB)	Detector	Polarization
*	10282.0	50.4	-5.3	45.1	68.2	-23.1	Peak	Horizontal
	12262.5	50.6	-3.7	46.9	74.0	-27.1	Peak	Horizontal
	15654.0	53.3	1.5	54.8	74.0	-19.2	Peak	Horizontal
	15654.0	45.3	1.5	46.8	54.0	-7.2	Average	Horizontal
*	17277.5	46.8	4.6	51.4	68.2	-16.8	Peak	Horizontal
*	9993.0	50.4	-5.1	45.3	68.2	-22.9	Peak	Vertical
	12441.0	49.2	-3.8	45.4	74.0	-28.6	Peak	Vertical
	15662.5	50.4	1.8	52.2	74.0	-21.8	Peak	Vertical
	15662.5	42.2	1.8	44.0	54.0	-10.0	Average	Vertical
*	16818.5	47.4	4.1	51.5	68.2	-16.7	Peak	Vertical

Note 1: "*" is not in restricted band, its limit is -27dBm/MHz. At a distance of 3 meters, the field strength limit in dBμV/m can be determined by adding a "conversion" factor of 95.2dB to the EIRP limit of -27dBm/MHz to obtain the limit for out of band spurious emissions.

Note 2: Measure Level (dBμV/m) = Reading Level (dBμV) + Factor (dB)

Factor (dB) = Cable Loss (dB) + Antenna Factor (dB/m) - Pre_Amplifier Gain (dB)

Test Site	SIP-AC1	Test Engineer	Edward Zhang
Test Date	2021/06/04	Test Mode:	802.11a - Ant 0 + 1 (CDD Mode)
Test Channel:	48		
Remark:	1. Average measurement was not performed if peak level lower than average limit. 2. Other frequency was 20dB below limit line within 1-18GHz, there is not show in the report.		

Mark	Frequency (MHz)	Reading Level (dBμV)	Factor (dB)	Measure Level (dBμV/m)	Limit (dBμV/m)	Margin (dB)	Detector	Polarization
*	10001.5	50.6	-5.1	45.5	68.2	-22.7	Peak	Horizontal
	12398.5	49.9	-3.6	46.3	74.0	-27.7	Peak	Horizontal
	15722.0	50.3	1.7	52.0	74.0	-22.0	Peak	Horizontal
*	16784.5	46.8	4.1	50.9	68.2	-17.3	Peak	Horizontal
*	10001.5	50.5	-5.1	45.4	68.2	-22.8	Peak	Vertical
	12330.5	48.0	-3.8	44.2	74.0	-29.8	Peak	Vertical
	15866.5	47.4	2.5	49.9	74.0	-24.1	Peak	Vertical
*	16767.5	46.8	4.1	50.9	68.2	-17.3	Peak	Vertical

Note 1: "*" is not in restricted band, its limit is -27dBm/MHz. At a distance of 3 meters, the field strength limit in dBμV/m can be determined by adding a "conversion" factor of 95.2dB to the EIRP limit of -27dBm/MHz to obtain the limit for out of band spurious emissions.

Note 2: Measure Level (dBμV/m) = Reading Level (dBμV) + Factor (dB)

Factor (dB) = Cable Loss (dB) + Antenna Factor (dB/m) - Pre_Amplifier Gain (dB)

Test Site	SIP-AC1	Test Engineer	Edward Zhang
Test Date	2021/06/04	Test Mode	802.11a - Ant 0 + 1 (CDD Mode)
Test Channel	52		
Remark:	1. Average measurement was not performed if peak level lower than average limit. 2. Other frequency was 20dB below limit line within 1-18GHz, there is not show in the report.		

Mark	Frequency (MHz)	Reading Level (dBμV)	Factor (dB)	Measure Level (dBμV/m)	Limit (dBμV/m)	Margin (dB)	Detector	Polarization
*	9874.0	51.0	-5.3	45.7	68.2	-22.5	Peak	Horizontal
	12390.0	49.1	-3.5	45.6	74.0	-28.4	Peak	Horizontal
	15781.5	51.3	2.5	53.8	74.0	-20.2	Peak	Horizontal
*	16784.5	46.9	4.1	51.0	68.2	-17.2	Peak	Horizontal
*	10197.0	51.3	-5.4	45.9	68.2	-22.3	Peak	Vertical
	11880.0	50.0	-4.0	46.0	74.0	-28.0	Peak	Vertical
	15773.0	46.7	2.8	49.5	74.0	-24.5	Peak	Vertical
*	17286.0	47.0	4.9	51.9	68.2	-16.3	Peak	Vertical

Note 1: "*" is not in restricted band, its limit is -27dBm/MHz. At a distance of 3 meters, the field strength limit in dBμV/m can be determined by adding a "conversion" factor of 95.2dB to the EIRP limit of -27dBm/MHz to obtain the limit for out of band spurious emissions.

Note 2: Measure Level (dBμV/m) = Reading Level (dBμV) + Factor (dB)

Factor (dB) = Cable Loss (dB) + Antenna Factor (dB/m) - Pre_Amplifier Gain (dB)

Test Site	SIP-AC1	Test Engineer	Edward Zhang
Test Date	2021/06/04	Test Mode	802.11a - Ant 0 + 1 (CDD Mode)
Test Channel	60		
Remark:	1. Average measurement was not performed if peak level lower than average limit. 2. Other frequency was 20dB below limit line within 1-18GHz, there is not show in the report.		

Mark	Frequency (MHz)	Reading Level (dBμV)	Factor (dB)	Measure Level (dBμV/m)	Limit (dBμV/m)	Margin (dB)	Detector	Polarization
*	9874.0	50.5	-5.3	45.2	68.2	-23.0	Peak	Horizontal
	12237.0	49.9	-3.8	46.1	74.0	-27.9	Peak	Horizontal
	15900.5	49.3	2.1	51.4	74.0	-22.6	Peak	Horizontal
*	16844.0	46.7	4.2	50.9	68.2	-17.3	Peak	Horizontal
*	10044.0	50.6	-5.1	45.5	68.2	-22.7	Peak	Vertical
	11693.0	50.1	-4.6	45.5	74.0	-28.5	Peak	Vertical
	15696.5	47.4	1.8	49.2	74.0	-24.8	Peak	Vertical
*	16750.5	46.9	4.2	51.1	68.2	-17.1	Peak	Vertical

Note 1: "*" is not in restricted band, its limit is -27dBm/MHz. At a distance of 3 meters, the field strength limit in dBμV/m can be determined by adding a "conversion" factor of 95.2dB to the EIRP limit of -27dBm/MHz to obtain the limit for out of band spurious emissions.

Note 2: Measure Level (dBμV/m) = Reading Level (dBμV) + Factor (dB)

Factor (dB) = Cable Loss (dB) + Antenna Factor (dB/m) - Pre_Amplifier Gain (dB)

Test Site	SIP-AC1	Test Engineer	Edward Zhang
Test Date	2021/06/04	Test Mode:	802.11a - Ant 0 + 1 (CDD Mode)
Test Channel	64		
Remark:	1. Average measurement was not performed if peak level lower than average limit. 2. Other frequency was 20dB below limit line within 1-18GHz, there is not show in the report.		

Mark	Frequency (MHz)	Reading Level (dB μ V)	Factor (dB)	Measure Level (dB μ V/m)	Limit (dB μ V/m)	Margin (dB)	Detector	Polarization
*	9840.0	51.6	-5.4	46.2	68.2	-22.0	Peak	Horizontal
	12160.5	49.4	-3.8	45.6	74.0	-28.4	Peak	Horizontal
	15671.0	47.2	2.1	49.3	74.0	-24.7	Peak	Horizontal
*	17158.5	47.2	4.2	51.4	68.2	-16.8	Peak	Horizontal
*	9840.0	50.7	-5.4	45.3	68.2	-22.9	Peak	Vertical
	12262.5	49.9	-3.7	46.2	74.0	-27.8	Peak	Vertical
	15577.5	47.7	1.7	49.4	74.0	-24.6	Peak	Vertical
*	16776.0	47.3	4.1	51.4	68.2	-16.8	Peak	Vertical

Note 1: "*" is not in restricted band, its limit is -27dBm/MHz. At a distance of 3 meters, the field strength limit in dB μ V/m can be determined by adding a "conversion" factor of 95.2dB to the EIRP limit of -27dBm/MHz to obtain the limit for out of band spurious emissions.

Note 2: Measure Level (dB μ V/m) = Reading Level (dB μ V) + Factor (dB)

Factor (dB) = Cable Loss (dB) + Antenna Factor (dB/m) - Pre_Amplifier Gain (dB)

Test Site	SIP-AC1	Test Engineer	Edward Zhang
Test Date	2021/06/04	Test Mode:	802.11a - Ant 0 + 1 (CDD Mode)
Test Channel	100		
Remark:	1. Average measurement was not performed if peak level lower than average limit. 2. Other frequency was 20dB below limit line within 1-18GHz, there is not show in the report.		

Mark	Frequency (MHz)	Reading Level (dBμV)	Factor (dB)	Measure Level (dBμV/m)	Limit (dBμV/m)	Margin (dB)	Detector	Polarization
*	9993.0	50.8	-5.1	45.7	68.2	-22.5	Peak	Horizontal
	12279.5	49.4	-3.6	45.8	74.0	-28.2	Peak	Horizontal
	15764.5	47.2	2.7	49.9	74.0	-24.1	Peak	Horizontal
*	17294.5	47.0	4.9	51.9	68.2	-16.3	Peak	Horizontal
*	9916.5	50.4	-5.2	45.2	68.2	-23.0	Peak	Vertical
	12636.5	50.1	-3.6	46.5	74.0	-27.5	Peak	Vertical
	15756.0	47.0	2.6	49.6	74.0	-24.4	Peak	Vertical
*	17099.0	47.5	4.0	51.5	68.2	-16.7	Peak	Vertical

Note 1: "*" is not in restricted band, its limit is -27dBm/MHz. At a distance of 3 meters, the field strength limit in dBμV/m can be determined by adding a "conversion" factor of 95.2dB to the EIRP limit of -27dBm/MHz to obtain the limit for out of band spurious emissions.

Note 2: Measure Level (dBμV/m) = Reading Level (dBμV) + Factor (dB)

Factor (dB) = Cable Loss (dB) + Antenna Factor (dB/m) - Pre_Amplifier Gain (dB)

Test Site	SIP-AC1	Test Engineer	Edward Zhang
Test Date	2021/06/04	Test Mode	802.11a - Ant 0 + 1 (CDD Mode)
Test Channel	116		
Remark:	1. Average measurement was not performed if peak level lower than average limit. 2. Other frequency was 20dB below limit line within 1-18GHz, there is not show in the report.		

Mark	Frequency (MHz)	Reading Level (dBμV)	Factor (dB)	Measure Level (dBμV/m)	Limit (dBμV/m)	Margin (dB)	Detector	Polarization
*	9874.0	51.0	-5.3	45.7	68.2	-22.5	Peak	Horizontal
	12160.5	49.6	-3.8	45.8	74.0	-28.2	Peak	Horizontal
	15858.0	47.3	2.7	50.0	74.0	-24.0	Peak	Horizontal
*	16742.0	48.0	4.2	52.2	68.2	-16.0	Peak	Horizontal
*	9721.0	50.3	-5.3	45.0	68.2	-23.2	Peak	Vertical
	11633.5	50.7	-4.4	46.3	74.0	-27.7	Peak	Vertical
	15985.5	46.3	2.4	48.7	74.0	-25.3	Peak	Vertical
*	16827.0	47.1	4.3	51.4	68.2	-16.8	Peak	Vertical

Note 1: "*" is not in restricted band, its limit is -27dBm/MHz. At a distance of 3 meters, the field strength limit in dBμV/m can be determined by adding a "conversion" factor of 95.2dB to the EIRP limit of -27dBm/MHz to obtain the limit for out of band spurious emissions.

Note 2: Measure Level (dBμV/m) = Reading Level (dBμV) + Factor (dB)

Factor (dB) = Cable Loss (dB) + Antenna Factor (dB/m) - Pre_Amplifier Gain (dB)

Test Site	SIP-AC1	Test Engineer	Edward Zhang
Test Date	2021/06/04	Test Mode	802.11a - Ant 0 + 1 (CDD Mode)
Test Channel	140		
Remark:	1. Average measurement was not performed if peak level lower than average limit. 2. Other frequency was 20dB below limit line within 1-18GHz, there is not show in the report.		

Mark	Frequency (MHz)	Reading Level (dB μ V)	Factor (dB)	Measure Level (dB μ V/m)	Limit (dB μ V/m)	Margin (dB)	Detector	Polarization
*	9908.0	50.7	-5.2	45.5	68.2	-22.7	Peak	Horizontal
	12024.5	49.8	-4.1	45.7	74.0	-28.3	Peak	Horizontal
	15671.0	47.4	2.1	49.5	74.0	-24.5	Peak	Horizontal
*	17396.5	45.9	5.2	51.1	68.2	-17.1	Peak	Horizontal
*	9984.5	50.1	-5.2	44.9	68.2	-23.3	Peak	Vertical
	12177.5	49.3	-3.8	45.5	74.0	-28.5	Peak	Vertical
	15875.0	47.8	2.2	50.0	74.0	-24.0	Peak	Vertical
*	16818.5	46.9	4.1	51.0	68.2	-17.2	Peak	Vertical

Note 1: "*" is not in restricted band, its limit is -27dBm/MHz. At a distance of 3 meters, the field strength limit in dB μ V/m can be determined by adding a "conversion" factor of 95.2dB to the EIRP limit of -27dBm/MHz to obtain the limit for out of band spurious emissions.

Note 2: Measure Level (dB μ V/m) = Reading Level (dB μ V) + Factor (dB)

Factor (dB) = Cable Loss (dB) + Antenna Factor (dB/m) - Pre_Amplifier Gain (dB)

Test Site	SIP-AC1	Test Engineer	Edward Zhang
Test Date	2021/06/04	Test Mode	802.11a - Ant 0 + 1 (CDD Mode)
Test Channel	144		
Remark:	1. Average measurement was not performed if peak level lower than average limit. 2. Other frequency was 20dB below limit line within 1-18GHz, there is not show in the report.		

Mark	Frequency (MHz)	Reading Level (dBμV)	Factor (dB)	Measure Level (dBμV/m)	Limit (dBμV/m)	Margin (dB)	Detector	Polarization
*	9916.5	50.4	-5.2	45.2	68.2	-23.0	Peak	Horizontal
	12007.5	48.8	-4.2	44.6	74.0	-29.4	Peak	Horizontal
	15849.5	45.3	2.7	48.0	74.0	-26.0	Peak	Horizontal
*	16886.5	44.7	4.0	48.7	68.2	-19.5	Peak	Horizontal
*	9993.0	50.6	-5.1	45.5	68.2	-22.7	Peak	Vertical
	12254.0	49.3	-3.7	45.6	74.0	-28.4	Peak	Vertical
	16096.0	46.8	2.7	49.5	74.0	-24.5	Peak	Vertical
*	16886.5	44.7	4.0	48.7	68.2	-19.5	Peak	Vertical

Note 1: "*" is not in restricted band, its limit is -27dBm/MHz. At a distance of 3 meters, the field strength limit in dBμV/m can be determined by adding a "conversion" factor of 95.2dB to the EIRP limit of -27dBm/MHz to obtain the limit for out of band spurious emissions.

Note 2: Measure Level (dBμV/m) = Reading Level (dBμV) + Factor (dB)

Factor (dB) = Cable Loss (dB) + Antenna Factor (dB/m) - Pre_Amplifier Gain (dB)

Test Site	SIP-AC1	Test Engineer	Edward Zhang
Test Date	2021/06/04	Test Mode	802.11a - Ant 0 + 1 (CDD Mode)
Test Channel	149		
Remark:	1. Average measurement was not performed if peak level lower than average limit. 2. Other frequency was 20dB below limit line within 1-18GHz, there is not show in the report.		

Mark	Frequency (MHz)	Reading Level (dBμV)	Factor (dB)	Measure Level (dBμV/m)	Limit (dBμV/m)	Margin (dB)	Detector	Polarization
*	6975.5	51.4	-8.1	43.3	68.2	-24.9	Peak	Horizontal
*	9908.0	50.7	-5.2	45.5	68.2	-22.7	Peak	Horizontal
	11982.0	49.9	-3.9	46.0	74.0	-28.0	Peak	Horizontal
	15951.5	47.0	2.3	49.3	74.0	-24.7	Peak	Horizontal
*	7902.0	51.1	-6.7	44.4	68.2	-23.8	Peak	Vertical
*	10086.5	50.2	-5.2	45.0	68.2	-23.2	Peak	Vertical
	12050.0	49.5	-4.0	45.5	74.0	-28.5	Peak	Vertical
	15900.5	47.5	2.1	49.6	74.0	-24.4	Peak	Vertical

Note 1: "*" is not in restricted band, its limit is -27dBm/MHz or -17dBm/MHz. At a distance of 3 meters, the field strength limit in dBμV/m can be determined by adding a "conversion" factor of 95.2dB to the EIRP limit of -27dBm/MHz to obtain the limit for out of band spurious emissions.

Note 2: Measure Level (dBμV/m) = Reading Level (dBμV) + Factor (dB)

Factor (dB) = Cable Loss (dB) + Antenna Factor (dB/m) - Pre_Amplifier Gain (dB)

Test Site	SIP-AC1	Test Engineer	Edward Zhang
Test Date	2021/06/04	Test Mode	802.11a - Ant 0 + 1 (CDD Mode)
Test Channel	157		
Remark:	1. Average measurement was not performed if peak level lower than average limit. 2. Other frequency was 20dB below limit line within 1-18GHz, there is not show in the report.		

Mark	Frequency (MHz)	Reading Level (dB μ V)	Factor (dB)	Measure Level (dB μ V/m)	Limit (dB μ V/m)	Margin (dB)	Detector	Polarization
*	7086.0	51.5	-7.8	43.7	68.2	-24.5	Peak	Horizontal
*	10001.5	50.0	-5.1	44.9	68.2	-23.3	Peak	Horizontal
	12203.0	49.4	-3.9	45.5	74.0	-28.5	Peak	Horizontal
	15790.0	46.7	2.3	49.0	74.0	-25.0	Peak	Horizontal
*	10154.5	50.8	-5.3	45.5	68.2	-22.7	Peak	Vertical
	12033.0	49.2	-4.0	45.2	74.0	-28.8	Peak	Vertical
	15671.0	46.4	2.1	48.5	74.0	-25.5	Peak	Vertical
*	16776.0	46.4	4.1	50.5	68.2	-17.7	Peak	Vertical

Note 1: "*" is not in restricted band, its limit is -27dBm/MHz or -17dBm/MHz. At a distance of 3 meters, the field strength limit in dB μ V/m can be determined by adding a "conversion" factor of 95.2dB to the EIRP limit of -27dBm/MHz to obtain the limit for out of band spurious emissions.

Note 2: Measure Level (dB μ V/m) = Reading Level (dB μ V) + Factor (dB)

Factor (dB) = Cable Loss (dB) + Antenna Factor (dB/m) - Pre_Amplifier Gain (dB)

Test Site	SIP-AC1	Test Engineer	Edward Zhang
Test Date	2021/06/04	Test Mode:	802.11a - Ant 0 + 1 (CDD Mode)
Test Channel	165		
Remark:	1. Average measurement was not performed if peak level lower than average limit. 2. Other frequency was 20dB below limit line within 1-18GHz, there is not show in the report.		

Mark	Frequency (MHz)	Reading Level (dB μ V)	Factor (dB)	Measure Level (dB μ V/m)	Limit (dB μ V/m)	Margin (dB)	Detector	Polarization
*	6975.5	52.5	-8.1	44.4	68.2	-23.8	Peak	Horizontal
*	10078.0	50.3	-5.2	45.1	68.2	-23.1	Peak	Horizontal
	12390.0	49.9	-3.5	46.4	74.0	-27.6	Peak	Horizontal
	16096.0	48.9	2.7	51.6	74.0	-22.4	Peak	Horizontal
*	10078.0	49.5	-5.2	44.3	68.2	-23.9	Peak	Vertical
	11786.5	49.9	-4.3	45.6	74.0	-28.4	Peak	Vertical
	15764.5	46.8	2.7	49.5	74.0	-24.5	Peak	Vertical
*	16801.5	44.6	3.9	48.5	68.2	-19.7	Peak	Vertical

Note 1: "*" is not in restricted band, its limit is -27dBm/MHz or -17dBm/MHz. At a distance of 3 meters, the field strength limit in dB μ V/m can be determined by adding a "conversion" factor of 95.2dB to the EIRP limit of -27dBm/MHz to obtain the limit for out of band spurious emissions.

Note 2: Measure Level (dB μ V/m) = Reading Level (dB μ V) + Factor (dB)

Factor (dB) = Cable Loss (dB) + Antenna Factor (dB/m) - Pre_Amplifier Gain (dB)

Test Site	SIP-AC1	Test Engineer	Edward Zhang
Test Date	2021/06/04	Test Mode	802.11n-HT20 - Ant 0 + 1 (CDD Mode)
Test Channel	36		
Remark:	1. Average measurement was not performed if peak level lower than average limit. 2. Other frequency was 20dB below limit line within 1-18GHz, there is not show in the report.		

Mark	Frequency (MHz)	Reading Level (dBμV)	Factor (dB)	Measure Level (dBμV/m)	Limit (dBμV/m)	Margin (dB)	Detector	Polarization
*	7120.0	50.9	-7.8	43.1	68.2	-25.1	Peak	Horizontal
*	10103.5	50.1	-5.2	44.9	68.2	-23.3	Peak	Horizontal
	11897.0	50.3	-4.4	45.9	74.0	-28.1	Peak	Horizontal
	15637.0	46.6	1.5	48.1	74.0	-25.9	Peak	Horizontal
*	9942.0	49.7	-5.2	44.5	68.2	-23.7	Peak	Vertical
	12152.0	49.7	-3.8	45.9	74.0	-28.1	Peak	Vertical
	15858.0	47.0	2.7	49.7	74.0	-24.3	Peak	Vertical
*	16903.5	45.4	3.9	49.3	68.2	-18.9	Peak	Vertical

Note 1: "*" is not in restricted band, its limit is -27dBm/MHz. At a distance of 3 meters, the field strength limit in dBμV/m can be determined by adding a "conversion" factor of 95.2dB to the EIRP limit of -27dBm/MHz to obtain the limit for out of band spurious emissions.

Note 2: Measure Level (dBμV/m) = Reading Level (dBμV) + Factor (dB)

Factor (dB) = Cable Loss (dB) + Antenna Factor (dB/m) - Pre_Amplifier Gain (dB)

Test Site	SIP-AC1	Test Engineer	Edward Zhang
Test Date	2021/06/04	Test Mode	802.11n-HT20 - Ant 0 + 1 (CDD Mode)
Test Channel	44		
Remark:	1. Average measurement was not performed if peak level lower than average limit. 2. Other frequency was 20dB below limit line within 1-18GHz, there is not show in the report.		

Mark	Frequency (MHz)	Reading Level (dBμV)	Factor (dB)	Measure Level (dBμV/m)	Limit (dBμV/m)	Margin (dB)	Detector	Polarization
*	9942.0	50.2	-5.2	45.0	68.2	-23.2	Peak	Horizontal
	12602.5	49.0	-3.6	45.4	74.0	-28.6	Peak	Horizontal
	15662.5	53.2	1.8	55.0	74.0	-19.0	Peak	Horizontal
	15662.5	40.9	1.8	42.7	54.0	-11.3	Average	Horizontal
*	17107.5	47.4	3.9	51.3	68.2	-16.9	Peak	Horizontal
*	9950.5	50.0	-5.1	44.9	68.2	-23.3	Peak	Vertical
	12211.5	50.0	-3.9	46.1	74.0	-27.9	Peak	Vertical
	15756.0	46.6	2.6	49.2	74.0	-24.8	Peak	Vertical
*	17150.0	46.8	4.2	51.0	68.2	-17.2	Peak	Vertical

Note 1: "*" is not in restricted band, its limit is -27dBm/MHz. At a distance of 3 meters, the field strength limit in dBμV/m can be determined by adding a "conversion" factor of 95.2dB to the EIRP limit of -27dBm/MHz to obtain the limit for out of band spurious emissions.

Note 2: Measure Level (dBμV/m) = Reading Level (dBμV) + Factor (dB)

Factor (dB) = Cable Loss (dB) + Antenna Factor (dB/m) - Pre_Amplifier Gain (dB)

Test Site	SIP-AC1	Test Engineer	Edward Zhang
Test Date	2021/06/04	Test Mode	802.11n-HT20 - Ant 0 + 1 (CDD Mode)
Test Channel	48		
Remark:	1. Average measurement was not performed if peak level lower than average limit. 2. Other frequency was 20dB below limit line within 1-18GHz, there is not show in the report.		

Mark	Frequency (MHz)	Reading Level (dB μ V)	Factor (dB)	Measure Level (dB μ V/m)	Limit (dB μ V/m)	Margin (dB)	Detector	Polarization
*	8726.5	50.3	-5.8	44.5	68.2	-23.7	Peak	Horizontal
*	9814.5	49.4	-5.5	43.9	68.2	-24.3	Peak	Horizontal
	11922.5	50.5	-4.3	46.2	74.0	-27.8	Peak	Horizontal
	15713.5	52.0	1.7	53.7	74.0	-20.3	Peak	Horizontal
	12007.5	48.2	-4.2	44.0	74.0	-30.0	Peak	Vertical
*	13605.5	49.9	-1.9	48.0	68.2	-20.2	Peak	Vertical
	15730.5	50.9	1.9	52.8	74.0	-21.2	Peak	Vertical
*	16759.0	46.6	4.1	50.7	68.2	-17.5	Peak	Vertical

Note 1: "*" is not in restricted band, its limit is -27dBm/MHz. At a distance of 3 meters, the field strength limit in dB μ V/m can be determined by adding a "conversion" factor of 95.2dB to the EIRP limit of -27dBm/MHz to obtain the limit for out of band spurious emissions.

Note 2: Measure Level (dB μ V/m) = Reading Level (dB μ V) + Factor (dB)

Factor (dB) = Cable Loss (dB) + Antenna Factor (dB/m) - Pre_Amplifier Gain (dB)

Test Site	SIP-AC1	Test Engineer	Edward Zhang
Test Date	2021/06/04	Test Mode	802.11n-HT20 - Ant 0 + 1 (CDD Mode)
Test Channel	52		
Remark:	1. Average measurement was not performed if peak level lower than average limit. 2. Other frequency was 20dB below limit line within 1-18GHz, there is not show in the report.		

Mark	Frequency (MHz)	Reading Level (dB μ V)	Factor (dB)	Measure Level (dB μ V/m)	Limit (dB μ V/m)	Margin (dB)	Detector	Polarization
*	10180.0	50.4	-5.1	45.3	68.2	-22.9	Peak	Horizontal
	11982.0	49.1	-3.9	45.2	74.0	-28.8	Peak	Horizontal
	15781.5	50.3	2.5	52.8	74.0	-21.2	Peak	Horizontal
*	16852.5	47.0	4.2	51.2	68.2	-17.0	Peak	Horizontal
*	9993.0	50.8	-5.1	45.7	68.2	-22.5	Peak	Vertical
	11956.5	49.4	-3.9	45.5	74.0	-28.5	Peak	Vertical
	15790.0	48.4	2.3	50.7	74.0	-23.3	Peak	Vertical
*	16733.5	47.1	4.2	51.3	68.2	-16.9	Peak	Vertical

Note 1: "*" is not in restricted band, its limit is -27dBm/MHz. At a distance of 3 meters, the field strength limit in dB μ V/m can be determined by adding a "conversion" factor of 95.2dB to the EIRP limit of -27dBm/MHz to obtain the limit for out of band spurious emissions.

Note 2: Measure Level (dB μ V/m) = Reading Level (dB μ V) + Factor (dB)

Factor (dB) = Cable Loss (dB) + Antenna Factor (dB/m) - Pre_Amplifier Gain (dB)

Test Site	SIP-AC1	Test Engineer	Edward Zhang
Test Date	2021/06/04	Test Mode	802.11n-HT20 - Ant 0 + 1 (CDD Mode)
Test Channel	60		
Remark:	1. Average measurement was not performed if peak level lower than average limit. 2. Other frequency was 20dB below limit line within 1-18GHz, there is not show in the report.		

Mark	Frequency (MHz)	Reading Level (dBμV)	Factor (dB)	Measure Level (dBμV/m)	Limit (dBμV/m)	Margin (dB)	Detector	Polarization
*	9925.0	50.5	-5.3	45.2	68.2	-23.0	Peak	Horizontal
	12449.5	49.3	-3.7	45.6	74.0	-28.4	Peak	Horizontal
	15892.0	48.8	2.1	50.9	74.0	-23.1	Peak	Horizontal
*	16844.0	46.6	4.2	50.8	68.2	-17.4	Peak	Horizontal
*	10171.5	50.1	-5.1	45.0	68.2	-23.2	Peak	Vertical
	12262.5	49.7	-3.7	46.0	74.0	-28.0	Peak	Vertical
	15764.5	47.1	2.7	49.8	74.0	-24.2	Peak	Vertical
*	16716.5	46.8	4.1	50.9	68.2	-17.3	Peak	Vertical

Note 1: "*" is not in restricted band, its limit is -27dBm/MHz. At a distance of 3 meters, the field strength limit in dBμV/m can be determined by adding a "conversion" factor of 95.2dB to the EIRP limit of -27dBm/MHz to obtain the limit for out of band spurious emissions.

Note 2: Measure Level (dBμV/m) = Reading Level (dBμV) + Factor (dB)

Factor (dB) = Cable Loss (dB) + Antenna Factor (dB/m) - Pre_Amplifier Gain (dB)

Test Site	SIP-AC1	Test Engineer	Edward Zhang
Test Date	2021/06/04	Test Mode	802.11n-HT20 - Ant 0 + 1 (CDD Mode)
Test Channel	64		
Remark:	1. Average measurement was not performed if peak level lower than average limit. 2. Other frequency was 20dB below limit line within 1-18GHz, there is not show in the report.		

Mark	Frequency (MHz)	Reading Level (dBμV)	Factor (dB)	Measure Level (dBμV/m)	Limit (dBμV/m)	Margin (dB)	Detector	Polarization
*	9942.0	50.4	-5.2	45.2	68.2	-23.0	Peak	Horizontal
	12254.0	49.9	-3.7	46.2	74.0	-27.8	Peak	Horizontal
	15960.0	46.9	2.3	49.2	74.0	-24.8	Peak	Horizontal
*	16461.5	47.8	3.2	51.0	68.2	-17.2	Peak	Horizontal
*	9959.0	50.3	-5.1	45.2	68.2	-23.0	Peak	Vertical
	11931.0	49.5	-4.1	45.4	74.0	-28.6	Peak	Vertical
	15756.0	46.9	2.6	49.5	74.0	-24.5	Peak	Vertical
*	17192.5	46.8	4.3	51.1	68.2	-17.1	Peak	Vertical

Note 1: "*" is not in restricted band, its limit is -27dBm/MHz. At a distance of 3 meters, the field strength limit in dBμV/m can be determined by adding a "conversion" factor of 95.2dB to the EIRP limit of -27dBm/MHz to obtain the limit for out of band spurious emissions.

Note 2: Measure Level (dBμV/m) = Reading Level (dBμV) + Factor (dB)

Factor (dB) = Cable Loss (dB) + Antenna Factor (dB/m) - Pre_Amplifier Gain (dB)

Test Site	SIP-AC1	Test Engineer	Edward Zhang
Test Date	2021/06/04	Test Mode	802.11n-HT20 - Ant 0 + 1 (CDD Mode)
Test Channel	100		
Remark:	1. Average measurement was not performed if peak level lower than average limit. 2. Other frequency was 20dB below limit line within 1-18GHz, there is not show in the report.		

Mark	Frequency (MHz)	Reading Level (dBμV)	Factor (dB)	Measure Level (dBμV/m)	Limit (dBμV/m)	Margin (dB)	Detector	Polarization
*	9644.5	50.5	-5.3	45.2	68.2	-23.0	Peak	Horizontal
	12058.5	49.6	-3.9	45.7	74.0	-28.3	Peak	Horizontal
	16079.0	47.0	2.9	49.9	74.0	-24.1	Peak	Horizontal
*	17473.0	46.9	4.7	51.6	68.2	-16.6	Peak	Horizontal
*	9916.5	50.4	-5.2	45.2	68.2	-23.0	Peak	Vertical
	11642.0	49.7	-4.3	45.4	74.0	-28.6	Peak	Vertical
	15773.0	46.9	2.8	49.7	74.0	-24.3	Peak	Vertical
*	16937.5	47.2	4.0	51.2	68.2	-17.0	Peak	Vertical

Note 1: "*" is not in restricted band, its limit is -27dBm/MHz. At a distance of 3 meters, the field strength limit in dBμV/m can be determined by adding a "conversion" factor of 95.2dB to the EIRP limit of -27dBm/MHz to obtain the limit for out of band spurious emissions.

Note 2: Measure Level (dBμV/m) = Reading Level (dBμV) + Factor (dB)

Factor (dB) = Cable Loss (dB) + Antenna Factor (dB/m) - Pre_Amplifier Gain (dB)

Test Site	SIP-AC1	Test Engineer	Edward Zhang
Test Date	2021/06/04	Test Mode	802.11n-HT20 - Ant 0 + 1 (CDD Mode)
Test Channel	116		
Remark:	1. Average measurement was not performed if peak level lower than average limit. 2. Other frequency was 20dB below limit line within 1-18GHz, there is not show in the report.		

Mark	Frequency (MHz)	Reading Level (dBμV)	Factor (dB)	Measure Level (dBμV/m)	Limit (dBμV/m)	Margin (dB)	Detector	Polarization
*	10214.0	50.6	-5.2	45.4	68.2	-22.8	Peak	Horizontal
	11914.0	50.6	-4.4	46.2	74.0	-27.8	Peak	Horizontal
	15773.0	47.1	2.8	49.9	74.0	-24.1	Peak	Horizontal
*	16725.0	46.5	4.3	50.8	68.2	-17.4	Peak	Horizontal
*	10129.0	50.1	-5.3	44.8	68.2	-23.4	Peak	Vertical
	12033.0	49.8	-4.0	45.8	74.0	-28.2	Peak	Vertical
	15781.5	47.1	2.5	49.6	74.0	-24.4	Peak	Vertical
*	17167.0	47.6	4.2	51.8	68.2	-16.4	Peak	Vertical

Note 1: "*" is not in restricted band, its limit is -27dBm/MHz. At a distance of 3 meters, the field strength limit in dBμV/m can be determined by adding a "conversion" factor of 95.2dB to the EIRP limit of -27dBm/MHz to obtain the limit for out of band spurious emissions.

Note 2: Measure Level (dBμV/m) = Reading Level (dBμV) + Factor (dB)

Factor (dB) = Cable Loss (dB) + Antenna Factor (dB/m) - Pre_Amplifier Gain (dB)

Test Site	SIP-AC1	Test Engineer	Edward Zhang
Test Date	2021/06/04	Test Mode	802.11n-HT20 - Ant 0 + 1 (CDD Mode)
Test Channel	140		
Remark:	1. Average measurement was not performed if peak level lower than average limit. 2. Other frequency was 20dB below limit line within 1-18GHz, there is not show in the report.		

Mark	Frequency (MHz)	Reading Level (dBμV)	Factor (dB)	Measure Level (dBμV/m)	Limit (dBμV/m)	Margin (dB)	Detector	Polarization
*	9712.5	51.5	-5.3	46.2	68.2	-22.0	Peak	Horizontal
	11965.0	50.1	-3.9	46.2	74.0	-27.8	Peak	Horizontal
	15756.0	47.0	2.6	49.6	74.0	-24.4	Peak	Horizontal
*	16725.0	47.7	4.3	52.0	68.2	-16.2	Peak	Horizontal
*	10197.0	50.9	-5.4	45.5	68.2	-22.7	Peak	Vertical
	11013.0	50.9	-5.1	45.8	74.0	-28.2	Peak	Vertical
	15764.5	47.6	2.7	50.3	74.0	-23.7	Peak	Vertical
*	16827.0	46.4	4.3	50.7	68.2	-17.5	Peak	Vertical

Note 1: "*" is not in restricted band, its limit is -27dBm/MHz. At a distance of 3 meters, the field strength limit in dBμV/m can be determined by adding a "conversion" factor of 95.2dB to the EIRP limit of -27dBm/MHz to obtain the limit for out of band spurious emissions.

Note 2: Measure Level (dBμV/m) = Reading Level (dBμV) + Factor (dB)

Factor (dB) = Cable Loss (dB) + Antenna Factor (dB/m) - Pre_Amplifier Gain (dB)

Test Site	SIP-AC1	Test Engineer	Edward Zhang
Test Date	2021/06/04	Test Mode	802.11n-HT20 - Ant 0 + 1 (CDD Mode)
Test Channel	144		
Remark:	1. Average measurement was not performed if peak level lower than average limit. 2. Other frequency was 20dB below limit line within 1-18GHz, there is not show in the report.		

Mark	Frequency (MHz)	Reading Level (dB μ V)	Factor (dB)	Measure Level (dB μ V/m)	Limit (dB μ V/m)	Margin (dB)	Detector	Polarization
*	9738.0	51.6	-5.5	46.1	68.2	-22.1	Peak	Horizontal
	12050.0	49.4	-4.0	45.4	74.0	-28.6	Peak	Horizontal
	15773.0	46.4	2.8	49.2	74.0	-24.8	Peak	Horizontal
*	17141.5	47.2	4.2	51.4	68.2	-16.8	Peak	Horizontal
*	10435.0	51.2	-5.5	45.7	68.2	-22.5	Peak	Vertical
	11446.5	50.3	-4.8	45.5	74.0	-28.5	Peak	Vertical
	15858.0	47.0	2.7	49.7	74.0	-24.3	Peak	Vertical
*	16759.0	46.8	4.1	50.9	68.2	-17.3	Peak	Vertical

Note 1: "*" is not in restricted band, its limit is -27dBm/MHz. At a distance of 3 meters, the field strength limit in dB μ V/m can be determined by adding a "conversion" factor of 95.2dB to the EIRP limit of -27dBm/MHz to obtain the limit for out of band spurious emissions.

Note 2: Measure Level (dB μ V/m) = Reading Level (dB μ V) + Factor (dB)

Factor (dB) = Cable Loss (dB) + Antenna Factor (dB/m) - Pre_Amplifier Gain (dB)

Test Site	SIP-AC1	Test Engineer	Edward Zhang
Test Date	2021/06/04	Test Mode	802.11n-HT20 - Ant 0 + 1 (CDD Mode)
Test Channel	149		
Remark:	1. Average measurement was not performed if peak level lower than average limit. 2. Other frequency was 20dB below limit line within 1-18GHz, there is not show in the report.		

Mark	Frequency (MHz)	Reading Level (dB μ V)	Factor (dB)	Measure Level (dB μ V/m)	Limit (dB μ V/m)	Margin (dB)	Detector	Polarization
*	10044.0	50.6	-5.1	45.5	68.2	-22.7	Peak	Horizontal
	12271.0	50.5	-3.6	46.9	74.0	-27.1	Peak	Horizontal
	15365.0	48.6	1.4	50.0	74.0	-24.0	Peak	Horizontal
*	16725.0	46.9	4.3	51.2	68.2	-17.0	Peak	Horizontal
*	10120.5	50.4	-5.2	45.2	68.2	-23.0	Peak	Vertical
	11812.0	50.4	-4.6	45.8	74.0	-28.2	Peak	Vertical
	15960.0	47.5	2.3	49.8	74.0	-24.2	Peak	Vertical
*	16861.0	47.3	4.2	51.5	68.2	-16.7	Peak	Vertical

Note 1: "*" is not in restricted band, its limit is -27dBm/MHz or -17dBm/MHz. At a distance of 3 meters, the field strength limit in dB μ V/m can be determined by adding a "conversion" factor of 95.2dB to the EIRP limit of -27dBm/MHz to obtain the limit for out of band spurious emissions.

Note 2: Measure Level (dB μ V/m) = Reading Level (dB μ V) + Factor (dB)

Factor (dB) = Cable Loss (dB) + Antenna Factor (dB/m) - Pre_Amplifier Gain (dB)

Test Site	SIP-AC1	Test Engineer	Edward Zhang
Test Date	2021/06/04	Test Mode	802.11n-HT20 - Ant 0 + 1 (CDD Mode)
Test Channel	157		
Remark:	1. Average measurement was not performed if peak level lower than average limit. 2. Other frequency was 20dB below limit line within 1-18GHz, there is not show in the report.		

Mark	Frequency (MHz)	Reading Level (dB μ V)	Factor (dB)	Measure Level (dB μ V/m)	Limit (dB μ V/m)	Margin (dB)	Detector	Polarization
*	10103.5	50.7	-5.2	45.5	68.2	-22.7	Peak	Horizontal
	12126.5	50.1	-4.0	46.1	74.0	-27.9	Peak	Horizontal
	15781.5	47.1	2.5	49.6	74.0	-24.4	Peak	Horizontal
*	16801.5	47.2	3.9	51.1	68.2	-17.1	Peak	Horizontal
*	10027.0	51.1	-5.2	45.9	68.2	-22.3	Peak	Vertical
	12194.5	50.2	-3.9	46.3	74.0	-27.7	Peak	Vertical
	15858.0	46.5	2.7	49.2	74.0	-24.8	Peak	Vertical
*	16895.0	47.6	3.9	51.5	68.2	-16.7	Peak	Vertical

Note 1: "*" is not in restricted band, its limit is -27dBm/MHz or -17dBm/MHz. At a distance of 3 meters, the field strength limit in dB μ V/m can be determined by adding a "conversion" factor of 95.2dB to the EIRP limit of -27dBm/MHz to obtain the limit for out of band spurious emissions.

Note 2: Measure Level (dB μ V/m) = Reading Level (dB μ V) + Factor (dB)

Factor (dB) = Cable Loss (dB) + Antenna Factor (dB/m) - Pre_Amplifier Gain (dB)

Test Site	SIP-AC1	Test Engineer	Edward Zhang
Test Date	2021/06/04	Test Mode	802.11n-HT20 - Ant 0 + 1 (CDD Mode)
Test Channel	165		
Remark:	1. Average measurement was not performed if peak level lower than average limit. 2. Other frequency was 20dB below limit line within 1-18GHz, there is not show in the report.		

Mark	Frequency (MHz)	Reading Level (dB μ V)	Factor (dB)	Measure Level (dB μ V/m)	Limit (dB μ V/m)	Margin (dB)	Detector	Polarization
*	10282.0	51.0	-5.3	45.7	68.2	-22.5	Peak	Horizontal
	11880.0	49.9	-4.0	45.9	74.0	-28.1	Peak	Horizontal
	15807.0	48.0	2.0	50.0	74.0	-24.0	Peak	Horizontal
*	17303.0	46.3	4.9	51.2	68.2	-17.0	Peak	Horizontal
*	10010.0	50.2	-5.0	45.2	68.2	-23.0	Peak	Vertical
	12033.0	49.5	-4.0	45.5	74.0	-28.5	Peak	Vertical
	16070.5	47.5	2.7	50.2	74.0	-23.8	Peak	Vertical
*	16869.5	47.0	4.2	51.2	68.2	-17.0	Peak	Vertical

Note 1: "*" is not in restricted band, its limit is -27dBm/MHz or -17dBm/MHz. At a distance of 3 meters, the field strength limit in dB μ V/m can be determined by adding a "conversion" factor of 95.2dB to the EIRP limit of -27dBm/MHz to obtain the limit for out of band spurious emissions.

Note 2: Measure Level (dB μ V/m) = Reading Level (dB μ V) + Factor (dB)

Factor (dB) = Cable Loss (dB) + Antenna Factor (dB/m) - Pre_Amplifier Gain (dB)

Test Site	SIP-AC1	Test Engineer	Edward Zhang
Test Date	2021/06/04	Test Mode	802.11n-HT40 - Ant 0 + 1 (CDD Mode)
Test Channel	38		
Remark:	1. Average measurement was not performed if peak level lower than average limit. 2. Other frequency was 20dB below limit line within 1-18GHz, there is not show in the report.		

Mark	Frequency (MHz)	Reading Level (dBμV)	Factor (dB)	Measure Level (dBμV/m)	Limit (dBμV/m)	Margin (dB)	Detector	Polarization
*	10010.0	50.5	-5.0	45.5	68.2	-22.7	Peak	Horizontal
	11990.5	50.2	-4.0	46.2	74.0	-27.8	Peak	Horizontal
	15960.0	47.6	2.3	49.9	74.0	-24.1	Peak	Horizontal
*	16852.5	47.4	4.2	51.6	68.2	-16.6	Peak	Horizontal
*	10095.0	50.6	-5.3	45.3	68.2	-22.9	Peak	Vertical
	11268.0	51.0	-5.3	45.7	74.0	-28.3	Peak	Vertical
	15560.5	47.5	1.9	49.4	74.0	-24.6	Peak	Vertical
*	16903.5	47.3	3.9	51.2	68.2	-17.0	Peak	Vertical

Note 1: "*" is not in restricted band, its limit is -27dBm/MHz. At a distance of 3 meters, the field strength limit in dBμV/m can be determined by adding a "conversion" factor of 95.2dB to the EIRP limit of -27dBm/MHz to obtain the limit for out of band spurious emissions.

Note 2: Measure Level (dBμV/m) = Reading Level (dBμV) + Factor (dB)

Factor (dB) = Cable Loss (dB) + Antenna Factor (dB/m) - Pre_Amplifier Gain (dB)

Test Site	SIP-AC1	Test Engineer	Edward Zhang
Test Date	2021/06/04	Test Mode	802.11n-HT40 - Ant 0 + 1 (CDD Mode)
Test Channel	46		
Remark:	1. Average measurement was not performed if peak level lower than average limit. 2. Other frequency was 20dB below limit line within 1-18GHz, there is not show in the report.		

Mark	Frequency (MHz)	Reading Level (dBμV)	Factor (dB)	Measure Level (dBμV/m)	Limit (dBμV/m)	Margin (dB)	Detector	Polarization
*	9916.5	50.5	-5.2	45.3	68.2	-22.9	Peak	Horizontal
	11625.0	50.6	-4.4	46.2	74.0	-27.8	Peak	Horizontal
	15764.5	47.1	2.7	49.8	74.0	-24.2	Peak	Horizontal
*	17235.0	46.9	4.6	51.5	68.2	-16.7	Peak	Horizontal
*	9993.0	51.0	-5.1	45.9	68.2	-22.3	Peak	Vertical
	11863.0	50.4	-4.2	46.2	74.0	-27.8	Peak	Vertical
	15764.5	46.1	2.7	48.8	74.0	-25.2	Peak	Vertical
*	16750.5	46.3	4.2	50.5	68.2	-17.7	Peak	Vertical

Note 1: "*" is not in restricted band, its limit is -27dBm/MHz. At a distance of 3 meters, the field strength limit in dBμV/m can be determined by adding a "conversion" factor of 95.2dB to the EIRP limit of -27dBm/MHz to obtain the limit for out of band spurious emissions.

Note 2: Measure Level (dBμV/m) = Reading Level (dBμV) + Factor (dB)

Factor (dB) = Cable Loss (dB) + Antenna Factor (dB/m) - Pre_Amplifier Gain (dB)

Test Site	SIP-AC1	Test Engineer	Edward Zhang
Test Date	2021/06/04	Test Mode	802.11n-HT40 - Ant 0 + 1 (CDD Mode)
Test Channel	54		
Remark:	1. Average measurement was not performed if peak level lower than average limit. 2. Other frequency was 20dB below limit line within 1-18GHz, there is not show in the report.		

Mark	Frequency (MHz)	Reading Level (dBμV)	Factor (dB)	Measure Level (dBμV/m)	Limit (dBμV/m)	Margin (dB)	Detector	Polarization
*	9848.5	50.8	-5.3	45.5	68.2	-22.7	Peak	Horizontal
	11871.5	50.5	-4.1	46.4	74.0	-27.6	Peak	Horizontal
	15790.0	47.5	2.3	49.8	74.0	-24.2	Peak	Horizontal
*	16742.0	46.7	4.2	50.9	68.2	-17.3	Peak	Horizontal
*	9857.0	50.6	-5.3	45.3	68.2	-22.9	Peak	Vertical
	10792.0	51.2	-5.6	45.6	74.0	-28.4	Peak	Vertical
	15764.5	46.8	2.7	49.5	74.0	-24.5	Peak	Vertical
*	16733.5	46.7	4.2	50.9	68.2	-17.3	Peak	Vertical

Note 1: "*" is not in restricted band, its limit is -27dBm/MHz. At a distance of 3 meters, the field strength limit in dBμV/m can be determined by adding a "conversion" factor of 95.2dB to the EIRP limit of -27dBm/MHz to obtain the limit for out of band spurious emissions.

Note 2: Measure Level (dBμV/m) = Reading Level (dBμV) + Factor (dB)

Factor (dB) = Cable Loss (dB) + Antenna Factor (dB/m) - Pre_Amplifier Gain (dB)

Test Site	SIP-AC1	Test Engineer	Edward Zhang
Test Date	2021/06/04	Test Mode	802.11n-HT40 - Ant 0 + 1 (CDD Mode)
Test Channel	62		
Remark:	1. Average measurement was not performed if peak level lower than average limit. 2. Other frequency was 20dB below limit line within 1-18GHz, there is not show in the report.		

Mark	Frequency (MHz)	Reading Level (dBμV)	Factor (dB)	Measure Level (dBμV/m)	Limit (dBμV/m)	Margin (dB)	Detector	Polarization
*	9950.5	51.1	-5.1	46.0	68.2	-22.2	Peak	Horizontal
	12152.0	50.3	-3.8	46.5	74.0	-27.5	Peak	Horizontal
	15781.5	47.4	2.5	49.9	74.0	-24.1	Peak	Horizontal
*	17447.5	47.2	5.0	52.2	68.2	-16.0	Peak	Horizontal
*	9806.0	51.5	-5.5	46.0	68.2	-22.2	Peak	Vertical
	11880.0	49.8	-4.0	45.8	74.0	-28.2	Peak	Vertical
	15747.5	47.0	2.4	49.4	74.0	-24.6	Peak	Vertical
*	16818.5	47.8	4.1	51.9	68.2	-16.3	Peak	Vertical

Note 1: "*" is not in restricted band, its limit is -27dBm/MHz. At a distance of 3 meters, the field strength limit in dBμV/m can be determined by adding a "conversion" factor of 95.2dB to the EIRP limit of -27dBm/MHz to obtain the limit for out of band spurious emissions.

Note 2: Measure Level (dBμV/m) = Reading Level (dBμV) + Factor (dB)

Factor (dB) = Cable Loss (dB) + Antenna Factor (dB/m) - Pre_Amplifier Gain (dB)

Test Site	SIP-AC1	Test Engineer	Edward Zhang
Test Date	2021/06/04	Test Mode	802.11n-HT40 - Ant 0 + 1 (CDD Mode)
Test Channel	102		
Remark:	1. Average measurement was not performed if peak level lower than average limit. 2. Other frequency was 20dB below limit line within 1-18GHz, there is not show in the report.		

Mark	Frequency (MHz)	Reading Level (dBμV)	Factor (dB)	Measure Level (dBμV/m)	Limit (dBμV/m)	Margin (dB)	Detector	Polarization
*	9840.0	50.8	-5.4	45.4	68.2	-22.8	Peak	Horizontal
	12288.0	49.1	-3.6	45.5	74.0	-28.5	Peak	Horizontal
	15764.5	47.0	2.7	49.7	74.0	-24.3	Peak	Horizontal
*	16733.5	47.2	4.2	51.4	68.2	-16.8	Peak	Horizontal
*	9950.5	50.9	-5.1	45.8	68.2	-22.4	Peak	Vertical
	11608.0	50.2	-4.7	45.5	74.0	-28.5	Peak	Vertical
	15764.5	47.7	2.7	50.4	74.0	-23.6	Peak	Vertical
*	17269.0	47.9	4.3	52.2	68.2	-16.0	Peak	Vertical

Note 1: "*" is not in restricted band, its limit is -27dBm/MHz. At a distance of 3 meters, the field strength limit in dBμV/m can be determined by adding a "conversion" factor of 95.2dB to the EIRP limit of -27dBm/MHz to obtain the limit for out of band spurious emissions.

Note 2: Measure Level (dBμV/m) = Reading Level (dBμV) + Factor (dB)

Factor (dB) = Cable Loss (dB) + Antenna Factor (dB/m) - Pre_Amplifier Gain (dB)

Test Site	SIP-AC1	Test Engineer	Edward Zhang
Test Date	2021/06/04	Test Mode	802.11n-HT40 - Ant 0 + 1 (CDD Mode)
Test Channel	110		
Remark:	1. Average measurement was not performed if peak level lower than average limit. 2. Other frequency was 20dB below limit line within 1-18GHz, there is not show in the report.		

Mark	Frequency (MHz)	Reading Level (dBμV)	Factor (dB)	Measure Level (dBμV/m)	Limit (dBμV/m)	Margin (dB)	Detector	Polarization
*	10401.0	51.5	-5.4	46.1	68.2	-22.1	Peak	Horizontal
	11285.0	50.4	-5.1	45.3	74.0	-28.7	Peak	Horizontal
	15747.5	47.0	2.4	49.4	74.0	-24.6	Peak	Horizontal
*	16835.5	46.1	4.3	50.4	68.2	-17.8	Peak	Horizontal
*	9993.0	50.7	-5.1	45.6	68.2	-22.6	Peak	Vertical
	12475.0	49.5	-3.7	45.8	74.0	-28.2	Peak	Vertical
	15747.5	48.0	2.4	50.4	74.0	-23.6	Peak	Vertical
*	17464.5	46.6	4.8	51.4	68.2	-16.8	Peak	Vertical

Note 1: "*" is not in restricted band, its limit is -27dBm/MHz. At a distance of 3 meters, the field strength limit in dBμV/m can be determined by adding a "conversion" factor of 95.2dB to the EIRP limit of -27dBm/MHz to obtain the limit for out of band spurious emissions.

Note 2: Measure Level (dBμV/m) = Reading Level (dBμV) + Factor (dB)

Factor (dB) = Cable Loss (dB) + Antenna Factor (dB/m) - Pre_Amplifier Gain (dB)

Test Site	SIP-AC1	Test Engineer	Edward Zhang
Test Date	2021/06/04	Test Mode	802.11n-HT40 - Ant 0 + 1 (CDD Mode)
Test Channel	134		
Remark:	1. Average measurement was not performed if peak level lower than average limit. 2. Other frequency was 20dB below limit line within 1-18GHz, there is not show in the report.		

Mark	Frequency (MHz)	Reading Level (dBμV)	Factor (dB)	Measure Level (dBμV/m)	Limit (dBμV/m)	Margin (dB)	Detector	Polarization
*	9891.0	50.5	-5.2	45.3	68.2	-22.9	Peak	Horizontal
	11956.5	49.5	-3.9	45.6	74.0	-28.4	Peak	Horizontal
	15747.5	47.1	2.4	49.5	74.0	-24.5	Peak	Horizontal
*	17388.0	45.8	5.3	51.1	68.2	-17.1	Peak	Horizontal
*	9644.5	51.1	-5.3	45.8	68.2	-22.4	Peak	Vertical
	12407.0	50.0	-3.7	46.3	74.0	-27.7	Peak	Vertical
	15764.5	46.6	2.7	49.3	74.0	-24.7	Peak	Vertical
*	16852.5	46.6	4.2	50.8	68.2	-17.4	Peak	Vertical

Note 1: "*" is not in restricted band, its limit is -27dBm/MHz. At a distance of 3 meters, the field strength limit in dBμV/m can be determined by adding a "conversion" factor of 95.2dB to the EIRP limit of -27dBm/MHz to obtain the limit for out of band spurious emissions.

Note 2: Measure Level (dBμV/m) = Reading Level (dBμV) + Factor (dB)

Factor (dB) = Cable Loss (dB) + Antenna Factor (dB/m) - Pre_Amplifier Gain (dB)

Test Site	SIP-AC1	Test Engineer	Edward Zhang
Test Date	2021/06/04	Test Mode	802.11n-HT40 - Ant 0 + 1 (CDD Mode)
Test Channel	142		
Remark:	1. Average measurement was not performed if peak level lower than average limit. 2. Other frequency was 20dB below limit line within 1-18GHz, there is not show in the report.		

Mark	Frequency (MHz)	Reading Level (dBμV)	Factor (dB)	Measure Level (dBμV/m)	Limit (dBμV/m)	Margin (dB)	Detector	Polarization
*	9840.0	50.3	-5.4	44.9	68.2	-23.3	Peak	Horizontal
	11327.5	50.1	-5.0	45.1	74.0	-28.9	Peak	Horizontal
	15764.5	47.6	2.7	50.3	74.0	-23.7	Peak	Horizontal
*	17388.0	45.8	5.3	51.1	68.2	-17.1	Peak	Horizontal
*	9891.0	50.9	-5.2	45.7	68.2	-22.5	Peak	Vertical
	11778.0	49.3	-4.2	45.1	74.0	-28.9	Peak	Vertical
	15696.5	47.6	1.8	49.4	74.0	-24.6	Peak	Vertical
*	16835.5	46.9	4.3	51.2	68.2	-17.0	Peak	Vertical

Note 1: "*" is not in restricted band, its limit is -27dBm/MHz. At a distance of 3 meters, the field strength limit in dBμV/m can be determined by adding a "conversion" factor of 95.2dB to the EIRP limit of -27dBm/MHz to obtain the limit for out of band spurious emissions.

Note 2: Measure Level (dBμV/m) = Reading Level (dBμV) + Factor (dB)

Factor (dB) = Cable Loss (dB) + Antenna Factor (dB/m) - Pre_Amplifier Gain (dB)

Test Site	SIP-AC1	Test Engineer	Edward Zhang
Test Date	2021/06/04	Test Mode	802.11n-HT40 - Ant 0 + 1 (CDD Mode)
Test Channel	151		
Remark:	1. Average measurement was not performed if peak level lower than average limit. 2. Other frequency was 20dB below limit line within 1-18GHz, there is not show in the report.		

Mark	Frequency (MHz)	Reading Level (dBμV)	Factor (dB)	Measure Level (dBμV/m)	Limit (dBμV/m)	Margin (dB)	Detector	Polarization
*	10180.0	50.3	-5.1	45.2	68.2	-23.0	Peak	Horizontal
	11463.5	50.1	-4.6	45.5	74.0	-28.5	Peak	Horizontal
	15739.0	47.0	2.2	49.2	74.0	-24.8	Peak	Horizontal
*	16750.5	46.7	4.2	50.9	68.2	-17.3	Peak	Horizontal
*	10435.0	51.6	-5.5	46.1	68.2	-22.1	Peak	Vertical
	12407.0	50.2	-3.7	46.5	74.0	-27.5	Peak	Vertical
	15764.5	46.6	2.7	49.3	74.0	-24.7	Peak	Vertical
*	16929.0	47.0	4.0	51.0	68.2	-17.2	Peak	Vertical

Note 1: "*" is not in restricted band, its limit is -27dBm/MHz or -17dBm/MHz. At a distance of 3 meters, the field strength limit in dBμV/m can be determined by adding a "conversion" factor of 95.2dB to the EIRP limit of -27dBm/MHz to obtain the limit for out of band spurious emissions.

Note 2: Measure Level (dBμV/m) = Reading Level (dBμV) + Factor (dB)

Factor (dB) = Cable Loss (dB) + Antenna Factor (dB/m) - Pre_Amplifier Gain (dB)

Test Site	SIP-AC1	Test Engineer	Edward Zhang
Test Date	2021/06/04	Test Mode	802.11n-HT40 - Ant 0 + 1 (CDD Mode)
Test Channel	159		
Remark:	1. Average measurement was not performed if peak level lower than average limit. 2. Other frequency was 20dB below limit line within 1-18GHz, there is not show in the report.		

Mark	Frequency (MHz)	Reading Level (dB μ V)	Factor (dB)	Measure Level (dB μ V/m)	Limit (dB μ V/m)	Margin (dB)	Detector	Polarization
*	9653.0	51.0	-5.2	45.8	68.2	-22.4	Peak	Horizontal
	11650.5	50.5	-4.4	46.1	74.0	-27.9	Peak	Horizontal
	15773.0	46.6	2.8	49.4	74.0	-24.6	Peak	Horizontal
*	16759.0	46.2	4.1	50.3	68.2	-17.9	Peak	Horizontal
*	10273.5	51.0	-5.3	45.7	68.2	-22.5	Peak	Vertical
	12330.5	49.6	-3.8	45.8	74.0	-28.2	Peak	Vertical
	15756.0	47.5	2.6	50.1	74.0	-23.9	Peak	Vertical
*	17430.5	47.0	5.1	52.1	68.2	-16.1	Peak	Vertical

Note 1: "*" is not in restricted band, its limit is -27dBm/MHz or -17dBm/MHz. At a distance of 3 meters, the field strength limit in dB μ V/m can be determined by adding a "conversion" factor of 95.2dB to the EIRP limit of -27dBm/MHz to obtain the limit for out of band spurious emissions.

Note 2: Measure Level (dB μ V/m) = Reading Level (dB μ V) + Factor (dB)

Factor (dB) = Cable Loss (dB) + Antenna Factor (dB/m) - Pre_Amplifier Gain (dB)

Test Site	SIP-AC1	Test Engineer	Edward Zhang
Test Date	2021/06/04	Test Mode	802.11ac-VHT20 - Ant 0 + 1 (CDD Mode)
Test Channel	36		
Remark:	1. Average measurement was not performed if peak level lower than average limit. 2. Other frequency was 20dB below limit line within 1-18GHz, there is not show in the report.		

Mark	Frequency (MHz)	Reading Level (dBμV)	Factor (dB)	Measure Level (dBμV/m)	Limit (dBμV/m)	Margin (dB)	Detector	Polarization
*	9704.0	50.4	-5.2	45.2	68.2	-23.0	Peak	Horizontal
	12305.0	49.7	-3.7	46.0	74.0	-28.0	Peak	Horizontal
	15603.0	47.3	1.6	48.9	74.0	-25.1	Peak	Horizontal
*	16725.0	47.7	4.3	52.0	68.2	-16.2	Peak	Horizontal
*	9848.5	50.4	-5.3	45.1	68.2	-23.1	Peak	Vertical
	11693.0	50.3	-4.6	45.7	74.0	-28.3	Peak	Vertical
	15756.0	46.7	2.6	49.3	74.0	-24.7	Peak	Vertical
*	16776.0	45.7	4.1	49.8	68.2	-18.4	Peak	Vertical

Note 1: "*" is not in restricted band, its limit is -27dBm/MHz. At a distance of 3 meters, the field strength limit in dBμV/m can be determined by adding a "conversion" factor of 95.2dB to the EIRP limit of -27dBm/MHz to obtain the limit for out of band spurious emissions.

Note 2: Measure Level (dBμV/m) = Reading Level (dBμV) + Factor (dB)

Factor (dB) = Cable Loss (dB) + Antenna Factor (dB/m) - Pre_Amplifier Gain (dB)

Test Site	SIP-AC1	Test Engineer	Edward Zhang
Test Date	2021/06/04	Test Mode	802.11ac-VHT20 - Ant 0 + 1 (CDD Mode)
Test Channel	44		
Remark:	1. Average measurement was not performed if peak level lower than average limit. 2. Other frequency was 20dB below limit line within 1-18GHz, there is not show in the report.		

Mark	Frequency (MHz)	Reading Level (dB μ V)	Factor (dB)	Measure Level (dB μ V/m)	Limit (dB μ V/m)	Margin (dB)	Detector	Polarization
*	9644.5	51.7	-5.3	46.4	68.2	-21.8	Peak	Horizontal
	11319.0	50.9	-4.9	46.0	74.0	-28.0	Peak	Horizontal
	15654.0	49.6	1.5	51.1	74.0	-22.9	Peak	Horizontal
*	17490.0	46.4	5.0	51.4	68.2	-16.8	Peak	Horizontal
*	9916.5	50.8	-5.2	45.6	68.2	-22.6	Peak	Vertical
	12160.5	49.7	-3.8	45.9	74.0	-28.1	Peak	Vertical
	15773.0	46.4	2.8	49.2	74.0	-24.8	Peak	Vertical
*	17277.5	46.2	4.6	50.8	68.2	-17.4	Peak	Vertical

Note 1: "*" is not in restricted band, its limit is -27dBm/MHz. At a distance of 3 meters, the field strength limit in dB μ V/m can be determined by adding a "conversion" factor of 95.2dB to the EIRP limit of -27dBm/MHz to obtain the limit for out of band spurious emissions.

Note 2: Measure Level (dB μ V/m) = Reading Level (dB μ V) + Factor (dB)

Factor (dB) = Cable Loss (dB) + Antenna Factor (dB/m) - Pre_Amplifier Gain (dB)

Test Site	SIP-AC1	Test Engineer	Edward Zhang
Test Date	2021/06/04	Test Mode	802.11ac-VHT20 - Ant 0 + 1 (CDD Mode)
Test Channel	48		
Remark:	1. Average measurement was not performed if peak level lower than average limit. 2. Other frequency was 20dB below limit line within 1-18GHz, there is not show in the report.		

Mark	Frequency (MHz)	Reading Level (dB μ V)	Factor (dB)	Measure Level (dB μ V/m)	Limit (dB μ V/m)	Margin (dB)	Detector	Polarization
*	9814.5	51.0	-5.5	45.5	68.2	-22.7	Peak	Horizontal
	12220.0	50.4	-3.9	46.5	74.0	-27.5	Peak	Horizontal
	15722.0	50.4	1.7	52.1	74.0	-21.9	Peak	Horizontal
*	17294.5	45.6	4.9	50.5	68.2	-17.7	Peak	Horizontal
*	9644.5	50.3	-5.3	45.0	68.2	-23.2	Peak	Vertical
	11387.0	50.6	-4.9	45.7	74.0	-28.3	Peak	Vertical
	15713.5	48.1	1.7	49.8	74.0	-24.2	Peak	Vertical
*	17388.0	45.8	5.3	51.1	68.2	-17.1	Peak	Vertical

Note 1: "*" is not in restricted band, its limit is -27dBm/MHz. At a distance of 3 meters, the field strength limit in dB μ V/m can be determined by adding a "conversion" factor of 95.2dB to the EIRP limit of -27dBm/MHz to obtain the limit for out of band spurious emissions.

Note 2: Measure Level (dB μ V/m) = Reading Level (dB μ V) + Factor (dB)

Factor (dB) = Cable Loss (dB) + Antenna Factor (dB/m) - Pre_Amplifier Gain (dB)

Test Site	SIP-AC1	Test Engineer	Edward Zhang
Test Date	2021/06/04	Test Mode	802.11ac-VHT20 - Ant 0 + 1 (CDD Mode)
Test Channel	52		
Remark:	1. Average measurement was not performed if peak level lower than average limit. 2. Other frequency was 20dB below limit line within 1-18GHz, there is not show in the report.		

Mark	Frequency (MHz)	Reading Level (dB μ V)	Factor (dB)	Measure Level (dB μ V/m)	Limit (dB μ V/m)	Margin (dB)	Detector	Polarization
*	9993.0	50.3	-5.1	45.2	68.2	-23.0	Peak	Horizontal
	12058.5	49.5	-3.9	45.6	74.0	-28.4	Peak	Horizontal
	15781.5	49.3	2.5	51.8	74.0	-22.2	Peak	Horizontal
*	16793.0	47.1	4.0	51.1	68.2	-17.1	Peak	Horizontal
*	9755.0	50.8	-5.3	45.5	68.2	-22.7	Peak	Vertical
	12084.0	49.5	-4.0	45.5	74.0	-28.5	Peak	Vertical
	15764.5	47.3	2.7	50.0	74.0	-24.0	Peak	Vertical
*	17430.5	46.5	5.1	51.6	68.2	-16.6	Peak	Vertical

Note 1: "*" is not in restricted band, its limit is -27dBm/MHz. At a distance of 3 meters, the field strength limit in dB μ V/m can be determined by adding a "conversion" factor of 95.2dB to the EIRP limit of -27dBm/MHz to obtain the limit for out of band spurious emissions.

Note 2: Measure Level (dB μ V/m) = Reading Level (dB μ V) + Factor (dB)

Factor (dB) = Cable Loss (dB) + Antenna Factor (dB/m) - Pre_Amplifier Gain (dB)

Test Site	SIP-AC1	Test Engineer	Edward Zhang
Test Date	2021/06/04	Test Mode	802.11ac-VHT20 - Ant 0 + 1 (CDD Mode)
Test Channel	60		
Remark:	1. Average measurement was not performed if peak level lower than average limit. 2. Other frequency was 20dB below limit line within 1-18GHz, there is not show in the report.		

Mark	Frequency (MHz)	Reading Level (dBμV)	Factor (dB)	Measure Level (dBμV/m)	Limit (dBμV/m)	Margin (dB)	Detector	Polarization
*	9950.5	50.8	-5.1	45.7	68.2	-22.5	Peak	Horizontal
	12560.0	49.8	-3.7	46.1	74.0	-27.9	Peak	Horizontal
	15781.5	48.3	2.5	50.8	74.0	-23.2	Peak	Horizontal
*	17600.5	47.0	5.0	52.0	68.2	-16.2	Peak	Horizontal
*	10001.5	50.7	-5.1	45.6	68.2	-22.6	Peak	Vertical
	11897.0	50.3	-4.4	45.9	74.0	-28.1	Peak	Vertical
	15739.0	48.4	2.2	50.6	74.0	-23.4	Peak	Vertical
*	17439.0	45.9	5.1	51.0	68.2	-17.2	Peak	Vertical

Note 1: "*" is not in restricted band, its limit is -27dBm/MHz. At a distance of 3 meters, the field strength limit in dBμV/m can be determined by adding a "conversion" factor of 95.2dB to the EIRP limit of -27dBm/MHz to obtain the limit for out of band spurious emissions.

Note 2: Measure Level (dBμV/m) = Reading Level (dBμV) + Factor (dB)

Factor (dB) = Cable Loss (dB) + Antenna Factor (dB/m) - Pre_Amplifier Gain (dB)

Test Site	SIP-AC1	Test Engineer	Edward Zhang
Test Date	2021/06/04	Test Mode	802.11ac-VHT20 - Ant 0 + 1 (CDD Mode)
Test Channel	64		
Remark:	1. Average measurement was not performed if peak level lower than average limit. 2. Other frequency was 20dB below limit line within 1-18GHz, there is not show in the report.		

Mark	Frequency (MHz)	Reading Level (dB μ V)	Factor (dB)	Measure Level (dB μ V/m)	Limit (dB μ V/m)	Margin (dB)	Detector	Polarization
*	9891.0	50.2	-5.2	45.0	68.2	-23.2	Peak	Horizontal
	12271.0	49.3	-3.6	45.7	74.0	-28.3	Peak	Horizontal
	15773.0	47.0	2.8	49.8	74.0	-24.2	Peak	Horizontal
*	16827.0	46.4	4.3	50.7	68.2	-17.5	Peak	Horizontal
*	9780.5	51.1	-5.5	45.6	68.2	-22.6	Peak	Vertical
	11642.0	49.8	-4.3	45.5	74.0	-28.5	Peak	Vertical
	15747.5	47.7	2.4	50.1	74.0	-23.9	Peak	Vertical
*	17286.0	46.2	4.9	51.1	68.2	-17.1	Peak	Vertical

Note 1: "*" is not in restricted band, its limit is -27dBm/MHz. At a distance of 3 meters, the field strength limit in dB μ V/m can be determined by adding a "conversion" factor of 95.2dB to the EIRP limit of -27dBm/MHz to obtain the limit for out of band spurious emissions.

Note 2: Measure Level (dB μ V/m) = Reading Level (dB μ V) + Factor (dB)

Factor (dB) = Cable Loss (dB) + Antenna Factor (dB/m) - Pre_Amplifier Gain (dB)

Test Site	SIP-AC1	Test Engineer	Edward Zhang
Test Date	2021/06/04	Test Mode	802.11ac-VHT20 - Ant 0 + 1 (CDD Mode)
Test Channel	100		
Remark:	1. Average measurement was not performed if peak level lower than average limit. 2. Other frequency was 20dB below limit line within 1-18GHz, there is not show in the report.		

Mark	Frequency (MHz)	Reading Level (dBμV)	Factor (dB)	Measure Level (dBμV/m)	Limit (dBμV/m)	Margin (dB)	Detector	Polarization
*	9738.0	51.1	-5.5	45.6	68.2	-22.6	Peak	Horizontal
	11633.5	51.2	-4.4	46.8	74.0	-27.2	Peak	Horizontal
	15764.5	47.9	2.7	50.6	74.0	-23.4	Peak	Horizontal
*	17430.5	46.6	5.1	51.7	68.2	-16.5	Peak	Horizontal
*	10171.5	50.6	-5.1	45.5	68.2	-22.7	Peak	Vertical
	11948.0	49.6	-3.9	45.7	74.0	-28.3	Peak	Vertical
	15764.5	47.4	2.7	50.1	74.0	-23.9	Peak	Vertical
*	17439.0	46.3	5.1	51.4	68.2	-16.8	Peak	Vertical

Note 1: "*" is not in restricted band, its limit is -27dBm/MHz. At a distance of 3 meters, the field strength limit in dBμV/m can be determined by adding a "conversion" factor of 95.2dB to the EIRP limit of -27dBm/MHz to obtain the limit for out of band spurious emissions.

Note 2: Measure Level (dBμV/m) = Reading Level (dBμV) + Factor (dB)

Factor (dB) = Cable Loss (dB) + Antenna Factor (dB/m) - Pre_Amplifier Gain (dB)

Test Site	SIP-AC1	Test Engineer	Edward Zhang
Test Date	2021/06/04	Test Mode	802.11ac-VHT20 - Ant 0 + 1 (CDD Mode)
Test Channel	116		
Remark:	1. Average measurement was not performed if peak level lower than average limit. 2. Other frequency was 20dB below limit line within 1-18GHz, there is not show in the report.		

Mark	Frequency (MHz)	Reading Level (dBμV)	Factor (dB)	Measure Level (dBμV/m)	Limit (dBμV/m)	Margin (dB)	Detector	Polarization
*	9865.5	50.7	-5.3	45.4	68.2	-22.8	Peak	Horizontal
	11948.0	49.7	-3.9	45.8	74.0	-28.2	Peak	Horizontal
	15764.5	47.4	2.7	50.1	74.0	-23.9	Peak	Horizontal
*	16818.5	45.8	4.1	49.9	68.2	-18.3	Peak	Horizontal
*	9644.5	50.2	-5.3	44.9	68.2	-23.3	Peak	Vertical
	11166.0	51.1	-5.4	45.7	74.0	-28.3	Peak	Vertical
	15722.0	48.5	1.7	50.2	74.0	-23.8	Peak	Vertical
*	16767.5	47.1	4.1	51.2	68.2	-17.0	Peak	Vertical

Note 1: "*" is not in restricted band, its limit is -27dBm/MHz. At a distance of 3 meters, the field strength limit in dBμV/m can be determined by adding a "conversion" factor of 95.2dB to the EIRP limit of -27dBm/MHz to obtain the limit for out of band spurious emissions.

Note 2: Measure Level (dBμV/m) = Reading Level (dBμV) + Factor (dB)

Factor (dB) = Cable Loss (dB) + Antenna Factor (dB/m) - Pre_Amplifier Gain (dB)

Test Site	SIP-AC1	Test Engineer	Edward Zhang
Test Date	2021/06/04	Test Mode	802.11ac-VHT20 - Ant 0 + 1 (CDD Mode)
Test Channel	140		
Remark:	1. Average measurement was not performed if peak level lower than average limit. 2. Other frequency was 20dB below limit line within 1-18GHz, there is not show in the report.		

Mark	Frequency (MHz)	Reading Level (dB μ V)	Factor (dB)	Measure Level (dB μ V/m)	Limit (dB μ V/m)	Margin (dB)	Detector	Polarization
*	10409.5	50.7	-5.4	45.3	68.2	-22.9	Peak	Horizontal
	11973.5	50.4	-3.9	46.5	74.0	-27.5	Peak	Horizontal
	15756.0	46.4	2.6	49.0	74.0	-25.0	Peak	Horizontal
*	16742.0	46.0	4.2	50.2	68.2	-18.0	Peak	Horizontal
*	10256.5	50.6	-5.4	45.2	68.2	-23.0	Peak	Vertical
	11897.0	50.1	-4.4	45.7	74.0	-28.3	Peak	Vertical
	15696.5	47.5	1.8	49.3	74.0	-24.7	Peak	Vertical
*	17388.0	46.0	5.3	51.3	68.2	-16.9	Peak	Vertical

Note 1: "*" is not in restricted band, its limit is -27dBm/MHz. At a distance of 3 meters, the field strength limit in dB μ V/m can be determined by adding a "conversion" factor of 95.2dB to the EIRP limit of -27dBm/MHz to obtain the limit for out of band spurious emissions.

Note 2: Measure Level (dB μ V/m) = Reading Level (dB μ V) + Factor (dB)

Factor (dB) = Cable Loss (dB) + Antenna Factor (dB/m) - Pre_Amplifier Gain (dB)

Test Site	SIP-AC1	Test Engineer	Edward Zhang
Test Date	2021/06/04	Test Mode	802.11ac-VHT20 - Ant 0 + 1 (CDD Mode)
Test Channel	144		
Remark:	1. Average measurement was not performed if peak level lower than average limit. 2. Other frequency was 20dB below limit line within 1-18GHz, there is not show in the report.		

Mark	Frequency (MHz)	Reading Level (dBμV)	Factor (dB)	Measure Level (dBμV/m)	Limit (dBμV/m)	Margin (dB)	Detector	Polarization
*	9772.0	50.5	-5.5	45.0	68.2	-23.2	Peak	Horizontal
	11880.0	49.3	-4.0	45.3	74.0	-28.7	Peak	Horizontal
	15696.5	48.1	1.8	49.9	74.0	-24.1	Peak	Horizontal
*	17192.5	45.5	4.3	49.8	68.2	-18.4	Peak	Horizontal
*	10171.5	50.6	-5.1	45.5	68.2	-22.7	Peak	Vertical
	12483.5	49.3	-3.8	45.5	74.0	-28.5	Peak	Vertical
	15773.0	46.6	2.8	49.4	74.0	-24.6	Peak	Vertical
*	17396.5	45.7	5.2	50.9	68.2	-17.3	Peak	Vertical

Note 1: "*" is not in restricted band, its limit is -27dBm/MHz. At a distance of 3 meters, the field strength limit in dBμV/m can be determined by adding a "conversion" factor of 95.2dB to the EIRP limit of -27dBm/MHz to obtain the limit for out of band spurious emissions.

Note 2: Measure Level (dBμV/m) = Reading Level (dBμV) + Factor (dB)

Factor (dB) = Cable Loss (dB) + Antenna Factor (dB/m) - Pre_Amplifier Gain (dB)

Test Site	SIP-AC1	Test Engineer	Edward Zhang
Test Date	2021/06/04	Test Mode	802.11ac-VHT20 - Ant 0 + 1 (CDD Mode)
Test Channel	149		
Remark:	1. Average measurement was not performed if peak level lower than average limit. 2. Other frequency was 20dB below limit line within 1-18GHz, there is not show in the report.		

Mark	Frequency (MHz)	Reading Level (dB μ V)	Factor (dB)	Measure Level (dB μ V/m)	Limit (dB μ V/m)	Margin (dB)	Detector	Polarization
*	10010.0	50.5	-5.0	45.5	68.2	-22.7	Peak	Horizontal
	11922.5	49.6	-4.3	45.3	74.0	-28.7	Peak	Horizontal
	15722.0	47.2	1.7	48.9	74.0	-25.1	Peak	Horizontal
*	16784.5	46.6	4.1	50.7	68.2	-17.5	Peak	Horizontal
*	9882.5	50.2	-5.2	45.0	68.2	-23.2	Peak	Vertical
	12381.5	49.3	-3.5	45.8	74.0	-28.2	Peak	Vertical
	15560.5	46.9	1.9	48.8	74.0	-25.2	Peak	Vertical
*	16869.5	47.0	4.2	51.2	68.2	-17.0	Peak	Vertical

Note 1: "*" is not in restricted band, its limit is -27dBm/MHz or -17dBm/MHz. At a distance of 3 meters, the field strength limit in dB μ V/m can be determined by adding a "conversion" factor of 95.2dB to the EIRP limit of -27dBm/MHz to obtain the limit for out of band spurious emissions.

Note 2: Measure Level (dB μ V/m) = Reading Level (dB μ V) + Factor (dB)

Factor (dB) = Cable Loss (dB) + Antenna Factor (dB/m) - Pre_Amplifier Gain (dB)

Test Site	SIP-AC1	Test Engineer	Edward Zhang
Test Date	2021/06/04	Test Mode	802.11ac-VHT20 - Ant 0 + 1 (CDD Mode)
Test Channel	157		
Remark:	1. Average measurement was not performed if peak level lower than average limit. 2. Other frequency was 20dB below limit line within 1-18GHz, there is not show in the report.		

Mark	Frequency (MHz)	Reading Level (dB μ V)	Factor (dB)	Measure Level (dB μ V/m)	Limit (dB μ V/m)	Margin (dB)	Detector	Polarization
*	9976.0	50.5	-5.3	45.2	68.2	-23.0	Peak	Horizontal
	12220.0	49.4	-3.9	45.5	74.0	-28.5	Peak	Horizontal
	15747.5	46.9	2.4	49.3	74.0	-24.7	Peak	Horizontal
*	17490.0	47.2	5.0	52.2	68.2	-16.0	Peak	Horizontal
*	9984.5	50.7	-5.2	45.5	68.2	-22.7	Peak	Vertical
	12237.0	49.4	-3.8	45.6	74.0	-28.4	Peak	Vertical
	15756.0	47.0	2.6	49.6	74.0	-24.4	Peak	Vertical
*	16793.0	47.0	4.0	51.0	68.2	-17.2	Peak	Vertical

Note 1: "*" is not in restricted band, its limit is -27dBm/MHz or -17dBm/MHz. At a distance of 3 meters, the field strength limit in dB μ V/m can be determined by adding a "conversion" factor of 95.2dB to the EIRP limit of -27dBm/MHz to obtain the limit for out of band spurious emissions.

Note 2: Measure Level (dB μ V/m) = Reading Level (dB μ V) + Factor (dB)

Factor (dB) = Cable Loss (dB) + Antenna Factor (dB/m) - Pre_Amplifier Gain (dB)

Test Site	SIP-AC1	Test Engineer	Edward Zhang
Test Date	2021/06/04	Test Mode	802.11ac-VHT20 - Ant 0 + 1 (CDD Mode)
Test Channel	165		
Remark:	1. Average measurement was not performed if peak level lower than average limit. 2. Other frequency was 20dB below limit line within 1-18GHz, there is not show in the report.		

Mark	Frequency (MHz)	Reading Level (dB μ V)	Factor (dB)	Measure Level (dB μ V/m)	Limit (dB μ V/m)	Margin (dB)	Detector	Polarization
*	9916.5	50.6	-5.2	45.4	68.2	-22.8	Peak	Horizontal
	12126.5	49.7	-4.0	45.7	74.0	-28.3	Peak	Horizontal
	15747.5	47.6	2.4	50.0	74.0	-24.0	Peak	Horizontal
*	17447.5	46.3	5.0	51.3	68.2	-16.9	Peak	Horizontal
*	10188.5	50.4	-5.2	45.2	68.2	-23.0	Peak	Vertical
	12050.0	50.1	-4.0	46.1	74.0	-27.9	Peak	Vertical
*	16699.5	45.4	3.9	49.3	68.2	-18.9	Peak	Vertical
	17915.0	47.5	5.9	53.4	74.0	-20.6	Peak	Vertical

Note 1: "*" is not in restricted band, its limit is -27dBm/MHz or -17dBm/MHz. At a distance of 3 meters, the field strength limit in dB μ V/m can be determined by adding a "conversion" factor of 95.2dB to the EIRP limit of -27dBm/MHz to obtain the limit for out of band spurious emissions.

Note 2: Measure Level (dB μ V/m) = Reading Level (dB μ V) + Factor (dB)

Factor (dB) = Cable Loss (dB) + Antenna Factor (dB/m) - Pre_Amplifier Gain (dB)

Test Site	SIP-AC1	Test Engineer	Edward Zhang
Test Date	2021/06/04	Test Mode	802.11ac-VHT40 - Ant 0 + 1 (CDD Mode)
Test Channel	38		
Remark:	1. Average measurement was not performed if peak level lower than average limit. 2. Other frequency was 20dB below limit line within 1-18GHz, there is not show in the report.		

Mark	Frequency (MHz)	Reading Level (dBμV)	Factor (dB)	Measure Level (dBμV/m)	Limit (dBμV/m)	Margin (dB)	Detector	Polarization
*	10163.0	50.0	-5.1	44.9	68.2	-23.3	Peak	Horizontal
	12636.5	49.6	-3.6	46.0	74.0	-28.0	Peak	Horizontal
	15739.0	47.8	2.2	50.0	74.0	-24.0	Peak	Horizontal
*	16844.0	46.1	4.2	50.3	68.2	-17.9	Peak	Horizontal
*	9891.0	50.3	-5.2	45.1	68.2	-23.1	Peak	Vertical
	11880.0	49.6	-4.0	45.6	74.0	-28.4	Peak	Vertical
	15458.5	47.4	1.9	49.3	74.0	-24.7	Peak	Vertical
*	17184.0	46.8	4.3	51.1	68.2	-17.1	Peak	Vertical

Note 1: "*" is not in restricted band, its limit is -27dBm/MHz. At a distance of 3 meters, the field strength limit in dBμV/m can be determined by adding a "conversion" factor of 95.2dB to the EIRP limit of -27dBm/MHz to obtain the limit for out of band spurious emissions.

Note 2: Measure Level (dBμV/m) = Reading Level (dBμV) + Factor (dB)

Factor (dB) = Cable Loss (dB) + Antenna Factor (dB/m) - Pre_Amplifier Gain (dB)

Test Site	SIP-AC1	Test Engineer	Edward Zhang
Test Date	2021/06/04	Test Mode	802.11ac-VHT40 - Ant 0 + 1 (CDD Mode)
Test Channel	46		
Remark:	1. Average measurement was not performed if peak level lower than average limit. 2. Other frequency was 20dB below limit line within 1-18GHz, there is not show in the report.		

Mark	Frequency (MHz)	Reading Level (dBμV)	Factor (dB)	Measure Level (dBμV/m)	Limit (dBμV/m)	Margin (dB)	Detector	Polarization
*	10120.5	50.1	-5.2	44.9	68.2	-23.3	Peak	Horizontal
	12305.0	50.1	-3.7	46.4	74.0	-27.6	Peak	Horizontal
	15594.5	47.5	1.6	49.1	74.0	-24.9	Peak	Horizontal
*	16733.5	46.0	4.2	50.2	68.2	-18.0	Peak	Horizontal
*	9772.0	49.3	-5.5	43.8	68.2	-24.4	Peak	Vertical
	11948.0	49.0	-3.9	45.1	74.0	-28.9	Peak	Vertical
	15841.0	46.3	2.7	49.0	74.0	-25.0	Peak	Vertical
*	17626.0	46.9	4.9	51.8	68.2	-16.4	Peak	Vertical

Note 1: "*" is not in restricted band, its limit is -27dBm/MHz. At a distance of 3 meters, the field strength limit in dBμV/m can be determined by adding a "conversion" factor of 95.2dB to the EIRP limit of -27dBm/MHz to obtain the limit for out of band spurious emissions.

Note 2: Measure Level (dBμV/m) = Reading Level (dBμV) + Factor (dB)

Factor (dB) = Cable Loss (dB) + Antenna Factor (dB/m) - Pre_Amplifier Gain (dB)

Test Site	SIP-AC1	Test Engineer	Edward Zhang
Test Date	2021/06/04	Test Mode	802.11ac-VHT40 - Ant 0 + 1 (CDD Mode)
Test Channel	54		
Remark:	1. Average measurement was not performed if peak level lower than average limit. 2. Other frequency was 20dB below limit line within 1-18GHz, there is not show in the report.		

Mark	Frequency (MHz)	Reading Level (dBμV)	Factor (dB)	Measure Level (dBμV/m)	Limit (dBμV/m)	Margin (dB)	Detector	Polarization
*	9789.0	50.6	-5.6	45.0	68.2	-23.2	Peak	Horizontal
	11973.5	49.7	-3.9	45.8	74.0	-28.2	Peak	Horizontal
	15654.0	47.7	1.5	49.2	74.0	-24.8	Peak	Horizontal
*	17396.5	47.1	5.2	52.3	68.2	-15.9	Peak	Horizontal
*	10180.0	50.8	-5.1	45.7	68.2	-22.5	Peak	Vertical
	11871.5	50.4	-4.1	46.3	74.0	-27.7	Peak	Vertical
	15722.0	47.8	1.7	49.5	74.0	-24.5	Peak	Vertical
*	16835.5	46.4	4.3	50.7	68.2	-17.5	Peak	Vertical

Note 1: "*" is not in restricted band, its limit is -27dBm/MHz. At a distance of 3 meters, the field strength limit in dBμV/m can be determined by adding a "conversion" factor of 95.2dB to the EIRP limit of -27dBm/MHz to obtain the limit for out of band spurious emissions.

Note 2: Measure Level (dBμV/m) = Reading Level (dBμV) + Factor (dB)

Factor (dB) = Cable Loss (dB) + Antenna Factor (dB/m) - Pre_Amplifier Gain (dB)

Test Site	SIP-AC1	Test Engineer	Edward Zhang
Test Date	2021/06/04	Test Mode	802.11ac-VHT40 - Ant 0 + 1 (CDD Mode)
Test Channel	62		
Remark:	1. Average measurement was not performed if peak level lower than average limit. 2. Other frequency was 20dB below limit line within 1-18GHz, there is not show in the report.		

Mark	Frequency (MHz)	Reading Level (dBμV)	Factor (dB)	Measure Level (dBμV/m)	Limit (dBμV/m)	Margin (dB)	Detector	Polarization
*	9636.0	50.5	-5.4	45.1	68.2	-23.1	Peak	Horizontal
	12594.0	49.8	-3.7	46.1	74.0	-27.9	Peak	Horizontal
	15611.5	47.4	1.6	49.0	74.0	-25.0	Peak	Horizontal
*	16759.0	46.3	4.1	50.4	68.2	-17.8	Peak	Horizontal
*	10180.0	50.0	-5.1	44.9	68.2	-23.3	Peak	Vertical
	11463.5	50.0	-4.6	45.4	74.0	-28.6	Peak	Vertical
	15696.5	47.6	1.8	49.4	74.0	-24.6	Peak	Vertical
*	16725.0	45.9	4.3	50.2	68.2	-18.0	Peak	Vertical

Note 1: "*" is not in restricted band, its limit is -27dBm/MHz. At a distance of 3 meters, the field strength limit in dBμV/m can be determined by adding a "conversion" factor of 95.2dB to the EIRP limit of -27dBm/MHz to obtain the limit for out of band spurious emissions.

Note 2: Measure Level (dBμV/m) = Reading Level (dBμV) + Factor (dB)

Factor (dB) = Cable Loss (dB) + Antenna Factor (dB/m) - Pre_Amplifier Gain (dB)

Test Site	SIP-AC1	Test Engineer	Edward Zhang
Test Date	2021/06/04	Test Mode	802.11ac-VHT40 - Ant 0 + 1 (CDD Mode)
Test Channel	102		
Remark:	1. Average measurement was not performed if peak level lower than average limit. 2. Other frequency was 20dB below limit line within 1-18GHz, there is not show in the report.		

Mark	Frequency (MHz)	Reading Level (dB μ V)	Factor (dB)	Measure Level (dB μ V/m)	Limit (dB μ V/m)	Margin (dB)	Detector	Polarization
*	9950.5	50.4	-5.1	45.3	68.2	-22.9	Peak	Horizontal
	11990.5	49.8	-4.0	45.8	74.0	-28.2	Peak	Horizontal
	15526.5	47.3	1.7	49.0	74.0	-25.0	Peak	Horizontal
*	16929.0	47.1	4.0	51.1	68.2	-17.1	Peak	Horizontal
*	9984.5	51.2	-5.2	46.0	68.2	-22.2	Peak	Vertical
	12160.5	49.6	-3.8	45.8	74.0	-28.2	Peak	Vertical
	15773.0	46.3	2.8	49.1	74.0	-24.9	Peak	Vertical
*	17388.0	45.8	5.3	51.1	68.2	-17.1	Peak	Vertical

Note 1: "*" is not in restricted band, its limit is -27dBm/MHz. At a distance of 3 meters, the field strength limit in dB μ V/m can be determined by adding a "conversion" factor of 95.2dB to the EIRP limit of -27dBm/MHz to obtain the limit for out of band spurious emissions.

Note 2: Measure Level (dB μ V/m) = Reading Level (dB μ V) + Factor (dB)

Factor (dB) = Cable Loss (dB) + Antenna Factor (dB/m) - Pre_Amplifier Gain (dB)

Test Site	SIP-AC1	Test Engineer	Edward Zhang
Test Date	2021/06/04	Test Mode	802.11ac-VHT40 - Ant 0 + 1 (CDD Mode)
Test Channel	110		
Remark:	1. Average measurement was not performed if peak level lower than average limit. 2. Other frequency was 20dB below limit line within 1-18GHz, there is not show in the report.		

Mark	Frequency (MHz)	Reading Level (dBμV)	Factor (dB)	Measure Level (dBμV/m)	Limit (dBμV/m)	Margin (dB)	Detector	Polarization
*	9993.0	50.3	-5.1	45.2	68.2	-23.0	Peak	Horizontal
	12254.0	49.2	-3.7	45.5	74.0	-28.5	Peak	Horizontal
	15764.5	47.1	2.7	49.8	74.0	-24.2	Peak	Horizontal
*	16852.5	46.8	4.2	51.0	68.2	-17.2	Peak	Horizontal
*	10001.5	50.6	-5.1	45.5	68.2	-22.7	Peak	Vertical
	12245.5	50.9	-3.8	47.1	74.0	-26.9	Peak	Vertical
	15773.0	46.8	2.8	49.6	74.0	-24.4	Peak	Vertical
*	17371.0	46.7	5.2	51.9	68.2	-16.3	Peak	Vertical

Note 1: "*" is not in restricted band, its limit is -27dBm/MHz. At a distance of 3 meters, the field strength limit in dBμV/m can be determined by adding a "conversion" factor of 95.2dB to the EIRP limit of -27dBm/MHz to obtain the limit for out of band spurious emissions.

Note 2: Measure Level (dBμV/m) = Reading Level (dBμV) + Factor (dB)

Factor (dB) = Cable Loss (dB) + Antenna Factor (dB/m) - Pre_Amplifier Gain (dB)

Test Site	SIP-AC1	Test Engineer	Edward Zhang
Test Date	2021/06/04	Test Mode	802.11ac-VHT40 - Ant 0 + 1 (CDD Mode)
Test Channel	134		
Remark:	1. Average measurement was not performed if peak level lower than average limit. 2. Other frequency was 20dB below limit line within 1-18GHz, there is not show in the report.		

Mark	Frequency (MHz)	Reading Level (dB μ V)	Factor (dB)	Measure Level (dB μ V/m)	Limit (dB μ V/m)	Margin (dB)	Detector	Polarization
*	9619.0	50.7	-5.2	45.5	68.2	-22.7	Peak	Horizontal
	11846.0	50.2	-4.4	45.8	74.0	-28.2	Peak	Horizontal
	15671.0	47.5	2.1	49.6	74.0	-24.4	Peak	Horizontal
*	16827.0	47.2	4.3	51.5	68.2	-16.7	Peak	Horizontal
*	9950.5	50.6	-5.1	45.5	68.2	-22.7	Peak	Vertical
	12339.0	49.9	-3.8	46.1	74.0	-27.9	Peak	Vertical
	15739.0	47.3	2.2	49.5	74.0	-24.5	Peak	Vertical
*	17422.0	46.9	5.0	51.9	68.2	-16.3	Peak	Vertical

Note 1: "*" is not in restricted band, its limit is -27dBm/MHz. At a distance of 3 meters, the field strength limit in dB μ V/m can be determined by adding a "conversion" factor of 95.2dB to the EIRP limit of -27dBm/MHz to obtain the limit for out of band spurious emissions.

Note 2: Measure Level (dB μ V/m) = Reading Level (dB μ V) + Factor (dB)

Factor (dB) = Cable Loss (dB) + Antenna Factor (dB/m) - Pre_Amplifier Gain (dB)

Test Site	SIP-AC1	Test Engineer	Edward Zhang
Test Date	2021/06/04	Test Mode	802.11ac-VHT40 - Ant 0 + 1 (CDD Mode)
Test Channel	142		
Remark:	1. Average measurement was not performed if peak level lower than average limit. 2. Other frequency was 20dB below limit line within 1-18GHz, there is not show in the report.		

Mark	Frequency (MHz)	Reading Level (dB μ V)	Factor (dB)	Measure Level (dB μ V/m)	Limit (dB μ V/m)	Margin (dB)	Detector	Polarization
*	9959.0	51.4	-5.1	46.3	68.2	-21.9	Peak	Horizontal
	12415.5	49.7	-3.8	45.9	74.0	-28.1	Peak	Horizontal
	15747.5	47.1	2.4	49.5	74.0	-24.5	Peak	Horizontal
*	17286.0	46.4	4.9	51.3	68.2	-16.9	Peak	Horizontal
*	9984.5	50.4	-5.2	45.2	68.2	-23.0	Peak	Vertical
	11982.0	49.4	-3.9	45.5	74.0	-28.5	Peak	Vertical
	15730.5	48.3	1.9	50.2	74.0	-23.8	Peak	Vertical
*	17447.5	46.3	5.0	51.3	68.2	-16.9	Peak	Vertical

Note 1: "*" is not in restricted band, its limit is -27dBm/MHz. At a distance of 3 meters, the field strength limit in dB μ V/m can be determined by adding a "conversion" factor of 95.2dB to the EIRP limit of -27dBm/MHz to obtain the limit for out of band spurious emissions.

Note 2: Measure Level (dB μ V/m) = Reading Level (dB μ V) + Factor (dB)

Factor (dB) = Cable Loss (dB) + Antenna Factor (dB/m) - Pre_Amplifier Gain (dB)

Test Site	SIP-AC1	Test Engineer	Edward Zhang
Test Date	2021/06/04	Test Mode	802.11ac-VHT40 - Ant 0 + 1 (CDD Mode)
Test Channel	151		
Remark:	1. Average measurement was not performed if peak level lower than average limit. 2. Other frequency was 20dB below limit line within 1-18GHz, there is not show in the report.		

Mark	Frequency (MHz)	Reading Level (dB μ V)	Factor (dB)	Measure Level (dB μ V/m)	Limit (dB μ V/m)	Margin (dB)	Detector	Polarization
*	9959.0	50.3	-5.1	45.2	68.2	-23.0	Peak	Horizontal
	12058.5	49.6	-3.9	45.7	74.0	-28.3	Peak	Horizontal
	15756.0	46.8	2.6	49.4	74.0	-24.6	Peak	Horizontal
*	16852.5	46.4	4.2	50.6	68.2	-17.6	Peak	Horizontal
*	10018.5	51.1	-5.1	46.0	68.2	-22.2	Peak	Vertical
	11395.5	51.4	-5.0	46.4	74.0	-27.6	Peak	Vertical
	15696.5	47.1	1.8	48.9	74.0	-25.1	Peak	Vertical
*	16869.5	45.8	4.2	50.0	68.2	-18.2	Peak	Vertical

Note 1: "*" is not in restricted band, its limit is -27dBm/MHz or -17dBm/MHz. At a distance of 3 meters, the field strength limit in dB μ V/m can be determined by adding a "conversion" factor of 95.2dB to the EIRP limit of -27dBm/MHz to obtain the limit for out of band spurious emissions.

Note 2: Measure Level (dB μ V/m) = Reading Level (dB μ V) + Factor (dB)

Factor (dB) = Cable Loss (dB) + Antenna Factor (dB/m) - Pre_Amplifier Gain (dB)

Test Site	SIP-AC1	Test Engineer	Edward Zhang
Test Date	2021/06/04	Test Mode	802.11ac-VHT40 - Ant 0 + 1 (CDD Mode)
Test Channel	159		
Remark:	1. Average measurement was not performed if peak level lower than average limit. 2. Other frequency was 20dB below limit line within 1-18GHz, there is not show in the report.		

Mark	Frequency (MHz)	Reading Level (dB μ V)	Factor (dB)	Measure Level (dB μ V/m)	Limit (dB μ V/m)	Margin (dB)	Detector	Polarization
*	9704.0	51.0	-5.2	45.8	68.2	-22.4	Peak	Horizontal
	12373.0	49.4	-3.5	45.9	74.0	-28.1	Peak	Horizontal
	15773.0	46.4	2.8	49.2	74.0	-24.8	Peak	Horizontal
*	17226.5	45.8	4.4	50.2	68.2	-18.0	Peak	Horizontal
*	9831.5	51.0	-5.4	45.6	68.2	-22.6	Peak	Vertical
	12458.0	49.5	-3.6	45.9	74.0	-28.1	Peak	Vertical
	15713.5	47.6	1.7	49.3	74.0	-24.7	Peak	Vertical
*	16793.0	46.1	4.0	50.1	68.2	-18.1	Peak	Vertical

Note 1: "*" is not in restricted band, its limit is -27dBm/MHz or -17dBm/MHz. At a distance of 3 meters, the field strength limit in dB μ V/m can be determined by adding a "conversion" factor of 95.2dB to the EIRP limit of -27dBm/MHz to obtain the limit for out of band spurious emissions.

Note 2: Measure Level (dB μ V/m) = Reading Level (dB μ V) + Factor (dB)

Factor (dB) = Cable Loss (dB) + Antenna Factor (dB/m) - Pre_Amplifier Gain (dB)

Test Site	SIP-AC1	Test Engineer	Edward Zhang
Test Date	2021/06/04	Test Mode	802.11ac-VHT80 - Ant 0 + 1 (CDD Mode)
Test Channel	42		
Remark:	1. Average measurement was not performed if peak level lower than average limit. 2. Other frequency was 20dB below limit line within 1-18GHz, there is not show in the report.		

Mark	Frequency (MHz)	Reading Level (dB μ V)	Factor (dB)	Measure Level (dB μ V/m)	Limit (dB μ V/m)	Margin (dB)	Detector	Polarization
*	10163.0	50.8	-5.1	45.7	68.2	-22.5	Peak	Horizontal
	11608.0	50.2	-4.7	45.5	74.0	-28.5	Peak	Horizontal
	15747.5	47.6	2.4	50.0	74.0	-24.0	Peak	Horizontal
*	16861.0	47.1	4.2	51.3	68.2	-16.9	Peak	Horizontal
*	10171.5	50.4	-5.1	45.3	68.2	-22.9	Peak	Vertical
	11965.0	50.0	-3.9	46.1	74.0	-27.9	Peak	Vertical
	15764.5	46.8	2.7	49.5	74.0	-24.5	Peak	Vertical
*	16835.5	46.5	4.3	50.8	68.2	-17.4	Peak	Vertical

Note 1: "*" is not in restricted band, its limit is -27dBm/MHz. At a distance of 3 meters, the field strength limit in dB μ V/m can be determined by adding a "conversion" factor of 95.2dB to the EIRP limit of -27dBm/MHz to obtain the limit for out of band spurious emissions.

Note 2: Measure Level (dB μ V/m) = Reading Level (dB μ V) + Factor (dB)

Factor (dB) = Cable Loss (dB) + Antenna Factor (dB/m) - Pre_Amplifier Gain (dB)

Test Site	SIP-AC1	Test Engineer	Edward Zhang
Test Date	2021/06/04	Test Mode	802.11ac-VHT80 - Ant 0 + 1 (CDD Mode)
Test Channel	58		
Remark:	1. Average measurement was not performed if peak level lower than average limit. 2. Other frequency was 20dB below limit line within 1-18GHz, there is not show in the report.		

Mark	Frequency (MHz)	Reading Level (dBμV)	Factor (dB)	Measure Level (dBμV/m)	Limit (dBμV/m)	Margin (dB)	Detector	Polarization
*	9984.5	50.5	-5.2	45.3	68.2	-22.9	Peak	Horizontal
	11676.0	51.0	-4.5	46.5	74.0	-27.5	Peak	Horizontal
	15773.0	46.4	2.8	49.2	74.0	-24.8	Peak	Horizontal
*	16852.5	46.4	4.2	50.6	68.2	-17.6	Peak	Horizontal
*	10052.5	51.1	-5.1	46.0	68.2	-22.2	Peak	Vertical
	12279.5	49.7	-3.6	46.1	74.0	-27.9	Peak	Vertical
	15747.5	47.6	2.4	50.0	74.0	-24.0	Peak	Vertical
*	17439.0	46.6	5.1	51.7	68.2	-16.5	Peak	Vertical

Note 1: "*" is not in restricted band, its limit is -27dBm/MHz. At a distance of 3 meters, the field strength limit in dBμV/m can be determined by adding a "conversion" factor of 95.2dB to the EIRP limit of -27dBm/MHz to obtain the limit for out of band spurious emissions.

Note 2: Measure Level (dBμV/m) = Reading Level (dBμV) + Factor (dB)

Factor (dB) = Cable Loss (dB) + Antenna Factor (dB/m) - Pre_Amplifier Gain (dB)

Test Site	SIP-AC1	Test Engineer	Edward Zhang
Test Date	2021/06/04	Test Mode	802.11ac-VHT80 - Ant 0 + 1 (CDD Mode)
Test Channel	106		
Remark:	1. Average measurement was not performed if peak level lower than average limit. 2. Other frequency was 20dB below limit line within 1-18GHz, there is not show in the report.		

Mark	Frequency (MHz)	Reading Level (dBμV)	Factor (dB)	Measure Level (dBμV/m)	Limit (dBμV/m)	Margin (dB)	Detector	Polarization
*	9772.0	51.0	-5.5	45.5	68.2	-22.7	Peak	Horizontal
	12152.0	49.3	-3.8	45.5	74.0	-28.5	Peak	Horizontal
	15841.0	46.6	2.7	49.3	74.0	-24.7	Peak	Horizontal
*	17362.5	46.2	4.9	51.1	68.2	-17.1	Peak	Horizontal
*	9984.5	50.5	-5.2	45.3	68.2	-22.9	Peak	Vertical
	11948.0	49.1	-3.9	45.2	74.0	-28.8	Peak	Vertical
	15679.5	47.2	1.9	49.1	74.0	-24.9	Peak	Vertical
*	16835.5	46.3	4.3	50.6	68.2	-17.6	Peak	Vertical

Note 1: "*" is not in restricted band, its limit is -27dBm/MHz. At a distance of 3 meters, the field strength limit in dBμV/m can be determined by adding a "conversion" factor of 95.2dB to the EIRP limit of -27dBm/MHz to obtain the limit for out of band spurious emissions.

Note 2: Measure Level (dBμV/m) = Reading Level (dBμV) + Factor (dB)

Factor (dB) = Cable Loss (dB) + Antenna Factor (dB/m) - Pre_Amplifier Gain (dB)

Test Site	SIP-AC1	Test Engineer	Edward Zhang
Test Date	2021/06/04	Test Mode	802.11ac-VHT80 - Ant 0 + 1 (CDD Mode)
Test Channel	122		
Remark:	1. Average measurement was not performed if peak level lower than average limit. 2. Other frequency was 20dB below limit line within 1-18GHz, there is not show in the report.		

Mark	Frequency (MHz)	Reading Level (dBμV)	Factor (dB)	Measure Level (dBμV/m)	Limit (dBμV/m)	Margin (dB)	Detector	Polarization
*	9712.5	50.5	-5.3	45.2	68.2	-23.0	Peak	Horizontal
	11973.5	49.8	-3.9	45.9	74.0	-28.1	Peak	Horizontal
	15713.5	47.6	1.7	49.3	74.0	-24.7	Peak	Horizontal
*	16844.0	46.4	4.2	50.6	68.2	-17.6	Peak	Horizontal
*	10154.5	50.7	-5.3	45.4	68.2	-22.8	Peak	Vertical
	11948.0	49.9	-3.9	46.0	74.0	-28.0	Peak	Vertical
	15747.5	46.9	2.4	49.3	74.0	-24.7	Peak	Vertical
*	16835.5	46.7	4.3	51.0	68.2	-17.2	Peak	Vertical

Note 1: "*" is not in restricted band, its limit is -27dBm/MHz. At a distance of 3 meters, the field strength limit in dBμV/m can be determined by adding a "conversion" factor of 95.2dB to the EIRP limit of -27dBm/MHz to obtain the limit for out of band spurious emissions.

Note 2: Measure Level (dBμV/m) = Reading Level (dBμV) + Factor (dB)

Factor (dB) = Cable Loss (dB) + Antenna Factor (dB/m) - Pre_Amplifier Gain (dB)

Test Site	SIP-AC1	Test Engineer	Edward Zhang
Test Date	2021/06/04	Test Mode	802.11ac-VHT80 - Ant 0 + 1 (CDD Mode)
Test Channel	138		
Remark:	1. Average measurement was not performed if peak level lower than average limit. 2. Other frequency was 20dB below limit line within 1-18GHz, there is not show in the report.		

Mark	Frequency (MHz)	Reading Level (dB μ V)	Factor (dB)	Measure Level (dB μ V/m)	Limit (dB μ V/m)	Margin (dB)	Detector	Polarization
*	10171.5	50.9	-5.1	45.8	68.2	-22.4	Peak	Horizontal
	12500.5	49.8	-3.9	45.9	74.0	-28.1	Peak	Horizontal
	15781.5	46.9	2.5	49.4	74.0	-24.6	Peak	Horizontal
*	17439.0	46.1	5.1	51.2	68.2	-17.0	Peak	Horizontal
*	10418.0	52.2	-5.4	46.8	68.2	-21.4	Peak	Vertical
	11965.0	49.7	-3.9	45.8	74.0	-28.2	Peak	Vertical
	15739.0	47.9	2.2	50.1	74.0	-23.9	Peak	Vertical
*	17447.5	46.8	5.0	51.8	68.2	-16.4	Peak	Vertical

Note 1: "*" is not in restricted band, its limit is -27dBm/MHz. At a distance of 3 meters, the field strength limit in dB μ V/m can be determined by adding a "conversion" factor of 95.2dB to the EIRP limit of -27dBm/MHz to obtain the limit for out of band spurious emissions.

Note 2: Measure Level (dB μ V/m) = Reading Level (dB μ V) + Factor (dB)

Factor (dB) = Cable Loss (dB) + Antenna Factor (dB/m) - Pre_Amplifier Gain (dB)

Test Site	SIP-AC1	Test Engineer	Edward Zhang
Test Date	2021/06/04	Test Mode	802.11ac-VHT80 - Ant 0 + 1 (CDD Mode)
Test Channel	155		
Remark:	1. Average measurement was not performed if peak level lower than average limit. 2. Other frequency was 20dB below limit line within 1-18GHz, there is not show in the report.		

Mark	Frequency (MHz)	Reading Level (dBμV)	Factor (dB)	Measure Level (dBμV/m)	Limit (dBμV/m)	Margin (dB)	Detector	Polarization
*	10061.0	50.4	-5.1	45.3	68.2	-22.9	Peak	Horizontal
	12092.5	51.0	-4.0	47.0	74.0	-27.0	Peak	Horizontal
	15858.0	47.6	2.7	50.3	74.0	-23.7	Peak	Horizontal
*	16878.0	46.3	4.1	50.4	68.2	-17.8	Peak	Horizontal
*	10061.0	50.7	-5.1	45.6	68.2	-22.6	Peak	Vertical
	11880.0	49.8	-4.0	45.8	74.0	-28.2	Peak	Vertical
	15518.0	47.4	1.6	49.0	74.0	-25.0	Peak	Vertical
*	16835.5	46.6	4.3	50.9	68.2	-17.3	Peak	Vertical

Note 1: "*" is not in restricted band, its limit is -27dBm/MHz or -17dBm/MHz. At a distance of 3 meters, the field strength limit in dBμV/m can be determined by adding a "conversion" factor of 95.2dB to the EIRP limit of -27dBm/MHz to obtain the limit for out of band spurious emissions.

Note 2: Measure Level (dBμV/m) = Reading Level (dBμV) + Factor (dB)

Factor (dB) = Cable Loss (dB) + Antenna Factor (dB/m) - Pre_Amplifier Gain (dB)

Test Site	SIP-AC1	Test Engineer	Edward Zhang
Test Date	2021/06/04	Test Mode	802.11ax-HE20 - Ant 0 + 1 (CDD Mode)
Test Channel	36		
Remark:	1. Average measurement was not performed if peak level lower than average limit. 2. Other frequency was 20dB below limit line within 1-18GHz, there is not show in the report.		

Mark	Frequency (MHz)	Reading Level (dB μ V)	Factor (dB)	Measure Level (dB μ V/m)	Limit (dB μ V/m)	Margin (dB)	Detector	Polarization
*	10171.5	50.4	-5.1	45.3	68.2	-22.9	Peak	Horizontal
	12143.5	49.4	-3.9	45.5	74.0	-28.5	Peak	Horizontal
	15781.5	46.8	2.5	49.3	74.0	-24.7	Peak	Horizontal
*	16827.0	46.5	4.3	50.8	68.2	-17.4	Peak	Horizontal
*	10171.5	50.3	-5.1	45.2	68.2	-23.0	Peak	Vertical
	12381.5	49.3	-3.5	45.8	74.0	-28.2	Peak	Vertical
	15662.5	46.9	1.8	48.7	74.0	-25.3	Peak	Vertical
*	17413.5	46.8	5.0	51.8	68.2	-16.4	Peak	Vertical

Note 1: "*" is not in restricted band, its limit is -27dBm/MHz. At a distance of 3 meters, the field strength limit in dB μ V/m can be determined by adding a "conversion" factor of 95.2dB to the EIRP limit of -27dBm/MHz to obtain the limit for out of band spurious emissions.

Note 2: Measure Level (dB μ V/m) = Reading Level (dB μ V) + Factor (dB)

Factor (dB) = Cable Loss (dB) + Antenna Factor (dB/m) - Pre_Amplifier Gain (dB)

Test Site	SIP-AC1	Test Engineer	Edward Zhang
Test Date	2021/06/04	Test Mode	802.11ax-HE20 - Ant 0 + 1 (CDD Mode)
Test Channel	44		
Remark:	1. Average measurement was not performed if peak level lower than average limit. 2. Other frequency was 20dB below limit line within 1-18GHz, there is not show in the report.		

Mark	Frequency (MHz)	Reading Level (dB μ V)	Factor (dB)	Measure Level (dB μ V/m)	Limit (dB μ V/m)	Margin (dB)	Detector	Polarization
*	9661.5	52.3	-5.3	47.0	68.2	-21.2	Peak	Horizontal
	12058.5	49.7	-3.9	45.8	74.0	-28.2	Peak	Horizontal
	15662.5	50.4	1.8	52.2	74.0	-21.8	Peak	Horizontal
*	17430.5	46.8	5.1	51.9	68.2	-16.3	Peak	Horizontal
*	9916.5	50.1	-5.2	44.9	68.2	-23.3	Peak	Vertical
	12339.0	49.0	-3.8	45.2	74.0	-28.8	Peak	Vertical
	15764.5	47.4	2.7	50.1	74.0	-23.9	Peak	Vertical
*	17303.0	46.4	4.9	51.3	68.2	-16.9	Peak	Vertical

Note 1: "*" is not in restricted band, its limit is -27dBm/MHz. At a distance of 3 meters, the field strength limit in dB μ V/m can be determined by adding a "conversion" factor of 95.2dB to the EIRP limit of -27dBm/MHz to obtain the limit for out of band spurious emissions.

Note 2: Measure Level (dB μ V/m) = Reading Level (dB μ V) + Factor (dB)

Factor (dB) = Cable Loss (dB) + Antenna Factor (dB/m) - Pre_Amplifier Gain (dB)

Test Site	SIP-AC1	Test Engineer	Edward Zhang
Test Date	2021/06/04	Test Mode	802.11ax-HE20 - Ant 0 + 1 (CDD Mode)
Test Channel	48		
Remark:	1. Average measurement was not performed if peak level lower than average limit. 2. Other frequency was 20dB below limit line within 1-18GHz, there is not show in the report.		

Mark	Frequency (MHz)	Reading Level (dBμV)	Factor (dB)	Measure Level (dBμV/m)	Limit (dBμV/m)	Margin (dB)	Detector	Polarization
*	9653.0	51.1	-5.2	45.9	68.2	-22.3	Peak	Horizontal
	11965.0	50.2	-3.9	46.3	74.0	-27.7	Peak	Horizontal
	15730.5	49.2	1.9	51.1	74.0	-22.9	Peak	Horizontal
*	16818.5	46.5	4.1	50.6	68.2	-17.6	Peak	Horizontal
*	10163.0	50.7	-5.1	45.6	68.2	-22.6	Peak	Vertical
	12203.0	49.9	-3.9	46.0	74.0	-28.0	Peak	Vertical
	15696.5	47.5	1.8	49.3	74.0	-24.7	Peak	Vertical
*	17668.5	47.4	5.1	52.5	68.2	-15.7	Peak	Vertical

Note 1: "*" is not in restricted band, its limit is -27dBm/MHz. At a distance of 3 meters, the field strength limit in dBμV/m can be determined by adding a "conversion" factor of 95.2dB to the EIRP limit of -27dBm/MHz to obtain the limit for out of band spurious emissions.

Note 2: Measure Level (dBμV/m) = Reading Level (dBμV) + Factor (dB)

Factor (dB) = Cable Loss (dB) + Antenna Factor (dB/m) - Pre_Amplifier Gain (dB)

Test Site	SIP-AC1	Test Engineer	Edward Zhang
Test Date	2021/06/04	Test Mode	802.11ax-HE20 - Ant 0 + 1 (CDD Mode)
Test Channel	52		
Remark:	1. Average measurement was not performed if peak level lower than average limit. 2. Other frequency was 20dB below limit line within 1-18GHz, there is not show in the report.		

Mark	Frequency (MHz)	Reading Level (dBμV)	Factor (dB)	Measure Level (dBμV/m)	Limit (dBμV/m)	Margin (dB)	Detector	Polarization
*	9993.0	50.3	-5.1	45.2	68.2	-23.0	Peak	Horizontal
	11701.5	50.6	-4.6	46.0	74.0	-28.0	Peak	Horizontal
	15773.0	48.0	2.8	50.8	74.0	-23.2	Peak	Horizontal
*	16810.0	46.4	3.8	50.2	68.2	-18.0	Peak	Horizontal
*	10401.0	51.5	-5.4	46.1	68.2	-22.1	Peak	Vertical
	11956.5	50.3	-3.9	46.4	74.0	-27.6	Peak	Vertical
	15679.5	47.9	1.9	49.8	74.0	-24.2	Peak	Vertical
*	17099.0	46.8	4.0	50.8	68.2	-17.4	Peak	Vertical

Note 1: "*" is not in restricted band, its limit is -27dBm/MHz. At a distance of 3 meters, the field strength limit in dBμV/m can be determined by adding a "conversion" factor of 95.2dB to the EIRP limit of -27dBm/MHz to obtain the limit for out of band spurious emissions.

Note 2: Measure Level (dBμV/m) = Reading Level (dBμV) + Factor (dB)

Factor (dB) = Cable Loss (dB) + Antenna Factor (dB/m) - Pre_Amplifier Gain (dB)

Test Site	SIP-AC1	Test Engineer	Edward Zhang
Test Date	2021/06/04	Test Mode	802.11ax-HE20 - Ant 0 + 1 (CDD Mode)
Test Channel	60		
Remark:	1. Average measurement was not performed if peak level lower than average limit. 2. Other frequency was 20dB below limit line within 1-18GHz, there is not show in the report.		

Mark	Frequency (MHz)	Reading Level (dBμV)	Factor (dB)	Measure Level (dBμV/m)	Limit (dBμV/m)	Margin (dB)	Detector	Polarization
*	10171.5	50.4	-5.1	45.3	68.2	-22.9	Peak	Horizontal
	11140.5	50.8	-5.1	45.7	74.0	-28.3	Peak	Horizontal
	15756.0	47.3	2.6	49.9	74.0	-24.1	Peak	Horizontal
*	16844.0	46.5	4.2	50.7	68.2	-17.5	Peak	Horizontal
*	10188.5	50.1	-5.2	44.9	68.2	-23.3	Peak	Vertical
	12092.5	49.8	-4.0	45.8	74.0	-28.2	Peak	Vertical
	15628.5	48.2	1.5	49.7	74.0	-24.3	Peak	Vertical
*	17532.5	47.8	4.8	52.6	68.2	-15.6	Peak	Vertical

Note 1: "*" is not in restricted band, its limit is -27dBm/MHz. At a distance of 3 meters, the field strength limit in dBμV/m can be determined by adding a "conversion" factor of 95.2dB to the EIRP limit of -27dBm/MHz to obtain the limit for out of band spurious emissions.

Note 2: Measure Level (dBμV/m) = Reading Level (dBμV) + Factor (dB)

Factor (dB) = Cable Loss (dB) + Antenna Factor (dB/m) - Pre_Amplifier Gain (dB)

Test Site	SIP-AC1	Test Engineer	Edward Zhang
Test Date	2021/06/04	Test Mode	802.11ax-HE20 - Ant 0 + 1 (CDD Mode)
Test Channel	64		
Remark:	1. Average measurement was not performed if peak level lower than average limit. 2. Other frequency was 20dB below limit line within 1-18GHz, there is not show in the report.		

Mark	Frequency (MHz)	Reading Level (dBμV)	Factor (dB)	Measure Level (dBμV/m)	Limit (dBμV/m)	Margin (dB)	Detector	Polarization
*	9678.5	50.6	-5.4	45.2	68.2	-23.0	Peak	Horizontal
	12041.5	49.9	-4.0	45.9	74.0	-28.1	Peak	Horizontal
	15781.5	47.8	2.5	50.3	74.0	-23.7	Peak	Horizontal
*	17507.0	46.9	5.0	51.9	68.2	-16.3	Peak	Horizontal
*	9678.5	51.7	-5.4	46.3	68.2	-21.9	Peak	Vertical
	12152.0	49.9	-3.8	46.1	74.0	-27.9	Peak	Vertical
	15620.0	48.3	1.5	49.8	74.0	-24.2	Peak	Vertical
*	16810.0	46.9	3.8	50.7	68.2	-17.5	Peak	Vertical

Note 1: "*" is not in restricted band, its limit is -27dBm/MHz. At a distance of 3 meters, the field strength limit in dBμV/m can be determined by adding a "conversion" factor of 95.2dB to the EIRP limit of -27dBm/MHz to obtain the limit for out of band spurious emissions.

Note 2: Measure Level (dBμV/m) = Reading Level (dBμV) + Factor (dB)

Factor (dB) = Cable Loss (dB) + Antenna Factor (dB/m) - Pre_Amplifier Gain (dB)

Test Site	SIP-AC1	Test Engineer	Edward Zhang
Test Date	2021/06/04	Test Mode	802.11ax-HE20 - Ant 0 + 1 (CDD Mode)
Test Channel	100		
Remark:	1. Average measurement was not performed if peak level lower than average limit. 2. Other frequency was 20dB below limit line within 1-18GHz, there is not show in the report.		

Mark	Frequency (MHz)	Reading Level (dB μ V)	Factor (dB)	Measure Level (dB μ V/m)	Limit (dB μ V/m)	Margin (dB)	Detector	Polarization
*	10239.5	51.5	-5.4	46.1	68.2	-22.1	Peak	Horizontal
	12322.0	49.9	-3.8	46.1	74.0	-27.9	Peak	Horizontal
	15756.0	47.1	2.6	49.7	74.0	-24.3	Peak	Horizontal
*	17413.5	47.1	5.0	52.1	68.2	-16.1	Peak	Horizontal
*	9959.0	50.4	-5.1	45.3	68.2	-22.9	Peak	Vertical
	11633.5	49.6	-4.4	45.2	74.0	-28.8	Peak	Vertical
	15764.5	48.3	2.7	51.0	74.0	-23.0	Peak	Vertical
*	16742.0	45.6	4.2	49.8	68.2	-18.4	Peak	Vertical

Note 1: "*" is not in restricted band, its limit is -27dBm/MHz. At a distance of 3 meters, the field strength limit in dB μ V/m can be determined by adding a "conversion" factor of 95.2dB to the EIRP limit of -27dBm/MHz to obtain the limit for out of band spurious emissions.

Note 2: Measure Level (dB μ V/m) = Reading Level (dB μ V) + Factor (dB)

Factor (dB) = Cable Loss (dB) + Antenna Factor (dB/m) - Pre_Amplifier Gain (dB)

Test Site	SIP-AC1	Test Engineer	Edward Zhang
Test Date	2021/06/04	Test Mode	802.11ax-HE20 - Ant 0 + 1 (CDD Mode)
Test Channel	116		
Remark:	1. Average measurement was not performed if peak level lower than average limit. 2. Other frequency was 20dB below limit line within 1-18GHz, there is not show in the report.		

Mark	Frequency (MHz)	Reading Level (dBμV)	Factor (dB)	Measure Level (dBμV/m)	Limit (dBμV/m)	Margin (dB)	Detector	Polarization
*	10095.0	51.2	-5.3	45.9	68.2	-22.3	Peak	Horizontal
	11931.0	50.3	-4.1	46.2	74.0	-27.8	Peak	Horizontal
	15773.0	47.1	2.8	49.9	74.0	-24.1	Peak	Horizontal
*	17447.5	46.6	5.0	51.6	68.2	-16.6	Peak	Horizontal
*	9891.0	49.9	-5.2	44.7	68.2	-23.5	Peak	Vertical
	11472.0	50.2	-4.6	45.6	74.0	-28.4	Peak	Vertical
	15679.5	47.0	1.9	48.9	74.0	-25.1	Peak	Vertical
*	16776.0	46.2	4.1	50.3	68.2	-17.9	Peak	Vertical

Note 1: "*" is not in restricted band, its limit is -27dBm/MHz. At a distance of 3 meters, the field strength limit in dBμV/m can be determined by adding a "conversion" factor of 95.2dB to the EIRP limit of -27dBm/MHz to obtain the limit for out of band spurious emissions.

Note 2: Measure Level (dBμV/m) = Reading Level (dBμV) + Factor (dB)

Factor (dB) = Cable Loss (dB) + Antenna Factor (dB/m) - Pre_Amplifier Gain (dB)

Test Site	SIP-AC1	Test Engineer	Edward Zhang
Test Date	2021/06/04	Test Mode	802.11ax-HE20 - Ant 0 + 1 (CDD Mode)
Test Channel	140		
Remark:	1. Average measurement was not performed if peak level lower than average limit. 2. Other frequency was 20dB below limit line within 1-18GHz, there is not show in the report.		

Mark	Frequency (MHz)	Reading Level (dB μ V)	Factor (dB)	Measure Level (dB μ V/m)	Limit (dB μ V/m)	Margin (dB)	Detector	Polarization
*	9857.0	49.2	-5.3	43.9	68.2	-24.3	Peak	Horizontal
	12271.0	49.4	-3.6	45.8	74.0	-28.2	Peak	Horizontal
	15739.0	46.8	2.2	49.0	74.0	-25.0	Peak	Horizontal
*	16716.5	46.2	4.1	50.3	68.2	-17.9	Peak	Horizontal
*	10273.5	50.3	-5.3	45.0	68.2	-23.2	Peak	Vertical
	12058.5	49.6	-3.9	45.7	74.0	-28.3	Peak	Vertical
	15688.0	47.2	1.8	49.0	74.0	-25.0	Peak	Vertical
*	16835.5	46.1	4.3	50.4	68.2	-17.8	Peak	Vertical

Note 1: "*" is not in restricted band, its limit is -27dBm/MHz. At a distance of 3 meters, the field strength limit in dB μ V/m can be determined by adding a "conversion" factor of 95.2dB to the EIRP limit of -27dBm/MHz to obtain the limit for out of band spurious emissions.

Note 2: Measure Level (dB μ V/m) = Reading Level (dB μ V) + Factor (dB)

Factor (dB) = Cable Loss (dB) + Antenna Factor (dB/m) - Pre_Amplifier Gain (dB)

Test Site	SIP-AC1	Test Engineer	Edward Zhang
Test Date	2021/06/04	Test Mode	802.11ax-HE20 - Ant 0 + 1 (CDD Mode)
Test Channel	144		
Remark:	1. Average measurement was not performed if peak level lower than average limit. 2. Other frequency was 20dB below limit line within 1-18GHz, there is not show in the report.		

Mark	Frequency (MHz)	Reading Level (dB μ V)	Factor (dB)	Measure Level (dB μ V/m)	Limit (dB μ V/m)	Margin (dB)	Detector	Polarization
*	9746.5	51.3	-5.4	45.9	68.2	-22.3	Peak	Horizontal
	11990.5	50.8	-4.0	46.8	74.0	-27.2	Peak	Horizontal
	15688.0	47.8	1.8	49.6	74.0	-24.4	Peak	Horizontal
*	17371.0	46.3	5.2	51.5	68.2	-16.7	Peak	Horizontal
*	9789.0	50.4	-5.6	44.8	68.2	-23.4	Peak	Vertical
	11693.0	49.9	-4.6	45.3	74.0	-28.7	Peak	Vertical
	15773.0	47.2	2.8	50.0	74.0	-24.0	Peak	Vertical
*	16844.0	47.3	4.2	51.5	68.2	-16.7	Peak	Vertical

Note 1: "*" is not in restricted band, its limit is -27dBm/MHz. At a distance of 3 meters, the field strength limit in dB μ V/m can be determined by adding a "conversion" factor of 95.2dB to the EIRP limit of -27dBm/MHz to obtain the limit for out of band spurious emissions.

Note 2: Measure Level (dB μ V/m) = Reading Level (dB μ V) + Factor (dB)

Factor (dB) = Cable Loss (dB) + Antenna Factor (dB/m) - Pre_Amplifier Gain (dB)

Test Site	SIP-AC1	Test Engineer	Edward Zhang
Test Date	2021/06/04	Test Mode	802.11ax-HE20 - Ant 0 + 1 (CDD Mode)
Test Channel	149		
Remark:	1. Average measurement was not performed if peak level lower than average limit. 2. Other frequency was 20dB below limit line within 1-18GHz, there is not show in the report.		

Mark	Frequency (MHz)	Reading Level (dB μ V)	Factor (dB)	Measure Level (dB μ V/m)	Limit (dB μ V/m)	Margin (dB)	Detector	Polarization
*	10205.5	52.0	-5.3	46.7	68.2	-21.5	Peak	Horizontal
	11973.5	49.7	-3.9	45.8	74.0	-28.2	Peak	Horizontal
	15764.5	47.4	2.7	50.1	74.0	-23.9	Peak	Horizontal
*	16835.5	46.2	4.3	50.5	68.2	-17.7	Peak	Horizontal
*	9899.5	50.7	-5.2	45.5	68.2	-22.7	Peak	Vertical
	11727.0	50.4	-4.5	45.9	74.0	-28.1	Peak	Vertical
	15645.5	49.5	1.5	51.0	74.0	-23.0	Peak	Vertical
*	17447.5	46.1	5.0	51.1	68.2	-17.1	Peak	Vertical

Note 1: "*" is not in restricted band, its limit is -27dBm/MHz or -17dBm/MHz. At a distance of 3 meters, the field strength limit in dB μ V/m can be determined by adding a "conversion" factor of 95.2dB to the EIRP limit of -27dBm/MHz to obtain the limit for out of band spurious emissions.

Note 2: Measure Level (dB μ V/m) = Reading Level (dB μ V) + Factor (dB)

Factor (dB) = Cable Loss (dB) + Antenna Factor (dB/m) - Pre_Amplifier Gain (dB)

Test Site	SIP-AC1	Test Engineer	Edward Zhang
Test Date	2021/06/04	Test Mode	802.11ax-HE20 - Ant 0 + 1 (CDD Mode)
Test Channel	157		
Remark:	1. Average measurement was not performed if peak level lower than average limit. 2. Other frequency was 20dB below limit line within 1-18GHz, there is not show in the report.		

Mark	Frequency (MHz)	Reading Level (dBμV)	Factor (dB)	Measure Level (dBμV/m)	Limit (dBμV/m)	Margin (dB)	Detector	Polarization
*	9993.0	50.9	-5.1	45.8	68.2	-22.4	Peak	Horizontal
	12458.0	49.8	-3.6	46.2	74.0	-27.8	Peak	Horizontal
	15739.0	46.5	2.2	48.7	74.0	-25.3	Peak	Horizontal
*	16835.5	45.9	4.3	50.2	68.2	-18.0	Peak	Horizontal
*	10273.5	50.6	-5.3	45.3	68.2	-22.9	Peak	Vertical
	11633.5	50.6	-4.4	46.2	74.0	-27.8	Peak	Vertical
	15764.5	46.3	2.7	49.0	74.0	-25.0	Peak	Vertical
*	17294.5	46.8	4.9	51.7	68.2	-16.5	Peak	Vertical

Note 1: "*" is not in restricted band, its limit is -27dBm/MHz or -17dBm/MHz. At a distance of 3 meters, the field strength limit in dBμV/m can be determined by adding a "conversion" factor of 95.2dB to the EIRP limit of -27dBm/MHz to obtain the limit for out of band spurious emissions.

Note 2: Measure Level (dBμV/m) = Reading Level (dBμV) + Factor (dB)

Factor (dB) = Cable Loss (dB) + Antenna Factor (dB/m) - Pre_Amplifier Gain (dB)

Test Site	SIP-AC1	Test Engineer	Edward Zhang
Test Date	2021/06/04	Test Mode	802.11ax-HE20 - Ant 0 + 1 (CDD Mode)
Test Channel	165		
Remark:	1. Average measurement was not performed if peak level lower than average limit. 2. Other frequency was 20dB below limit line within 1-18GHz, there is not show in the report.		

Mark	Frequency (MHz)	Reading Level (dB μ V)	Factor (dB)	Measure Level (dB μ V/m)	Limit (dB μ V/m)	Margin (dB)	Detector	Polarization
*	10120.5	50.3	-5.2	45.1	68.2	-23.1	Peak	Horizontal
	11574.0	50.4	-4.7	45.7	74.0	-28.3	Peak	Horizontal
	15679.5	48.0	1.9	49.9	74.0	-24.1	Peak	Horizontal
*	16886.5	46.5	4.0	50.5	68.2	-17.7	Peak	Horizontal
*	9712.5	51.2	-5.3	45.9	68.2	-22.3	Peak	Vertical
	11956.5	49.9	-3.9	46.0	74.0	-28.0	Peak	Vertical
	15747.5	47.3	2.4	49.7	74.0	-24.3	Peak	Vertical
*	17439.0	46.4	5.1	51.5	68.2	-16.7	Peak	Vertical

Note 1: "*" is not in restricted band, its limit is -27dBm/MHz or -17dBm/MHz. At a distance of 3 meters, the field strength limit in dB μ V/m can be determined by adding a "conversion" factor of 95.2dB to the EIRP limit of -27dBm/MHz to obtain the limit for out of band spurious emissions.

Note 2: Measure Level (dB μ V/m) = Reading Level (dB μ V) + Factor (dB)

Factor (dB) = Cable Loss (dB) + Antenna Factor (dB/m) - Pre_Amplifier Gain (dB)

Test Site	SIP-AC1	Test Engineer	Edward Zhang
Test Date	2021/06/04	Test Mode	802.11ax-HE40 - Ant 0 + 1 (CDD Mode)
Test Channel	38		
Remark:	1. Average measurement was not performed if peak level lower than average limit. 2. Other frequency was 20dB below limit line within 1-18GHz, there is not show in the report.		

Mark	Frequency (MHz)	Reading Level (dB μ V)	Factor (dB)	Measure Level (dB μ V/m)	Limit (dB μ V/m)	Margin (dB)	Detector	Polarization
	8412.0	51.1	-6.1	45.0	74.0	-29.0	Peak	Horizontal
*	9882.5	52.1	-5.2	46.9	68.2	-21.3	Peak	Horizontal
	11132.0	51.0	-5.0	46.0	74.0	-28.0	Peak	Horizontal
*	16954.5	47.3	3.9	51.2	68.2	-17.0	Peak	Horizontal
	8361.0	50.9	-6.0	44.9	74.0	-29.1	Peak	Vertical
*	10129.0	50.8	-5.3	45.5	68.2	-22.7	Peak	Vertical
	12007.5	50.2	-4.2	46.0	74.0	-28.0	Peak	Vertical
*	16784.5	46.7	4.1	50.8	68.2	-17.4	Peak	Vertical

Note 1: "*" is not in restricted band, its limit is -27dBm/MHz. At a distance of 3 meters, the field strength limit in dB μ V/m can be determined by adding a "conversion" factor of 95.2dB to the EIRP limit of -27dBm/MHz to obtain the limit for out of band spurious emissions.

Note 2: Measure Level (dB μ V/m) = Reading Level (dB μ V) + Factor (dB)

Factor (dB) = Cable Loss (dB) + Antenna Factor (dB/m) - Pre_Amplifier Gain (dB)

Test Site	SIP-AC1	Test Engineer	Edward Zhang
Test Date	2021/06/04	Test Mode	802.11ax-HE40 - Ant 0 + 1 (CDD Mode)
Test Channel	46		
Remark:	1. Average measurement was not performed if peak level lower than average limit. 2. Other frequency was 20dB below limit line within 1-18GHz, there is not show in the report.		

Mark	Frequency (MHz)	Reading Level (dB μ V)	Factor (dB)	Measure Level (dB μ V/m)	Limit (dB μ V/m)	Margin (dB)	Detector	Polarization
	8488.5	52.0	-6.1	45.9	74.0	-28.1	Peak	Horizontal
*	10282.0	50.8	-5.3	45.5	68.2	-22.7	Peak	Horizontal
	11701.5	50.3	-4.6	45.7	74.0	-28.3	Peak	Horizontal
*	16827.0	46.9	4.3	51.2	68.2	-17.0	Peak	Horizontal
	8072.0	50.7	-6.2	44.5	74.0	-29.5	Peak	Vertical
*	10001.5	50.4	-5.1	45.3	68.2	-22.9	Peak	Vertical
	12279.5	49.7	-3.6	46.1	74.0	-27.9	Peak	Vertical
*	17218.0	47.3	4.2	51.5	68.2	-16.7	Peak	Vertical

Note 1: "*" is not in restricted band, its limit is -27dBm/MHz. At a distance of 3 meters, the field strength limit in dB μ V/m can be determined by adding a "conversion" factor of 95.2dB to the EIRP limit of -27dBm/MHz to obtain the limit for out of band spurious emissions.

Note 2: Measure Level (dB μ V/m) = Reading Level (dB μ V) + Factor (dB)

Factor (dB) = Cable Loss (dB) + Antenna Factor (dB/m) - Pre_Amplifier Gain (dB)

Test Site	SIP-AC1	Test Engineer	Edward Zhang
Test Date	2021/06/04	Test Mode	802.11ax-HE40 - Ant 0 + 1 (CDD Mode)
Test Channel	54		
Remark:	1. Average measurement was not performed if peak level lower than average limit. 2. Other frequency was 20dB below limit line within 1-18GHz, there is not show in the report.		

Mark	Frequency (MHz)	Reading Level (dB μ V)	Factor (dB)	Measure Level (dB μ V/m)	Limit (dB μ V/m)	Margin (dB)	Detector	Polarization
	8165.5	50.3	-5.9	44.4	74.0	-29.6	Peak	Horizontal
*	9636.0	51.0	-5.4	45.6	68.2	-22.6	Peak	Horizontal
	11310.5	50.7	-5.0	45.7	74.0	-28.3	Peak	Horizontal
*	16487.0	47.5	3.5	51.0	68.2	-17.2	Peak	Horizontal
*	9891.0	50.8	-5.2	45.6	68.2	-22.6	Peak	Vertical
	11480.5	50.0	-4.8	45.2	74.0	-28.8	Peak	Vertical
	15773.0	46.9	2.8	49.7	74.0	-24.3	Peak	Vertical
*	16733.5	47.0	4.2	51.2	68.2	-17.0	Peak	Vertical

Note 1: "*" is not in restricted band, its limit is -27dBm/MHz. At a distance of 3 meters, the field strength limit in dB μ V/m can be determined by adding a "conversion" factor of 95.2dB to the EIRP limit of -27dBm/MHz to obtain the limit for out of band spurious emissions.

Note 2: Measure Level (dB μ V/m) = Reading Level (dB μ V) + Factor (dB)

Factor (dB) = Cable Loss (dB) + Antenna Factor (dB/m) - Pre_Amplifier Gain (dB)

Test Site	SIP-AC1	Test Engineer	Edward Zhang
Test Date	2021/06/04	Test Mode	802.11ax-HE40 - Ant 0 + 1 (CDD Mode)
Test Channel	62		
Remark:	1. Average measurement was not performed if peak level lower than average limit. 2. Other frequency was 20dB below limit line within 1-18GHz, there is not show in the report.		

Mark	Frequency (MHz)	Reading Level (dBμV)	Factor (dB)	Measure Level (dBμV/m)	Limit (dBμV/m)	Margin (dB)	Detector	Polarization
	8327.0	51.1	-6.0	45.1	74.0	-28.9	Peak	Horizontal
*	10163.0	50.9	-5.1	45.8	68.2	-22.4	Peak	Horizontal
	11795.0	50.6	-4.4	46.2	74.0	-27.8	Peak	Horizontal
*	16852.5	47.2	4.2	51.4	68.2	-16.8	Peak	Horizontal
	8199.5	50.2	-6.1	44.1	74.0	-29.9	Peak	Vertical
*	10052.5	50.5	-5.1	45.4	68.2	-22.8	Peak	Vertical
	11429.5	50.7	-4.9	45.8	74.0	-28.2	Peak	Vertical
*	16572.0	47.1	3.1	50.2	68.2	-18.0	Peak	Vertical

Note 1: "*" is not in restricted band, its limit is -27dBm/MHz. At a distance of 3 meters, the field strength limit in dBμV/m can be determined by adding a "conversion" factor of 95.2dB to the EIRP limit of -27dBm/MHz to obtain the limit for out of band spurious emissions.

Note 2: Measure Level (dBμV/m) = Reading Level (dBμV) + Factor (dB)

Factor (dB) = Cable Loss (dB) + Antenna Factor (dB/m) - Pre_Amplifier Gain (dB)

Test Site	SIP-AC1	Test Engineer	Edward Zhang
Test Date	2021/06/04	Test Mode	802.11ax-HE40 - Ant 0 + 1 (CDD Mode)
Test Channel	102		
Remark:	1. Average measurement was not performed if peak level lower than average limit. 2. Other frequency was 20dB below limit line within 1-18GHz, there is not show in the report.		

Mark	Frequency (MHz)	Reading Level (dBμV)	Factor (dB)	Measure Level (dBμV/m)	Limit (dBμV/m)	Margin (dB)	Detector	Polarization
	8199.5	49.4	-6.1	43.3	74.0	-30.7	Peak	Horizontal
*	9619.0	50.4	-5.2	45.2	68.2	-23.0	Peak	Horizontal
	11276.5	48.3	-5.2	43.1	74.0	-30.9	Peak	Horizontal
*	16784.5	47.6	4.1	51.7	68.2	-16.5	Peak	Horizontal
	8361.0	51.0	-6.0	45.0	74.0	-29.0	Peak	Vertical
*	9865.5	51.1	-5.3	45.8	68.2	-22.4	Peak	Vertical
	11888.5	50.3	-4.2	46.1	74.0	-27.9	Peak	Vertical
*	16810.0	46.8	3.8	50.6	68.2	-17.6	Peak	Vertical

Note 1: "*" is not in restricted band, its limit is -27dBm/MHz. At a distance of 3 meters, the field strength limit in dBμV/m can be determined by adding a "conversion" factor of 95.2dB to the EIRP limit of -27dBm/MHz to obtain the limit for out of band spurious emissions.

Note 2: Measure Level (dBμV/m) = Reading Level (dBμV) + Factor (dB)

Factor (dB) = Cable Loss (dB) + Antenna Factor (dB/m) - Pre_Amplifier Gain (dB)

Test Site	SIP-AC1	Test Engineer	Edward Zhang
Test Date	2021/06/04	Test Mode	802.11ax-HE40 - Ant 0 + 1 (CDD Mode)
Test Channel	110		
Remark:	1. Average measurement was not performed if peak level lower than average limit. 2. Other frequency was 20dB below limit line within 1-18GHz, there is not show in the report.		

Mark	Frequency (MHz)	Reading Level (dBμV)	Factor (dB)	Measure Level (dBμV/m)	Limit (dBμV/m)	Margin (dB)	Detector	Polarization
	8480.0	50.6	-6.0	44.6	74.0	-29.4	Peak	Horizontal
*	10129.0	51.2	-5.3	45.9	68.2	-22.3	Peak	Horizontal
	11769.5	50.5	-4.4	46.1	74.0	-27.9	Peak	Horizontal
*	16861.0	46.5	4.2	50.7	68.2	-17.5	Peak	Horizontal
*	10086.5	50.7	-5.2	45.5	68.2	-22.7	Peak	Vertical
	11778.0	49.3	-4.2	45.1	74.0	-28.9	Peak	Vertical
	15764.5	47.4	2.7	50.1	74.0	-23.9	Peak	Vertical
*	16869.5	47.5	4.2	51.7	68.2	-16.5	Peak	Vertical

Note 1: "*" is not in restricted band, its limit is -27dBm/MHz. At a distance of 3 meters, the field strength limit in dBμV/m can be determined by adding a "conversion" factor of 95.2dB to the EIRP limit of -27dBm/MHz to obtain the limit for out of band spurious emissions.

Note 2: Measure Level (dBμV/m) = Reading Level (dBμV) + Factor (dB)

Factor (dB) = Cable Loss (dB) + Antenna Factor (dB/m) - Pre_Amplifier Gain (dB)

Test Site	SIP-AC1	Test Engineer	Edward Zhang
Test Date	2021/06/04	Test Mode	802.11ax-HE40 - Ant 0 + 1 (CDD Mode)
Test Channel	134		
Remark:	1. Average measurement was not performed if peak level lower than average limit. 2. Other frequency was 20dB below limit line within 1-18GHz, there is not show in the report.		

Mark	Frequency (MHz)	Reading Level (dB μ V)	Factor (dB)	Measure Level (dB μ V/m)	Limit (dB μ V/m)	Margin (dB)	Detector	Polarization
	8403.5	51.0	-6.0	45.0	74.0	-29.0	Peak	Horizontal
*	9865.5	50.5	-5.3	45.2	68.2	-23.0	Peak	Horizontal
	11880.0	49.8	-4.0	45.8	74.0	-28.2	Peak	Horizontal
*	16818.5	47.3	4.1	51.4	68.2	-16.8	Peak	Horizontal
*	9950.5	50.4	-5.1	45.3	68.2	-22.9	Peak	Vertical
	11378.5	50.2	-4.9	45.3	74.0	-28.7	Peak	Vertical
	15450.0	47.6	2.0	49.6	74.0	-24.4	Peak	Vertical
*	17481.5	46.5	4.9	51.4	68.2	-16.8	Peak	Vertical

Note 1: "*" is not in restricted band, its limit is -27dBm/MHz. At a distance of 3 meters, the field strength limit in dB μ V/m can be determined by adding a "conversion" factor of 95.2dB to the EIRP limit of -27dBm/MHz to obtain the limit for out of band spurious emissions.

Note 2: Measure Level (dB μ V/m) = Reading Level (dB μ V) + Factor (dB)

Factor (dB) = Cable Loss (dB) + Antenna Factor (dB/m) - Pre_Amplifier Gain (dB)

Test Site	SIP-AC1	Test Engineer	Edward Zhang
Test Date	2021/06/04	Test Mode	802.11ax-HE40 - Ant 0 + 1 (CDD Mode)
Test Channel	142		
Remark:	1. Average measurement was not performed if peak level lower than average limit. 2. Other frequency was 20dB below limit line within 1-18GHz, there is not show in the report.		

Mark	Frequency (MHz)	Reading Level (dBμV)	Factor (dB)	Measure Level (dBμV/m)	Limit (dBμV/m)	Margin (dB)	Detector	Polarization
*	10001.5	51.1	-5.1	46.0	68.2	-22.2	Peak	Horizontal
	11480.5	50.0	-4.8	45.2	74.0	-28.8	Peak	Horizontal
	15875.0	47.8	2.2	50.0	74.0	-24.0	Peak	Horizontal
*	16818.5	47.0	4.1	51.1	68.2	-17.1	Peak	Horizontal
*	9644.5	50.8	-5.3	45.5	68.2	-22.7	Peak	Vertical
	11956.5	49.7	-3.9	45.8	74.0	-28.2	Peak	Vertical
	15773.0	46.4	2.8	49.2	74.0	-24.8	Peak	Vertical
*	16776.0	46.8	4.1	50.9	68.2	-17.3	Peak	Vertical

Note 1: "*" is not in restricted band, its limit is -27dBm/MHz. At a distance of 3 meters, the field strength limit in dBμV/m can be determined by adding a "conversion" factor of 95.2dB to the EIRP limit of -27dBm/MHz to obtain the limit for out of band spurious emissions.

Note 2: Measure Level (dBμV/m) = Reading Level (dBμV) + Factor (dB)

Factor (dB) = Cable Loss (dB) + Antenna Factor (dB/m) - Pre_Amplifier Gain (dB)

Test Site	SIP-AC1	Test Engineer	Edward Zhang
Test Date	2021/06/04	Test Mode	802.11ax-HE40 - Ant 0 + 1 (CDD Mode)
Test Channel	151		
Remark:	1. Average measurement was not performed if peak level lower than average limit. 2. Other frequency was 20dB below limit line within 1-18GHz, there is not show in the report.		

Mark	Frequency (MHz)	Reading Level (dB μ V)	Factor (dB)	Measure Level (dB μ V/m)	Limit (dB μ V/m)	Margin (dB)	Detector	Polarization
	8250.5	50.3	-5.8	44.5	74.0	-29.5	Peak	Horizontal
*	9636.0	50.5	-5.4	45.1	68.2	-23.1	Peak	Horizontal
	12058.5	47.6	-3.9	43.7	74.0	-30.3	Peak	Horizontal
*	16419.0	47.3	3.7	51.0	68.2	-17.2	Peak	Horizontal
	8395.0	51.3	-5.9	45.4	74.0	-28.6	Peak	Vertical
*	9644.5	51.4	-5.3	46.1	68.2	-22.1	Peak	Vertical
	11778.0	49.4	-4.2	45.2	74.0	-28.8	Peak	Vertical
*	16725.0	46.1	4.3	50.4	68.2	-17.8	Peak	Vertical

Note 1: "*" is not in restricted band, its limit is -27dBm/MHz or -17dBm/MHz. At a distance of 3 meters, the field strength limit in dB μ V/m can be determined by adding a "conversion" factor of 95.2dB to the EIRP limit of -27dBm/MHz to obtain the limit for out of band spurious emissions.

Note 2: Measure Level (dB μ V/m) = Reading Level (dB μ V) + Factor (dB)

Factor (dB) = Cable Loss (dB) + Antenna Factor (dB/m) - Pre_Amplifier Gain (dB)

Test Site	SIP-AC1	Test Engineer	Edward Zhang
Test Date	2021/06/04	Test Mode	802.11ax-HE40 - Ant 0 + 1 (CDD Mode)
Test Channel	159		
Remark:	1. Average measurement was not performed if peak level lower than average limit. 2. Other frequency was 20dB below limit line within 1-18GHz, there is not show in the report.		

Mark	Frequency (MHz)	Reading Level (dBμV)	Factor (dB)	Measure Level (dBμV/m)	Limit (dBμV/m)	Margin (dB)	Detector	Polarization
	8131.5	50.8	-6.1	44.7	74.0	-29.3	Peak	Horizontal
*	10324.5	51.0	-5.4	45.6	68.2	-22.6	Peak	Horizontal
	11650.5	50.0	-4.4	45.6	74.0	-28.4	Peak	Horizontal
*	16750.5	46.9	4.2	51.1	68.2	-17.1	Peak	Horizontal
	7562.0	51.2	-7.1	44.1	74.0	-29.9	Peak	Vertical
*	9857.0	51.1	-5.3	45.8	68.2	-22.4	Peak	Vertical
	11234.0	50.5	-5.3	45.2	74.0	-28.8	Peak	Vertical
*	16776.0	47.4	4.1	51.5	68.2	-16.7	Peak	Vertical

Note 1: "*" is not in restricted band, its limit is -27dBm/MHz or -17dBm/MHz. At a distance of 3 meters, the field strength limit in dBμV/m can be determined by adding a "conversion" factor of 95.2dB to the EIRP limit of -27dBm/MHz to obtain the limit for out of band spurious emissions.

Note 2: Measure Level (dBμV/m) = Reading Level (dBμV) + Factor (dB)

Factor (dB) = Cable Loss (dB) + Antenna Factor (dB/m) - Pre_Amplifier Gain (dB)

Test Site	SIP-AC1	Test Engineer	Edward Zhang
Test Date	2021/06/04	Test Mode	802.11ax-HE80 - Ant 0 + 1 (CDD Mode)
Test Channel	42		
Remark:	1. Average measurement was not performed if peak level lower than average limit. 2. Other frequency was 20dB below limit line within 1-18GHz, there is not show in the report.		

Mark	Frequency (MHz)	Reading Level (dBμV)	Factor (dB)	Measure Level (dBμV/m)	Limit (dBμV/m)	Margin (dB)	Detector	Polarization
*	9993.0	50.1	-5.1	45.0	68.2	-23.2	Peak	Horizontal
	11642.0	50.4	-4.3	46.1	74.0	-27.9	Peak	Horizontal
	15628.5	47.9	1.5	49.4	74.0	-24.6	Peak	Horizontal
*	16708.0	47.0	4.0	51.0	68.2	-17.2	Peak	Horizontal
*	10027.0	51.1	-5.2	45.9	68.2	-22.3	Peak	Vertical
	11225.5	48.3	-5.3	43.0	74.0	-31.0	Peak	Vertical
	15628.5	47.9	1.5	49.4	74.0	-24.6	Peak	Vertical
*	16555.0	48.5	3.0	51.5	68.2	-16.7	Peak	Vertical

Note 1: "*" is not in restricted band, its limit is -27dBm/MHz. At a distance of 3 meters, the field strength limit in dBμV/m can be determined by adding a "conversion" factor of 95.2dB to the EIRP limit of -27dBm/MHz to obtain the limit for out of band spurious emissions.

Note 2: Measure Level (dBμV/m) = Reading Level (dBμV) + Factor (dB)

Factor (dB) = Cable Loss (dB) + Antenna Factor (dB/m) - Pre_Amplifier Gain (dB)

Test Site	SIP-AC1	Test Engineer	Edward Zhang
Test Date	2021/06/04	Test Mode	802.11ax-HE80 - Ant 0 + 1 (CDD Mode)
Test Channel	58		
Remark:	1. Average measurement was not performed if peak level lower than average limit. 2. Other frequency was 20dB below limit line within 1-18GHz, there is not show in the report.		

Mark	Frequency (MHz)	Reading Level (dBμV)	Factor (dB)	Measure Level (dBμV/m)	Limit (dBμV/m)	Margin (dB)	Detector	Polarization
*	9610.5	51.0	-5.3	45.7	68.2	-22.5	Peak	Horizontal
	11625.0	49.3	-4.4	44.9	74.0	-29.1	Peak	Horizontal
	15773.0	45.3	2.8	48.1	74.0	-25.9	Peak	Horizontal
*	16495.5	46.0	3.5	49.5	68.2	-18.7	Peak	Horizontal
*	10129.0	51.1	-5.3	45.8	68.2	-22.4	Peak	Vertical
	11421.0	50.9	-4.9	46.0	74.0	-28.0	Peak	Vertical
	15739.0	47.5	2.2	49.7	74.0	-24.3	Peak	Vertical
*	17286.0	47.1	4.9	52.0	68.2	-16.2	Peak	Vertical

Note 1: "*" is not in restricted band, its limit is -27dBm/MHz. At a distance of 3 meters, the field strength limit in dBμV/m can be determined by adding a "conversion" factor of 95.2dB to the EIRP limit of -27dBm/MHz to obtain the limit for out of band spurious emissions.

Note 2: Measure Level (dBμV/m) = Reading Level (dBμV) + Factor (dB)

Factor (dB) = Cable Loss (dB) + Antenna Factor (dB/m) - Pre_Amplifier Gain (dB)

Test Site	SIP-AC1	Test Engineer	Edward Zhang
Test Date	2021/06/04	Test Mode	802.11ax-HE80 - Ant 0 + 1 (CDD Mode)
Test Channel	106		
Remark:	1. Average measurement was not performed if peak level lower than average limit. 2. Other frequency was 20dB below limit line within 1-18GHz, there is not show in the report.		

Mark	Frequency (MHz)	Reading Level (dBμV)	Factor (dB)	Measure Level (dBμV/m)	Limit (dBμV/m)	Margin (dB)	Detector	Polarization
*	9695.5	50.7	-5.4	45.3	68.2	-22.9	Peak	Horizontal
	11880.0	50.6	-4.0	46.6	74.0	-27.4	Peak	Horizontal
	15577.5	47.7	1.7	49.4	74.0	-24.6	Peak	Horizontal
*	16844.0	47.5	4.2	51.7	68.2	-16.5	Peak	Horizontal
*	9993.0	50.0	-5.1	44.9	68.2	-23.3	Peak	Vertical
	11854.5	50.1	-4.3	45.8	74.0	-28.2	Peak	Vertical
	15739.0	46.9	2.2	49.1	74.0	-24.9	Peak	Vertical
*	16716.5	47.5	4.1	51.6	68.2	-16.6	Peak	Vertical

Note 1: "*" is not in restricted band, its limit is -27dBm/MHz. At a distance of 3 meters, the field strength limit in dBμV/m can be determined by adding a "conversion" factor of 95.2dB to the EIRP limit of -27dBm/MHz to obtain the limit for out of band spurious emissions.

Note 2: Measure Level (dBμV/m) = Reading Level (dBμV) + Factor (dB)

Factor (dB) = Cable Loss (dB) + Antenna Factor (dB/m) - Pre_Amplifier Gain (dB)

Test Site	SIP-AC1	Test Engineer	Edward Zhang
Test Date	2021/06/04	Test Mode	802.11ax-HE80 - Ant 0 + 1 (CDD Mode)
Test Channel	122		
Remark:	1. Average measurement was not performed if peak level lower than average limit. 2. Other frequency was 20dB below limit line within 1-18GHz, there is not show in the report.		

Mark	Frequency (MHz)	Reading Level (dBμV)	Factor (dB)	Measure Level (dBμV/m)	Limit (dBμV/m)	Margin (dB)	Detector	Polarization
*	9823.0	50.8	-5.4	45.4	68.2	-22.8	Peak	Horizontal
	11880.0	50.2	-4.0	46.2	74.0	-27.8	Peak	Horizontal
	15781.5	47.0	2.5	49.5	74.0	-24.5	Peak	Horizontal
*	16835.5	47.2	4.3	51.5	68.2	-16.7	Peak	Horizontal
*	10163.0	50.5	-5.1	45.4	68.2	-22.8	Peak	Vertical
	11880.0	49.2	-4.0	45.2	74.0	-28.8	Peak	Vertical
	15858.0	46.7	2.7	49.4	74.0	-24.6	Peak	Vertical
*	16742.0	47.0	4.2	51.2	68.2	-17.0	Peak	Vertical

Note 1: "*" is not in restricted band, its limit is -27dBm/MHz. At a distance of 3 meters, the field strength limit in dBμV/m can be determined by adding a "conversion" factor of 95.2dB to the EIRP limit of -27dBm/MHz to obtain the limit for out of band spurious emissions.

Note 2: Measure Level (dBμV/m) = Reading Level (dBμV) + Factor (dB)

Factor (dB) = Cable Loss (dB) + Antenna Factor (dB/m) - Pre_Amplifier Gain (dB)

Test Site	SIP-AC1	Test Engineer	Edward Zhang
Test Date	2021/06/04	Test Mode	802.11ax-HE80 - Ant 0 + 1 (CDD Mode)
Test Channel	138		
Remark:	1. Average measurement was not performed if peak level lower than average limit. 2. Other frequency was 20dB below limit line within 1-18GHz, there is not show in the report.		

Mark	Frequency (MHz)	Reading Level (dBμV)	Factor (dB)	Measure Level (dBμV/m)	Limit (dBμV/m)	Margin (dB)	Detector	Polarization
	8327.0	51.3	-6.0	45.3	74.0	-28.7	Peak	Horizontal
*	10460.5	51.2	-5.4	45.8	68.2	-22.4	Peak	Horizontal
	11854.5	50.1	-4.3	45.8	74.0	-28.2	Peak	Horizontal
*	16495.5	46.6	3.5	50.1	68.2	-18.1	Peak	Horizontal
	8242.0	51.1	-5.6	45.5	74.0	-28.5	Peak	Vertical
*	10052.5	50.3	-5.1	45.2	68.2	-23.0	Peak	Vertical
	12330.5	49.4	-3.8	45.6	74.0	-28.4	Peak	Vertical
*	16767.5	48.0	4.1	52.1	68.2	-16.1	Peak	Vertical

Note 1: "*" is not in restricted band, its limit is -27dBm/MHz. At a distance of 3 meters, the field strength limit in dBμV/m can be determined by adding a "conversion" factor of 95.2dB to the EIRP limit of -27dBm/MHz to obtain the limit for out of band spurious emissions.

Note 2: Measure Level (dBμV/m) = Reading Level (dBμV) + Factor (dB)

Factor (dB) = Cable Loss (dB) + Antenna Factor (dB/m) - Pre_Amplifier Gain (dB)

Test Site	SIP-AC1	Test Engineer	Edward Zhang
Test Date	2021/06/04	Test Mode	802.11ax-HE80 - Ant 0 + 1 (CDD Mode)
Test Channel	155		
Remark:	1. Average measurement was not performed if peak level lower than average limit. 2. Other frequency was 20dB below limit line within 1-18GHz, there is not show in the report.		

Mark	Frequency (MHz)	Reading Level (dB μ V)	Factor (dB)	Measure Level (dB μ V/m)	Limit (dB μ V/m)	Margin (dB)	Detector	Polarization
*	9874.0	51.1	-5.3	45.8	68.2	-22.4	Peak	Horizontal
	11625.0	50.2	-4.4	45.8	74.0	-28.2	Peak	Horizontal
	15747.5	47.5	2.4	49.9	74.0	-24.1	Peak	Horizontal
*	16861.0	46.8	4.2	51.0	68.2	-17.2	Peak	Horizontal
*	9874.0	50.4	-5.3	45.1	68.2	-23.1	Peak	Vertical
	11370.0	51.4	-4.9	46.5	74.0	-27.5	Peak	Vertical
	15764.5	47.5	2.7	50.2	74.0	-23.8	Peak	Vertical
*	17532.5	46.5	4.8	51.3	68.2	-16.9	Peak	Vertical

Note 1: "*" is not in restricted band, its limit is -27dBm/MHz or -17dBm/MHz. At a distance of 3 meters, the field strength limit in dB μ V/m can be determined by adding a "conversion" factor of 95.2dB to the EIRP limit of -27dBm/MHz to obtain the limit for out of band spurious emissions.

Note 2: Measure Level (dB μ V/m) = Reading Level (dB μ V) + Factor (dB)

Factor (dB) = Cable Loss (dB) + Antenna Factor (dB/m) - Pre_Amplifier Gain (dB)

The worst case of Radiated Emission below 1GHz:

Site: SIP-AC1	Time: 2021/06/07 - 17:11
Limit: FCC_Part15.209_RE(3m)	Engineer: Mero Zhou
Probe: SIP-AC1_VULB 9168 _30-1000MHz	Polarity: Horizontal
EUT: WIFI+BT Combo Module	Power: AC 120V/60Hz
Test Mode: Transmit by 802.11a at Channel 5180MHz	

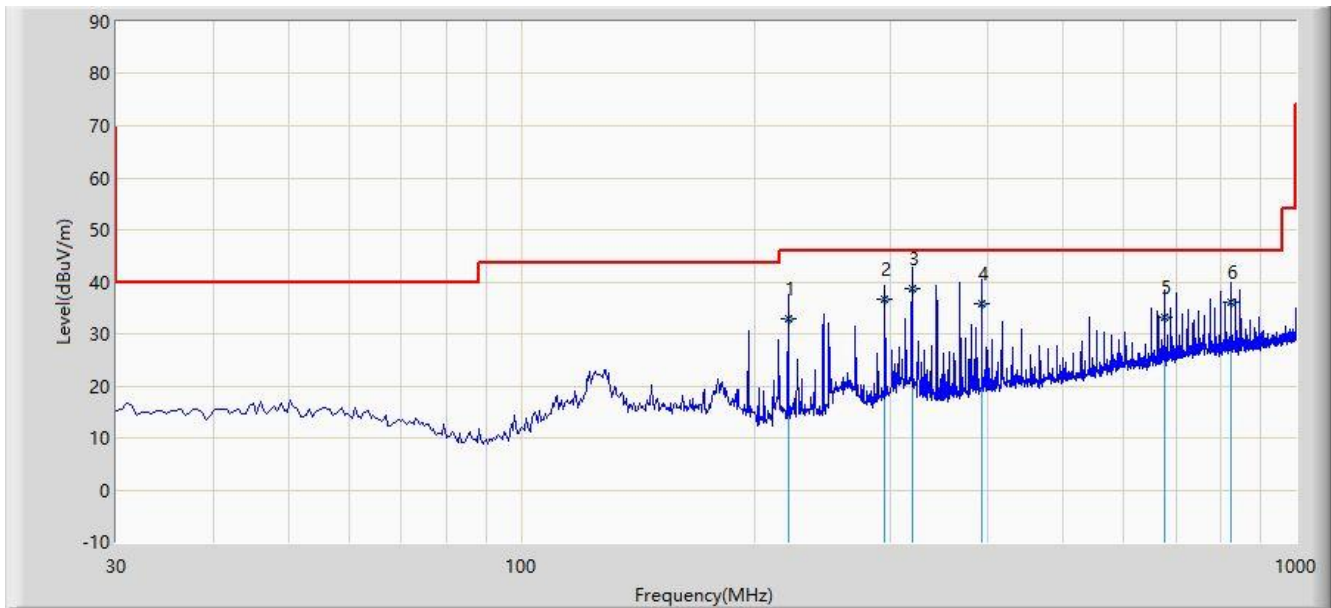

No	Flag	Mark	Frequency (MHz)	Measure Level (dBuV/m)	Reading Level (dBuV)	Margin (dB)	Limit (dBuV/m)	Factor (dB)	Type
1			221.090	32.964	18.250	-13.036	46.000	14.714	QP
2			294.810	36.766	18.660	-9.234	46.000	18.106	QP
3		*	319.545	38.837	20.020	-7.163	46.000	18.817	QP
4			393.265	35.762	15.330	-10.238	46.000	20.432	QP
5			676.020	33.273	7.410	-12.727	46.000	25.863	QP
6			823.460	36.014	7.950	-9.986	46.000	28.064	QP

Note 1: Measure Level (dBuV/m) = Reading Level (dBuV) + Factor (dB)

Factor (dB) = Cable Loss (dB) + Antenna Factor (dB/m)

Note 2: The amplitude of radiated emissions (frequency range from 9kHz ~ 30MHz, 18GHz to 40GHz) is that proximity to ambient noise, which also are attenuated more than 20 dB below the permissible value. Therefore, the data is not presented in the report.

Site: SIP-AC1	Time: 2021/06/07 - 17:13
Limit: FCC_Part15.209_RE(3m)	Engineer: Mero Zhou
Probe: SIP-AC1_VULB 9168 _30-1000MHz	Polarity: Vertical
EUT: WIFI+BT Combo Module	Power: AC 120V/60Hz
Test Mode: Transmit by 802.11a at Channel 5180MHz	

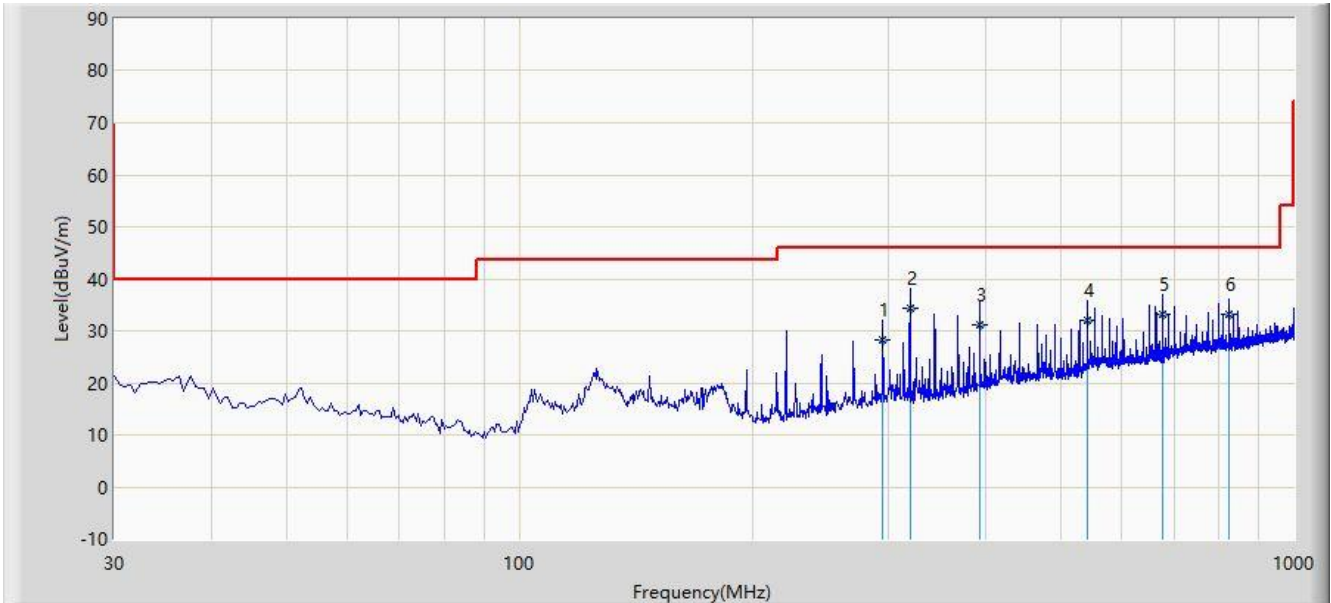

No	Flag	Mark	Frequency (MHz)	Measure Level (dBuV/m)	Reading Level (dBuV)	Margin (dB)	Limit (dBuV/m)	Factor (dB)	Type
1			294.810	28.356	10.250	-17.644	46.000	18.106	QP
2		*	319.545	34.437	15.620	-11.563	46.000	18.817	QP
3			393.265	31.022	10.590	-14.978	46.000	20.432	QP
4			540.705	32.112	8.590	-13.888	46.000	23.522	QP
5			676.020	33.313	7.450	-12.687	46.000	25.863	QP
6			823.460	33.084	5.020	-12.916	46.000	28.064	QP

Note 1: Measure Level (dB μ V/m) = Reading Level (dB μ V) + Factor (dB)

Factor (dB) = Cable Loss (dB) + Antenna Factor (dB/m)

Note 2: The amplitude of radiated emissions (frequency range from 9kHz ~ 30MHz, 18GHz to 40GHz) is that proximity to ambient noise, which also are attenuated more than 20 dB below the permissible value. Therefore, the data is not presented in the report.

Unwanted Emission in 5250MHz~5350MHz Band Result:

Test Site	WZ-TR3	Test Engineer	Luis Yang
Test Date	2021/06/16		

Test Mode	Data Rate/ MCS	Channel No.	Frequency (MHz)	Max Reading Level (dBm)	Limit (dBm)	Result
Ant 0 / Ant 0 + 1						
802.11a	6Mbps	48	5240	-24.51	-15.97	Pass
802.11n-HT20	MCS0	48	5240	-21.11	-15.45	Pass
802.11n-HT40	MCS0	46	5230	-24.76	-12.39	Pass
802.11ac-VHT20	MCS0	48	5240	-20.31	-15.47	Pass
802.11ac-VHT40	MCS0	46	5230	-25.77	-12.49	Pass
802.11ac-VHT80	MCS0	42	5210	-15.70	-9.92	Pass
802.11ax-HE20	MCS0	48	5240	-20.58	-15.33	Pass
802.11ax-HE40	MCS0	46	5230	-21.41	-11.34	Pass
802.11ax-HE80	MCS0	42	5210	-14.16	-10.00	Pass
Ant 1 / Ant 0 + 1						
802.11a	6Mbps	48	5240	-23.90	-17.37	Pass
802.11n-HT20	MCS0	48	5240	-20.60	-16.97	Pass
802.11n-HT40	MCS0	46	5230	-25.84	-13.80	Pass
802.11ac-VHT20	MCS0	48	5240	-22.77	-16.61	Pass
802.11ac-VHT40	MCS0	46	5230	-27.90	-14.01	Pass
802.11ac-VHT80	MCS0	42	5210	-18.37	-10.94	Pass
802.11ax-HE20	MCS0	48	5240	-21.31	-16.18	Pass
802.11ax-HE40	MCS0	46	5230	-23.97	-12.85	Pass
802.11ax-HE80	MCS0	42	5210	-15.76	-11.40	Pass

Note: Limit (dBm) = Each antenna port output power (dBm) - 26dB, output power is from ISED UNII-1 (5150-5250MHz).

Result – Ant 0 / Ant 0+1

802.11a - Channel 48 (5240MHz)

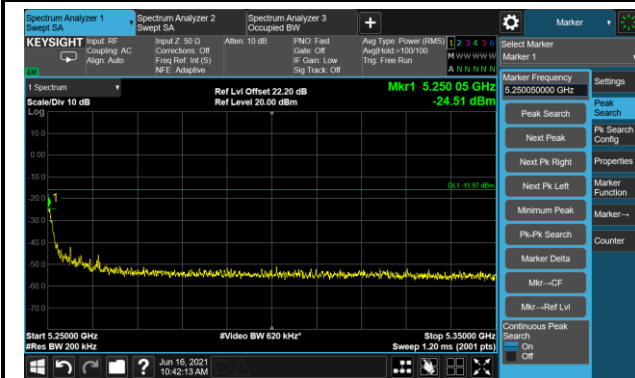

802.11n-HT20 - Channel 48 (5240MHz)

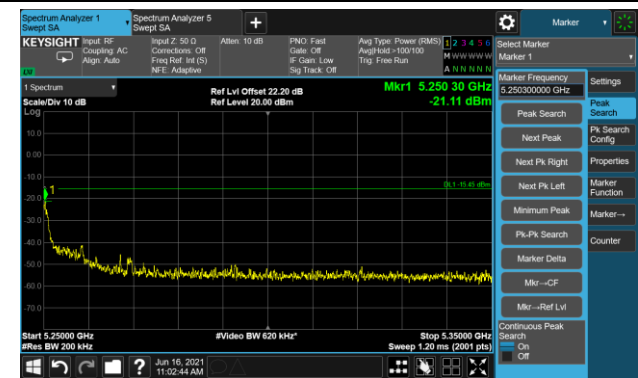

802.11n-HT40 - Channel 46 (5230MHz)

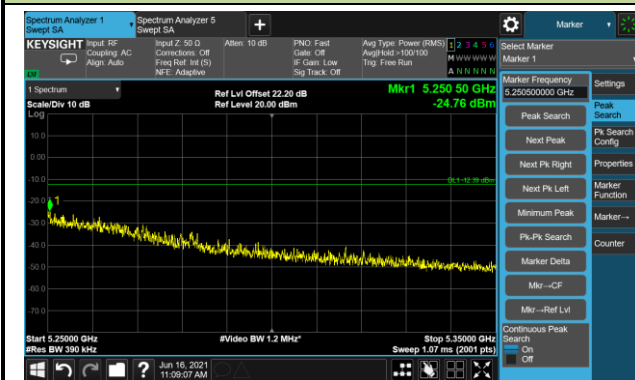

802.11ac-VHT20 - Channel 48 (5240MHz)

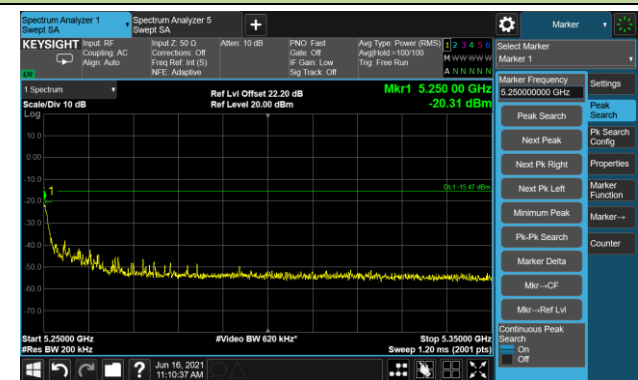

802.11ac-VHT40 - Channel 46 (5230MHz)

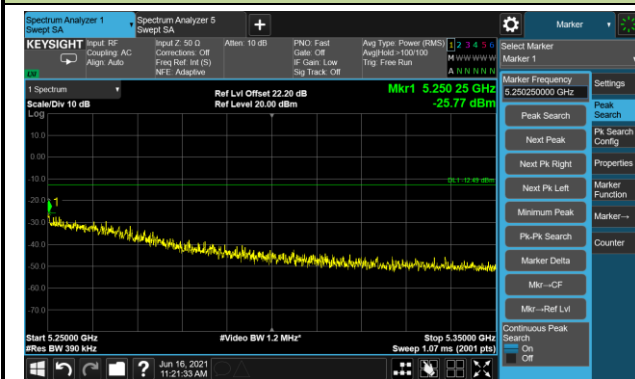

802.11ac-VHT80 - Channel 42 (5210MHz)

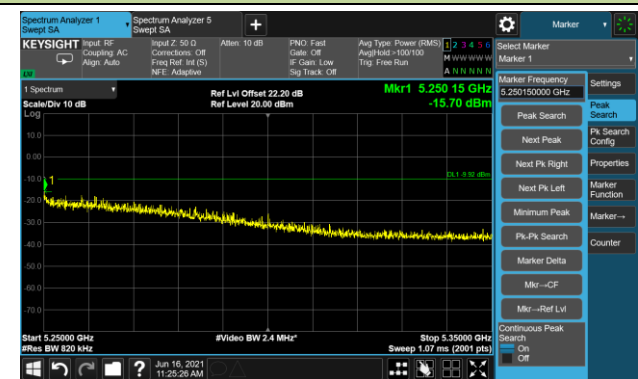

802.11ax-HE20 - Channel 48 (5240MHz)

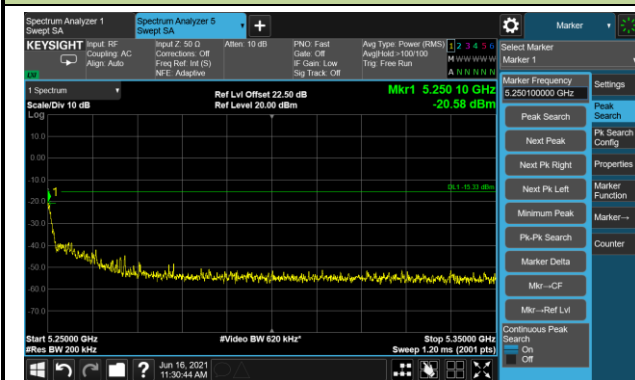

802.11ax-HE40 - Channel 46 (5230MHz)

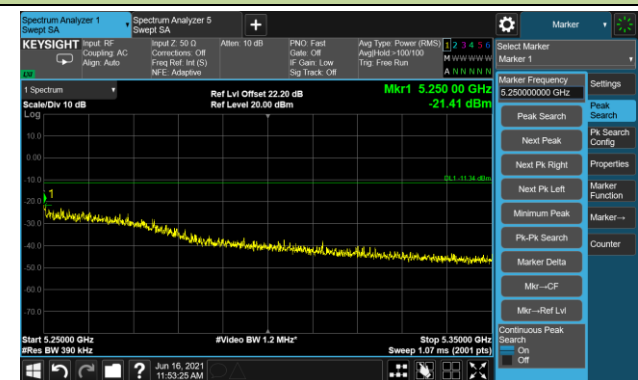

802.11ax-HE80 - Channel 42 (5210MHz)



Result – Ant 1 / Ant 0+1

802.11a - Channel 48 (5240MHz)

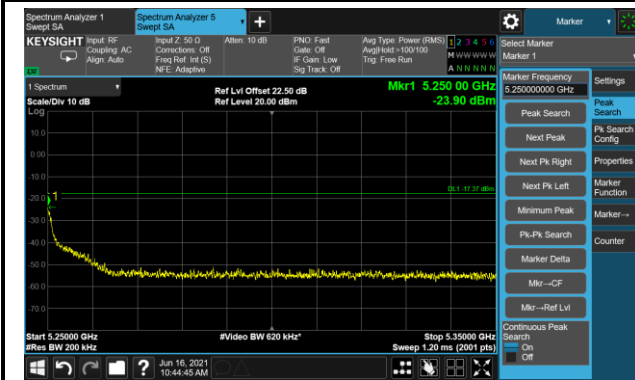

802.11n-HT20 - Channel 48 (5240MHz)

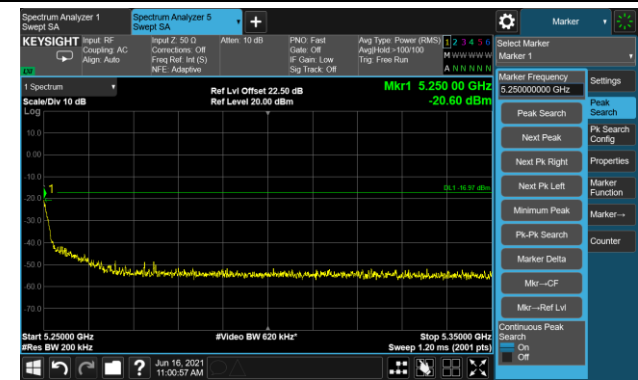

802.11n-HT40 - Channel 46 (5230MHz)

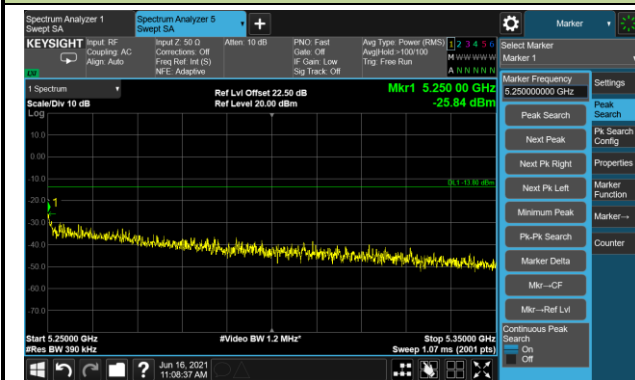

802.11ac-VHT20 - Channel 48 (5240MHz)

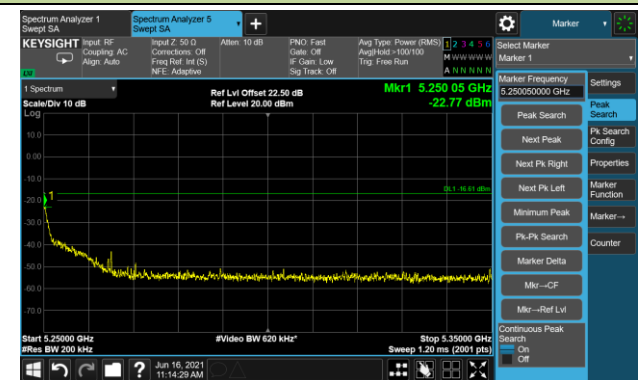

802.11ac-VHT40 - Channel 46 (5230MHz)

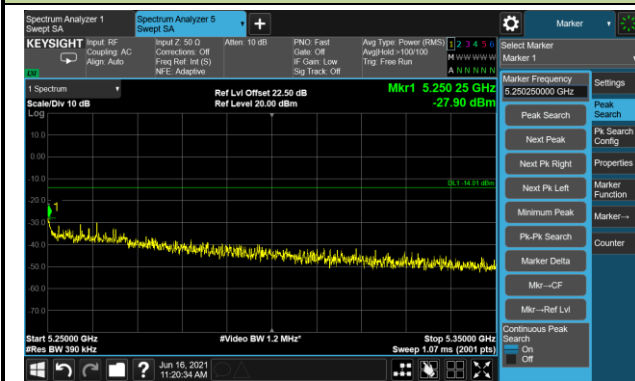

802.11ac-VHT80 - Channel 42 (5210MHz)

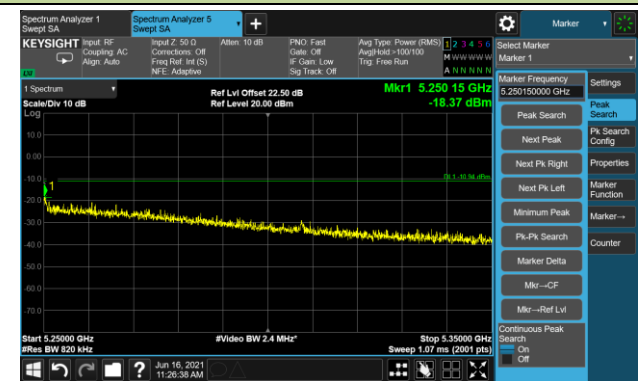

802.11ax-HE20 - Channel 48 (5240MHz)



802.11ax-HE40 - Channel 46 (5230MHz)



802.11ax-HE80 - Channel 42 (5210MHz)

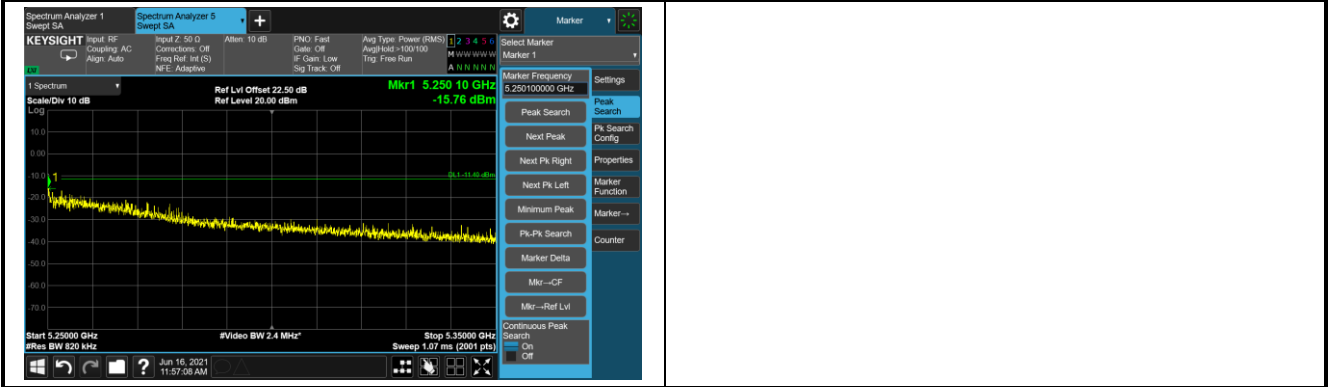

6.9. Radiated Restricted Band Edge Measurement

6.9.1. Test Limit

For 15.205 requirement:

Radiated emissions which fall in the restricted bands, as defined in Section 15.205(a) of FCC part 15, must also comply with the radiated emission limits specified in Section 15.209(a).

Frequency (MHz)	Frequency (MHz)	Frequency (MHz)	Frequency (GHz)
0.090 - 0.110	16.42 - 16.423	399.9 - 410	4.5 - 5.15
¹ 0.495 - 0.505	16.69475 - 16.69525	608 - 614	5.35 - 5.46
2.1735 - 2.1905	16.80425 - 16.80475	960 - 1240	7.25 - 7.75
4.125 - 4.128	25.5 - 25.67	1300 - 1427	8.025 - 8.5
4.17725 - 4.17775	37.5 - 38.25	1435 - 1626.5	9.0 - 9.2
4.20725 - 4.20775	73 - 74.6	1645.5 - 1646.5	9.3 - 9.5
6.215 - 6.218	74.8 - 75.2	1660 - 1710	10.6 - 12.7
6.26775 - 6.26825	108 - 121.94	1718.8 - 1722.2	13.25 - 13.4
6.31175 - 6.31225	123 - 138	2200 - 2300	14.47 - 14.5
8.291 - 8.294	149.9 - 150.05	2310 - 2390	15.35 - 16.2
8.362 - 8.366	156.52475 - 156.525	2483.5 - 2500	17.7 - 21.4
8.37625 - 8.38675	156.7 - 156.9	2690 - 2900	22.01 - 23.12
8.41425 - 8.41475	162.0125 - 167.17	3260 - 3267	23.6 - 24.0
12.29 - 12.293	167.72 - 173.2	3332 - 3339	31.2 - 31.8
12.51975 - 12.52025	240 - 285	3345.8 - 3358	36.43 - 36.5
12.57675 - 12.57725	322 - 335.4	3600 - 4400	(²)
13.36 - 13.41	--	--	--

For 15.407(b) requirement:

For transmitters operating in the 5.15-5.25 GHz band: All emissions outside of the 5.15-5.35 GHz band shall not exceed an e.i.r.p. of -27 dBm/MHz.

For transmitters operating in the 5.25-5.35 GHz band: All emissions outside of the 5.15-5.35 GHz band shall not exceed an e.i.r.p. of -27 dBm/MHz.

For transmitters operating in the 5.47-5.725 GHz band: All emissions outside of the 5.47-5.725 GHz band shall not exceed an e.i.r.p. of -27 dBm/MHz.

For transmitters operating in the 5.725-5.85 GHz band: All emissions shall be limited to a level of -27 dBm/MHz at 75 MHz or more above or below the band edge increasing linearly to 10 dBm/MHz at 25 MHz above or below the band edge, and from 25 MHz above or below the band edge

increasing linearly to a level of 15.6 dBm/MHz at 5 MHz above or below the band edge, and from 5 MHz above or below the band edge increasing linearly to a level of 27 dBm/MHz at the band edge.

Refer to KDB 789033 D02v02r01 G)2)c), as specified in § 15.407(b), emissions above 1000 MHz that are outside of the restricted bands are subject to a maximum emission limit of -27 dBm/MHz (or -17 dBm/MHz as specified in § 15.407(b)(4)). However, an out-of-band emission that complies with both the peak and average limits of § 15.209 is not required to satisfy the -27 dBm/MHz or -17 dBm/MHz maximum emission limit.

All out of band emissions appearing in a restricted band as specified in Section 15.205 of the Title 47CFR must not exceed the limits shown in Table per Section 15.209.

FCC Part 15 Subpart C Paragraph 15.209		
Frequency [MHz]	Field Strength [uV/m]	Measured Distance [Meters]
0.009 - 0.490	2400/F (kHz)	300
0.490 - 1.705	24000/F (kHz)	30
1.705 - 30	30	30
30 - 88	100	3
88 - 216	150	3
216 - 960	200	3
Above 960	500	3

For RSS-Gen Section 8.10 requirement:

Radiated emissions which fall in the restricted bands, as defined in Section 8.10 of RSS-Gen, must also comply with the radiated emission limits specified in Section 8.9.

Restricted frequency bands*		
Frequency (MHz)	Frequency (MHz)	Frequency (GHz)
0.090- 0.110	149.9 - 150.05	9.0 - 9.2
0.495 - 0.505	156.52475 - 156.525225	9.3 - 9.5
2.1735 - 2.1905	156.7 - 156.9	10.6 - 12.7
3.020 - 3.026	162.0125 - 167.17	13.25 - 13.4
4.125-4.128	167.72 - 173.2	14.47 - 14.5
4.17725-4.17775	240 - 285	15.35 - 16.2
4.20725-4.20775	322 - 335.4	17.7 - 21.4
5.677 - 5.683	399.9 - 410	22.01 - 23.12
6.215 - 6.218	608 - 614	23.6 - 24.0
6.26775 - 6.26825	960 - 1427	31.2 - 31.8
6.31175 - 6.31225	1435 - 1626.5	36.43 - 36.5
8.291 - 8.294	1645.5 - 1646.5	Above 38.6
8.362 - 8.366	1660 - 1710	
8.37625 - 8.38675	1718.8 -1722.2	
8.41425 - 8.41475	2200 - 2300	
12.29 - 12.293	2310 -2390	
12.51975 - 12.52025	2483.5 - 2500	
12.57675 - 12.57725	2655 - 2900	
13.36 -13.41	3260 - 3267	
16.42 - 16.423	3332 -3339	
16.69475 - 16.69525	3345.8 - 3358	
16.80425 - 16.80475	3500 - 4400	
25.5 - 25.67	4500 - 5150	
37.5 - 38.25	5350 - 5460	
73 - 74.6	7250 - 7750	
74.8 - 75.2	8025 - 8500	
108 - 138	--	

Note: *Certain frequency bands listed in Table6 and in bands above 38.6GHz are designated for licence-exempt applications. These frequency bands and the requirements that apply to the devices

are set out in the 200- and 300- series of RSSs, such as RSS-210 and RSS-310, which contain the requirements that apply to licence-exempt radio apparatus.

For transmitters operating in the 5.15-5.25 GHz band: All emissions outside of the 5.15-5.35 GHz band shall not exceed an e.i.r.p. of -27 dBm/MHz.

For transmitters operating in the band 5725-5850 MHz shall have e.i.r.p. of unwanted emissions comply with the following:

- a) 27 dBm/MHz at frequencies from the band edges decreasing linearly to 15.6 dBm/MHz at 5MHz above or below the band edges;
- b) 15.6 dBm/MHz at 5 MHz above or below the band edges decreasing linearly to 10 dBm/MHz at 25 MHz above or below the band edges;
- c) 10 dBm/MHz at 25 MHz above or below the band edges decreasing linearly to -27 dBm/MHz at 75 MHz above or below the band edges; and
- d) -27 dBm/MHz at frequencies more than 75 MHz above or below the band edges.

All out of band emissions appearing in a restricted band as specified in Section 8.10 of the RSS-Gen must not exceed the limits shown in Table per Section 8.9.

RSS-Gen Section 8.9		
Frequency [MHz]	Field Strength [μ V/m]	Measured Distance [Meters]
0.009 - 0.490	2400/F (kHz)	300
0.490 - 1.705	24000/F (kHz)	30
1.705 - 30	30	30
30 - 88	100	3
88 - 216	150	3
216 - 960	200	3
Above 960	500	3

6.9.2. Test Procedure Used

KDB 789033 D02v02r01 – Section G

6.9.3. Test Setting

Peak Measurements above 1GHz

1. Analyzer center frequency was set to the frequency of the radiated spurious emission of interest
2. RBW = 1MHz
3. VBW = 3MHz
4. Detector = peak
5. Sweep time = auto couple
6. Trace mode = max hold
7. Trace was allowed to stabilize

Average Measurements above 1GHz (Method VB)

1. Analyzer center frequency was set to the frequency of the radiated spurious emission of interest
2. RBW = 1MHz
3. VBW If the EUT is configured to transmit with duty cycle $\geq 98\%$, set $VBW \leq RBW/100$ (i.e., 10 kHz) but not less than 10 Hz. If the EUT duty cycle is $< 98\%$, set $VBW \geq 1/T$
4. Detector = Peak
5. Sweep time = auto
6. Allow max hold to run for at least 50 traces if the transmitted signal is continuous or has at least 98% duty cycle. For lower duty cycles, increase the minimum number of traces by a factor of $1/x$, where x is the duty cycle.

6.9.4. Test Setup

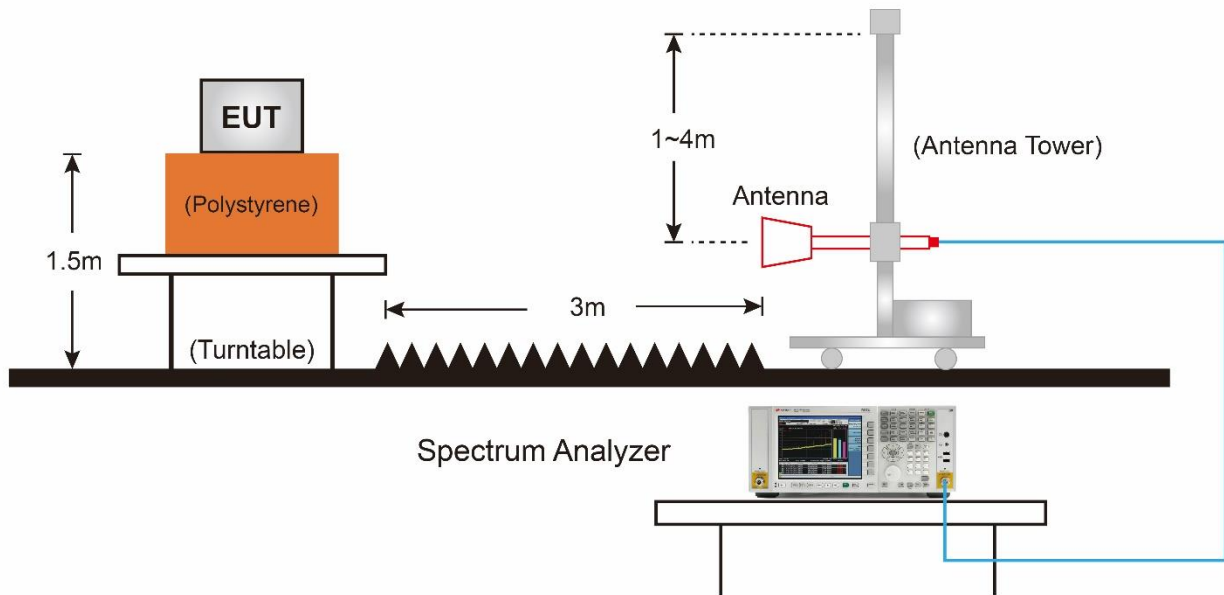

6.9.5. Test Result

Site: WZ-AC1	Time: 2021/05/28 - 20:55
Limit: FCC_Part15.209_RE(3m)	Engineer: Tommy Tang
Probe: WZ-AC1_BBHA9120D_1-18GHz	Polarity: Horizontal
EUT: WIFI+BT Combo Module	Power: AC 120V/60Hz
Test Mode: Transmit by 802.11a at Channel 5180MHz	

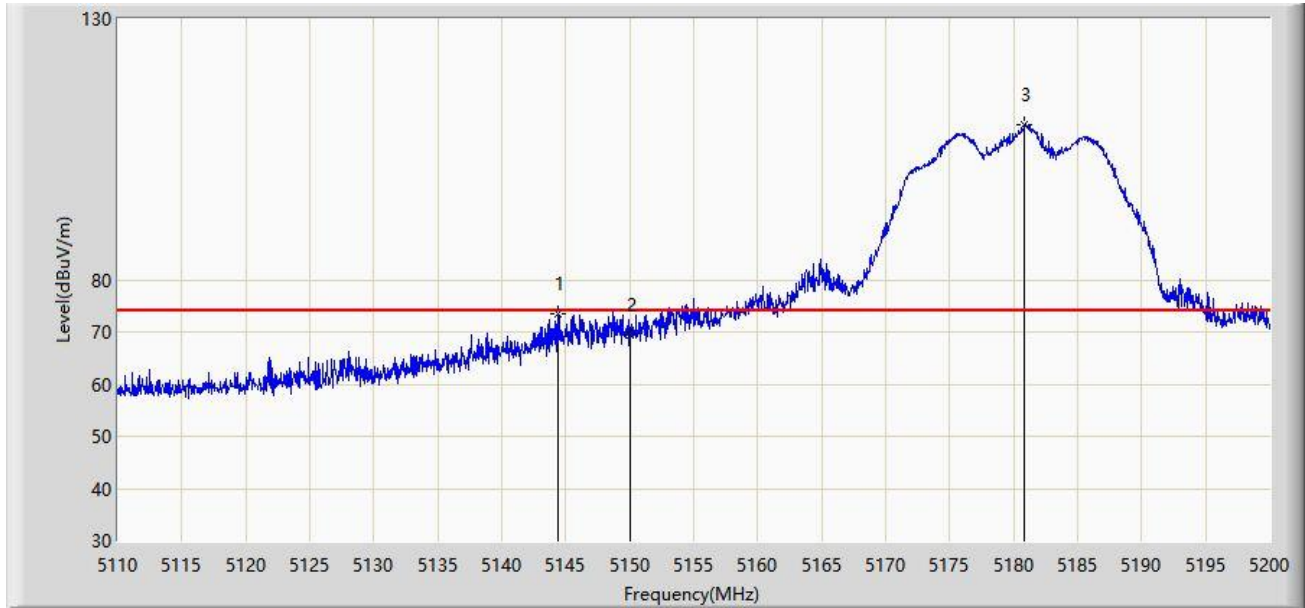

No	Flag	Mark	Frequency (MHz)	Measure Level (dBuV/m)	Reading Level (dBuV)	Margin (dB)	Limit (dBuV/m)	Factor (dB)	Type
1			5144.425	73.505	69.474	-0.495	74.000	4.032	PK
2			5150.000	69.346	65.317	-4.654	74.000	4.029	PK
3		*	5180.830	109.706	105.609	N/A	N/A	4.097	PK

Note: Measure Level (dB μ V/m) = Reading Level (dB μ V) + Factor (dB)

Factor (dB) = Cable Loss (dB) + Antenna Factor (dB/m) - Pre_Amplifier Gain (dB)

Site: WZ-AC1	Time: 2021/05/28 - 20:55
Limit: FCC_Part15.209_RE(3m)	Engineer: Tommy Tang
Probe: WZ-AC1_BBHA9120D_1-18GHz	Polarity: Horizontal
EUT: WIFI+BT Combo Module	Power: AC 120V/60Hz
Test Mode: Transmit by 802.11a at Channel 5180MHz	

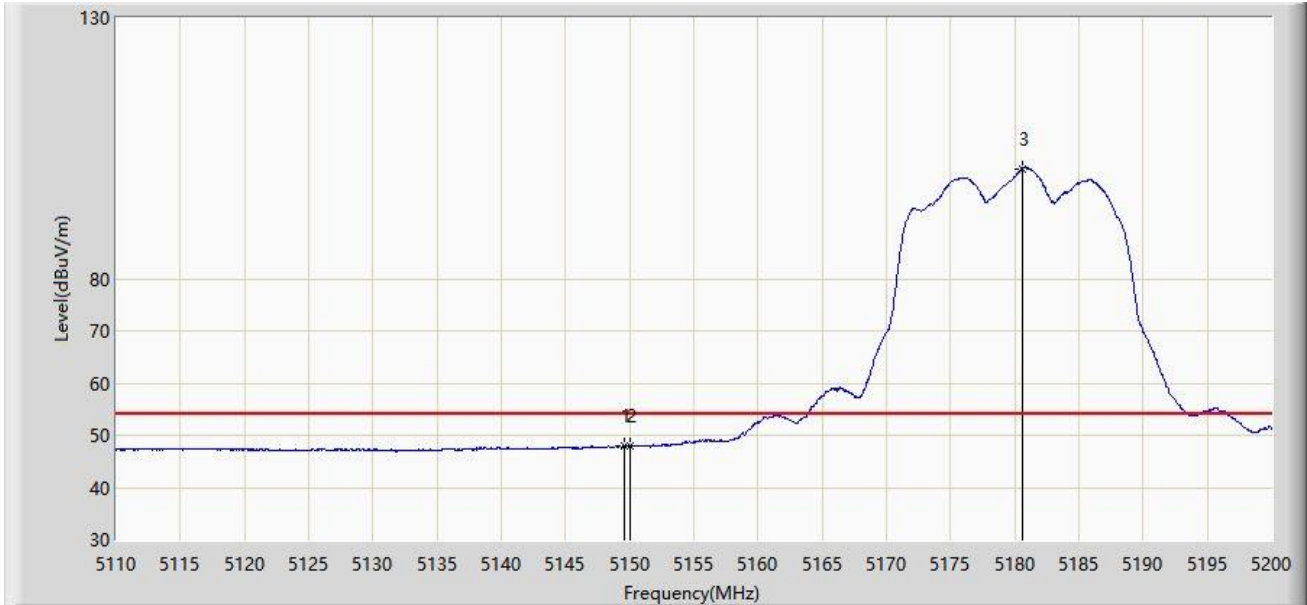

No	Flag	Mark	Frequency (MHz)	Measure Level (dBuV/m)	Reading Level (dBuV)	Margin (dB)	Limit (dBuV/m)	Factor (dB)	Type
1			5149.555	48.016	43.989	-5.984	54.000	4.027	AV
2			5150.000	47.895	43.866	-6.105	54.000	4.029	AV
3		*	5180.560	101.006	96.908	N/A	N/A	4.099	AV

Note: Measure Level (dB μ V/m) = Reading Level (dB μ V) + Factor (dB)

Factor (dB) = Cable Loss (dB) + Antenna Factor (dB/m) - Pre_Amplifier Gain (dB)

Site: WZ-AC1	Time: 2021/05/28 - 20:55
Limit: FCC_Part15.209_RE(3m)	Engineer: Tommy Tang
Probe: WZ-AC1_BBHA9120D_1-18GHz	Polarity: Vertical
EUT: WIFI+BT Combo Module	Power: AC 120V/60Hz
Test Mode: Transmit by 802.11a at Channel 5180MHz	

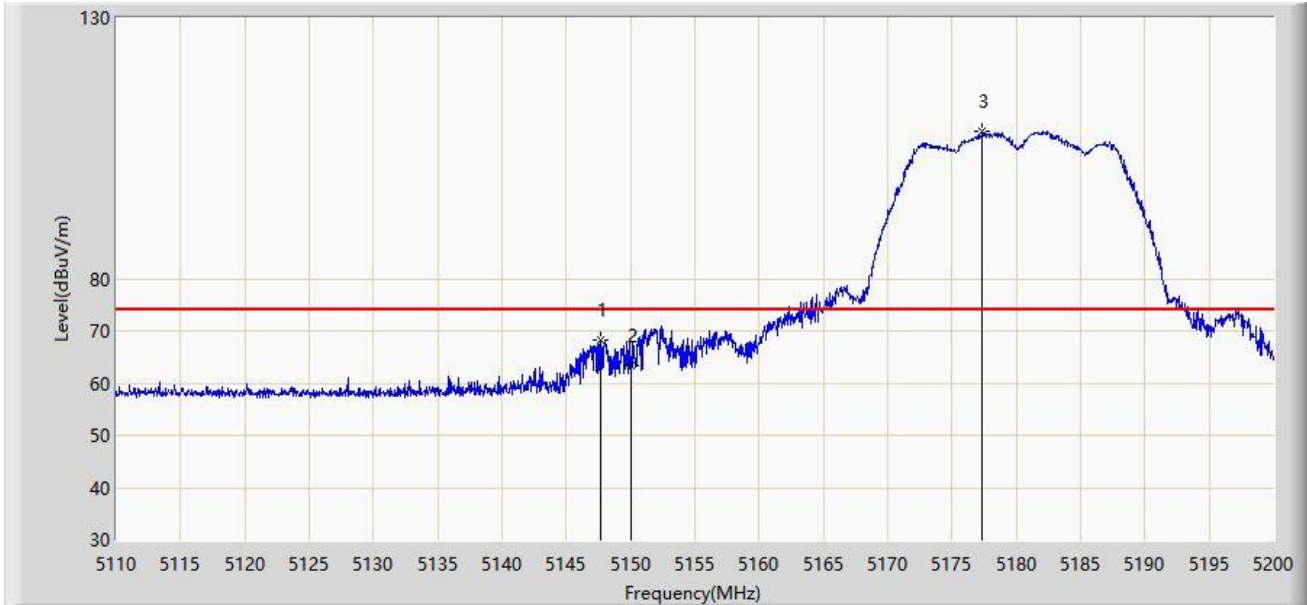

No	Flag	Mark	Frequency (MHz)	Measure Level (dBuV/m)	Reading Level (dBuV)	Margin (dB)	Limit (dBuV/m)	Factor (dB)	Type
1			5147.710	68.396	64.374	-5.604	74.000	4.022	PK
2			5150.000	63.394	59.365	-10.606	74.000	4.029	PK
3		*	5177.365	108.205	104.091	N/A	N/A	4.114	PK

Note: Measure Level (dB μ V/m) = Reading Level (dB μ V) + Factor (dB)

Factor (dB) = Cable Loss (dB) + Antenna Factor (dB/m) - Pre_Amplifier Gain (dB)

Site: WZ-AC1	Time: 2021/05/28 - 20:55
Limit: FCC_Part15.209_RE(3m)	Engineer: Tommy Tang
Probe: WZ-AC1_BBHA9120D_1-18GHz	Polarity: Vertical
EUT: WIFI+BT Combo Module	Power: AC 120V/60Hz
Test Mode: Transmit by 802.11a at Channel 5180MHz	

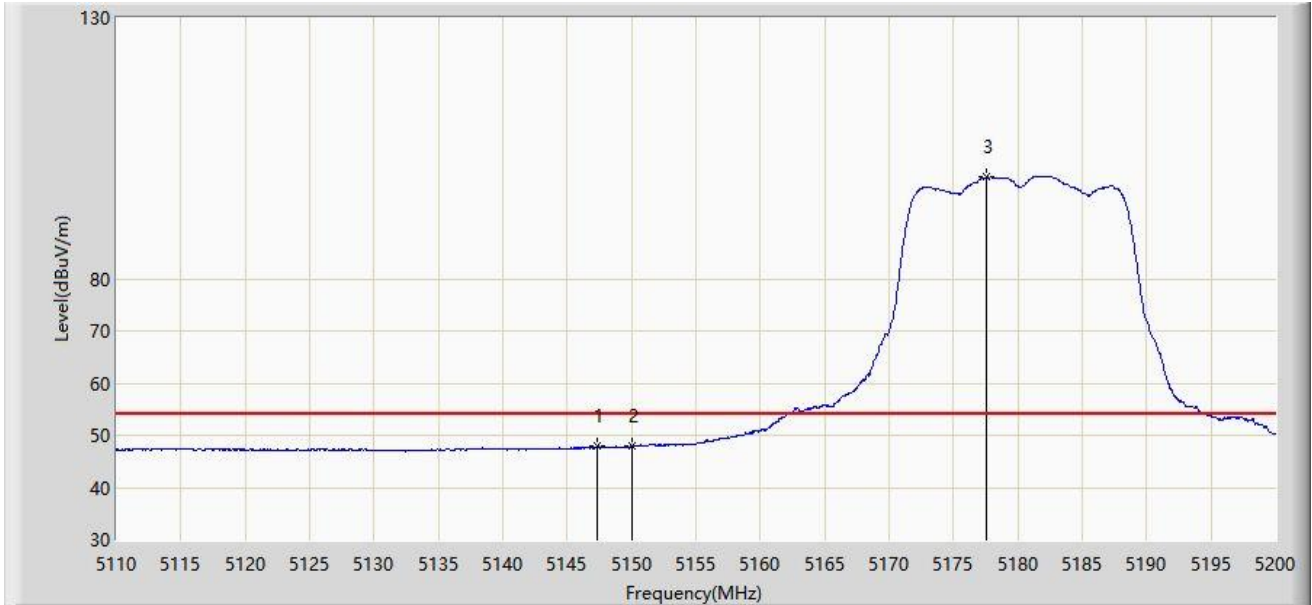

No	Flag	Mark	Frequency (MHz)	Measure Level (dBuV/m)	Reading Level (dBuV)	Margin (dB)	Limit (dBuV/m)	Factor (dB)	Type
1			5147.350	47.856	43.833	-6.144	54.000	4.022	AV
2			5150.000	47.889	43.860	-6.111	54.000	4.029	AV
3		*	5177.500	99.429	95.316	N/A	N/A	4.113	AV

Note: Measure Level (dB μ V/m) = Reading Level (dB μ V) + Factor (dB)

Factor (dB) = Cable Loss (dB) + Antenna Factor (dB/m) - Pre_Amplifier Gain (dB)

Site: WZ-AC1	Time: 2021/05/28 - 21:57
Limit: FCC_Part15.209_RE(3m)	Engineer: Tommy Tang
Probe: WZ-AC1_BBHA9120D_1-18GHz	Polarity: Horizontal
EUT: WIFI+BT Combo Module	Power: AC 120V/60Hz
Test Mode: Transmit by 802.11a at Channel 5320MHz	

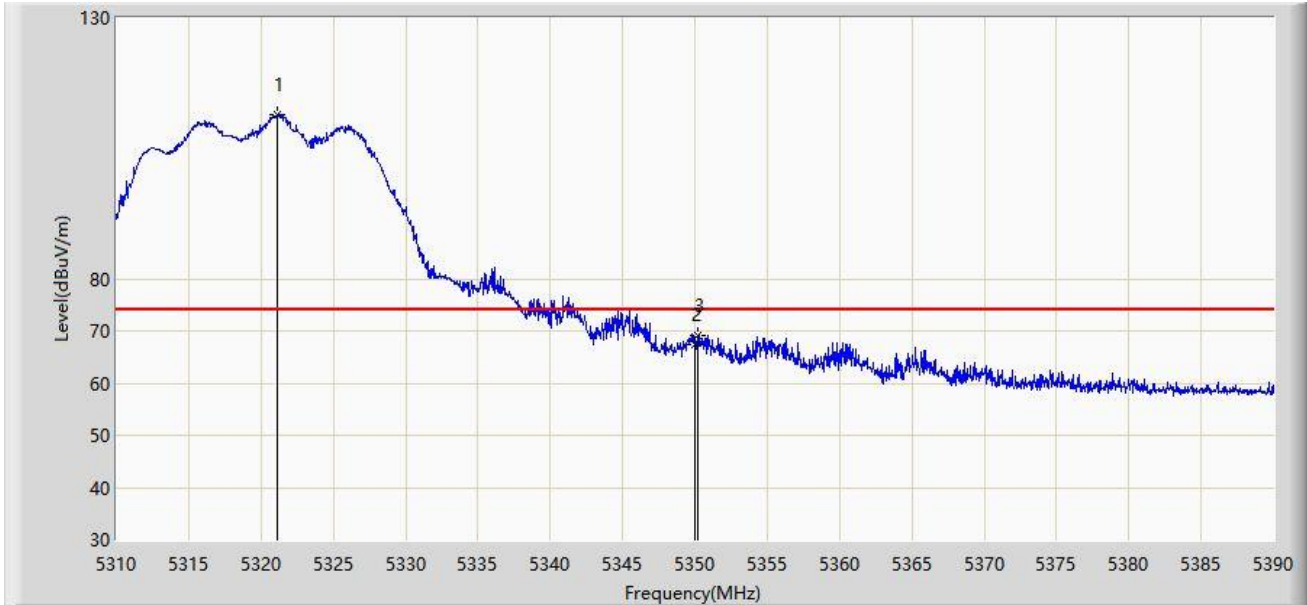

No	Flag	Mark	Frequency (MHz)	Measure Level (dBuV/m)	Reading Level (dBuV)	Margin (dB)	Limit (dBuV/m)	Factor (dB)	Type
1		*	5321.080	111.388	107.568	N/A	N/A	3.819	PK
2			5350.000	67.527	63.510	-6.473	74.000	4.017	PK
3			5350.240	69.267	65.248	-4.733	74.000	4.018	PK

Note: Measure Level (dB μ V/m) = Reading Level (dB μ V) + Factor (dB)

Factor (dB) = Cable Loss (dB) + Antenna Factor (dB/m) - Pre_Amplifier Gain (dB)

Site: WZ-AC1	Time: 2021/05/28 - 21:59
Limit: FCC_Part15.209_RE(3m)	Engineer: Tommy Tang
Probe: WZ-AC1_BBHA9120D_1-18GHz	Polarity: Horizontal
EUT: WIFI+BT Combo Module	Power: AC 120V/60Hz
Test Mode: Transmit by 802.11a at Channel 5320MHz	

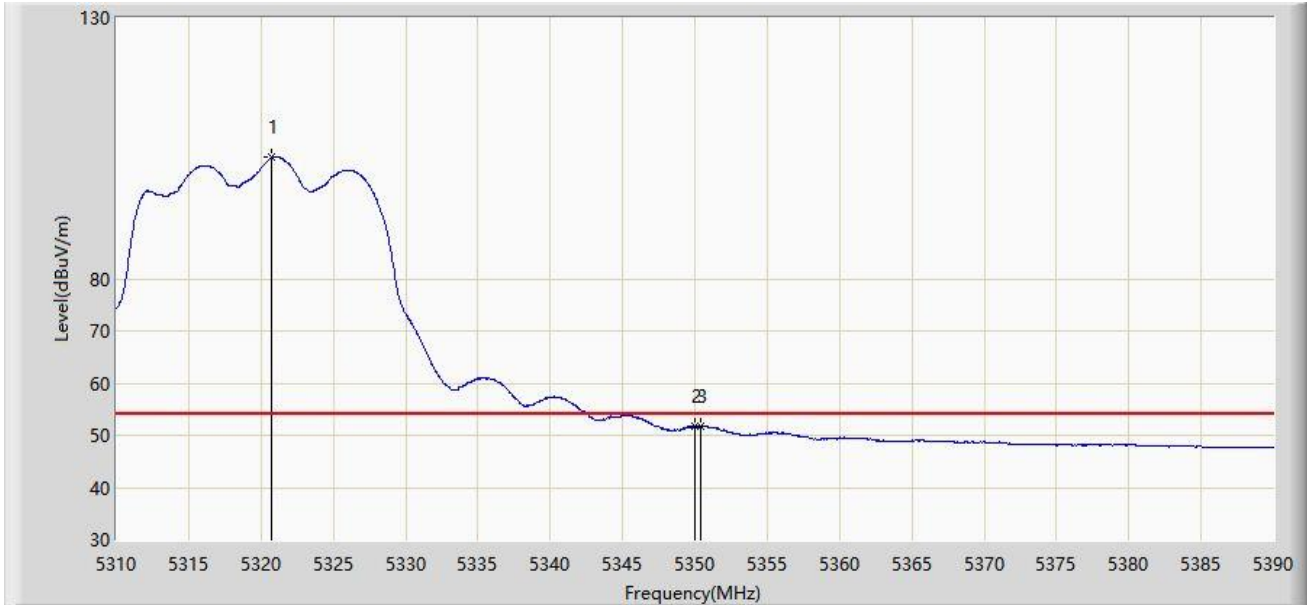

No	Flag	Mark	Frequency (MHz)	Measure Level (dBuV/m)	Reading Level (dBuV)	Margin (dB)	Limit (dBuV/m)	Factor (dB)	Type
1		*	5320.760	103.208	99.390	N/A	N/A	3.818	AV
2			5350.000	51.641	47.624	-2.359	54.000	4.017	AV
3			5350.360	51.818	47.798	-2.182	54.000	4.020	AV

Note: Measure Level (dB μ V/m) = Reading Level (dB μ V) + Factor (dB)

Factor (dB) = Cable Loss (dB) + Antenna Factor (dB/m) - Pre_Amplifier Gain (dB)

Site: WZ-AC1	Time: 2021/05/28 - 22:00
Limit: FCC_Part15.209_RE(3m)	Engineer: Tommy Tang
Probe: WZ-AC1_BBHA9120D_1-18GHz	Polarity: Vertical
EUT: WIFI+BT Combo Module	Power: AC 120V/60Hz
Test Mode: Transmit by 802.11a at Channel 5320MHz	

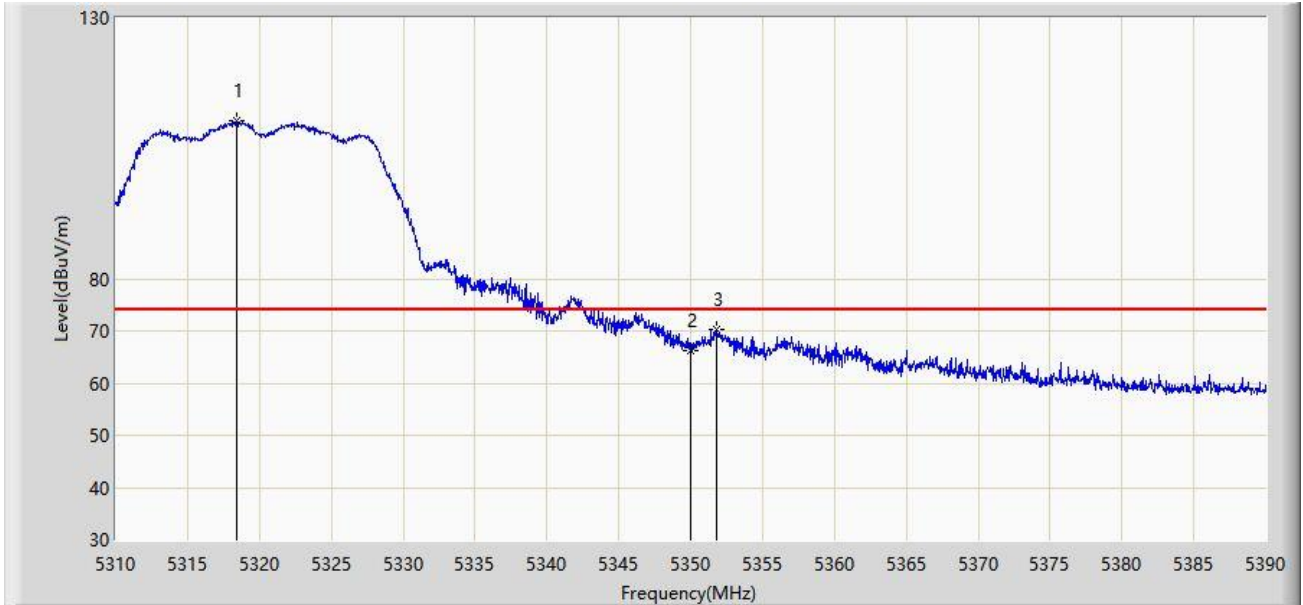

No	Flag	Mark	Frequency (MHz)	Measure Level (dBuV/m)	Reading Level (dBuV)	Margin (dB)	Limit (dBuV/m)	Factor (dB)	Type
1		*	5318.400	110.191	106.382	N/A	N/A	3.809	PK
2			5350.000	66.188	62.171	-7.812	74.000	4.017	PK
3			5351.760	70.417	66.389	-3.583	74.000	4.028	PK

Note: Measure Level (dB μ V/m) = Reading Level (dB μ V) + Factor (dB)

Factor (dB) = Cable Loss (dB) + Antenna Factor (dB/m) - Pre_Amplifier Gain (dB)

Site: WZ-AC1	Time: 2021/05/28 - 22:06
Limit: FCC_Part15.209_RE(3m)	Engineer: Tommy Tang
Probe: WZ-AC1_BBHA9120D_1-18GHz	Polarity: Vertical
EUT: WIFI+BT Combo Module	Power: AC 120V/60Hz
Test Mode: Transmit by 802.11a at Channel 5320MHz	

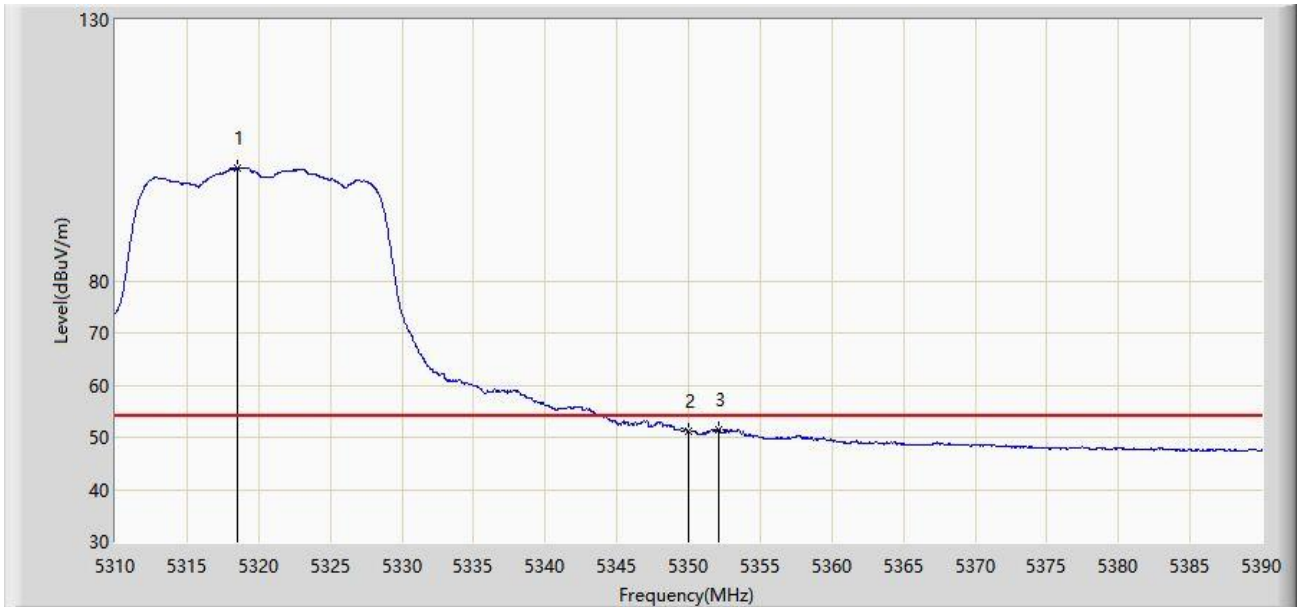

No	Flag	Mark	Frequency (MHz)	Measure Level (dBuV/m)	Reading Level (dBuV)	Margin (dB)	Limit (dBuV/m)	Factor (dB)	Type
1		*	5318.520	101.593	97.784	N/A	N/A	3.809	AV
2			5350.000	51.135	47.118	-2.865	54.000	4.017	AV
3			5352.120	51.591	47.562	-2.409	54.000	4.029	AV

Note: Measure Level (dB μ V/m) = Reading Level (dB μ V) + Factor (dB)

Factor (dB) = Cable Loss (dB) + Antenna Factor (dB/m) - Pre_Amplifier Gain (dB)

Site: WZ-AC1	Time: 2021/05/28 - 23:01
Limit: FCC_Part15.209_RE(3m)	Engineer: Tommy Tang
Probe: WZ-AC1_BBHA9120D_1-18GHz	Polarity: Horizontal
EUT: WIFI+BT Combo Module	Power: AC 120V/60Hz
Test Mode: Transmit by 802.11a at Channel 5500MHz	

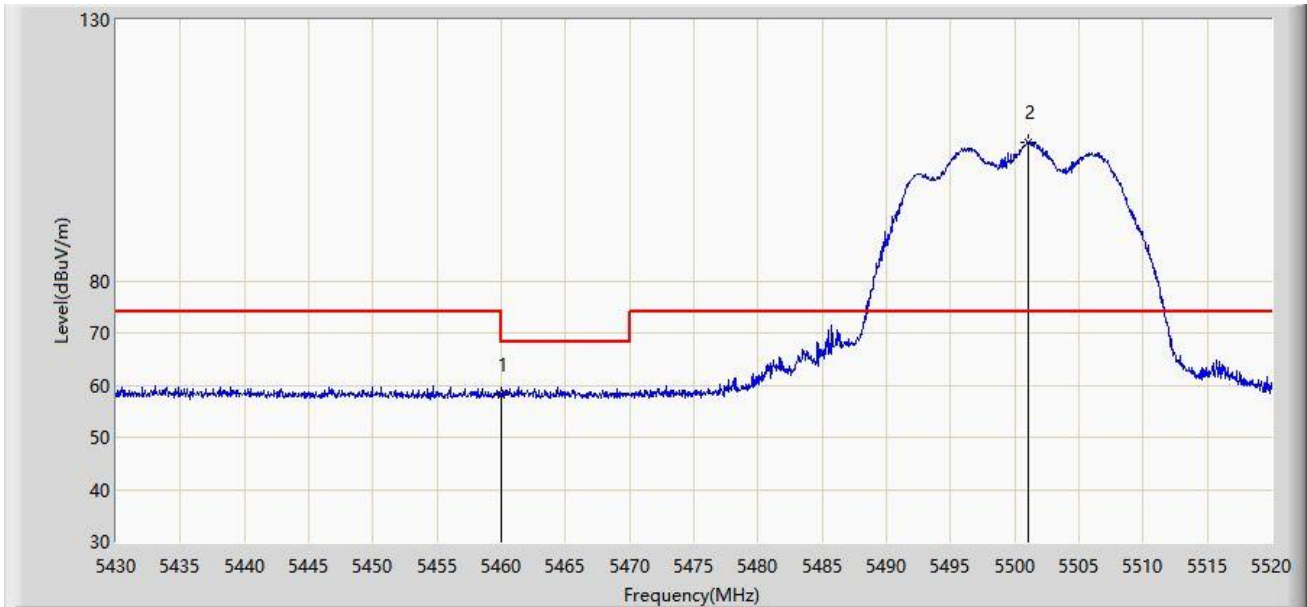

No	Flag	Mark	Frequency (MHz)	Measure Level (dBuV/m)	Reading Level (dBuV)	Margin (dB)	Limit (dBuV/m)	Factor (dB)	Type
1			5460.000	58.085	53.823	-15.915	74.000	4.261	PK
2		*	5501.055	106.642	102.251	N/A	N/A	4.391	PK

Note: Measure Level (dB μ V/m) = Reading Level (dB μ V) + Factor (dB)

Factor (dB) = Cable Loss (dB) + Antenna Factor (dB/m) - Pre_Amplifier Gain (dB)

Site: WZ-AC1	Time: 2021/05/28 - 23:08
Limit: FCC_Part15.209_RE(3m)	Engineer: Tommy Tang
Probe: WZ-AC1_BBHA9120D_1-18GHz	Polarity: Horizontal
EUT: WIFI+BT Combo Module	Power: AC 120V/60Hz
Test Mode: Transmit by 802.11a at Channel 5500MHz	



No	Flag	Mark	Frequency (MHz)	Measure Level (dBuV/m)	Reading Level (dBuV)	Margin (dB)	Limit (dBuV/m)	Factor (dB)	Type
1			5460.000	46.989	42.727	-7.011	54.000	4.261	AV
2		*	5500.785	98.227	93.841	N/A	N/A	4.387	AV

Note: Measure Level (dB μ V/m) = Reading Level (dB μ V) + Factor (dB)

Factor (dB) = Cable Loss (dB) + Antenna Factor (dB/m) - Pre_Amplifier Gain (dB)

Site: WZ-AC1	Time: 2021/05/28 - 23:14
Limit: FCC_Part15.209_RE(3m)	Engineer: Tommy Tang
Probe: WZ-AC1_BBHA9120D_1-18GHz	Polarity: Vertical
EUT: WIFI+BT Combo Module	Power: AC 120V/60Hz
Test Mode: Transmit by 802.11a at Channel 5500MHz	

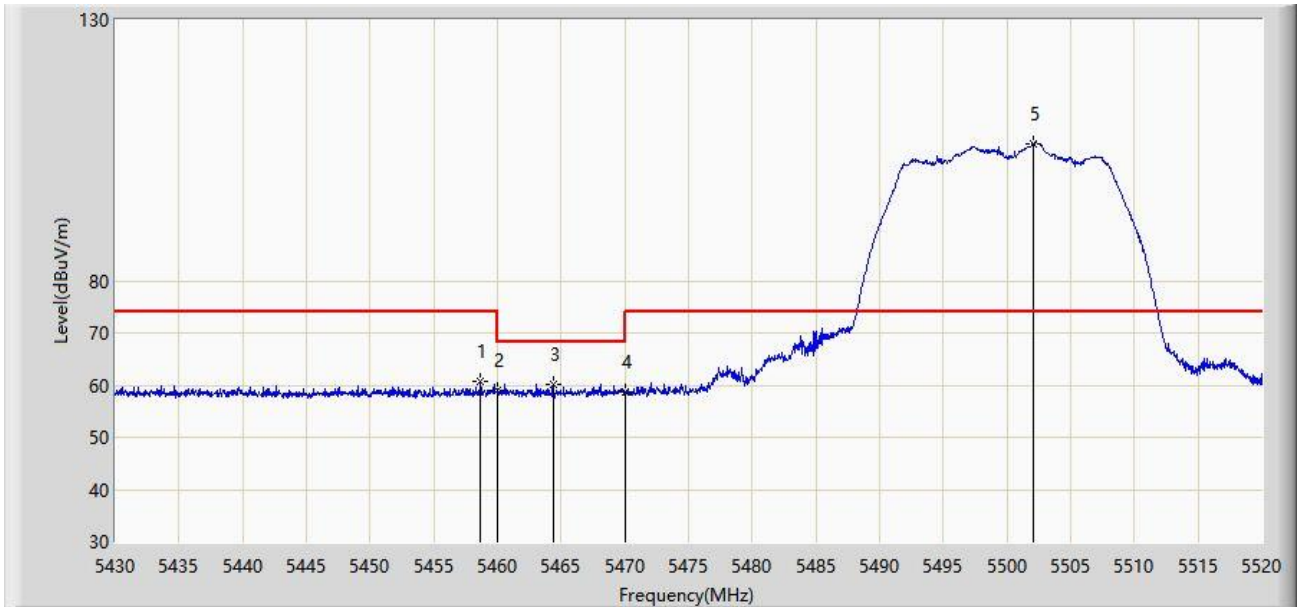

No	Flag	Mark	Frequency (MHz)	Measure Level (dBuV/m)	Reading Level (dBuV)	Margin (dB)	Limit (dBuV/m)	Factor (dB)	Type
1			5458.665	60.775	56.506	-13.225	74.000	4.269	PK
2			5460.000	59.030	54.768	-14.970	74.000	4.261	PK
3			5464.380	60.191	55.955	-8.009	68.200	4.236	PK
4			5470.000	58.669	54.465	-9.531	68.200	4.204	PK
5		*	5502.090	106.257	101.851	N/A	N/A	4.406	PK

Note: Measure Level (dB μ V/m) = Reading Level (dB μ V) + Factor (dB)

Factor (dB) = Cable Loss (dB) + Antenna Factor (dB/m) - Pre_Amplifier Gain (dB)

Site: WZ-AC1	Time: 2021/05/28 - 23:14
Limit: FCC_Part15.209_RE(3m)	Engineer: Tommy Tang
Probe: WZ-AC1_BBHA9120D_1-18GHz	Polarity: Vertical
EUT: WIFI+BT Combo Module	Power: AC 120V/60Hz
Test Mode: Transmit by 802.11a at Channel 5500MHz	

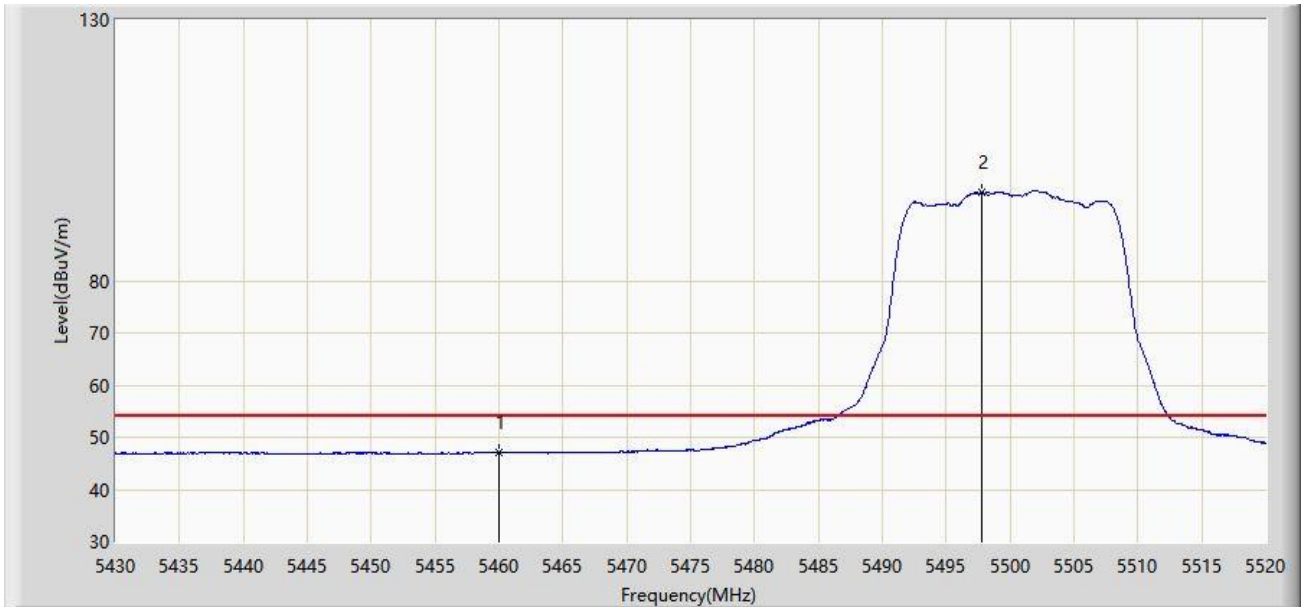

No	Flag	Mark	Frequency (MHz)	Measure Level (dBuV/m)	Reading Level (dBuV)	Margin (dB)	Limit (dBuV/m)	Factor (dB)	Type
1			5460.000	47.105	42.843	-6.895	54.000	4.261	AV
2		*	5497.815	96.926	92.584	N/A	N/A	4.342	AV

Note: Measure Level (dB μ V/m) = Reading Level (dB μ V) + Factor (dB)

Factor (dB) = Cable Loss (dB) + Antenna Factor (dB/m) - Pre_Amplifier Gain (dB)

Site: WZ-AC1	Time: 2021/05/28 - 23:33
Limit: FCC_Part15.209_RE(3m)	Engineer: Tommy Tang
Probe: WZ-AC1_BBHA9120D_1-18GHz	Polarity: Horizontal
EUT: WIFI+BT Combo Module	Power: AC 120V/60Hz
Test Mode: Transmit by 802.11a at Channel 5700MHz	

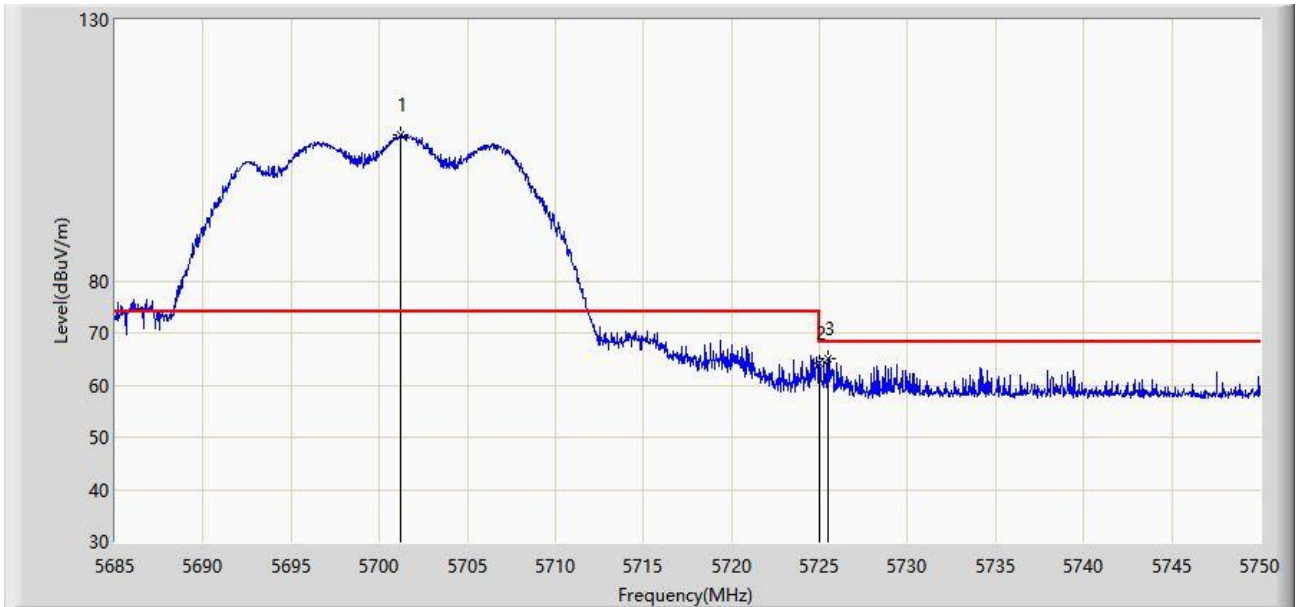

No	Flag	Mark	Frequency (MHz)	Measure Level (dBuV/m)	Reading Level (dBuV)	Margin (dB)	Limit (dBuV/m)	Factor (dB)	Type
1		*	5701.217	107.981	103.434	N/A	N/A	4.547	PK
2			5725.000	64.290	59.779	-3.910	68.200	4.511	PK
3			5725.462	65.129	60.619	-3.071	68.200	4.510	PK

Note: Measure Level (dB μ V/m) = Reading Level (dB μ V) + Factor (dB)

Factor (dB) = Cable Loss (dB) + Antenna Factor (dB/m) - Pre_Amplifier Gain (dB)

Site: WZ-AC1	Time: 2021/05/28 - 23:33
Limit: FCC_Part15.209_RE(3m)	Engineer: Tommy Tang
Probe: WZ-AC1_BBHA9120D_1-18GHz	Polarity: Vertical
EUT: WIFI+BT Combo Module	Power: AC 120V/60Hz
Test Mode: Transmit by 802.11a at Channel 5700MHz	

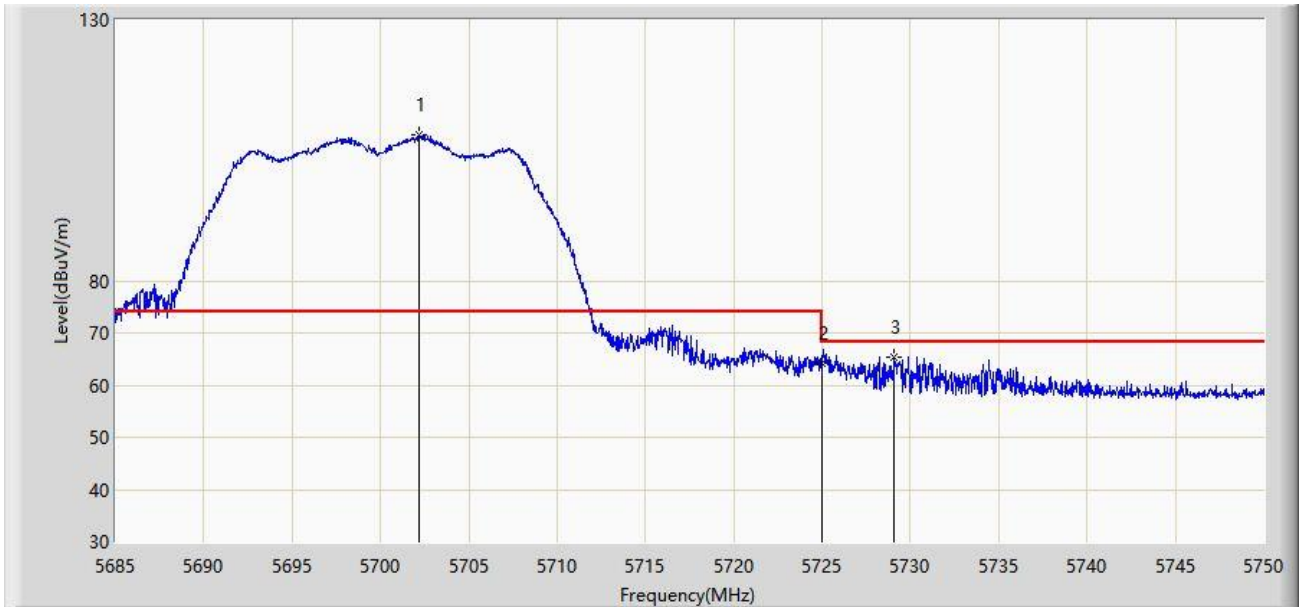

No	Flag	Mark	Frequency (MHz)	Measure Level (dBuV/m)	Reading Level (dBuV)	Margin (dB)	Limit (dBuV/m)	Factor (dB)	Type
1		*	5702.192	107.946	103.403	N/A	N/A	4.543	PK
2			5725.000	64.256	59.745	-3.944	68.200	4.511	PK
3			5729.103	65.385	60.872	-2.815	68.200	4.513	PK

Note: Measure Level (dB μ V/m) = Reading Level (dB μ V) + Factor (dB)

Factor (dB) = Cable Loss (dB) + Antenna Factor (dB/m) - Pre_Amplifier Gain (dB)

Site: WZ-AC1	Time: 2021/05/28 - 23:48
Limit: FCC_Part15.407_RE(3m)	Engineer: Tommy Tang
Probe: WZ-AC1_BBHA9120D_1-18GHz	Polarity: Horizontal
EUT: WIFI+BT Combo Module	Power: AC 120V/60Hz
Test Mode: Transmit by 802.11a at Channel 5745MHz	

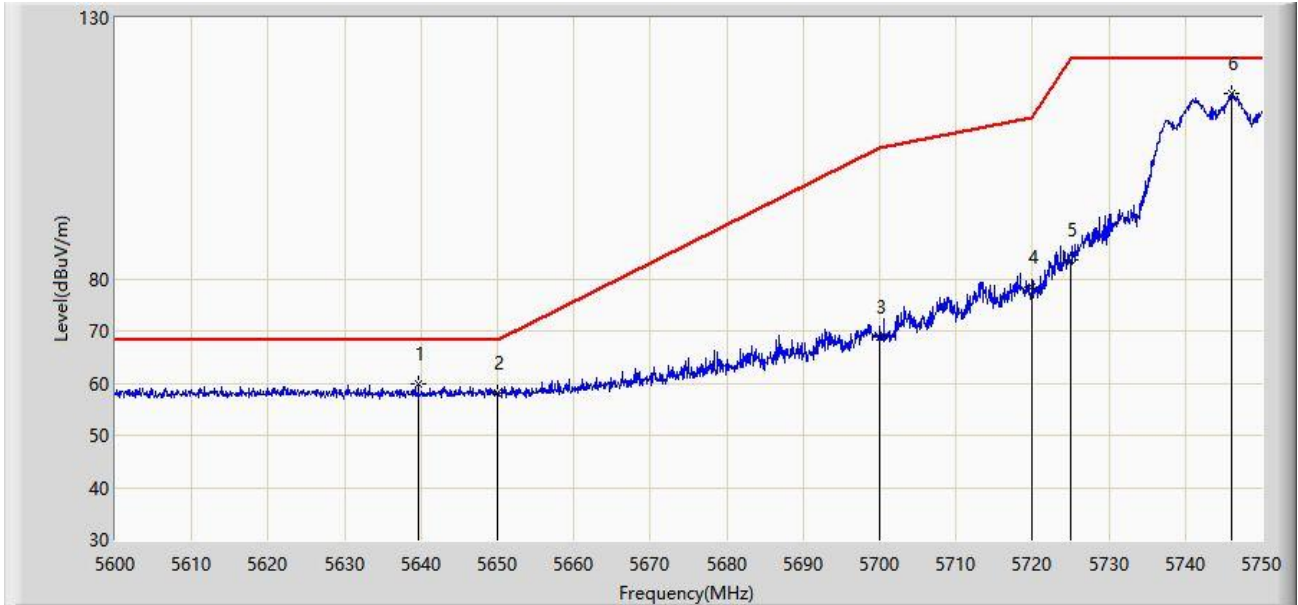

No	Flag	Mark	Frequency (MHz)	Measure Level (dBuV/m)	Reading Level (dBuV)	Margin (dB)	Limit (dBuV/m)	Factor (dB)	Type
1			5639.675	59.967	55.676	-8.233	68.200	4.291	PK
2			5650.000	58.118	53.785	-10.082	68.200	4.333	PK
3			5700.000	68.981	64.429	-36.219	105.200	4.551	PK
4			5720.000	78.542	74.029	-32.258	110.800	4.513	PK
5			5725.000	83.503	78.992	-38.697	122.200	4.511	PK
6		*	5746.025	115.558	111.036	N/A	N/A	4.523	PK

Note: Measure Level (dBμV/m) = Reading Level (dBμV) + Factor (dB)

Factor (dB) = Cable Loss (dB) + Antenna Factor (dB/m) - Pre_Amplifier Gain (dB)

Site: WZ-AC1	Time: 2021/05/28 - 23:50
Limit: FCC_Part15.407_RE(3m)	Engineer: Tommy Tang
Probe: WZ-AC1_BBHA9120D_1-18GHz	Polarity: Vertical
EUT: WIFI+BT Combo Module	Power: AC 120V/60Hz
Test Mode: Transmit by 802.11a at Channel 5745MHz	

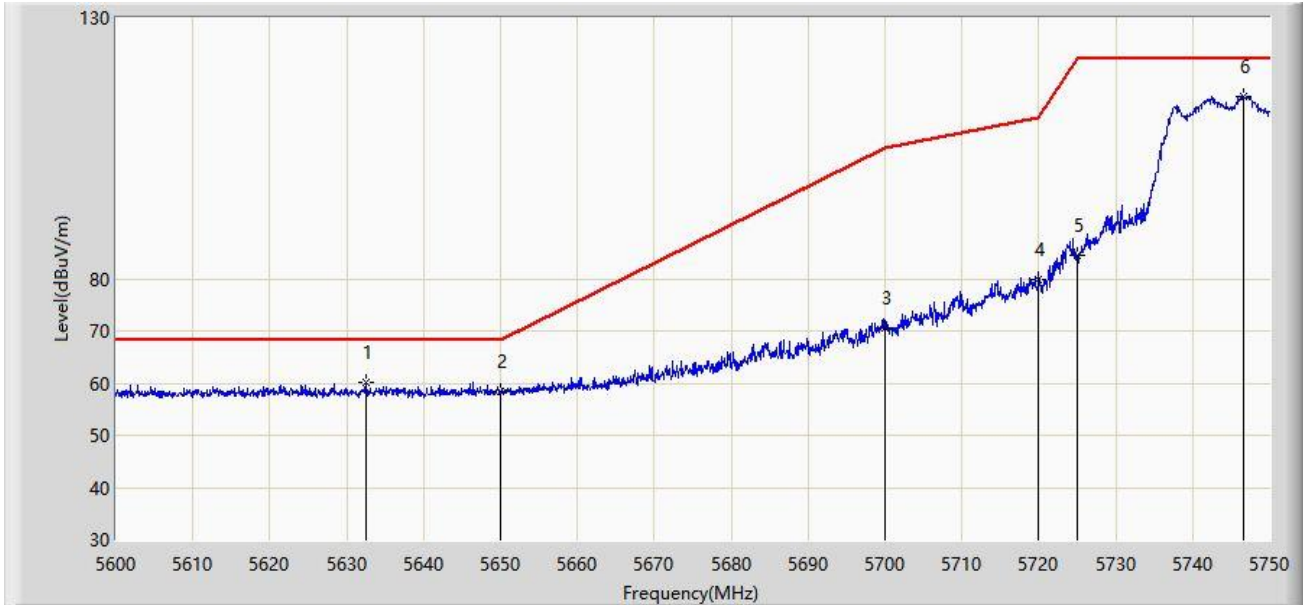

No	Flag	Mark	Frequency (MHz)	Measure Level (dBuV/m)	Reading Level (dBuV)	Margin (dB)	Limit (dBuV/m)	Factor (dB)	Type
1			5632.475	60.061	55.694	-8.139	68.200	4.366	PK
2			5650.000	58.265	53.932	-9.935	68.200	4.333	PK
3			5700.000	70.660	66.108	-34.540	105.200	4.551	PK
4			5720.000	79.911	75.398	-30.889	110.800	4.513	PK
5			5725.000	84.433	79.922	-37.767	122.200	4.511	PK
6		*	5746.550	115.033	110.506	N/A	N/A	4.527	PK

Note: Measure Level (dB μ V/m) = Reading Level (dB μ V) + Factor (dB)

Factor (dB) = Cable Loss (dB) + Antenna Factor (dB/m) - Pre_Amplifier Gain (dB)

Site: WZ-AC1	Time: 2021/05/29 - 00:01
Limit: FCC_Part15.407_RE(3m)	Engineer: Tommy Tang
Probe: WZ-AC1_BBHA9120D_1-18GHz	Polarity: Horizontal
EUT: WIFI+BT Combo Module	Power: AC 120V/60Hz
Test Mode: Transmit by 802.11a at Channel 5825MHz	

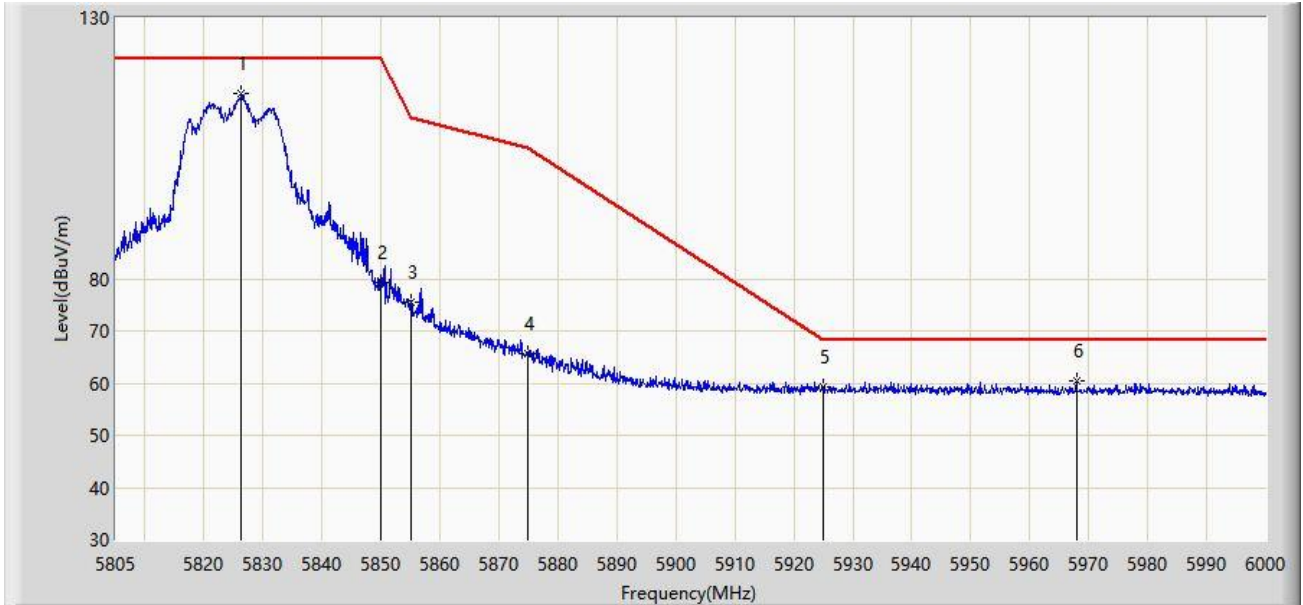

No	Flag	Mark	Frequency (MHz)	Measure Level (dBuV/m)	Reading Level (dBuV)	Margin (dB)	Limit (dBuV/m)	Factor (dB)	Type
1		*	5826.255	115.433	110.722	N/A	N/A	4.711	PK
2			5850.000	79.134	74.339	-43.066	122.200	4.795	PK
3			5855.000	75.592	70.796	-35.208	110.800	4.796	PK
4			5875.000	65.583	60.793	-39.617	105.200	4.790	PK
5			5925.000	59.216	54.153	-8.984	68.200	5.063	PK
6			5967.922	60.330	55.515	-7.870	68.200	4.815	PK

Note: Measure Level (dB μ V/m) = Reading Level (dB μ V) + Factor (dB)

Factor (dB) = Cable Loss (dB) + Antenna Factor (dB/m) - Pre_Amplifier Gain (dB)

Site: WZ-AC1	Time: 2021/05/29 - 00:04
Limit: FCC_Part15.407_RE(3m)	Engineer: Tommy Tang
Probe: WZ-AC1_BBHA9120D_1-18GHz	Polarity: Vertical
EUT: WIFI+BT Combo Module	Power: AC 120V/60Hz
Test Mode: Transmit by 802.11a at Channel 5825MHz	

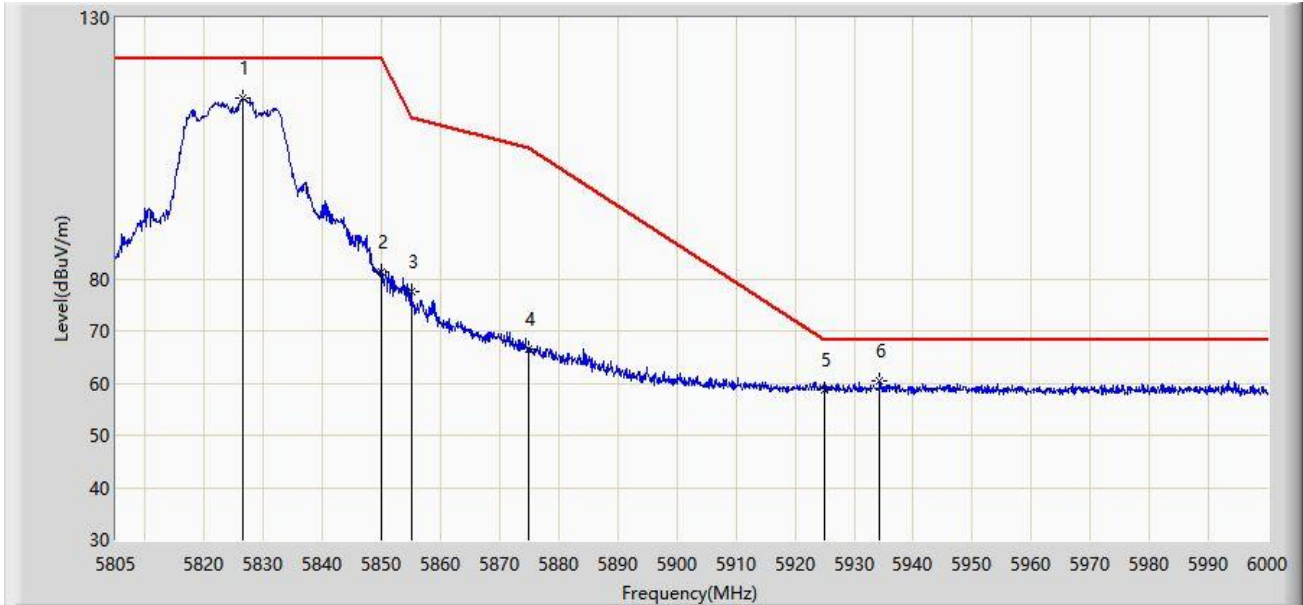

No	Flag	Mark	Frequency (MHz)	Measure Level (dBuV/m)	Reading Level (dBuV)	Margin (dB)	Limit (dBuV/m)	Factor (dB)	Type
1		*	5826.450	114.570	109.858	N/A	N/A	4.712	PK
2			5850.000	81.382	76.587	-40.818	122.200	4.795	PK
3			5855.000	77.594	72.798	-33.206	110.800	4.796	PK
4			5875.000	66.440	61.650	-38.760	105.200	4.790	PK
5			5925.000	58.774	53.711	-9.426	68.200	5.063	PK
6			5934.382	60.369	55.367	-7.831	68.200	5.002	PK

Note: Measure Level (dB μ V/m) = Reading Level (dB μ V) + Factor (dB)

Factor (dB) = Cable Loss (dB) + Antenna Factor (dB/m) - Pre_Amplifier Gain (dB)

Site: WZ-AC1	Time: 2021/05/29 - 00:29
Limit: FCC_Part15.209_RE(3m)	Engineer: Tommy Tang
Probe: WZ-AC1_BBHA9120D_1-18GHz	Polarity: Horizontal
EUT: WIFI+BT Combo Module	Power: AC 120V/60Hz
Test Mode: Transmit by 802.11n-HT20 at Channel 5180MHz	

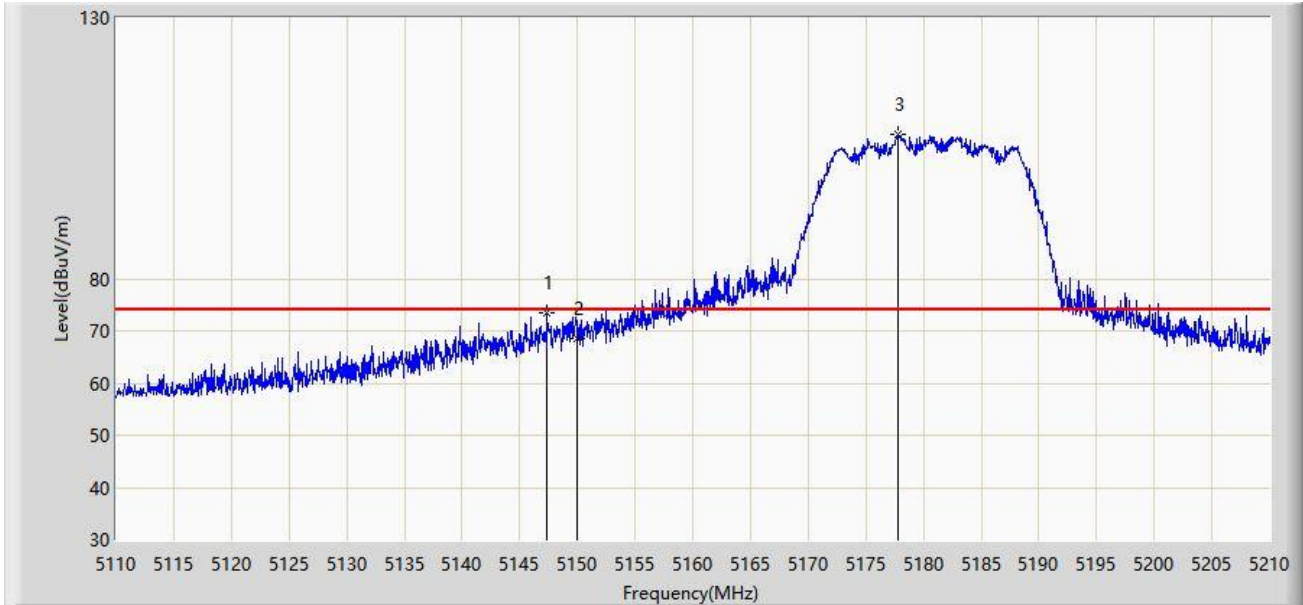

No	Flag	Mark	Frequency (MHz)	Measure Level (dBuV/m)	Reading Level (dBuV)	Margin (dB)	Limit (dBuV/m)	Factor (dB)	Type
1			5147.400	73.364	69.341	-0.636	74.000	4.023	PK
2			5150.000	68.479	64.450	-5.521	74.000	4.029	PK
3		*	5177.850	107.569	103.458	N/A	N/A	4.111	PK

Note: Measure Level (dB μ V/m) = Reading Level (dB μ V) + Factor (dB)

Factor (dB) = Cable Loss (dB) + Antenna Factor (dB/m) - Pre_Amplifier Gain (dB)

Site: WZ-AC1	Time: 2021/05/29 - 00:30
Limit: FCC_Part15.209_RE(3m)	Engineer: Tommy Tang
Probe: WZ-AC1_BBHA9120D_1-18GHz	Polarity: Horizontal
EUT: WIFI+BT Combo Module	Power: AC 120V/60Hz
Test Mode: Transmit by 802.11n-HT20 at Channel 5180MHz	

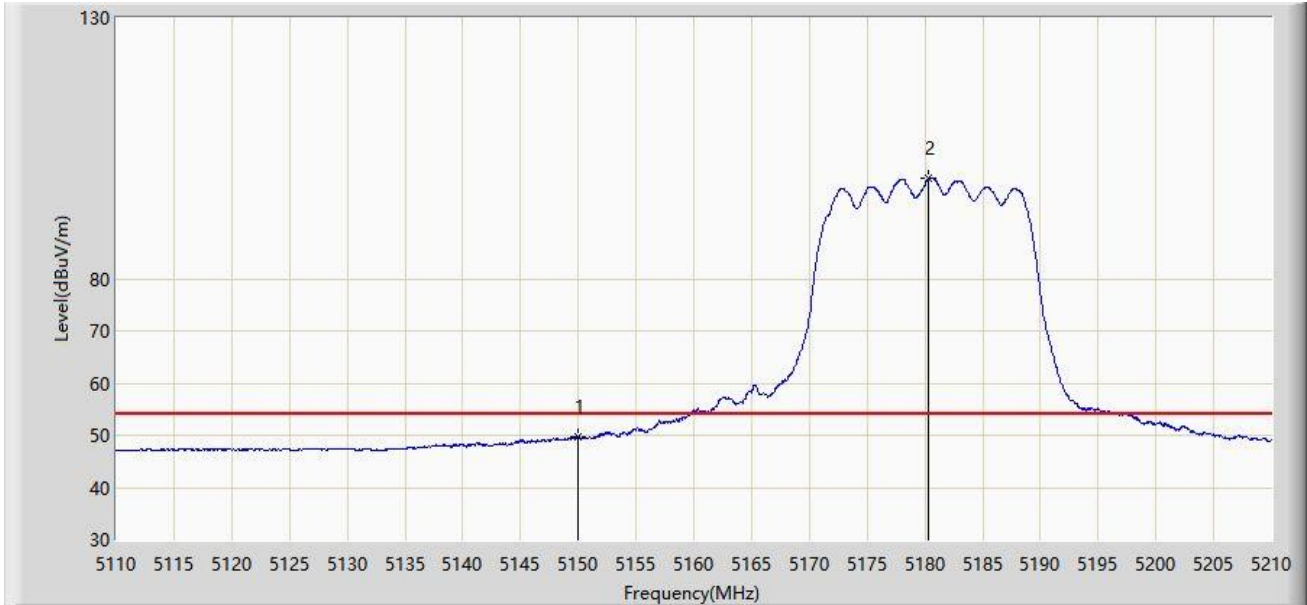

No	Flag	Mark	Frequency (MHz)	Measure Level (dBuV/m)	Reading Level (dBuV)	Margin (dB)	Limit (dBuV/m)	Factor (dB)	Type
1			5150.000	49.752	45.723	-4.248	54.000	4.029	AV
2		*	5180.350	99.199	95.100	N/A	N/A	4.100	AV

Note: Measure Level (dB μ V/m) = Reading Level (dB μ V) + Factor (dB)

Factor (dB) = Cable Loss (dB) + Antenna Factor (dB/m) - Pre_Amplifier Gain (dB)

Site: WZ-AC1	Time: 2021/05/29 - 00:32
Limit: FCC_Part15.209_RE(3m)	Engineer: Tommy Tang
Probe: WZ-AC1_BBHA9120D_1-18GHz	Polarity: Vertical
EUT: WIFI+BT Combo Module	Power: AC 120V/60Hz
Test Mode: Transmit by 802.11n-HT20 at Channel 5180MHz	

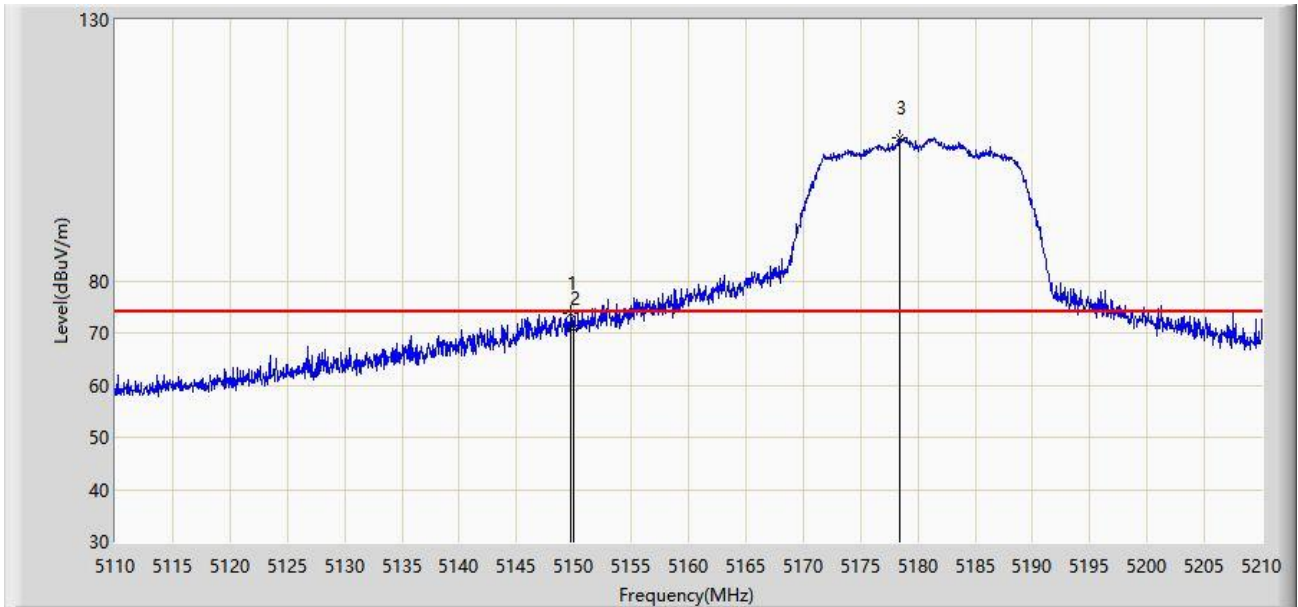

No	Flag	Mark	Frequency (MHz)	Measure Level (dBuV/m)	Reading Level (dBuV)	Margin (dB)	Limit (dBuV/m)	Factor (dB)	Type
1			5149.700	73.634	69.606	-0.366	74.000	4.028	PK
2			5150.000	70.966	66.937	-3.034	74.000	4.029	PK
3		*	5178.450	107.338	103.230	N/A	N/A	4.108	PK

Note: Measure Level (dB μ V/m) = Reading Level (dB μ V) + Factor (dB)

Factor (dB) = Cable Loss (dB) + Antenna Factor (dB/m) - Pre_Amplifier Gain (dB)

Site: WZ-AC1	Time: 2021/05/29 - 00:32
Limit: FCC_Part15.209_RE(3m)	Engineer: Tommy Tang
Probe: WZ-AC1_BBHA9120D_1-18GHz	Polarity: Vertical
EUT: WIFI+BT Combo Module	Power: AC 120V/60Hz
Test Mode: Transmit by 802.11n-HT20 at Channel 5180MHz	

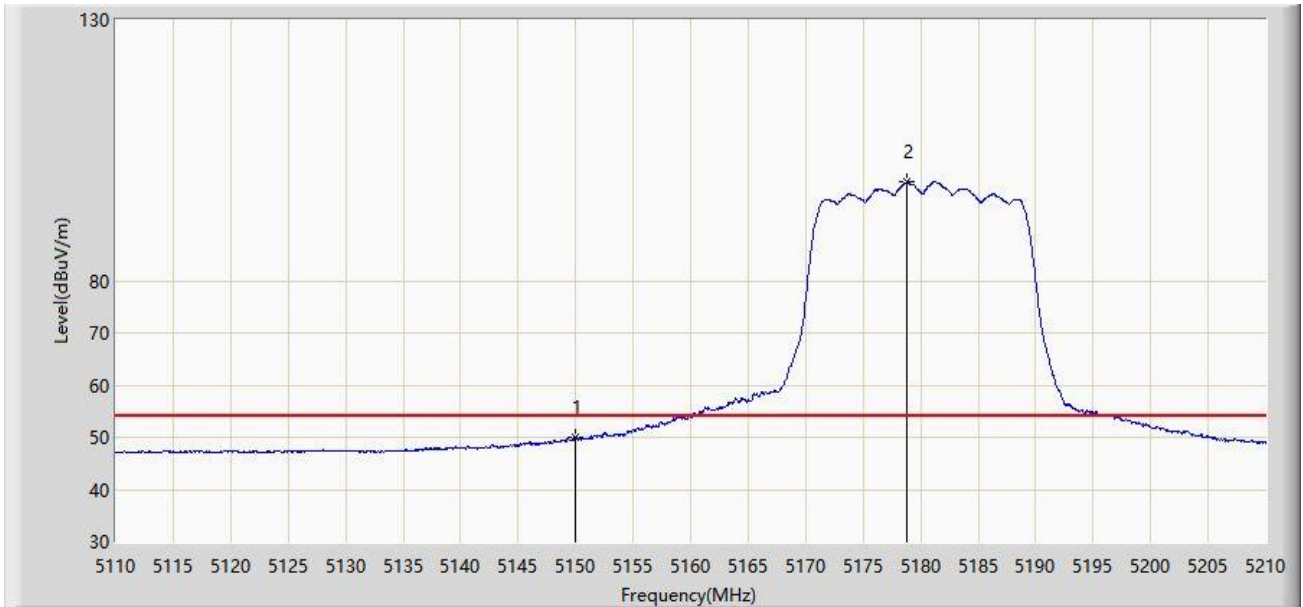

No	Flag	Mark	Frequency (MHz)	Measure Level (dBuV/m)	Reading Level (dBuV)	Margin (dB)	Limit (dBuV/m)	Factor (dB)	Type
1			5150.000	49.929	45.900	-4.071	54.000	4.029	AV
2		*	5178.750	98.855	94.748	N/A	N/A	4.106	AV

Note: Measure Level (dB μ V/m) = Reading Level (dB μ V) + Factor (dB)

Factor (dB) = Cable Loss (dB) + Antenna Factor (dB/m) - Pre_Amplifier Gain (dB)

Site: WZ-AC1	Time: 2021/05/29 - 00:46
Limit: FCC_Part15.209_RE(3m)	Engineer: Tommy Tang
Probe: WZ-AC1_BBHA9120D_1-18GHz	Polarity: Horizontal
EUT: WIFI+BT Combo Module	Power: AC 120V/60Hz
Test Mode: Transmit by 802.11n-HT20 at Channel 5320MHz	

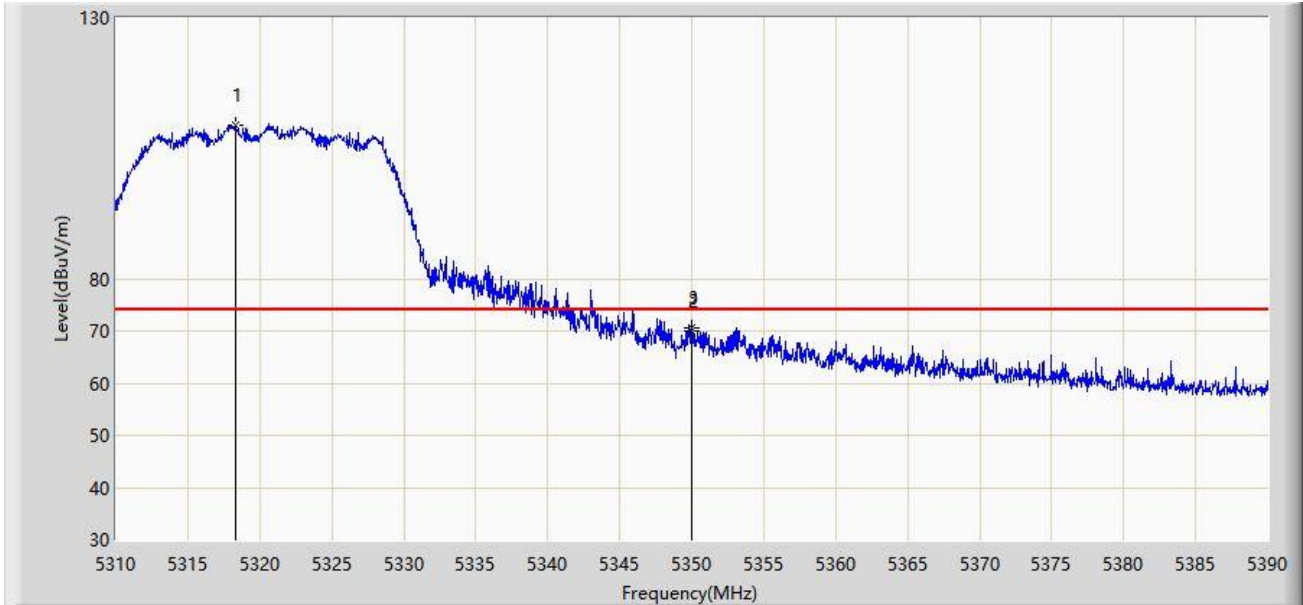

No	Flag	Mark	Frequency (MHz)	Measure Level (dBuV/m)	Reading Level (dBuV)	Margin (dB)	Limit (dBuV/m)	Factor (dB)	Type
1		*	5318.360	109.348	105.539	N/A	N/A	3.809	PK
2			5350.000	69.962	65.945	-4.038	74.000	4.017	PK
3			5350.040	70.503	66.485	-3.497	74.000	4.017	PK

Note: Measure Level (dB μ V/m) = Reading Level (dB μ V) + Factor (dB)

Factor (dB) = Cable Loss (dB) + Antenna Factor (dB/m) - Pre_Amplifier Gain (dB)

Site: WZ-AC1	Time: 2021/05/29 - 00:48
Limit: FCC_Part15.209_RE(3m)	Engineer: Tommy Tang
Probe: WZ-AC1_BBHA9120D_1-18GHz	Polarity: Horizontal
EUT: WIFI+BT Combo Module	Power: AC 120V/60Hz
Test Mode: Transmit by 802.11n-HT20 at Channel 5320MHz	

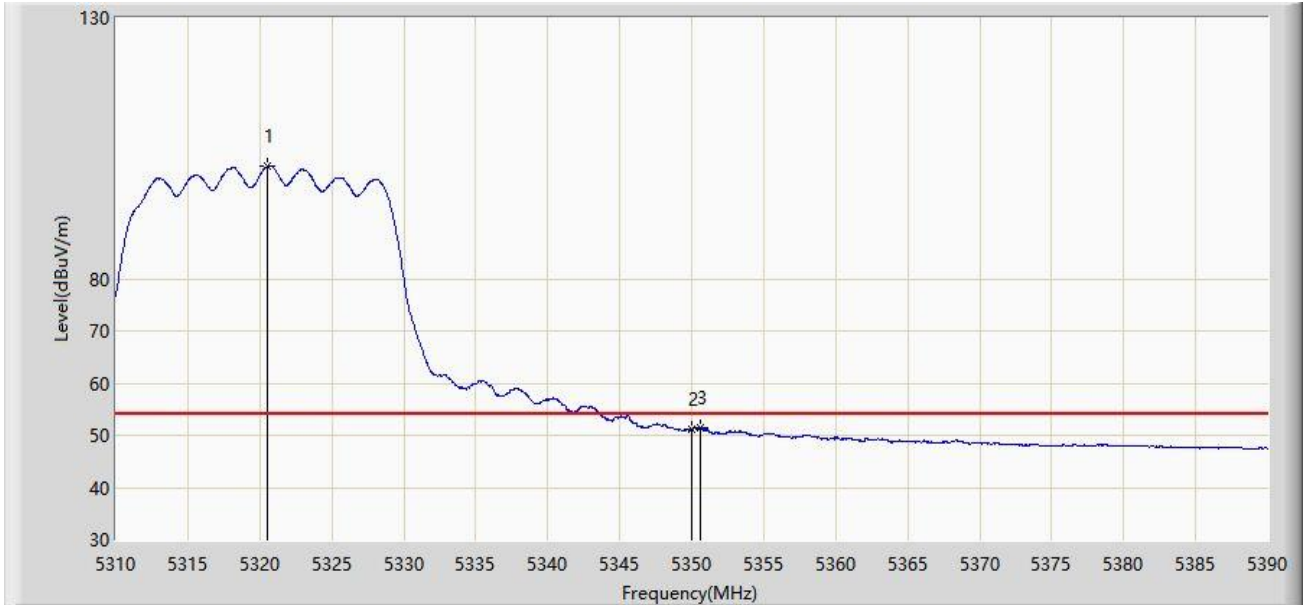

No	Flag	Mark	Frequency (MHz)	Measure Level (dBuV/m)	Reading Level (dBuV)	Margin (dB)	Limit (dBuV/m)	Factor (dB)	Type
1		*	5320.520	101.594	97.777	N/A	N/A	3.817	AV
2			5350.000	51.102	47.085	-2.898	54.000	4.017	AV
3			5350.640	51.399	47.378	-2.601	54.000	4.022	AV

Note: Measure Level (dB μ V/m) = Reading Level (dB μ V) + Factor (dB)

Factor (dB) = Cable Loss (dB) + Antenna Factor (dB/m) - Pre_Amplifier Gain (dB)

Site: WZ-AC1	Time: 2021/05/29 - 00:50
Limit: FCC_Part15.209_RE(3m)	Engineer: Tommy Tang
Probe: WZ-AC1_BBHA9120D_1-18GHz	Polarity: Vertical
EUT: WIFI+BT Combo Module	Power: AC 120V/60Hz
Test Mode: Transmit by 802.11n-HT20 at Channel 5320MHz	

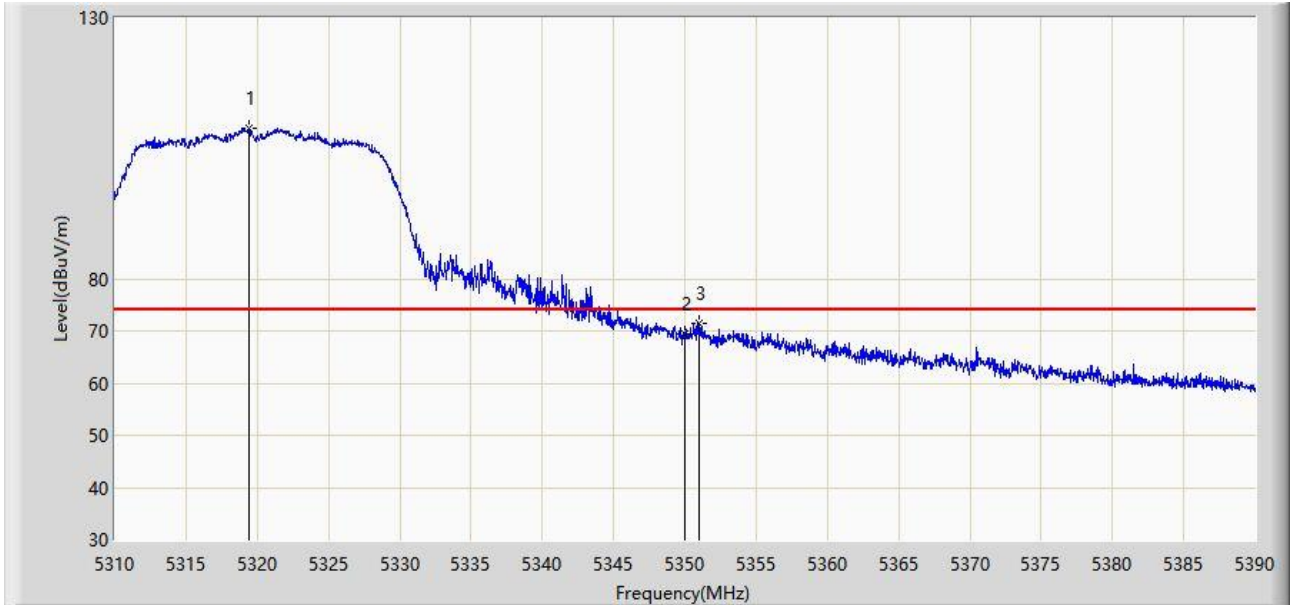

No	Flag	Mark	Frequency (MHz)	Measure Level (dBuV/m)	Reading Level (dBuV)	Margin (dB)	Limit (dBuV/m)	Factor (dB)	Type
1		*	5319.440	108.776	104.963	N/A	N/A	3.813	PK
2			5350.000	69.530	65.513	-4.470	74.000	4.017	PK
3			5351.040	71.504	67.480	-2.496	74.000	4.024	PK

Note: Measure Level (dB μ V/m) = Reading Level (dB μ V) + Factor (dB)

Factor (dB) = Cable Loss (dB) + Antenna Factor (dB/m) - Pre_Amplifier Gain (dB)

Site: WZ-AC1	Time: 2021/05/29 - 00:50
Limit: FCC_Part15.209_RE(3m)	Engineer: Tommy Tang
Probe: WZ-AC1_BBHA9120D_1-18GHz	Polarity: Vertical
EUT: WIFI+BT Combo Module	Power: AC 120V/60Hz
Test Mode: Transmit by 802.11n-HT20 at Channel 5320MHz	

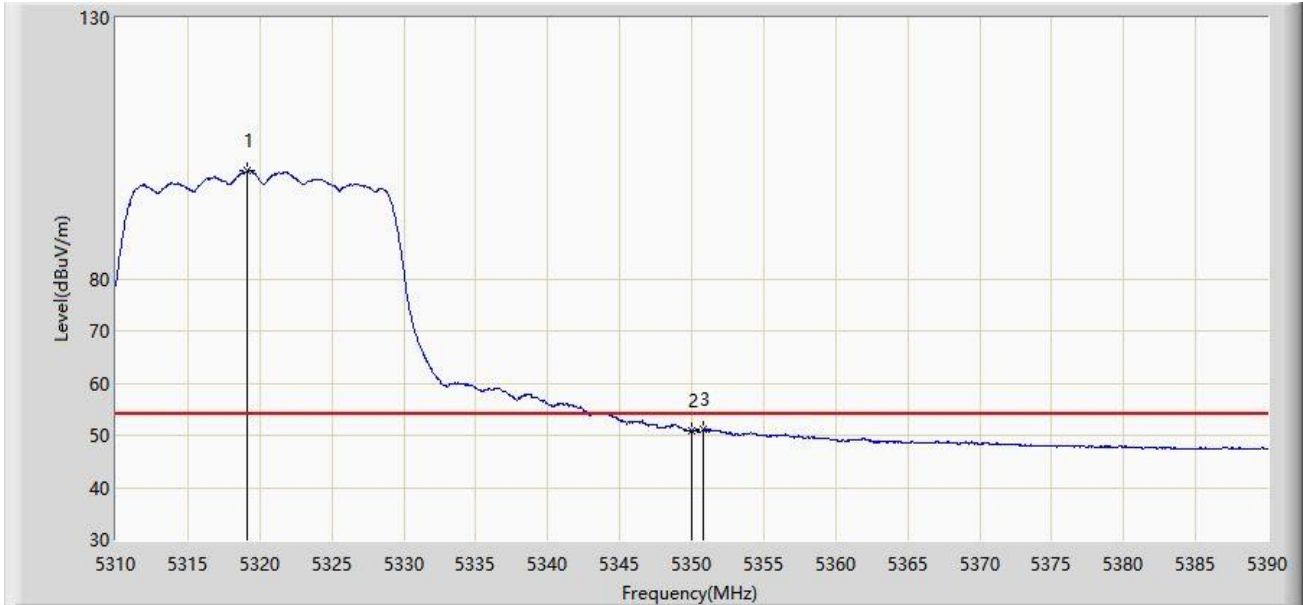

No	Flag	Mark	Frequency (MHz)	Measure Level (dBuV/m)	Reading Level (dBuV)	Margin (dB)	Limit (dBuV/m)	Factor (dB)	Type
1		*	5319.160	100.679	96.867	N/A	N/A	3.811	AV
2			5350.000	50.902	46.885	-3.098	54.000	4.017	AV
3			5350.840	51.079	47.057	-2.921	54.000	4.023	AV

Note: Measure Level (dB μ V/m) = Reading Level (dB μ V) + Factor (dB)

Factor (dB) = Cable Loss (dB) + Antenna Factor (dB/m) - Pre_Amplifier Gain (dB)

Site: WZ-AC1	Time: 2021/05/29 - 01:08
Limit: FCC_Part15.209_RE(3m)	Engineer: Tommy Tang
Probe: WZ-AC1_BBHA9120D_1-18GHz	Polarity: Horizontal
EUT: WIFI+BT Combo Module	Power: AC 120V/60Hz
Test Mode: Transmit by 802.11n-HT20 at Channel 5500MHz	

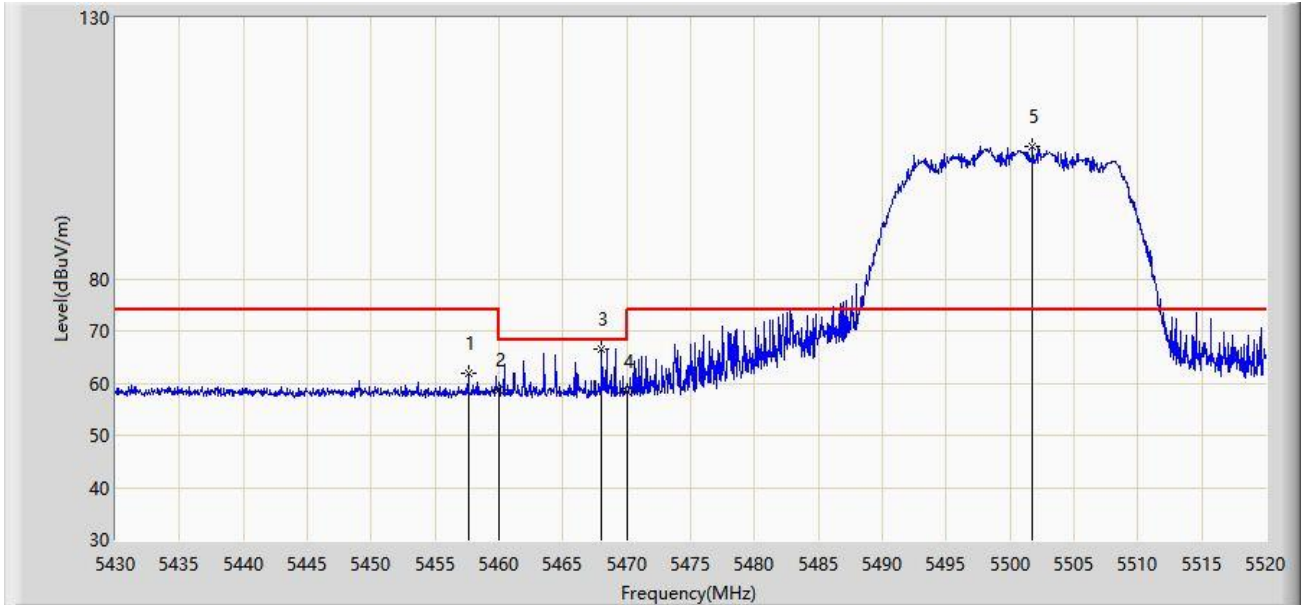

No	Flag	Mark	Frequency (MHz)	Measure Level (dBuV/m)	Reading Level (dBuV)	Margin (dB)	Limit (dBuV/m)	Factor (dB)	Type
1			5457.585	61.884	57.609	-12.116	74.000	4.276	PK
2			5460.000	58.755	54.493	-15.245	74.000	4.261	PK
3			5468.025	66.602	62.386	-1.598	68.200	4.215	PK
4			5470.000	58.288	54.084	-9.912	68.200	4.204	PK
5		*	5501.775	105.503	101.102	N/A	N/A	4.401	PK

Note: Measure Level (dB μ V/m) = Reading Level (dB μ V) + Factor (dB)

Factor (dB) = Cable Loss (dB) + Antenna Factor (dB/m) - Pre_Amplifier Gain (dB)

Site: WZ-AC1	Time: 2021/05/29 - 01:11
Limit: FCC_Part15.209_RE(3m)	Engineer: Tommy Tang
Probe: WZ-AC1_BBHA9120D_1-18GHz	Polarity: Horizontal
EUT: WIFI+BT Combo Module	Power: AC 120V/60Hz
Test Mode: Transmit by 802.11n-HT20 at Channel 5500MHz	

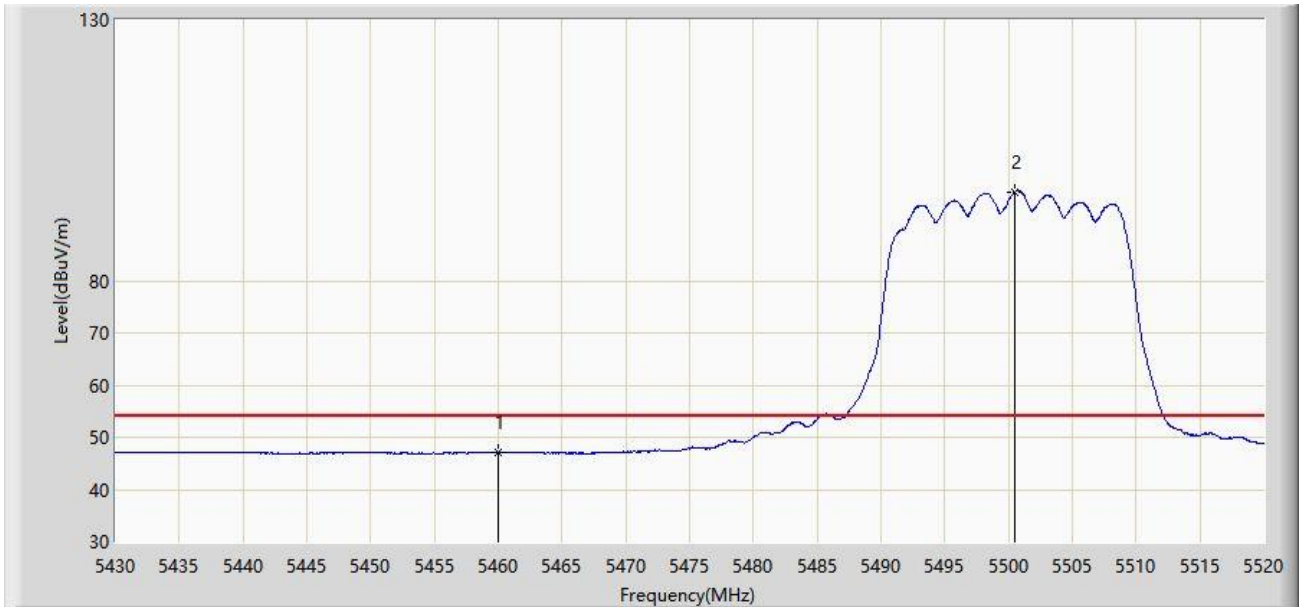

No	Flag	Mark	Frequency (MHz)	Measure Level (dBuV/m)	Reading Level (dBuV)	Margin (dB)	Limit (dBuV/m)	Factor (dB)	Type
1			5460.000	47.068	42.806	-6.932	54.000	4.261	AV
2		*	5500.470	97.017	92.635	N/A	N/A	4.381	AV

Note: Measure Level (dB μ V/m) = Reading Level (dB μ V) + Factor (dB)

Factor (dB) = Cable Loss (dB) + Antenna Factor (dB/m) - Pre_Amplifier Gain (dB)

Site: WZ-AC1	Time: 2021/05/29 - 01:52
Limit: FCC_Part15.209_RE(3m)	Engineer: Tommy Tang
Probe: WZ-AC1_BBHA9120D_1-18GHz	Polarity: Vertical
EUT: WIFI+BT Combo Module	Power: AC 120V/60Hz
Test Mode: Transmit by 802.11n-HT20 at Channel 5500MHz	

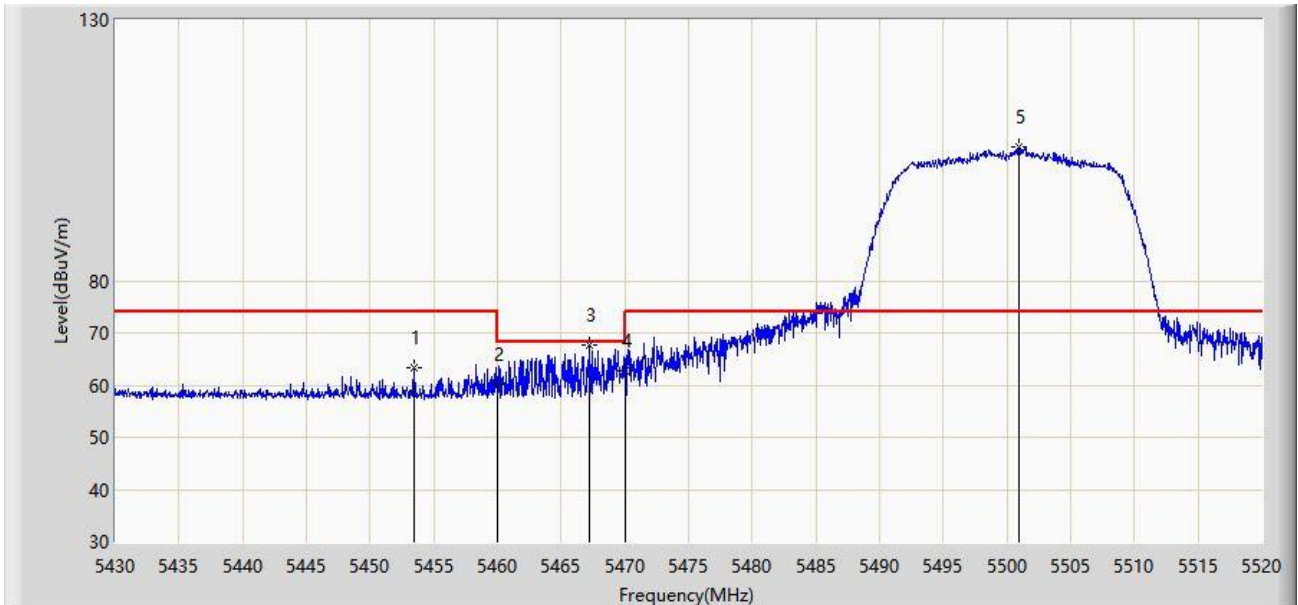

No	Flag	Mark	Frequency (MHz)	Measure Level (dBuV/m)	Reading Level (dBuV)	Margin (dB)	Limit (dBuV/m)	Factor (dB)	Type
1			5453.445	63.462	59.160	-10.538	74.000	4.301	PK
2			5460.000	60.228	55.966	-13.772	74.000	4.261	PK
3			5467.170	67.551	63.331	-0.649	68.200	4.221	PK
4			5470.000	62.732	58.528	-5.468	68.200	4.204	PK
5		*	5500.965	105.687	101.298	N/A	N/A	4.389	PK

Note: Measure Level (dBuV/m) = Reading Level (dBuV) + Factor (dB)

Factor (dB) = Cable Loss (dB) + Antenna Factor (dB/m) - Pre_Amplifier Gain (dB)

Site: WZ-AC1	Time: 2021/05/29 - 01:52
Limit: FCC_Part15.209_RE(3m)	Engineer: Tommy Tang
Probe: WZ-AC1_BBHA9120D_1-18GHz	Polarity: Vertical
EUT: WIFI+BT Combo Module	Power: AC 120V/60Hz
Test Mode: Transmit by 802.11n-HT20 at Channel 5500MHz	

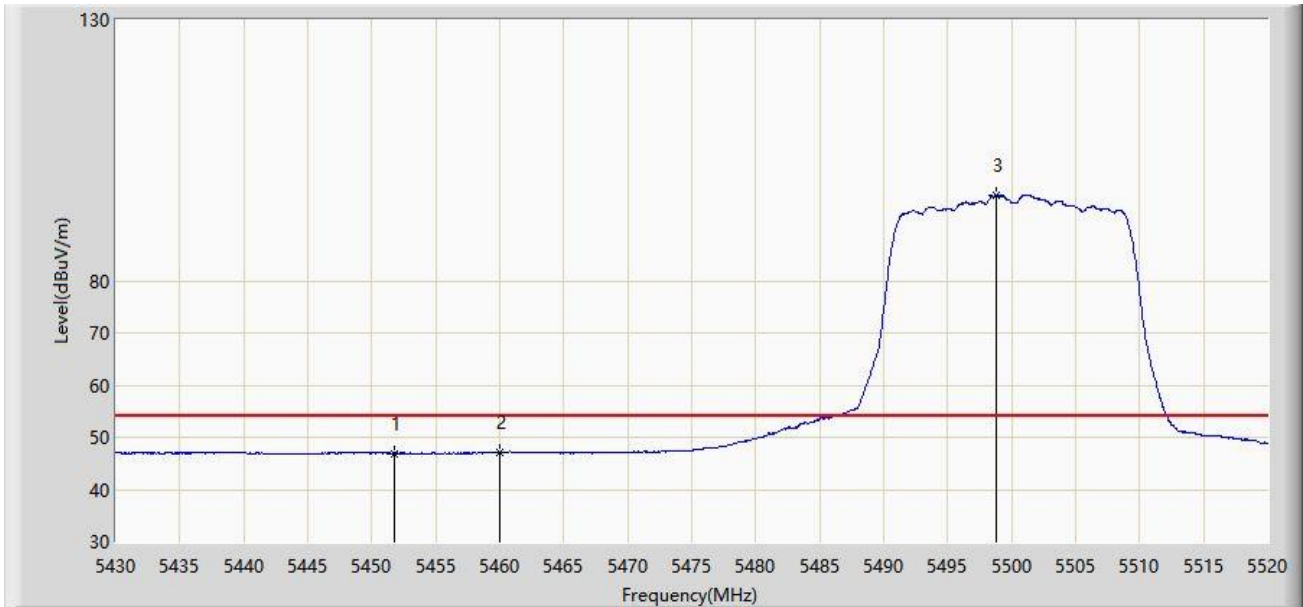

No	Flag	Mark	Frequency (MHz)	Measure Level (dBuV/m)	Reading Level (dBuV)	Margin (dB)	Limit (dBuV/m)	Factor (dB)	Type
1			5451.735	46.952	42.644	-7.048	54.000	4.308	AV
2			5460.000	47.071	42.809	-6.929	54.000	4.261	AV
3		*	5498.805	96.332	91.975	N/A	N/A	4.357	AV

Note: Measure Level (dB μ V/m) = Reading Level (dB μ V) + Factor (dB)

Factor (dB) = Cable Loss (dB) + Antenna Factor (dB/m) - Pre_Amplifier Gain (dB)

Site: WZ-AC1	Time: 2021/05/29 - 02:01
Limit: FCC_Part15.209_RE(3m)	Engineer: Tommy Tang
Probe: WZ-AC1_BBHA9120D_1-18GHz	Polarity: Horizontal
EUT: WIFI+BT Combo Module	Power: AC 120V/60Hz
Test Mode: Transmit by 802.11n-HT20 at Channel 5700MHz	

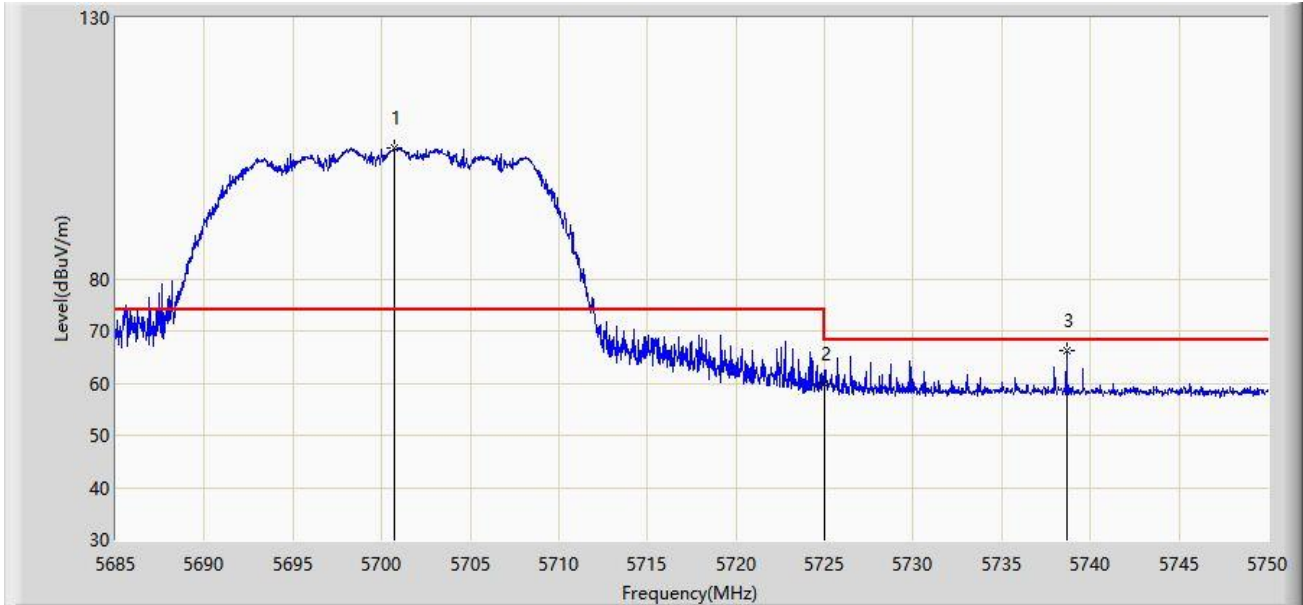

No	Flag	Mark	Frequency (MHz)	Measure Level (dBuV/m)	Reading Level (dBuV)	Margin (dB)	Limit (dBuV/m)	Factor (dB)	Type
1		*	5700.697	105.033	100.484	N/A	N/A	4.548	PK
2			5725.000	59.790	55.279	-8.410	68.200	4.511	PK
3			5738.658	66.284	61.778	-1.916	68.200	4.506	PK

Note: Measure Level (dB μ V/m) = Reading Level (dB μ V) + Factor (dB)

Factor (dB) = Cable Loss (dB) + Antenna Factor (dB/m) - Pre_Amplifier Gain (dB)

Site: WZ-AC1	Time: 2021/05/29 - 02:03
Limit: FCC_Part15.209_RE(3m)	Engineer: Tommy Tang
Probe: WZ-AC1_BBHA9120D_1-18GHz	Polarity: Vertical
EUT: WIFI+BT Combo Module	Power: AC 120V/60Hz
Test Mode: Transmit by 802.11n-HT20 at Channel 5700MHz	

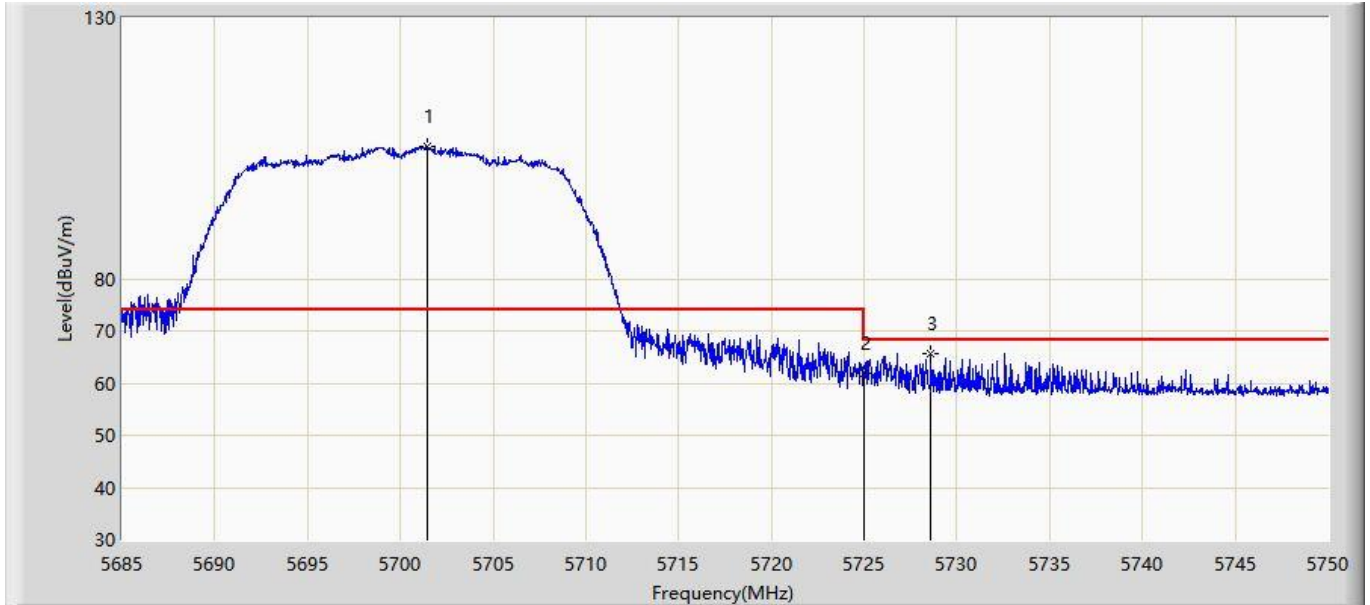

No	Flag	Mark	Frequency (MHz)	Measure Level (dBuV/m)	Reading Level (dBuV)	Margin (dB)	Limit (dBuV/m)	Factor (dB)	Type
1		*	5701.413	105.367	100.821	N/A	N/A	4.546	PK
2			5725.000	61.873	57.362	-6.327	68.200	4.511	PK
3			5728.615	65.621	61.107	-2.579	68.200	4.514	PK

Note: Measure Level (dB μ V/m) = Reading Level (dB μ V) + Factor (dB)

Factor (dB) = Cable Loss (dB) + Antenna Factor (dB/m) - Pre_Amplifier Gain (dB)

Site: WZ-AC1	Time: 2021/05/29 - 02:17
Limit: FCC_Part15.407_RE(3m)	Engineer: Tommy Tang
Probe: WZ-AC1_BBHA9120D_1-18GHz	Polarity: Horizontal
EUT: WIFI+BT Combo Module	Power: AC 120V/60Hz
Test Mode: Transmit by 802.11n-HT20 at Channel 5745MHz	

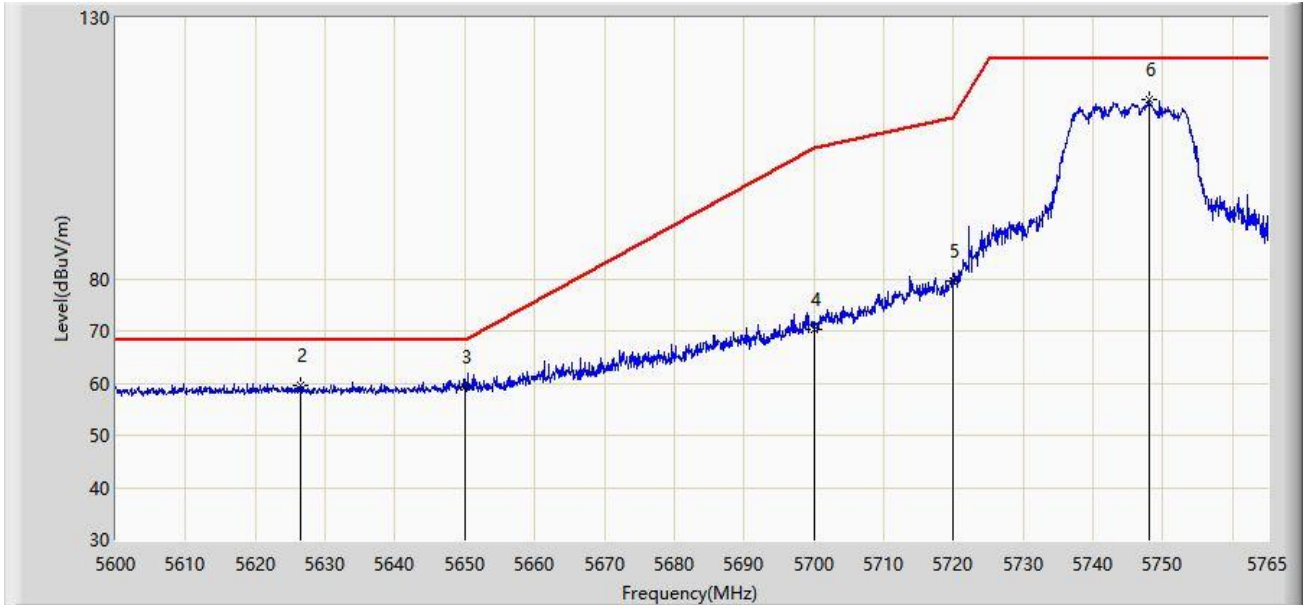

No	Flag	Mark	Frequency (MHz)	Measure Level (dBuV/m)	Reading Level (dBuV)	Margin (dB)	Limit (dBuV/m)	Factor (dB)	Type
1			725.000	59.238	67.862	NaN	NaN	-8.624	PK
2			5626.400	59.676	55.219	-8.524	68.200	4.456	PK
3			5650.000	59.174	54.841	-9.026	68.200	4.333	PK
4			5700.000	70.392	65.840	-34.808	105.200	4.551	PK
5			5720.000	79.464	74.951	-31.336	110.800	4.513	PK
6		*	5748.005	114.262	109.719	N/A	N/A	4.543	PK

Note: Measure Level (dB μ V/m) = Reading Level (dB μ V) + Factor (dB)

Factor (dB) = Cable Loss (dB) + Antenna Factor (dB/m) - Pre_Amplifier Gain (dB)

Site: WZ-AC1	Time: 2021/05/29 - 02:39
Limit: FCC_Part15.407_RE(3m)	Engineer: Tommy Tang
Probe: WZ-AC1_BBHA9120D_1-18GHz	Polarity: Vertical
EUT: WIFI+BT Combo Module	Power: AC 120V/60Hz
Test Mode: Transmit by 802.11n-HT20 at Channel 5745MHz	

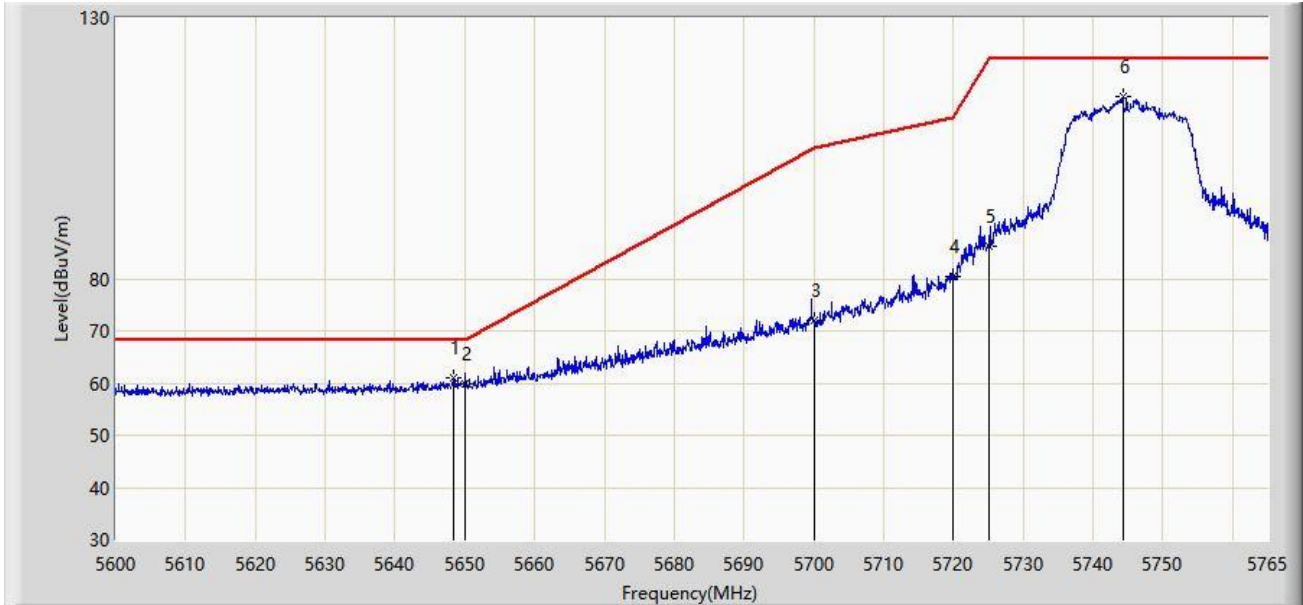

No	Flag	Mark	Frequency (MHz)	Measure Level (dBuV/m)	Reading Level (dBuV)	Margin (dB)	Limit (dBuV/m)	Factor (dB)	Type
1		*	5648.345	61.055	56.731	-7.145	68.200	4.324	PK
2			5650.000	59.742	55.409	-8.458	68.200	4.333	PK
3			5700.000	71.963	67.411	-33.237	105.200	4.551	PK
4			5720.000	80.578	76.065	-30.222	110.800	4.513	PK
5			5725.000	86.151	81.640	-36.049	122.200	4.511	PK
6			5744.292	114.811	110.307	N/A	N/A	4.504	PK

Note: Measure Level (dB μ V/m) = Reading Level (dB μ V) + Factor (dB)

Factor (dB) = Cable Loss (dB) + Antenna Factor (dB/m) - Pre_Amplifier Gain (dB)

Site: WZ-AC1	Time: 2021/05/29 - 02:51
Limit: FCC_Part15.407_RE(3m)	Engineer: Tommy Tang
Probe: WZ-AC1_BBHA9120D_1-18GHz	Polarity: Horizontal
EUT: WIFI+BT Combo Module	Power: AC 120V/60Hz
Test Mode: Transmit by 802.11n-HT20 at Channel 5825MHz	

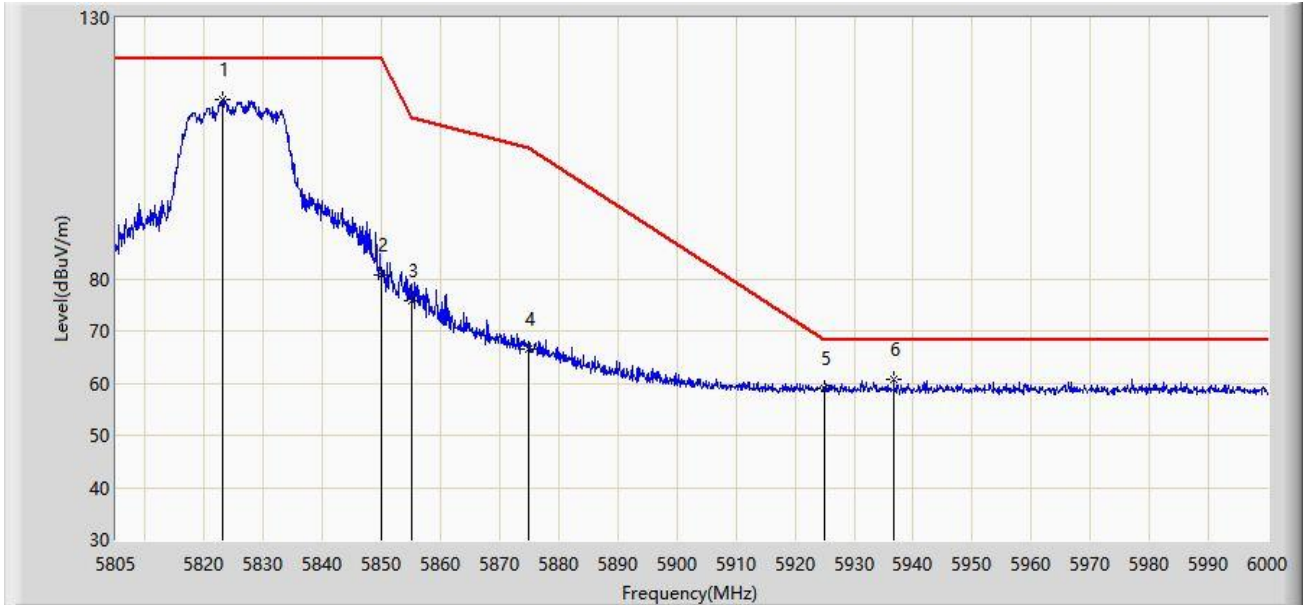

No	Flag	Mark	Frequency (MHz)	Measure Level (dBuV/m)	Reading Level (dBuV)	Margin (dB)	Limit (dBuV/m)	Factor (dB)	Type
1			5823.038	114.399	109.705	N/A	N/A	4.694	PK
2			5850.000	80.606	75.811	-41.594	122.200	4.795	PK
3			5855.000	75.870	71.074	-34.930	110.800	4.796	PK
4			5875.000	66.652	61.862	-38.548	105.200	4.790	PK
5			5925.000	58.853	53.790	-9.347	68.200	5.063	PK
6		*	5936.723	60.739	55.765	-7.461	68.200	4.974	PK

Note: Measure Level (dB μ V/m) = Reading Level (dB μ V) + Factor (dB)

Factor (dB) = Cable Loss (dB) + Antenna Factor (dB/m) - Pre_Amplifier Gain (dB)

Site: WZ-AC1	Time: 2021/05/29 - 02:55
Limit: FCC_Part15.407_RE(3m)	Engineer: Tommy Tang
Probe: WZ-AC1_BBHA9120D_1-18GHz	Polarity: Vertical
EUT: WIFI+BT Combo Module	Power: AC 120V/60Hz
Test Mode: Transmit by 802.11n-HT20 at Channel 5825MHz	

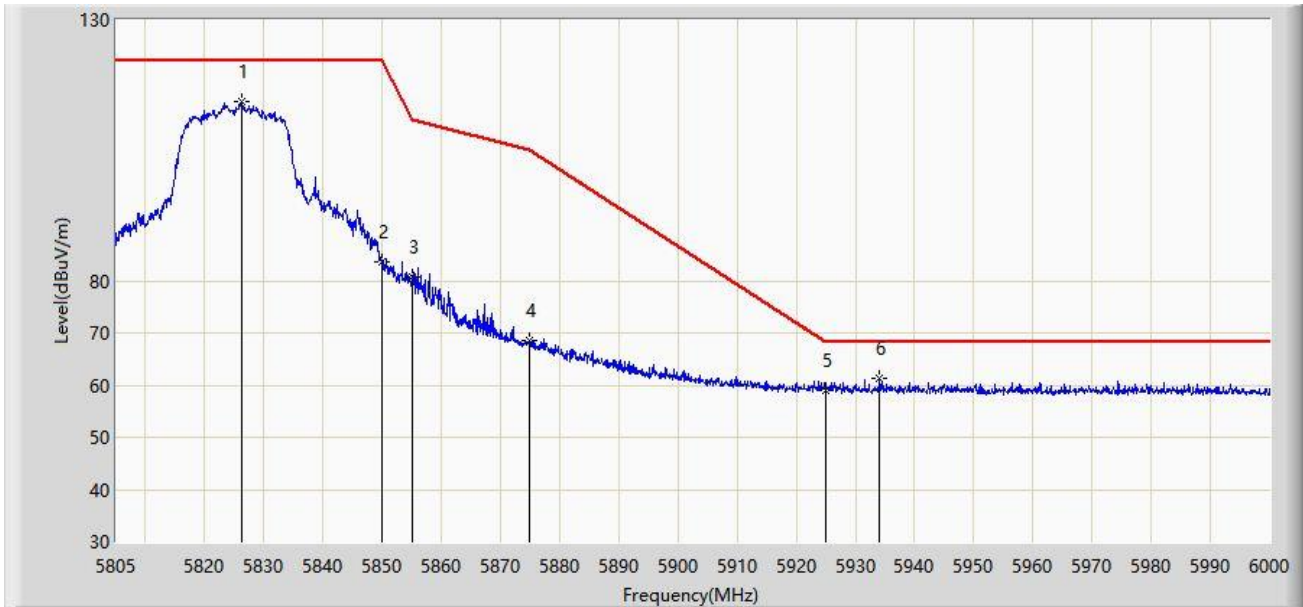

No	Flag	Mark	Frequency (MHz)	Measure Level (dBuV/m)	Reading Level (dBuV)	Margin (dB)	Limit (dBuV/m)	Factor (dB)	Type
1			5826.255	114.455	109.744	N/A	N/A	4.711	PK
2			5850.000	83.494	78.699	-38.706	122.200	4.795	PK
3			5855.000	80.624	75.828	-30.176	110.800	4.796	PK
4			5875.000	68.585	63.795	-36.615	105.200	4.790	PK
5			5925.000	59.043	53.980	-9.157	68.200	5.063	PK
6		*	5934.090	61.170	56.164	-7.030	68.200	5.006	PK

Note: Measure Level (dB μ V/m) = Reading Level (dB μ V) + Factor (dB)

Factor (dB) = Cable Loss (dB) + Antenna Factor (dB/m) - Pre_Amplifier Gain (dB)

Site: WZ-AC1	Time: 2021/05/29 - 03:10
Limit: FCC_Part15.209_RE(3m)	Engineer: Tommy Tang
Probe: WZ-AC1_BBHA9120D_1-18GHz	Polarity: Horizontal
EUT: WIFI+BT Combo Module	Power: AC 120V/60Hz
Test Mode: Transmit by 802.11n-HT40 at Channel 5190MHz	

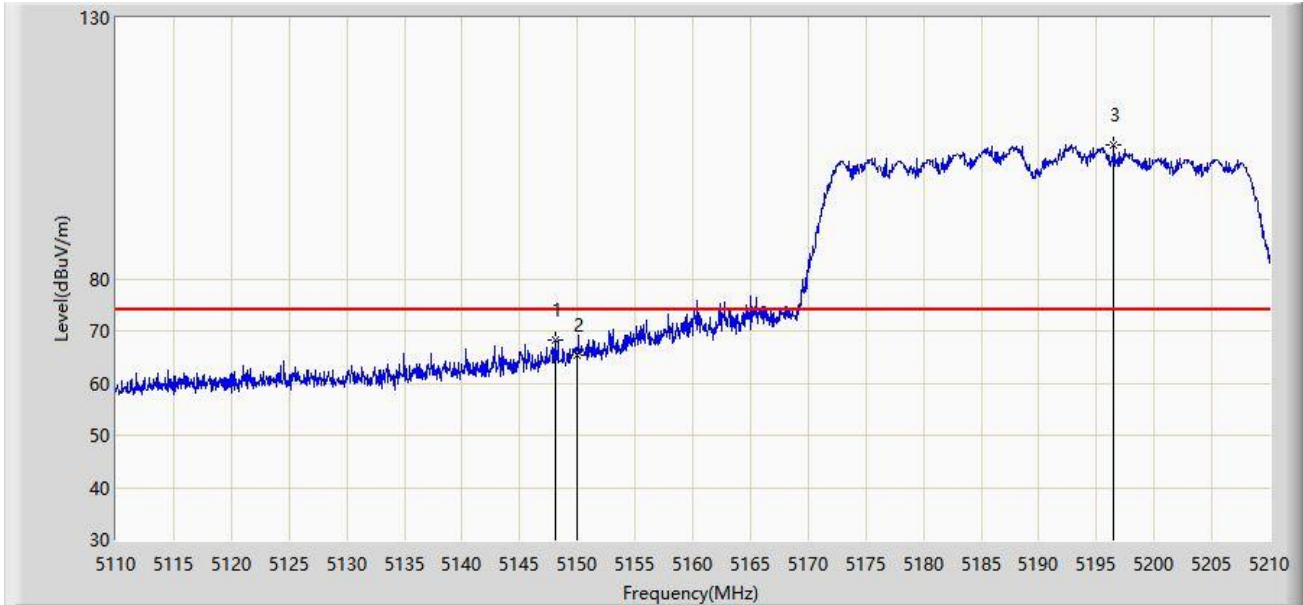

No	Flag	Mark	Frequency (MHz)	Measure Level (dBuV/m)	Reading Level (dBuV)	Margin (dB)	Limit (dBuV/m)	Factor (dB)	Type
1			5148.150	68.352	64.331	-5.648	74.000	4.022	PK
2			5150.000	65.302	61.273	-8.698	74.000	4.029	PK
3		*	5196.500	105.631	101.578	N/A	N/A	4.054	PK

Note: Measure Level (dB μ V/m) = Reading Level (dB μ V) + Factor (dB)

Factor (dB) = Cable Loss (dB) + Antenna Factor (dB/m) - Pre_Amplifier Gain (dB)

Site: WZ-AC1	Time: 2021/05/29 - 03:13
Limit: FCC_Part15.209_RE(3m)	Engineer: Tommy Tang
Probe: WZ-AC1_BBHA9120D_1-18GHz	Polarity: Horizontal
EUT: WIFI+BT Combo Module	Power: AC 120V/60Hz
Test Mode: Transmit by 802.11n-HT40 at Channel 5190MHz	

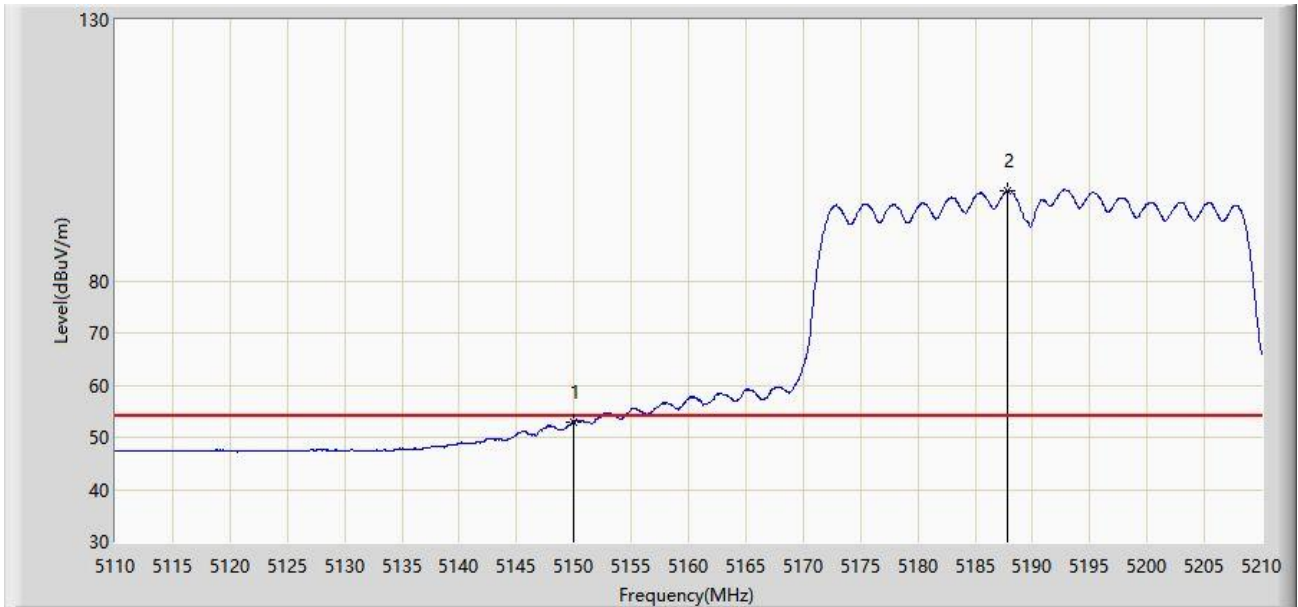

No	Flag	Mark	Frequency (MHz)	Measure Level (dBuV/m)	Reading Level (dBuV)	Margin (dB)	Limit (dBuV/m)	Factor (dB)	Type
1			5150.000	52.942	48.913	-1.058	54.000	4.029	AV
2		*	5187.850	97.237	93.200	N/A	N/A	4.038	AV

Note: Measure Level (dB μ V/m) = Reading Level (dB μ V) + Factor (dB)

Factor (dB) = Cable Loss (dB) + Antenna Factor (dB/m) - Pre_Amplifier Gain (dB)

Site: WZ-AC1	Time: 2021/05/29 - 03:13
Limit: FCC_Part15.209_RE(3m)	Engineer: Tommy Tang
Probe: WZ-AC1_BBHA9120D_1-18GHz	Polarity: Vertical
EUT: WIFI+BT Combo Module	Power: AC 120V/60Hz
Test Mode: Transmit by 802.11n-HT40 at Channel 5190MHz	

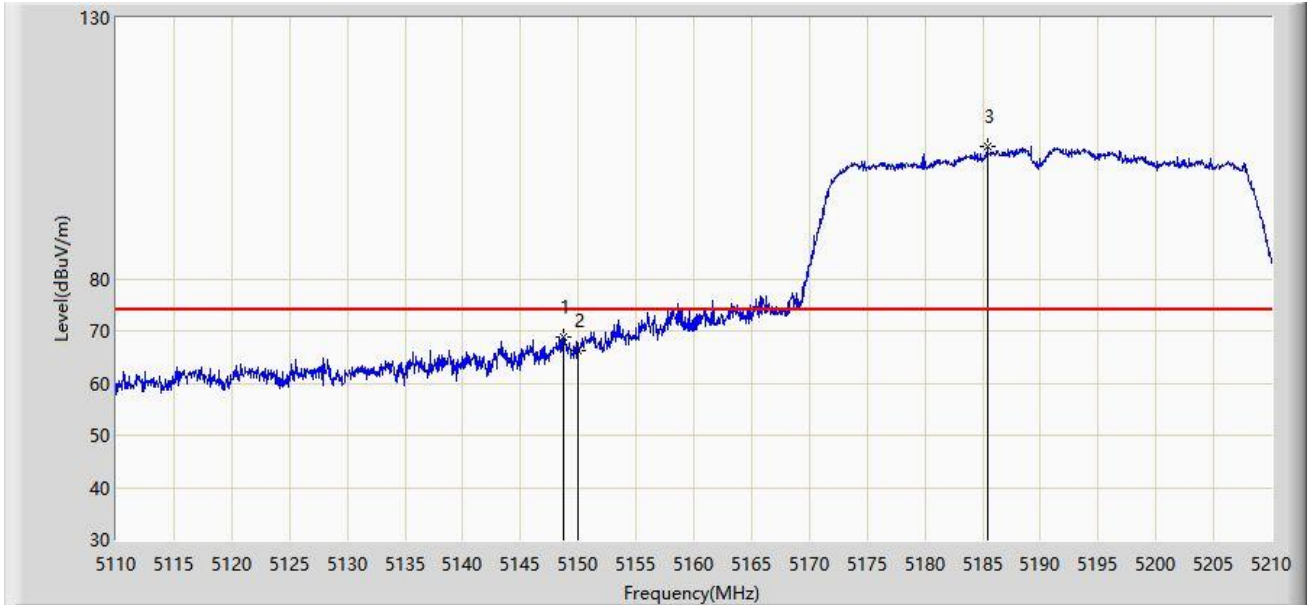

No	Flag	Mark	Frequency (MHz)	Measure Level (dBuV/m)	Reading Level (dBuV)	Margin (dB)	Limit (dBuV/m)	Factor (dB)	Type
1			5148.700	68.732	64.708	-5.268	74.000	4.023	PK
2			5150.000	66.193	62.164	-7.807	74.000	4.029	PK
3		*	5185.400	105.364	101.307	N/A	N/A	4.056	PK

Note: Measure Level (dB μ V/m) = Reading Level (dB μ V) + Factor (dB)

Factor (dB) = Cable Loss (dB) + Antenna Factor (dB/m) - Pre_Amplifier Gain (dB)

Site: WZ-AC1	Time: 2021/05/29 - 03:15
Limit: FCC_Part15.209_RE(3m)	Engineer: Tommy Tang
Probe: WZ-AC1_BBHA9120D_1-18GHz	Polarity: Vertical
EUT: WIFI+BT Combo Module	Power: AC 120V/60Hz
Test Mode: Transmit by 802.11n-HT40 at Channel 5190MHz	

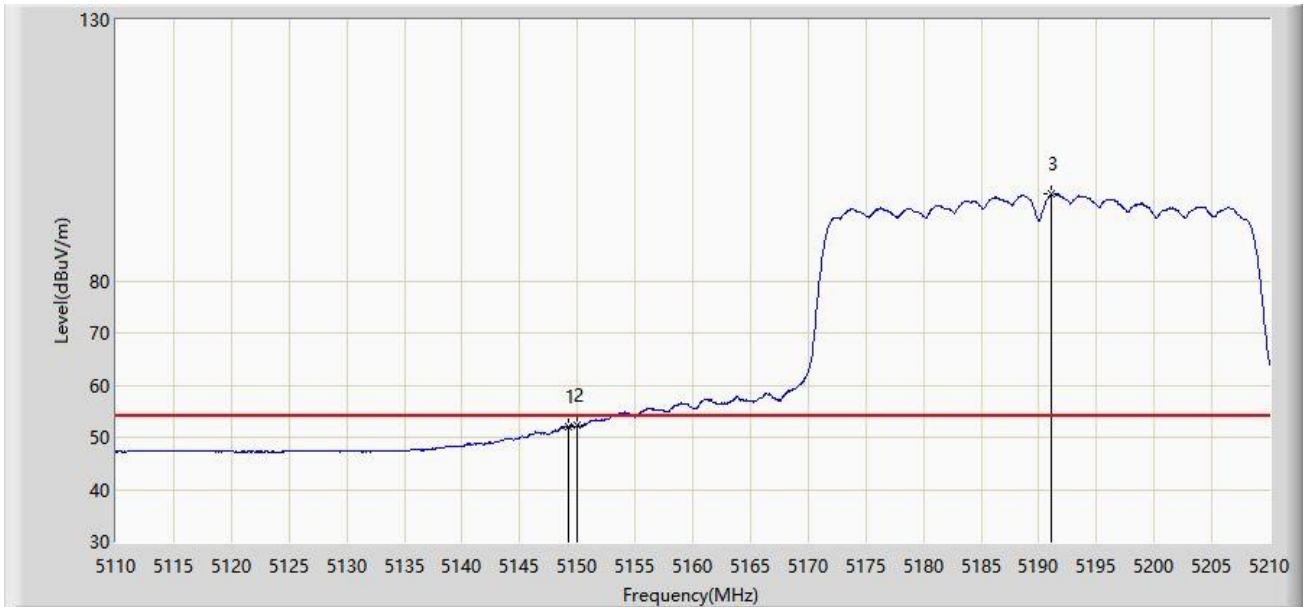

No	Flag	Mark	Frequency (MHz)	Measure Level (dBuV/m)	Reading Level (dBuV)	Margin (dB)	Limit (dBuV/m)	Factor (dB)	Type
1			5149.200	52.139	48.113	-1.861	54.000	4.026	AV
2			5150.000	52.207	48.178	-1.793	54.000	4.029	AV
3		*	5191.100	96.635	92.592	N/A	N/A	4.043	AV

Note: Measure Level (dB μ V/m) = Reading Level (dB μ V) + Factor (dB)

Factor (dB) = Cable Loss (dB) + Antenna Factor (dB/m) - Pre_Amplifier Gain (dB)

Site: WZ-AC1	Time: 2021/05/29 - 04:09
Limit: FCC_Part15.209_RE(3m)	Engineer: Tommy Tang
Probe: WZ-AC1_BBHA9120D_1-18GHz	Polarity: Horizontal
EUT: WIFI+BT Combo Module	Power: AC 120V/60Hz
Test Mode: Transmit by 802.11n-HT40 at Channel 5310MHz	

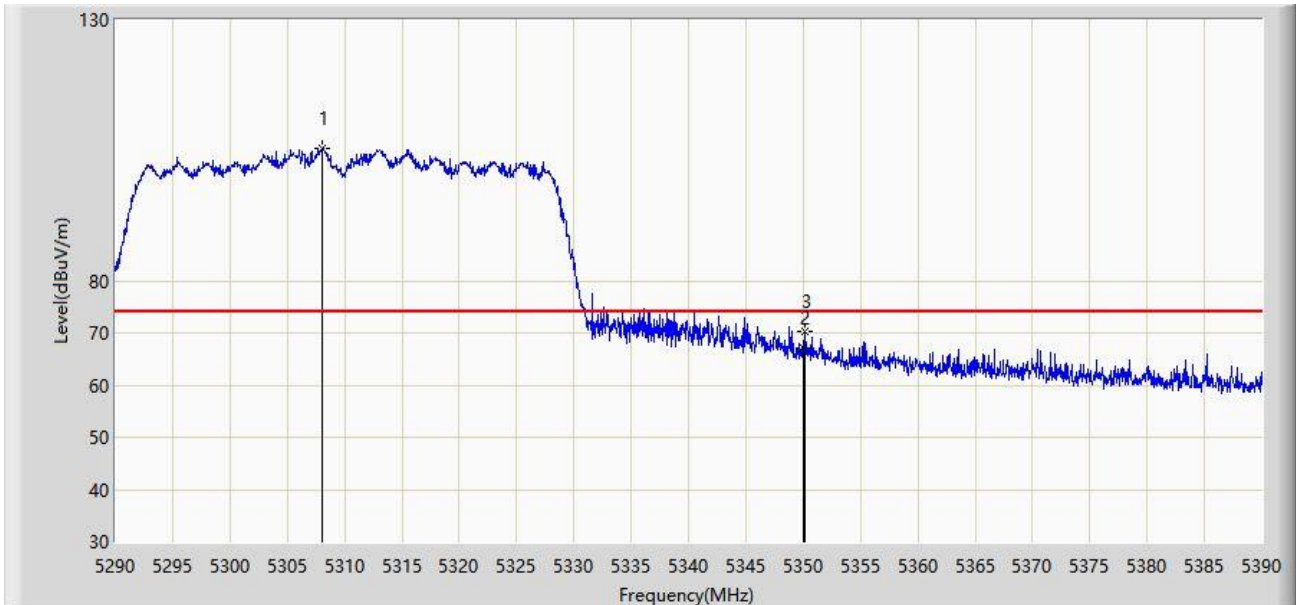

No	Flag	Mark	Frequency (MHz)	Measure Level (dBuV/m)	Reading Level (dBuV)	Margin (dB)	Limit (dBuV/m)	Factor (dB)	Type
1		*	5308.050	105.473	101.682	N/A	N/A	3.791	PK
2			5350.000	66.998	62.981	-7.002	74.000	4.017	PK
3			5350.150	70.265	66.247	-3.735	74.000	4.018	PK

Note: Measure Level (dB μ V/m) = Reading Level (dB μ V) + Factor (dB)

Factor (dB) = Cable Loss (dB) + Antenna Factor (dB/m) - Pre_Amplifier Gain (dB)

Site: WZ-AC1	Time: 2021/05/29 - 04:13
Limit: FCC_Part15.209_RE(3m)	Engineer: Tommy Tang
Probe: WZ-AC1_BBHA9120D_1-18GHz	Polarity: Horizontal
EUT: WIFI+BT Combo Module	Power: AC 120V/60Hz
Test Mode: Transmit by 802.11n-HT40 at Channel 5310MHz	

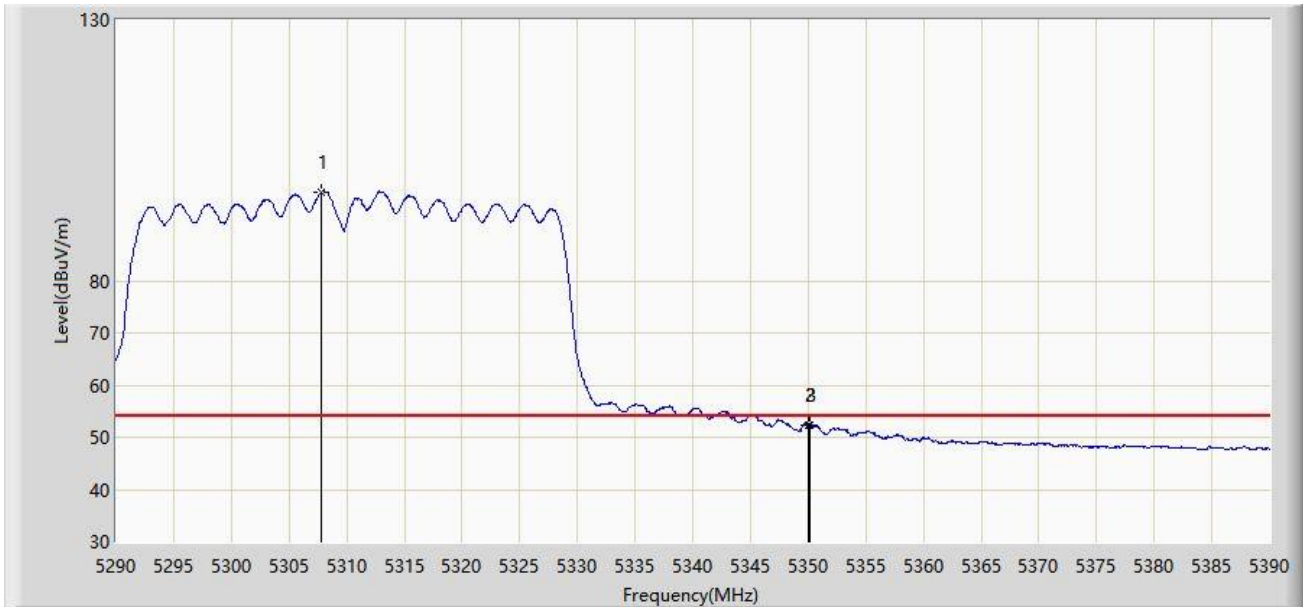

No	Flag	Mark	Frequency (MHz)	Measure Level (dBuV/m)	Reading Level (dBuV)	Margin (dB)	Limit (dBuV/m)	Factor (dB)	Type
1		*	5307.800	96.953	93.163	N/A	N/A	3.790	AV
2			5350.000	52.214	48.197	-1.786	54.000	4.017	AV
3			5350.150	52.344	48.326	-1.656	54.000	4.018	AV

Note: Measure Level (dB μ V/m) = Reading Level (dB μ V) + Factor (dB)

Factor (dB) = Cable Loss (dB) + Antenna Factor (dB/m) - Pre_Amplifier Gain (dB)

Site: WZ-AC1	Time: 2021/05/29 - 04:15
Limit: FCC_Part15.209_RE(3m)	Engineer: Tommy Tang
Probe: WZ-AC1_BBHA9120D_1-18GHz	Polarity: Vertical
EUT: WIFI+BT Combo Module	Power: AC 120V/60Hz
Test Mode: Transmit by 802.11n-HT40 at Channel 5310MHz	

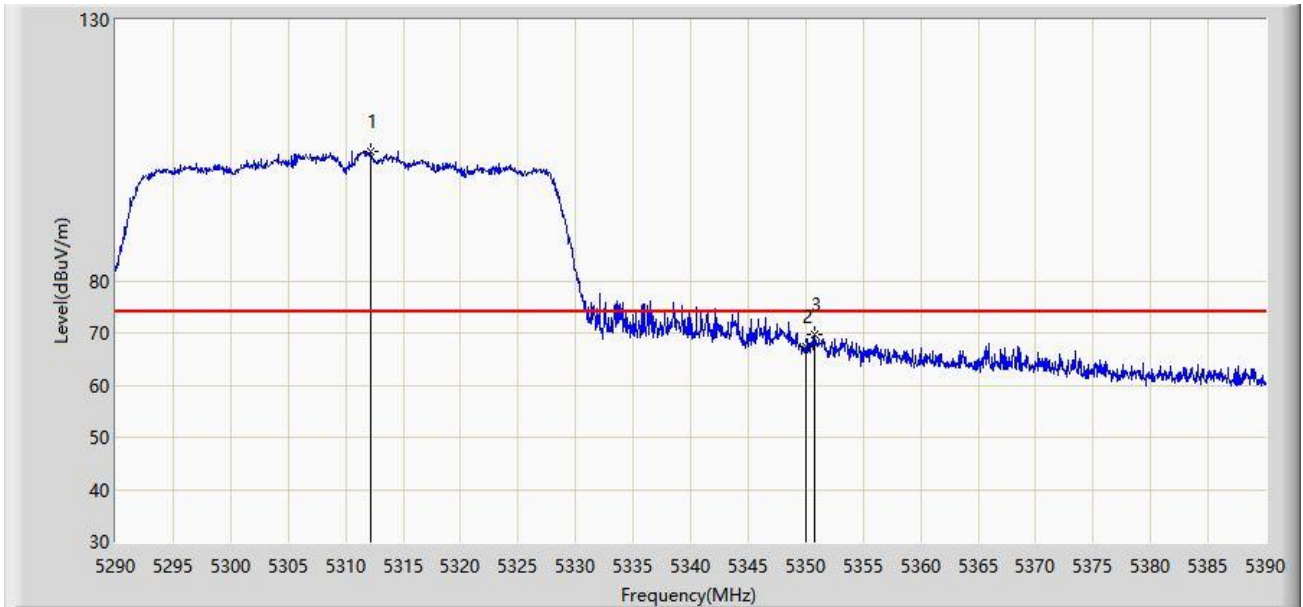

No	Flag	Mark	Frequency (MHz)	Measure Level (dBuV/m)	Reading Level (dBuV)	Margin (dB)	Limit (dBuV/m)	Factor (dB)	Type
1		*	5312.200	104.742	100.931	N/A	N/A	3.811	PK
2			5350.000	67.366	63.349	-6.634	74.000	4.017	PK
3			5350.750	69.686	65.664	-4.314	74.000	4.022	PK

Note: Measure Level (dB μ V/m) = Reading Level (dB μ V) + Factor (dB)

Factor (dB) = Cable Loss (dB) + Antenna Factor (dB/m) - Pre_Amplifier Gain (dB)

Site: WZ-AC1	Time: 2021/05/29 - 04:15
Limit: FCC_Part15.209_RE(3m)	Engineer: Tommy Tang
Probe: WZ-AC1_BBHA9120D_1-18GHz	Polarity: Vertical
EUT: WIFI+BT Combo Module	Power: AC 120V/60Hz
Test Mode: Transmit by 802.11n-HT40 at Channel 5310MHz	

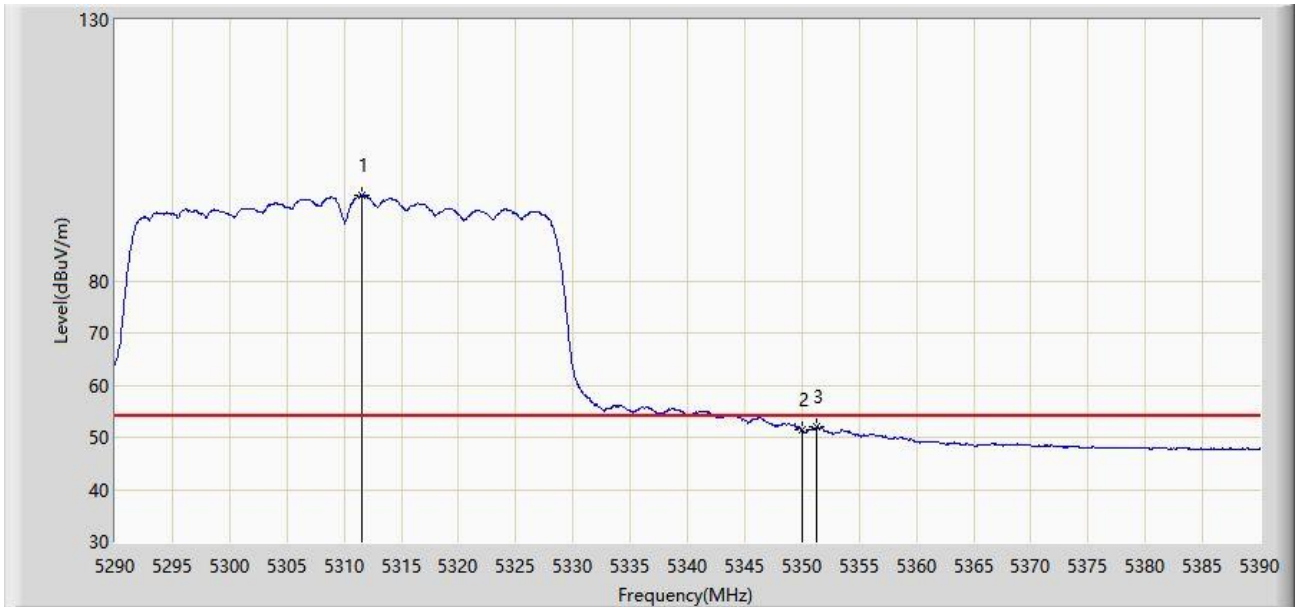

No	Flag	Mark	Frequency (MHz)	Measure Level (dBuV/m)	Reading Level (dBuV)	Margin (dB)	Limit (dBuV/m)	Factor (dB)	Type
1		*	5311.500	96.384	92.576	N/A	N/A	3.808	AV
2			5350.000	51.466	47.449	-2.534	54.000	4.017	AV
3			5351.300	51.911	47.886	-2.089	54.000	4.025	AV

Note: Measure Level (dB μ V/m) = Reading Level (dB μ V) + Factor (dB)

Factor (dB) = Cable Loss (dB) + Antenna Factor (dB/m) - Pre_Amplifier Gain (dB)

Site: WZ-AC1	Time: 2021/05/29 - 04:35
Limit: FCC_Part15.209_RE(3m)	Engineer: Tommy Tang
Probe: WZ-AC1_BBHA9120D_1-18GHz	Polarity: Horizontal
EUT: WIFI+BT Combo Module	Power: AC 120V/60Hz
Test Mode: Transmit by 802.11n-HT40 at Channel 5510MHz	

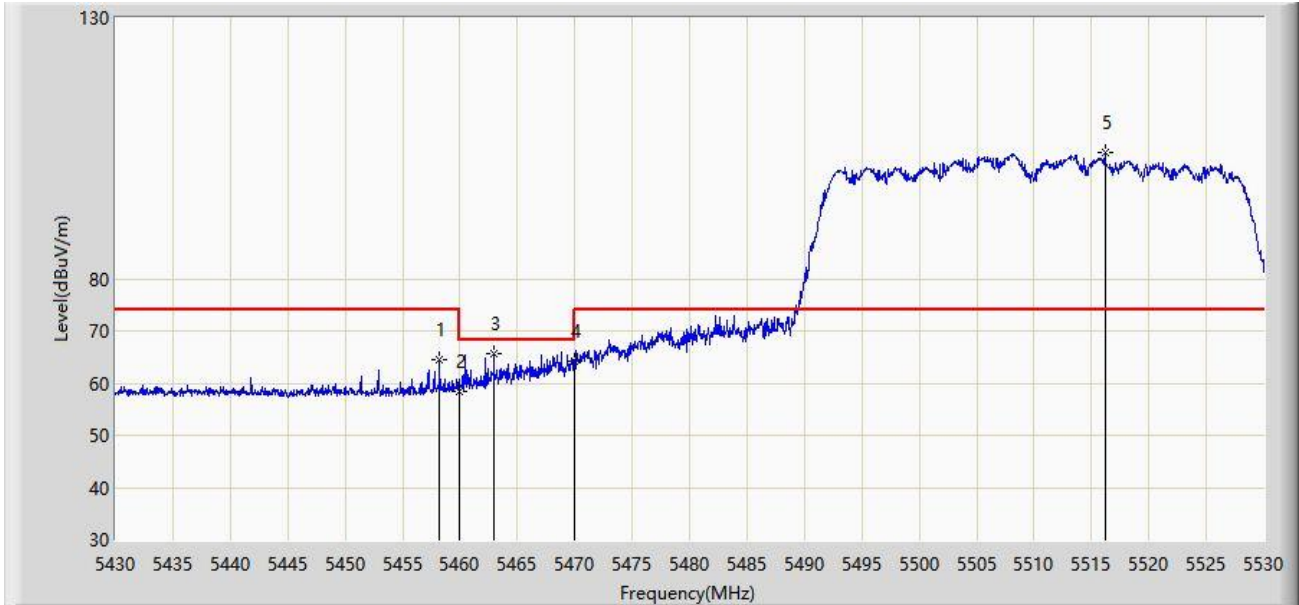

No	Flag	Mark	Frequency (MHz)	Measure Level (dBuV/m)	Reading Level (dBuV)	Margin (dB)	Limit (dBuV/m)	Factor (dB)	Type
1			5458.200	64.624	60.352	-9.376	74.000	4.272	PK
2			5460.000	58.427	54.165	-15.573	74.000	4.261	PK
3			5462.950	65.663	61.418	-2.537	68.200	4.245	PK
4			5470.000	64.199	59.995	-4.001	68.200	4.204	PK
5		*	5516.200	104.296	99.791	N/A	N/A	4.506	PK

Note: Measure Level (dBμV/m) = Reading Level (dBμV) + Factor (dB)

Factor (dB) = Cable Loss (dB) + Antenna Factor (dB/m) - Pre_Amplifier Gain (dB)

Site: WZ-AC1	Time: 2021/05/29 - 04:37
Limit: FCC_Part15.209_RE(3m)	Engineer: Tommy Tang
Probe: WZ-AC1_BBHA9120D_1-18GHz	Polarity: Horizontal
EUT: WIFI+BT Combo Module	Power: AC 120V/60Hz
Test Mode: Transmit by 802.11n-HT40 at Channel 5510MHz	

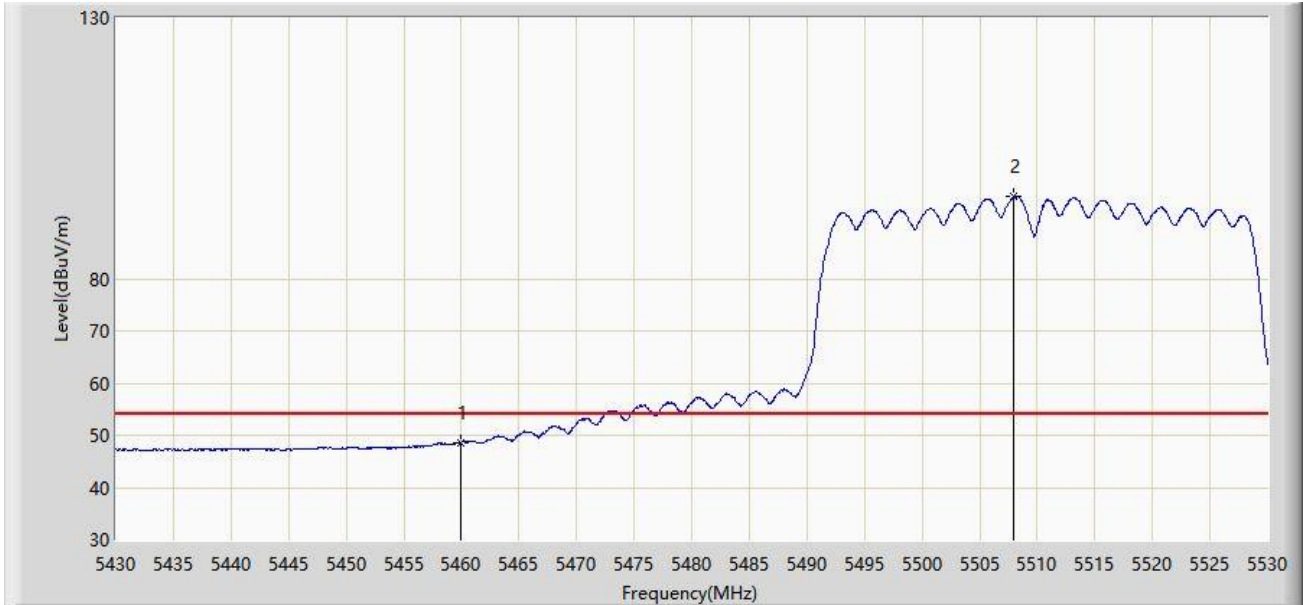

No	Flag	Mark	Frequency (MHz)	Measure Level (dBuV/m)	Reading Level (dBuV)	Margin (dB)	Limit (dBuV/m)	Factor (dB)	Type
1			5460.000	48.682	44.420	-5.318	54.000	4.261	AV
2		*	5508.000	95.738	91.269	N/A	N/A	4.469	AV

Note: Measure Level (dB μ V/m) = Reading Level (dB μ V) + Factor (dB)

Factor (dB) = Cable Loss (dB) + Antenna Factor (dB/m) - Pre_Amplifier Gain (dB)

Site: WZ-AC1	Time: 2021/05/29 - 04:39
Limit: FCC_Part15.209_RE(3m)	Engineer: Tommy Tang
Probe: WZ-AC1_BBHA9120D_1-18GHz	Polarity: Vertical
EUT: WIFI+BT Combo Module	Power: AC 120V/60Hz
Test Mode: Transmit by 802.11n-HT40 at Channel 5510MHz	

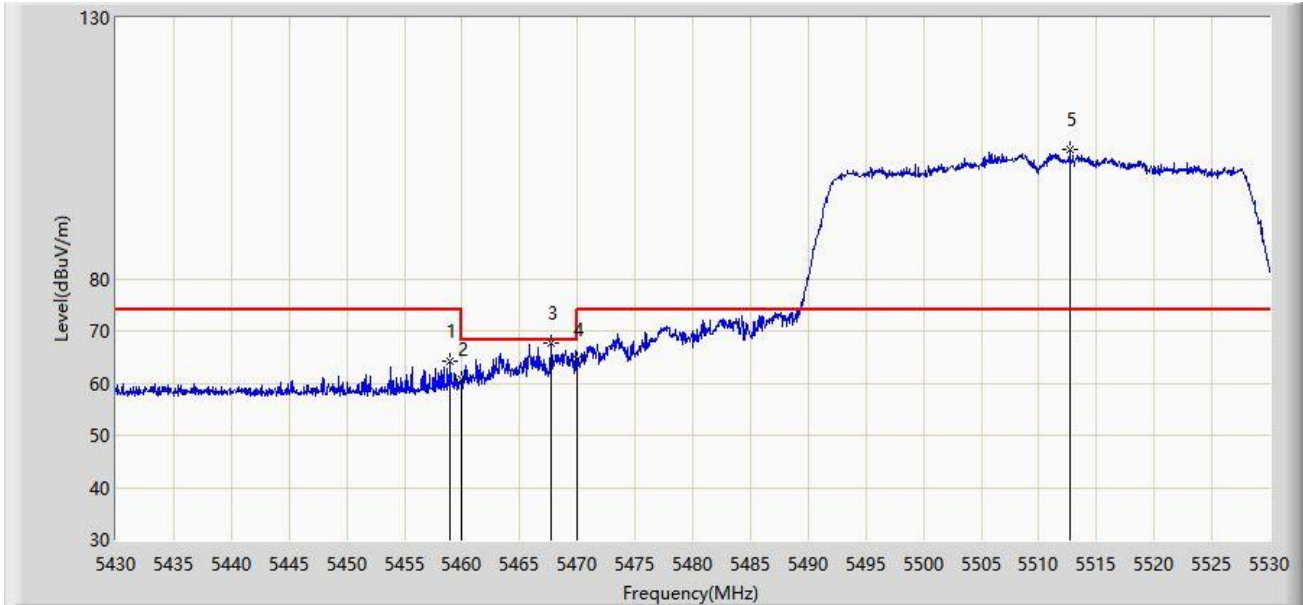

No	Flag	Mark	Frequency (MHz)	Measure Level (dBuV/m)	Reading Level (dBuV)	Margin (dB)	Limit (dBuV/m)	Factor (dB)	Type
1			5459.000	64.202	59.935	-9.798	74.000	4.267	PK
2			5460.000	60.676	56.414	-13.324	74.000	4.261	PK
3			5467.750	67.726	63.509	-0.474	68.200	4.217	PK
4			5470.000	64.402	60.198	-3.798	68.200	4.204	PK
5		*	5512.700	104.865	100.371	N/A	N/A	4.493	PK

Note: Measure Level (dB μ V/m) = Reading Level (dB μ V) + Factor (dB)

Factor (dB) = Cable Loss (dB) + Antenna Factor (dB/m) - Pre_Amplifier Gain (dB)

Site: WZ-AC1	Time: 2021/05/29 - 04:39
Limit: FCC_Part15.209_RE(3m)	Engineer: Tommy Tang
Probe: WZ-AC1_BBHA9120D_1-18GHz	Polarity: Vertical
EUT: WIFI+BT Combo Module	Power: AC 120V/60Hz
Test Mode: Transmit by 802.11n-HT40 at Channel 5510MHz	

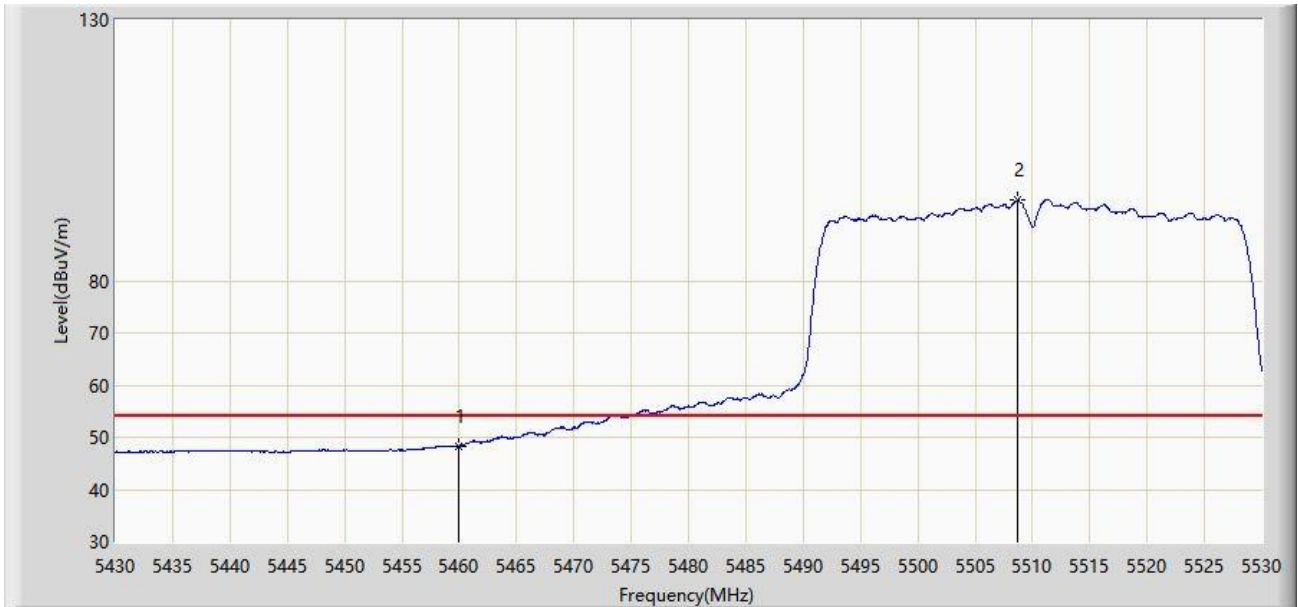

No	Flag	Mark	Frequency (MHz)	Measure Level (dBuV/m)	Reading Level (dBuV)	Margin (dB)	Limit (dBuV/m)	Factor (dB)	Type
1			5460.000	48.273	44.011	-5.727	54.000	4.261	AV
2		*	5508.700	95.453	90.979	N/A	N/A	4.474	AV

Note: Measure Level (dB μ V/m) = Reading Level (dB μ V) + Factor (dB)

Factor (dB) = Cable Loss (dB) + Antenna Factor (dB/m) - Pre_Amplifier Gain (dB)

Site: WZ-AC1	Time: 2021/05/29 - 04:49
Limit: FCC_Part15.209_RE(3m)	Engineer: Tommy Tang
Probe: WZ-AC1_BBHA9120D_1-18GHz	Polarity: Horizontal
EUT: WIFI+BT Combo Module	Power: AC 120V/60Hz
Test Mode: Transmit by 802.11n-HT40 at Channel 5670MHz	

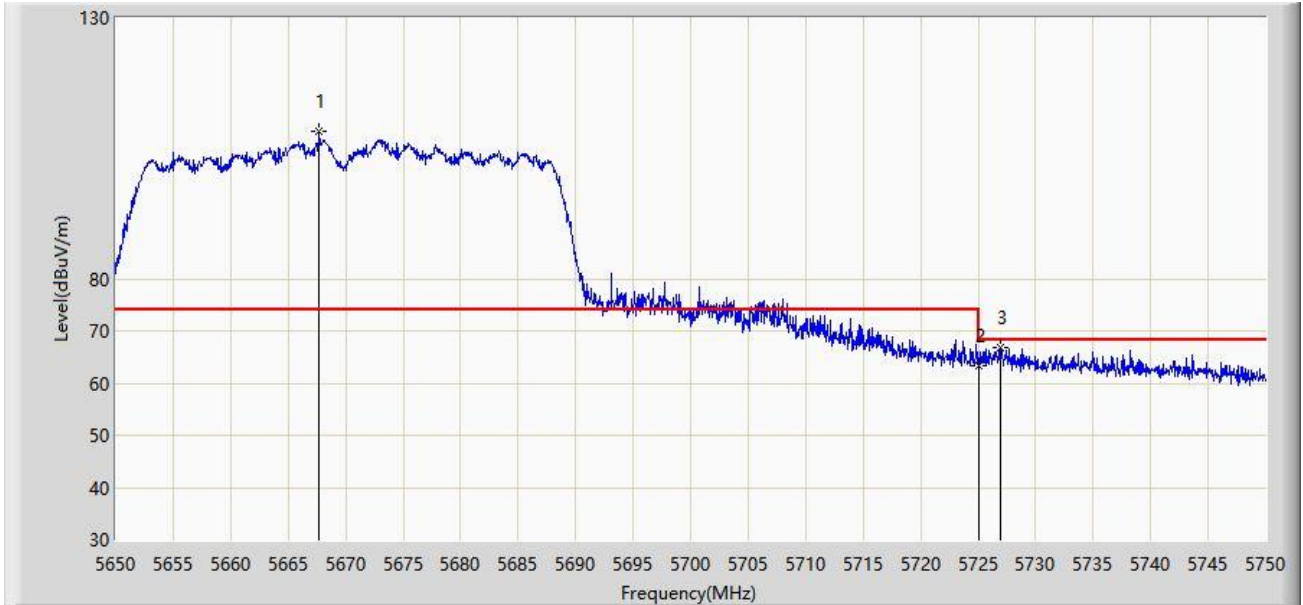

No	Flag	Mark	Frequency (MHz)	Measure Level (dBuV/m)	Reading Level (dBuV)	Margin (dB)	Limit (dBuV/m)	Factor (dB)	Type
1		*	5667.700	108.327	103.781	N/A	N/A	4.545	PK
2			5725.000	63.438	58.927	-4.762	68.200	4.511	PK
3			5727.000	66.717	62.202	-1.483	68.200	4.516	PK

Note: Measure Level (dB μ V/m) = Reading Level (dB μ V) + Factor (dB)

Factor (dB) = Cable Loss (dB) + Antenna Factor (dB/m) - Pre_Amplifier Gain (dB)

Site: WZ-AC1	Time: 2021/05/29 - 04:52
Limit: FCC_Part15.209_RE(3m)	Engineer: Tommy Tang
Probe: WZ-AC1_BBHA9120D_1-18GHz	Polarity: Vertical
EUT: WIFI+BT Combo Module	Power: AC 120V/60Hz
Test Mode: Transmit by 802.11n-HT40 at Channel 5670MHz	

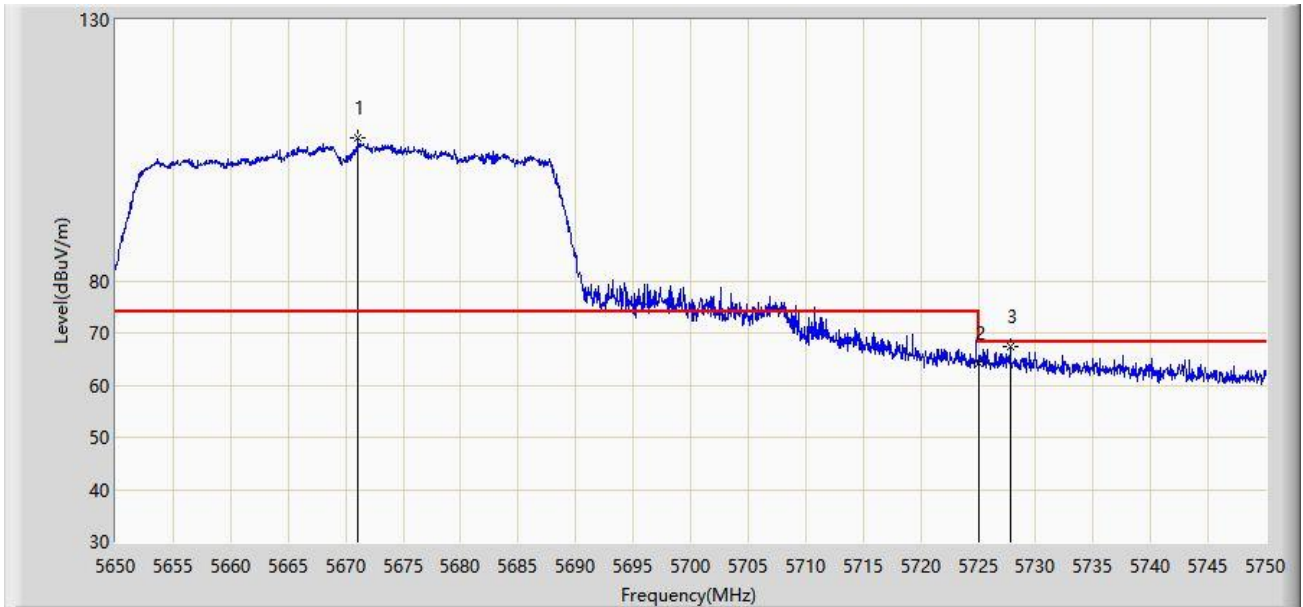

No	Flag	Mark	Frequency (MHz)	Measure Level (dBuV/m)	Reading Level (dBuV)	Margin (dB)	Limit (dBuV/m)	Factor (dB)	Type
1		*	5671.100	107.285	102.686	N/A	N/A	4.599	PK
2			5725.000	64.229	59.718	-3.971	68.200	4.511	PK
3			5727.800	67.266	62.751	-0.934	68.200	4.515	PK

Note: Measure Level (dB μ V/m) = Reading Level (dB μ V) + Factor (dB)

Factor (dB) = Cable Loss (dB) + Antenna Factor (dB/m) - Pre_Amplifier Gain (dB)

Site: WZ-AC1	Time: 2021/06/28 - 20:48
Limit: FCC_Part15.407_RE(3m)	Engineer: Buter Shi
Probe: WZ-AC1_BBHA9120D_1-18GHz	Polarity: Horizontal
EUT: WIFI+BT Combo Module	Power: AC 120V/60Hz
Test Mode: Transmit by 802.11n-HT40 at Channel 5755MHz	

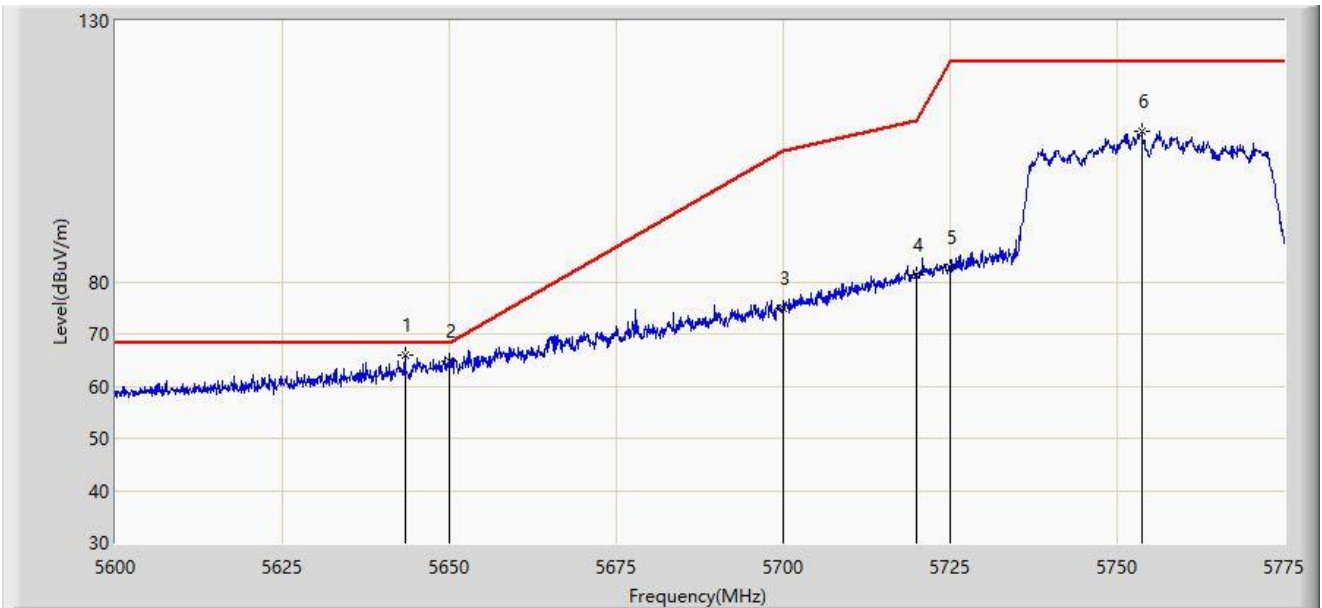

No	Flag	Mark	Frequency (MHz)	Measure Level (dBuV/m)	Reading Level (dBuV)	Margin (dB)	Limit (dBuV/m)	Factor (dB)	Type
1		*	5643.312	65.929	61.632	-2.271	68.200	4.297	PK
2			5650.000	64.675	60.342	-3.525	68.200	4.333	PK
3			5700.000	74.815	70.263	-30.385	105.200	4.551	PK
4			5720.000	81.237	76.724	-29.563	110.800	4.513	PK
5			5725.000	82.686	78.175	-39.514	122.200	4.511	PK
6			5753.737	108.772	104.166	N/A	N/A	4.606	PK

Note: Measure Level (dBμV/m) = Reading Level (dBμV) + Factor (dB)

Factor (dB) = Cable Loss (dB) + Antenna Factor (dB/m) - Pre_Amplifier Gain (dB)

Site: WZ-AC1	Time: 2021/06/24 - 21:22
Limit: FCC_Part15.407_RE(3m)	Engineer: Tommy Tang
Probe: WZ-AC1_BBHA9120D_1-18GHz	Polarity: Vertical
EUT: WIFI+BT Combo Module	Power: AC 120V/60Hz
Test Mode: Transmit by 802.11n-HT40 at Channel 5755MHz	

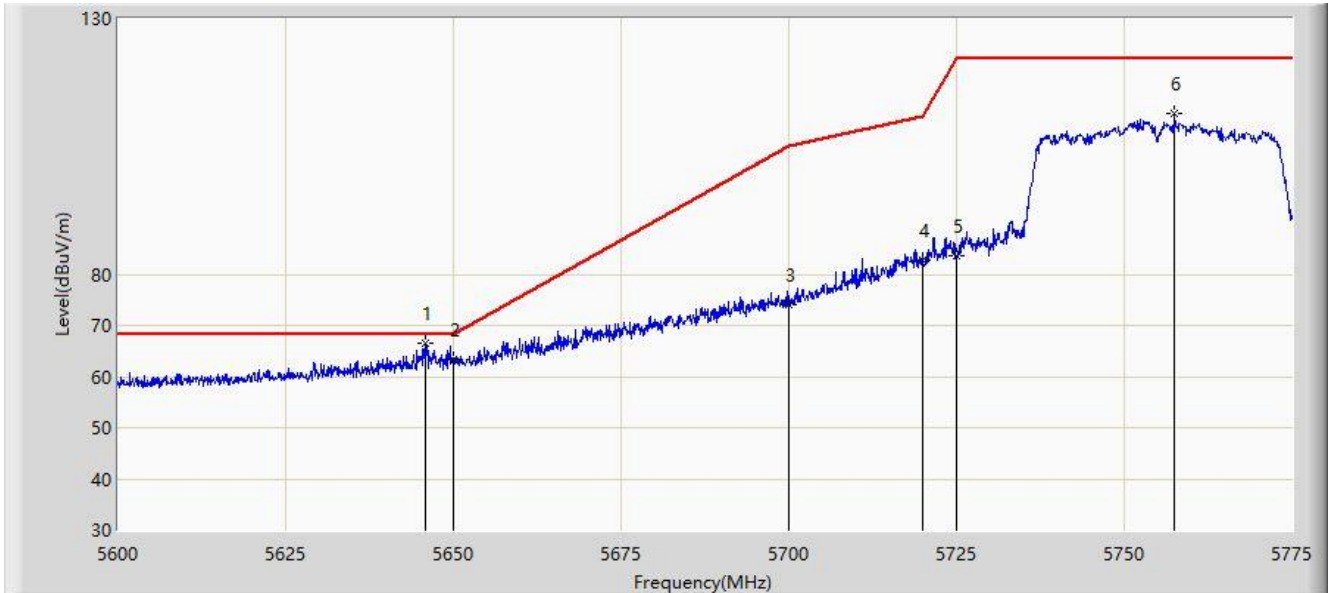

No	Flag	Mark	Frequency (MHz)	Measure Level (dBuV/m)	Reading Level (dBuV)	Margin (dB)	Limit (dBuV/m)	Factor (dB)	Type
1		*	5645.937	66.432	62.121	-1.768	68.200	4.310	PK
2			5650.000	63.463	59.130	-4.737	68.200	4.333	PK
3			5700.000	73.984	69.432	-31.216	105.200	4.551	PK
4			5720.000	82.788	78.275	-28.012	110.800	4.513	PK
5			5725.000	83.597	79.086	-38.603	122.200	4.511	PK
6			5757.500	111.330	106.683	N/A	N/A	4.647	PK

Note: Measure Level (dB μ V/m) = Reading Level (dB μ V) + Factor (dB)

Factor (dB) = Cable Loss (dB) + Antenna Factor (dB/m) - Pre_Amplifier Gain (dB)

Site: WZ-AC1	Time: 2021/05/29 - 05:00
Limit: FCC_Part15.407_RE(3m)	Engineer: Tommy Tang
Probe: WZ-AC1_BBHA9120D_1-18GHz	Polarity: Horizontal
EUT: WIFI+BT Combo Module	Power: AC 120V/60Hz
Test Mode: Transmit by 802.11n-HT40 at Channel 5795MHz	

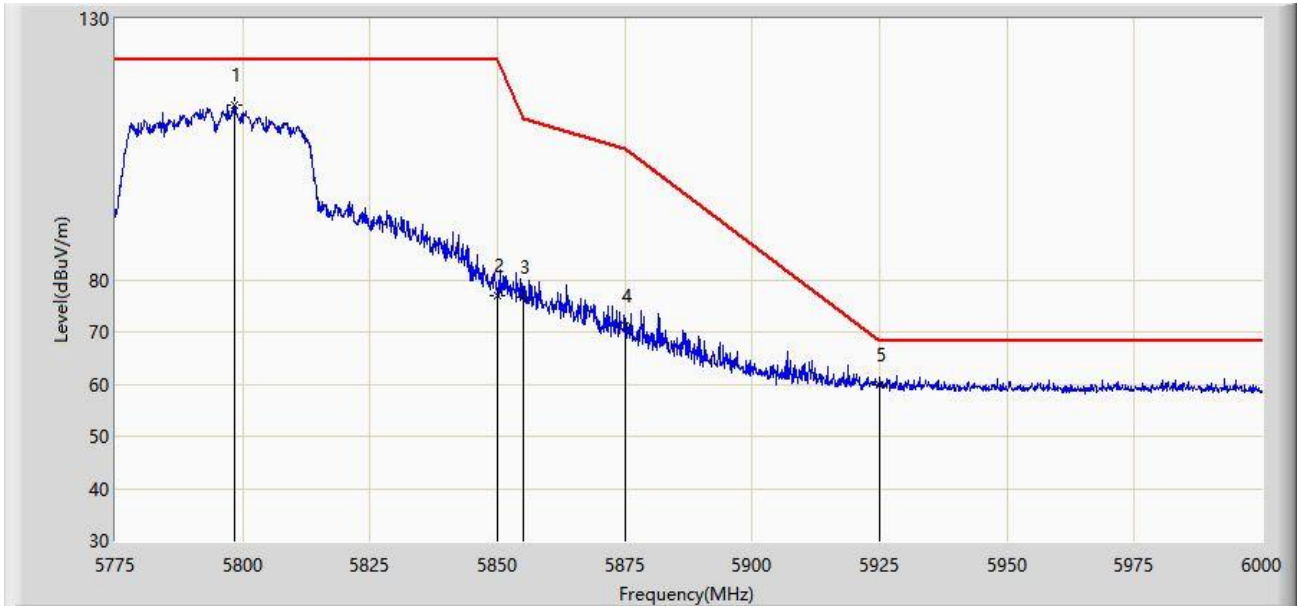

No	Flag	Mark	Frequency (MHz)	Measure Level (dBuV/m)	Reading Level (dBuV)	Margin (dB)	Limit (dBuV/m)	Factor (dB)	Type
1			5798.288	113.518	108.945	N/A	N/A	4.573	PK
2			5850.000	76.844	72.049	-45.356	122.200	4.795	PK
3			5855.000	76.788	71.992	-34.012	110.800	4.796	PK
4			5875.000	71.291	66.501	-33.909	105.200	4.790	PK
5		*	5925.000	59.865	54.802	-8.335	68.200	5.063	PK

Note: Measure Level (dB μ V/m) = Reading Level (dB μ V) + Factor (dB)

Factor (dB) = Cable Loss (dB) + Antenna Factor (dB/m) - Pre_Amplifier Gain (dB)