



Prüfbericht-Nr.: <i>Test report no.:</i>	CN23TGZZ (P15E-WiFi6G) 001	Auftrags-Nr.: <i>Order no.:</i>	48216848	Seite 1 von 42 Page 1 of 42
Kunden-Referenz-Nr.: <i>Client reference no.:</i>	N/A	Auftragsdatum: <i>Order date:</i>	2023-03-13	
Auftraggeber: <i>Client:</i>	Askey Computer Corp. 10F, No. 119, JIANKANG RD. ZHONGHE DIST. NEW TAIPEI CITY			
Prüfgegenstand: <i>Test item:</i>	WiFi 6E Extender			
Bezeichnung / Typ-Nr.: <i>Identification / Type no.:</i>	AP5692W			
Auftrags-Inhalt: <i>Order content:</i>	FCC Part 15E Test report (WiFi 6GHz)			
Prüfgrundlage: <i>Test specification:</i>	FCC 47CFR Part 15: Subpart E Section 15.407			
Wareneingangsdatum: <i>Date of sample receipt:</i>	2023-03-16			
Prüfmuster-Nr.: <i>Test sample no.:</i>	A003435592-001			
Prüfzeitraum: <i>Testing period:</i>	2023-04-08 - 2023-07-14			
Ort der Prüfung: <i>Place of testing:</i>	EMC/RF Taipei Testing Site			
Prüflaboratorium: <i>Testing laboratory:</i>	Taipei Testing Laboratories			
Prüfergebnis*: <i>Test result*:</i>	Pass			
überprüft von: <i>compiled by:</i>		genehmigt von: <i>authorized by:</i>		
Datum: <i>Date:</i>	2023-07-19	Ausstellungsdatum: <i>Issue date:</i>	2023-07-19	
Stellung / Position:	Senior Project Manager	Stellung / Position:	Senior Project Manager	
Sonstiges / Other:				
Zustand des Prüfgegenstandes bei Anlieferung: <i>Condition of the test item at delivery:</i>	Prüfmuster vollständig und unbeschädigt <i>Test item complete and undamaged</i>			
* Legende:	1 = sehr gut P(ass) = entspricht o.g. Prüfgrundlage(n)	2 = gut F(ail) = entspricht nicht o.g. Prüfgrundlage(n)	3 = befriedigend N/A = nicht anwendbar	4 = ausreichend N/T = nicht getestet
* Legend:	1 = very good P(ass) = passed a.m. test specification(s)	2 = good F(ail) = failed a.m. test specification(s)	3 = satisfactory N/A = not applicable	4 = sufficient N/T = not tested
Dieser Prüfbericht bezieht sich nur auf das o.g. Prüfmuster und darf ohne Genehmigung der Prüfstelle nicht auszugsweise vervielfältigt werden. Dieser Bericht berechtigt nicht zur Verwendung eines Prüfzeichens. <i>This test report only relates to the a. m. test sample. Without permission of the test center this test report is not permitted to be duplicated in extracts. This test report does not entitle to carry any test mark.</i>				

V05

TEST SUMMARY

Report Section	FCC Clause	Test Item	Result
5.1.1	15.203	Antenna Requirement	Pass
5.1.2	15.407(a)	Maximum e.i.r.p.	Pass
5.1.3	15.407(a)	Emission Bandwidth	Pass
5.1.4	15.407(g)	Frequency Stability	Pass
5.1.5	15.407(a)	Maximum Power Spectral Density (e.i.r.p.)	Pass
5.1.6	15.407(b)	Radiated Spurious Emissions	Pass
5.1.7	15.407(b)	In-Band Emissions (Channel Mask)	Pass
5.1.8	15.407(d)	Contention-Based Protocol	Pass
5.2.1	15.207	Conducted Emissions on a.c. mains port	Pass

Note: Determining compliance based on the results of the compliance measurement without taking into account measurement instrumentation uncertainty.

Contents

HISTORY OF THIS TEST REPORT	5
1. GENERAL REMARKS	6
1.1 COMPLEMENTARY MATERIALS.....	6
1.2 DECISION RULE OF CONFORMITY	6
2. TEST SITES	7
2.1 TEST LABORATORY	7
2.2 TEST FACILITY.....	7
2.3 TRACEABILITY	8
2.4 CALIBRATION	8
2.5 MEASUREMENT UNCERTAINTY	8
3. GENERAL PRODUCT INFORMATION.....	9
3.1 PRODUCT FUNCTION AND INTENDED USE	9
3.2 SYSTEM DETAILS AND RATINGS.....	9
4. TEST SET-UP AND OPERATION MODES.....	10
4.1 PRINCIPLE OF CONFIGURATION SELECTION	10
4.2 CARRIER FREQUENCY AND CHANNEL.....	11
4.3 TEST OPERATION AND TEST SOFTWARE.....	14
4.4 SPECIAL ACCESSORIES AND AUXILIARY EQUIPMENT	16
4.5 TEST SETUP DIAGRAM	17
4.6 DUTY CYCLE OF TEST SIGNAL.....	18
5. TEST RESULTS	19
5.1 TRANSMITTER REQUIREMENT & TEST SUITES	19
5.1.1 <i>Antenna Requirement.....</i>	<i>19</i>
5.1.2 <i>Maximum e.i.r.p.....</i>	<i>20</i>
5.1.3 <i>Emission Bandwidth</i>	<i>25</i>
5.1.4 <i>Frequency Stability.....</i>	<i>26</i>
5.1.5 <i>Maximum Power Spectral Density (e.i.r.p.)</i>	<i>28</i>
5.1.6 <i>Radiated Spurious Emissions</i>	<i>30</i>
5.1.7 <i>In-Band Emissions (Channel Mask).....</i>	<i>35</i>
5.1.8 <i>Contention-Based Protocol.....</i>	<i>37</i>
5.2 MAINS EMISSION	41
5.2.1 <i>Conducted Emissions on a.c. mains port</i>	<i>41</i>

Prüfbericht - Nr.: CN23TGZZ (P15E-WiFi6G) 001
Test Report No.

Seite 4 von 42
Page 4 of 42

APPENDIX A - TEST RESULTS OF CONDUCTED TEST_BANDWIDTH

APPENDIX B - TEST RESULTS OF CONDUCTED TEST_PSD&MASK

**APPENDIX C - TEST RESULTS OF RADIATED SPURIOUS EMISSIONS & CONDUCTED
EMISSIONS ON A.C. MAINS PORT TEST**

APPENDIX D - CONTENTION-BASED PROTOCOL

APPENDIX SP - PHOTOGRAPHS OF TEST SETUP

APPENDIX EP - PHOTOGRAPHS OF EUT

Prüfbericht - Nr.: CN23TGZZ (P15E-WiFi6G) 001
Test Report No.

Seite 5 von 42
Page 5 of 42

HISTORY OF THIS TEST REPORT

Revision	Description	Date Issued
R00	Original Release	2023-07-19

1. General Remarks

1.1 Complementary Materials

All attachments are integral parts of this test report. This applies especially to the following appendix:

Appendix A - Test Results of Conducted Test_Bandwidth

Appendix B - Test Results of Conducted Test_PSD&Mask

Appendix C - Test Results of Radiated Spurious Emissions & Conducted Emissions on a.c. mains port Test

Appendix D - Contention-Based Protocol

Appendix SP - Photographs of Test Setup

Appendix EP - Photographs of EUT

Applied Standard and Test Levels

Radio
FCC 47CFR Part 15: Subpart E Section 15.407
ANSI C63.10:2013
KDB 789033 D02 General UNII Test Procedures New Rules v02r01
KDB 987594 D02 U-NII 6 GHz EMC Measurement v01r01
KDB 662911 D01 Multiple Transmitter Output v02r01

1.2 Decision Rule of Conformity

The decision rule of conformity of this test report is following the requirements of the requested standard in the quotation, and agreed among testing laboratory and manufacturer (applicant) to exclude the consideration of Measurement Uncertainty, unless it is required by the specific standard.

2. Test Sites

2.1 Test Laboratory

Taipei Testing Laboratories

11F. No.758, Sec. 4, Bade Rd., Songshan Dist.
Taipei City 105
Taiwan (R.O.C.)

2.2 Test Facility

Taipei Testing Laboratories

No.458-18, Sec. 2, Fenliao Rd., Linkou Dist.,
New Taipei City 244
Taiwan (R.O.C.)
FCC Registration No.: 180491
ISED Registration No.: 25563

2.3 Traceability

All measurement equipment calibrations are traceable to NML(Taiwan)/NIST(USA) or where calibration is performed outside Taiwan, to equivalent nationally recognized standards organizations.

2.4 Calibration

Equipment requiring calibration is calibrated periodically in a suitably accredited Calibration Lab. Additionally all equipment is verified for proper performance on a regular basis using in house standards or comparisons.

2.5 Measurement Uncertainty

All measurement uncertainty values are shown with a coverage factor of $k=2$ to indicate a 95% level of confidence.

Emission Measurement Uncertainty

Parameter	Uncertainty
Radiated Emission (9 kHz ~ 30 MHz)	± 1.15 dB
Radiated Emission (30 MHz ~ 200 MHz)	± 1.32 dB
Radiated Emission (200 MHz ~ 1 GHz)	± 1.31 dB
Radiated Emission (1 GHz ~ 18 GHz)	± 1.53 dB
Radiated Emission (18 GHz ~ 40 GHz)	± 2.50 dB
Mains Conducted Emission	± 1.65 dB

3. General Product Information

3.1 Product Function and Intended Use

The EUT is a WiFi 6E Extender, it is a Wi-Fi extender amplifies and rebroadcasts your existing wireless network signal, extending its coverage to eliminate dead spots or weak areas. It helps expand the range and improve connectivity in places where the router's signal doesn't reach effectively. For details refer to the User Guide, Data Sheet and Circuit Diagram.

3.2 System Details and Ratings

Basic Information of EUT

Item	EUT information
Kind of Equipment/Test Item	WiFi 6E Extender
Type Identification	AP5692W
FCC ID	H8N-AP5692W

Technical Specification of EUT

Item	EUT information	
Operating Frequency Range	U-NII-5: 5925 MHz ~ 6425 MHz U-NII-6: 6425 MHz ~ 6525 MHz U-NII-7: 6525 MHz ~ 6875 MHz U-NII-8: 6875 MHz ~ 7125 MHz	
Channel Number	59 for 802.11ax HE20 29 for 802.11ax HE40 14 for 802.11ax HE80 7 for 802.11ax HE160	
Data Rate	802.11ax: up to MCS11	
Operation Voltage	Adapter input 100-240 Vac, output 12 Vdc	
Modulation	OFDM/OFDMA : (BPSK, QPSK, 16QAM, 64QAM, 256QAM, 1024QAM)	
Maximum EIRP Output Power (dBm)	CDD	5955 ~ 6415 MHz: 24.49 6435 ~ 6525 MHz: 22.94 6525 ~ 6875 MHz: 23.09 6875 ~ 7115 MHz: 23.60
	Beamforming	5955 ~ 6415 MHz: 20.85 6435 ~ 6525 MHz: 19.32 6525 ~ 6875 MHz: 20.13 6875 ~ 7115 MHz: 20.10
Antenna Information	Refer to 5.1.1	
Accessory Device	Refer to 4.4	

4. Test Set-up and Operation Modes

4.1 Principle of Configuration Selection

The test modes were adapted accordingly in reference to the instructions for use.

During testing, Channel and Power Controlling Software provided by the customer was used to control the operating channel as well as the output power level. The RF output power selection is for the setting of RF output expected by the customer and is going to be fixed on the firmware of the final end product.

Table for Parameters of Test Software Setting

802.11ax HE20		802.11ax HE40		802.11ax HE80		802.11ax HE160	
Channel	Power Setting	Channel	Power Setting	Channel	Power Setting	Channel	Power Setting
1	5	3	8.5	7	12	15	14.5
45	3.5	43	7.5	39	10.5	47	14.5
93	4	91	6.5	87	10	79	13
97	5	99	7.5	103	12	*111	14
105	5.5	107	7	*119	11	143	13.5
113	4.5	*115	6	135	11	*175	14
117	4	123	6.5	151	11	207	13.5
149	4	155	7	167	11.5		
181	5	179	7.5	183*	11		
185*	4.5	*187	7	199	11		
189	4	195	6.5	215	10.5		
209	4	211	6.5				
233	4	227	5.5				

*Note : Straddle Channel

4.2 Carrier Frequency and Channel

Band	Channel	Frequency (MHz)	802.11ax HE20	802.11ax HE40	802.11ax HE80	802.11ax HE160
U-NII-5 (Band 5)	1	5955	V			
	3	5965		V		
	5	5975	V			
	7	5985			V	
	9	5995	V			
	11	6005		V		
	13	6015	V			
	15	6025				V
	17	6035	V			
	19	6045		V		
	21	6055	V			
	23	6065			V	
	25	6075	V			
	27	6085		V		
	29	6095	V			
	33	6105	V			
	35	6115		V		
	37	6135	V			
	39	6145			V	
	41	6155	V			
	43	6165		V		
	45	6175	V			
	47	6185				V
	49	6195	V			
	51	6205		V		
	53	6215	V			
	55	6225			V	
	57	6235	V			
	59	6245		V		
	61	6255	V			
	65	6275	V			
	67	6285		V		
69	6295	V				
71	6305			V		
73	6315	V				
75	6325		V			
77	6335	V				
79	6345				V	
81	6355	V				
83	6365		V			
85	6375	V				
87	6385			V		

Band	Channel	Frequency (MHz)	802.11ax HE20	802.11ax HE40	802.11ax HE80	802.11ax HE160
U-NII-5 (Band 5)	89	6395	V			
	91	6405		V		
	93	6415	V			
U-NII-6 (Band 6)	97	6435	V			
	99	6445		V		
	101	6455	V			
	103	6465			V	
	105	6475	V			
	107	6485		V		
	109	6495	V			
Straddle Channel	111	6505				V
	115	6525		V		
	119	6545			V	
U-NII-7 (Band 7)	117	6535	V			
	121	6555	V			
	123	6565		V		
	125	6575	V			
	129	6595	V			
	131	6605		V		
	133	6615	V			
	135	6625			V	
	137	6635	V			
	139	6645		V		
	141	6655	V			
	143	6665				V
	145	6675	V			
	147	6685		V		
	149	6695	V			
	151	6705			V	
	153	6715	V			
	155	6725		V		
	157	6735	V			
	161	6755	V			
	163	6765		V		
	165	6775	V			
	167	6785			V	
169	6795	V				
171	6805		V			
173	6815	V				
177	6835	V				
179	6845		V			
181	6855	V				
Straddle Channel	175	6825				V
	183	6865			V	
	185	6875	V			
	187	6885		V		

Band	Channel	Frequency (MHz)	802.11ax HE20	802.11ax HE40	802.11ax HE80	802.11ax HE160
U-NII-8 (Band 8)	189	6895	V			
	193	6915	V			
	195	6925		V		
	197	6935	V			
	199	6945			V	
	201	6955	V			
	203	6965		V		
	205	6975	V			
	207	6985				V
	209	6995	V			
	211	7005		V		
	213	7015	V			
	215	7025			V	
	217	7035	V			
	219	7045		V		
	221	7055	V			
	225	7075	V			
	227	7085		V		
229	7095	V				
233	7115	V				

4.3 Test Operation and Test Software

Setup for testing: Test samples are provided with LAN(RJ-45) interface connected to the notebook computer and used the Terminal software(Putty) to input the test mode command which makes it possible to control them through a test software(QPST) installed on a notebook computer. This software was running on the laptop computer connected to the EUT.

Test Software	QSPR V5.0-00197
---------------	-----------------

Full test was applied on all test modes, but only the worst case was shown.

The device (EUT) includes a MIMO feature with four independent transmitters and receivers.

Modulation Mode	Tx Function
802.11ax HE20	4TX (MIMO)
802.11ax HE40	4TX (MIMO)
802.11ax HE80	4TX (MIMO)
802.11ax HE160	4TX (MIMO)

* For Beamforming mode, only the output power is evaluated and presented in this report.

EUT Configure Mode	Applicable To				Description
	Antenna Port Conducted Measurement	Radiated Spurious Emissions above 1 GHz	Radiated Spurious Emissions below 1 GHz	Conducted Emissions on a.c. mains port	
-	√	√	√	√	-

Note:

1. The EUT had been pre-tested on the positioned of each 3 axis. The worst case was found when position on **Y-plane**.
2. For emission tests, the worst case was the EUT placed in typical used, refer to the photo of test-setup.
3. "-" means no effect.

Antenna Port Conducted Measurement

- Only the worst case of the testing modes was reported.
- Following channel(s) was (were) selected for the final test as listed below.

EUT Configured Modes	Mode	Frequency (MHz)	Available Channel	Tested Channel	Date Rate (Mbps)
CDD	802.11ax HE20	5925-6425	1 to 93	1, 45, 93	NSS1 MCS0
		6425-6525	97 to 113	97, 105, 113	
		6525-6875	117 to 185	117, 149, 181, 185	
		6875-7125	189 to 233	189, 209, 233	
	802.11ax HE40	5925-6425	3 to 91	3, 43, 91	NSS1 MCS0
		6425-6525	99 to 115	99, 107, 115	
		6875-7125	195 to 227	195, 211, 227	
	802.11ax HE80	5925-6425	7 to 87	7, 39, 87	NSS1 MCS0
		6425-6525	103 to 119	103, 119	
		6875-7125	199 to 215	199, 215	
	802.11ax HE160	5925-6425	15 to 79	15, 47, 79	NSS1 MCS0
		6425-6525	111	111	
		6525-6875	143 to 175	143, 175	
		6875-7125	207	207	

EUT Configured Modes	Mode	Frequency (MHz)	Available Channel	Tested Channel	Date Rate (Mbps)
Beamforming	802.11ax HE20	5925-6425	1 to 93	1, 45, 93	NSS1 MCS0
		6425-6525	97 to 113	97, 105, 113	
		6525-6875	117 to 185	117, 149, 181, 185	
		6875-7125	189 to 233	189, 209, 233	
	802.11ax HE40	5925-6425	3 to 91	3, 43, 91	NSS1 MCS0
		6425-6525	99 to 115	99, 107, 115	
		6525-6875	123 to 187	123, 155, 179, 187	
	802.11ax HE80	5925-6425	7 to 87	7, 39, 87	NSS1 MCS0
		6425-6525	103 to 119	103, 119	
		6525-6875	135 to 183	135, 151, 167, 183	
		6875-7125	199 to 215	199, 215	
	802.11ax HE160	5925-6425	15 to 79	15, 47, 79	NSS1 MCS0
		6425-6525	111	111	
		6525-6875	143 to 175	143, 175	
		6875-7125	207	207	

Radiated Spurious Emissions (Above 1 GHz)

- Only the worst case of the testing modes was reported.
- Following channel(s) was (were) selected for the final test as listed below.

PSU Used	Mode	Frequency (MHz)	Available Channel	Tested Channel	Date Rate (Mbps)
Adapter 1	802.11ax HE20	5925-6425	1 to 93	1, 45, 93	NSS1 MCS0
		6425-6525	97 to 113	97, 105, 113	
		6525-6875	117 to 185	117, 149, 181, 185	
		6875-7125	189 to 233	189, 209, 233	
	802.11ax HE40	5925-6425	3 to 91	3, 43, 91	NSS1 MCS0
		6425-6525	99 to 115	99, 107, 115	
		6525-6875	123 to 187	123, 155, 179, 187	
	802.11ax HE80	5925-6425	7 to 87	7, 39, 87	NSS1 MCS0
		6425-6525	103 to 119	103, 119	
		6525-6875	135 to 183	135, 151, 167, 183	
		6875-7125	199 to 215	199, 215	
	802.11ax HE160	5925-6425	15 to 79	15, 47, 79	NSS1 MCS0
		6425-6525	111	111	
		6525-6875	143 to 175	143, 175	
		6875-7125	207	207	

Radiated Spurious Emissions (Below 1 GHz)

- Only the worst case of the testing modes was reported.
- Following channel(s) was (were) selected for the final test as listed below.

PSU Used	Mode	Frequency (MHz)	Available Channel	Tested Channel	Date Rate (Mbps)
Adapter 1	802.11ax HE20	6875-7125	189 to 233	233	NSS1 MCS0

Conducted Emissions on a.c. mains port

- Only the worst case of the testing modes was reported.
 The EUT configuration is shown as below,

PSU Used	Radio Configurations
Adapter 2	The following radio interfaces were set with the configurations below in continuously transmitting mode. Bluetooth: LE, Fc: 2480 MHz WLAN: IEEE 802.11ax, HE20, 2412 MHz. IEEE 802.11a, 5475 MHz IEEE 802.11ax, HE20, 5955 MHz.

Test Condition

Test Item	Ambient Temperature	Relative Humidity	Tested by
Conducted Measurement	22.8-23.4 °C	52-53 %	Andy Chen & Nick Hsu
Radiated Spurious Emissions above 1 GHz	23.7-24.8 °C	54-56 %	Ray Huang
Radiated Spurious Emissions below 1 GHz	23.7-24.8 °C	54-56 %	Ray Huang
Conducted Emissions on a.c. mains port	21.1-24.9 °C	51.7-54.9 %	Ray Huang

4.4 Special Accessories and Auxiliary Equipment

The product has been tested together with the following additional accessories:

Accessory of EUT

No.	Product	Brand	Model	Description
A	Adapter 1	Frecom	F30L10-120250SPAU	I/P: 100-240 Vac, 50/60 Hz, 1.25 A O/P: 12 Vdc, 2.5 A
B	Adapter 2	FLYPOWER	PS30L120K2500UD	I/P: 100-240 Vac, 50/60 Hz, 0.8 A O/P: 12 Vdc, 2.5 A

Support Unit

Support Unit								
No	Description	Brand	Model	S/N	Shielded	Ferrite Core (Qty)	Length (cm)	Remark
-	Notebook	HP	9470m	CNU4099WK7	-	-	-	--

4.5 Test Setup Diagram

<Radiated Spurious Emissions mode>

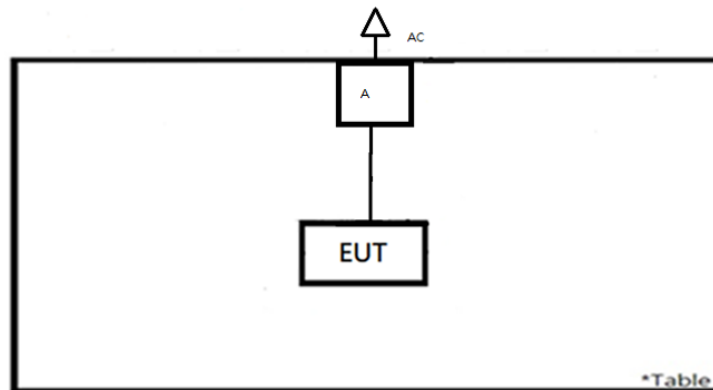

<Conducted Emissions on a.c. mains port mode>

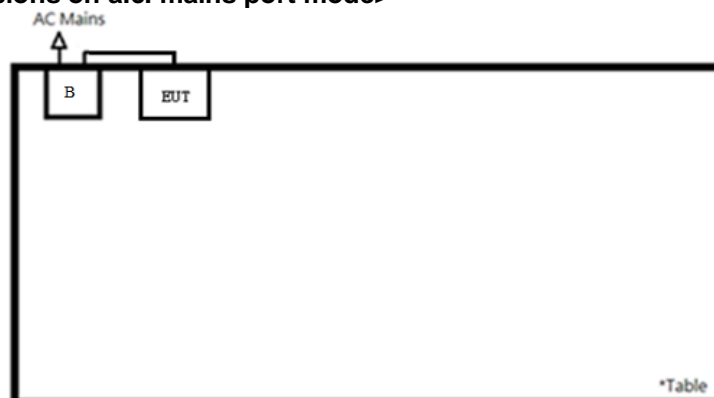

4.6 Duty Cycle of Test Signal

Mode	On + Off Time (ms)	On Time (ms)	Duty Cycle (%)	Duty Factor (dB)
802.11ax HE20	2.178	1.770	81.27	0.90
802.11ax HE40	1.324	0.920	69.49	1.58
802.11ax HE80	3.370	3.030	89.91	0.46
802.11ax HE160	3.451	3.077	89.16	0.50

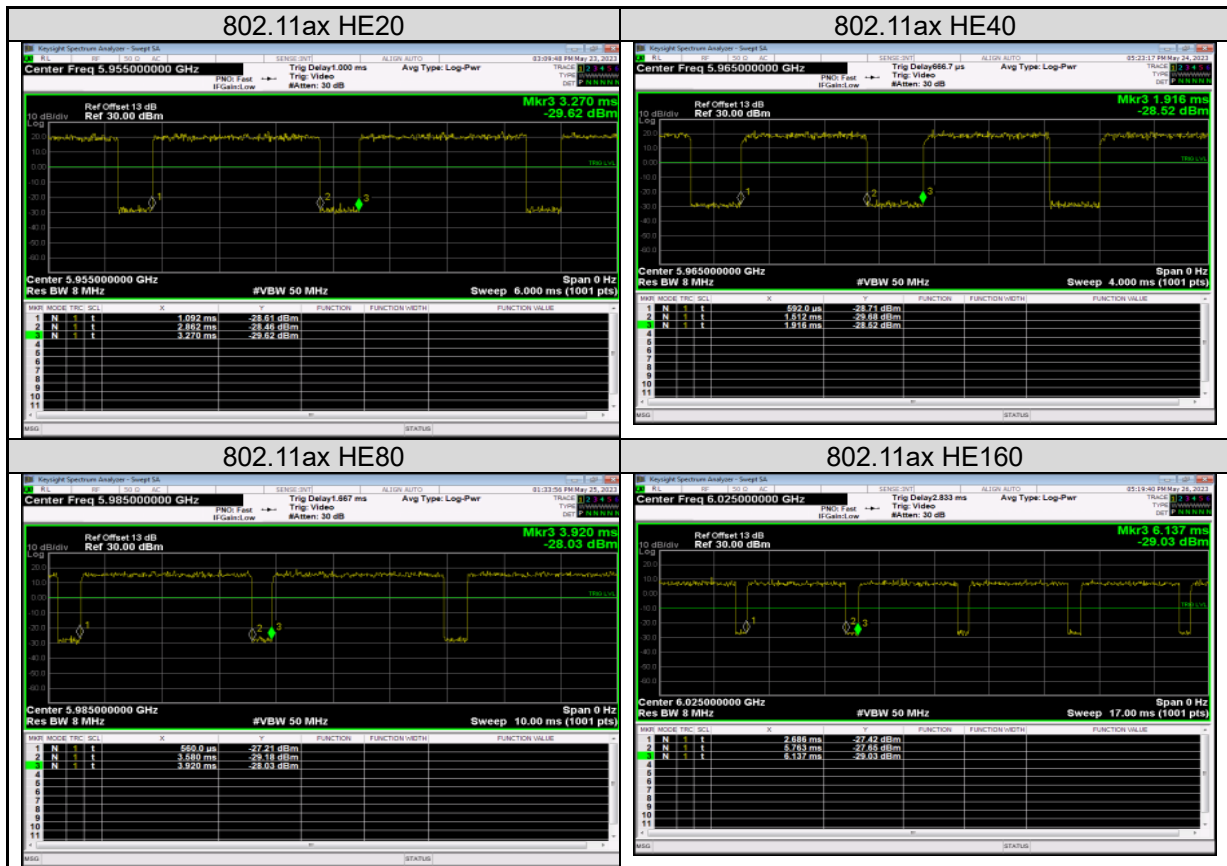

5. Test Results

5.1 Transmitter Requirement & Test Suites

5.1.1 Antenna Requirement

Requirement Use of approved antennas only

The gain value is derived from Antenna datasheet, the EUT's antenna specifications are described as below. The antenna is used with no possibility of replacement with a non-approved antenna by the end-user. Therefore, the EUT is considered to comply with this provision.

ANT		Gain (dBi)				Antenna Type
		U-NII-5	U-NII-6	U-NII-7	U-NII-8	
1		3.04	0.14	2.26	2.83	Dipole
2		3.02	2.24	2.39	3.33	Dipole
5		3.36	0.84	1.33	3.01	Dipole
6		3.53	1.38	1.52	2.12	Dipole
Max Peak Gain		3.53	2.24	2.39	3.33	-
CDD Mode	Power Directional Gain	3.53	2.24	2.39	3.33	-
	PSD Directional Gain	5.91	4.64	5.45	5.85	-
Beamforming Mode	Power Directional Gain	5.91	4.64	5.45	5.85	-
	PSD Directional Gain	5.91	4.64	5.45	5.85	-

Note: The PSD directional gain has been measured, please refer to antenna test report.

Refer to EUT photo for details.

5.1.2 Maximum e.i.r.p.

Limit

Frequency Band	EUT Category	Limit
5.925 ~ 7.125 GHz	Indoor Access Point	The maximum e.i.r.p. over the frequency band of operation must not exceed 30 dBm.
5.925 ~ 6.425 GHz 6.525 ~ 6.875 GHz	Standard Power AP & Fixed Client Device	The maximum e.i.r.p. over the frequency band of operation must not exceed 36 dBm. For outdoor devices, the maximum e.i.r.p. at any elevation angle above 30 degrees as measured from the horizon must not exceed 125 mW (21 dBm).
5.925 ~ 7.125 GHz	Subordinate Device	Operating under the control of an indoor access point: The maximum e.i.r.p. over the frequency band of operation must not exceed 30 dBm.
5.925 ~ 6.425 GHz 6.525 ~ 6.875 GHz	Standard Power Client Devices	Except for fixed client devices, operating under the control of a standard power access point: The maximum e.i.r.p. over the frequency band of operation must not exceed 30 dBm and the device must limit its power to no more than 6 dB below its associated standard power access point's authorized transmit power.
5.925 ~ 7.125 GHz	Indoor Client Devices	Operating under the control of an indoor access point: The maximum e.i.r.p. over the frequency band of operation must not exceed 24 dBm.

Kind of Test Site Shielded room

Test Setup



Test Instruments

Kind of Equipment	Manufacturer	Type	S/N	Calibration Date	Calibration Due Date	Test Date	
						From	Until
4-Channel MIMO	keysight	X8750A	MY58000430	2022/12/26	2023/12/25	2023/5/23	2023/5/26
		X8750A	MY58000431	2022/12/26	2023/12/25	2023/5/23	2023/5/26
		X8750A	MY58000432	2022/12/26	2023/12/25	2023/5/23	2023/5/26
		X8750A	MY58000433	2022/12/26	2023/12/25	2023/5/23	2023/5/26

Test Procedures

Method PM is used to perform output power measurement, trigger and gating function of wide band power meter is enabled to measure max output power of TX on burst and set the detector to AVERAGE. Duty factor is not added to measured value.

Test Result
For U-NII-5 to U-NII-8
<CDD>
<802.11ax HE20>

Channel	Channel Frequency (MHz)	Average Output Power (dBm)				Total Power		EIRP Power (dBm)	EIRP Limit (dBm)
		Chain 0	Chain 1	Chain 2	Chain 3	(dBm)	(mW)		
1	5955	5.11	4.33	4.22	5.49	10.84	12.14	14.37	30.00
45	6175	5.01	3.81	4.97	4.89	10.72	11.80	14.25	30.00
93	6415	4.97	4.83	5.18	4.63	10.93	12.38	14.46	30.00
97	6435	5.98	5.87	6.27	5.82	12.01	15.88	14.25	30.00
105	6475	6.47	6.41	6.75	6.38	12.53	17.89	14.77	30.00
113	6515	6.17	5.62	5.79	5.51	11.80	15.14	14.04	30.00
117	6535	5.62	5.14	5.28	4.91	11.27	13.38	13.66	30.00
149	6695	5.31	5.22	5.11	5.14	11.22	13.23	13.61	30.00
181	6855	6.06	5.97	6.15	6.09	12.09	16.18	14.48	30.00
*185	6875	5.48	5.52	5.46	5.57	11.53	14.22	13.92	30.00
*185	6875	5.48	5.52	5.46	5.57	11.53	14.22	14.86	30.00
189	6895	5.21	4.92	4.84	5.17	11.06	12.76	14.39	30.00
209	6995	5.24	4.99	5.32	5.56	11.30	13.50	14.63	30.00
233	7115	5.11	5.36	5.05	5.29	11.22	13.26	14.55	30.00

*Note : Straddle Channel

<802.11ax HE40>

Channel	Channel Frequency (MHz)	Average Output Power (dBm)				Total Power		EIRP Power (dBm)	EIRP Limit (dBm)
		Chain 0	Chain 1	Chain 2	Chain 3	(dBm)	(mW)		
3	5965	8.22	7.51	8.38	7.23	13.88	24.44	17.41	30.00
43	6165	7.82	6.66	7.89	7.92	13.62	23.03	17.15	30.00
91	6405	6.14	6.34	6.62	6.04	12.31	17.03	15.84	30.00
99	6445	7.32	7.34	7.58	7.21	13.39	21.80	15.63	30.00
107	6485	7.76	7.04	7.32	6.84	13.27	21.25	15.51	30.00
*115	6525	6.58	6.13	6.23	5.89	12.24	16.73	14.48	30.00
*115	6525	6.58	6.13	6.23	5.89	12.24	16.73	14.63	30.00
123	6565	6.97	6.79	6.82	6.38	12.77	18.91	15.16	30.00
155	6725	6.71	7.27	7.38	7.21	13.17	20.75	15.56	30.00
179	6845	7.26	7.35	7.52	7.79	13.51	22.41	15.90	30.00
*187	6885	6.97	7.08	7.02	7.19	13.09	20.35	15.48	30.00
*187	6885	6.97	7.08	7.02	7.19	13.09	20.35	16.42	30.00
195	6925	6.69	6.29	6.61	6.65	12.58	18.13	15.91	30.00
211	7005	6.85	6.63	7.05	7.24	12.97	19.81	16.30	30.00
227	7085	6.51	5.47	6.99	6.81	12.50	17.80	15.83	30.00

*Note : Straddle Channel

<802.11ax HE80>

Channel	Channel Frequency (MHz)	Average Output Power (dBm)				Total Power		EIRP Power (dBm)	EIRP Limit (dBm)
		Chain 0	Chain 1	Chain 2	Chain 3	(dBm)	(mW)		
7	5985	11.78	11.41	12.04	10.98	17.59	57.43	21.12	30.00
39	6145	11.14	10.99	11.41	10.56	17.06	50.77	20.59	30.00
87	6385	11.01	10.27	10.49	9.97	16.47	44.39	20.00	30.00
103	6465	13.11	12.33	12.58	11.71	18.48	70.50	20.72	30.00
*119	6545	12.29	11.77	11.73	10.69	17.68	58.59	19.92	30.00
*119	6545	12.29	11.77	11.73	10.69	17.68	58.59	20.07	30.00
135	6625	12.12	11.71	11.91	11.06	17.74	59.41	20.13	30.00
151	6705	11.58	12.04	11.61	10.92	17.58	57.23	19.97	30.00
167	6785	11.83	12.27	11.81	11.24	17.82	60.58	20.21	30.00
*183	6865	11.89	11.41	11.49	10.75	17.42	55.27	19.81	30.00
*183	6865	11.89	11.41	11.49	10.75	17.42	55.27	20.75	30.00
199	6945	12.15	11.31	11.63	11.05	17.58	57.22	20.91	30.00
215	7025	11.64	10.97	11.02	10.69	17.11	51.46	20.44	30.00

*Note : Straddle Channel

<802.11ax HE160>

Channel	Channel Frequency (MHz)	Average Output Power (dBm)				Total Power		EIRP Power (dBm)	EIRP Limit (dBm)
		Chain 0	Chain 1	Chain 2	Chain 3	(dBm)	(mW)		
15	6025	14.22	14.76	14.71	13.58	20.36	108.73	23.89	30.00
47	6185	15.13	14.72	15.29	14.58	20.96	124.75	24.49	30.00
79	6345	14.11	13.44	13.84	13.19	19.68	92.90	23.21	30.00
*111	6505	15.34	15.02	14.62	13.53	20.70	117.48	22.94	30.00
*111	6505	15.34	15.02	14.62	13.53	20.70	117.48	23.09	30.00
143	6665	14.76	14.21	14.49	13.85	20.36	108.67	22.75	30.00
*175	6825	14.36	14.51	14.34	13.75	20.27	106.42	22.66	30.00
*175	6825	14.36	14.51	14.34	13.75	20.27	106.42	23.60	30.00
207	6985	14.79	13.82	14.04	13.48	20.08	101.86	23.41	30.00

*Note : Straddle Channel

<Beamforming>
<802.11ax HE20>

Channel	Channel Frequency (MHz)	Average Output Power (dBm)				Total Power		EIRP Power (dBm)	EIRP Limit (dBm)
		Chain 0	Chain 1	Chain 2	Chain 3	(dBm)	(mW)		
1	5955	-0.91	-1.69	-1.80	-0.53	4.82	3.03	10.73	30.00
45	6175	-1.01	-2.21	-1.05	-1.13	4.70	2.95	10.61	30.00
93	6415	-1.05	-1.19	-0.84	-1.39	4.91	3.10	10.82	30.00
97	6435	-0.04	-0.15	0.25	-0.20	5.99	3.97	10.63	30.00
105	6475	0.45	0.39	0.73	0.36	6.51	4.47	11.15	30.00
113	6515	0.15	-0.40	-0.23	-0.51	5.78	3.78	10.42	30.00
117	6535	-0.40	-0.88	-0.74	-1.11	5.25	3.35	10.70	30.00
149	6695	-0.71	-0.80	-0.91	-0.88	5.20	3.31	10.65	30.00
181	6855	0.04	-0.05	0.13	0.07	6.07	4.04	11.52	30.00
*185	6875	-0.54	-0.50	-0.56	-0.45	5.51	3.55	10.96	30.00
*185	6875	-0.54	-0.50	-0.56	-0.45	5.51	3.55	11.36	30.00
189	6895	-0.81	-1.10	-1.18	-0.85	5.04	3.19	10.89	30.00
209	6995	-0.78	-1.03	-0.70	-0.46	5.28	3.38	11.13	30.00
233	7115	-0.91	-0.66	-0.97	-0.73	5.20	3.32	11.05	30.00

*Note : Straddle Channel

<802.11ax HE40>

Channel	Channel Frequency (MHz)	Average Output Power (dBm)				Total Power		EIRP Power (dBm)	EIRP Limit (dBm)
		Chain 0	Chain 1	Chain 2	Chain 3	(dBm)	(mW)		
3	5965	2.20	1.49	2.36	1.21	7.86	6.11	13.77	30.00
43	6165	1.80	0.64	1.87	1.90	7.60	5.76	13.51	30.00
91	6405	0.12	0.32	0.60	0.02	6.29	4.26	12.20	30.00
99	6445	1.30	1.32	1.56	1.19	7.37	5.45	12.01	30.00
107	6485	1.74	1.02	1.30	0.82	7.25	5.31	11.89	30.00
*115	6525	0.56	0.11	0.21	-0.13	6.22	4.18	10.86	30.00
*115	6525	0.56	0.11	0.21	-0.13	6.22	4.18	11.67	30.00
123	6565	0.95	0.77	0.80	0.36	6.75	4.73	12.20	30.00
155	6725	0.69	1.25	1.36	1.19	7.15	5.19	12.60	30.00
179	6845	1.24	1.33	1.50	1.77	7.49	5.60	12.94	30.00
*187	6885	0.95	1.06	1.00	1.17	7.07	5.09	12.52	30.00
*187	6885	0.95	1.06	1.00	1.17	7.07	5.09	12.92	30.00
195	6925	0.67	0.27	0.59	0.63	6.56	4.53	12.41	30.00
211	7005	0.83	0.61	1.03	1.22	6.95	4.95	12.80	30.00
227	7085	0.49	-0.55	0.97	0.79	6.48	4.45	12.33	30.00

*Note : Straddle Channel

<802.11ax HE80>

Channel	Channel Frequency (MHz)	Average Output Power (dBm)				Total Power		EIRP Power (dBm)	EIRP Limit (dBm)
		Chain 0	Chain 1	Chain 2	Chain 3	(dBm)	(mW)		
7	5985	5.76	5.39	6.02	4.96	11.57	14.36	17.48	30.00
39	6145	5.12	4.97	5.39	4.54	11.04	12.70	16.95	30.00
87	6385	4.99	4.25	4.47	3.95	10.45	11.10	16.36	30.00
103	6465	7.09	6.31	6.56	5.69	12.46	17.63	17.10	30.00
*119	6545	6.27	5.75	5.71	4.67	11.66	14.65	16.30	30.00
*119	6545	6.27	5.75	5.71	4.67	11.66	14.65	17.11	30.00
135	6625	6.10	5.69	5.89	5.04	11.72	14.85	17.17	30.00
151	6705	5.56	6.02	5.59	4.90	11.56	14.31	17.01	30.00
167	6785	5.81	6.25	5.79	5.22	11.80	15.15	17.25	30.00
*183	6865	5.87	5.39	5.47	4.73	11.40	13.82	16.85	30.00
*183	6865	5.87	5.39	5.47	4.73	11.40	13.82	17.25	30.00
199	6945	6.13	5.29	5.61	5.03	11.56	14.31	17.41	30.00
215	7025	5.62	4.95	5.00	4.67	11.09	12.87	16.94	30.00

*Note : Straddle Channel

<802.11ax HE160>

Channel	Channel Frequency (MHz)	Average Output Power (dBm)				Total Power		EIRP Power (dBm)	EIRP Limit (dBm)
		Chain 0	Chain 1	Chain 2	Chain 3	(dBm)	(mW)		
15	6025	8.20	8.74	8.69	7.56	14.34	27.19	20.25	30.00
47	6185	9.11	8.70	9.27	8.56	14.94	31.19	20.85	30.00
79	6345	8.09	7.42	7.82	7.17	13.66	23.23	19.57	30.00
*111	6505	9.32	9.00	8.60	7.51	14.68	29.37	19.32	30.00
*111	6505	9.32	9.00	8.60	7.51	14.68	29.37	20.13	30.00
143	6665	8.74	8.19	8.47	7.83	14.34	27.17	19.79	30.00
*175	6825	8.34	8.49	8.32	7.73	14.25	26.61	19.70	30.00
*175	6825	8.34	8.49	8.32	7.73	14.25	26.61	20.10	30.00
207	6985	8.77	7.80	8.02	7.46	14.06	25.47	19.91	30.00

*Note : Straddle Channel

5.1.4 Frequency Stability

Limit

Ensure that the emission bandwidth is maintained within the band of operation under all conditions of normal operation.

Kind of Test Site Shielded room

Test Setup

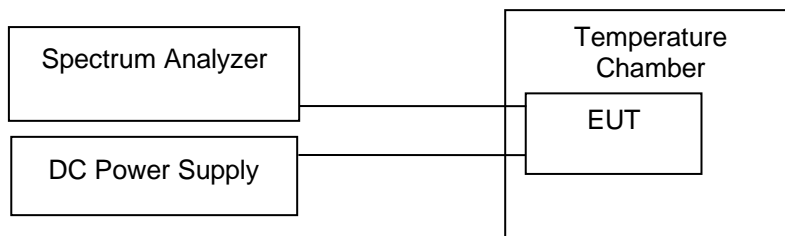

Test Instruments

Kind of Equipment	Manufacturer	Type	S/N	Calibration Date	Calibration Due Date	Test Date	
						From	Until
Spectrum Analyzer	Agilent	N9010A	MY53470241	2022/6/15	2023/6/14	2023/5/23	2023/5/26
Thermal Chamber	Giant Force	GHT-150-40-CP-SD	MAA1902-011	2023/4/10	2024/4/8	2023/5/23	2023/5/26

Test Procedure

MEASUREMENT PROCEDURE REF

- a. Set resolution bandwidth (RBW) = 100 kHz
- b. Set the video bandwidth (VBW) $\geq 3 \times$ RBW, Detector = Peak.
- c. Trace mode = max hold.
- d. Sweep = auto couple.
- e. Measure the maximum width of the emission that is constrained by the frequencies associated with the two amplitude points (upper and lower) that are attenuated by 6 dB relative to the maximum level measured in the fundamental emission.

Test Results

Frequency (MHz)	6175			
Voltage (Vac)	Measurement Frequency (MHz)			Max. Deviation (ppm)
138	6174.97159			4.601
120	6174.973707			4.258
102	6174.972324			4.482
Temperature (°C)	Measurement Frequency (MHz)			
	0 Minute	2 Minute	5 Minute	10 Minute
50	6174.969616	6174.97142	6174.972798	6174.973548
40	6174.974109	6174.97112	6174.970483	6174.971184
30	6174.972531	6174.973005	6174.971312	6174.97439
20	6174.973707	6174.970457	6174.972344	6174.973504
10	6175.035928	6175.032902	6175.026024	6175.015053
0	6175.020122	6175.035573	6175.04676	6175.011034
-10	6175.03383	6175.04281	6175.035194	6175.024928
-20	6175.030947	6175.024944	6175.005783	6175.040138
Max. Deviation (ppm)	5.818	6.933	7.572	6.500

5.1.5 Maximum Power Spectral Density (e.i.r.p.)

Limit

Frequency Band	EUT Category	Limit
5.925 ~ 7.125 GHz	Indoor Access Point	The maximum power spectral density must not exceed 5 dBm e.i.r.p. in any 1-megahertz band.
5.925 ~ 6.425 GHz 6.525 ~ 6.875 GHz	Standard Power AP & Fixed Client Device	The maximum power spectral density must not exceed 23 dBm e.i.r.p. in any 1-megahertz band.
5.925 ~ 7.125 GHz	Subordinate Device	The maximum power spectral density must not exceed 5 dBm e.i.r.p. in any 1-megahertz band.
5.925 ~ 6.425 GHz 6.525 ~ 6.875 GHz	Standard Power Client Devices	Except for fixed client devices, operating under the control of a standard power access point: The maximum power spectral density must not exceed 17 dBm e.i.r.p. in any 1-megahertz band.
5.925 ~ 7.125 GHz	Indoor Client Devices	Operating under the control of an indoor access point: The maximum power spectral density must not exceed -1 dBm e.i.r.p. in any 1-megahertz band.

Kind of Test Site Shielded room

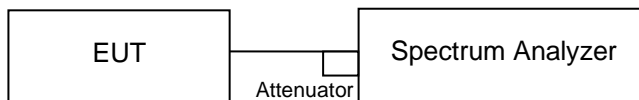
Test Setup

Test Instruments

Kind of Equipment	Manufacturer	Type	S/N	Calibration Date	Calibration Due Date	Test Date	
						From	Until
Spectrum Analyzer	Agilent	N9010A	MY53470241	2022/6/15	2023/6/14	2023/5/23	2023/5/26
Thermal Chamber	Giant Force	GHT-150-40-CP-SD	MAA1902-011	2023/4/10	2024/4/8	2023/5/23	2023/5/26

Test Procedure**For U-NII-5 to U-NII-8 band:**

Using method SA-2

1. Set span to encompass the entire emission bandwidth (EBW) of the signal.
2. Set RBW = 1 MHz, Set VBW \geq 3 MHz, Detector = RMS
3. Sweep time = auto, trigger set to "free run".
4. Trace average at least 100 traces in power averaging mode.
5. Record the max value and add 10 log (1/duty cycle)

For MIMO mode, calculation method follows FCC KDB 662911 Method 2) a) of power density measurement using for calculating total power density. Total power density is summing entire spectra across corresponding frequency bins on the various outputs by computer.

Test Results

Please refer to Appendix B.

5.1.6 Radiated Spurious Emissions

Limit

For transmitters operating within the 5.925-7.125 GHz band: Any emissions outside of the 5.925-7.125 GHz band must not exceed an e.i.r.p. of -27 dBm/MHz.

Radiated emissions which fall in the restricted bands, as defined in §15.205(a), must comply with the radiated emission limits specified in §15.209(a).

Kind of Test Site 3m Semi-Anechoic Chamber

Test Setup

<Radiated Emissions below 30 MHz>

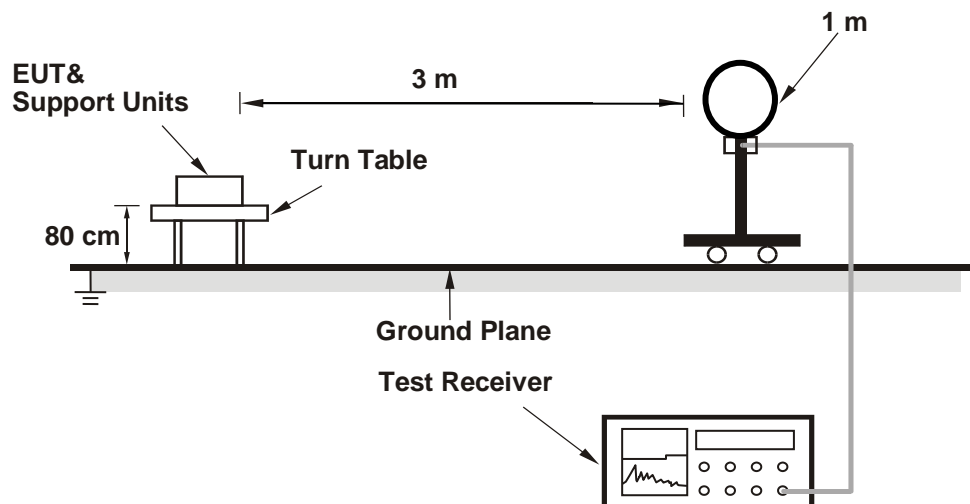

<Radiated Emissions 30 MHz to 1 GHz>

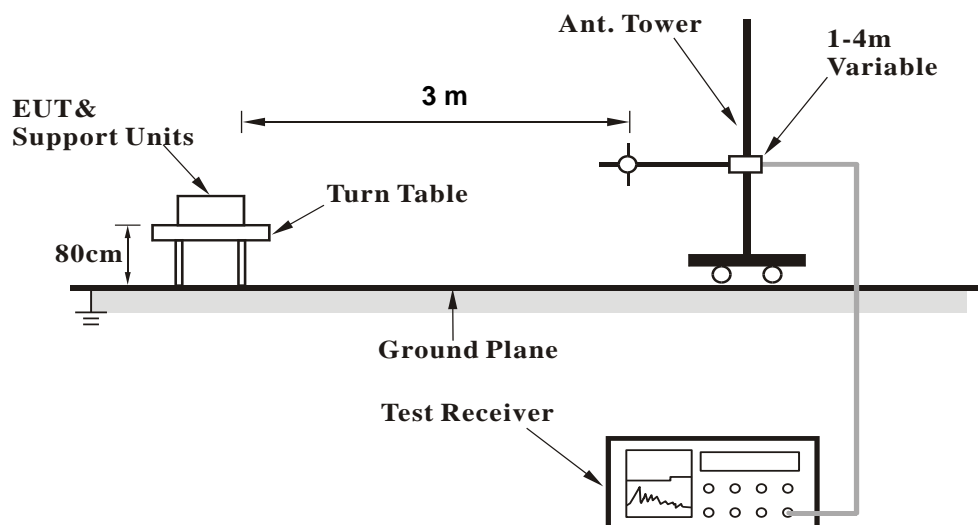

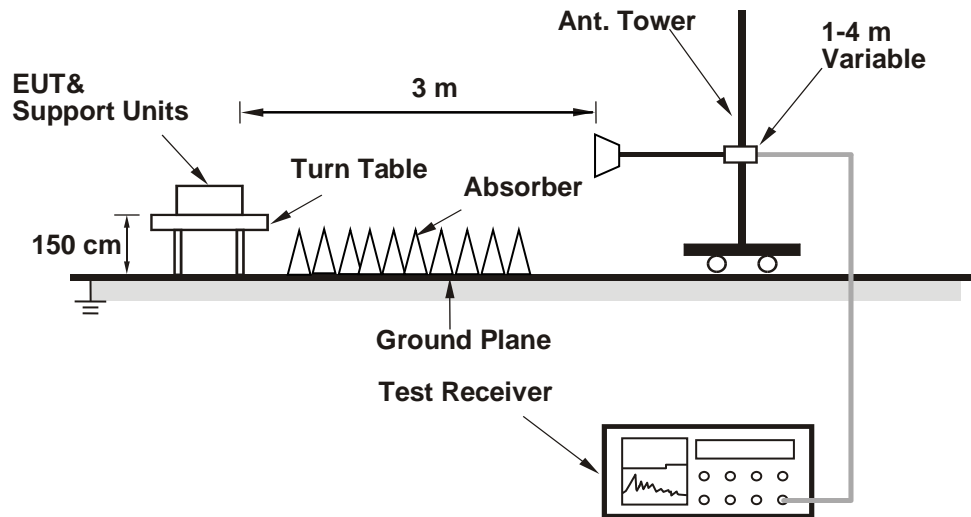
<Radiated Emissions above 1 GHz>

For the actual test configuration, please refer to the attached file (Test Setup Photo).

Test Instruments

Test Period: 2023-04-08 ~ 2023-05-22

Kind of Equipment	Manufacturer	Type	S/N	Calibration Date	Calibration Due Date
Above 1 GHz					
Signal Analyzer	R&S	FSV40	101509	2022/4/27	2023/4/26
			101507	2023/4/26	2024/4/24
Horn Antenna	ETS-Lindgren	3117	00218929	2022/11/17	2023/11/16
Horn Antenna	SCHWARZBECK	BBHA 9170	00890	2022/5/6	2023/5/5
HF-AMP + AC source	EMCI	EMC051845SE	980635	2023/2/16	2024/2/15
HF-AMP + AC source	EMCI	EMC051845SE	980656	2023/1/16	2024/1/15
Test Software	Audix E3	15914a_20191106 tuv	PK-001087	N/A	N/A
30 MHz ~ 1 GHz					
Receiver	R&S	ESR7	102109	2023/2/24	2024/2/23
Bilog Antenna	SCHWARZBECK	VULB-9168	00951	2023/3/31	2024/3/29
LF-AMP	Agilent	8447D	2944A107722	2023/3/22	2024/3/20
Test Software	Audix E3	15914a_20191106 tuv	PK-001087	N/A	N/A
Below 30 MHz					
Receiver	R&S	ESR7	102109	2023/2/24	2024/2/23
Loop Antenna	SCHWARZBECK	FMZB 1519B	00215	2023/1/4	2024/1/3
Test Software	Audix E3	15914a_20191106 tuv	PK-001087	N/A	N/A

Test Procedures**For Radiated Emissions below 30 MHz**

- a. The EUT was placed on the top of a rotating table 0.8 meters above the ground at a 3 meter chamber room. The table was rotated 360 degrees to determine the position of the highest radiation.
- b. The EUT was set 3 meters away from the interference-receiving antenna, which was mounted on the top of a variable-height antenna tower.
- c. Parallel (OPEN), perpendicular (CLOSE), and ground-parallel (GROUND) orientations of the antenna are set to make the measurement.
- d. For each suspected emission, the EUT was arranged to its worst case and the rotatable table was turned from 0 degrees to 360 degrees to find the maximum reading.
- e. The test-receiver system was set to Quasi-Peak Detect Function and Specified Bandwidth with Maximum Hold Mode.

Note:

1. The resolution bandwidth and video bandwidth of test receiver/spectrum analyzer is 9 kHz at frequency below 30 MHz.
2. All modes of operation were investigated and the worst-case emissions are reported.

For Radiated Emissions above 30 MHz

- a. The EUT was placed on the top of a rotating table 0.8 meters (for 30 MHz ~ 1 GHz) / 1.5 meters (for above 1 GHz) above the ground at 3 meter chamber room for test. The table was rotated 360 degrees to determine the position of the highest radiation.
- b. The EUT was set 3 meters away from the interference-receiving antenna, which was mounted on the top of a variable-height antenna tower.
- c. The height of antenna is varied from one meter to four meters above the ground to determine the maximum value of the field strength. Both horizontal and vertical polarizations of the antenna are set to make the measurement.
- d. For each suspected emission, the EUT was arranged to its worst case and then the antenna was tuned to heights from 1 meter to 4 meters and the rotatable table was turned from 0 degrees to 360 degrees to find the maximum reading.
- e. The test-receiver system was set to quasi-peak detect function and specified bandwidth with maximum hold mode when the test frequency is below 1 GHz.
- f. The test-receiver system was set to peak and average detected function and specified bandwidth with maximum hold mode when the test frequency is above 1 GHz. If the peak reading value also meets average limit, measurement with the average detector is unnecessary.

Note:

1. The resolution bandwidth and video bandwidth of test receiver/spectrum analyzer is 120 kHz for Quasi-peak detection (QP) or Peak detection (PK) at frequency below 1 GHz.
2. The resolution bandwidth of test receiver/spectrum analyzer is 1 MHz and the video bandwidth is 3 MHz for Peak detection (PK) at frequency above 1 GHz.
3. The resolution bandwidth of test receiver/spectrum analyzer is 1 MHz and the video bandwidth is $\geq 1/T$ (Duty cycle < 98 %) or 10 Hz (Duty cycle ≥ 98 %) for Average detection (AV) at frequency above 1 GHz.
4. All modes of operation were investigated and the worst-case emissions are reported.
5. The Radiated Emissions testing was performed in the X(E1), Y(H) and Z(E2) axis orientation. The worst-case Axis orientation is recorded in this test report.

Prüfbericht - Nr.: CN23TGZZ (P15E-WiFi6G) 001
Test Report No.

Seite 34 von 42
Page 34 of 42

Test Results

Factor (dB/m) = Antenna Factor (dB/m) + Cable Loss (dB)
Level (dBuV/m) = Reading (dBuV) + Factor (dB/m)

Please refer to Appendix C.

Test Procedures

1. Connect output of the antenna port to a spectrum analyzer or EMI receiver, with appropriate attenuation, as to not damage the instrumentation.
2. Set the reference level of the measuring equipment in accordance with procedure 4.1.5.2 of ANSI C63.10-2013.
3. Measure the 26 dB EBW using the test procedure 12.4.1 of ANSI C63.10-2013. (This will be used to determine the channel edge.)
4. Measure the power spectral density (which will be used for emissions mask reference) using the following procedure:
 - a) Set the span to encompass the entire 26 dB EBW of the signal.
 - b) Set RBW = same RBW used for 26 dB EBW measurement.
 - c) Set VBW $\geq 3 \times$ RBW
 - d) Number of points in sweep $\geq [2 \times \text{span} / \text{RBW}]$.
 - e) Sweep time = auto.
 - f) Detector = RMS (i.e., power averaging)
 - g) Trace average at least 100 traces in power averaging (rms) mode.
 - h) Use the peak search function on the instrument to find the peak of the spectrum.
5. For the purposes of developing the emission mask, the channel bandwidth is defined as the 26 dB EBW.
6. Using the measuring equipment limit line function, develop the emissions mask based on the following requirements. The emissions power spectral density must be reduced below the peak power spectral density (in dB) as follows:
 - a. Suppressed by 20 dB at 1 MHz outside of the channel edge. (The channel edge is defined as the 26-dB point on either side of the carrier center frequency.)
 - b. Suppressed by 28 dB at one channel bandwidth from the channel center.
 - c. Suppressed by 40 dB at one- and one-half times the channel bandwidth from the channel center.
7. Adjust the span to encompass the entire mask as necessary.
8. Clear trace.
9. Trace average at least 100 traces in power averaging (rms) mode.
10. Adjust the reference level as necessary so that the crest of the channel touches the top of the emission mask.

Test Results

Please refer to Appendix B.

5.1.8 Contention-Based Protocol

Limit

Unlicensed low-power indoor devices must detect co-channel radio frequency power that is at least -62 dBm or lower. Upon detection of energy in the band, unlicensed low power indoor devices must vacate the channel (in which incumbent signal is transmitted) and stay off the incumbent channel as long as detected radio frequency power is equal to or greater than the threshold. The -62 dBm threshold is referenced to a 0 dBi antenna gain.

Additionally, low-power indoor devices must detect co-channel energy with 90% or greater certainty.

Kind of Test Site Shielded room

Test Setup

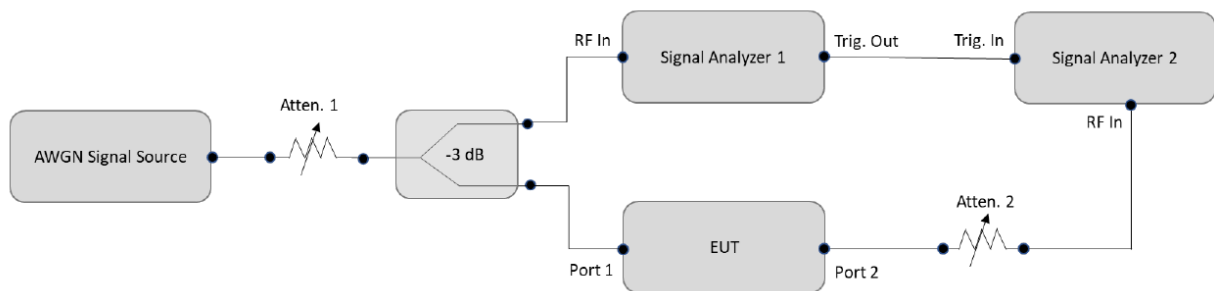

Test Instruments

Kind of Equipment	Manufacturer	Type	S/N	Calibration Date	Calibration Due Date	Test Date	
						From	Until
Spectrum Analyzer	Agilent	N9000B	MY62361339	2023/2/11	2024/2/10	2023/7/11	2023/7/14
EXG Vector Signal Generator	Keysight	N5172B	MY61253270	2022/12/6	2023/12/5	2023/7/11	2023/7/14
Frequency Extender	Keysight	N5182BX07	MY61500182	2023/1/19	2024/1/18	2023/7/11	2023/7/14

Test Procedures

1. Configure the EUT to transmit with a constant duty cycle.
2. Set the operating parameters of the EUT including power level, operating frequency, modulation and bandwidth.
3. Set the signal analyzer center frequency to the nominal EUT channel center frequency. The span range of the signal analyzer shall be between two times and five times the OBW of the EUT.
Connect the output port of the EUT to the signal analyzer 2, as shown in Test Setup. Ensure that the attenuator 2 provides enough attenuation to not overload the signal analyzer 2 receiver.
4. Monitoring the signal analyzer 2, verify the EUT is operating and transmitting with the parameters set at step 2.

5. Using an AWGN signal source, generate (but do not transmit, i.e., RF OFF) a 10 MHz-wide AWGN signal. Use Table 1 to determine the center frequency of the 10 MHz AWGN signal relative to the EUT's channel bandwidth and center frequency.

Table 1. Criteria to determine number of times detection threshold test may be performed

If	Number of Tests	Placement of Incumbent Transmission
$BW_{EUT} \leq BW_{Inc}$	Once	Tune incumbent and EUT transmissions ($f_{c1} = f_{c2}$)
$BW_{Inc} < BW_{EUT} \leq 2BW_{Inc}$	Once	Incumbent transmission is contained within BW_{EUT}
$2BW_{Inc} < BW_{EUT} \leq 4BW_{Inc}$	Twice. Incumbent transmission is contained within BW_{EUT}	Incumbent transmission is located as closely as possible to the lower edge and upper edge, respectively, of the EUT channel
$BW_{EUT} > 4BW_{Inc}$	Three times	Incumbent transmission is located as closely as possible to the lower edge of the EUT channel, in the middle of EUT channel, and as closely as possible to the upper edge of the EUT channel

where:

BW_{EUT} : Transmission bandwidth of EUT signal

BW_{Inc} : Transmission bandwidth of the simulated incumbent signal (10 MHz wide AWGN signal)

f_{c1} : Center frequency of EUT transmission

f_{c2} : Center frequency of simulated incumbent signal

6. Set the AWGN signal power to an extremely low level (more than 20 dB below the -62 dBm threshold). Connect the AWGN signal source, via a 3-dB splitter, to the signal analyzer 1 and the EUT as shown in Test Setup.
7. Transmit the AWGN signal (RF ON) and verify its characteristics on the signal analyzer 1.
8. Monitor the signal analyzer 2 to verify if the AWGN signal has been detected and the EUT has ceased transmission. If the EUT continues to transmit, then incrementally increase the AWGN signal power level until the EUT stops transmitting.
9. (Including all losses in the RF paths) Determine and record the AWGN signal power level (at the EUT's antenna port) at which the EUT ceased transmission. Repeat the procedure at least 10 times to verify the EUT can detect an AWGN signal with 90% (or better) level of certainty.
10. Refer to Table 1 to determine number of times the detection threshold testing needs to be repeated. If testing is required more than once, then go back to step 5, choose a different center frequency for the AWGN signal and repeat the process.

Test Results
<802.11ax HE20>

Contention Based protocol Measurement_802.11ax 20MHz									
UNII Band	Test Channel	Freq. (MHz)	Interference Frequency (MHz)	Threshold level of AWGN interference (dBm)	Number of Times	Number of Detected	Detection Rate (%)	Limit (%)	Test Result
5	45	6175	6175	-74.02	10	10	100	90	Pass
6	105	6475	6475	-74.14	10	10	100	90	Pass
7	149	6695	6695	-74.33	10	10	100	90	Pass
8	209	6995	6995	-74.12	10	10	100	90	Pass

Interference(AWGN) Level Check							
UNII Band	Test Channel	Freq. (MHz)	Interference Frequency (MHz)	AWGN signal level (ON) (dBm)	AWGN signal level (Minimal) (dBm)	AWGN signal level (OFF) (dBm)	Detection Limit (dBm)
5	45	6175	6175	-85.02	-82.02	-74.02	-65.02
6	105	6475	6475	-82.14	-82.14	-74.14	-62.14
7	149	6695	6695	-83.33	-83.33	-74.33	-63.33
8	209	6995	6995	-84.12	-84.12	-74.12	-64.12

Note: Threshold Level (TL) = -62dBm - minimum antenna gain

<802.11ax HE160>

Contention Based protocol Measurement_802.11ax 160MHz									
UNII Band	Test Channel	Freq. (MHz)	Interference Frequency (MHz)	Threshold level of AWGN interference (dBm)	Number of Times	Number of Detected	Detection Rate (%)	Limit (%)	Test Result
5	47	6185	6110	-68.02	10	10	100	90	Pass
			6185	-65.02	10	9	90	90	Pass
			6260	-75.02	10	10	100	90	Pass
6	111	6505	6430	-64.14	10	9	90	90	Pass
			6505	-63.14	10	9	90	90	Pass
			6580	-64.14	10	10	100	90	Pass
7	143	6665	6590	-71.33	10	9	90	90	Pass
			6665	-65.33	10	10	100	90	Pass
			6740	-71.33	10	9	90	90	Pass
8	207	6985	6910	-71.12	10	10	100	90	Pass
			6985	-66.12	10	9	90	90	Pass
			7060	-69.12	10	10	100	90	Pass

Interference(AWGN) Level Check							
UNII Band	Test Channel	Freq. (MHz)	Interference Frequency (MHz)	AWGN signal level (ON) (dBm)	AWGN signal level (Minimal) (dBm)	AWGN signal level (OFF) (dBm)	Detection Limit (dBm)
5	47	6185	6110	-85.02	-85.02	-68.02	-65.02
			6185			-75.02	
			6260			-75.02	
6	111	6505	6430	-82.14	-82.14	-64.14	-62.14
			6505			-63.14	
			6580			-64.14	
7	143	6665	6590	-83.33	-83.33	-71.33	-63.33
			6665			-65.33	
			6740			-71.33	
8	207	6985	6910	-84.12	-84.12	-71.12	-64.12
			6985			-66.12	
			7060			-69.12	

Note: Threshold Level (TL) = -62dBm - minimum antenna gain

Please refer to Appendix D for the details.

5.2 Mains Emission

5.2.1 Conducted Emissions on a.c. mains port

Limit

Mains Conducted emissions as defined in RSS-Gen 8.8 must comply with the mains conducted emission limits.

Kind of Test Site Shielded room

Test Setup

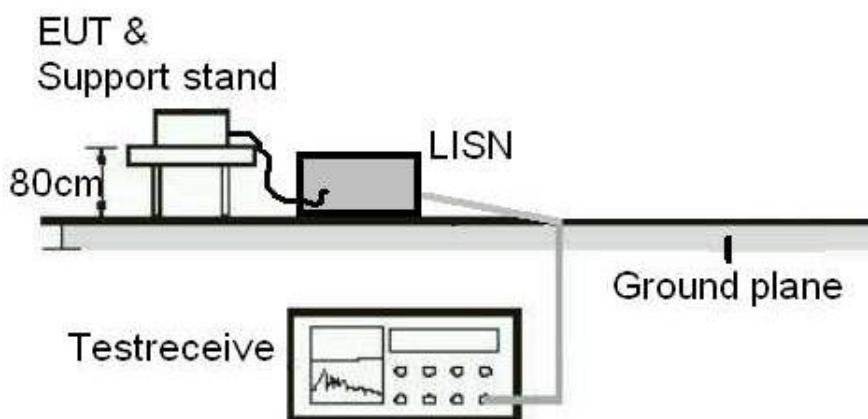

Test Instruments

Kind of Equipment	Manufacturer	Type	S/N	Calibration Date	Calibration Due Date
Two-Line V-Network	Rohde & Schwarz	ENV216	101938	2022/9/22	2023/9/21
EMI Test Receiver	R&S	ESCI	100797	2022/6/19	2023/6/18

Test Procedures

- a. The EUT was placed 0.4 meters from the conducting wall of the shielded room with EUT being connected to the power mains through a line impedance stabilization network (LISN). Other support units were connected to the power mains through another LISN. The two LISNs provide 50 ohm/50 uH of coupling impedance for the measuring instrument.
- b. Both lines of the power mains connected to the EUT were checked for maximum conducted interference.
- c. The frequency range from 150 kHz to 30 MHz was searched. Emission levels under (Limit – 20 dB) was not recorded.

Note: The resolution bandwidth and video bandwidth of test receiver is 9 kHz for quasi-peak detection (QP) and average detection (AV) at frequency 0.15 MHz – 30 MHz.

Test Results

Please refer to Appendix C.