

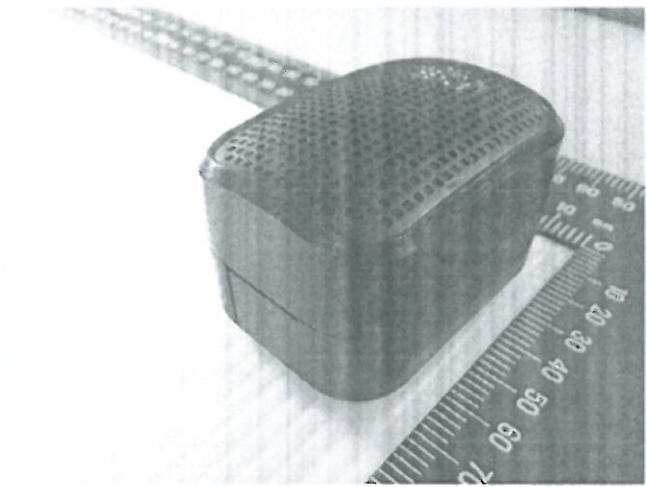

Prüfbericht-Nr.: <i>Test Report No.:</i>	10052384 001	Auftrags-Nr.: <i>Order No.:</i>	114038549	Seite 1 von 50 <i>Page 1 of 50</i>
Kunden-Referenz-Nr.: <i>Client Reference No.:</i>	N/A	Auftragsdatum: <i>Order date:</i>	22-Jul-2015	
Auftraggeber: <i>Client:</i>	Delta Electronics Incorporated, 3 Tungyuan Road Chungli Industrial Zone Taoyuan County			
Prüfgegenstand: <i>Test item:</i>	Bluetooth Speaker			
Bezeichnung / Typ-Nr.: <i>Identification / Type No.:</i>	VFRU-19-05BT			
Auftrags-Inhalt: <i>Order content:</i>	FCC Part 15C Test report			
Prüfgrundlage: <i>Test specification:</i>	FCC 47CFR Part 15: Subpart C Section 15.247			
Wareneingangsdatum: <i>Date of receipt:</i>	22-Jul-2015			
Prüfmuster-Nr.: <i>Test sample No.:</i>	A000231124-003 A000231124-002			
Prüfzeitraum: <i>Testing period:</i>	27-Jul-2015 - 11-Aug-2015			
Ort der Prüfung: <i>Place of testing:</i>	EMC Laboratory Taipei			
Prüflaboratorium: <i>Testing laboratory:</i>	TUV Rheinland Taiwan Ltd.			
Prüfergebnis*: <i>Test result*:</i>	Pass			
geprüft von / tested by:		kontrolliert von / reviewed by:		
2015-09-07	Ryan W. T. Chen / Project Engineer	2015-09-07	Rene Charton/Senior Project Manager	
<i>Datum</i>	<i>Name / Stellung</i>	<i>Unterschrift</i>	<i>Datum</i>	<i>Name / Stellung</i>
<i>Date</i>	<i>Name / Position</i>	<i>Signature</i>	<i>Date</i>	<i>Name / Position</i>
Sonstiges / Other:				
Zustand des Prüfgegenstandes bei Anlieferung: <i>Condition of the test item at delivery:</i>		Prüfmuster vollständig und unbeschädigt <i>Test item complete and undamaged</i>		
* Legende:	1 = sehr gut P(ass) = entspricht o.g. Prüfgrundlage(n)	2 = gut F(ail) = entspricht nicht o.g. Prüfgrundlage(n)	3 = befriedigend N/A = nicht anwendbar	4 = ausreichend N/T = nicht getestet
Legend:	1 = very good P(ass) = passed a.m. test specification(s)	2 = good F(ail) = failed a.m. test specification(s)	3 = satisfactory N/A = not applicable	4 = sufficient N/T = not tested
Dieser Prüfbericht bezieht sich nur auf das o.g. Prüfmuster und darf ohne Genehmigung der Prüfstelle nicht auszugsweise vervielfältigt werden. Dieser Bericht berechtigt nicht zur Verwendung eines Prüfzeichens. <i>This test report only relates to the a. m. test sample. Without permission of the test center this test report is not permitted to be duplicated in extracts. This test report does not entitle to carry any test mark.</i>				

TEST SUMMARY

5.1.1 ANTENNA REQUIREMENT*RESULT: Passed***5.1.2 PEAK OUTPUT POWER***RESULT: Passed***5.1.3 20dB BANDWIDTH***RESULT: Passed***5.1.4 99% BANDWIDTH***RESULT: Passed***5.1.5 CONDUCTED SPURIOUS EMISSIONS AND FREQUENCY BAND EDGE MEASURED IN 100KHz BANDWIDTH***RESULT: Passed***5.1.6 SPURIOUS EMISSION***RESULT: Passed***5.1.7 FREQUENCY SEPARATION***RESULT: Passed***5.1.8 NUMBER OF HOPPING FREQUENCY***RESULT: Passed***5.1.9 TIME OF OCCUPANCY***RESULT: Passed***5.2.1 MAINS CONDUCTED EMISSIONS***RESULT: Passed***6.1.1 ELECTROMAGNETIC FIELDS***RESULT: Passed*

Contents

1.	GENERAL REMARKS	5
1.1	COMPLEMENTARY MATERIALS.....	5
2.	TEST SITES	6
2.1	TEST LABORATORY	6
2.2	TEST FACILITY.....	6
2.3	LIST OF TEST AND MEASUREMENT INSTRUMENTS.....	7
2.4	TRACEABILITY	8
2.5	CALIBRATION	8
2.6	MEASUREMENT UNCERTAINTY	8
3.	GENERAL PRODUCT INFORMATION.....	9
3.1	PRODUCT FUNCTION AND INTENDED USE	9
3.2	SYSTEM DETAILS AND RATINGS.....	9
3.3	INDEPENDENT OPERATION MODES.....	10
3.4	NOISE GENERATING AND NOISE SUPPRESSING PARTS	11
3.5	SUBMITTED DOCUMENTS.....	11
4.	TEST SET-UP AND OPERATION MODES.....	12
4.1	PRINCIPLE OF CONFIGURATION SELECTION	12
4.2	TEST OPERATION AND TEST SOFTWARE.....	12
4.3	SPECIAL ACCESSORIES AND AUXILIARY EQUIPMENT	12
4.4	COUNTERMEASURES TO ACHIEVE EMC COMPLIANCE.....	13
4.5	TEST SETUP DIAGRAM	13
5.	TEST RESULTS	15
5.1	TRANSMITTER REQUIREMENT & TEST SUITES	15
<i>5.1.1</i>	<i>Antenna Requirement</i>	<i>15</i>
<i>5.1.2</i>	<i>Peak Output Power.....</i>	<i>16</i>
<i>5.1.3</i>	<i>20dB Bandwidth</i>	<i>20</i>
<i>5.1.4</i>	<i>99% Bandwidth</i>	<i>24</i>
<i>5.1.5</i>	<i>Conducted spurious emissions and Frequency Band Edge measured in 100kHz Bandwidth.....</i>	<i>28</i>
<i>5.1.6</i>	<i>Spurious Emission</i>	<i>36</i>
<i>5.1.7</i>	<i>Frequency Separation.....</i>	<i>37</i>
<i>5.1.8</i>	<i>Number of hopping frequency.....</i>	<i>39</i>
<i>5.1.9</i>	<i>Time of Occupancy.....</i>	<i>41</i>
5.2	MAINS EMISSIONS.....	44
<i>5.2.1</i>	<i>Mains Conducted Emissions.....</i>	<i>44</i>

6.	SAFETY HUMAN EXPOSURE	45
6.1	RADIO FREQUENCY EXPOSURE COMPLIANCE	45
6.1.1	<i>Electromagnetic Fields.....</i>	<i>45</i>
7.	PHOTOGRAPHS OF THE TEST SET-UP.....	46
8.	LIST OF TABLES	50
9.	LIST OF PHOTOGRAPHS.....	50

1. General Remarks

1.1 Complementary Materials

The following attachments are integral parts of this test report:

- Appendix P: Photo Documentation**
(File Name: 10052384APPENDIX P)
- Appendix D: Test Result of Radiated Emissions**
(File Name: 10052384APPENDIX D)

Test Specifications

The following standards were applied

Table 1: Applied Standard and Test Levels

Radio
FCC CFR47 Part 15: Subpart C Section 15.247
RSS-247 Issue 1 May 2015
RSS-Gen, Issue 4, November 2014
ANSI C63.10:2013
Public Notice DA 00-705
NCC Low-power Radio-frequency Devices Technical Regulations LP0002(2011)(100年6月28日)

2. Test Sites

2.1 Test Laboratory

TUV Rheinland Taiwan Ltd.
Taichung Branch Office

No.9, Lane 36, Minsheng Rd., Sec. 3, Daya District,
Taichung City 428
Taiwan (R.O.C.)

2.2 Test Facility

TUV Rheinland Taiwan Ltd.
Taipei Office

11F. No.758, Sec. 4, Bade Rd., Songshan Dist.
Taipei City 105
Taiwan (R.O.C.)

FCC RegistrationNo.: 365730
IC Canada Registration No.: 9465A-1
TAF Accredited NCC Test Lab. No.:0759
TAF ISO17025 Certification effective periods: 2013-Jul-1st to 2016-Jun-30th



Testing Laboratory
0759

2.3 List of Test and Measurement Instruments

Table 2: List of Test and Measurement Equipment

Kind of Equipment	Manufacturer	Type	S/N	Last Calibration	Next Calibration
EMI Test Receiver	R&S	ESR7	101062	31-Aug-14	30-Aug-15
Bilog Antenna	TESEQ	CBL6111D	29802	4-Jul-14	3-Jul-16
Spectrum Analyzer	R&S	FSV 40	100921	17-Dec-14	16-Dec-15
Spectrum Analyzer	Agilent	N9010A	MY53470241	1-Apr-15	30-Mar-16
Horn Antenna	ETS-Lindgren	3117	138160	12-Jan-15	11-Jan-17
Horn Antenna (18GHz~40GHz)	COM-POWER	AH840	101031	30-Oct-13	29-Oct-15
Preamplifier (30MHz -1GHz)	HP	8447F	2805A03335	23-Aug-14	22-Aug-15
Preamplifier (18 GHz -40 GHz)	COM-POWER	PAM-840	461257	26-Aug-14	25-Aug-15
Pre-Amplifier (1GHz~18GHz)	EM Electronics	EM30180	60558	4-Nov-14	3-Nov-15
Loop Antenna	Schwarzbeck	FMZB 1513	1513-076	22-Oct-14	21-Oct-15
EMI Test Receiver	R&S	ESCI7	100797	28-Dec-14	27-Dec-15
Spectrum Analyzer	R&S	FSL3	101943	14-Sep-14	13-Sep-15
LISN (1 phase)	R&S	ENV216	101243	1-Jun-15	31-May-16
LISN	Rolf Heine	NNB-2/16Z	99080	26-Aug-14	25-Aug-15

2.4 Traceability

All measurement equipment calibrations are traceable to NML(Taiwan)/NIST(USA) or where calibration is performed outside Taiwan, to equivalent nationally recognized standards organizations.

2.5 Calibration

requiring calibration is calibrated periodically in a suitably accredited Calibration Lab. Additionally all equipment is verified for proper performance on a regular basis using in house standards or comparisons.

2.6 Measurement Uncertainty

The estimated combined standard uncertainty for radiated emissions and conducted emissions measurements:.

Table 3: Emission Measurement Uncertainty

Parameter	Uncertainty
RF power, conducted	± 1.5 dB
Adjacent channel power	± 3 dB
Radiated emission of transmitter, valid up to 26 GHz	± 6 dB
Radiated emission of receiver, valid up to 26 GHz	± 6 dB
Temperature	± 2 °C
Humidity	± 10 %

3. General Product Information

3.1 Product Function and Intended Use

The EUT is a Bluetooth Speaker. It contains a Bluetooth 3.0 compatible module enabling the user to communicate data through a Wireless interface.
For details refer to the User Guide, Data Sheet and Circuit Diagram.

3.2 System Details and Ratings

Table 4: Basic Information of EUT

Item	EUT information
Kind of Equipment	Bluetooth Speaker
Type Designation	VFRU-19-05BT
FCC ID	H79VFRU-19-05BT

Table 5: Technical Specification of EUT

Technical Specification	Value
Operating Frequency	2402 MHz ~ 2480 MHz
Channel Spacing	1 MHz
Channel number	79
Operation Voltage	5VDC
Modulation	GFSK, $\pi/4$ DQPSK, 8 DPSK
Antenna gain	2.29 dBi

Table 6: Frequency hopping information

Technical Specification	Description
Hopping Range	Hereby we declare that the maximum frequency of this device is: 2402-2480MHz. This is according the Bluetooth Core Specification V2.1+EDR for devices which will be operated in the USA. This was checked during the Bluetooth Qualification tests (Test Case: TRM/CA/04).
Hopping Sequence	Example of a 79 hopping sequence in data mode: 33,04,21,44,23,42,53,46,55,48,40,59,72,29,76,31,08,73,07,75,09,45,60,39,58,13,47,11,77,52,35,50,65,54,67,56,69,62,71,64, 7,25,27,66,57,70,74,61,78,63,10,41,05,43,15,44,64,68,02,70,06,01,51,03,55,05,03,66,53,49,36,47,
Receiver input bandwidth	<p>The input bandwidth of the receiver is 1MHz. In every connection one Bluetooth device is the master and the other one is the slave. The master determines the hopping sequence. The slave follows this sequence. Both devices shift between RX and TX time slot according to the clock of the master.</p> <p>Additionally the type of connection is set up at the beginning of the connection. The master adapts its hopping frequency and its TX/RX timing according to the packet type of the connection. Also the slave of the connection will use these settings.</p> <p>Repeating of a packer has no influence on the hopping sequence. The hopping sequence generated by the master of the connection will be followed in any case.</p> <p>That means a repeated packet will not be send on the same frequency, it is send on the next frequency of the hopping sequence.</p>

3.3 Independent Operation Modes

The basic operation modes are:

- A. Transmitting
 - 1. Low channel
 - 2. Middle channel
 - 3. High channel
- B. Receiving
- C. Standby
- D. Off

3.4 Noise Generating and Noise Suppressing Parts

Refer to the Circuit Diagram.

3.5 Submitted Documents

- Circuit Diagram
- Instruction Manual
- Rating Label
- Technical Description

4. Test Set-up and Operation Modes

4.1 Principle of Configuration Selection

The equipment under test (EUT) was configured to measure its maximum power level. The test modes were adapted accordingly in reference to the instructions for use.

4.2 Test Operation and Test Software

Test operation refers to test setup in chapter 4. All testing were performed according to the procedures in ANSI C63.10: 2013 and DA 00-705 of March 30, 2000.

The samples were used as follows:

Conducted: **A000231124-002**

Radiation: **A000231124-003**

Full test was applied on all test modes, but only worst case was shown.

4.3 Special Accessories and Auxiliary Equipment

The product has been tested together with the following additional accessories:

Kind of Equipment	Manufacturer	S/N
Laptop	HP	CNF0339QBM

4.4 Countermeasures to achieve EMC Compliance

The test sample which has been tested containing the noise suppression parts as in the Photo Appendix and the Test Setup Photos. No additional measures were employed to achieve compliance.

4.5 Test Setup Diagram

Diagram of Measurement Configuration for Radiation Test

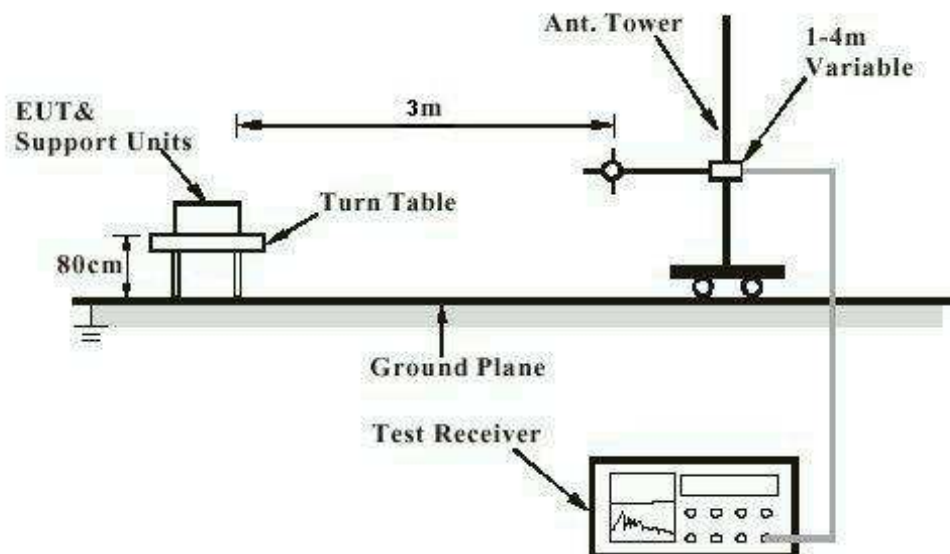

Note: Measurements above 1 GHz are done with a table height of 1.5m

Diagram of Measurement Equipment Configuration for Mains Conduction Measurement

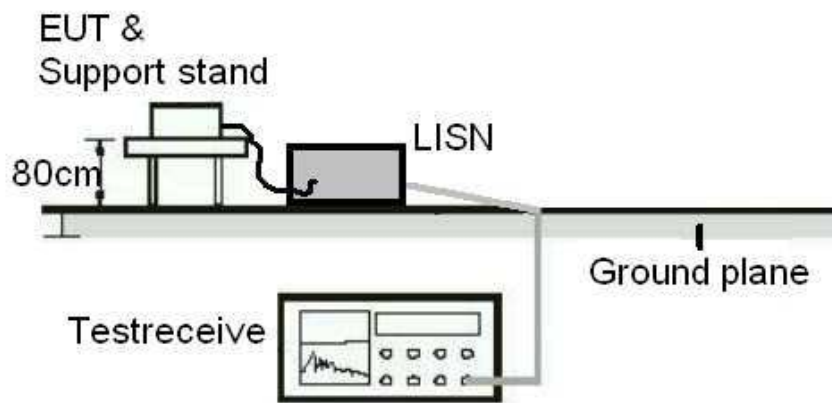
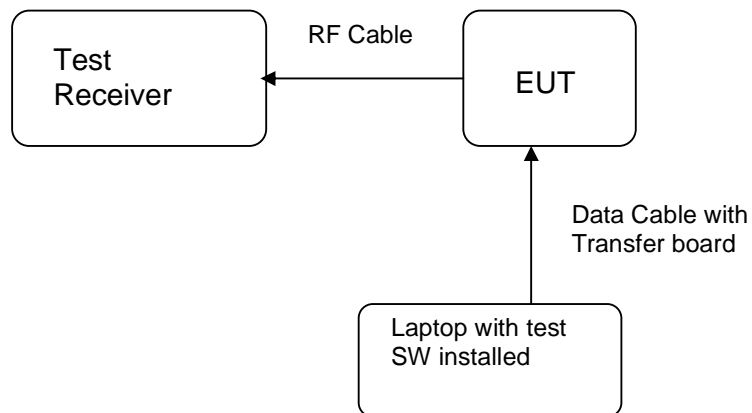

Diagram of Measurement Equipment Configuration for Conducted Transmitter Measurement



5. Test Results

5.1 Transmitter Requirement & Test Suites

5.1.1 Antenna Requirement

RESULT: **Passed**

Test standard	:	LP0002(2011): 2.2, 3.10.1, (3) FCC Part 15.247(b)(4), Part 15.203 and RSS- Gen 8.3
Requirement	:	use of approved antennas only with directional gains that do not exceed 6 dBi

According to the manufacturer declaration, the EUT has an antenna with a directional gain of 2.29 dBi. The antenna is a printed PCB trace with no possibility of replacement with a non-approved antenna by the end-user. Therefore, the EUT is considered to comply with this provision.

Refer to EUT photo for details.

5.1.2 Peak Output Power

RESULT: **Passed**

Test standard : FCC Part 15.247(b)(1),
 RSS-247 5.4(2)
 LP0002(2011): 3.10.1, (2)
 Basic standard : DA 00-705 of March 30, 2000
 LP0002(2011) Appendix II
 Kind of test site : Shielded room

Test setup

Test Channel : Low/ Middle/ High
 Operation Mode : A

Ambient temperature : 22-26 °C
 Relative humidity : 50-65 %
 Atmospheric pressure : 100-103 kPa

Table 7: Test result of Peak Output Power, GFSK modulation

Channel	Channel Frequency	Peak Output Power		Limit	Result
	(MHz)	(dBm)	(W)	(W)	
Low Channel	2402	7.11	0.00514	0.125	Pass
Middle Channel	2441	6.34	0.00431	0.125	Pass
High Channel	2480	6.52	0.00449	0.125	Pass

Table 8: Test result of Peak Output Power, 8DPSK modulation

Channel	Channel Frequency	Peak Output Power		Limit	Result
	(MHz)	(dBm)	(W)	(W)	
Low Channel	2402	6.35	0.00432	0.125	Pass
Middle Channel	2441	5.55	0.00359	0.125	Pass
High Channel	2480	5.65	0.00368	0.125	Pass

Pmax: 5.1357 mW

Test Plot of Peak Output Power, GFSK modulation

Low Channel

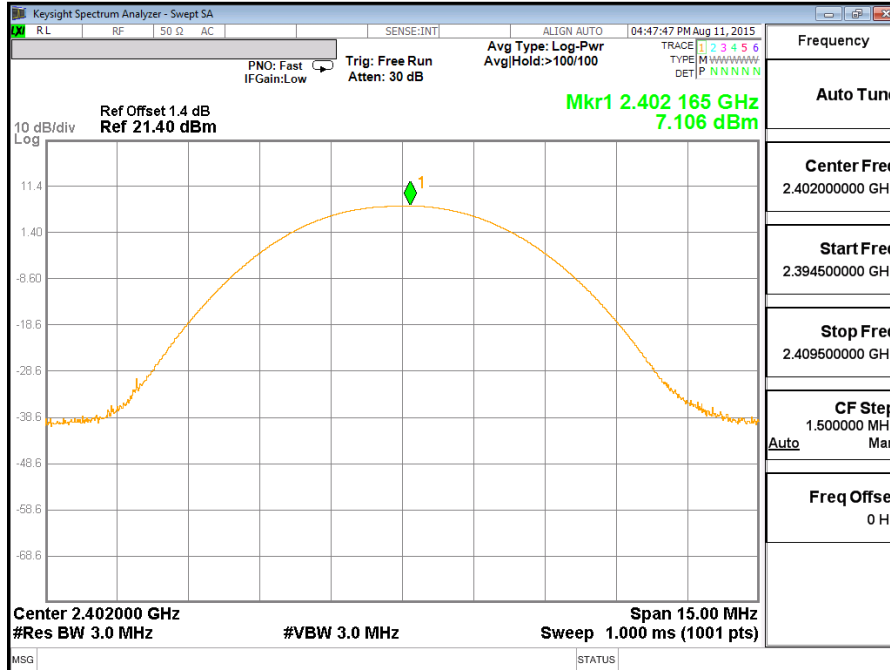

Middle Channel

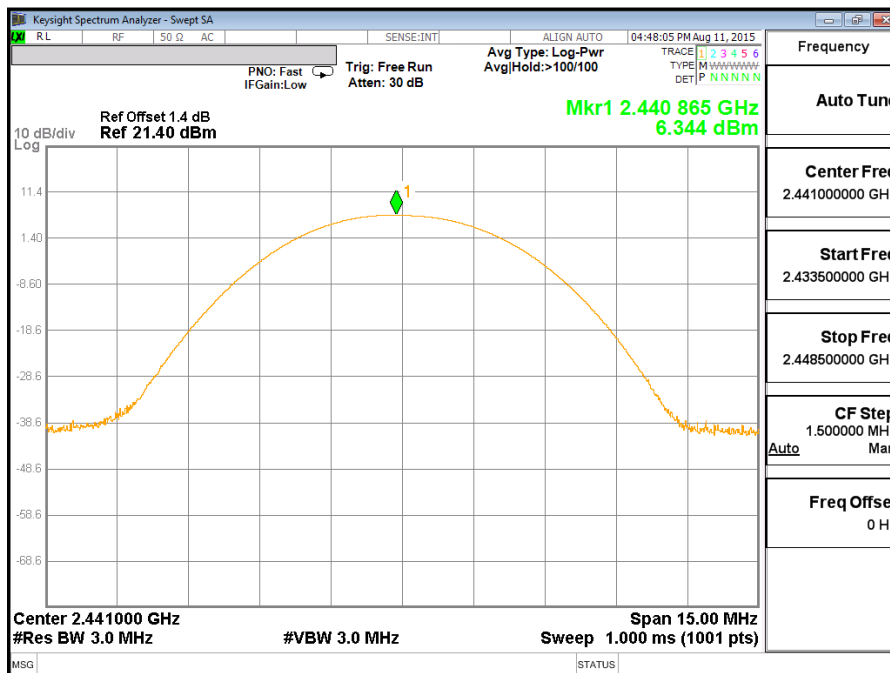

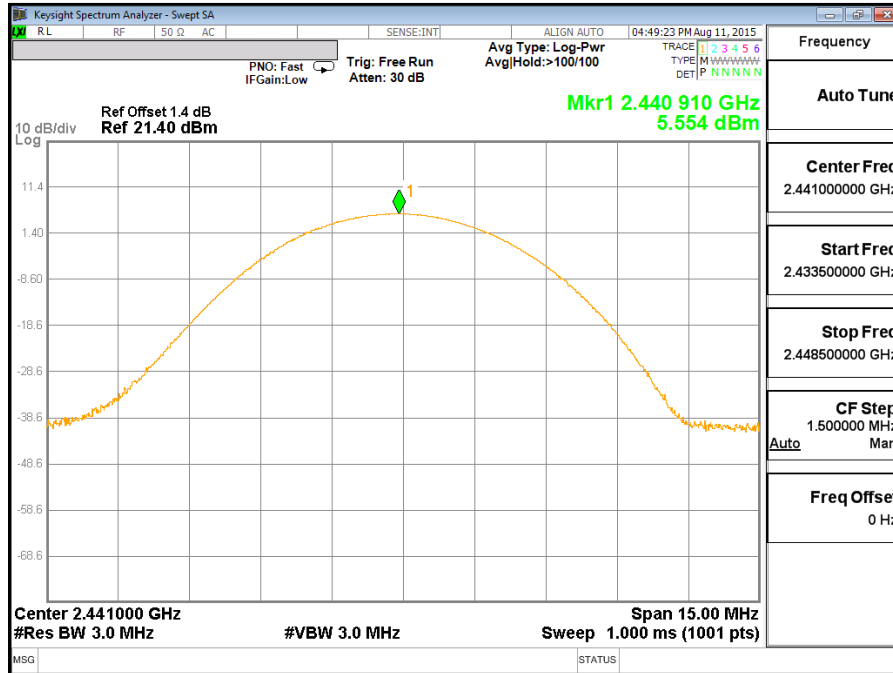
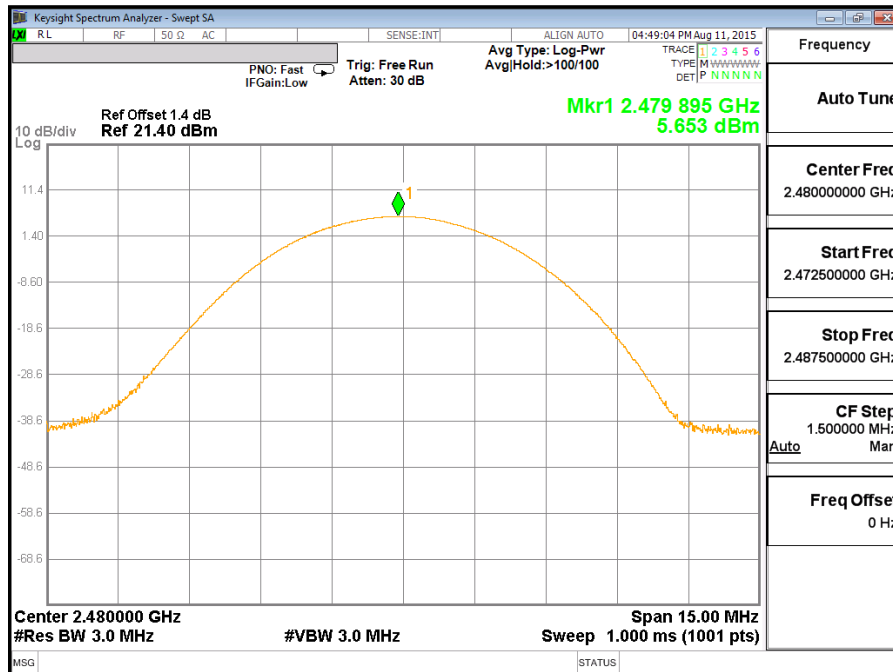
Middle Channel

High Channel

5.1.3 20dB Bandwidth

RESULT:
Passed

Test standard : FCC Part 15.247(a)(1),
 RSS-247 5.1(1)
 LP0002(2011): 3.10.1, (6.1.1)

Basic standard : DA 00-705 of March 30, 2000
 LP0002(2011) Appendix II

Kind of test site : Shielded room

Test setup

Test Channel : Low/ Middle/ High
 Operation Mode : A

Ambient temperature : 22-26°C
 Relative humidity : 50-65%
 Atmospheric pressure : 100-103kPa

Table 9: Test result of 20dB Bandwidth, GFSK modulation

Channel	Channel Frequency (MHz)	20dB Bandwidth (kHz)	Limit (MHz)	Result
Low Channel	2402	936.5	1.5	Pass
Mid Channel	2441	933.4	1.5	Pass
High Channel	2480	934.6	1.5	Pass

Note: Limit is for Channel Separation of 1 MHz and a power limit of 125 mW.

Table 10: Test result of 20dB Bandwidth, 8DPSK modulation

Channel	Channel Frequency (MHz)	20dB Bandwidth (kHz)	Limit (MHz)	Result
Low Channel	2402	1287	1.5	Pass
Mid Channel	2441	1286	1.5	Pass
High Channel	2480	1287	1.5	Pass

Note: Limit is for Channel Separation of 1 MHz and a power limit of 125 mW.

If the carrier separation frequency of a Bluetooth Device is set at 1 MHz due to the firmware setting and the Bluetooth Standard, then the limit for the 20 dB Bandwidth, becomes $1 \text{ MHz} / 0.66666 = 1.5 \text{ MHz}$.

Test Plot of 20dB Bandwidth, GFSK modulation

Low Channel

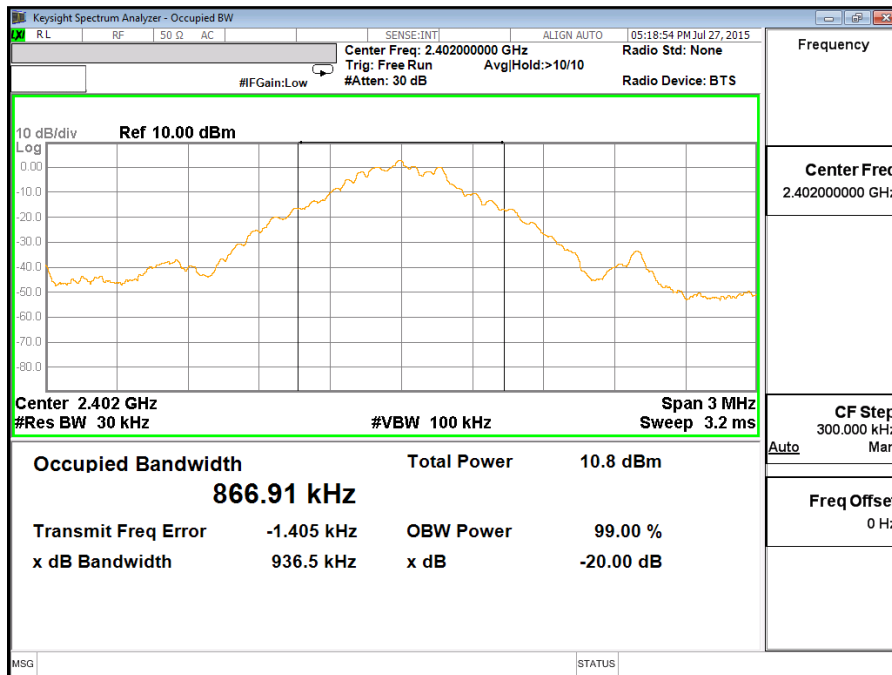

Middle Channel

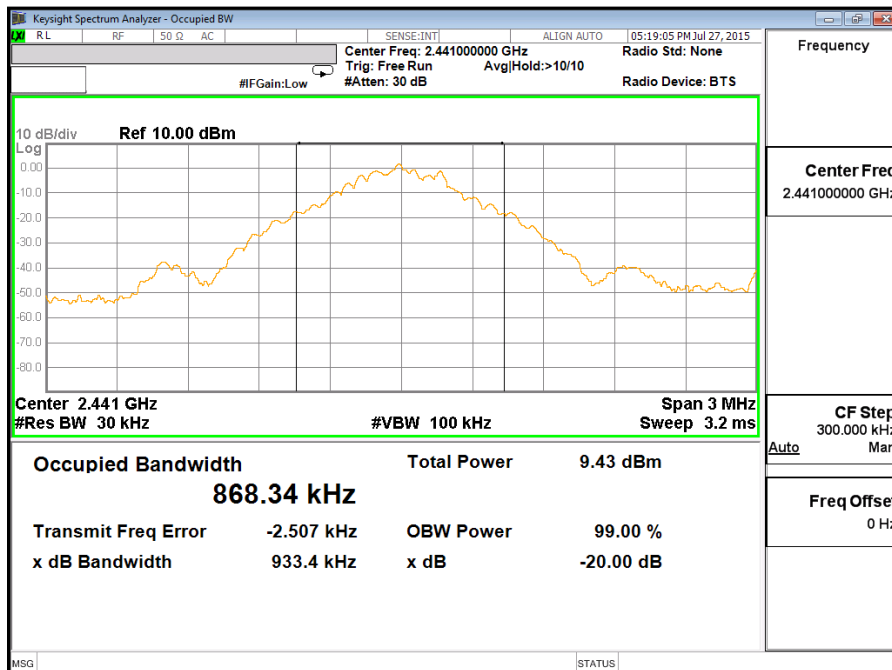

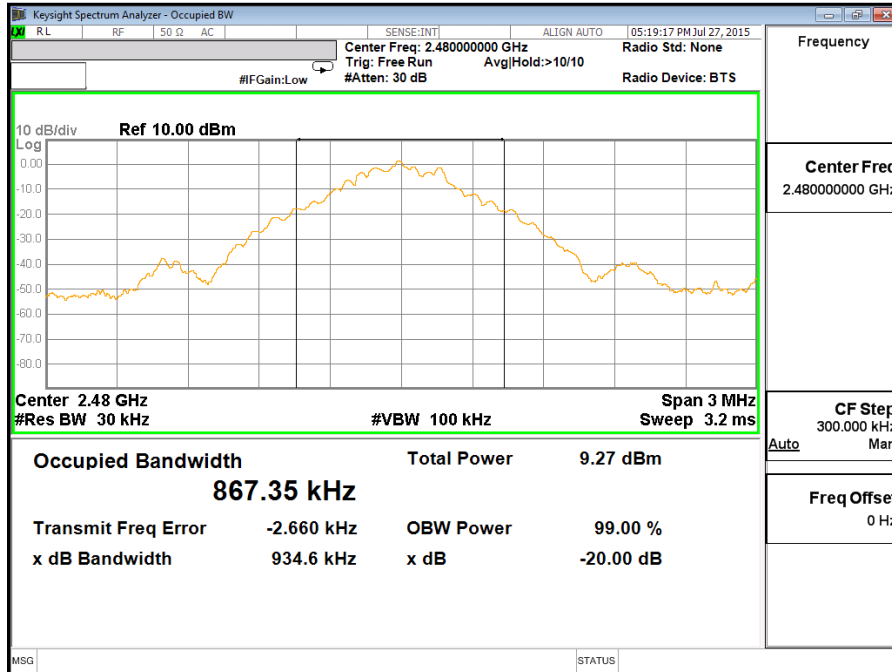
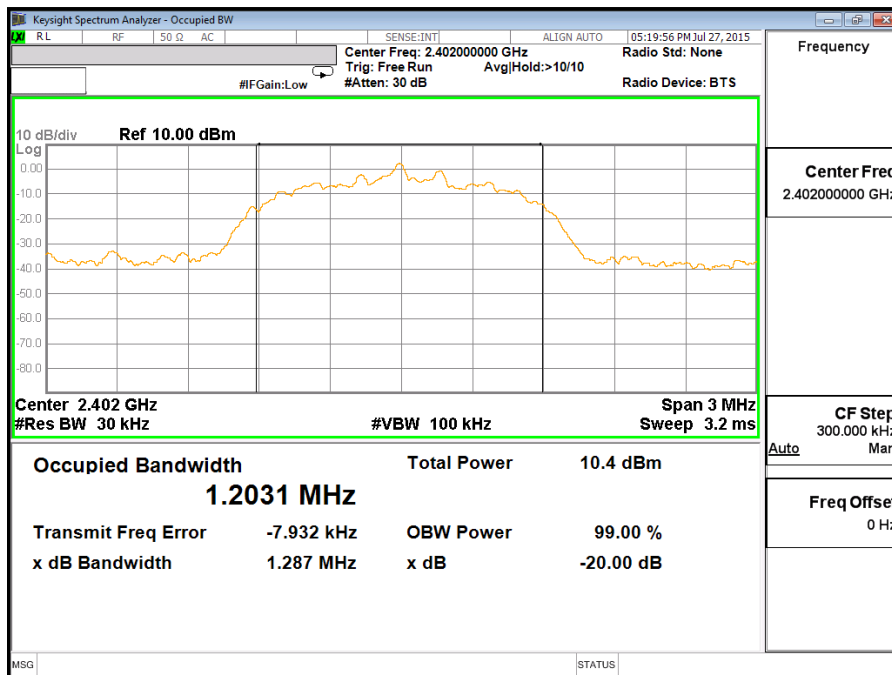
High Channel

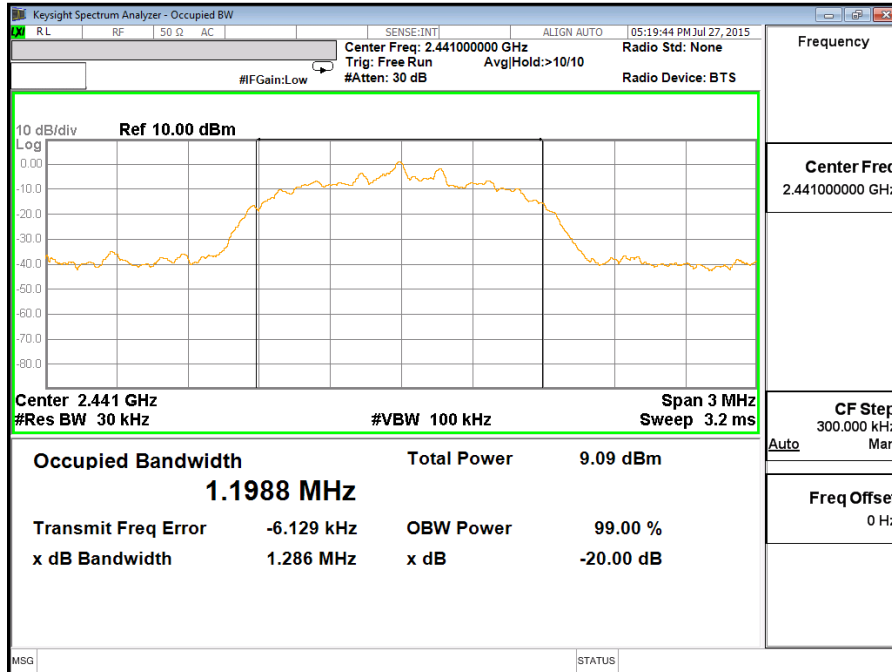
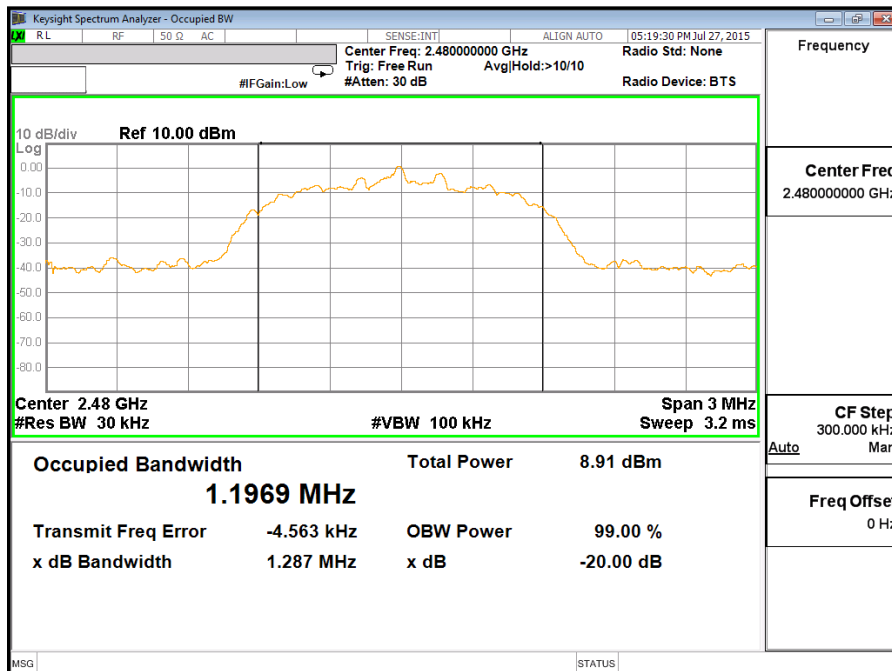
Test Plot of 20dB Bandwidth, 8DPSK modulation
Low Channel

Middle Channel

High Channel

5.1.4 99% Bandwidth

RESULT:
Passed

Test standard : RSS-Gen (Issue 4)
 Basic standard : RSS-Gen (Issue 4)
 Kind of test site : Shielded room

Test setup

Test Channel : Low/ Middle/ High
 Operation Mode : A

 Ambient temperature : 22-26°C
 Relative humidity : 50-65%
 Atmospheric pressure : 100-103kPa

Table 11: Test result of 99% Bandwidth, GFSK modulation

Channel	Channel Frequency (MHz)	99% Bandwidth (kHz)	Result
Low Channel	2402	874.54	Pass
Mid Channel	2441	869.09	Pass
High Channel	2480	872.71	Pass

Table 12: Test result of 99% Bandwidth, PSK modulation

Channel	Channel Frequency (MHz)	99% Bandwidth (kHz)	Result
Low Channel	2402	1204.9	Pass
Mid Channel	2441	1198	Pass
High Channel	2480	1200	Pass

Test Plot of 99% Bandwidth, GFSK modulation

Low Channel

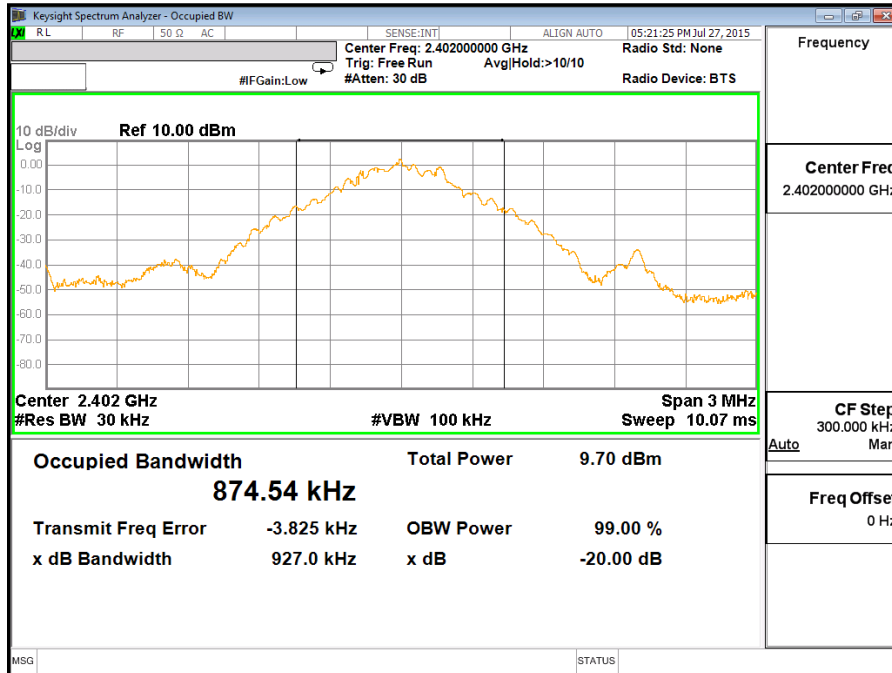

Middle Channel

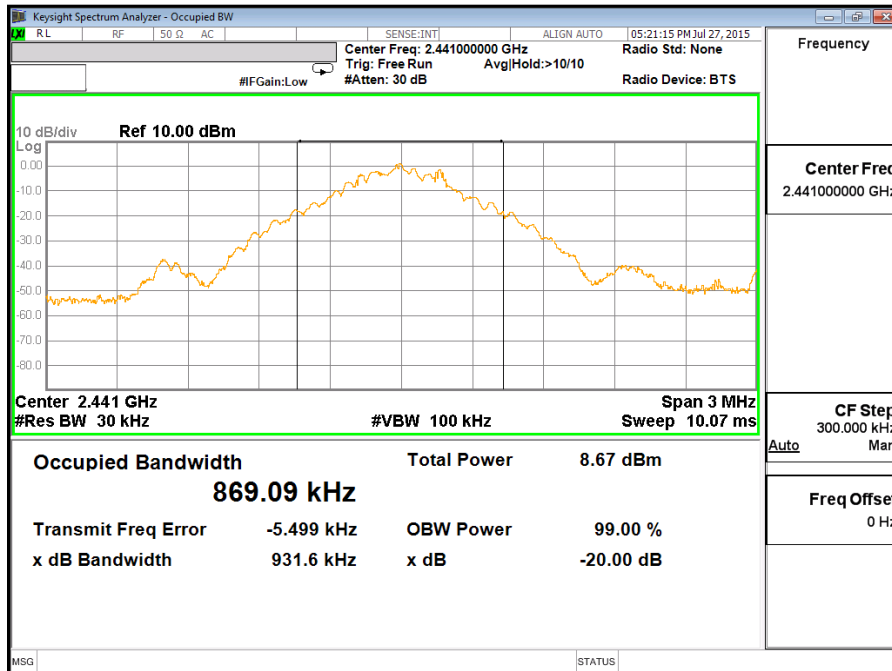

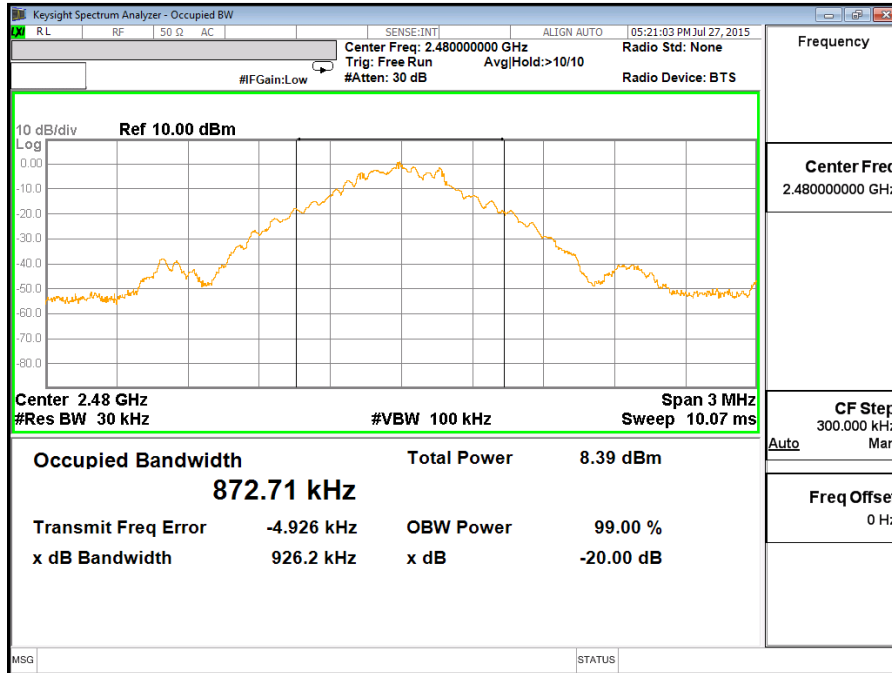
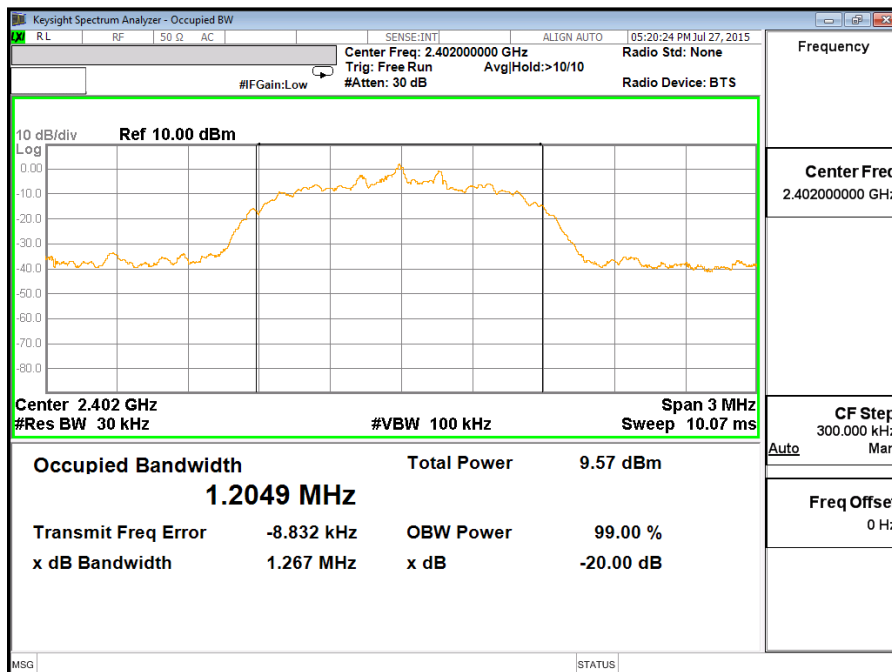
High Channel

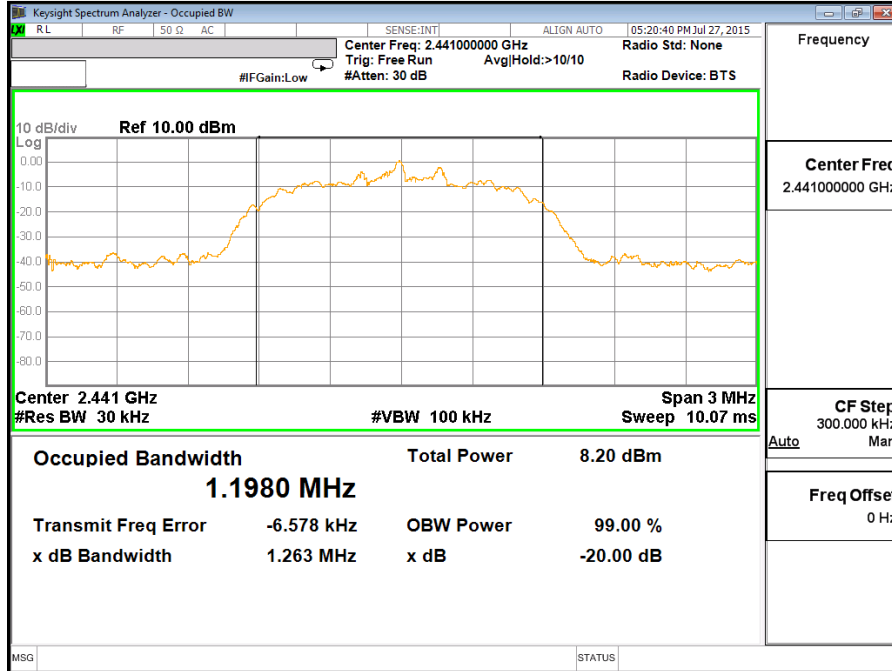
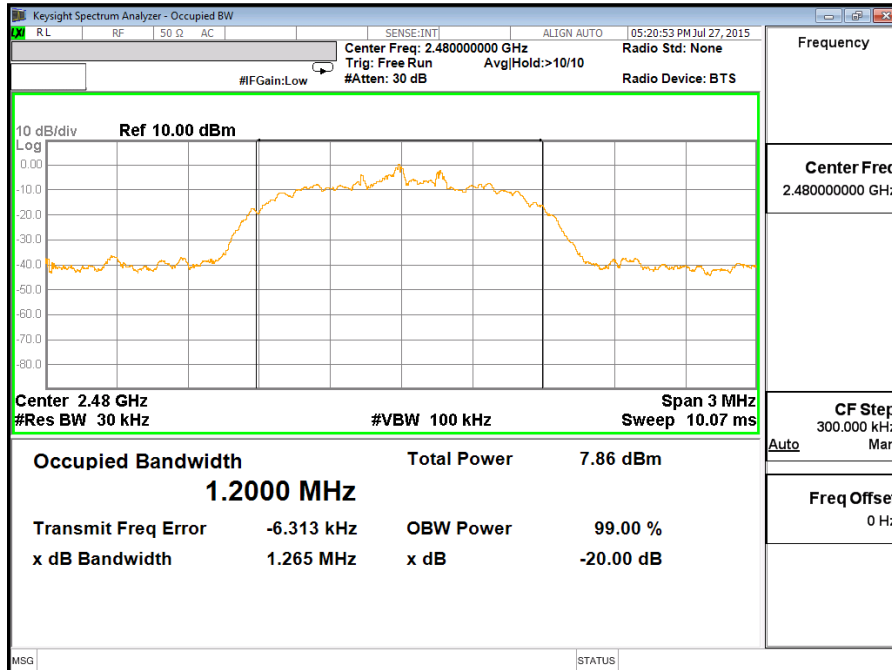
Test Plot of 99% Bandwidth, 8DPSK modulation
Low Channel

Middle Channel

High Channel

5.1.5 Conducted spurious emissions and Frequency Band Edge measured in 100kHz Bandwidth

RESULT: **Passed**

Test standard	:	FCC part 15.247(d), RSS-247 5.5 LP0002(2011): 3.10.1, (5)
Basic standard	:	DA 00-705 of March 30, 2000 LP0002(2011) Appendix II
Limit	:	20dB (below that in the 100kHz bandwidth within the band that contains the highest level of the desired power)
Kind of test site	:	Shielded room

Test setup

Test Channel	:	Low/ Middle/ High
Operation Mode	:	A
Ambient temperature	:	22-26°C
Relative humidity	:	50-65%
Atmospheric pressure	:	100-103 kPa

All emissions are more than 20dB below fundamental, details refer to following test plot, and compliance is achieved as well.

Due to the small size of the product and that there are no inductive components of significant size, 9kHz to 30MHz frequency range is not tested based on technical judgment.

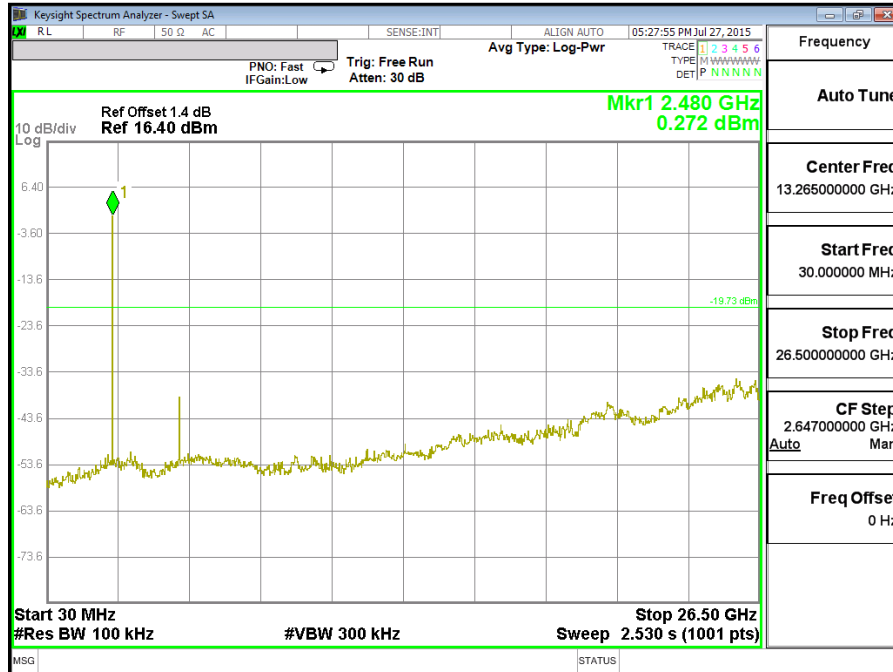
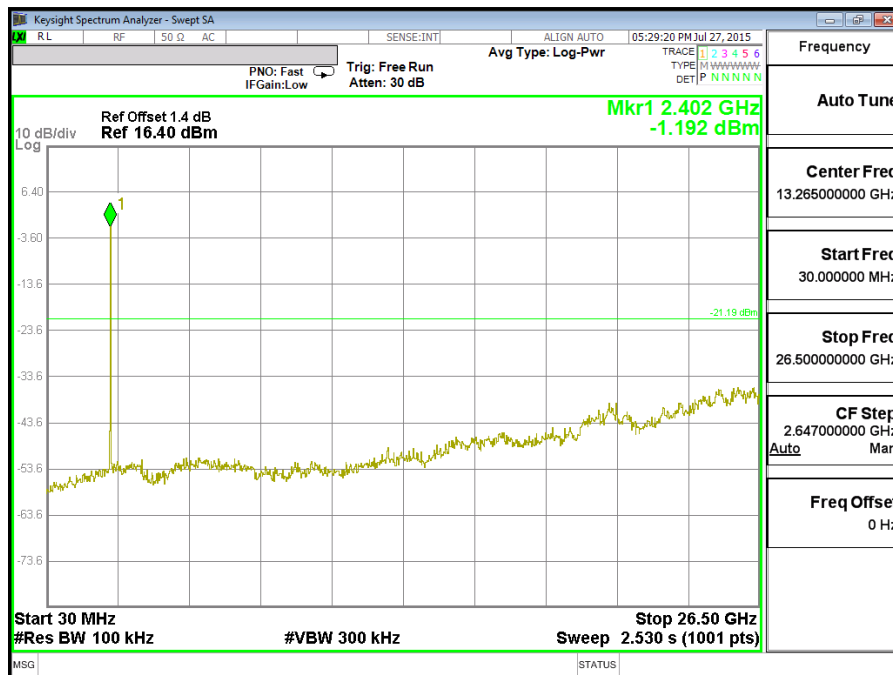
High Channel

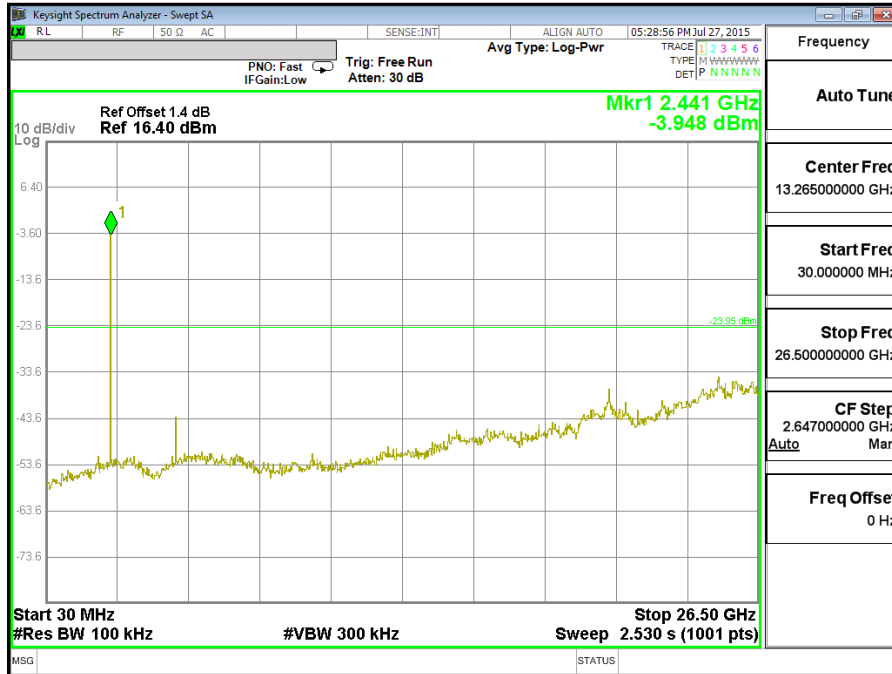
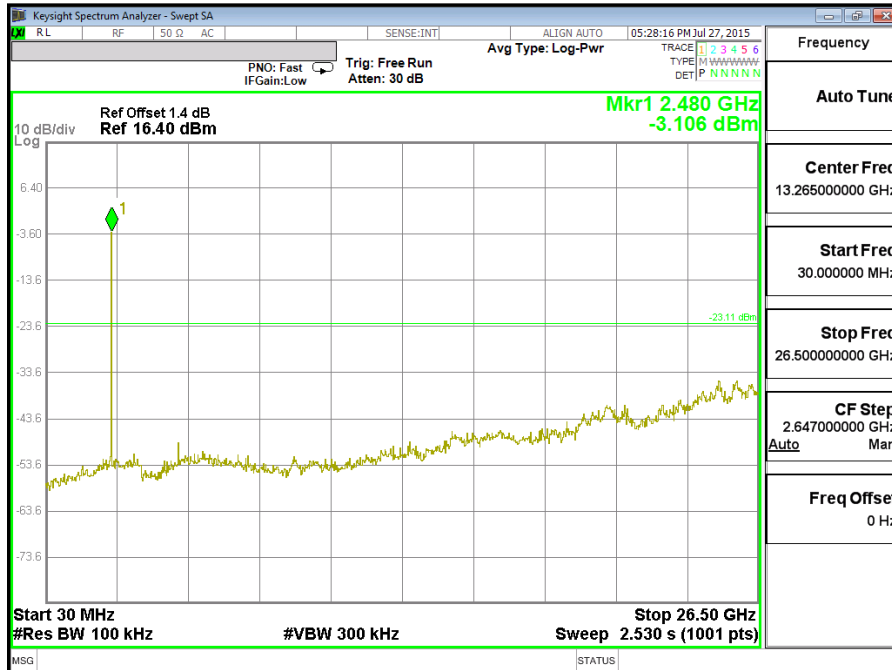
Test Plot of 100kHz Conducted Emissions, 8DPSK modulation
Low Channel

Middle Channel

High Channel

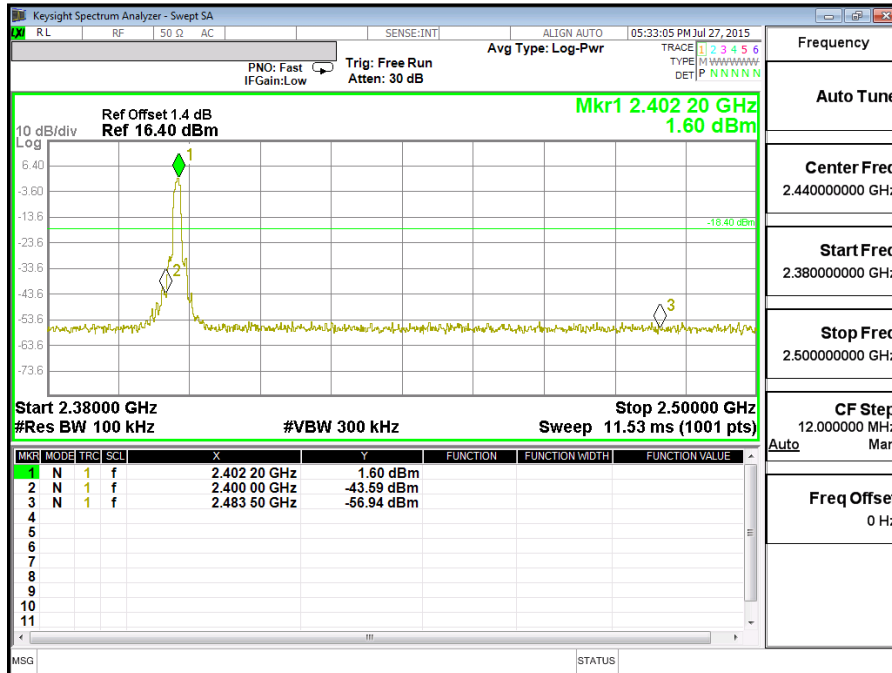
Test Plot of 100kHz Bandwidth of Frequency Band Edge, 8DPSK modulation

Low Channel

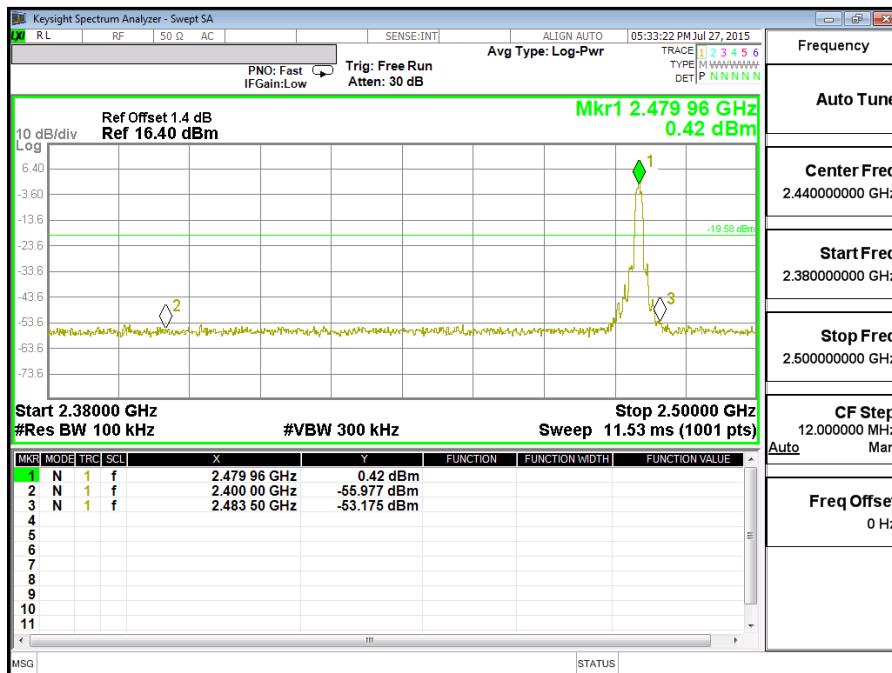

High Channel



5.1.6 Spurious Emission

RESULT:**Passed**

Test standard	:	FCC part 15.247(d), FCC 15.205, FCC 15.209, RSS-210 2.2, RSS-247 5.5 and RSS-Gen 8.9 LP0002(2011): 3.10.1, (5)
Basic standard	:	ANSI C63.10
Limits	:	Radiated emissions which fall in the restricted bands, as defined in FCC 15.205(a) and RSS-Gen i4, 8.9 (Table 6), must comply with the radiated emission limits specified in FCC 15.209(a) and RSS-Gen i4, 8.9 (Table 4 and 5). Radiated emissions which fall in the restricted bands, as defined in LP0002(2011): 2.7 , must comply with the radiated emission limits specified in LP0002(2011): 2.8 Emission radiated outside the specified frequency bands must comply with the radiated emission limits specified in FCC 15.209(a) and FCC 15.249(a), RSS-Gen i4, 8.9 (Table 4 and 5) and RSS-210 A2.9(a). Emission radiated outside the specified frequency bands must comply with the radiated emission limits specified in LP0002(2011): 2.8
Kind of test site	:	3m Semi-Anechoic Chamber

Test setup

Test Channel	:	Low/ Middle/ High
Operation Mode	:	A, B

Remark: Testing was carried out within frequency range 30MHz to the tenth harmonic. For details refer to Appendix D. The Radiated Emissions testing was performed in the X, Y and Z axis orientation. The worst-case Axis orientation is recorded in this test report. Due to the small size of the product and that there are no inductive components of significant size, 9kHz to 30MHz frequency range is not tested based on technical judgment.

5.1.7 Frequency Separation

RESULT: **Passed**

Test standard : FCC part 15.247(a)(1)
 RSS-247 5.1
 LP0002(2011): 3.10.1, (6.1.1)

Basic standard : DA 00-705 of March 30, 2000
 LP0002(2011) Appendix II

Limit : $\geq 25\text{kHz}$ or $2/3$ of 20dB bandwidth, whichever is greater

Test setup

Test Channel : Low/ Middle/ High
 Operation Mode : A
 Ambient temperature : 24°C
 Relative humidity : 53%

Table 13: Test result of Frequency Separation

Channel	Channel Frequency (MHz)	Measured Channel Separation (MHz)	Limit (kHz)	Result
Record Channel	2441	1	$\geq 25\text{kHz}$ or $2/3$ of 20dB bandwidth	Pass
Record Channel adj 1	2440			
Record Channel adj 2	2442			

Test Plot of Frequency Separation

GFSK

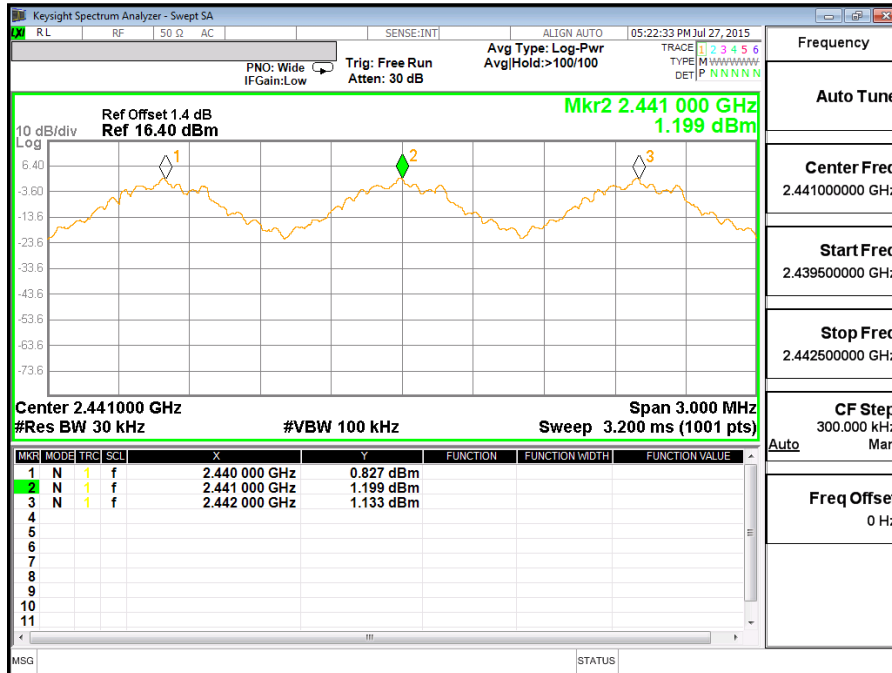

5.1.8 Number of hopping frequency**RESULT: Passed**

Test standard : FCC part 15.247(a)(1)(iii)
RSS-247 5.1(5)
LP0002(2011): 3.10.1, (6.1.2)

Basic standard : DA 00-705 of March 30, 2000
LP0002(2011) Appendix II

Test setup

Test Channel : Hopping On

Ambient temperature : 22-26°C
Relative humidity : 50-65%
Atmospheric pressure : 100-103 kPa

Table 14: Test result of Number of hopping frequency

Frequency Range	Measured Quantity of Hopping Channel	Limit	Result
<u>2400</u> to <u>2483.5</u> MHz	79	≥15	Pass

Test Plot of Number of hopping frequencies

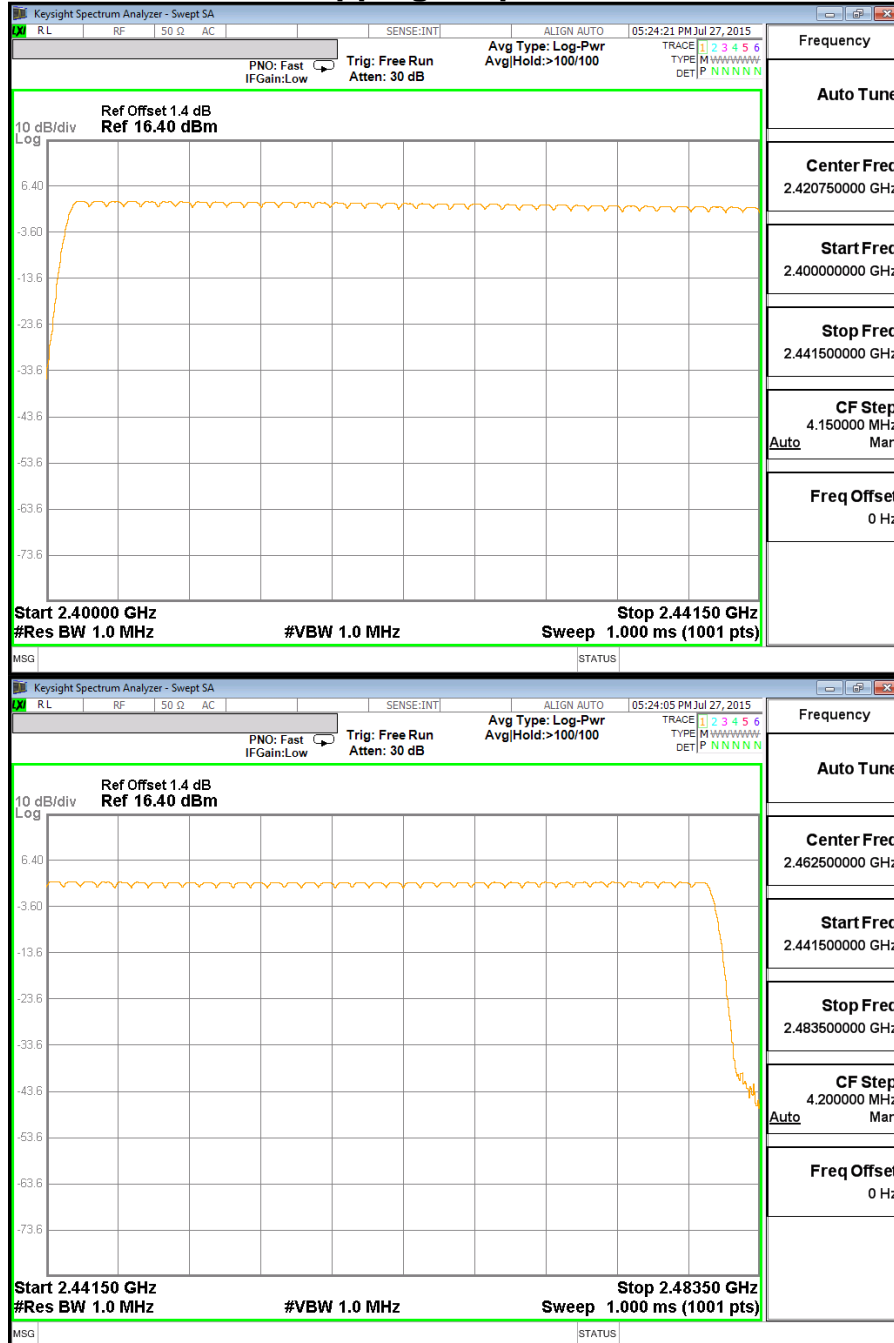

5.1.9 Time of Occupancy

RESULT:
Passed

Test standard : FCC part 15.247(a)(1)(iii)
 RSS-247 5.1(5)
 LP0002(2011): 3.10.1, (6.1.2)
 Basic standard : DA 00-705 of March 30, 2000
 LP0002(2011) Appendix II
 Limits : 0.4s
 Kind of test site : Shield room

Test setup

Test Channel : Low/ Middle/ High
 Operation Mode : A
 Ambient temperature : 22-26°C
 Relative humidity : 50-65%
 Atmospheric pressure : 100-103 kPa

Table 15: Test result of Time of Occupancy

Data Mode	Captured Burst (s)	Dwell time (s)	On+Off time (s)	Limit (s)	Result
DH5	0.00304	0.3243	0.00375	0.4	Pass
3DH5	0.00306	0.3264	0.00375	0.4	Pass

Note:

Dwell time = Pulse width x (Hopping rate / Number of channels) x Period

Period = 0.4 (seconds/ channel) x 79 (channel) = 31.6 seconds.

Hopping rate = 1 / (On+Off time) = 266 Hz

Test Plot of Time of Occupancy, GFSK modulation

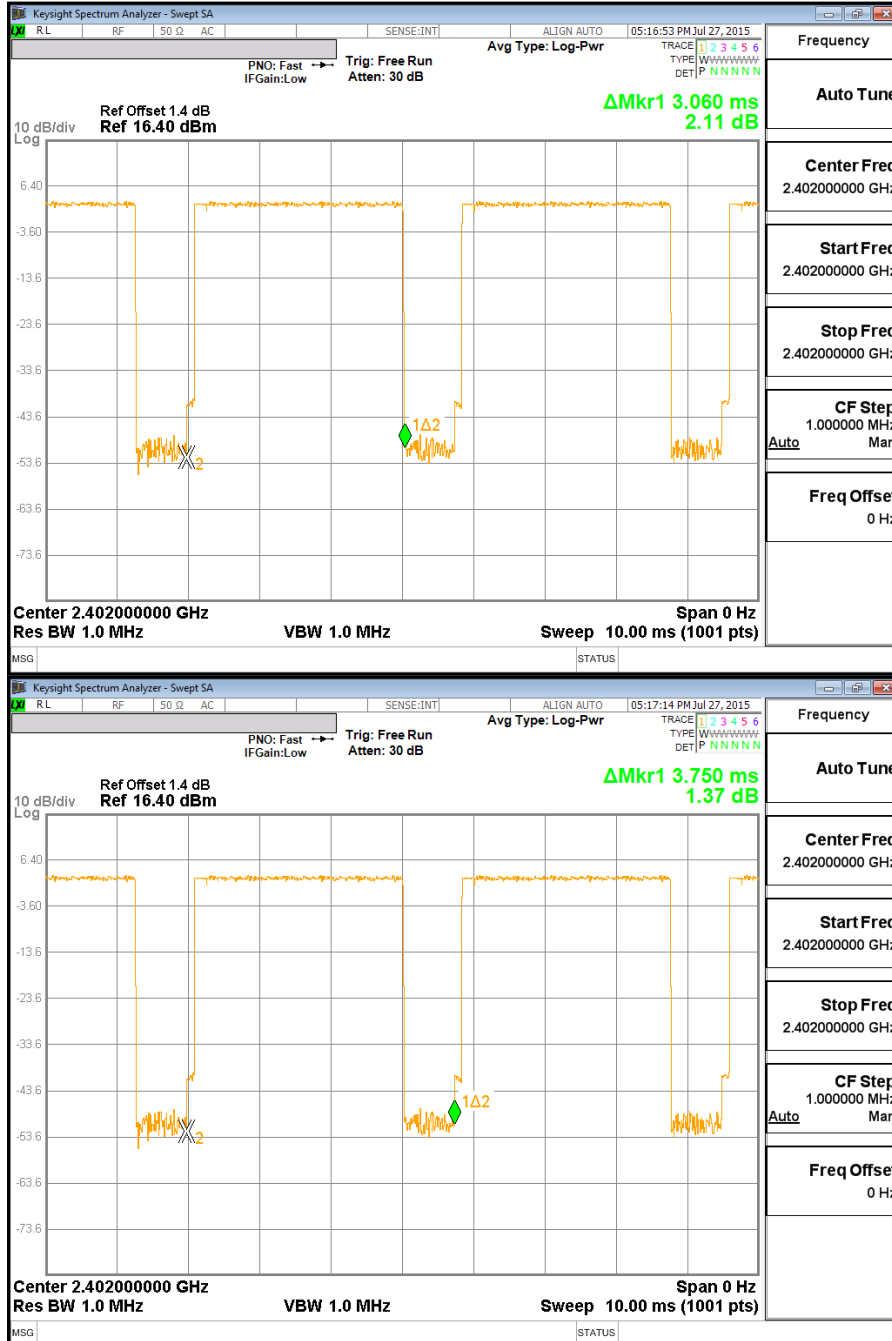

Test Plot of Time of Occupancy, 8DPSK modulation

5.2 Mains Emissions

5.2.1 Mains Conducted Emissions

RESULT:**Passed**

Test standard : FCC Part 15.207
FCC Part 15.107
RSS-Gen 8.8
LP0002: 2.3

Limits : Mains Conducted emissions as defined in
above test standards must comply with the
mains conducted emission limits specified

Kind of test site : Shielded Room

Test setup

Test Channel : Middle
Operation mode : A

Remark: For details refer to Appendix D.

6. Safety Human exposure

6.1 Radio Frequency Exposure Compliance

6.1.1 Electromagnetic Fields

RESULT:**Passed**

Test standard : FCC KDB Publication 447498

The maximum peak output power of the transmitter is 5.1357 mW.
The separation between hand and antenna is more than 5mm.

Hence the EUT is excluded from SAR evaluation.
Please also refer to FCC KDB publication 447498 D01 v05: Mobile Portable RF Exposure

7. Photographs of the Test Set-Up

Photograph 1: Set-up for Spurious Emissions (Front View)

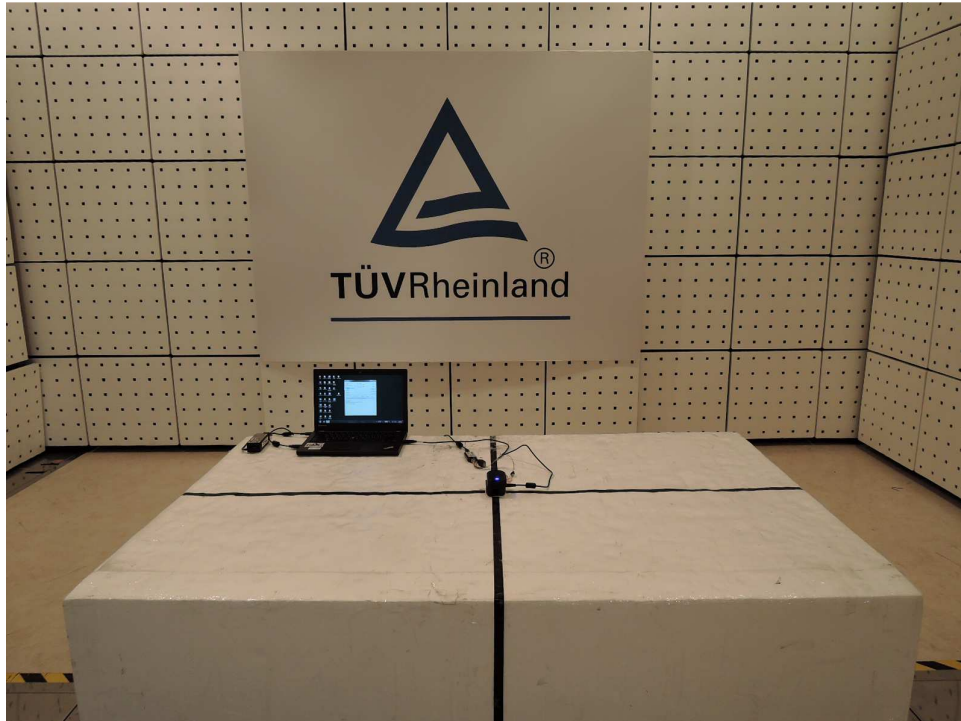

Photograph 2: Set-up for Spurious Emissions (Back View 1)

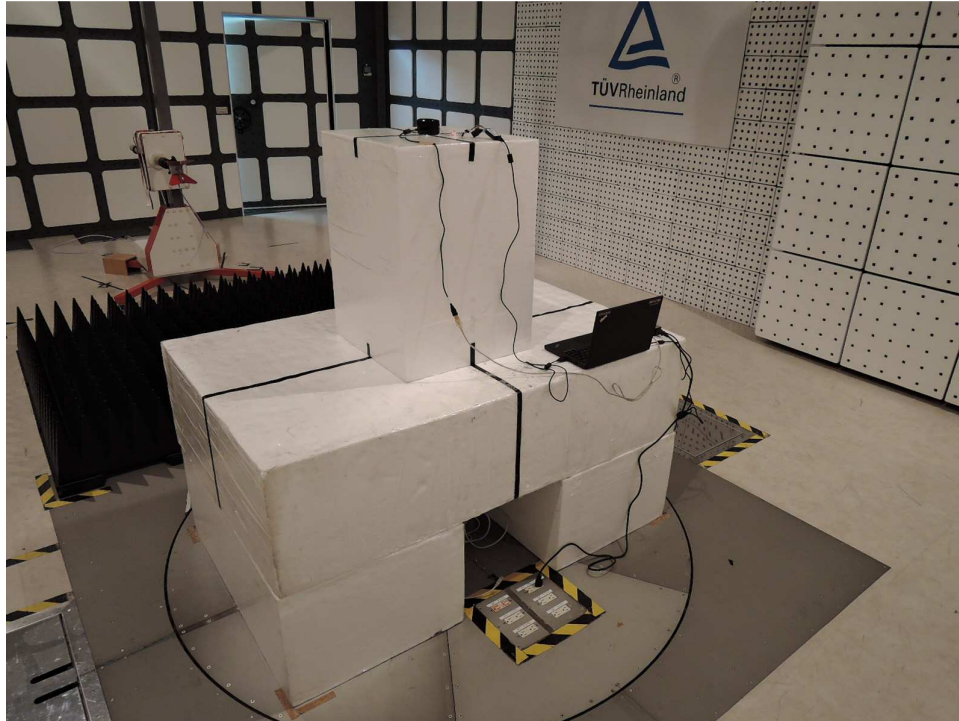

Photograph 3: Set-up for Spurious Emissions (Back View 2)

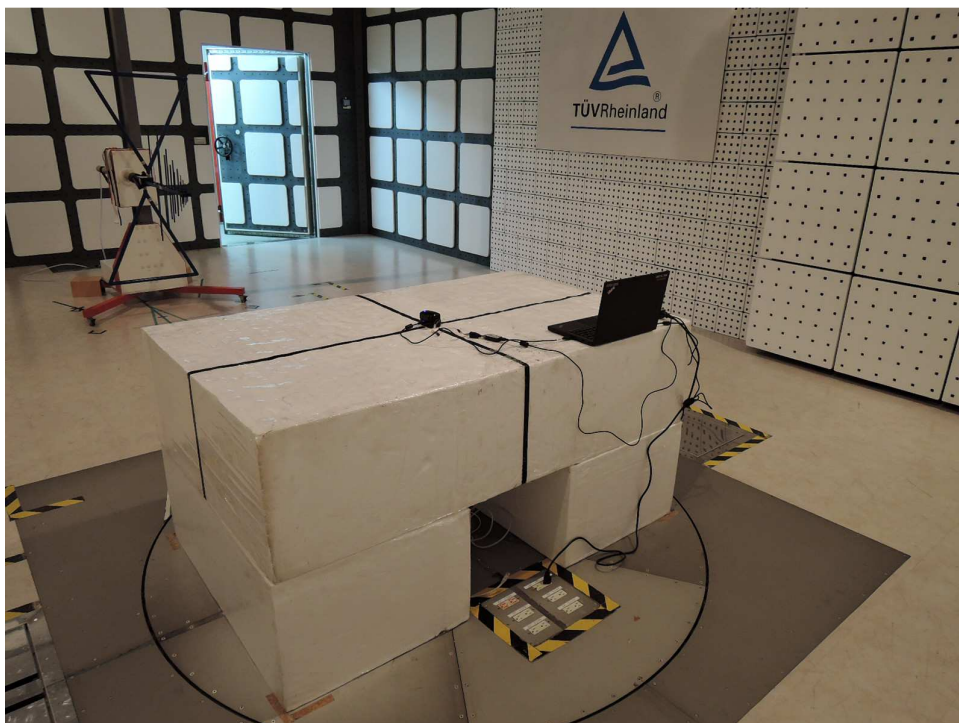

Photograph 4: Set-up for Conducted testing

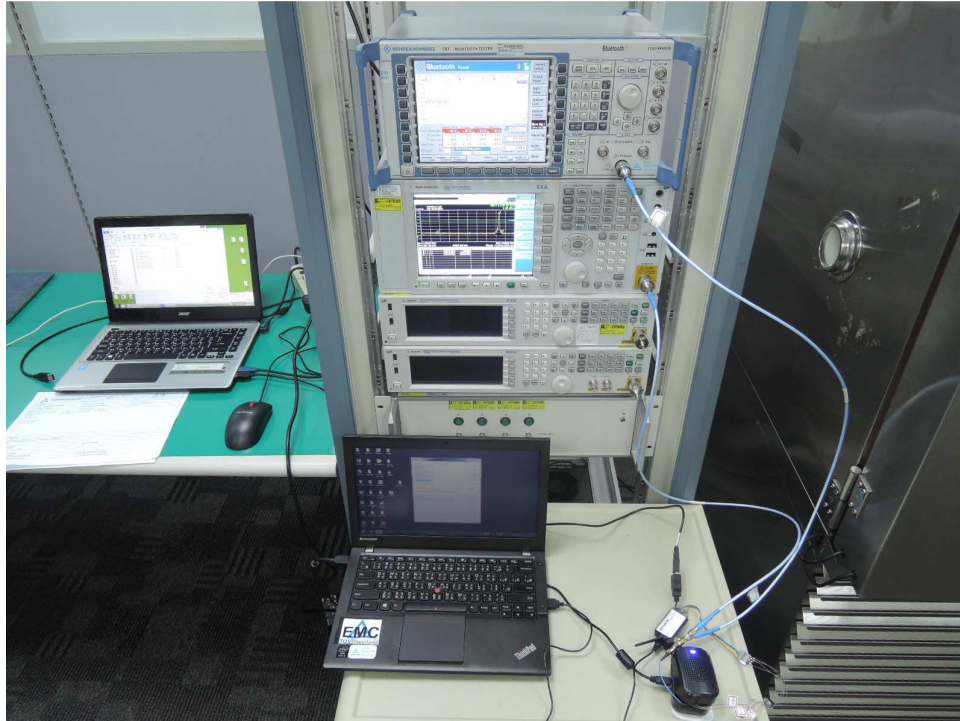

Photograph 5: Set-up for for Mains Conducted testing Back

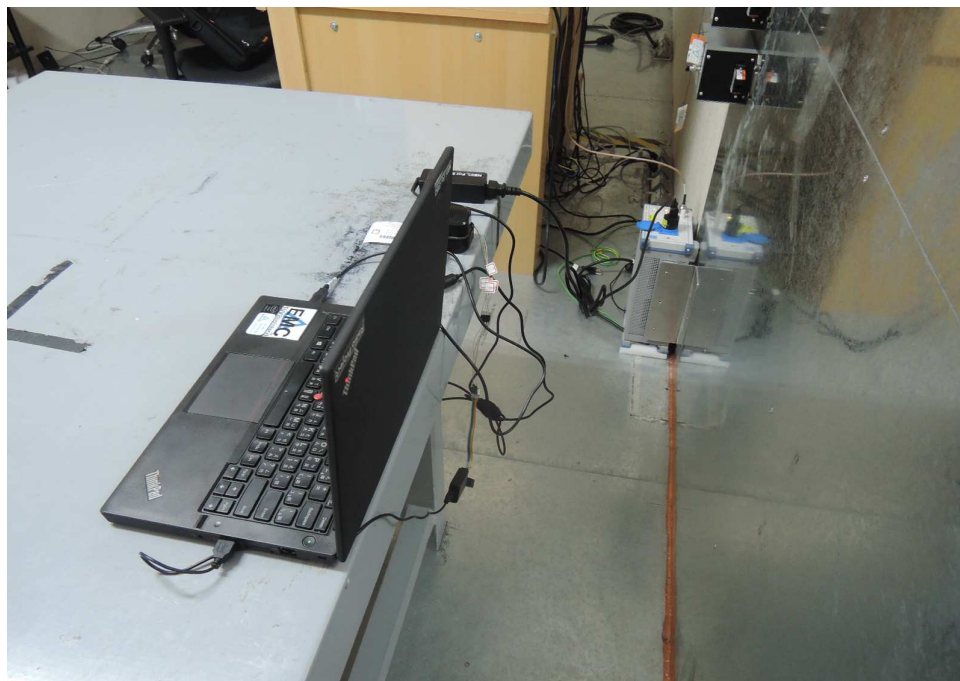

Photograph 6: Set-up for for Mains Conducted testing Front



8. List of Tables

Table 1: Applied Standard and Test Levels	5
Table 2: List of Test and Measurement Equipment	7
Table 3: Emission Measurement Uncertainty.....	8
Table 4: Basic Information of EUT	9
Table 5: Technical Specification of EUT	9
Table 6: Frequency hopping information.....	10
Table 7: Test result of Peak Output Power, GFSK modulation.....	16
Table 8: Test result of Peak Output Power, 8DPSK modulation.....	16
Table 9: Test result of 20dB Bandwidth, GFSK modulation.....	20
Table 10: Test result of 20dB Bandwidth, 8DPSK modulation.....	20
Table 11: Test result of 99% Bandwidth, GFSK modulation	24
Table 12: Test result of 99% Bandwidth, PSK modulation.....	24
Table 13: Test result of Frequency Separation	37
Table 14: Test result of Number of hopping frequency	39
Table 15: Test result of Time of Occupancy.....	41

9. List of Photographs

Photograph 1: Set-up for Spurious Emissions (Front View).....	46
Photograph 2: Set-up for Spurious Emissions (Back View 1)	47
Photograph 3: Set-up for Spurious Emissions (Back View 2)	47
Photograph 4: Set-up for Conducted testing	48
Photograph 5: Set-up for for Mains Conducted testing Back.....	48
Photograph 6: Set-up for for Mains Conducted testing Front.....	49