

FCC Test Report

Product Name : DC Wallbox 25kW
Brand Name : DELTA ELECTRONICS, INC.
Model No. : EVDU25C4AUM, EVDU25C4BUM,
EVDU25C4CUM
FCC ID : H79EVDU25C4CUM

Applicant : Delta Electronics Incorporated
Address : 3 Tungyuan Road Chungli Industrial Zone,
Taoyuan County, 32063, Taiwan

Date of Receipt : Jan. 25, 2022
Issued Date : Apr. 13, 2022
Report No. : 2210778R-RFUSOTHV07-A
Report Version : V1.0



The test results relate only to the samples tested.

The test results shown in the test report are traceable to the national/international standard through the calibration of the equipment and evaluated measurement uncertainty herein.

This report must not be used to claim product endorsement by TAF or any agency of the government. Measurement uncertainties evaluated for each testing system and associated connections are given here to provide the system information for reference. Compliance determinations do not take into account measurement uncertainties for each testing system, but are based on the results of the compliance measurement.

The test report shall not be reproduced except in full without the written approval of DEKRA Testing and Certification Co., Ltd.



Product Name : DC Wallbox 25kW
Applicant : Delta Electronics Incorporated
Address : 3 Tungyuan Road Chungli Industrial Zone, Taoyuan County,
32063, Taiwan
Manufacturer : Delta Electronics Incorporated
Address : 3 Tungyuan Road Chungli Industrial Zone, Taoyuan County,
32063, Taiwan
Brand Name : DELTA ELECTRONICS, INC.
Model No. : EVDU25C4AUM, EVDU25C4BUM, EVDU25C4CUM
FCC ID : H79EVDU25C4CUM
EUT Voltage : EUT 1: AC 200~277V/60Hz
EUT 2: AC 208V/60Hz
EUT 3: AC 480V/60Hz
Testing Voltage : AC 208V/60Hz
Applicable Standard : FCC CFR Title 47 Part 15 Subpart C Section 15.225
ANSI C63.10: 2013
Laboratory Name : Hsin Chu Laboratory
Address : No.372-2, Sec. 4, Zhongxing Rd., Zhudong Township, Hsinchu
County 310, Taiwan, R.O.C.
TEL: +886-3-582-8001 / FAX: +886-3-582-8958
Test Result : Complied

Documented By : 

(Amelia Wu / Project Specialist)

Approved By : 

(Rueyyan Lin / Supervisor)

The test results relate only to the samples tested.

The test report shall not be reproduced except in full without the written approval of DEKRA
Testing and Certification Co., Ltd.

Revision History

Version	Description	Issued Date
V1.0	Initial issue of report	Apr. 13, 2022

TABLE OF CONTENTS

Description	Page
1. General Information	6
1.1. EUT Description	6
1.2. Test Mode.....	7
1.3. Comments and Remarks	7
1.4. Tested System Details	8
1.5. Configuration of tested System.....	8
1.6. EUT Operation of during Test	8
1.7. Test Facility	9
1.8. List of Test Equipment	10
1.9. Measurement Uncertainty.....	11
2. AC Power Line Conducted Emission	12
2.1. Test Setup	12
2.2. Test Limit	12
2.3. Test Procedure	12
2.4. Test Specification	12
2.5. Test Result of AC Power Line Conducted Emission	13
3. Emission Bandwidth.....	15
3.1. Test Setup	15
3.2. Test Limit	15
3.3. Test Procedures	15
3.4. Test Specification	15
3.5. Test Result of Emission Bandwidth.....	16
4. Field Strength of Fundamental Emissions and Spectrum Mask	17
4.1. Test Setup	17
4.2. Test Limit	17
4.3. Test Procedure	18
4.4. Test Specification	18
4.5. Test Result of Field Strength of Fundamental Emissions	19
4.6. Test Result of Spectrum Mask	20
5. Radiated Emission	21
5.1. Test Setup	21
5.2. Test Limit	22
5.3. Test Procedure	22
5.4. Test Specification	22
5.5. Test Result of Radiated Emissions	23
6. Frequency Stability	25

6.1.	Test Setup	25
6.2.	Test Limit	25
6.3.	Test Procedures	25
6.4.	Test Specification	25
6.5.	Test Result of Frequency Stability.....	26
Appendix A	27
	Test Setup Photograph	27

1. General Information

1.1. EUT Description

Product Name	DC Wallbox 25kW
Brand Name	DELTA ELECTRONICS, INC.
Model No.	EVDU25C4AUM, EVDU25C4BUM, EVDU25C4CUM
Frequency	13.56 MHz
Channel Number	1 Channel
Type of Modulation	ASK

The difference for each model is shown as below:

EUT	1	2	3
Model No.	EVDU25C4AUM	EVDU25C4CUM	EVDU25C4BUM
EUT Rated Voltage	AC 200-277V/60Hz, 1 Φ	AC 208V/60Hz, 3 Φ	AC 480V/60Hz, 3 Φ
LTE Cat 1 Module	PLS8-X	PLS8-X	PLS8-X
Input Rating	200-277VAC, 134A max., 60Hz	208VAC, 75A max., 60Hz	480VAC, 32A max., 60Hz
Output Rating	50-500VDC, 65A max.	50-500VDC, 65A max.	50-500VDC, 65A max.

From the above models, EUT 2 (model: EVDU25C4CUM) was selected as representative model for the test and its data was recorded in this report.

Antenna Information				
Ant.	Brand Name	Model No.	Type	Gain (dBi)
0	EWT	EWTJ680F-I-02	PCB	10

Working Frequency of Each Channel	
Channel	Frequency
01	13.56 MHz

Note: The above EUT information is declared by the manufacturer.

1.2. Test Mode

DEKRA has verified the construction and function in typical operation. All the test modes were carried out with the EUT in transmitting operation, which was shown in this test report and defined as follows:

Test Mode	Mode 1: Transmit
-----------	------------------

Test Items	Test Mode	Modulation	Result
AC Power Line Conducted Emission	Mode 1	ASK	Pass
20dB Bandwidth	Mode 1	ASK	Pass
Field Strength of Fundamental Emissions and Spectrum Mask	Mode 1	ASK	Pass
Radiated Emission	Mode 1	ASK	Pass
Frequency Tolerance	Mode 1	ASK	Pass

Note:

- Determining compliance shall be based on the results of the compliance measurement, not taking into account measurement instrumentation uncertainty.
- The EUT was performed at Y axis and Z axis position for radiated emission and field strength of fundamental emissions and spectrum mask tests.
The worst case was found at Y axis, so the measurement will follow this same test configuration.

1.3. Comments and Remarks

The product specification and testing instructions for the EUT declared in the report are provided by the manufacturer who will take all responsibilities for the accuracy.

1.4. Tested System Details

N/A

1.5. Configuration of tested System

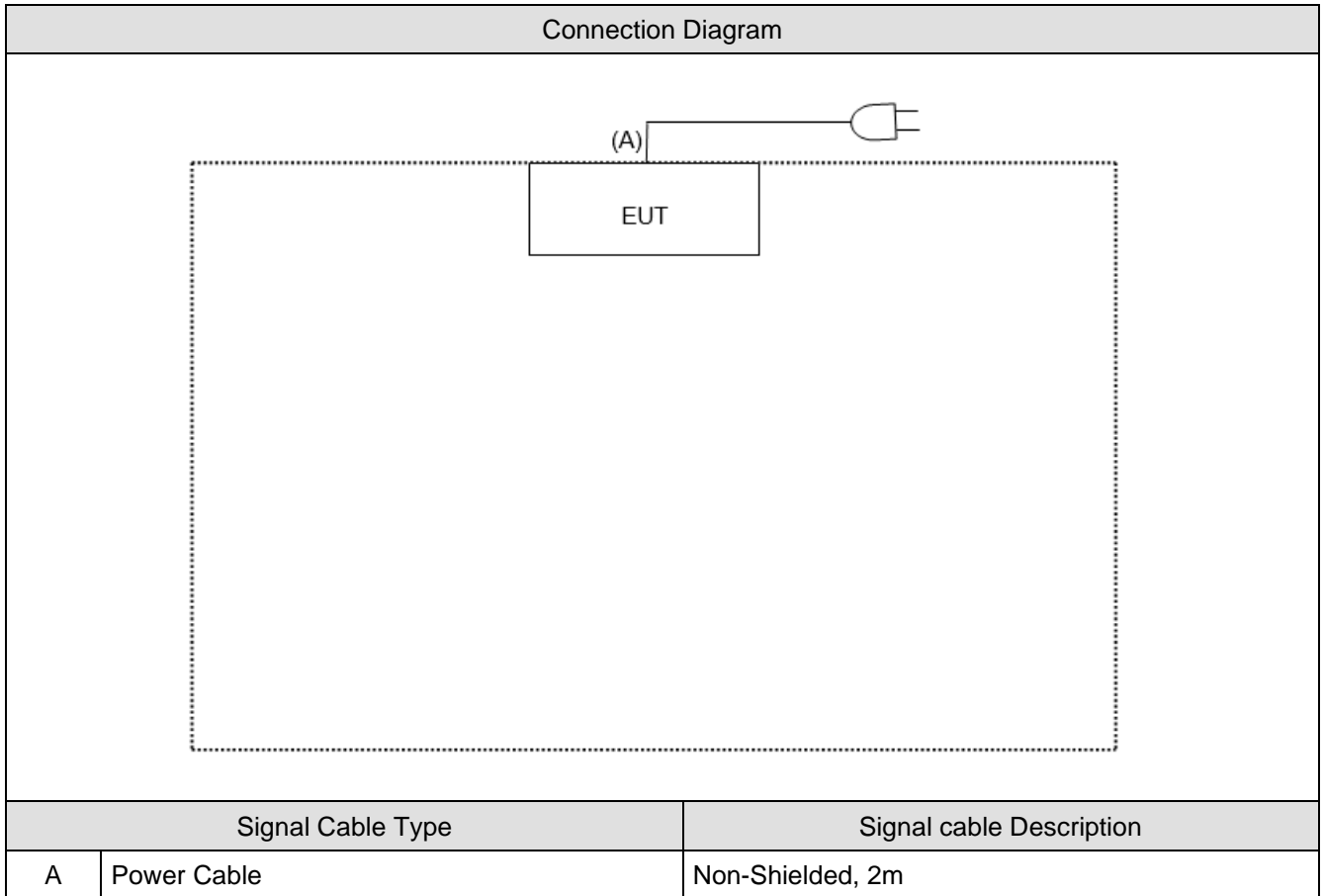

1.6. EUT Operation of during Test

1	Set the EUT as shown.
2	EUT power on.
3	Let the EUT transmit signal continuously.
4	Verify that device is working properly.

1.7. Test Facility

Ambient conditions in the laboratory:

Items	Test Item	Actually	Tested by	Test Date	Test Site
Temperature (°C)	AC Power Line Conducted Emission	20.5	Scott Chang	2022/02/22	HC-SR02
Humidity (%RH)		68			
Temperature (°C)	Emission Bandwidth	19	Scott Chang	2022/02/23	HC-SR12
Humidity (%RH)		61			
Temperature (°C)	Field Strength of Fundamental Emissions and Spectrum Mask	20.2	Lion Wang	2022/02/22	HC-CB02
Humidity (%RH)		57.1			
Temperature (°C)	Radiated Emission	20.2	Lion Wang	2022/02/22	HC-CB02
Humidity (%RH)		57.1			
Temperature (°C)	Frequency Stability	19	Scott Chang	2022/02/23	HC-SR12
Humidity (%RH)		61			

Note: Test site information refers to Laboratory Information.

Laboratory Information

USA : FCC Registration Number: TW3024
Canada : CAB identifier : TW3024

The address and introduction of DEKRA Testing and Certification Co., Ltd. laboratories can be founded in our Web site: <http://www.dekra.com.tw>

If you have any comments, please don't hesitate to contact us. Our test sites as below:

Test Laboratory	DEKRA Testing and Certification Co., Ltd.
Address	1. No.372-2, Sec. 4, Zhongxing Rd., Zhudong Township, Hsinchu County 31061, Taiwan, R.O.C. 2. No.372, Sec. 4, Zhongxing Rd., Zhudong Township, Hsinchu County 31061, Taiwan, R.O.C.
Phone number	1. +886-3-582-8001 2. +886-3-582-8001
Fax number	1. +886-3-582-8958 2. +886-3-582-8958
Email address	info.tw@dekra.com
Website	http://www.dekra.com.tw
Note: Test site number for address 1 includes HC-SR02. Test site number for address 2 includes HC-CB02, HC-CB03, HC-CB04, SR10-H and HC-SR12.	

1.8. List of Test Equipment

HC-SR02

Instrument	Manufacturer	Model No.	Serial No.	Cal. Date	Next Cal. Date
Artificial Mains Network	R&S	ENV4200	848411/010	2021/12/27	2022/12/26
EMI Test Receiver	R&S	ESR3	102608	2021/06/03	2022/06/02
LISN	R&S	ENV216	100092	2021/06/08	2022/06/07
Coaxial Cable(9 m)	Harbour	RG-400	HC-SR02	2021/08/15	2022/08/14
DEKRA Testing System	DEKRA	Version 2.0	HC-SR02	N/A	N/A

HC-SR12

Instrument	Manufacturer	Model No.	Serial No.	Cal. Date	Next Cal. Date
High Speed Peak Power Meter Dual Input	Anritsu	ML2496A	1602004	2021/11/12	2022/11/11
Pulse Power Sensor	Anritsu	MA2411B	1531043	2021/11/12	2022/11/11
EXA Signal Analyzer	Keysight	N9010A	MY51440132	2022/01/07	2023/01/06
Pulse Power Sensor	Anritsu	MA2411B	1531044	2021/11/12	2022/11/11
Power Meter	Keysight	8990B	MY51000248	2021/05/21	2022/05/20
Power Sensor	Keysight	N1923A	MY57240005	2021/05/21	2022/05/20
Spectrum Analyzer	Keysight	N9030B	MY57140404	2021/05/14	2022/05/13
Spectrum Analyzer	Keysight	N9010B	MY57110159	2021/03/29	2022/03/28
Spectrum Analyzer	Agilent	N9010A	US47140172	2021/05/28	2022/05/27
Signal & Spectrum Analyzer	R&S	FSV40	101049	2021/03/31	2022/03/30

HC-CB02

Instrument	Manufacturer	Model No.	Serial No.	Cal. Date	Next Cal. Date
Signal Analyzer	R&S	FSVA40	101455	2021/10/22	2022/10/21
Signal & Spectrum Analyzer	R&S	FSV40	101049	2021/03/31	2022/03/30
Signal Analyzer	R&S	FSVA40	101435	2021/06/04	2022/06/03
EXA Signal Analyzer	Keysight	N9010A	MY51440132	2022/01/07	2023/01/06
Trilog Broadband Antenna	Schwarzbeck	VULB 9168	1272	2021/08/20	2022/08/19
Bilog Antenna	Teseq	CBL6112D	23191	2022/02/10	2023/02/09
EMI Test Receiver	R&S	ESR7	102260	2021/12/22	2022/12/21
Magnetic Loop Antenna	Teseq	HLA 6121	44287	2021/09/06	2022/09/05
Pre-Amplifier	EMCI	EMC01820I	980365	2021/05/28	2022/05/27
Pre-Amplifier	EMEC	EM01G18GA	060741	2021/07/02	2022/07/01
Pre-Amplifier	DEKRA	AP-400C	201801231	2021/12/24	2022/12/23
Coaxial Cable(13m)	Huber+Suhner	SF104	HC-CB02	2021/08/17	2022/08/16
Radiated Software	AUDIX	e3 V9	HC-CB02	N/A	N/A

Note: All equipment upon which need to calibrated are with calibration period of 1 year.

1.9. Measurement Uncertainty

Uncertainties have been calculated according to the DEKRA internal document with the emissions test results be included in the report. The measurement uncertainties given below are based on a 95% confidence level (based on a coverage factor ($k=2$)).

Test item	Uncertainty
AC Power Line Conducted Emission	± 2.10 dB
Emission Bandwidth	± 282.55 Hz
Field Strength of Fundamental Emissions and Spectrum Mask	± 3.27 dB
Radiated Emission	± 3.25 dB
Frequency Stability	± 282.55 Hz

2. AC Power Line Conducted Emission

2.1. Test Setup

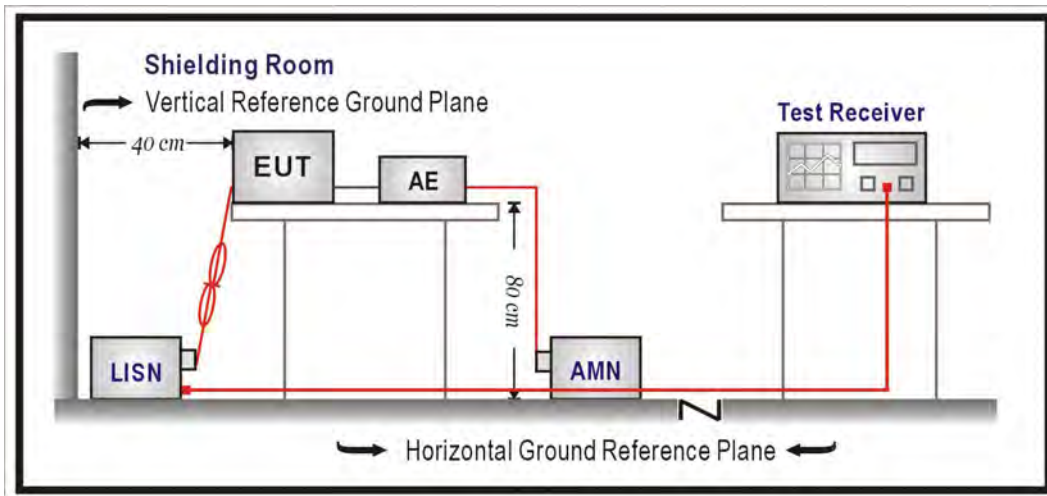

2.2. Test Limit

Frequency (MHz)	QP (dBuV)	AV (dBuV)
0.15 - 0.50	66 - 56	56 - 46
0.50 - 5.0	56	46
5.0 - 30	60	50

Remarks: In the above table, the tighter limit applies at the band edges.

2.3. Test Procedure

The EUT and simulators are connected to the main power through a line impedance stabilization network (L.I.S.N.). This provides a 50 ohm /50uH coupling impedance for the measuring equipment. The peripheral devices are also connected to the main power through a LISN that provides a 50ohm /50uH coupling impedance with 50 ohm termination. (Please refer to the block diagram of the test setup and photographs.)

Both sides of A.C. line are checked for maximum conducted interference. In order to find the maximum emission, the relative positions of equipment and all of the interface cables must be changed according to ANSI C63.10: 2013 on conducted measurement.

Conducted emissions were investigated over the frequency range from 0.15 MHz to 30 MHz using a receiver bandwidth of 9 kHz.

2.4. Test Specification

According to FCC Part 15 Subpart C Paragraph 15.207

2.5. Test Result of AC Power Line Conducted Emission

Test Mode	Mode 1: Transmit	Phase	Line
Test Condition	13.56 MHz		

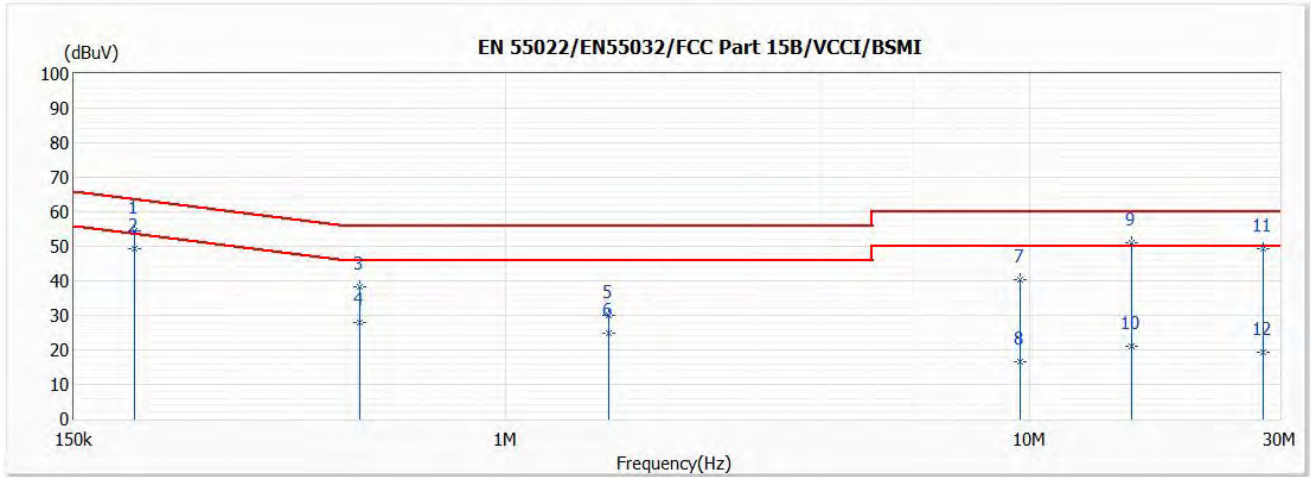

No	Frequency (MHz)	Emission Level (dBuV)	Limit (dBuV)	Margin (dB)	Reading Level (dBuV)	Correct Factor (dB)	Detector Type
1	0.195	54.54	63.80	-9.26	44.90	9.64	QP
*2	0.195	49.31	53.80	-4.49	39.67	9.64	AV
3	0.527	38.25	56.00	-17.75	28.58	9.67	QP
4	0.527	27.90	46.00	-18.10	18.23	9.67	AV
5	1.574	30.13	56.00	-25.87	20.37	9.76	QP
6	1.574	24.77	46.00	-21.23	15.01	9.76	AV
7	9.566	40.19	60.00	-19.81	30.10	10.09	QP
8	9.566	16.55	50.00	-33.45	6.46	10.09	AV
9	15.625	51.03	60.00	-8.97	40.77	10.26	QP
10	15.625	21.05	50.00	-28.95	10.79	10.26	AV
11	27.870	49.33	60.00	-10.67	38.86	10.47	QP
12	27.870	19.34	50.00	-30.66	8.87	10.47	AV

Remark:

1. "*" means this data is the worst emission level.
2. Emission Level = Reading Level + Correct Factor (Correct Factor = LISN Insertion Loss + Cable Loss).
3. Margin = Emission Level - Limit.

Test Mode	Mode 1: Transmit	Phase	Neutral
Test Condition	13.56 MHz		

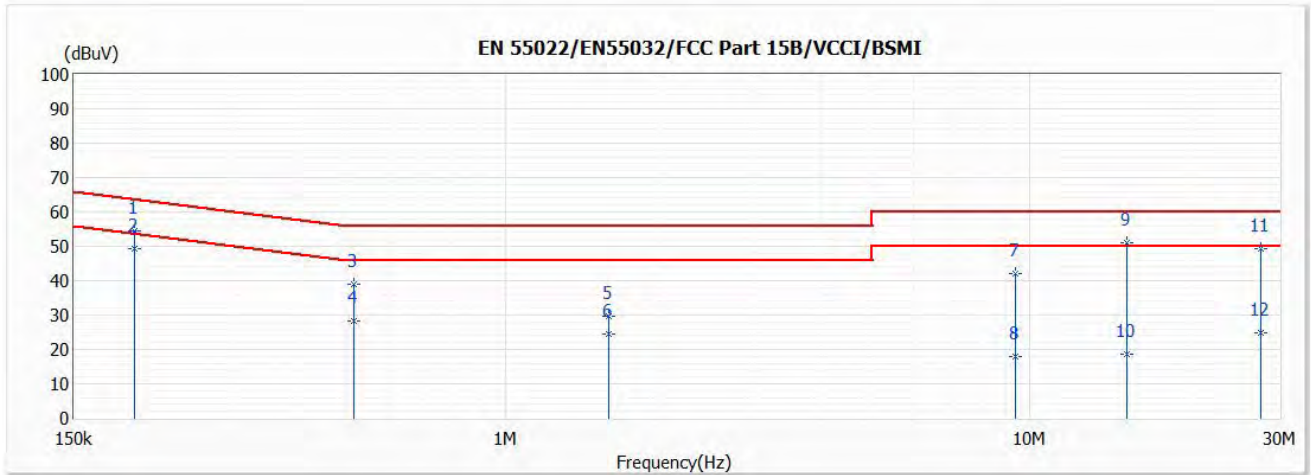

No	Frequency (MHz)	Emission Level (dBuV)	Limit (dBuV)	Margin (dB)	Reading Level (dBuV)	Correct Factor (dB)	Detector Type
1	0.196	54.56	63.79	-9.23	44.93	9.63	QP
*2	0.196	49.26	53.79	-4.53	39.63	9.63	AV
3	0.514	38.99	56.00	-17.01	29.32	9.67	QP
4	0.514	28.34	46.00	-17.66	18.67	9.67	AV
5	1.574	29.69	56.00	-26.31	19.93	9.76	QP
6	1.574	24.40	46.00	-21.60	14.64	9.76	AV
7	9.376	42.18	60.00	-17.82	32.06	10.12	QP
8	9.376	17.98	50.00	-32.02	7.86	10.12	AV
9	15.355	51.05	60.00	-8.95	40.68	10.37	QP
10	15.355	18.46	50.00	-31.54	8.09	10.37	AV
11	27.530	49.22	60.00	-10.78	38.48	10.74	QP
12	27.530	24.84	50.00	-25.16	14.10	10.74	AV

Remark:

1. "*" means this data is the worst emission level.
2. Emission Level = Reading Level + Correct Factor (Correct Factor = LISN Insertion Loss + Cable Loss).
3. Margin = Emission Level - Limit.

3. Emission Bandwidth

3.1. Test Setup

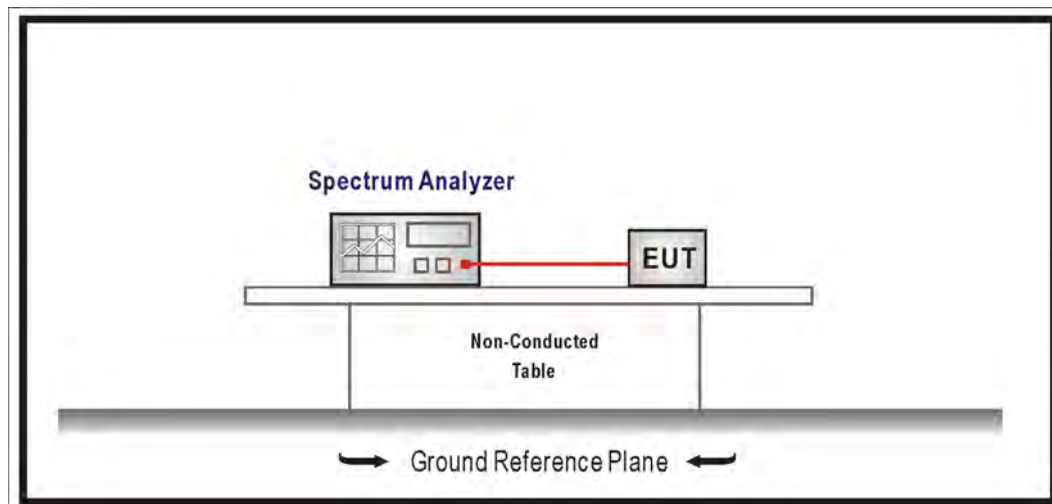

3.2. Test Limit

Intentional radiators must be designed to ensure that the emission bandwidth of the emissions in the specific band. (13.553 ~ 13.567 MHz)

3.3. Test Procedures

1. The transmitter output (antenna port) was connected to the spectrum analyzer in peak hold mode.
2. The resolution bandwidth of 1 kHz and the video bandwidth of 3 kHz were used.

3.4. Test Specification

According to FCC Part 15 Subpart C Paragraph 15.225.

3.5. Test Result of Emission Bandwidth

Frequency (MHz)	Measure Level (kHz)	Limit (MHz)
13.56	25.756	-

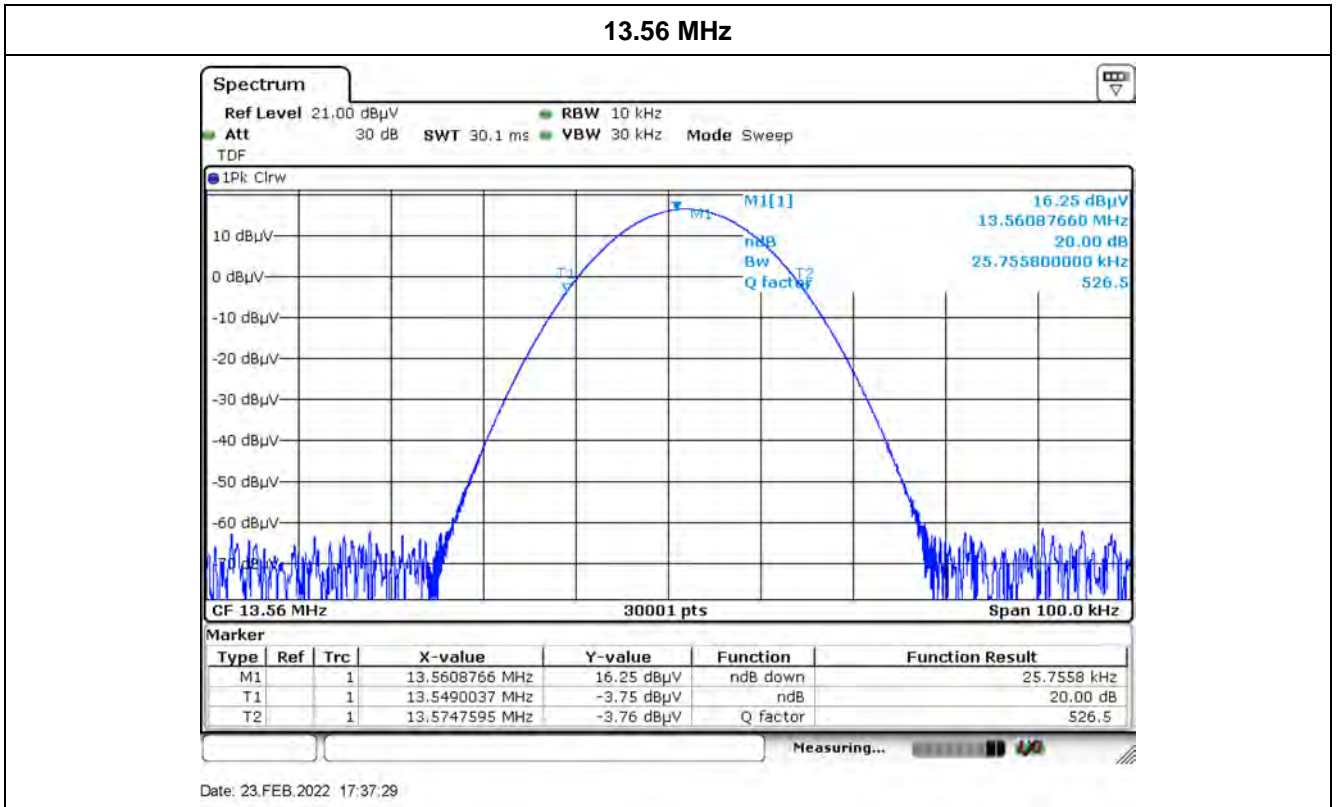

4. Field Strength of Fundamental Emissions and Spectrum Mask

4.1. Test Setup

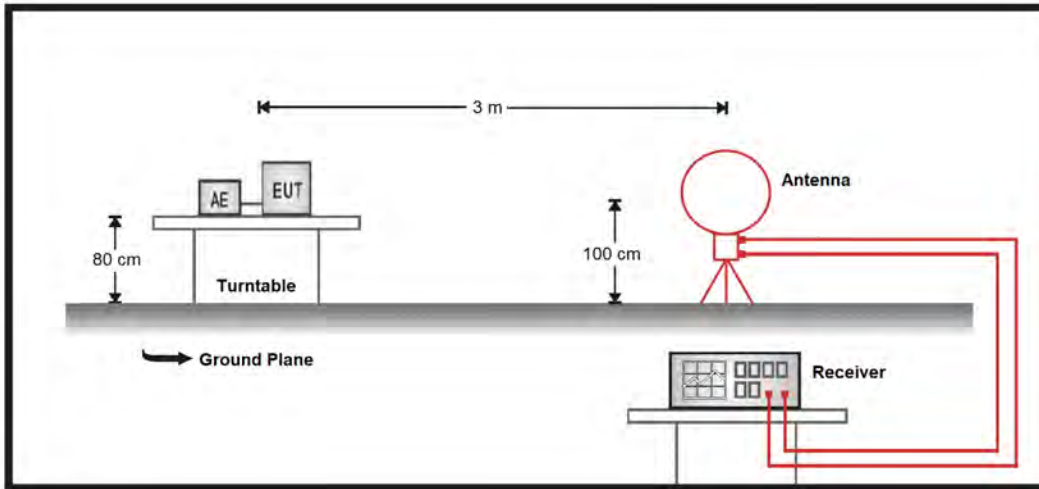

4.2. Test Limit

Field Strength of Fundamental Emissions			
Frequencies (MHz)	Field Strength (microvolts/meter) at 30m	Field Strength (dBµV/m) at 10m	Field Strength (dBµV/m) at 3m
13.553 – 13.567 MHz	15848	103.08 (QP)	124 (QP)
Quasi peak measurement of the fundamental.			

Spectrum Mask					
Rules and specifications	CFR 47 Part 15 section 15.225(a)-(d)				
Description	Compliance with the spectrum mask is tested using a spectrum analyzer with RBW set to a 9kHz for the band 13.553 – 13.567 MHz.				
Limit	Freq. of Emission (MHz)	Field Strength			
		(uV/m)@30m	(dBuV/m)@30m	(dBuV/m)@10m	(dBuV/m)@3m
	1.705~13.110	30	29.5	48.6	69.5
	13.110~13.410	106	40.5	59.6	80.5
	13.410~13.553	334	50.5	69.6	90.5
	13.553~13.567	15848	84.0	103.1	124.0
	13.567~13.710	334	50.5	69.6	90.5
	13.710~14.010	106	40.5	59.6	80.5
14.010~30.000	30	29.5	48.6	69.5	

4.3. Test Procedure

1. Configure the EUT according to ANSI C63.10: 2013. The EUT was placed on the top of the turntable 0.8 meter above ground. The phase center of the loop receiving antenna mounted antenna tower was placed 3 meters far away from the turntable.
2. Power on the EUT and all the supporting units. The turntable was rotated by 360 degrees to determine the position of the highest radiation.
3. The height of the receiving antenna was fixed at one meter above ground to find the maximum emissions field strength.
4. For Fundamental emissions, use the receiver to measure QP reading.
5. When the radiated emissions limits are expressed in terms of the average value of the emissions, and pulsed operation is employed, the measurement field strength shall be determined by averaging over one complete pulse train, including blanking intervals, as long as the pulse train does not exceed 0.1 seconds. As an alternative (provided the transmitter operates for longer than 0.1 seconds) or in cases where the pulse train exceeds 0.1 seconds, the measured field strength shall be determined from the average absolute voltage during a 0.1 second interval during which the field strength is at its maximum value.
6. Compliance with the spectrum mask is tested using a spectrum analyzer with RBW set to a 9kHz for the band 13.553 – 13.567 MHz.

4.4. Test Specification

According to FCC Part 15 Subpart C Paragraph 15.225.

4.5. Test Result of Field Strength of Fundamental Emissions

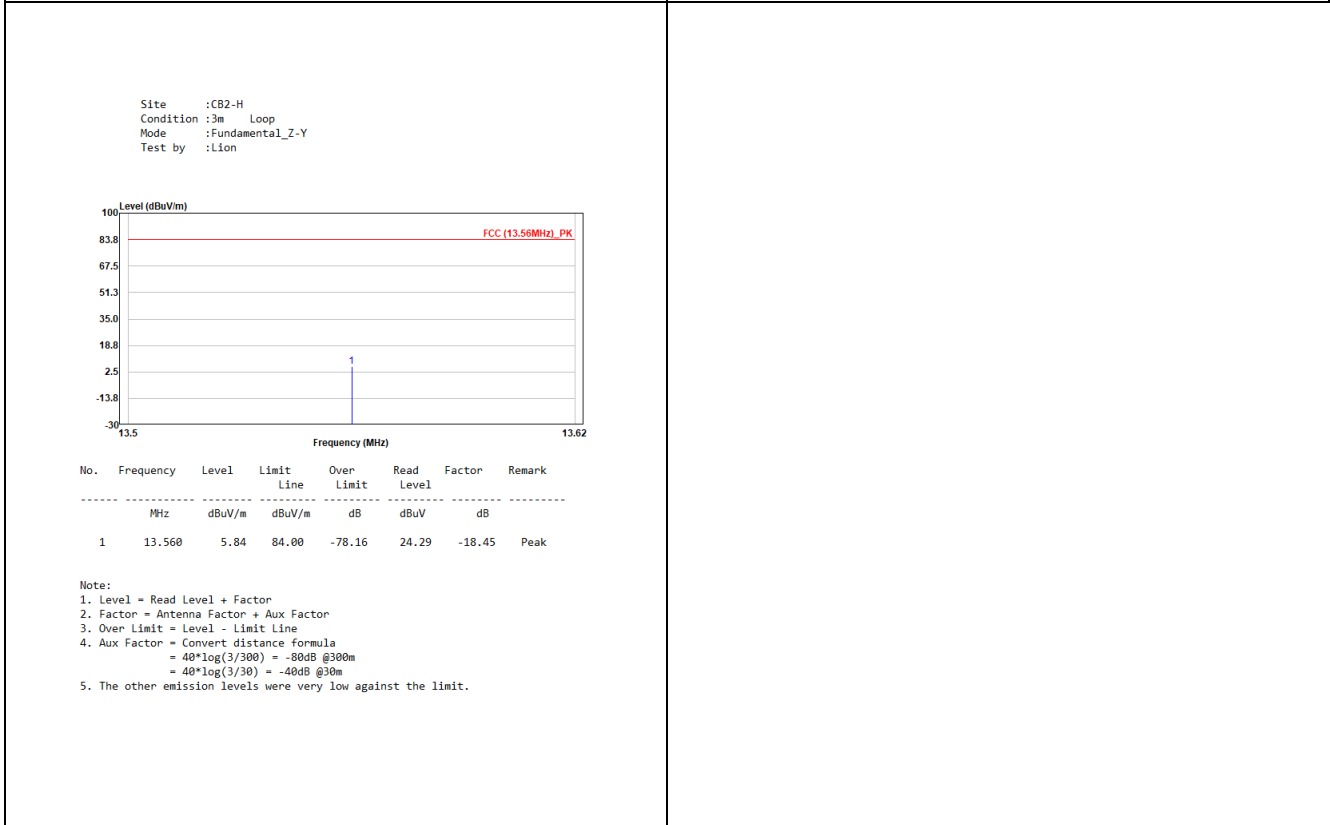
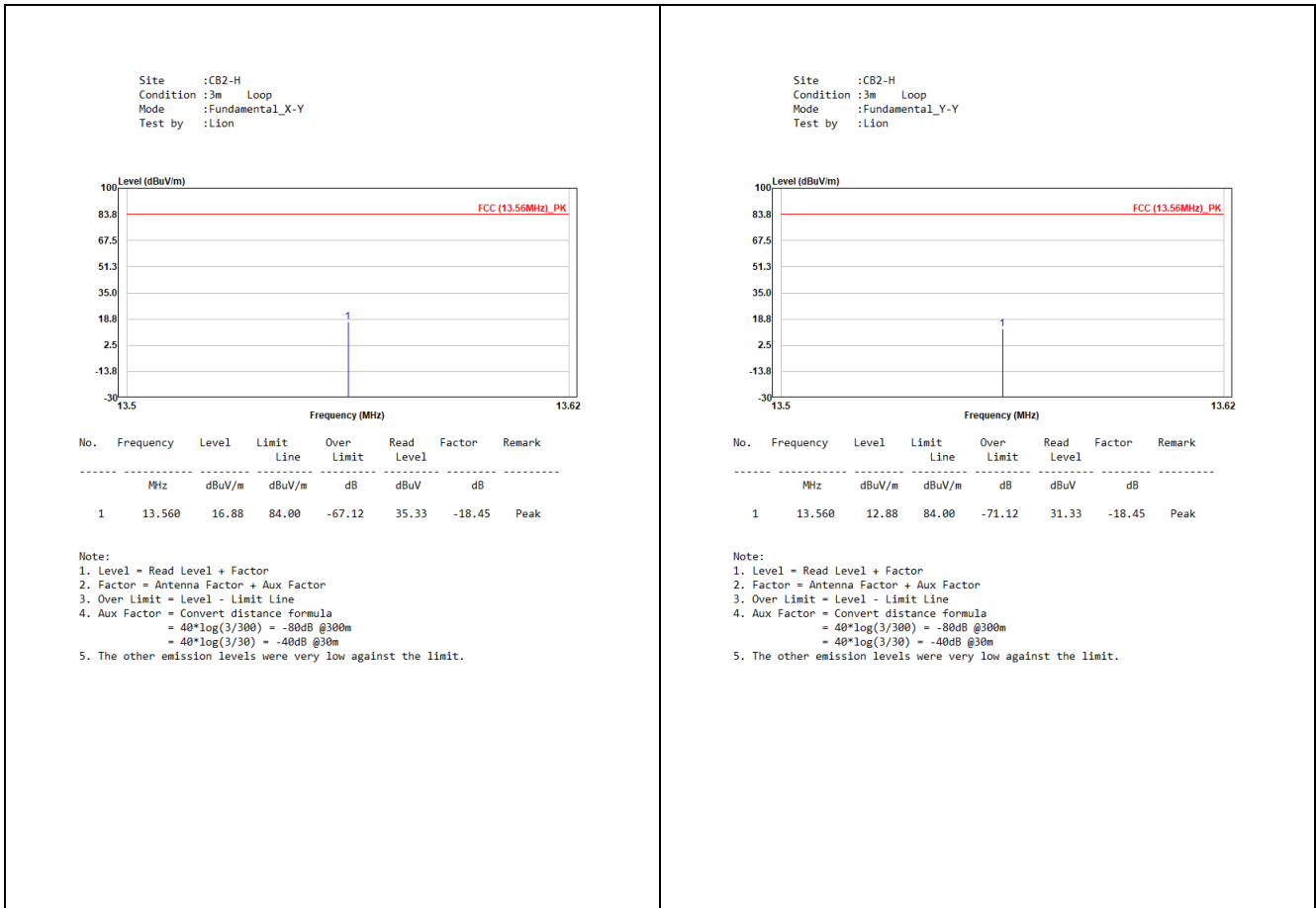

4.6. Test Result of Spectrum Mask

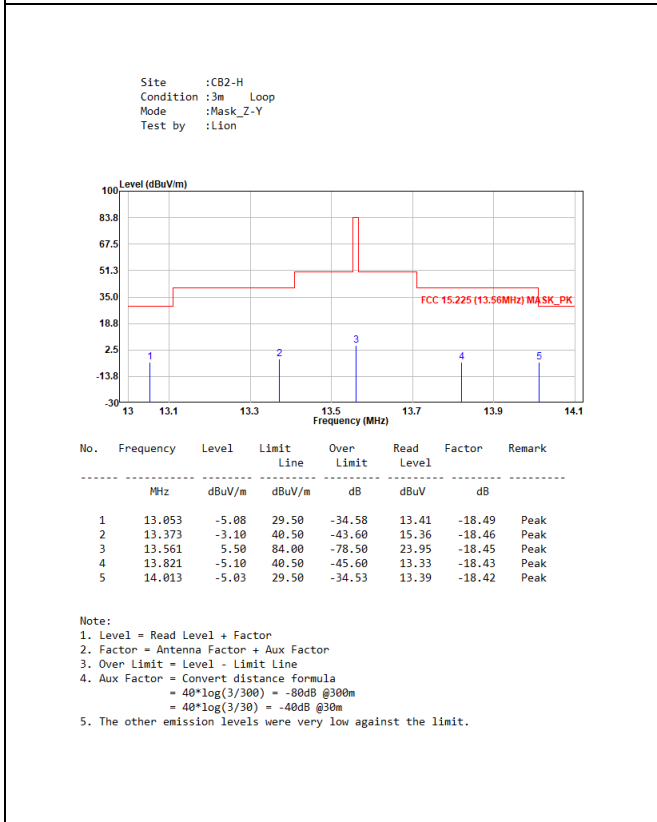
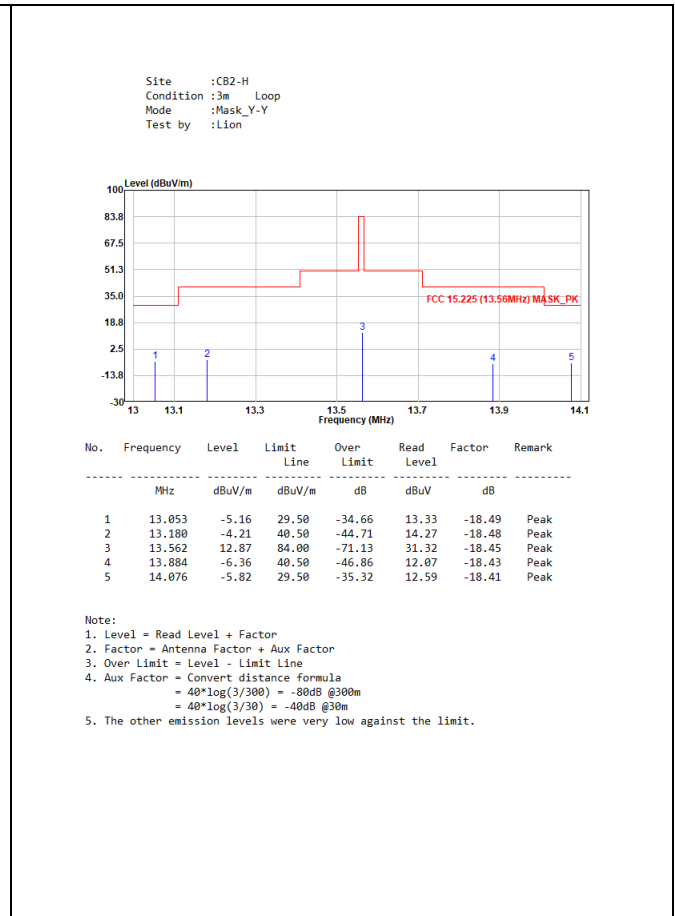
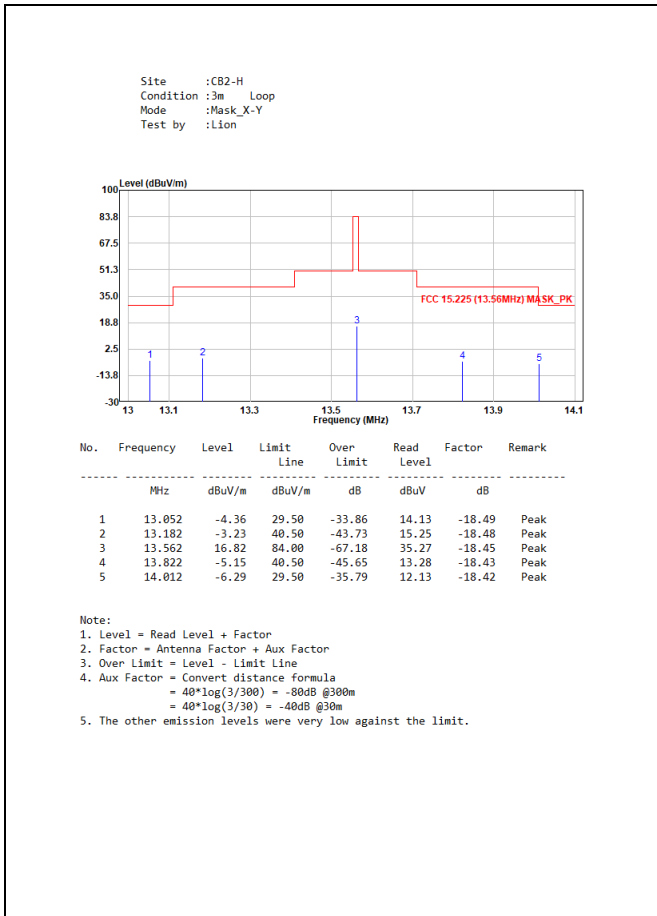

5. Radiated Emission

5.1. Test Setup

9 kHz ~ 30 MHz

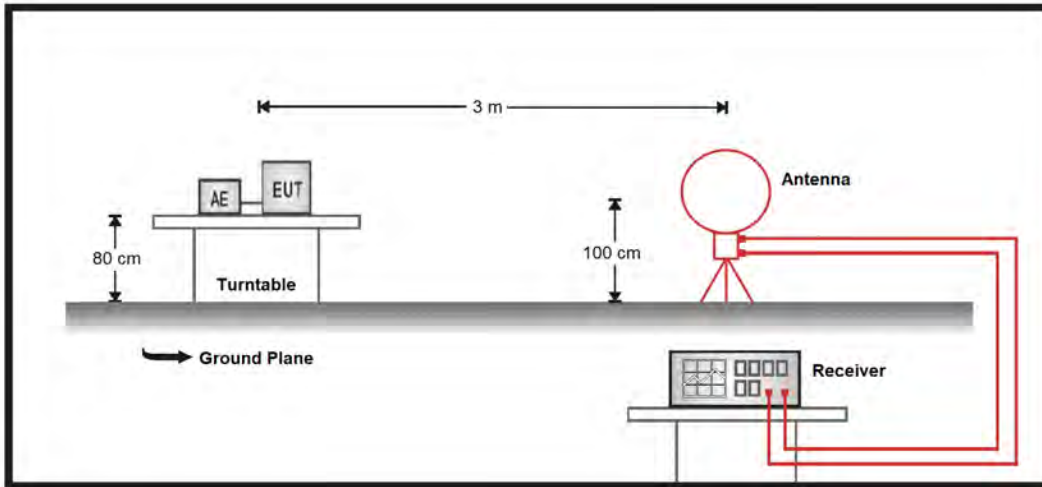

30 MHz ~ 1 GHz

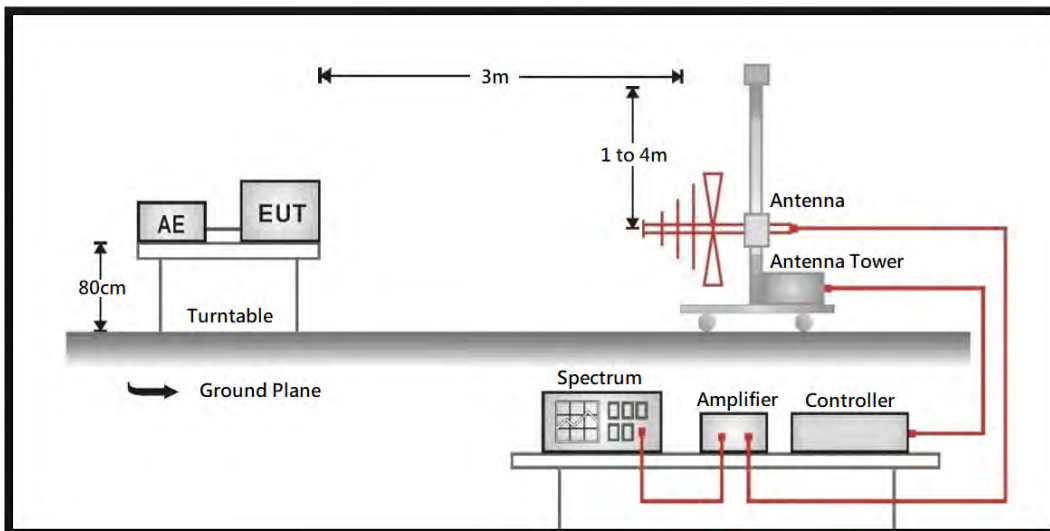

5.2. Test Limit

The field strength of any emissions which appear outside of 13.553 ~ 13.567MHz band shall not exceed the general radiated emissions limits.

Frequency (MHz)	Field strength (uV/m)	Field strength (dBuV/m)	Measurement distance (m)
0.009 – 0.490	2400/F(kHz)	20 log (2400/F(kHz))	300
0.490 – 1.705	24000/F(kHz)	20 log (24000/F(kHz))	30
1.705 - 30	30	29.5	30
30 - 88	100	40	3
88 - 216	150	43.5	3
216 - 960	200	46	3
Above 960	500	54	3

Remarks:

1. Field strength (dBuV/m) = 20 log Field strength (uV/m)
2. In the Above Table, the tighter limit applies at the band edges.
3. Distance refers to the distance in meters between the measuring instrument antenna and the closed point of any part of the device or system

5.3. Test Procedure

1. Configure the EUT according to ANSI C63.10: 2013. The EUT was placed on the top of the turntable 0.8 meter above ground. The phase center of the receiving antenna mounted on the top of a height-variable antenna tower was placed 3 meters far away from the turntable.
2. Power on the EUT and all the supporting units. The turntable was rotated by 360 degrees to determine the position of the highest radiation.
3. The height of the broadband receiving antenna was varied between one meter and four meters above ground to find the maximum emissions field strength of both horizontal and vertical polarization.
4. For each suspected emissions, the antenna tower was scan (from 1 M to 4 M) and then the turntable was rotated (from 0 degree to 360 degrees) to find the maximum reading.
5. Set the test-receiver system to Peak or CISPR quasi-peak Detect Function with specified bandwidth under Maximum Hold Mode.
6. When the radiated emissions limits are expressed in terms of the average value of the emissions, and pulsed operation is employed, the measurement field strength shall be determined by averaging over one complete pulse train, including blanking intervals, as long as the pulse train does not exceed 0.1 seconds. As an alternative (provided the transmitter operates for longer than 0.1 seconds) or in cases where the pulse train exceeds 0.1 seconds, the measured field strength shall be determined from the average absolute voltage during a 0.1 second interval during which the field strength is at its maximum value.
7. In case the emission is lower than 30MHz, loop antenna has to be used for measurement and the recorded data should be QP measured by receiver. High – Low scan is not required in this case.

5.4. Test Specification

According to FCC Part 15 Subpart C Paragraph 15.225.

5.5. Test Result of Radiated Emissions

9 kHz ~ 30 MHz

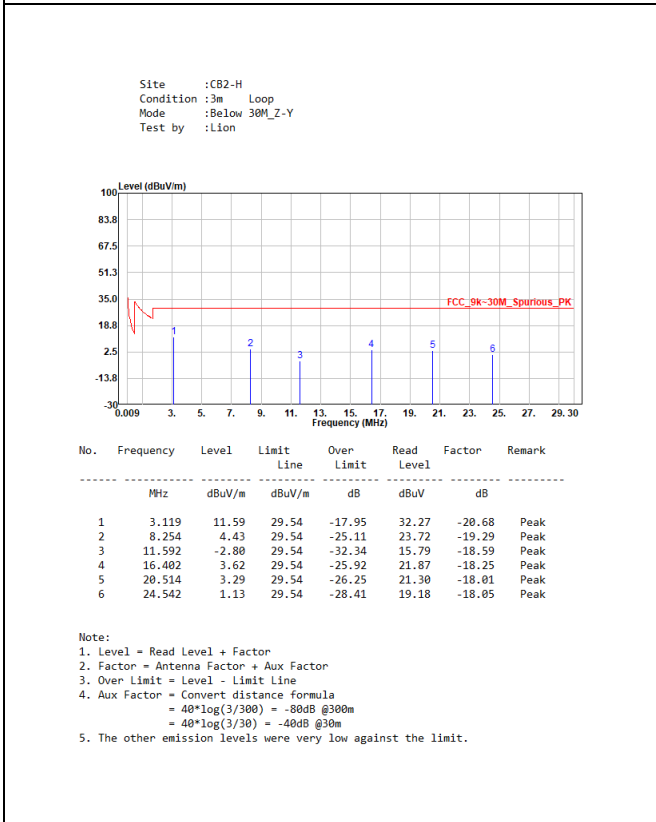
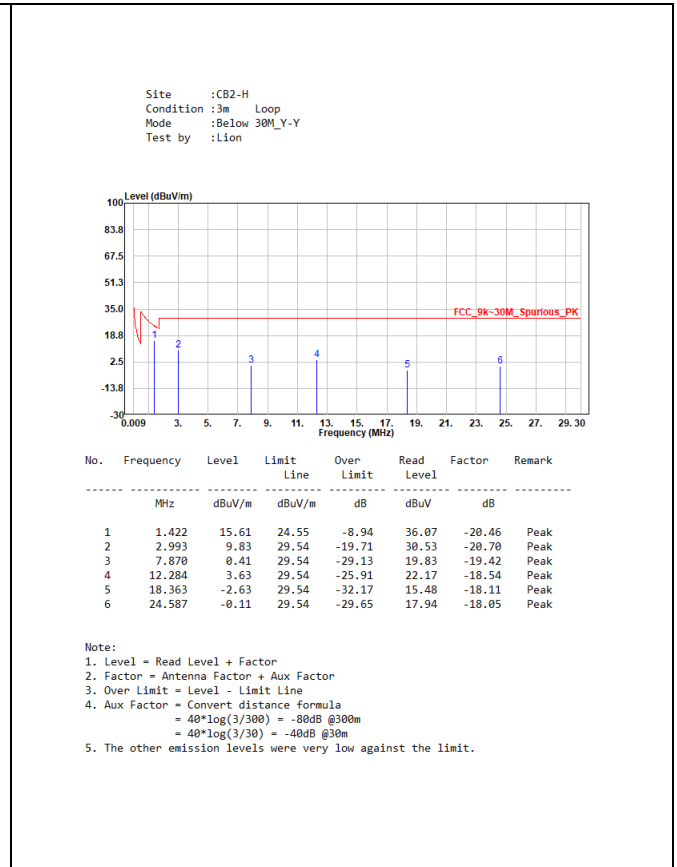
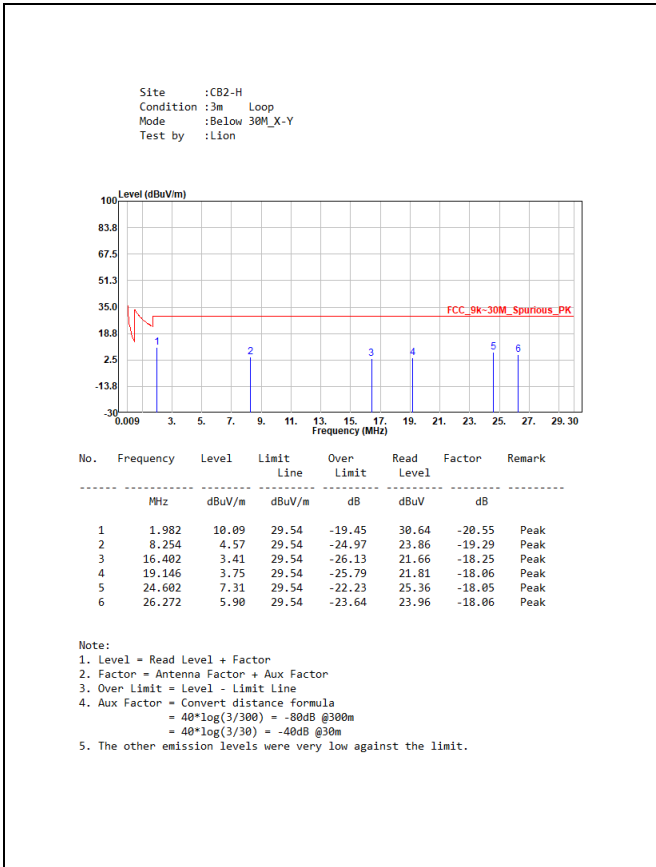

30 MHz ~ 1 GHz

Site :CB2-H
 Condition :3m Horizontal
 Mode :30M-1G_Y
 Test by :Lion

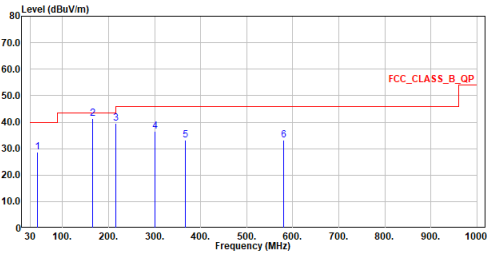

No.	Frequency MHz	Level dBuV/m	Limit dBuV/m	Over Limit dB	Read Level dBuV	Factor dB	Remark
1	46.102	28.74	40.00	-11.26	30.55	-1.81	QP
2	165.994	41.48	43.50	-2.02	44.09	-2.61	QP
3	216.046	39.42	46.00	-6.58	45.35	-5.93	QP
4	299.951	36.45	46.00	-9.55	38.27	-1.82	QP
5	365.814	33.12	46.00	-12.88	33.22	-0.10	QP
6	580.960	33.21	46.00	-12.79	28.16	5.05	QP

Note:
 1. Level = Read Level + Factor
 2. Factor = Antenna Factor + Cable Loss - Preamp Factor
 3. Over Limit = Level - Limit Line
 4. The emission under 30MHz was not included since the emission levels are very low against the limit.
 5. The other emission levels were very low against the limit.

Site :CB2-H
 Condition :3m Vertical
 Mode :30M-1G_Y
 Test by :Lion

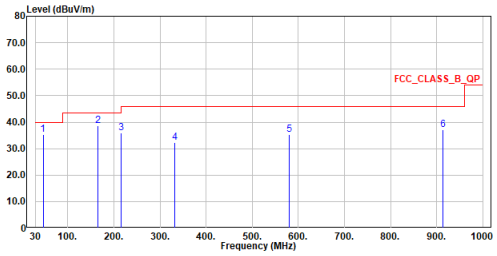

No.	Frequency MHz	Level dBuV/m	Limit dBuV/m	Over Limit dB	Read Level dBuV	Factor dB	Remark
1	46.199	35.41	40.00	-4.59	37.23	-1.82	QP
2	165.994	38.72	43.50	-4.78	41.33	-2.61	QP
3	216.046	35.81	46.00	-10.19	41.74	-5.93	QP
4	331.961	32.33	46.00	-13.67	33.17	-0.84	QP
5	580.960	35.18	46.00	-10.82	30.13	5.05	QP
6	913.088	37.00	46.00	-9.00	26.51	10.49	QP

Note:
 1. Level = Read Level + Factor
 2. Factor = Antenna Factor + Cable Loss - Preamp Factor
 3. Over Limit = Level - Limit Line
 4. The emission under 30MHz was not included since the emission levels are very low against the limit.
 5. The other emission levels were very low against the limit.

6. Frequency Stability

6.1. Test Setup

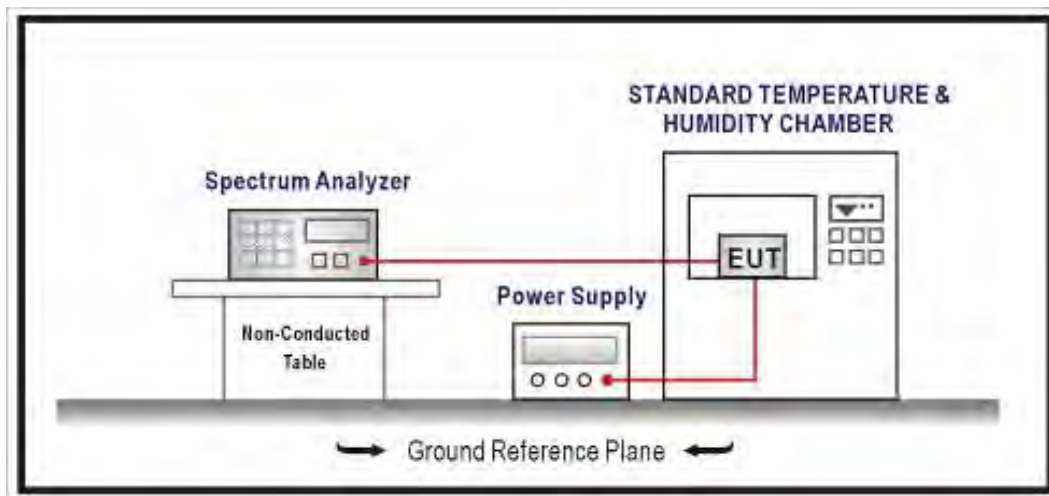

6.2. Test Limit

Carrier frequency stability shall be maintained to $\pm 0.01\%$ (± 100 ppm).

6.3. Test Procedures

The frequency tolerance of the carrier signal shall be maintained within $\pm 0.01\%$ of the operating frequency over a temperature variation of -20 degrees to 50 degrees C at normal supply voltage, and for a variation in the primary supply voltage from 85% to 115% of the rated supply voltage at a temperature of 20 degrees C.

For battery operated equipment, the equipment tests shall be performed using a new battery.

6.4. Test Specification

According to FCC Part 15 Subpart C Paragraph 15.225.

6.5. Test Result of Frequency Stability

Test Conditions		Center Frequency (MHz)	Frequency Tolerance (%)	Limit (%)
20°C	208V	13.560880	0.00649	<0.01
20°C	176.8V	13.560880	0.00649	<0.01
20°C	239.2V	13.560882	0.00650	<0.01

Test Conditions		Frequency (MHz)	Frequency Tolerance (%)	Limit (%)
-30°C	208V	13.560878	0.00648	<0.01
-20°C	208V	13.560648	0.00478	<0.01
-10°C	208V	13.560883	0.00651	<0.01
0°C	208V	13.560877	0.00646	<0.01
10°C	208V	13.560882	0.00650	<0.01
20°C	208V	13.560882	0.00650	<0.01
30°C	208V	13.560877	0.00646	<0.01
40°C	208V	13.560880	0.00649	<0.01
50°C	208V	13.560878	0.00648	<0.01