



产品规格书

Antenna_Specification

客户:
Manufacturer: 深圳市金亚太科技有限公司

客户编码:
ApplicantNumber: 01

产品描述:
Product: WIFI外置胶套天线

制造商编码:
Model Number: BGS-001F (RA版)

产品制造商:
Manufacturer: 深圳市博格斯通信技术有限公司

承认日期:
Dated: 2022年5月27日

供应商签章	客户签章
	

注：博格斯已经盖章的电子档或是纸质档提供给需求方后，若需求方在下达正式订单给博格斯前没有将承认书回签给博格斯，也没有正式的变更或是更改通知，则博格斯默认为需求方认可并接受规格书所述产品。

2、本产品相关知识产权归深圳市博格斯通信技术有限公司所有，未经我司许可，请不要以其他名义就本产品进行专利权的申请，请不要将本产品及相关资料泄露给他人或提供第三方阅览使用。



测试条件与方法:

Test conditions and methods

测试条件和仪器 Test conditions and instruments	测试方法 Methods	测试结果 Test result
Aglient E5071B网络分析仪	将样品与网络分析仪连接，测试天线驻波	见测试数据

测试数据:

Test data

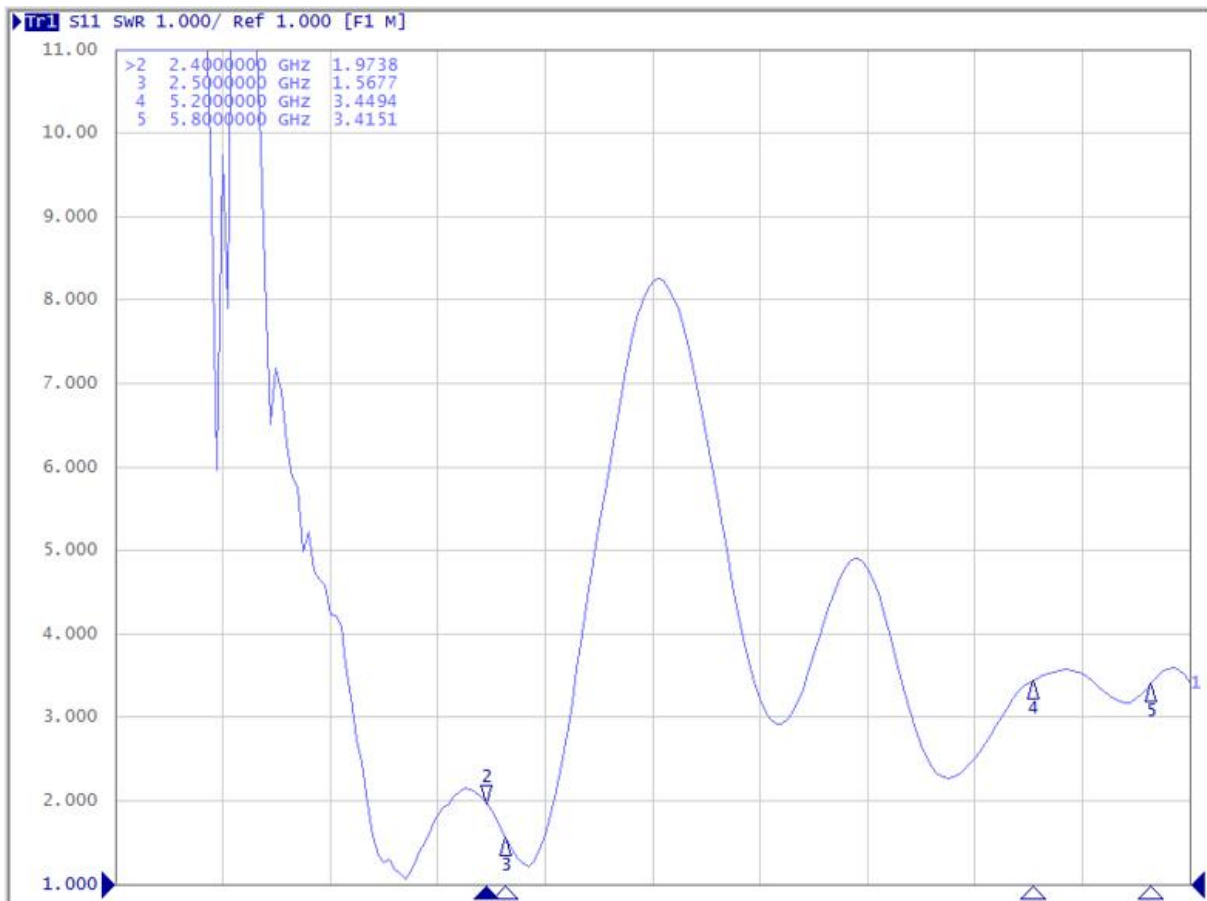

无源效率2400M-2500M		
Freq (MHz)	Effi (%)	Gain (dBi)
2400	80.76	3.45
2410	85.84	3.78
2420	81.13	3.81
2430	83.86	4.21
2440	83.46	3.96
2450	84.27	4.14
2460	78.44	3.92
2470	82.48	4.12
2480	78.56	3.91
2490	83.22	4.16
2500	80.21	4.1

无源效率5100M-5800M		
Freq (MHz)	Effi (%)	Gain (dBi)
5100	54.76	2.41
5120	52.33	1.1
5140	65.42	0.8
5160	59.1	0.19
5180	51.44	-1.54
5200	49.42	-2.4
5220	50.42	-1.63
5240	49.94	-1.67
5260	53.86	-1.2
5280	57.75	-0.87
5300	61.44	0.39
5320	53.69	1.72
5340	58.51	2.06
5360	51.75	2.12
5380	57.09	3.04
5400	55.97	3.22
5420	59.73	3.04
5440	60.95	2.73
5460	57.53	2.74
5480	62.97	3.19
5500	60.6	2.74
5520	66.33	2.84
5540	74.79	3.33
5560	76.06	3.66
5580	77.82	3.91
5600	78	3.63
5620	76.84	3.41
5640	77.55	3.95
5660	76.66	4.09
5680	78.14	3.73
5700	77.03	3.11
5720	75.66	3.41
5740	75.18	3.4
5760	75.25	3.09
5780	69.53	2.32
5800	65.92	2.11

方向图

2400/2450/2500MHz

2400.000MHz

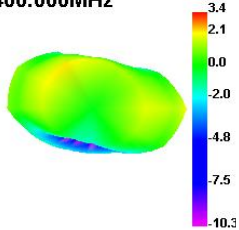

2400.000MHz H

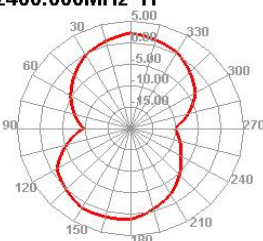

2450.000MHz

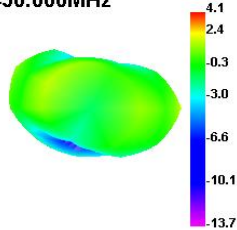

2450.000MHz H

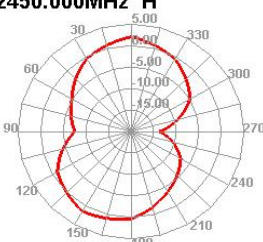

2400.000MHz E1

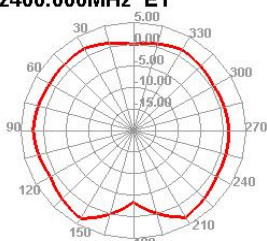

2400.000MHz E2

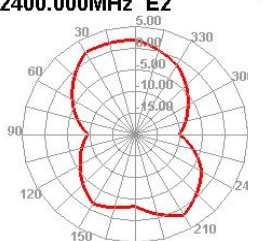

2450.000MHz E1

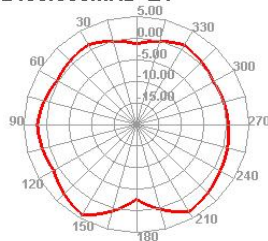

2450.000MHz E2

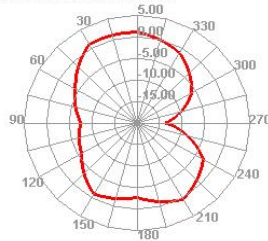

2500.000MHz

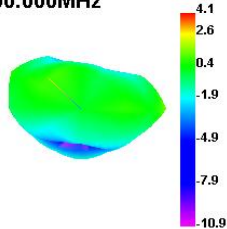

2500.000MHz H

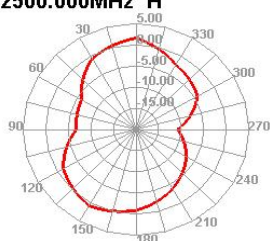

2500.000MHz E1

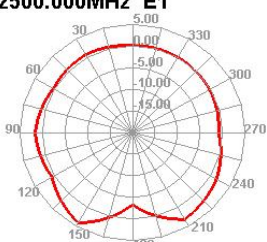

2500.000MHz E2

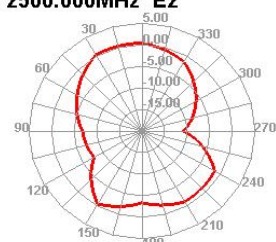

5140/5500/5800MHz

5140.000MHz

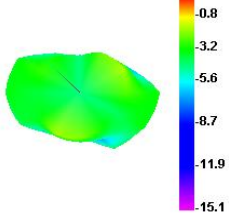

5140.000MHz H

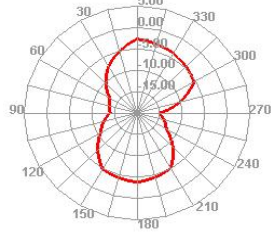

5500.000MHz

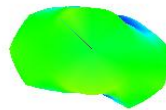

5500.000MHz H

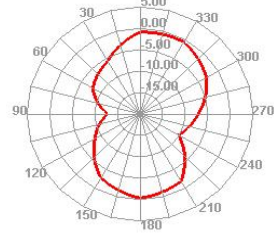

5140.000MHz E1

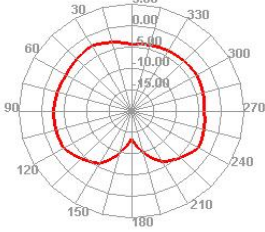

5140.000MHz E2

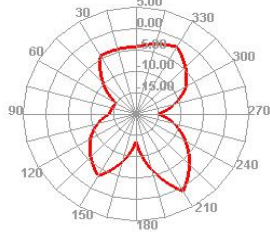

5500.000MHz E1

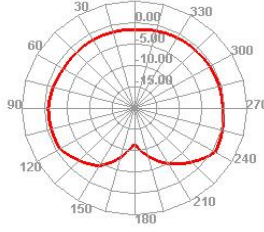

5500.000MHz E2

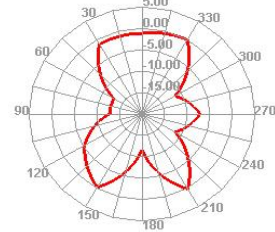

5800.000MHz

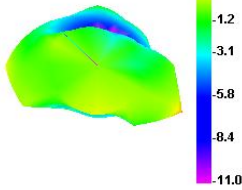

5800.000MHz H

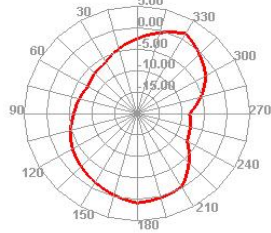

5800.000MHz E1

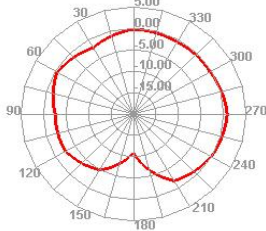

5800.000MHz E2

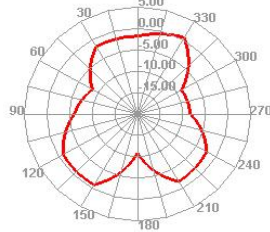



深圳市博格斯通信技术有限公司
shenzhen bogesi communication technology co., ltd

样品图片:



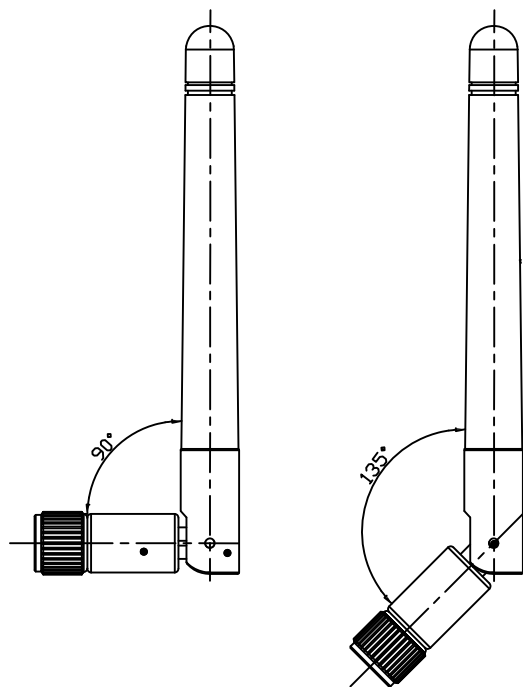

备注:
 1. 标注"*"为重点尺寸;
 2. 未标注公差范围请参照标准公差;
 3. SWR<=2.0。

4. 50PCS/包

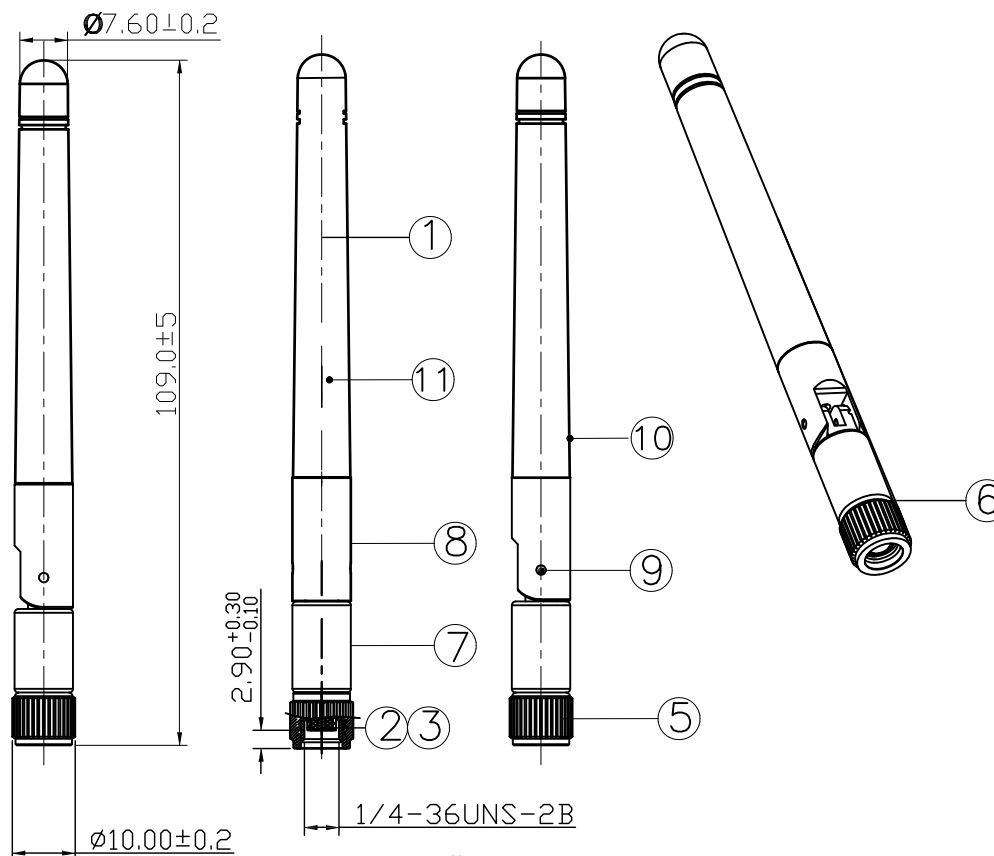

公头带孔!!!

NO	PARTNAME	DESCRIPTION	PART NO.	Q.TY
11	天线铜管	黄铜, 镀锡, $\varnothing 4.4 \times 27.5\text{MM}$	ZL-AN4427516	1
10	杆套	TPEE, 黑色, $\varnothing 9.4 \times 67\text{MM}$	ZL-AN5701-03B	1
9	转轴	POM, 黑色, $\varnothing 1.7 \times 3.8\text{MM}$	ZL-AN01-1215PB-1	2
8	上固定座	ABS, 黑色, $\varnothing 9.4 \times 30.5\text{MM}$	ZL-AN5704-01B	1
7	下固定座	ABS, 黑色, $\varnothing 9.35 \times 24.7\text{MM}$	ZL-AN57-12B-1	1
6	胶圈	$\varnothing 6.0\text{MM} \times 25.0\text{MM}$, 硅胶	ZL-SMA-RU-700	1
5	旋转套	C3604, 镀镍, 黑色, $\varnothing 10 \times 8.9\text{MM}$	ZL-SMA-MC-915BN	1
4	本体	黄铜, 镀镍, $\varnothing 4.5 \times 14.6\text{MM}$	ZL-SMA-MB-47146N	1
3	绝缘体	PTFE, $\varnothing 3.6 \times 7.2\text{MM}$, 白色	ZL-SMA-PT-3672	1
2	公头带孔	黑色半塑铜头	ZL-SMA-MP-C945G	1
1	线材	RG137线材	HTC137-006	1

		博格斯通信技术有限公司 Bogesi Organism Magnet Industry Co.,Ltd				
变更内容		变更日期	产品编号	BGS-001F	材质	Cable
公差范围	其它不超过 ± 0.2	设计	客户编号	/	版本	RA
		审核	零件名称	2.4G+5.8G WIFI天线	项目号	BGS-001
		核准	发行日期	2021-09-10		第1页 共1页



天线包装说明

一、外包装：纸箱包装

正面图：



侧面图：



二、内包装（50PCS/包，包装袋尺寸依产品尺寸而定）

