

FCC DFS TEST REPORT

For

Prepared by

Product Name: Wireless Presentation & Collaboration System

Brand Name: DELTA , VIVITEK

Model No.: NP2000

Series Model.: DS200

FCC ID: H79-0120C8

Test Report Number:

C151118R01-RPW3

Issued to

Delta Electronic Incorporated.

3 Tungyung rd., Chungli Industrial Zone, Taoyuan County 32063 Taiwan

Issued by

Compliance Certification Services Inc.

Kun shan Laboratory

**No.10 Weiye Rd., Innovation park, Eco&Tec,
Development Zone, Kunshan City, Jiangsu, China**

TEL: 86-512-57355888

FAX: 86-512-57370818



Note: This report shall not be reproduced except in full, without the written approval of Compliance Certification Services Inc. This document may be altered or revised by Compliance Certification Services Inc. personnel only, and shall be noted in the revision section of the document.



Revision History

Rev.	Issue Date	Report NO.	Effect Page	Contents
00	May 14, 2016	C151118R01-RPW3	ALL	N/A

TABLE OF CONTENTS

1. TEST RESULT CERTIFICATION	4
2. EUT DESCRIPTION	5
LOCAL SUPPORT EQUIPMENT:	6
EUT OPERATION FREQUENCY:	7
3. FACILITIES AND ACCREDITATIONS	8
FACILITIES	8
TABLE OF ACCREDITATIONS AND LISTINGS	8
4. SUMMARY OF TEST RESULTS.....	9
5. REQUIREMENTS AND PARAMETERS FOR DFS TEST	10
6. INSTRUMENT CALIBRATION	14
7. CALIBRATION SETUP AND DFS TEST RESULTS.....	15
7.1 CALIBRATION OF RADAR WAVEFORM.....	15
7.1.1 RADAR WAVEFORM CALIBRATION PROCEDURE.....	15
7.1.2 RADIATED CALIBRATION SETUP	15
7.1.3 CALIBRATION DEVIATION	15
7.1.4 RADAR WAVEFORM CALIBRATION RESULT	16
7.2 IN-SERVICE MONITORING: CHANNEL MOVE TIME, CHANNEL CLOSING TRANSMISSION TIME AND NON-OCCUPANCY PERIOD	17
7.2.1 LIMIT OF IN-SERVICE MONITORING	17
7.2.2 TEST PROCEDURES	18
7.2.3 TEST SETUP.....	19
7.2.4 TEST DEVIATION.....	19
7.2.5 RESULT OF CHANNEL MOVE TIME, CHANNEL CLOSING TRANSMISSION TIME AND NON-OCCUPANCY PERIOD FOR CLIENT BEACON TEST	20
7.2.6 CHANNEL MOVE TIME, CHANNEL CLOSING TRANSMISSION TIME AND NON-OCCUPANCY PERIOD FOR CLIENT BEACON TEST PLOTS	21
APPENDIX 1 - PHOTOGRAPHS OF EUT SETUP	28

1. TEST RESULT CERTIFICATION

Applicant: **Delta Electronic Incorporated.**
 3 Tungyung rd., Chungli Industrial Zone, Taoyuan County
 32063 Taiwan

Equipment Under Test: Wireless Presentation & Collaboration System

Trade Name: DELTA , VIVITEK

Model: NP2000

Date of Test: May 3, 2016 ~ May 13, 2016

APPLICABLE STANDARDS	
STANDARD	TEST RESULT
FCC 47 CFR Part 15 Subpart E	No non-compliance noted

Statement:

Compliance Certification Services Inc. tested the above equipment. The test data, data evaluation, test procedures, and equipment configurations shown in this report were made in accordance with the procedures given in ANSI C63.10: 2013 and the energy emitted by the sample EUT tested as described in this report is in compliance with conducted and radiated emission limits of FCC Rules Part 15.407.

The test results of this report relate only to the tested sample identified in this report.

Approved by:

Jeff.Fang

RF Manager

Compliance Certification Service Inc.

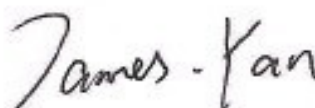
Tested by:

James.Yan

Test Engineer

Compliance Certification Service Inc.

2. EUT DESCRIPTION

Product Name	Wireless Presentation & Collaboration System
Brand Name	DELTA , VIVITEK
Model Name	NP2000
Model Discrepancy	N/A
Series Model	DS200
Received Date	November 18, 2015
Power Supply	Power supply and ADP (rating): Model: W12-010N3A Input: 100-240V-50/60Hz 0.3A Output: 5V 2A
Operating Frequency Range	5250 MHz ~ 5350 MHz 5470 MHz ~ 5725 MHz
EUT support WLAN function	<5250 MHz ~ 5350 MHz> 802.11a 802.11n HT20 802.11n HT40 802.11ac VHT20 802.11ac VHT40 802.11ac VHT80 <5470 MHz ~ 5725 MHz > 802.11a 802.11n HT20 802.11n HT40 802.11ac VHT20 802.11ac VHT40 802.11ac VHT80
Type of Modulation	802.11a : OFDM (6,9,12,18,24,36,48 and 54 Mbps) 802.11n : OFDM (MCS0~MCS7) 802.11ac : OFDM (MCS0~MCS7)
Antenna Specification	Antenna1 Gain: 3.0 dBi Antenna2 Gain: 3.0 dBi
Antenna Designation	PCB Antenna
DFS Function	Client without radar detection function

LOCAL SUPPORT EQUIPMENT:

No.	Device Type	Brand	Model	Series No.	FCC ID	Data Cable
1.	Notebook PC	Dell	E5430	CN8YYW1	FCC DoC	N.C.R
2	AP Router	Aerohive	AP130	01301503311156	WBV-AP130	N.C.R

EUT OPERATION FREQUENCY:

UNLICENSED NATIONAL INFORMATION INFRASTRUCTURE (U-NII)	
CHANNEL	MHz
36	5180
38	5190
40	5200
44	5220
46	5230
48	5240
52	5260
54	5270
56	5280
60	5300
62	5310
64	5320
100	5500
102	5510
104	5520
108	5540
110	5550
112	5560
116	5580
118	5590
120	5600
124	5620
126	5630
128	5640
132	5660
134	5670
136	5680
140	5700
149	5745
153	5765
157	5785
161	5805
165	5825

3. FACILITIES AND ACCREDITATIONS

FACILITIES

All measurement facilities used to collect the measurement data are located at

No.10Weiye Rd., Innovation park, Eco&Tec, Development Zone, Kunshan City, Jiangsu, China.

The sites are constructed in conformance with the requirements of ANSI C63.10:2013 and CISPR Publication 22. All receiving equipment conforms to CISPR Publication 16-1, "Radio Interference Measuring Apparatus and Measurement Methods."

TABLE OF ACCREDITATIONS AND LISTINGS

Our laboratories are accredited and approved by the following accreditation body according to ISO/IEC 17025.

USA	A2LA
China	CNAS

The measuring facility of laboratories has been authorized or registered by the following approval agencies.

Canada	Industry Canada
Japan	VCCI
Taiwan	BSMI
USA	FCC

Copies of granted accreditation certificates are available for downloading from our web site, <http://www.ccsrf.com>.

4. SUMMARY OF TEST RESULTS

UNII	Bandwidth and Channel	Description	Measured	Limit	Result
UNII Band 2-A 5250-5350MHz	80MHz (CH58) 5530MHz	Channel Move Time	409.5 ms	10 sec	Pass
		Channel Closing Transmission time	<200ms + 4.5 ms (aggregate)	200 ms + aggregate of 60 ms over remaining 10 s period	Pass
		Non-Occupancy Period and Client Beacon Test	No transmission or Beacons occurred	30 minutes	Pass
UNII Band 2-C 5470-5725MHz	(CH106) 5530MHz80 MHz	Channel Move Time	355.5 ms	10 sec	Pass
		Channel Closing Transmission time	<200ms + 6.0 ms (aggregate)	200 ms + aggregate of 60 ms over remaining 10 s period	Pass
		Non-Occupancy Period and Client Beacon Test	No transmission or Beacons occurred	30 minutes	Pass

Note: Since the product is client without radar detection function, only Channel Move Time, Channel Closing Transmission Time and Non-Occupancy Period Test are required to be performed.

5. REQUIREMENTS AND PARAMETERS FOR DFS TEST

5.1 Applicability of DFS Requirements

EUT is client and operates as client without radar detection function.

Table 1: Applicability of DFS requirements prior to use of a channel

Requirement	Operational Mode		
	Master	Client (without radar detection)	Client(with radar detection)
Non-Occupancy Period	Yes	Not required	Yes
DFS Detection Threshold	Yes	Not required	Yes
Channel Availability Check Time	Yes	Not required	Not required
U-NII Detection Bandwidth	Yes	Not required	Yes

Table 2: Applicability of DFS requirements during normal operation

Requirement	Operational Mode		
	Master	Client (without radar detection)	Client(with radar detection)
DFS Detection Threshold	Yes	Not required	Yes
Channel Closing Transmission Time	Yes	Yes	Yes
Channel Move Time	Yes	Yes	Yes
U-NII Detection Bandwidth	Yes	Not required	Yes
Client Beacon Test	N/A	Yes	Yes

Additional requirements for devices with multiple bandwidth modes	Operational Mode	
	Master Device or Client with Radar Detection	Client Without Radar Detection
U-NII Detection Bandwidth and Statistical Performance Check	All BW modes must be tested	Not required
Channel Move Time and Channel Closing Transmission Time	Test using widest BW mode available	Test using the widest BW mode available for the link
All other tests	Any single BW mode	Not required
Note Frequencies selected for statistical performance check (Section 7.8.4) should include several frequencies within the radar detection bandwidth and frequencies near the edge of the radar detection bandwidth. For 802.11 devices it is suggested to select frequencies in each of the bonded 20 MHz channels and the channel center frequency.		

Table 3: Interference Threshold values, Master or Client incorporating In-Service

Maximum Transmit Power	Value (see note)
≥ 200 Milliwatt	-64 dBm
< 200 Milliwatt	-62 dBm
Note 1: This is the level at the input of the receiver assuming a 0 dBi receive antenna. Note 2: Throughout these test procedures an additional 1 dB has been added to the amplitude of the test transmission waveforms to account for variations in measurement equipment. This will ensure that the test signal is at or above the detection threshold level to trigger a DFS response.	

Table 4: DFS Response requirement values

Parameter	Value
Non-occupancy period	30 minutes
Channel Availability Check Time	60 seconds
Channel Move Time	10 seconds See Note 1.
Channel Closing Transmission Time	200 milliseconds + approx. 60 milliseconds over remaining 10 second period. See Notes 1 and 2.
U-NII Detection Bandwidth	Minimum 100% of the 99% power bandwidth See Note 3.

Note 1: Channel Move Time and the Channel Closing Transmission Time should be performed with Radar Type 0. The measurement timing begins at the end of the Radar Type 0 burst.

Note 2: The Channel Closing Transmission Time is comprised of 200 milliseconds starting at the beginning of the Channel Move Time plus any additional intermittent control signals required to facilitate a Channel move (an aggregate of 60 milliseconds) during the remainder of the 10 second period. The aggregate duration of control signals will not count quiet periods in between transmissions.

Note 3: During the U-NII Detection Bandwidth detection test, radar type 0 should be used. For each frequency step the minimum percentage of detection is 90 percent. Measurements are performed with no data traffic.

Table 5 – Short Pulse Radar Test Waveforms

Radar Type	Pulse Width (Microseconds)	PRI (Microseconds)	Pulses	Minimum Percentage of Successful Detection	Minimum Trials
0	1	1428	18	60%	30
1	1	Test A Test B	Roundup $\left\{ \begin{matrix} \left(\frac{1}{360} \right) \cdot \\ \left(\frac{19 \cdot 10^6}{PRI_{\mu sec}} \right) \end{matrix} \right\}$	60%	30
2	1-5	150-230	23-29	60%	30
3	6-10	200-500	16-18	60%	30
4	11-20	200-500	12-16	60%	30
Aggregate (Radar Types 1-4)				80%	120

Test A: 15 unique PRI values randomly selected from the list of 23 PRI values in Table 5a
 Test B: 15 unique PRI values randomly selected within the range of 518-3066 μsec, with a minimum increment of 1 μsec, excluding PRI values selected in Test A

A minimum of 30 unique waveforms are required for each of the short pulse radar types 2 through 4.

For short pulse radar type 1, the same waveform is used a minimum of 30 times. If more than 30 waveforms are used for short pulse radar types 2 through 4, then each additional waveform must also be unique and not repeated from the previous waveforms.

If more than 30 waveforms are used for Short Pulse Radar Type 1, then each additional waveform is generated with Test B and must also be unique and not repeated from the previous waveforms in Tests A or B.

The aggregate is the average of the percentage of successful detections of short pulse radar types 1-4.

6. INSTRUMENT CALIBRATION

MEASUREMENT EQUIPMENT USED

Test Equipment List

Dynamic Frequency Selection					
Name of Equipment	Manufacturer	Model	Serial Number	Calibration Date	Calibration Due
Spectrum Analyzer	RS	FSU26	200789	2015-8-10	2016-8-9
Vector Signal Generator	R&S	SMU200A	US42340162	2016-3-3	2016-3-2
Horn-antenna	SCHWARZBECK	9120D	D:266	2016-3-7	2017-3-5
Horn-antenna	SCHWARZBECK	9120D	D:267	2015-11-10	2016-11-9

Remark: Each piece of equipment is scheduled for calibration once a year.

7. CALIBRATION SETUP AND DFS TEST RESULTS

7.1 CALIBRATION OF RADAR WAVEFORM

7.1.1 RADAR WAVEFORM CALIBRATION PROCEDURE

The Interference Radar Detection Threshold Level is $(-62\text{dBm}) + (0) [\text{dBi}] + 1 \text{ dB} = -61\text{dBm}$ that had been taken into account the output power range and antenna gain. The following equipment setup was used to calibrate the radiated Radar Waveform. A vector signal generator was utilized to establish the test signal level for radar type 0. During this process there were no transmissions by either the Master or Client Device. The spectrum analyzer was switched to the zero span (Time Domain) at the frequency of the Radar Waveform generator. Peak detection was used. The spectrum analyzer resolution bandwidth (RBW) and video bandwidth (VBW) were set to 3 MHz to measure the type 0 radar waveform. The spectrum analyzer had offset -7.4dB to compensate receiving horn antenna gain 11.20dBi and RF cable loss 3.8dB . The vector signal generator amplitude was set so that the power level measured at the spectrum analyzer was $(-62\text{dBm}) + (0) [\text{dBi}] + 1\text{dB} = -61\text{dBm}$. Capture the spectrum analyzer plots on short pulse radar waveform.

7.1.2 RADIATED CALIBRATION SETUP

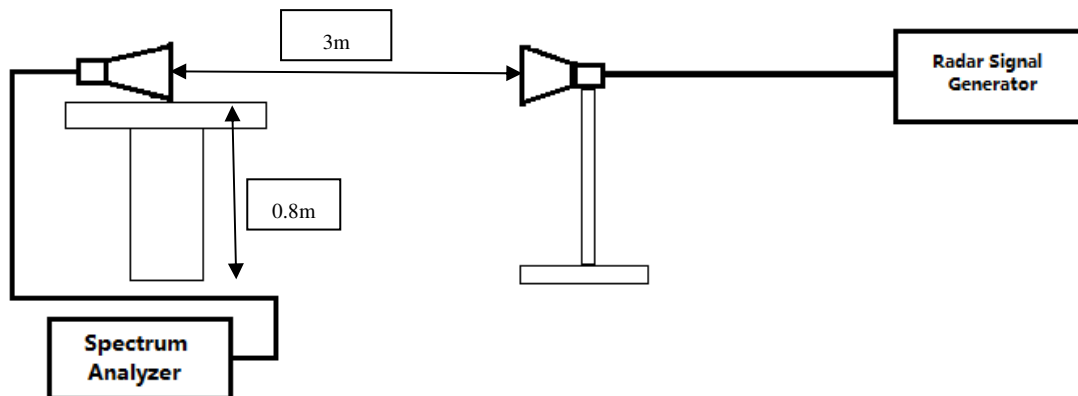

7.1.3 CALIBRATION DEVIATION

There is no deviation with the original standard.

7.1.4 RADAR WAVEFORM CALIBRATION RESULT

80MHz / 5290 MHz- Radar Type 0

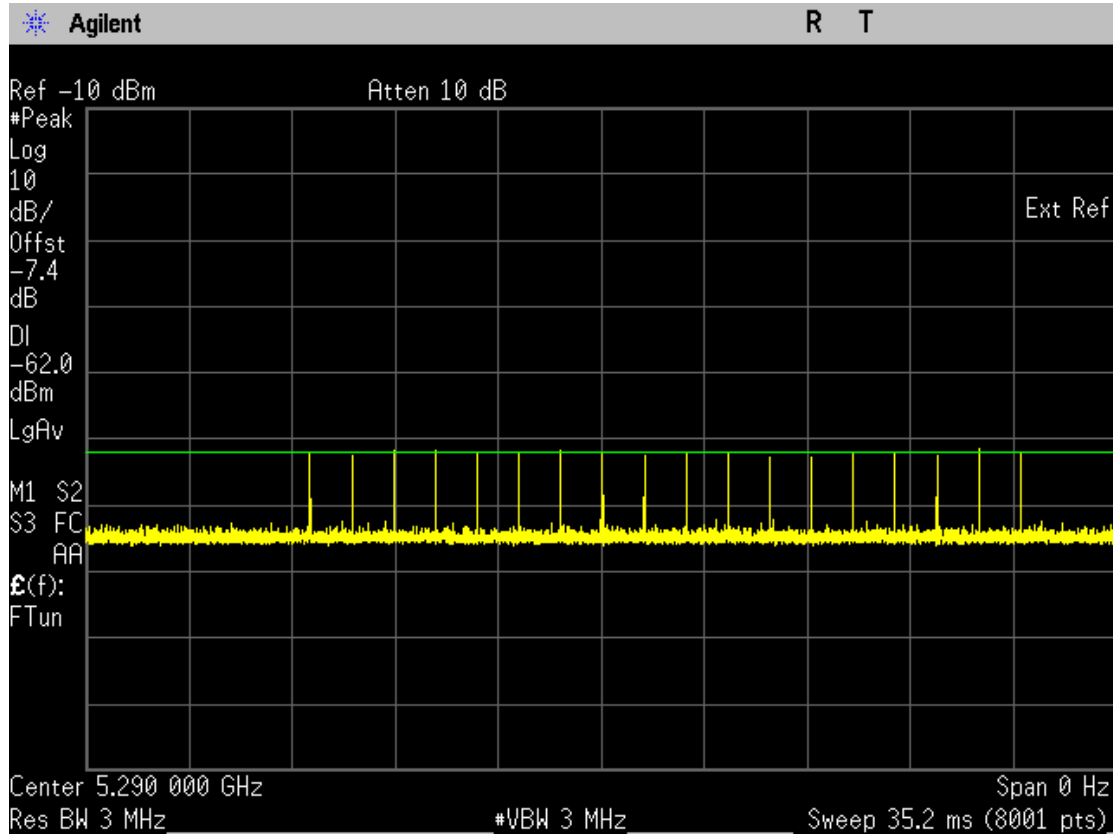

80MHz / 5530 MHz- Radar Type 0

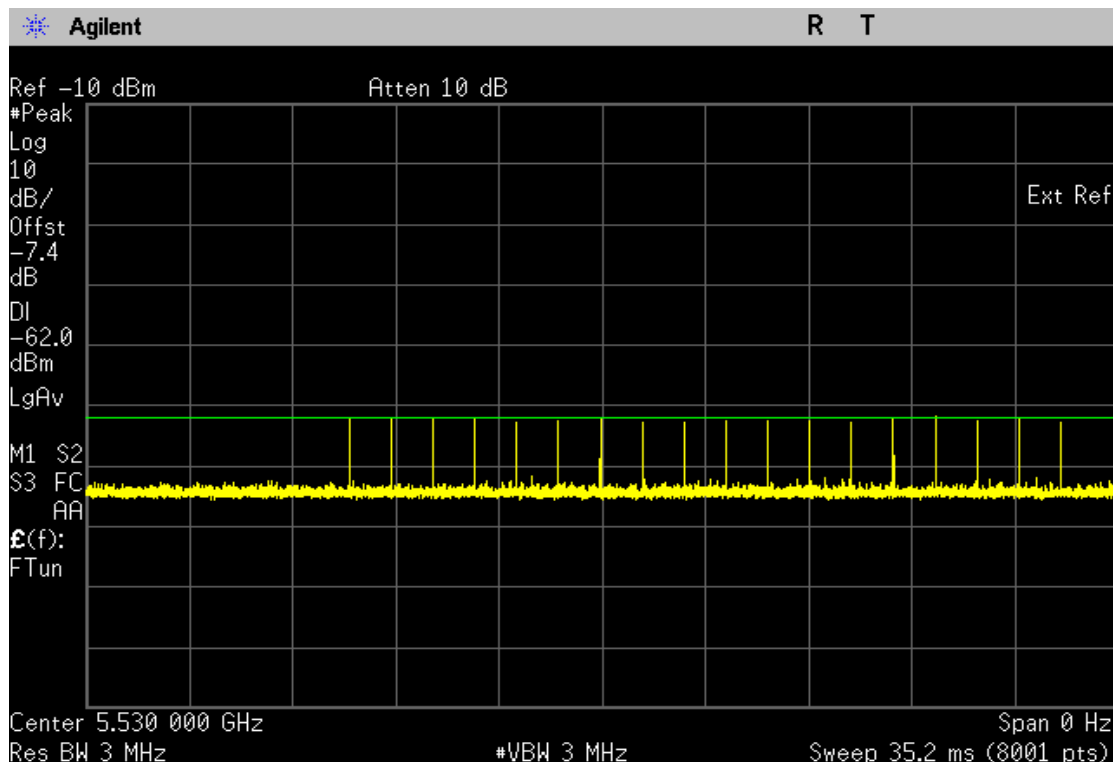

7.2 IN-SERVICE MONITORING: CHANNEL MOVE TIME, CHANNEL CLOSING TRANSMISSION TIME AND NON-OCCUPANCY PERIOD

7.2.1 LIMIT OF IN-SERVICE MONITORING

The EUT has In-Service Monitoring function to continuously monitor the radar signals, If radar is detected, it must leave the channel (Shutdown). The Channel Move Time to cease all transmissions on the current Channel upon detection of a Radar Waveform above the DFS Detection Threshold within 10 sec. The total duration of Channel Closing Transmission Time is comprised of 200 milliseconds starting at the beginning of the Channel Move Time plus any additional intermittent control signals required to facilitate Channel changes (an aggregate of 60 milliseconds) during the remainder of the 10 second period. The aggregate duration of control signals will not count quiet periods in between transmissions. Non-Occupancy Period time is 30 minute during which a Channel will not be utilized after a Radar Waveform is detected on that Channel. The non-associated Client Beacon Test is during the 30 minutes observation time. The EUT should not make any transmissions in the DFS band after EUT power up.

7.2.2 TEST PROCEDURES

1. The radar pulse generator is setup to provide a pulse at frequency that the Master and Client are operating. A type 0 radar pulse with a 1us pulse width and a 1428 us PRI is used for the testing.
2. The vector signal generator is adjusted to provide the radar burst (18 pulses) at a level of approximately -62dBm at the antenna of the Master device.
3. A trigger is provided from the pulse generator to the DFS monitoring system in order to capture the traffic and the occurrence of the radar pulse.
4. A U-NII device operating as a Client Device will associate with the Master at Channel. The MPEG file "TestFile.mpg" specified by the FCC is streamed from the "file computer" through the Master to the Client Device and played in full motion video using Media Player Classic Ver.6.4.8.6 in order to properly load the network for the entire period of the test.
5. When a radar Burst with a level equal to the DFS Detection Threshold + 1dB is generated on the Operating Channel of the U-NII device. At time T0 the Radar Waveform generator sends a Burst of pulse of the radar waveform at Detection Threshold + 1dB.
6. Observe the transmissions of the EUT at the end of the radar Burst on the Operating Channel. Measure and record the transmissions from the EUT during the observation time (Channel Move Time). One 12 seconds plot is reported for the Short Pulse Radar Types 1. The plot for the Short Pulse Radar Types start at the end of the radar burst. The Channel Move Time will be calculated based on the zoom in 600ms plot of the Short Pulse Radar Type.
7. Measurement of the aggregate duration of the Channel Closing Transmission Time method. With the spectrum analyzer set to zero span tuned to the center frequency of the EUT operating channel at the radar simulated frequency, peak detection, and max hold, the dwell time per bin is given by: $Dwell (1.5ms) = S (12000ms) / B (8001)$; where Dwell is the dwell time per spectrum analyzer sampling bin, S is the sweep time and B is the number of spectrum analyzer sampling bins. An upper bound of the aggregate duration of the intermittent control signals of Channel Closing Transmission Time is calculated by: $C (ms) = N \times Dwell (1.5 ms)$; where C is the Closing Time, N is the number of spectrum analyzer sampling bins (intermittent control signals) showing a U-NII transmission and Dwell is the dwell time per bin.
8. Measure the EUT for more than 30 minutes following the channel move time to verify that no transmissions or beacons occur on this Channel.

7.2.3 TEST SETUP

Radiated Test Setup Photo

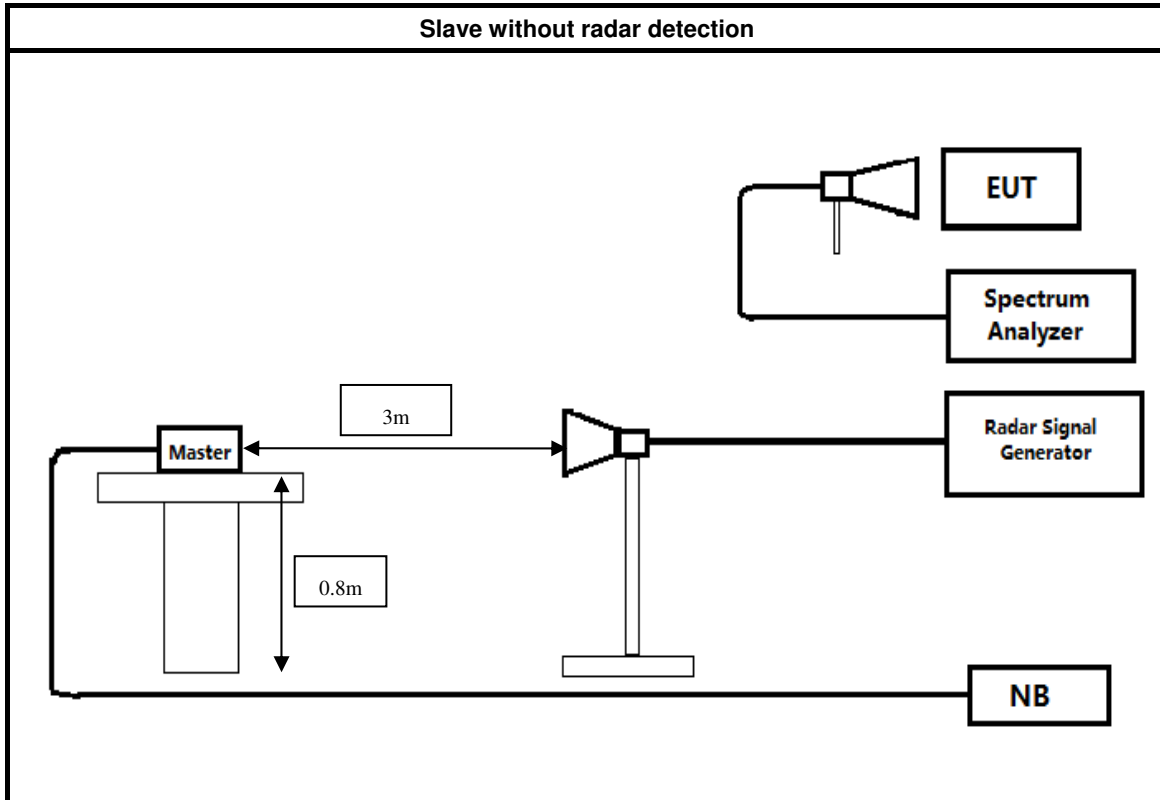

7.2.4 TEST DEVIATION

There is no deviation with the original standard.

7.2.5 RESULT OF CHANNEL MOVE TIME, CHANNEL CLOSING TRANSMISSION TIME AND NON-OCCUPANCY PERIOD FOR CLIENT BEACON TEST

Test Mode :	Client without radar detection	Temperature:	20°C
Test By:	James.Yan	Relative Humidity :	45~48%

BW/Channel	Test Item	Test Result	Limit	Pass/Fail
80MHz/5290MHz	Channel Move Time	409.5 ms	< 10s	Pass
	Channel Closing Transmission Time	200ms + 4.5 ms	< 260ms	Pass
	Non-Occupancy Period	≥ 30	≥ 30 min	Pass
80MHz/5530MHz	Channel Move Time	355.5 ms	< 10s	Pass
	Channel Closing Transmission Time	200ms + 6.0 ms	< 260ms	Pass
	Non-Occupancy Period	≥ 30	≥ 30 min	Pass

Note: The Channel Closing Transmission Time is comprised of 200 milliseconds starting at the beginning of the Channel Move Time plus any additional intermittent control signals required to facilitate a Channel move (an aggregate of 60 milliseconds) during the remainder of the 10 seconds period. The aggregate duration of control signals will not count quiet periods in between transmissions.

7.2.6 CHANNEL MOVE TIME, CHANNEL CLOSING TRANSMISSION TIME AND NON-OCCUPANCY PERIOD FOR CLIENT BEACON TEST PLOTS

Data Traffic and Noise Floor Plots

EUT data traffic (Client)- 80MHz / 5290 MHz

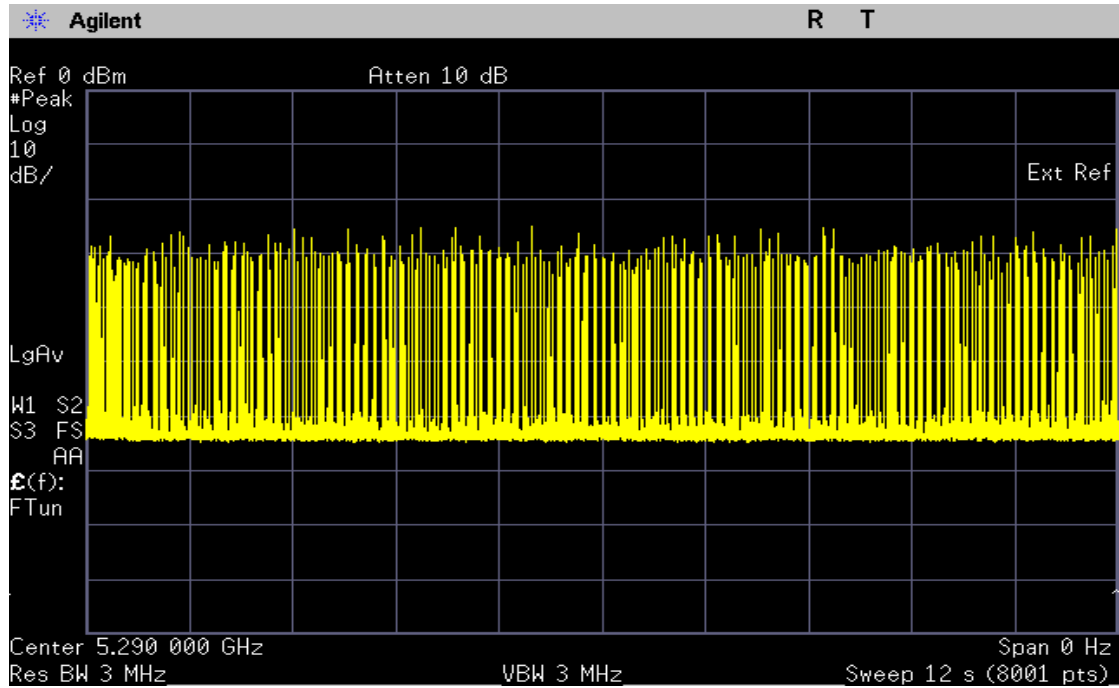

Access Point data traffic (Master) - 80MHz / 5290 MHz

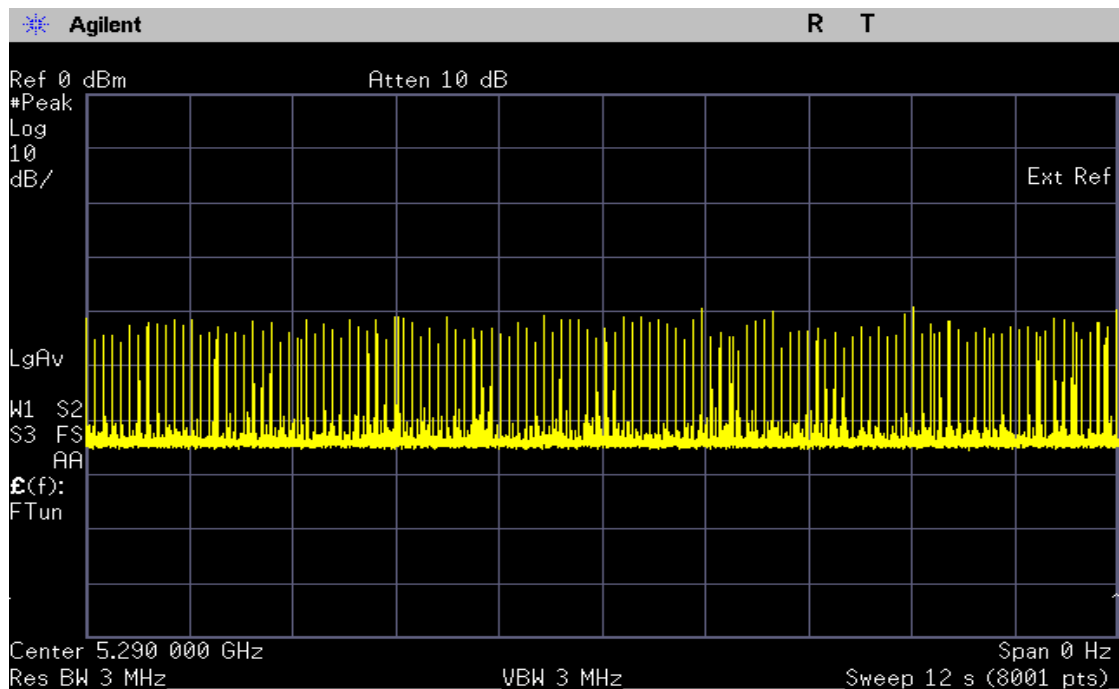

Noise Floor (No transmission) - 80MHz / 5290 MHz

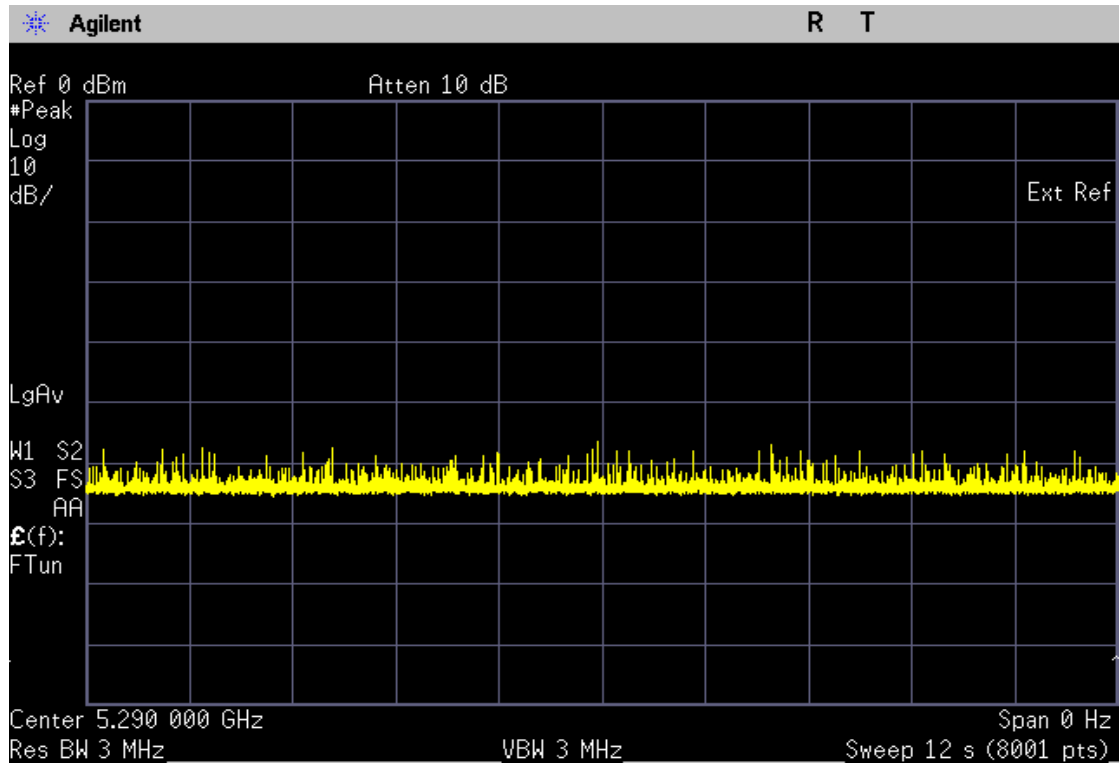

EUT data traffic (Client)- 80MHz / 5530 MHz

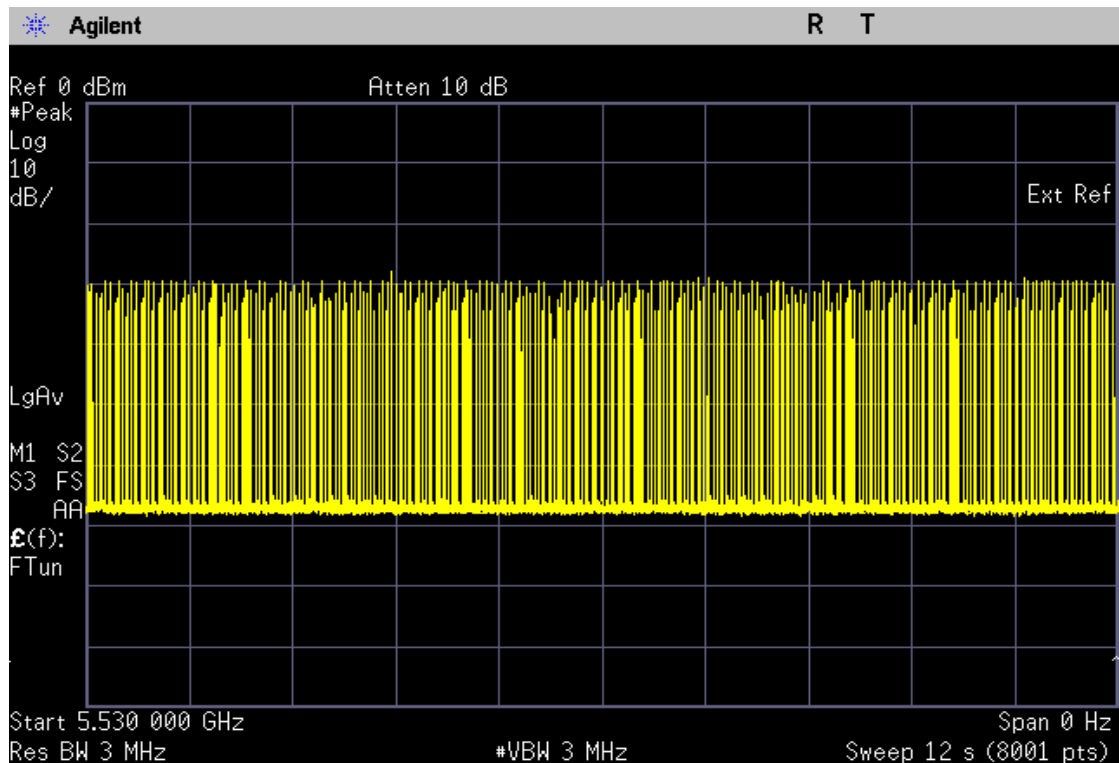

Access Point data traffic (Master) - 80MHz / 5530 MHz

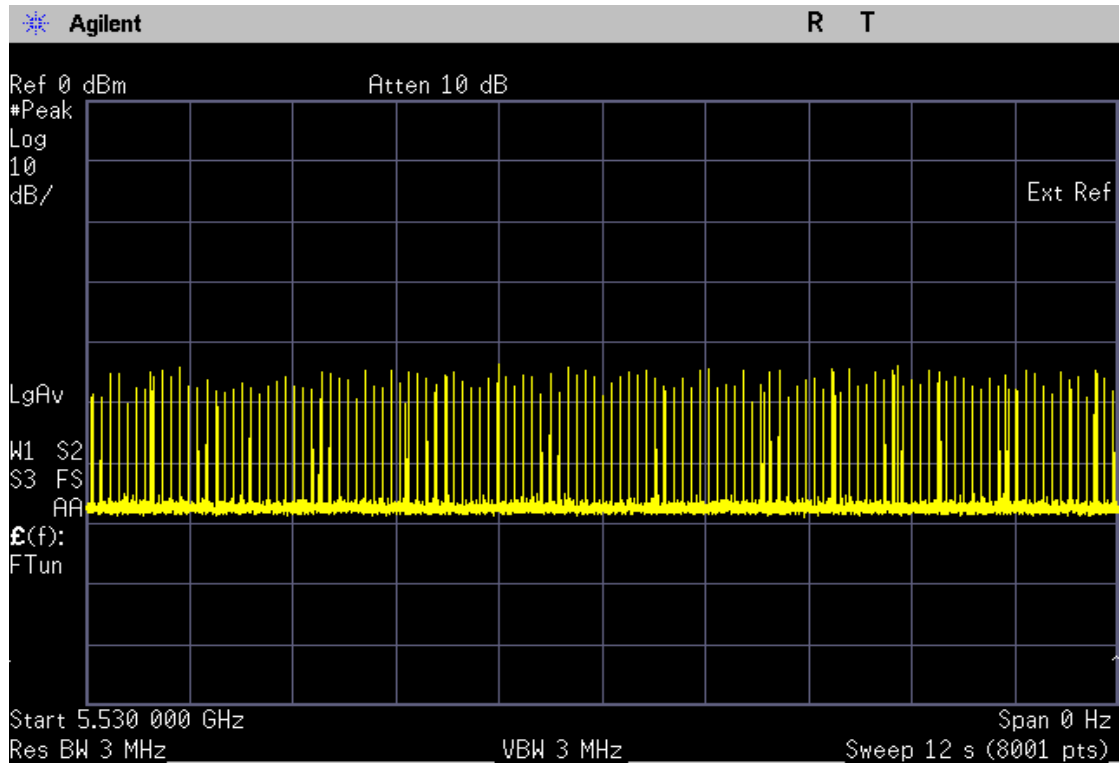

Noise Floor (No transmission) - 80MHz / 5530 MHz

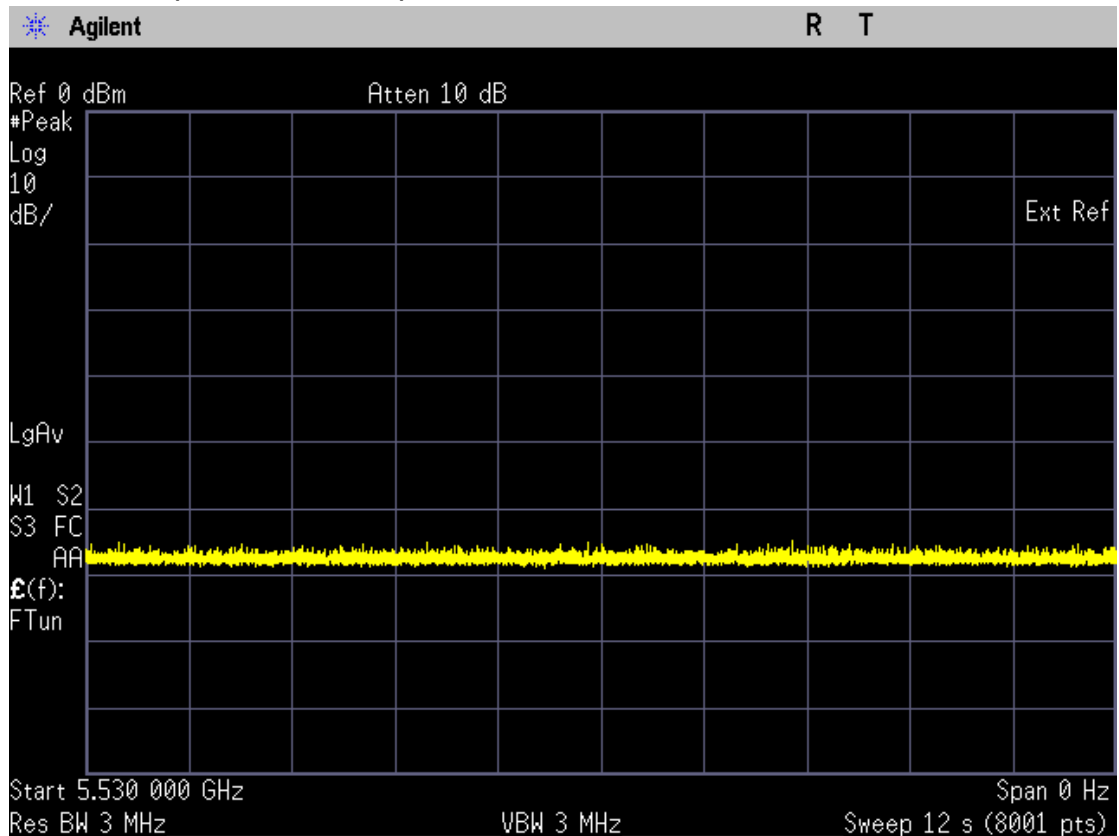

80MHz / 5290 MHz

Channel Move Time & Channel Closing Transmission Time

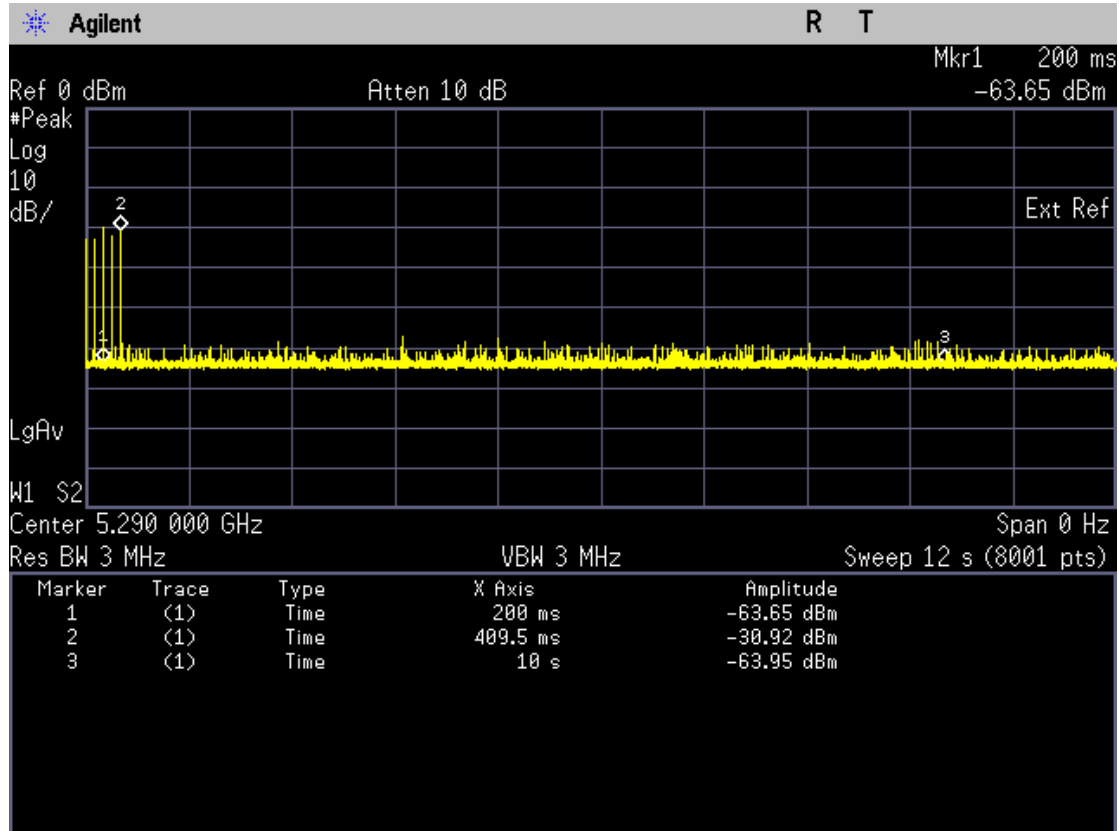

Note:

Dwell (1.5 ms)= Sweep Time (12000 ms) / Sweep Point Bins (8001)

Channel Closing Transmission Time (200 + 4.5 ms) = 200 + Number (3 X Dwell (1.5 ms)) < 260ms

Non-Occupancy Period

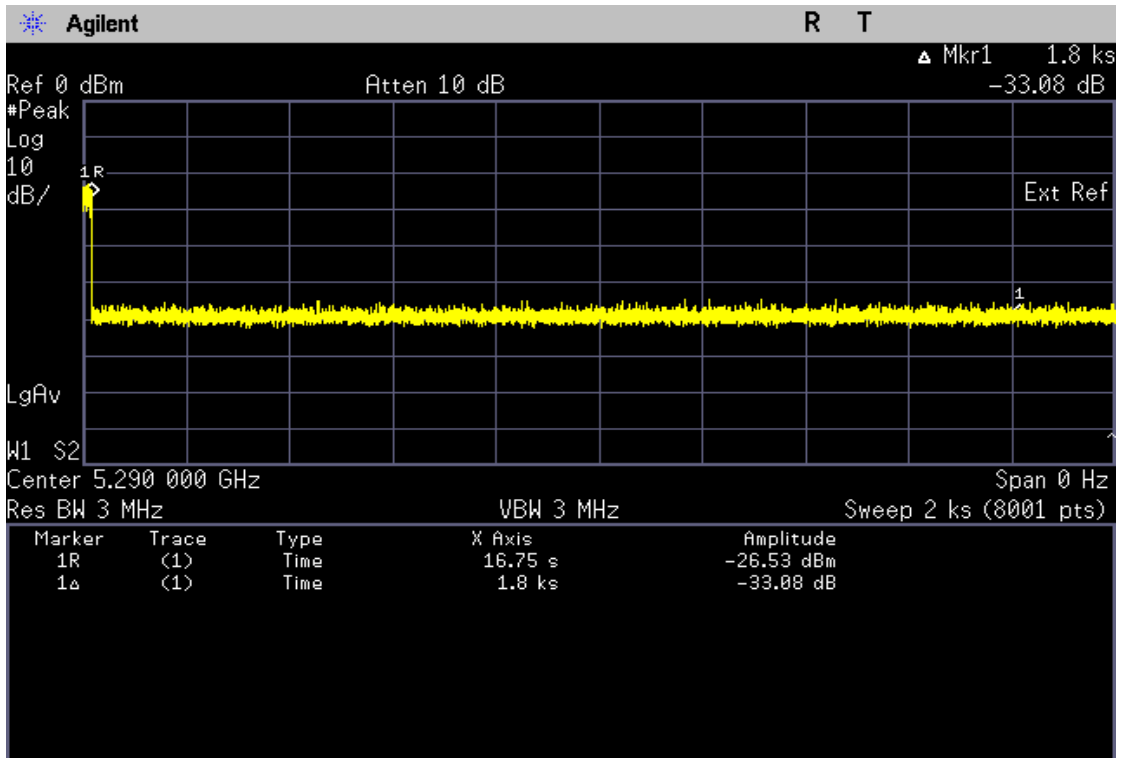

Non-associated test Master was off. (beacon test)

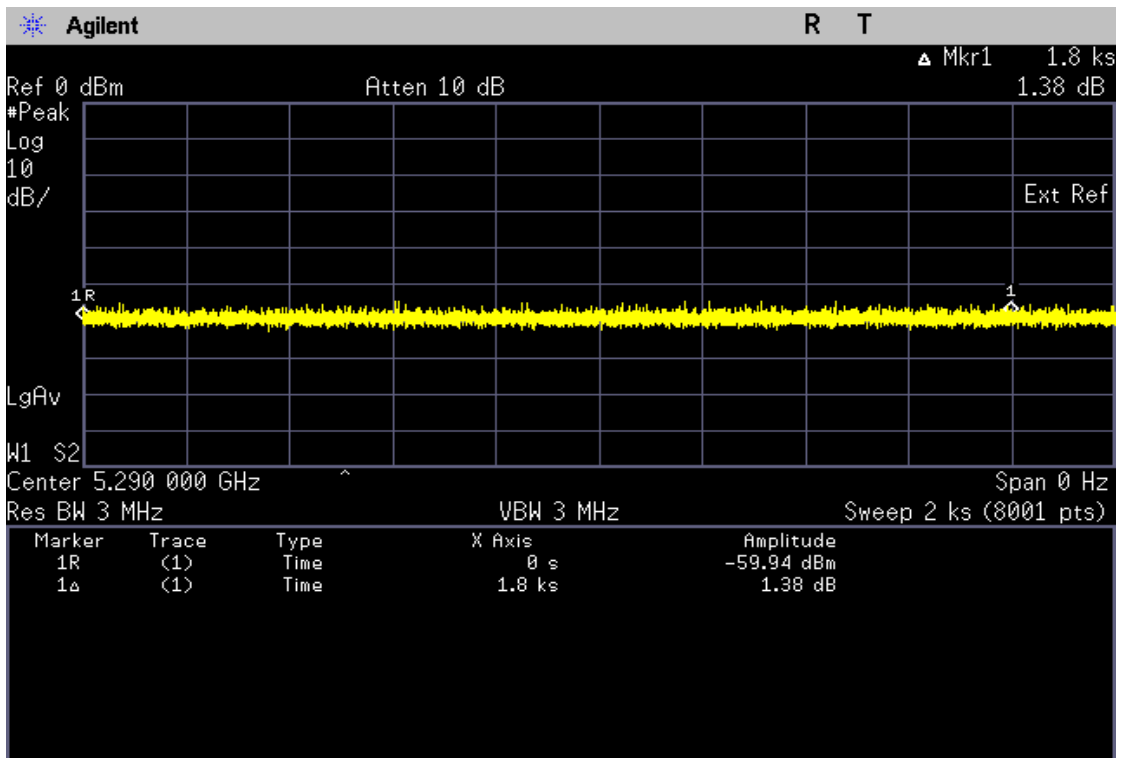

80MHz / 5530 MHz

Channel Move Time & Channel Closing Transmission Time

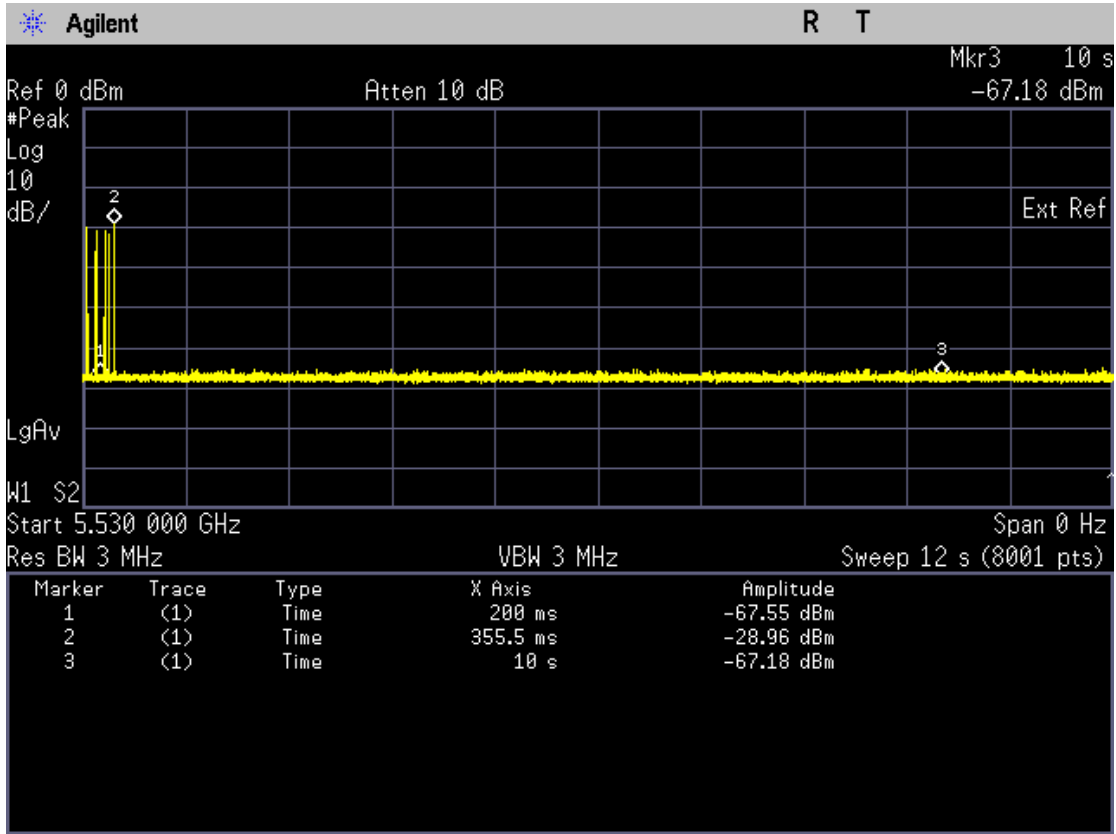

Note:

Dwell (1.5 ms) = Sweep Time (12000 ms) / Sweep Point Bins (8001)

Channel Closing Transmission Time (200 + 6.0 ms) = 200 + Number (4 X Dwell (1.5 ms)) < 260ms

Non-Occupancy Period

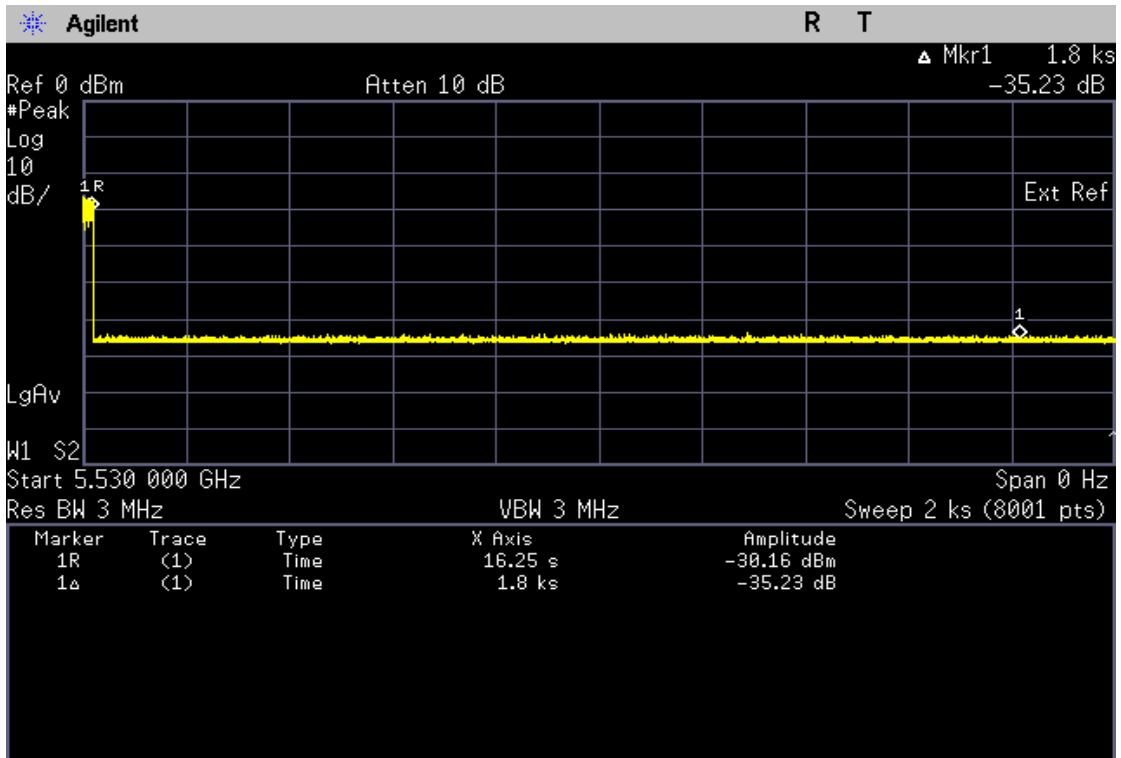

Non-associated test Master was off. (beacon test)

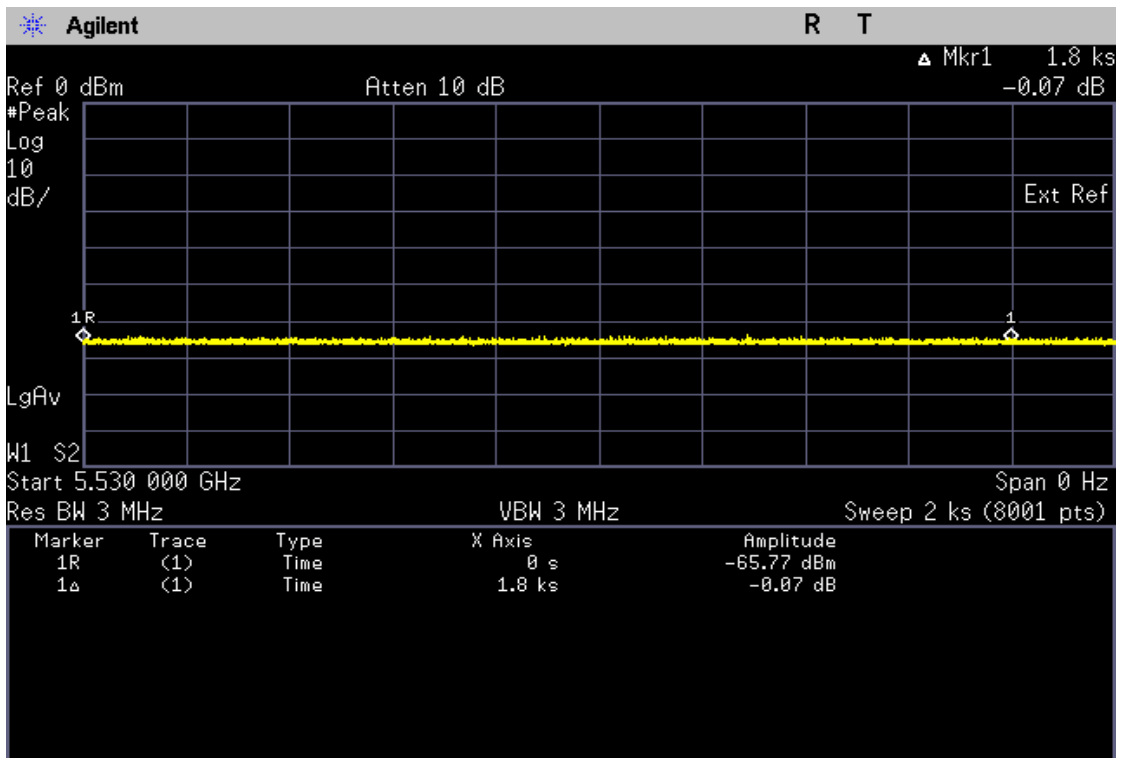

APPENDIX 1 - PHOTOGRAPHS OF EUT SETUP