

FCC 47 CFR PART15 SUBPART E

For

Prepared by

Product Name: Wireless Presentation & Collaboration System

Brand Name: DELTA , VIVITEK

Model No.: NP2000

Series Model.: DS200

FCC ID:H79-0120C8

Test Report Number:

C151118R01-RPW1

Issued for

Delta Electronic Incorporated.

3 Tungyung rd., Chungli Industrial Zone, Taoyuan County 32063 Taiwan

Issued by

Compliance Certification Services Inc.

Kun shan Laboratory

**No.10 Weiye Rd., Innovation park, Eco&Tec,
Development Zone, Kunshan City, Jiangsu, China**

TEL: 86-512-57355888

FAX: 86-512-57370818



Note: This report shall not be reproduced except in full, without the written approval of Compliance Certification Services Inc. This document may be altered or revised by Compliance Certification Services Inc. personnel only, and shall be noted in the revision section of the document. The client should not use it to claim product endorsement by A2LA or any government agencies. The test results in the report only apply to the tested sample.

Revision History

Revision	REPORT NO.	Date	Page Revised	Contents
Original	C151118R01-RPW1	May 10, 2016	N/A	N/A
01	C151118R01-RPW1	June 1, 2016	P11,P49~P52, P67,P91,P144, P149~P167	Add section 7.5,On page 49 to 52 update the OBW plots,On page 149 to 167 update the RSE data,On page 67&91 add antennas description, Calculate the antenna gain is 3dBi,on page 144 add 9kHz to 30MHz don't test specification

TABLE OF CONTENTS

1	TEST RESULT CERTIFICATION	4
2	EUT DESCRIPTION.....	5
3	TEST METHODOLOGY.....	7
3.1	EUT CONFIGURATION	7
3.2	EUT EXERCISE.....	7
3.3	GENERAL TEST PROCEDURES.....	7
3.4	FCC PART 15.205 RESTRICTED BANDS OF OPERATIONS	8
3.5	DESCRIPTION OF TEST MODES.....	9
3.6	ANTENNA DESCRIPTION.....	10
4	INSTRUMENT CALIBRATION	11
4.1	MEASUREMENT EQUIPMENT USED	11
4.2	MEASUREMENT UNCERTAINTY	12
5	FACILITIES AND ACCREDITATIONS	13
5.1	FACILITIES.....	13
5.2	EQUIPMENT.....	13
5.3	TABLE OF ACCREDITATIONS AND LISTINGS	13
5.4	TABLE OF ACCREDITATIONS AND LISTINGS.....	14
6	SETUP OF EQUIPMENT UNDER TEST	15
6.1	SETUP CONFIGURATION OF EUT.....	15
6.2	SUPPORT EQUIPMENT.....	15
7	FCC PART 15 REQUIREMENTS	16
7.1	26 DB EMISSION BANDWIDTH.....	16
7.2	MAXIMUM CONDUCTED OUTPUT POWER	67
7.3	BAND EDGES MEASUREMENT	72
7.4	MAXIMUM POWER SPECTRAL DENSITY.....	91
7.5	FREQUENCY STABILITY MEASUREMENT.....	139
7.6	RADIATED UNDESIRABLE EMISSION	141
7.7	POWERLINE CONDUCTED EMISSIONS	167

1 TEST RESULT CERTIFICATION

Product Name:	Wireless Presentation & Collaboration System
Trade Name:	DELTA , VIVITEK
Model Name.:	NP2000
Series Model:	DS200
Applicant Discrepancy:	Initial
Device Category:	Production unit
Date of Test:	April 16, 2016 ~ April 29, 2016 & May 31, 2016
Applicant:	Delta Electronic Incorporated. 3 Tungyung rd., Chungli Industrial Zone, Taoyuan County 32063 Taiwan
Manufacturer:	Delta Electronic Incorporated. 3 Tungyung rd., Chungli Industrial Zone, Taoyuan County 32063 Taiwan
Application Type:	Certification

APPLICABLE STANDARDS	
STANDARD	TEST RESULT
FCC 47 CFR Part 15 Subpart E	No non-compliance noted

The above equipment was tested by Compliance Certification Services Inc. The test data, data evaluation, test procedures, and equipment configurations shown in this report were made in accordance with the procedures given in ANSI C63.10: 2013 and the energy emitted by the sample EUT tested as described in this report is in compliance with the requirements of FCC Rules Part 15.207, 15.209, 15.407 and KDB 789033.

The test results of this report relate only to the tested sample EUT identified in this report.

Approved by:

Tested by:

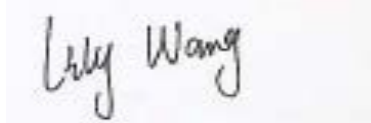
Jeff.Fang
RF Manager
Compliance Certification Service Inc.

Lily.Wang
Test Engineer
Compliance Certification Service Inc.

2 EUT DESCRIPTION

Product Name:	Wireless Presentation & Collaboration System			
Brand Name:	DELTA , VIVITEK			
Model Name:	NP2000			
Series Model:	DS200			
Model Discrepancy:	Only for market segment			
Power Adapter:	Power supply and ADP (rating): Model: W12-010N3A Input: 100-240V-50/60Hz 0.3A Output: 5V 2A			
Frequency Range :	Band	Mode	Frequency Range(MHz)	Number of Channels
	Band I UNII-I	IEEE802.11a mode	5150 MHz~5250 MHz	4
		IEEE802.11an HT20 mode		4
		IEEE802.11an HT40 mode		2
		IEEE802.11ac VHT20 mode		4
		IEEE802.11ac VHT40 mode		2
		IEEE802.11ac VHT80 mode		1
	Band II UNII-2A	IEEE802.11a mode	5250 MHz ~5350 MHz	4
		IEEE802.11an HT20 mode		4
		IEEE802.11an HT40 mode		2
		IEEE802.11ac VHT20 mode		4
		IEEE802.11ac VHT40 mode		2
		IEEE802.11ac VHT80 mode		1
	Band II UNII-2C	IEEE802.11a mode	5470 MHz ~5725 MHz	11
		IEEE802.11an HT20 mode		11
		IEEE802.11an HT40 mode		5
		IEEE802.11ac VHT20 mode		11
		IEEE802.11ac VHT40 mode		5
IEEE802.11ac VHT80 mode		2		
Transmit Power :	IEEE802.11a mode: 14.79dBm IEEE802.11an HT20 mode: 17.23dBm IEEE802.11an HT40 mode: 17.80dBm IEEE802.11ac VHT20 mode: 14.68dBm IEEE802.11ac VHT40 mode: 15.35dBm IEEE802.11ac VHT80 mode: 14.35dBm			
Modulation Technique :	IEEE802.11a mode: OFDM (6,9,12,18,24,36,48 and 54 Mbps) IEEE802.11an HT20 mode: OFDM (MCS0~MCS7) IEEE802.11an HT40 mode: OFDM (MCS0~MCS7) IEEE802.11ac VHT20 mode: OFDM (MCS0~MCS7) IEEE802.11ac VHT40 mode: OFDM (MCS0~MCS7) IEEE802.11ac VHT80 mode: OFDM (MCS0~MCS7)			
Antenna Specification:	Antenna1 Gain: 3.0 dBi Antenna2 Gain: 3.0 dBi			

Remark:

1. The sample selected for test was engineering sample that approximated to production product and was provided by manufacturer.
2. This submittal(s) (test report) is intended for **FCC ID:H79-0120C8** filing to comply with FCC Part 15, Subpart E Rules.

3 TEST METHODOLOGY

The tests documented in this report were performed in accordance with ANSI C63.10:2013 and FCC CFR 47 15.207, 15.209 and 15.407, RSS-247.

3.1 EUT CONFIGURATION

The EUT configuration for testing is installed for RF field strength measurement to meet the Commissions requirement, and is operated in a manner intended to generate the maximum emission in a continuous normal application.

3.2 EUT EXERCISE

The EUT is operated in the engineering mode to fix the Tx frequency for the purposes of measurement.

According to its specifications, the EUT must comply with the requirements of Section 15.407 under the FCC Rules Part 15 Subpart E.

3.3 GENERAL TEST PROCEDURES

Conducted Emissions

The EUT is placed on the turntable, which is positioned at 0.8 m above the ground plane. According to the requirements in Section 13.3 of ANSI C63.10:2013, the conducted emission from the EUT is measured in the frequency range between 0.15 MHz and 30MHz, using the CISPR Quasi-Peak detector mode.

Radiated Emissions

Under 1GHz

The EUT is placed on a turn table, which is 0.8 m above ground plane. The turntable shall rotate 360 degrees to determine the position of maximum emission level. EUT is set 3m away from the receiving antenna, which varied from 1m to 4m to find out the highest emission. And also, each emission was to be maximized by changing the polarization of receiving antenna both horizontal and vertical. In order to find out the maximum emissions, exploratory radiated emission measurements were made according to the requirements in Section 13.1.4.1 of ANSI C63.10:2013.

Above 1GHz

The EUT is placed on a turn table, which is 1.5 m above ground plane. The turntable shall rotate 360 degrees to determine the position of maximum emission level. EUT is set 3m away from the receiving antenna, which varied from 1m to 4m to find out the highest emission. And also, each emission was to be maximized by changing the polarization of receiving antenna both horizontal and vertical. In order to find out the maximum emissions, exploratory radiated emission measurements were made according to the requirements in Section 13.1.4.1 of ANSI C63.10:2013.

3.4 FCC PART 15.205 RESTRICTED BANDS OF OPERATIONS

(a) Except as shown in paragraph (d) of this section, only spurious emissions are permitted in any of the frequency bands listed below:

MHz	MHz	MHz	GHz
0.090 - 0.110	16.42 - 16.423	399.9 - 410	4.50 - 5.15
0.495 - 0.505 ⁽¹⁾	16.69475 - 16.69525	608 - 614	5.35 - 5.46
2.1735 - 2.1905	16.80425 - 16.80475	960.0 - 1240	7.25 - 7.75
4.125 - 4.128	25.50 - 25.67	1300 - 1427	8.025 - 8.500
4.17725 - 4.17775	37.50 - 38.25	1435.0 - 1626.5	9.0 - 9.2
4.20725 - 4.20775	73.00 - 74.60	1645.5 - 1646.5	9.3 - 9.5
6.215 - 6.218	74.80 - 75.20	1660 - 1710	10.6 - 12.7
6.26775 - 6.26825	108.00 - 121.94	1718.8 - 1722.2	13.25 - 13.4
6.31175 - 6.31225	123 - 138	2200 - 2300	14.47 - 14.5
8.291 - 8.294	149.90 - 150.05	2310 - 2390	15.35 - 16.2
8.362 - 8.366	156.52475 - 156.52525	2483.5 - 2500.0	17.7 - 21.4
8.37625 - 8.38675	156.70 - 156.90	2655 - 2900	22.01 - 23.12
8.41425 - 8.41475	162.0125 - 167.1700	3260 - 3267	23.6 - 24.0
12.29 - 12.293	167.72 - 173.20	3332 - 3339	31.2 - 31.8
12.51975 - 12.52025	240 - 285	3345.8 - 3358.0	36.43 - 36.5 ⁽²⁾
12.57675 - 12.57725	322.0 - 335.4	3600 - 4400	
13.36 - 13.41			

¹ Until February 1, 1999, this restricted band shall be 0.490-0.510 MHz.

² Above 38.6

(b) Except as provided in paragraphs (d) and (e), the field strength of emissions appearing within these frequency bands shall not exceed the limits shown in Section 15.209. At frequencies equal to or less than 1000 MHz, compliance with the limits in Section 15.209 shall be demonstrated using measurement instrumentation employing a CISPR quasi-peak detector. Above 1000 MHz, compliance with the emission limits in Section 15.209 shall be demonstrated based on the average value of the measured emissions. The provisions in Section 15.35 apply to these measurements.

3.5 DESCRIPTION OF TEST MODES

Description	Modulation Technology	Modulation Type
26dB Bandwidth and 99% bandwidth	OFDM	BPSK
Maximum conducted output power	OFDM	BPSK
Band edges measurement	OFDM	BPSK
Peak Power Spectral Density	OFDM	BPSK
Radiated undesirable emission	OFDM	BPSK
Powerline conducted emission	OFDM	BPSK

Test Mode	Ant 1	Ant 2	Ant 1+2
802.11a	✓	✓	x
802.11n HT20	✓	✓	✓
802.11n HT40	✓	✓	✓
802.11ac VHT20	✓	✓	x
802.11ac VHT40	✓	✓	x
802.11ac VHT80	✓	✓	x

IEEE 802.11a mode:

Channel (5180MHz),Channel (5200MHz),Channel (5240MHz), Channel (5260MHz), Channel (5300MHz), Channel (5320MHz), Channel (5500MHz), Channel (5540MHz) and Channel (5700MHz) with 6Mbps data rate were chosen for full testing.

IEEE 802.11an HT20 mode:

Channel (5180MHz),Channel (5200MHz),Channel (5240MHz), Channel (5260MHz), Channel (5300MHz), Channel (5320MHz), Channel (5500MHz), Channel (5540MHz) and Channel (5700MHz) with MCS0 data rate were chosen for full testing.

IEEE 802.11an HT40 mode:

Channel (5190MHz),Channel (5230MHz),Channel (5270MHz), Channel (5310MHz), Channel (5510MHz), Channel (5550MHz) and Channel (5670MHz) with MCS0 data rate were chosen for full testing.

IEEE 802.11ac VHT20 mode:

Channel (5180MHz),Channel (5200MHz),Channel (5240MHz), Channel (5260MHz), Channel (5300MHz), Channel (5320MHz), Channel (5500MHz), Channel (5540MHz) and Channel (5700MHz) with MCS0 data rate were chosen for full testing.

IEEE 802.11ac VHT40 mode:

Channel (5190MHz),Channel (5230MHz),Channel (5270MHz), Channel (5310MHz), Channel (5510MHz), Channel (5550MHz) and Channel (5670MHz) with MCS0 data rate were chosen for full testing.

IEEE 802.11ac VHT80 mode:

Channel (5210MHz),Channel (5290MHz) and Channel (5530MHz) with MCS0 data rate were chosen for full testing.

3.6 ANTENNA DESCRIPTION

an intentional radiator antenna shall be designed to ensure that no antenna other than that furnished by the responsible party can be used with the device. The use of a permanently attached or an antenna that uses a unique coupling to the intentional radiator shall be considered sufficient to comply with the provisions of this section”

* the antenna of this EUT is a unique(PCB Antenna for 5G WiFi).

* the EUT complies with the requirement of 15.203.

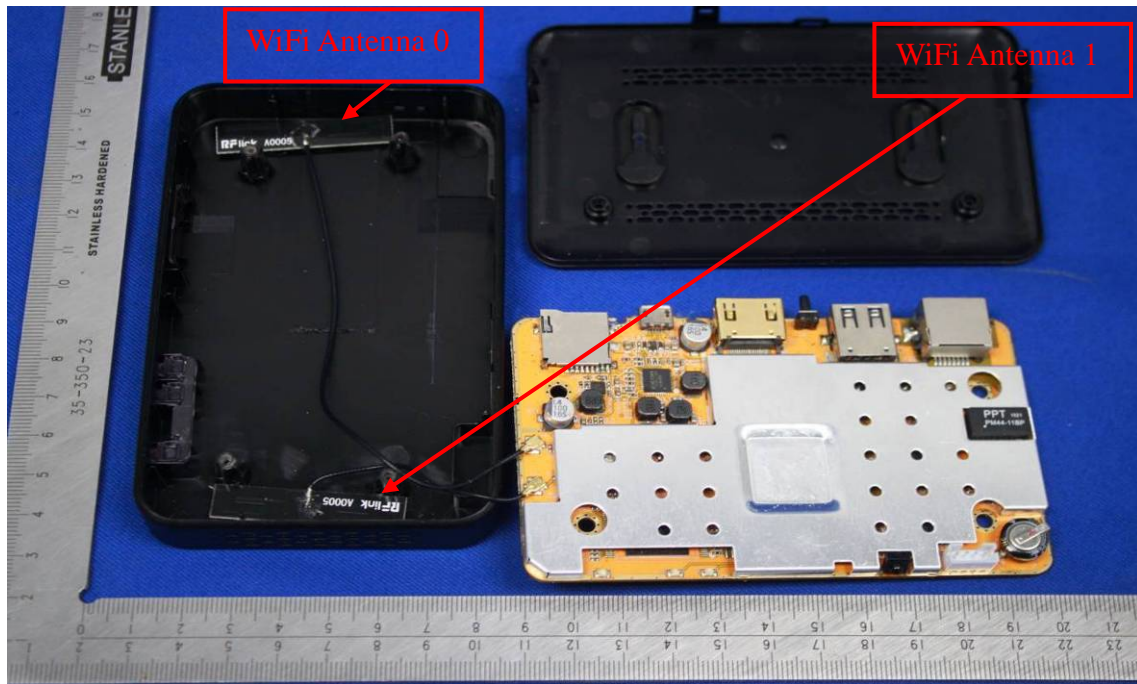

4 INSTRUMENT CALIBRATION

The measuring equipment, which was utilized in performing the tests documented herein, has been calibrated in accordance with the manufacturer's recommendations for utilizing calibration equipment, which is traceable to recognized national standards.

4.1 MEASUREMENT EQUIPMENT USED

Conducted Emissions Test Site					
Name of Equipment	Manufacturer	Model	Serial Number	Calibration Date	Calibration Due
Spectrum Analyzer	Agilent	E4446A	MY44020154	2015-9-11	2016-9-10
Spectrum Analyzer	RS	FSU26	200789	2015-8-10	2016-8-9
OSCILLOSCOPE	Agilent	DSO6104A	MY44002585	2016-3-2	2017-3-1
Power meter	Anritsu	ML2495A	1445010	2016-04-23	2017-04-22
Power sensor	Anritsu	MA2411B	1339220	2016-04-23	2017-04-22
Power SPLITTER	Mini-Circuits	ZN2PD-9G	SF078500430	N.C.R	N.C.R
DC Power Supply	AGILENT	E3632A	MY50340053	N.C.R	N.C.R
Temp. / Humidity Chamber	TERCHY	MHK-120AK	X30109	2016-1-11	2017-1-10
Power SPLITTER	Mini-Circuits	ZN2PD-9G	SF078500430	N.C.R	N.C.R
Temp. / Humidity Chamber	Kingson	THS-M1	242	2016-1-21	2017-1-20

977 Chamber					
Name of Equipment	Manufacturer	Model	Serial Number	Calibration Date	Calibration Due
Spectrum Analyzer	Agilent	E4446A	MY44020154	2015-9-11	2016-9-10
Spectrum Analyzer	RS	FSU26	200789	2015-8-10	2016-8-9
EMI Test Receiver	R&S	ESCI	101378	2016-1-6	2017-1-5
Pre-Amplifier	MINI	ZFL-1000VH2	070306	2016-1-13	2017-1-12
Pre-Amplifier	Miteq	JS41-00101800-32-10P	1675713	2015-8-10	2016-8-9
Bilog Antenna	Sunol	JB1	A062604	2016-3-6	2017-3-5
Bilog Antenna	Sunol	JB1	A110204-1	2016-3-6	2017-3-5
Loop Antenna	SCHWARZBECK	HXYZ9170	9170-108	2016-4-7	2017-4-6
Horn-antenna	SCHWARZBECK	9120D	D:266	2016-3-7	2017-3-6
Horn-antenna	SCHWARZBECK	9120D	D:267	2015-11-10	2016-11-9
Turn Table	CT	CT123	4165	N.C.R	N.C.R
Antenna Tower	CT	CTERG23	3256	N.C.R	N.C.R
Controller	CT	CT100	95637	N.C.R	N.C.R
Test Software			EZ-EMC		

Conducted Emission					
Name of Equipment	Manufacturer	Model	Serial Number	Calibration Date	Calibration Due
EMI TEST RECEIVER	R&S	ESCI	100781	2016-3-2	2017-3-1
V (V-LISN)	SCHWARZBECK	NNLK 8129	8129-143	2015-11-2	2016-11-1
LISN (EUT)	FCC	FCC-LISN-50/250-50-2-02	05012	2015-9-16	2016-9-15
Pulse LIMITER	R&S	ESH3-Z2	100524	2016-1-6	2017-1-5
Test Software	EZ-EMC				

Remark: Each piece of equipment is scheduled for calibration once a year.

4.2 MEASUREMENT UNCERTAINTY

For the test methods, according to the present document, the measurement uncertainty figures shall be calculated in accordance with TR 100 028-1 [2] and shall correspond to an expansion factor (coverage factor) $k = 1,96$ or $k = 2$ (which provide confidence levels of respectively 95 % and 95,45 % in the case where the distributions characterizing the actual measurement uncertainties are normal (Gaussian)).

Table 6 is based on such expansion factors.

Table 6: Maximum measurement uncertainty

Parameter	<u>UNCERTAINTY</u>
Radio frequency	$\pm 0.8 \times 10^{-7}$
RF power, conducted	0.2054
Maximum frequency deviation:	
-within 300 Hz and 6 kHz of audio frequency	1.3%
-within 6 kHz and 25 kHz of audio frequency	0.65 dB
Adjacent channel power	0.2054
Conducted spurious emission of transmitter, valid up to 6 GHz	0.2892
Conducted emission of receivers	+1.2/-1.1 dB
Radiated emission of transmitter, valid up to 6 GHz	± 3.94 dB
Radiated emission of receiver, valid up to 6 GHz	± 3.94 dB
RF level uncertainty for a given BER	± 0.3 dB
Temperature	0.1979
Humidity	± 1 %

5 FACILITIES AND ACCREDITATIONS

5.1 FACILITIES

All measurement facilities used to collect the measurement data are located at

No.10Weiye Rd., Innovation park, Eco&Tec, Development Zone, Kunshan City, Jiangsu, China.

The sites are constructed in conformance with the requirements of ANSI C63.10:2013 and CISPR Publication 22. All receiving equipment conforms to CISPR Publication 16-1, "Radio Interference Measuring Apparatus and Measurement Methods."

5.2 EQUIPMENT

Radiated emissions are measured with one or more of the following types of linearly polarized antennas: tuned dipole, biconical, log periodic, bi-log, and/or ridged waveguide, horn. Spectrum analyzers with preselectors and quasi-peak detectors are used to perform radiated measurements.

Conducted emissions are measured with Line Impedance Stabilization Networks and EMI Test Receivers.



Calibrated wideband preamplifiers, coaxial cables, and coaxial attenuators are also used for making measurements.

All receiving equipment conforms to CISPR Publication 16-1, "Radio Interference Measuring Apparatus and Measurement Methods."

5.3 TABLE OF ACCREDITATIONS AND LISTINGS

The test facilities used to perform radiated and conducted emissions tests are accredited by American Association for Laboratory Accreditation Program for the specific scope accreditation under Lab Code: 200581-0 to perform Electromagnetic Interference tests according to FCC Part 15 and CISPR 22 requirements. In addition, the test facilities are listed with Industry Canada, Certification and Engineering Bureau, 2324E-1 for 10m chamber 10m, 2324E-2 for 10m chamber 3m; the test facilities are listed with USA, Certification and Engineering Bureau, 424105 for 10m chamber 10m, 238958 for 10m chamber 3m.

5.4 TABLE OF ACCREDITATIONS AND LISTINGS

Country	Agency	Scope of Accreditation	Logo
USA	A2LA	47 CFR FCC Part 15/18 (using ANSI C63.10 :2013); VCCI V3; CNS 13438; CNS 13439; CNS 13803; CISPR 11; EN 55011; CISPR 13; EN 55013; CISPR 22:2005; CISPR 22:1997 +A1 :2000+A2 :2002; EN 55022:2006; EN55022 :1998 +A1 :2001+A2 :2003; EN 61000-6-3 (excluding discontinuous interference); EN 61000-6-4; AS/NZS CISPR 22; CAN/CSA-CEI/IEC CISPR 22; EN 61000-3-2; EN 61000-3-3; EN550024; EN 61000-4-2; EN 61000-4-3; EN61000-4-4; EN 61000-4-5; EN 61000-4-6; IEC 61000-4-8; EN 61000-4-11; IEC61000-3-2; IEC61000-3-3; IEC 61000-4-2; IEC 61000-4-3; IEC 61000-4-4; IEC 61000-4-5; IEC 61000-4-6; IEC 61000-4-8; IEC 61000-4-11; EN 300 220-3; EN 300 328; EN 300 330-2; EN 300 440-1; EN 300-440-2; EN 300 893; EN 301 489-01; EN 301 489-3; EN 301 489-07; EN 301 489-17; 47 CFR FCC Part 15, 22, 24	
USA	FCC	3/10 meter Sites to perform FCC Part 15/18 measurements	 93105, 90471
Japan	VCCI	3/10 meter Sites and conducted test sites to perform radiated/conducted measurements	VCCI R-1600 C-1707 G-216

** No part of this report may be used to claim or imply product endorsement by A2LA or any agency of the US Government.*

6 SETUP OF EQUIPMENT UNDER TEST

6.1 SETUP CONFIGURATION OF EUT

See test photographs attached in Appendix 1 for the actual connections between EUT and support equipment.

6.2 SUPPORT EQUIPMENT

No.	Equipment	Model No.	Serial No.
1	N/A		

Remark:

1. All the equipment/cables were placed in the worst-case configuration to maximize the emission during the test.
2. Grounding was established in accordance with the manufacturer's requirements and conditions for the intended use.

7 FCC PART 15 REQUIREMENTS

7.1 26 DB EMISSION BANDWIDTH

LIMIT

According to §15.303(c), for purposes of this subpart the emission bandwidth shall be determined by measuring the width of the signal between two points, one below the carrier center frequency and one above the carrier center frequency, that are 26 dB down relative to the maximum level of the modulated carrier. Compliance with the emissions limits is based on the use of measurement instrumentation employing a peak detector function with an instrument resolutions bandwidth approximately equal to 1.0 percent of the emission bandwidth of the device under measurement.

Test Configuration

TEST PROCEDURE

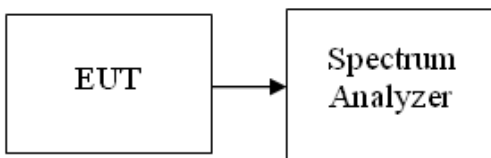

1. Place the EUT on the table and set it in the transmitting mode.
2. Remove the antenna from the EUT and then connect a low-loss RF cable from the antenna port to the spectrum analyzer.
3. Set the spectrum analyzer as RBW = approximately 1% of the emission bandwidth, VBW > RBW, Detector = Peak, Span >26dB bandwidth, and Sweep = auto, Trace mode = max hold.
4. Measure the maximum width of the emission that is 26 dB down from the maximum of the emission. Compare this with the RBW setting of the analyzer. Readjust RBW and repeat measurement as needed until the RBW/EBW ratio is approximately 1%..
5. Repeat until all the rest channels were investigated.

TEST RESULTS

No non-compliance noted

Test Data

Test mode: IEEE 802.11a mode/chain 0

5150~5250MHz

Channel	Frequency (MHz)	Bandwidth (B) (MHz)
Low	5180	22.115
Mid	5200	22.090
High	5240	22.115

5250~5350MHz

Channel	Frequency (MHz)	Bandwidth (B) (MHz)
Low	5260	22.035
Mid	5300	22.035
High	5320	22.035

5470~5725MHz

Channel	Frequency (MHz)	Bandwidth (B) (MHz)
Low	5500	21.955
Mid	5540	21.875
High	5700	21.795

Test mode: IEEE 802.11a mode/chain 1

5150~5250MHz

Channel	Frequency (MHz)	Bandwidth (B) (MHz)
Low	5180	22.035
Mid	5200	22.147
High	5240	21.955

5250~5350MHz

Channel	Frequency (MHz)	Bandwidth (B) (MHz)
Low	5260	22.035
Mid	5300	21.875
High	5320	22.035

5470~5725MHz

Channel	Frequency (MHz)	Bandwidth (B) (MHz)
Low	5500	21.971
Mid	5540	22.035
High	5700	21.955

Test mode: IEEE 802.11n HT20MHz mode / Chain 0

5150~5250MHz

Channel	Frequency (MHz)	Bandwidth (B) (MHz)
Low	5180	22.388
Mid	5200	22.59
High	5240	22.196

5250~5350MHz

Channel	Frequency (MHz)	Bandwidth (B) (MHz)
Low	5260	22.356
Mid	5300	22.548
High	5320	22.516

5470~5725MHz

Channel	Frequency (MHz)	Bandwidth (B) (MHz)
Low	5500	22.356
Mid	5540	22.356
High	5700	22.196

Test mode: IEEE 802.11n HT20MHz mode / Chain 1

5150~5250MHz

Channel	Frequency (MHz)	Bandwidth (B) (MHz)
Low	5180	22.276
Mid	5200	22.388
High	5240	22.276

5250~5350MHz

Channel	Frequency (MHz)	Bandwidth (B) (MHz)
Low	5260	22.196
Mid	5300	22.147
High	5320	22.115

5470~5725MHz

Channel	Frequency (MHz)	Bandwidth (B) (MHz)
Low	5500	22.276
Mid	5540	22.196
High	5700	22.115

Test mode: IEEE 802.11n HT40MHz mode / Chain 0

5150~5250MHz

Channel	Frequency (MHz)	Bandwidth (B) (MHz)
Low	5190	41.538
High	5230	40.256

5250~5350MHz

Channel	Frequency (MHz)	Bandwidth (B) (MHz)
Low	5270	40.385
High	5310	40.385

5470~5725MHz

Channel	Frequency (MHz)	Bandwidth (B) (MHz)
Low	5510	40.641
Mid	5550	40.641
High	5670	40.256

Test mode: IEEE 802.11n HT40MHz mode / Chain 1

5150~5250MHz

Channel	Frequency (MHz)	Bandwidth (B) (MHz)
Low	5190	40.385
High	5230	40.385

5250~5350MHz

Channel	Frequency (MHz)	Bandwidth (B) (MHz)
Low	5270	40.144
High	5310	40.128

5470~5725MHz

Channel	Frequency (MHz)	Bandwidth (B) (MHz)
Low	5510	40.385
Mid	5550	40.513
High	5670	40.256

Test mode: IEEE 802.11ac HT20MHz mode / Chain 0

5150~5250MHz

Channel	Frequency (MHz)	Bandwidth (B) (MHz)
Low	5180	22.308
Mid	5200	22.468
High	5240	22.676

5250~5350MHz

Channel	Frequency (MHz)	Bandwidth (B) (MHz)
Low	5260	22.356
Mid	5300	22.516
High	5320	22.077

5470~5725MHz

Channel	Frequency (MHz)	Bandwidth (B) (MHz)
Low	5500	22.196
Mid	5540	22.356
High	5700	22.035

Test mode: IEEE 802.11ac HT20MHz mode / Chain 1

5150~5250MHz

Channel	Frequency (MHz)	Bandwidth (B) (MHz)
Low	5180	22.244
Mid	5200	22.388
High	5240	22.436

5250~5350MHz

Channel	Frequency (MHz)	Bandwidth (B) (MHz)
Low	5260	22.276
Mid	5300	22.388
High	5320	22.997

5470~5725MHz

Channel	Frequency (MHz)	Bandwidth (B) (MHz)
Low	5500	22.196
Mid	5540	22.276
High	5700	22.356

Test mode: IEEE 802.11ac HT40MHz mode / Chain 0

5150~5250MHz

Channel	Frequency (MHz)	Bandwidth (B) (MHz)
Low	5190	40.769
High	5230	40.513

5250~5350MHz

Channel	Frequency (MHz)	Bandwidth (B) (MHz)
Low	5270	40.385
High	5310	40.641

5470~5725MHz

Channel	Frequency (MHz)	Bandwidth (B) (MHz)
Low	5510	40.385
Mid	5550	40.385
High	5670	40.128

Test mode: IEEE 802.11ac HT40MHz mode / Chain 1

5150~5250MHz

Channel	Frequency (MHz)	Bandwidth (B) (MHz)
Low	5190	40.256
High	5230	40.256

5250~5350MHz

Channel	Frequency (MHz)	Bandwidth (B) (MHz)
Low	5270	40.256
High	5310	40.256

5470~5725MHz

Channel	Frequency (MHz)	Bandwidth (B) (MHz)
Low	5510	40.128
Mid	5550	40.385
High	5670	40.256

Test mode: IEEE 802.11ac HT80MHz mode / Chain 0

5150~5250MHz

Channel	Frequency (MHz)	Bandwidth (B) (MHz)
Mid	5210	83.462

5250~5350MHz

Channel	Frequency (MHz)	Bandwidth (B) (MHz)
Mid	5290	83.077

5470~5725MHz

Channel	Frequency (MHz)	Bandwidth (B) (MHz)
Mid	5530	83.077

Test mode: IEEE 802.11ac HT80MHz mode / Chain 1

5150~5250MHz

Channel	Frequency (MHz)	Bandwidth (B) (MHz)
Mid	5210	83.077

5250~5350MHz

Channel	Frequency (MHz)	Bandwidth (B) (MHz)
Mid	5290	83.269

5470~5725MHz

Channel	Frequency (MHz)	Bandwidth (B) (MHz)
Mid	5530	82.885

Test Plot

IEEE 802.11a mode/chain 0:

5150~5250MHz

CH Low

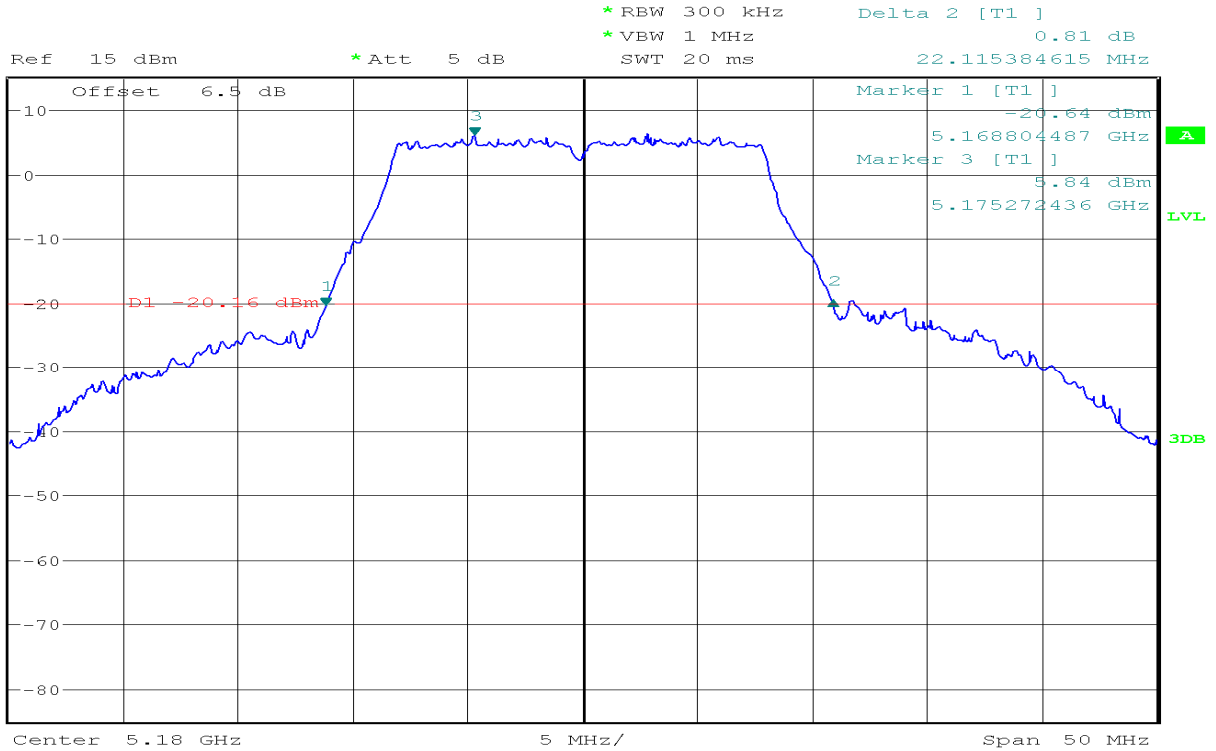

CH Mid

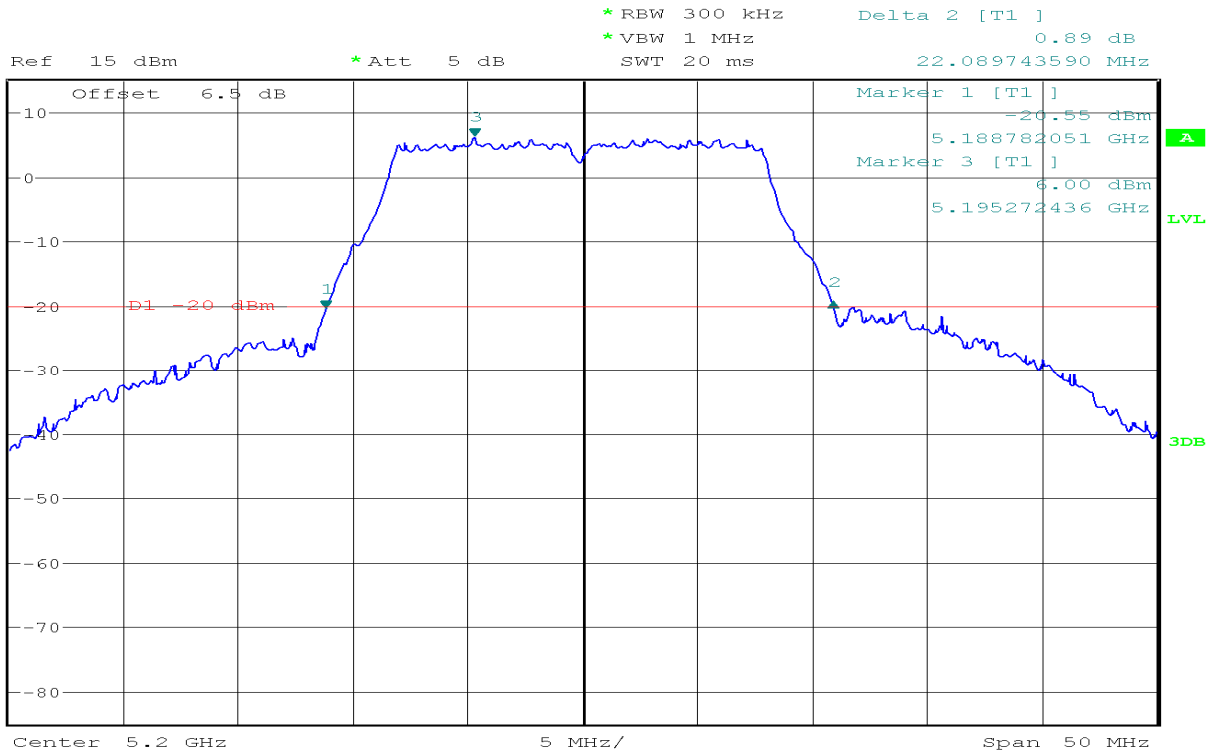

CH High

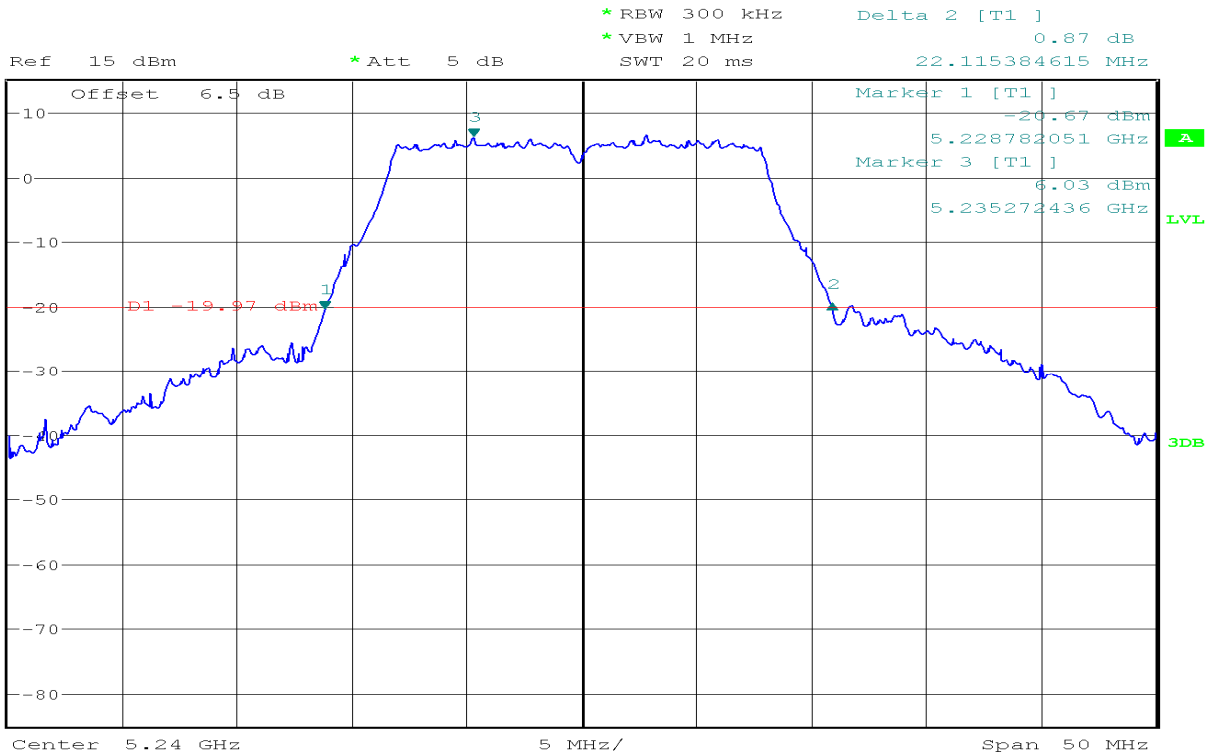

5250~5350MHz

CH Low

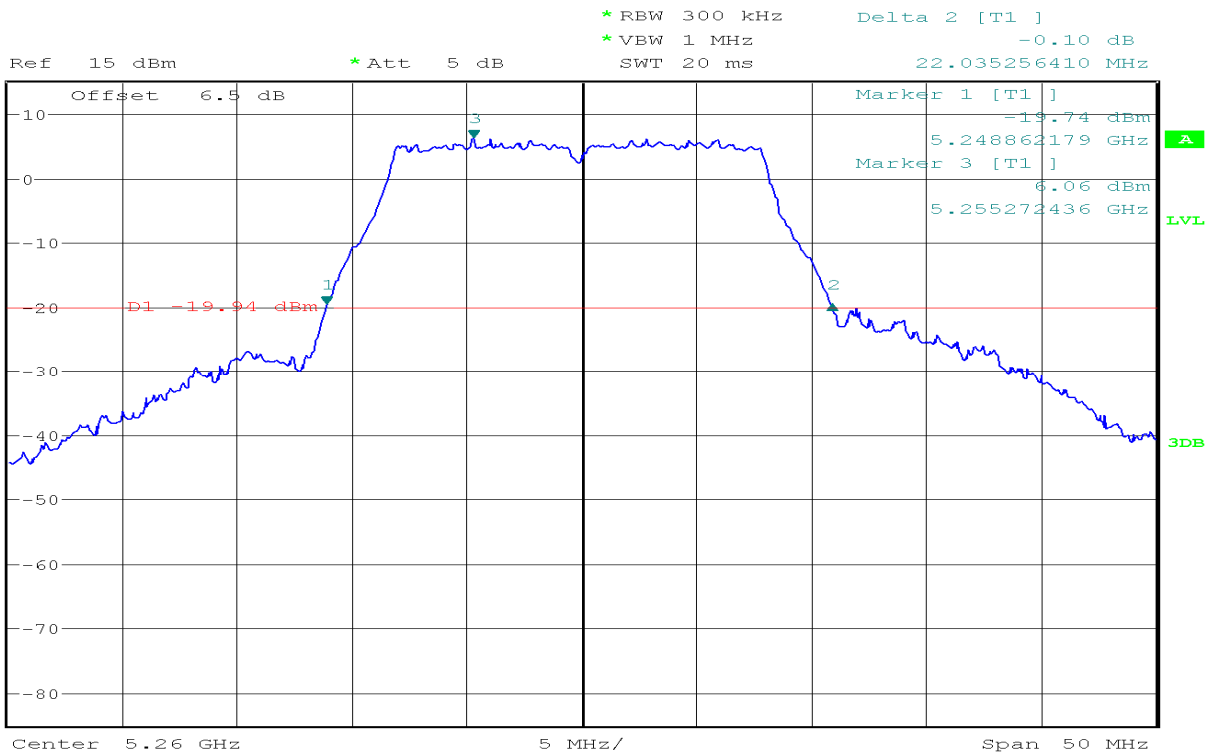

CH Mid

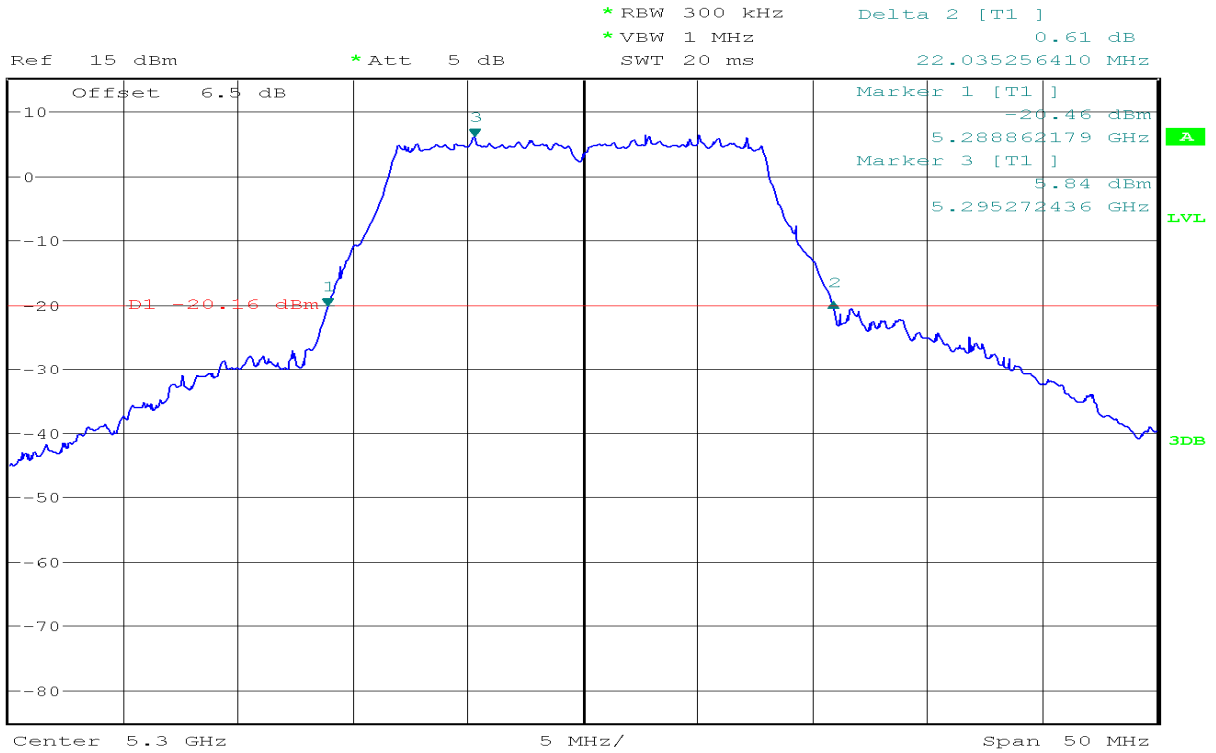

CH High

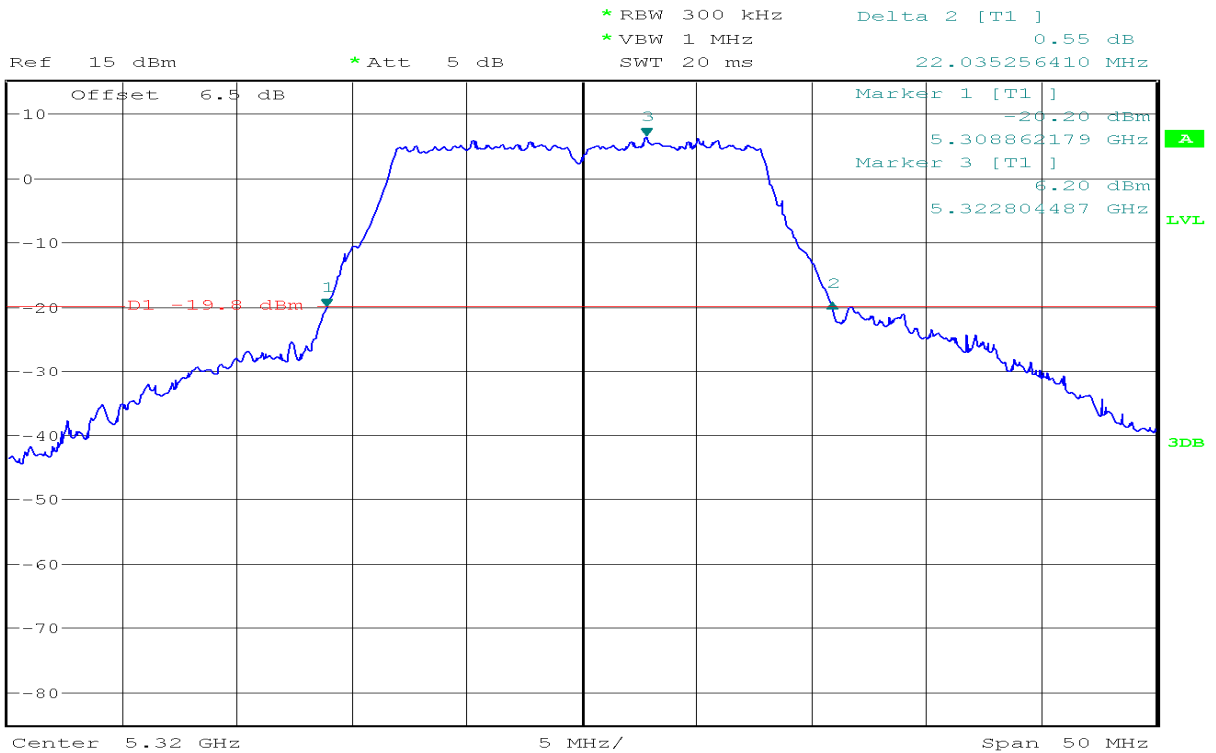

5470~5725MHz

CH Low

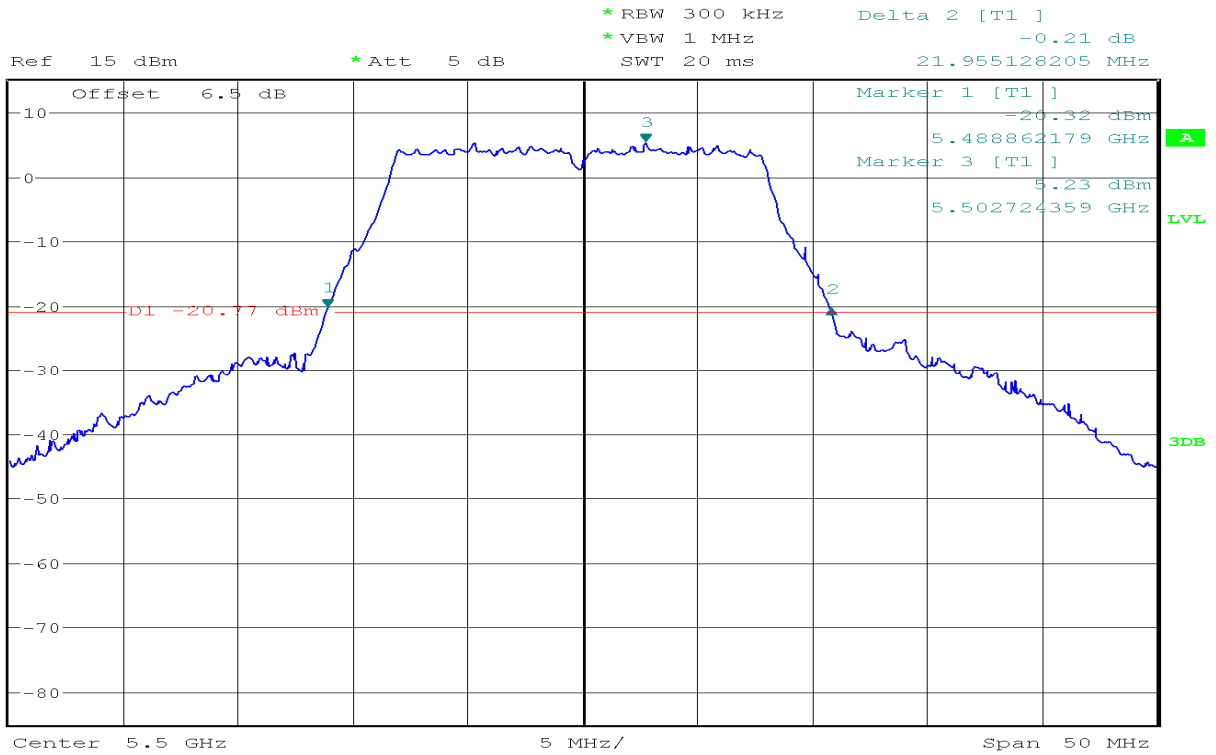

CH Mid

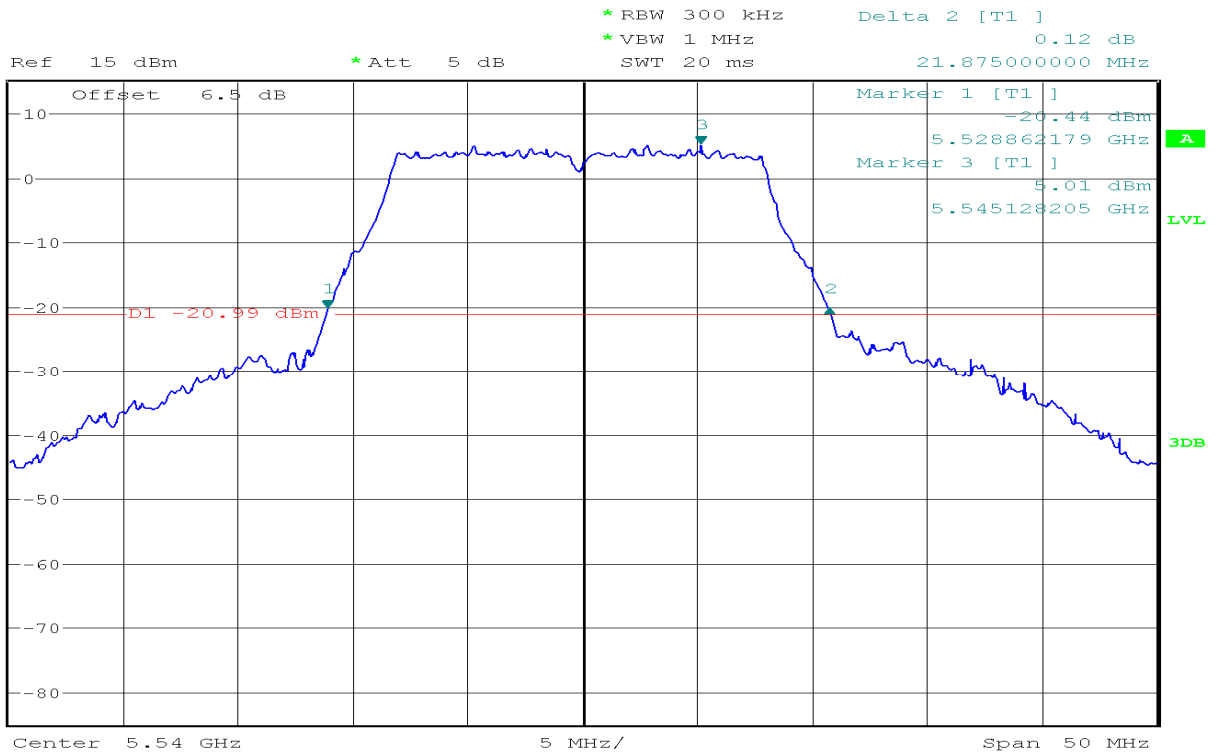

CH High

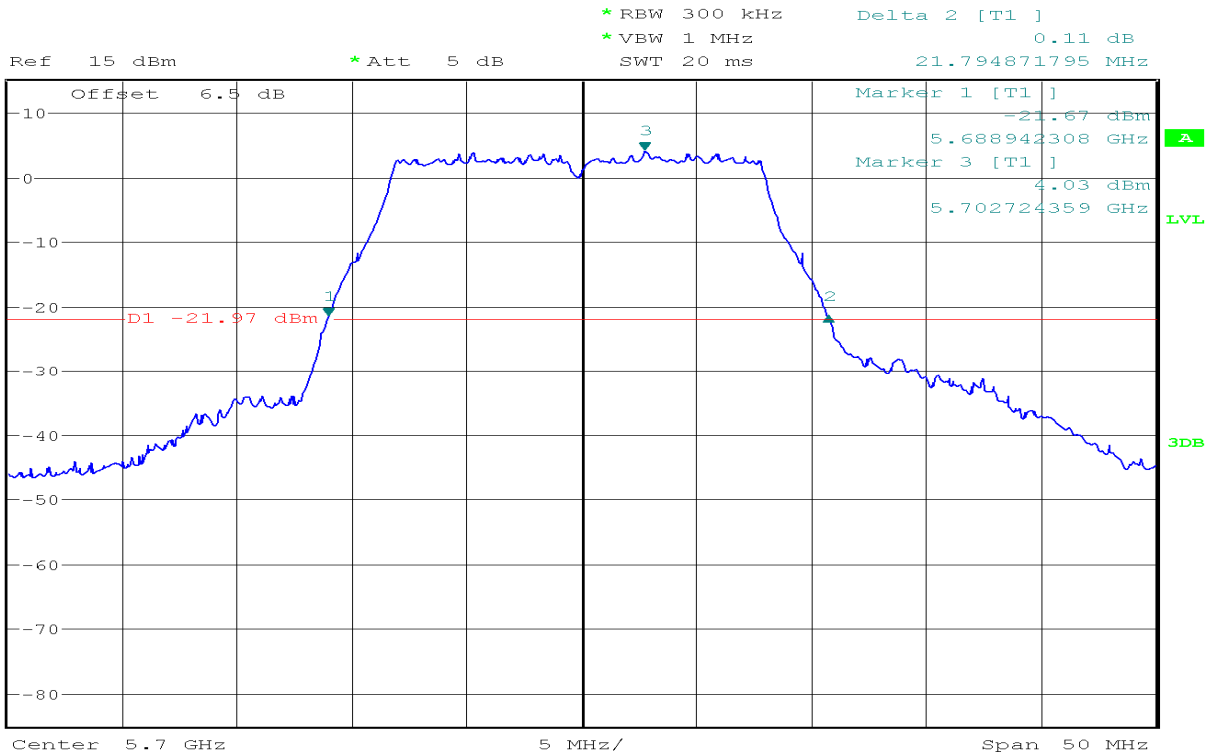

IEEE 802.11a mode/chain 1:

5150~5250MHz

CH Low

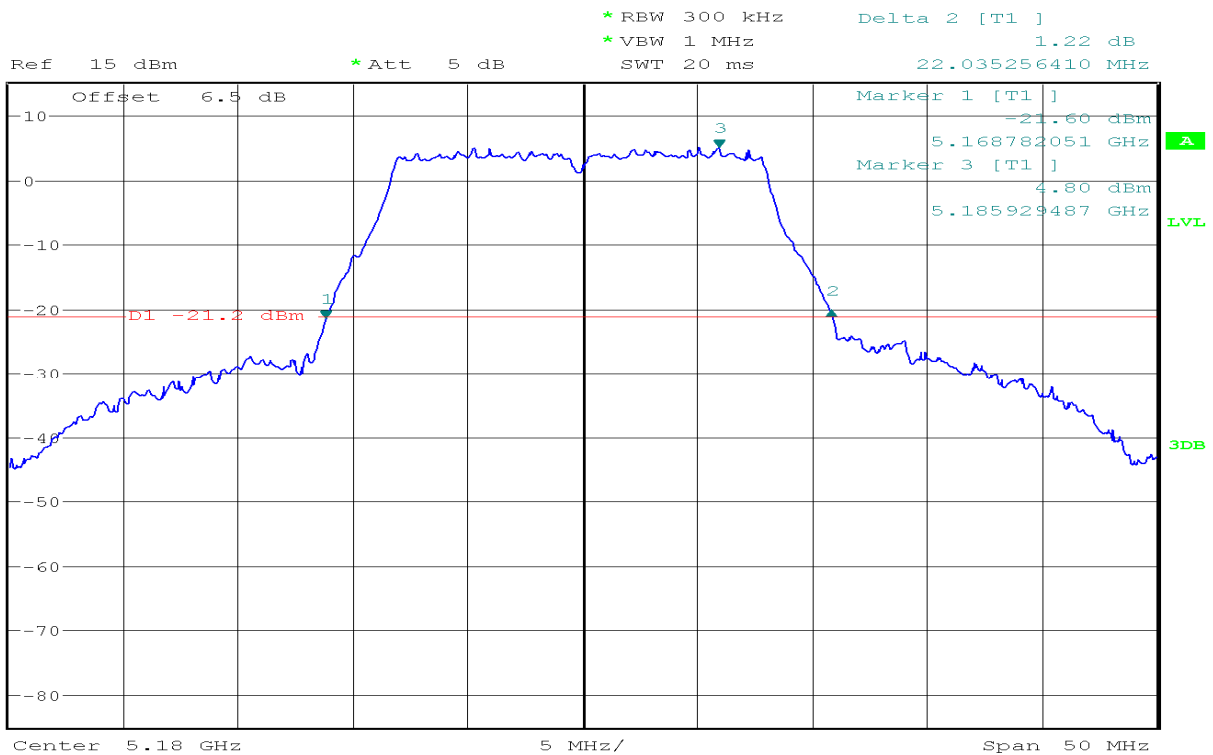

5250~5350MHz

CH Low



Ref 15 dBm * Att 5 dB * RBW 300 kHz Delta 2 [T1] 0.09 dB
 * VBW 1 MHz 22.035256410 MHz
 SWT 20 ms

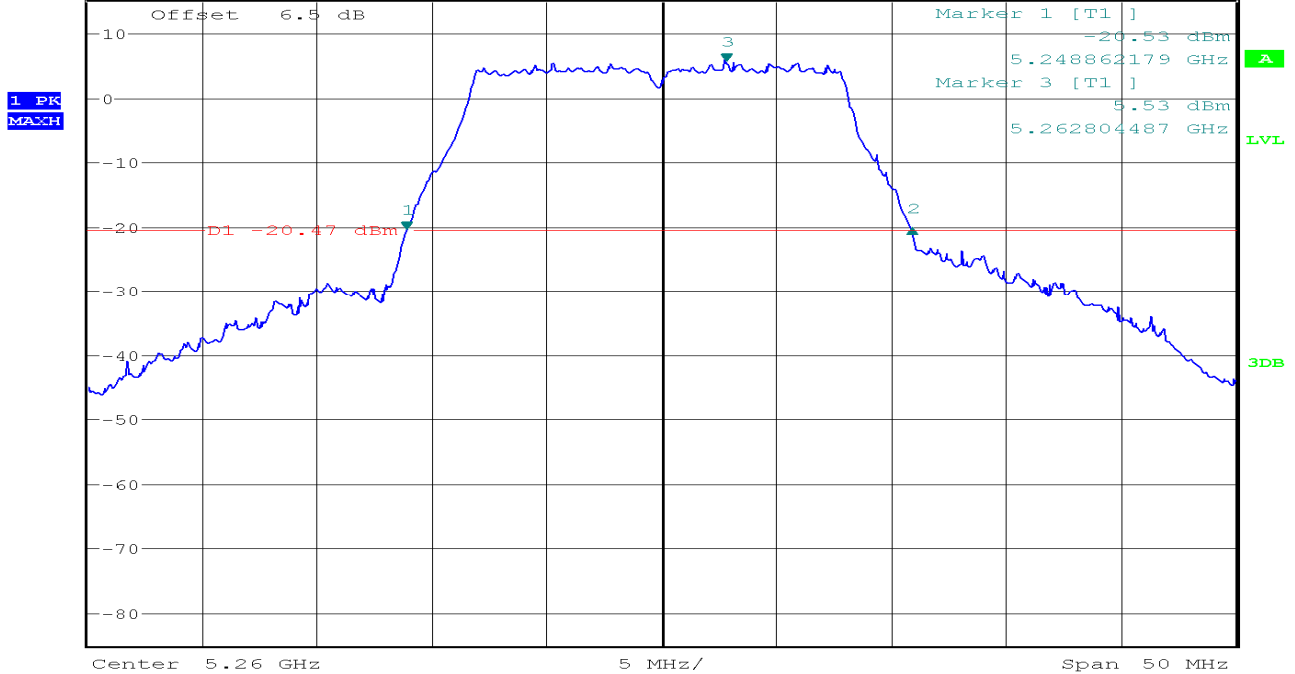

CH Mid



Ref 15 dBm * Att 5 dB * RBW 300 kHz Delta 2 [T1] 0.14 dB
 * VBW 1 MHz 21.875000000 MHz
 SWT 20 ms

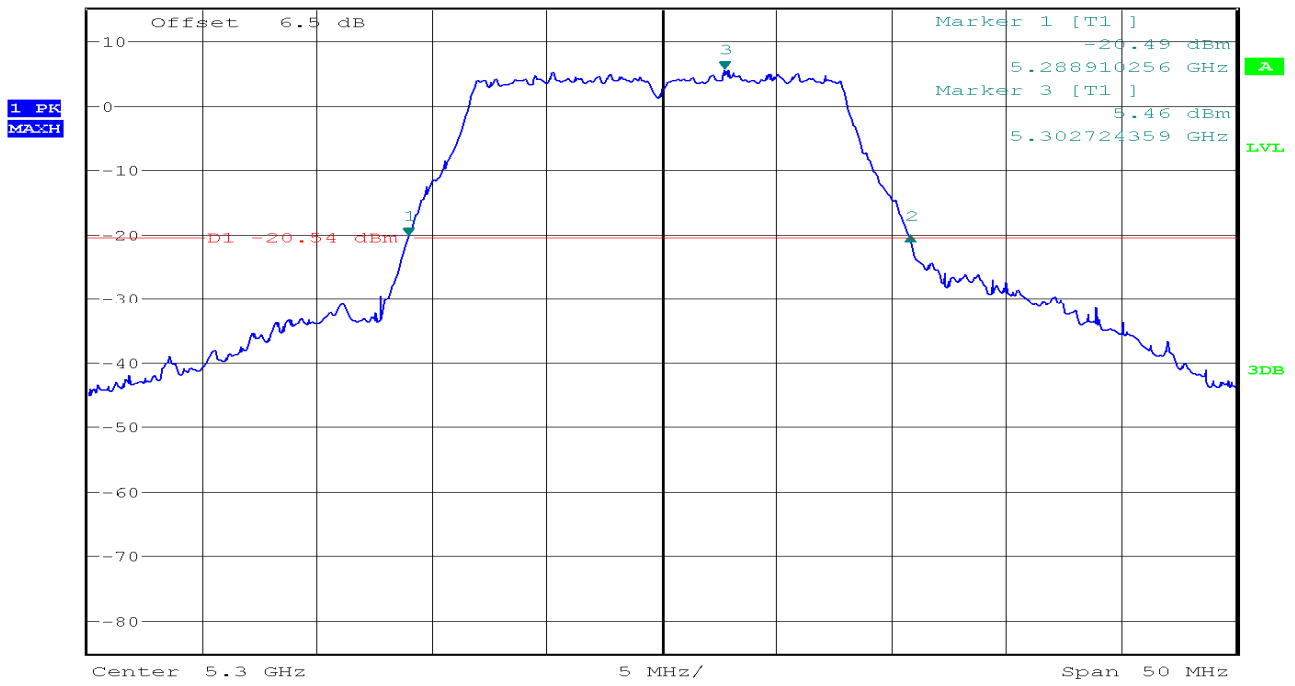

CH High



Ref 15 dBm * Att 5 dB * RBW 300 kHz Delta 2 [T1] 0.54 dB
 * VBW 1 MHz 22.035256410 MHz
 SWT 20 ms

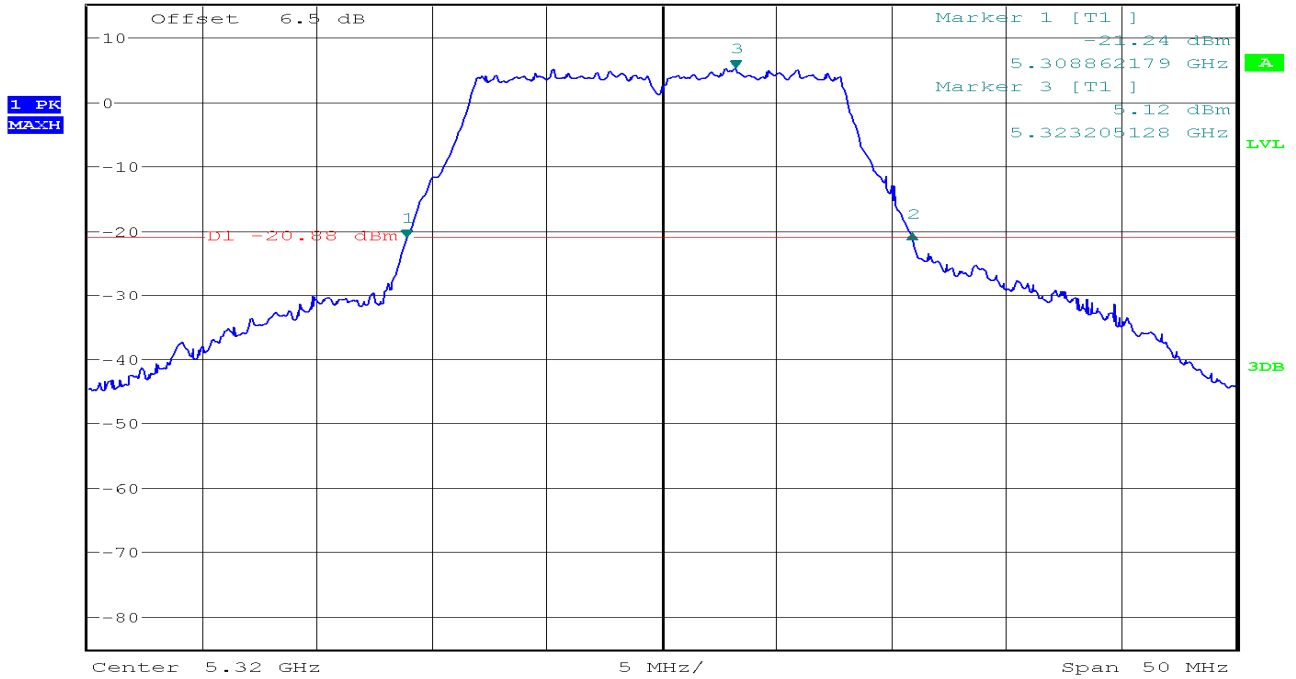

5470~5725MHz

CH Low



Ref 15 dBm * Att 5 dB * RBW 300 kHz Delta 2 [T1] -0.16 dB
 * VBW 1 MHz 21.971153846 MHz
 SWT 20 ms

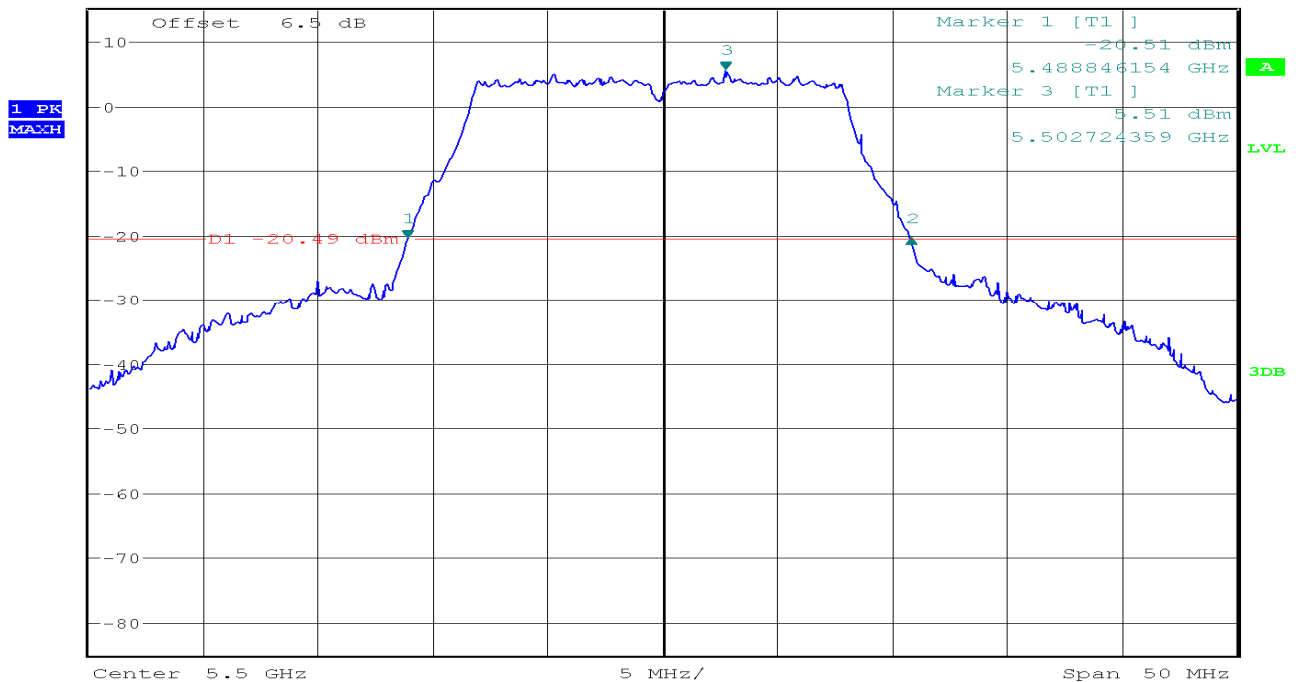

CH Mid

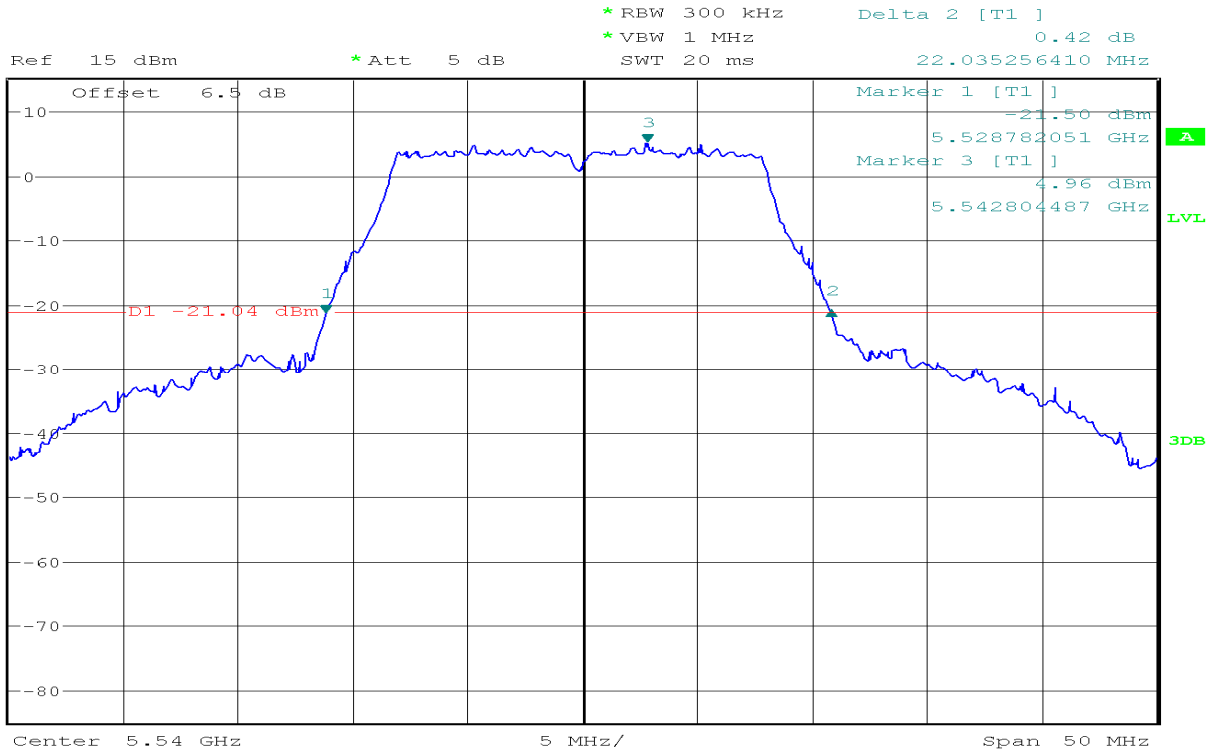

CH High

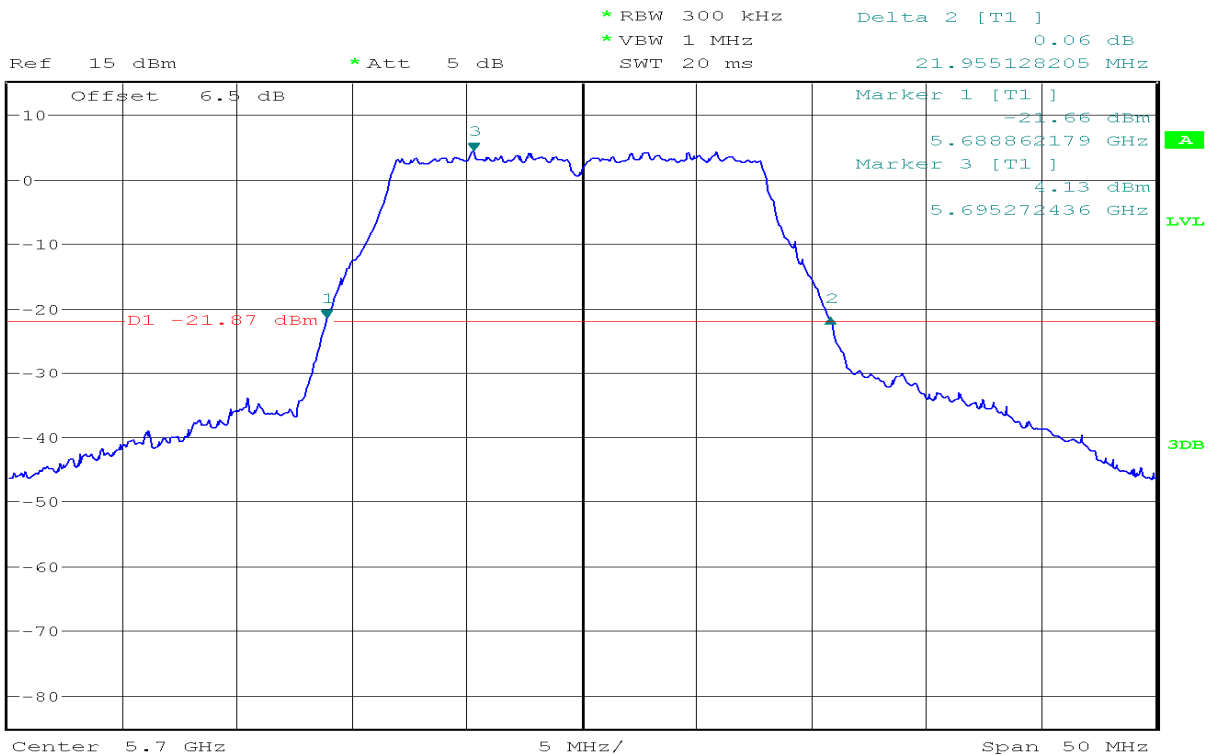

IEEE 802.11n HT20 mode / Chain 0
5150~5250MHz

CH Low

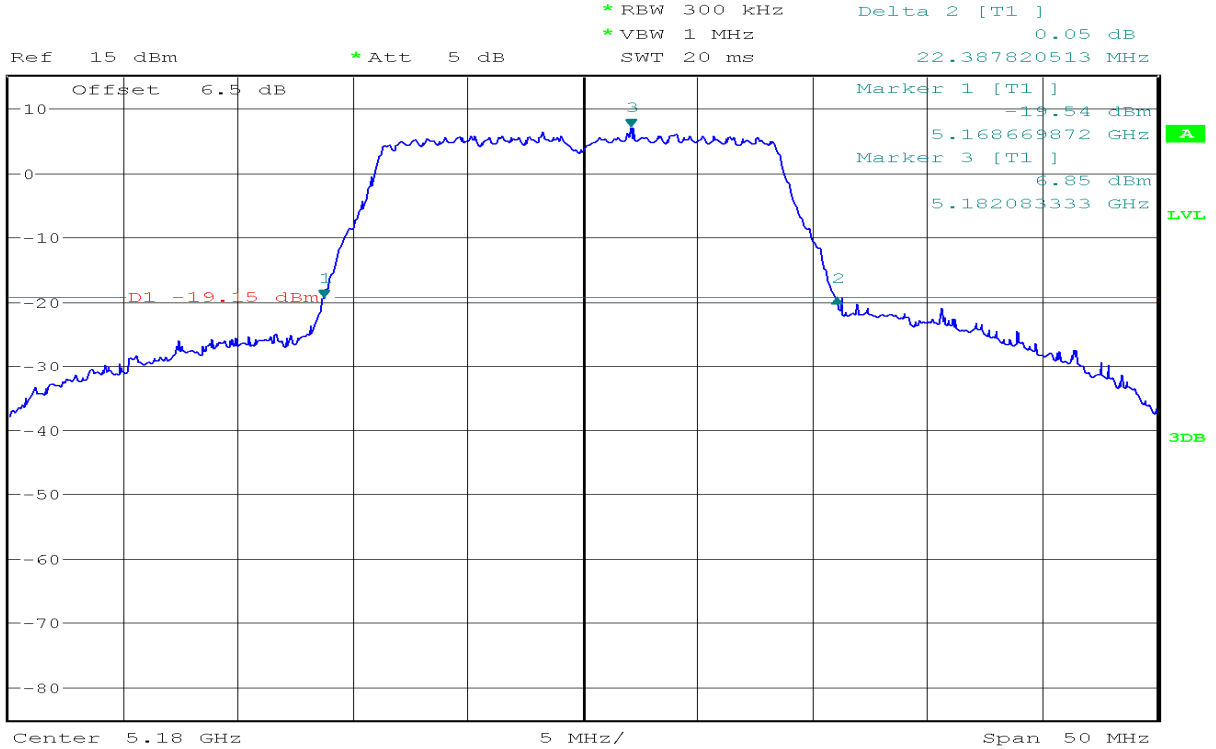

CH Mid

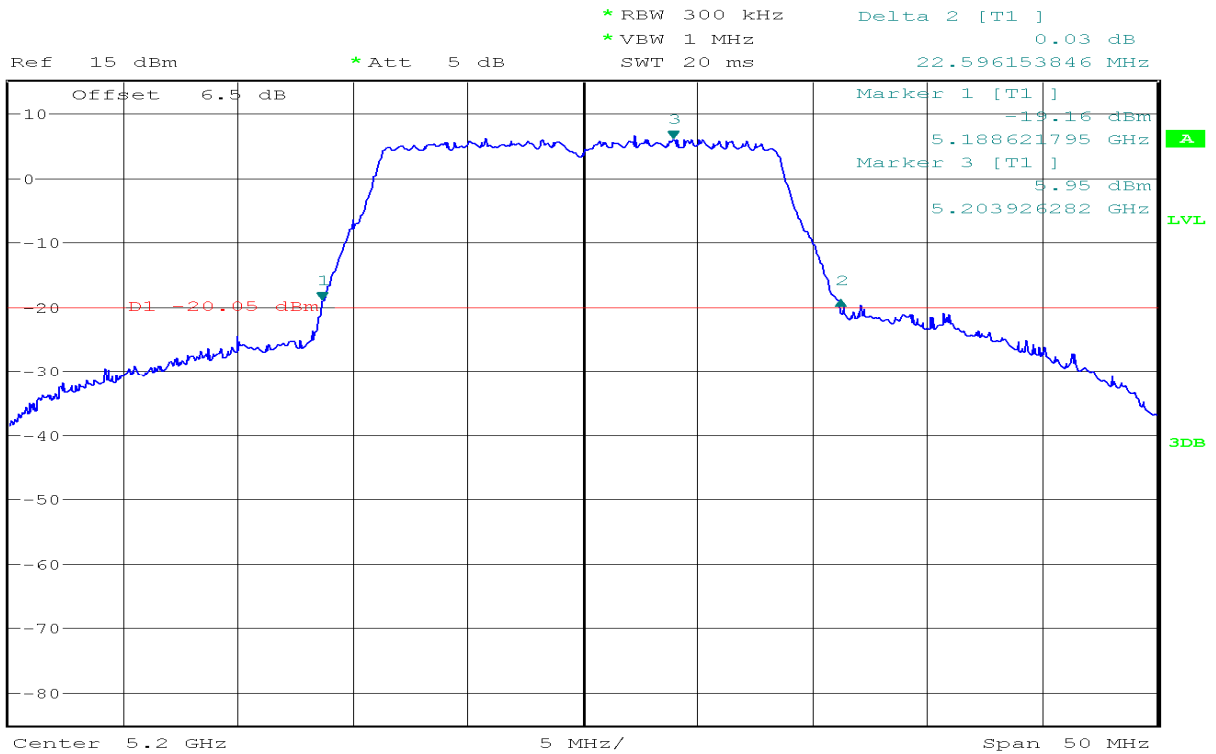

CH High

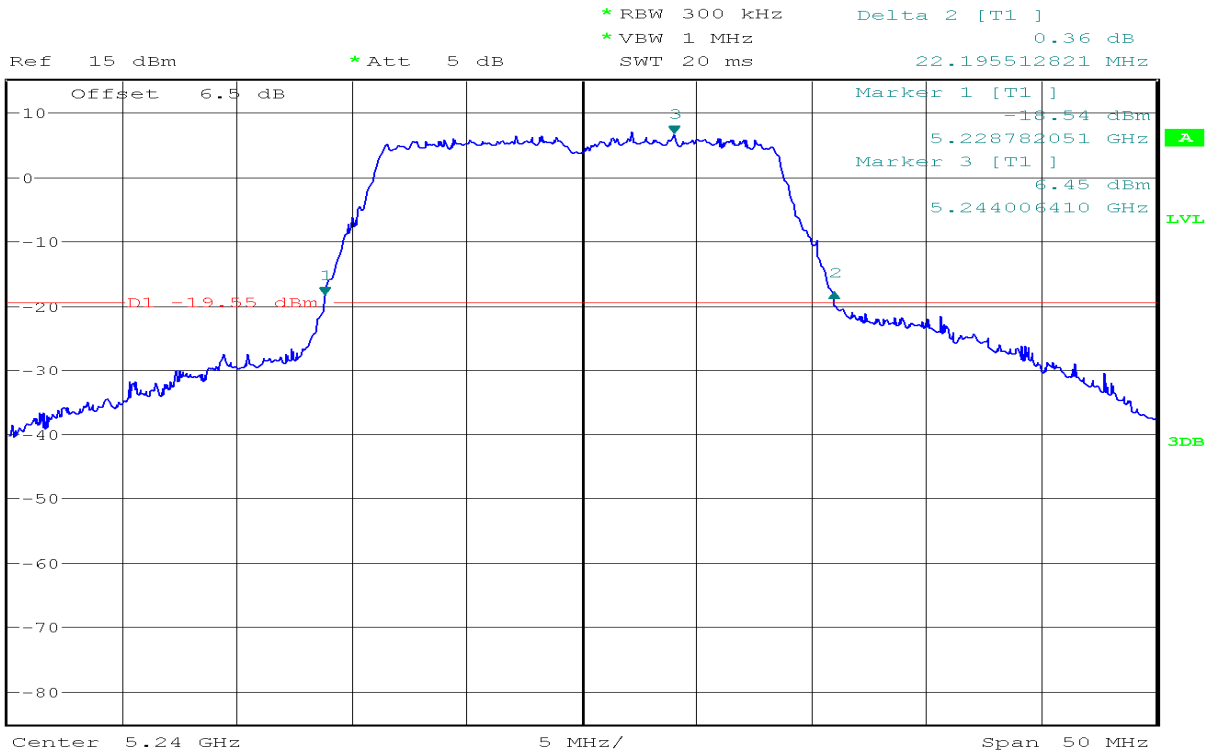

5250~5350MHz

CH Low

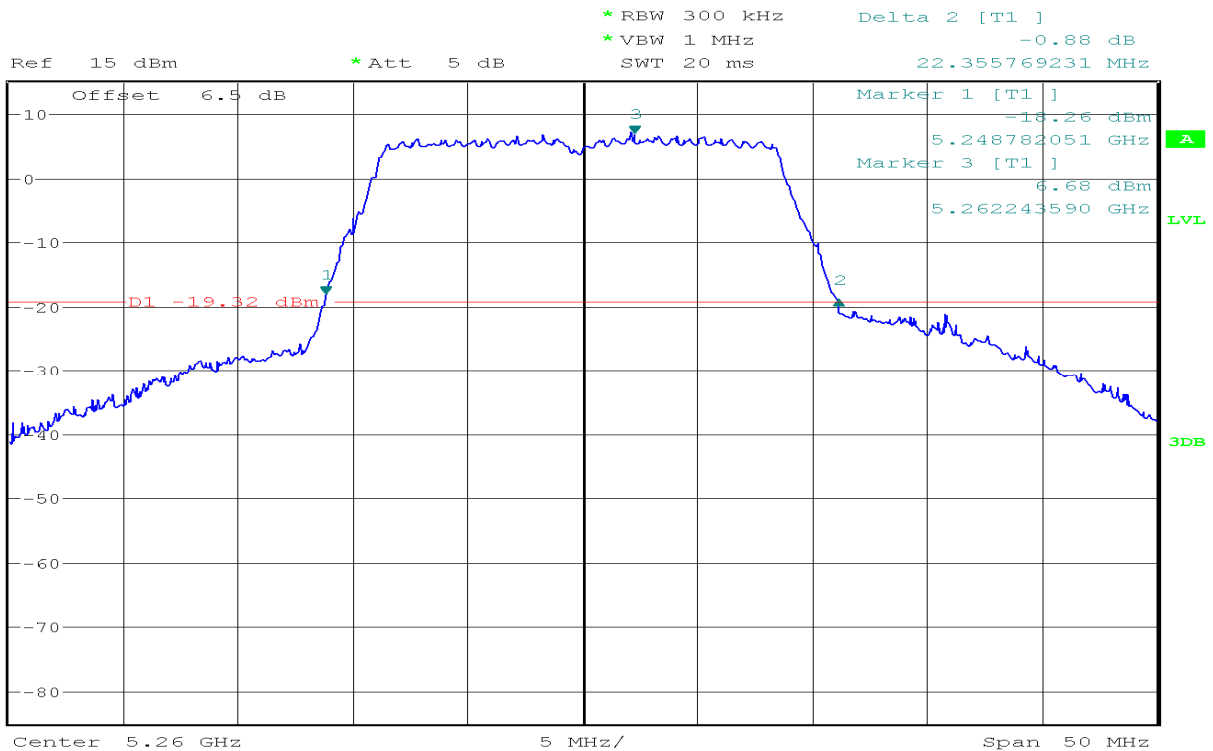

5470~5725MHz

CH Low



Ref 15 dBm *Att 5 dB *RBW 300 kHz Delta 2 [T1] -0.15 dB
 *VBW 1 MHz SWT 20 ms 22.355769231 MHz

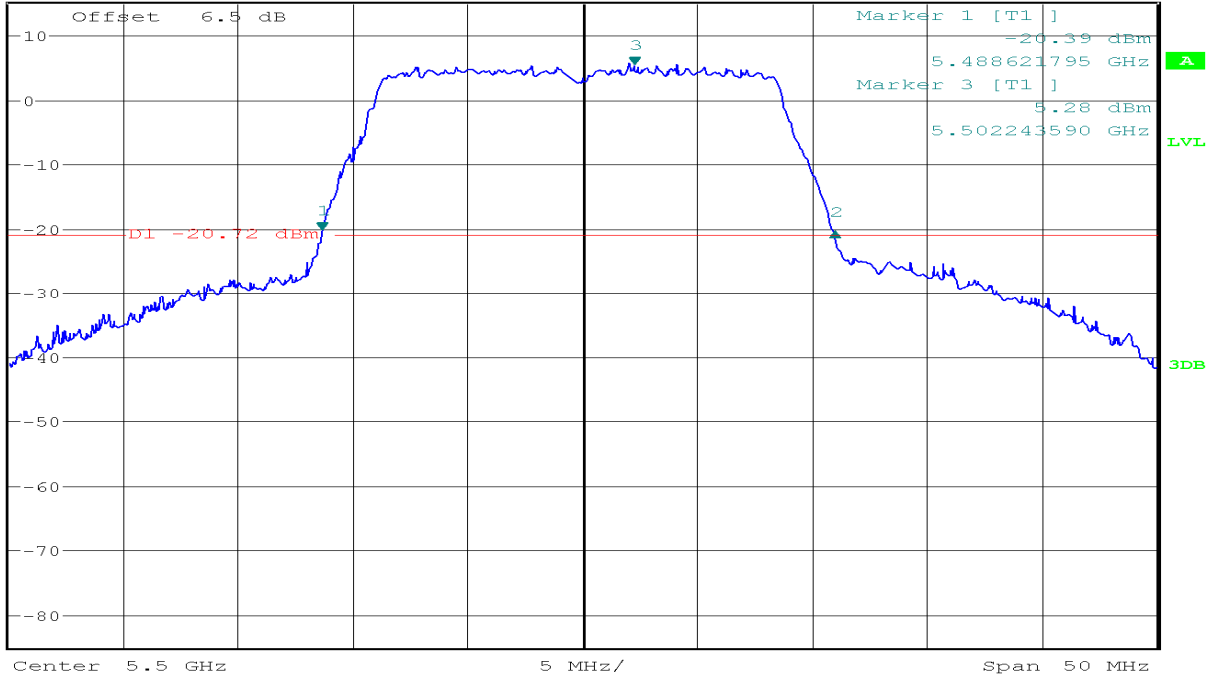

CH Mid



Ref 15 dBm *Att 5 dB *RBW 300 kHz Delta 2 [T1] -0.37 dB
 *VBW 1 MHz SWT 20 ms 22.355769231 MHz

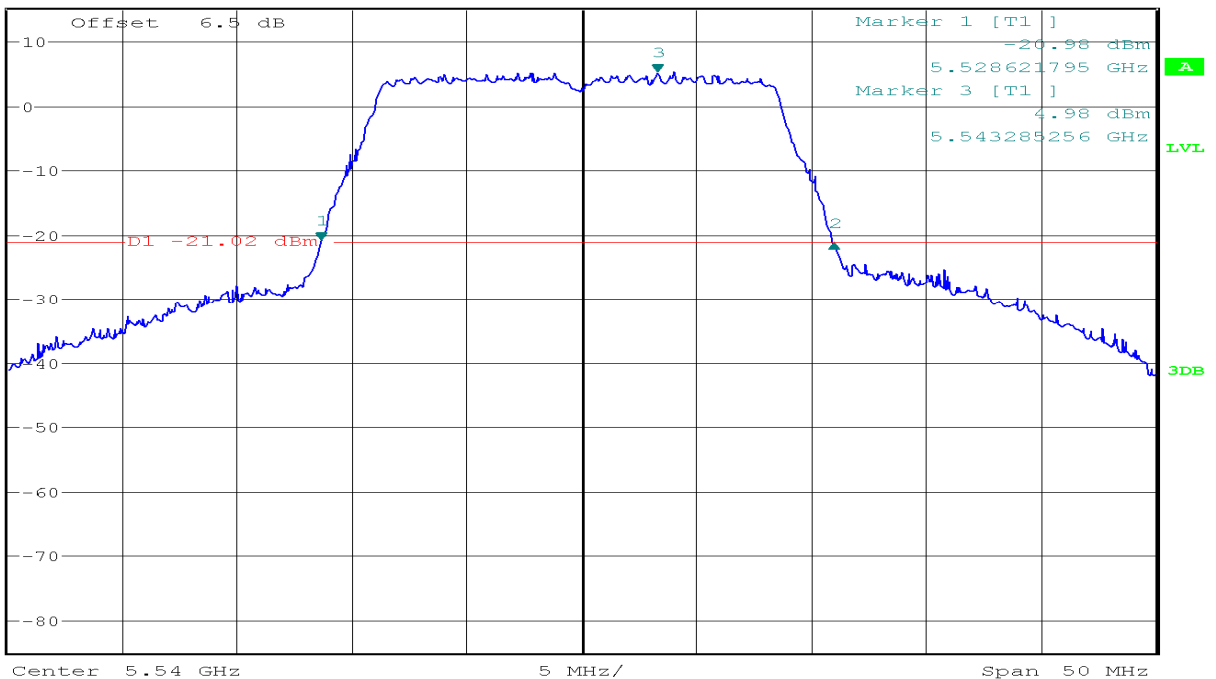

CH High

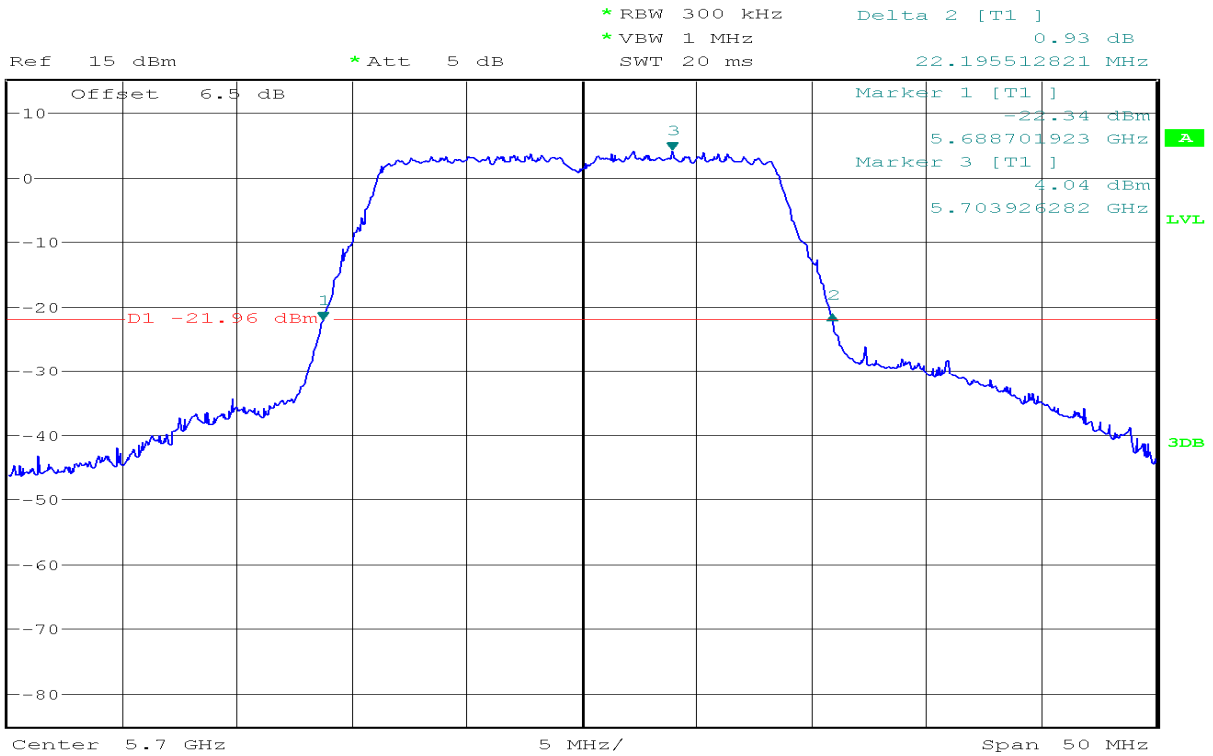

IEEE 802.11n HT20 mode / Chain 1
 5150~5250MHz

CH Low

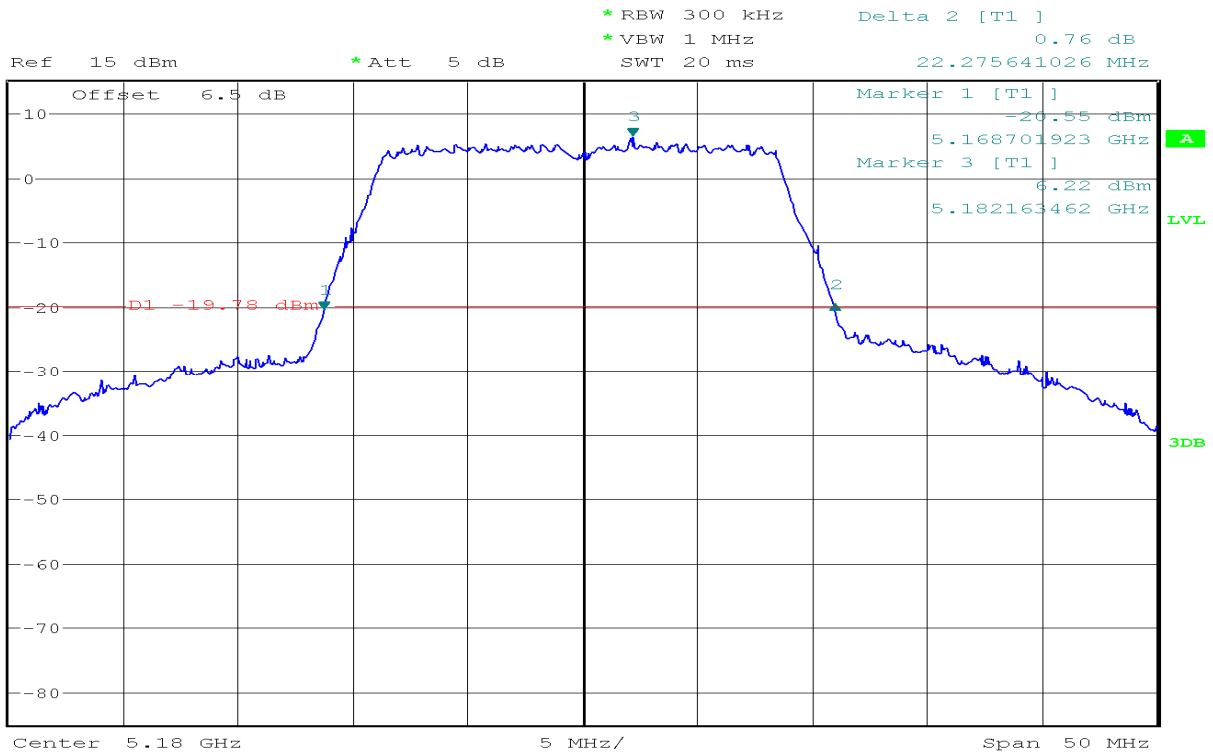

CH Mid

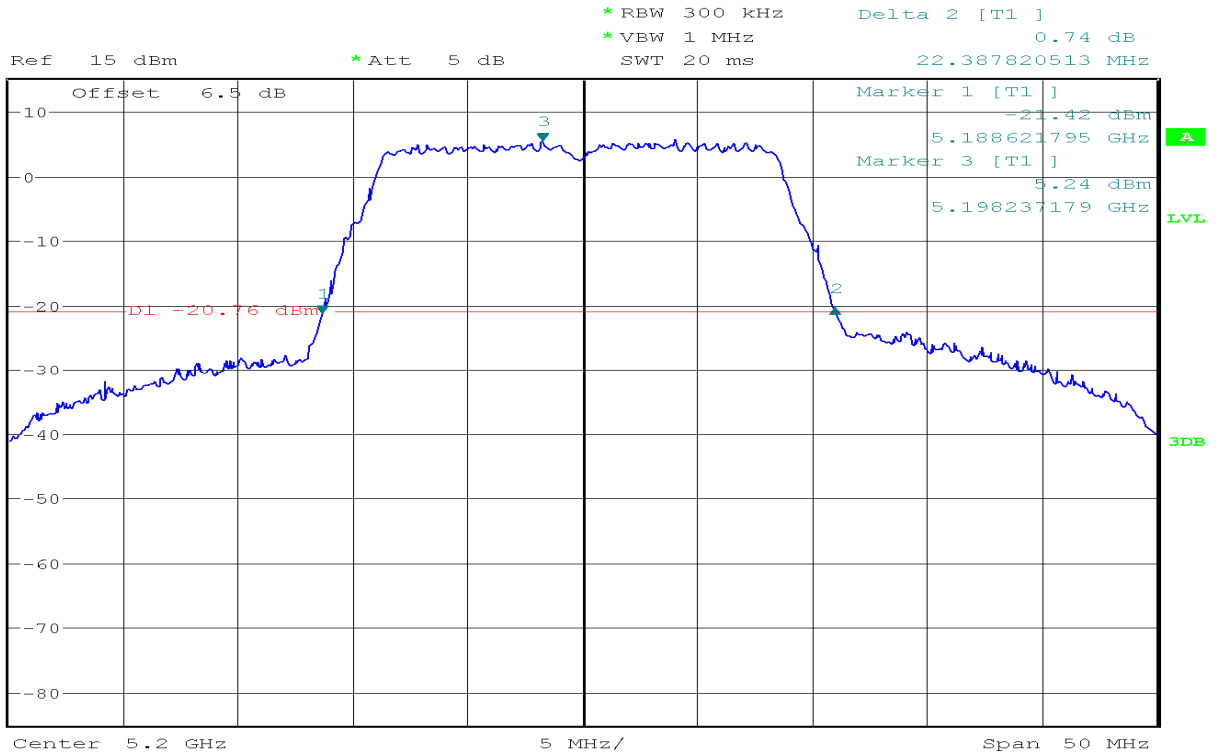

CH High

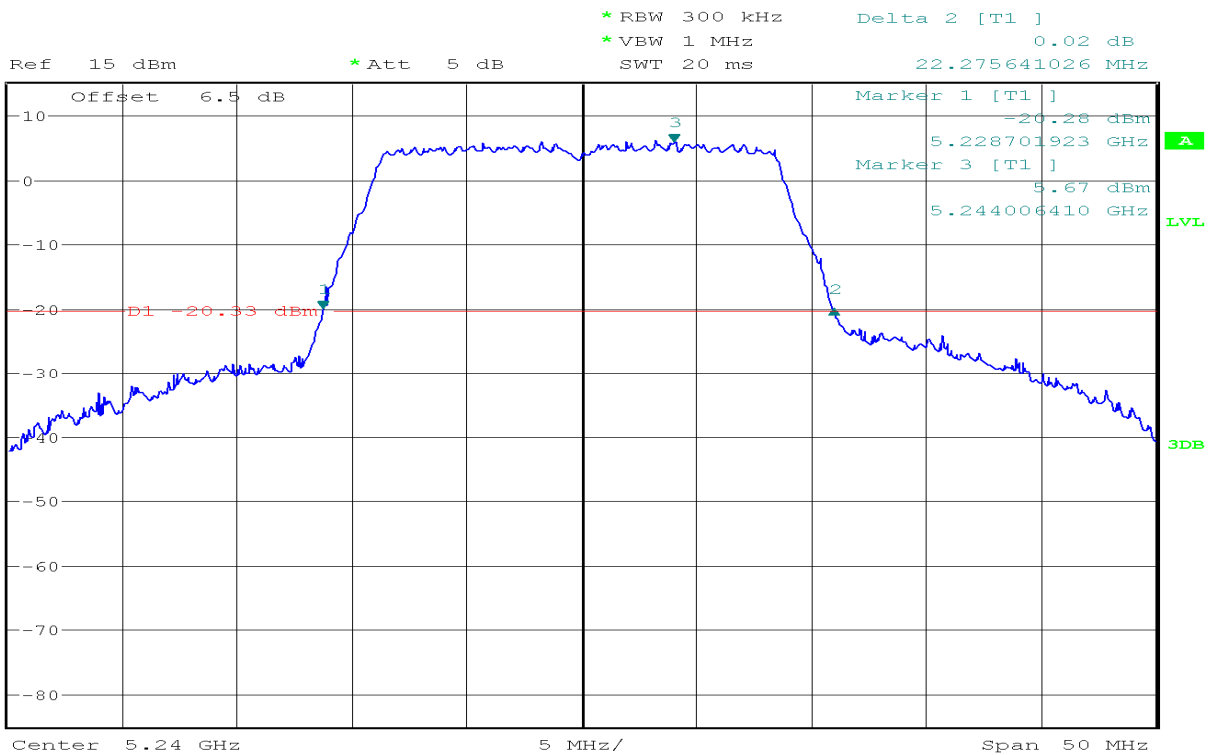

5250~5350MHz

CH Low



Ref 15 dBm *Att 5 dB *RBW 300 kHz Delta 2 [T1] 1.02 dB
 *VBW 1 MHz 22.195512821 MHz
 SWT 20 ms

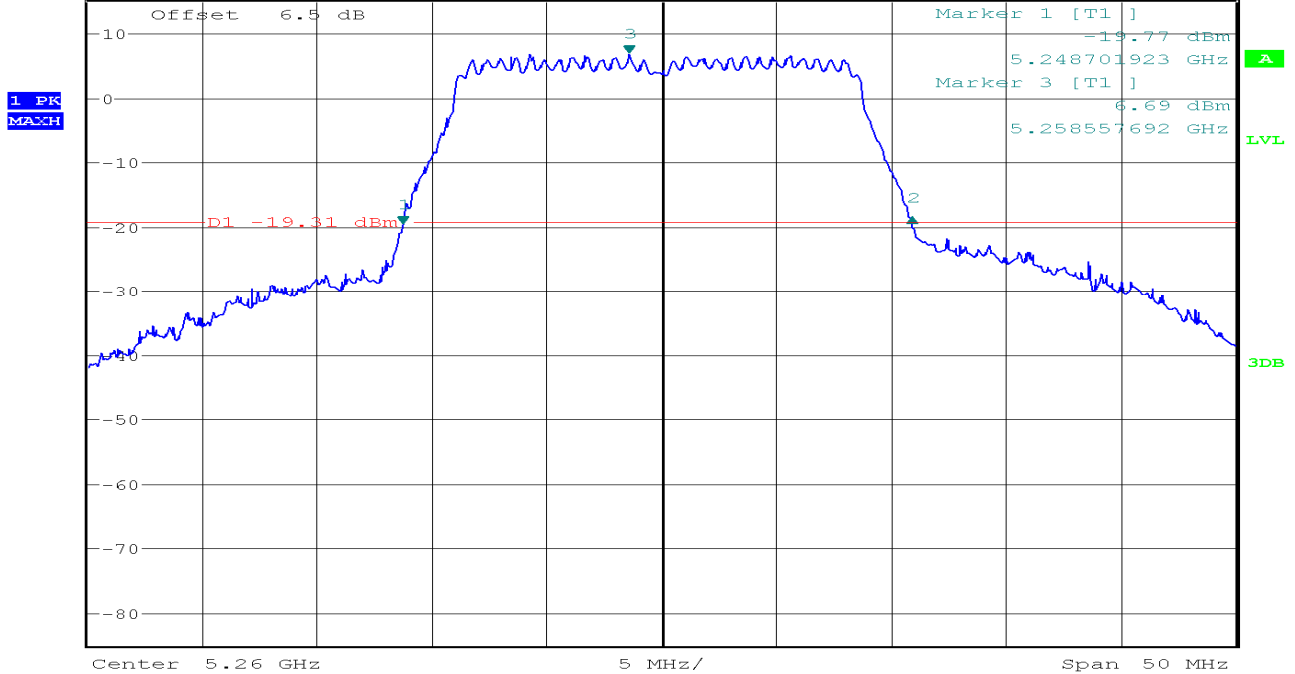

CH Mid



Ref 15 dBm *Att 5 dB *RBW 300 kHz Delta 2 [T1] 0.77 dB
 *VBW 1 MHz 22.147435897 MHz
 SWT 20 ms

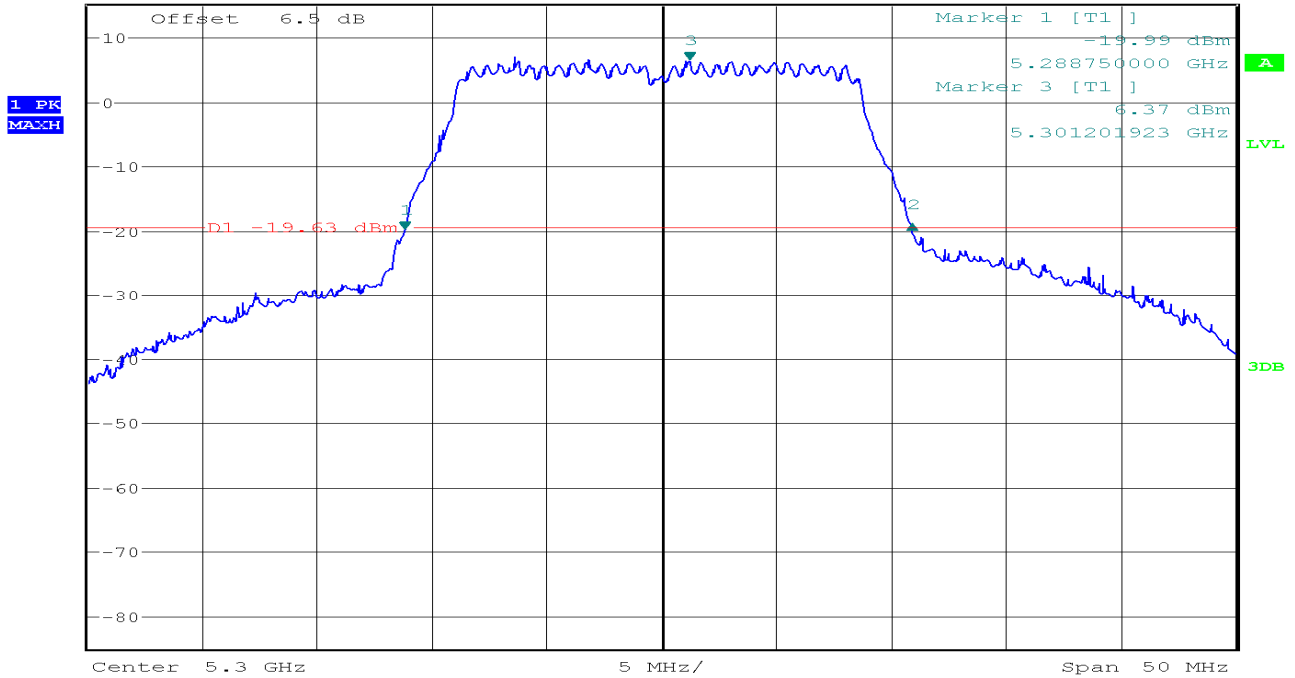

CH High

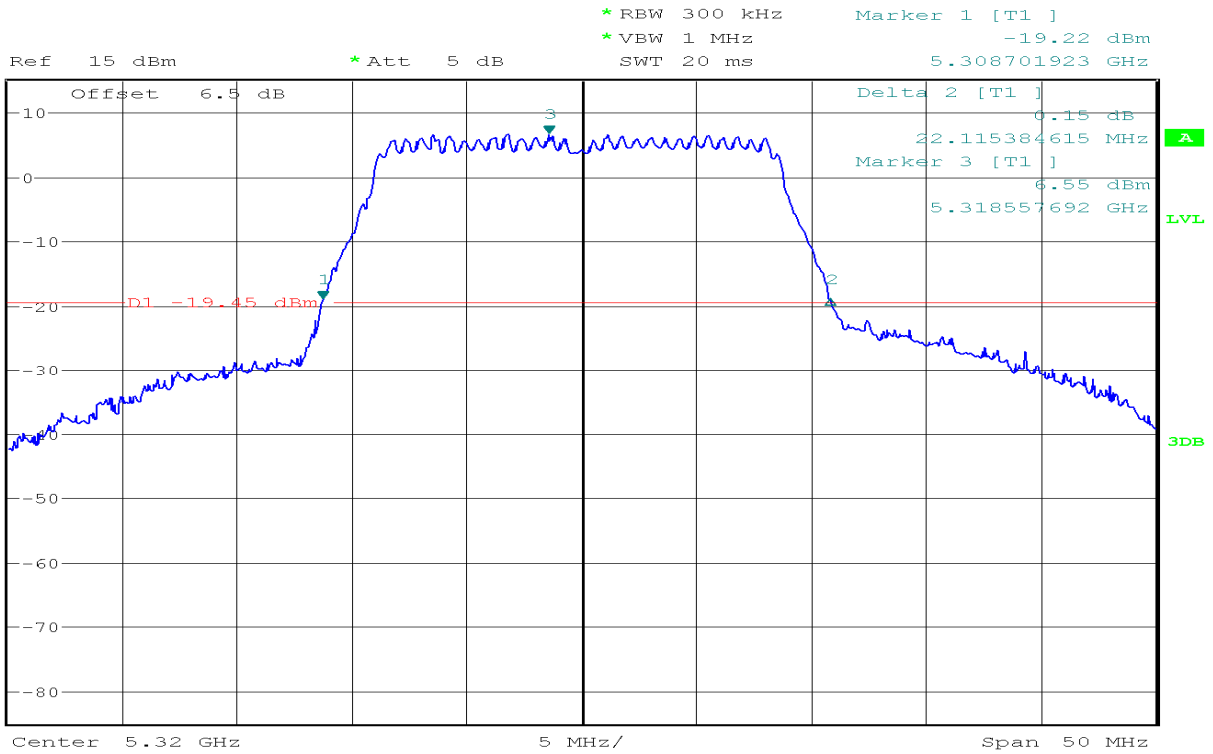

5470~5725MHz

CH Low

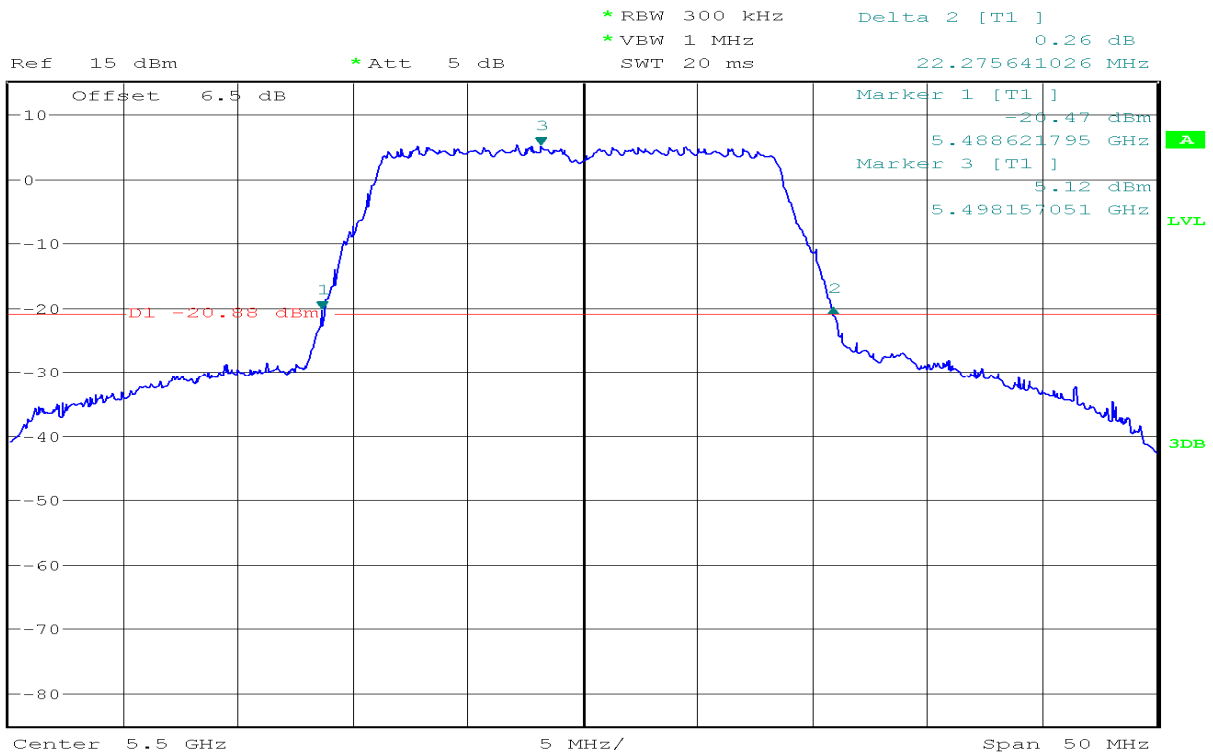

CH Mid



* RBW 300 kHz
* VBW 1 MHz
SWT 20 ms

Delta 2 [T1]
1.21 dB
22.195512821 MHz

Ref 15 dBm * Att 5 dB

1 PK
MACH

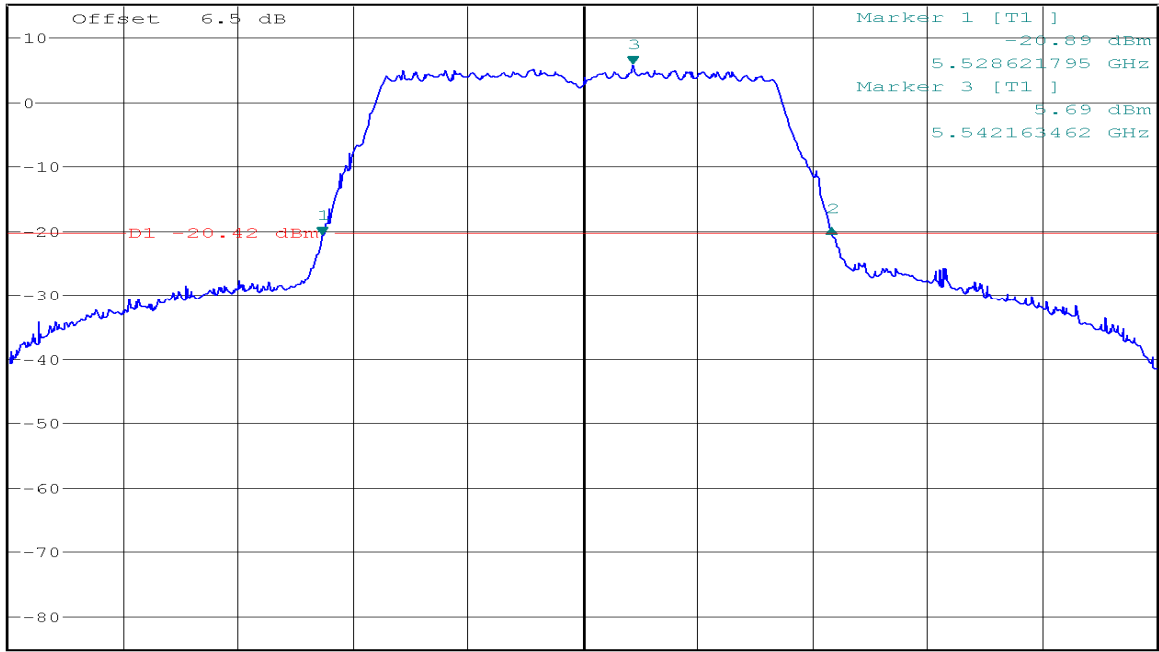

CH High



* RBW 300 kHz
* VBW 1 MHz
SWT 20 ms

Delta 2 [T1]
0.16 dB
22.115384615 MHz

Ref 15 dBm * Att 5 dB

1 PK
MACH

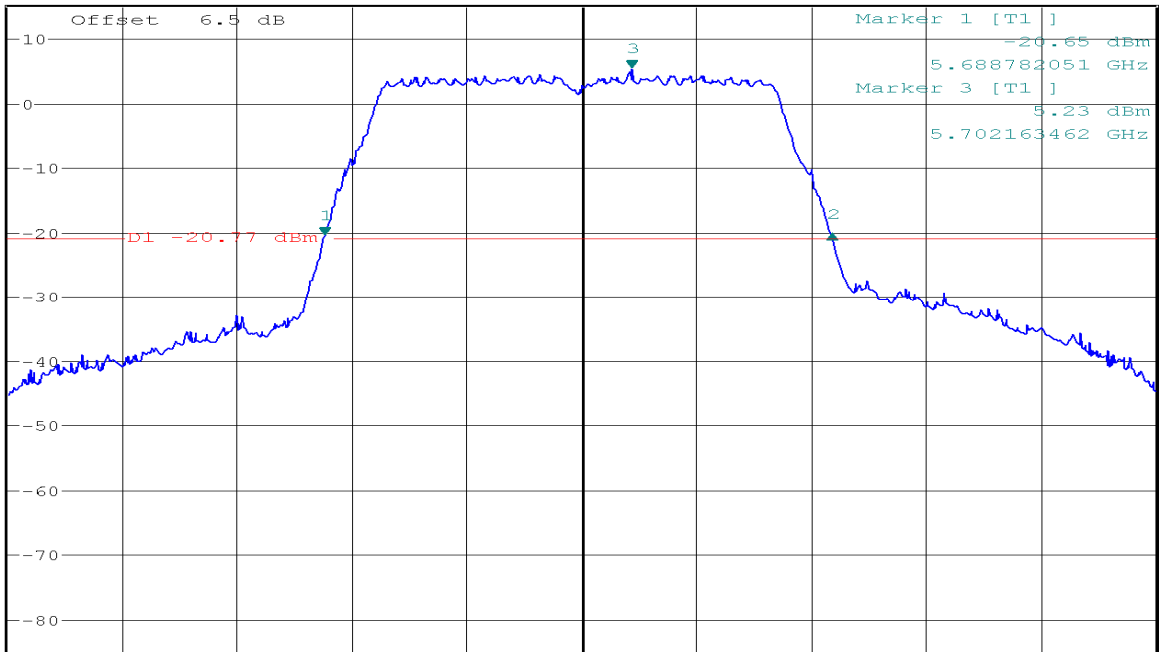

IEEE 802.11n HT40 mode / Chain 0
5150~5250MHz

CH Low

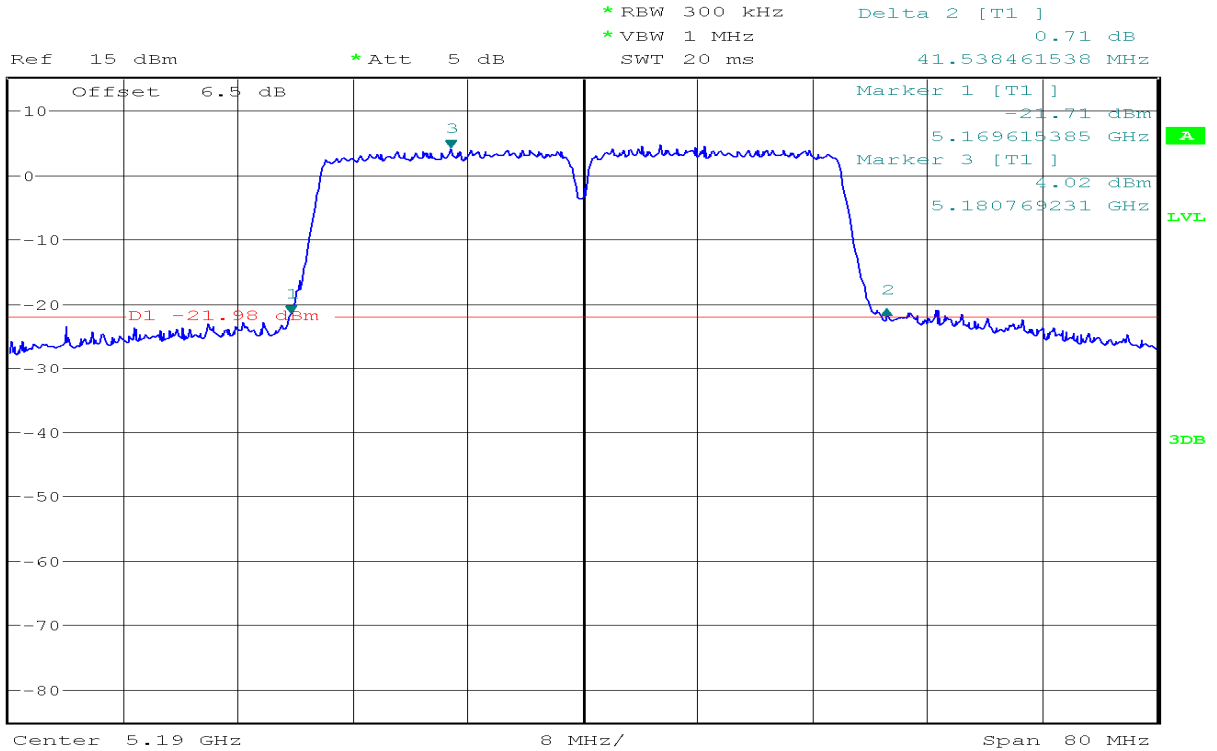

CH High

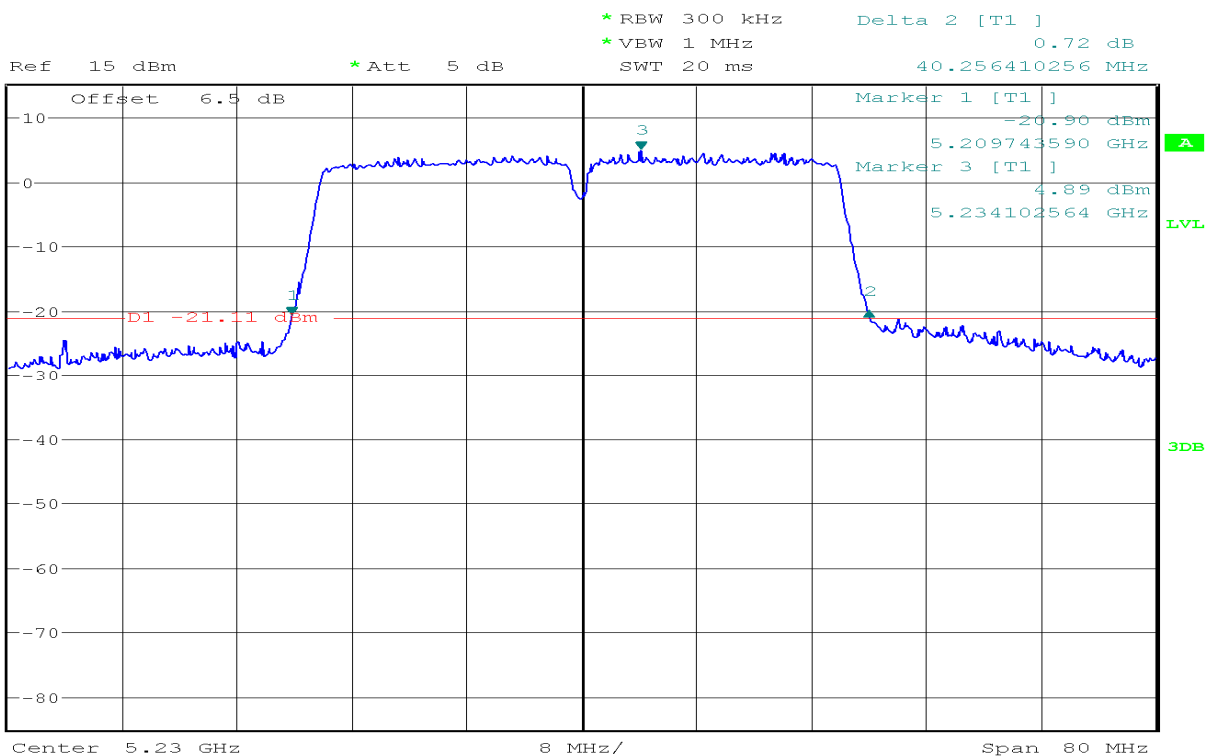

5250~5350MHz

CH Low

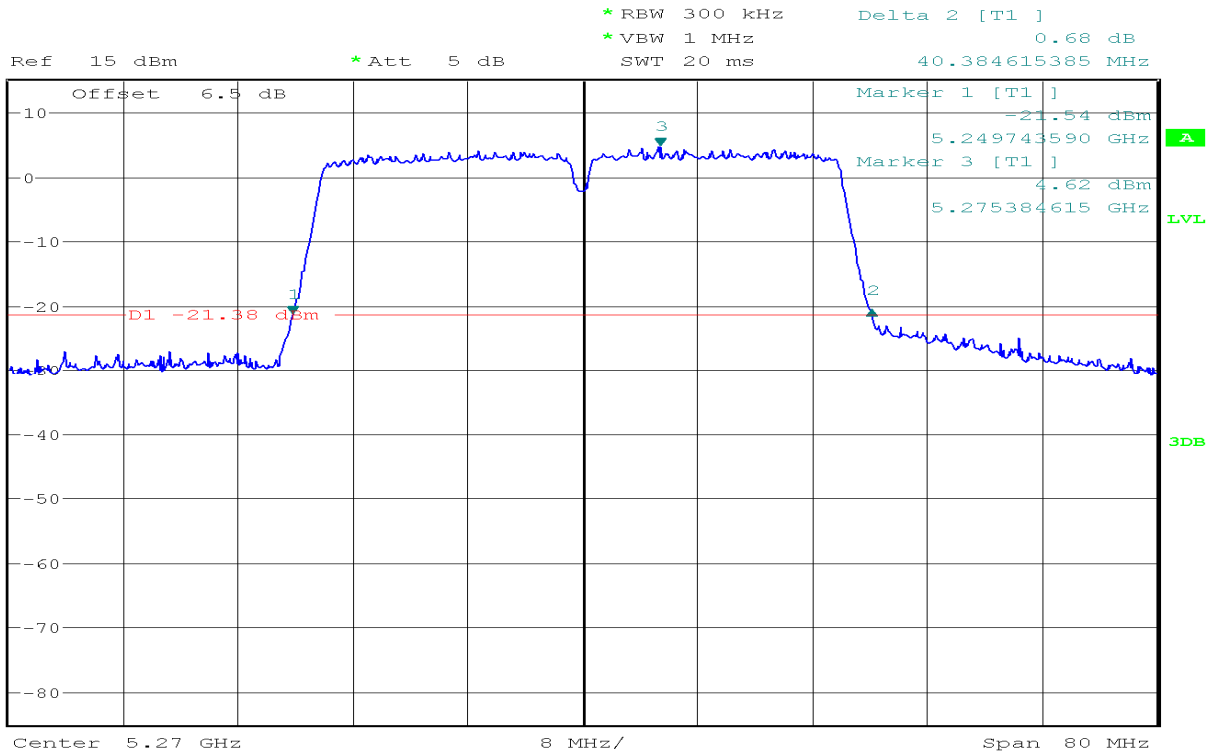

CH High

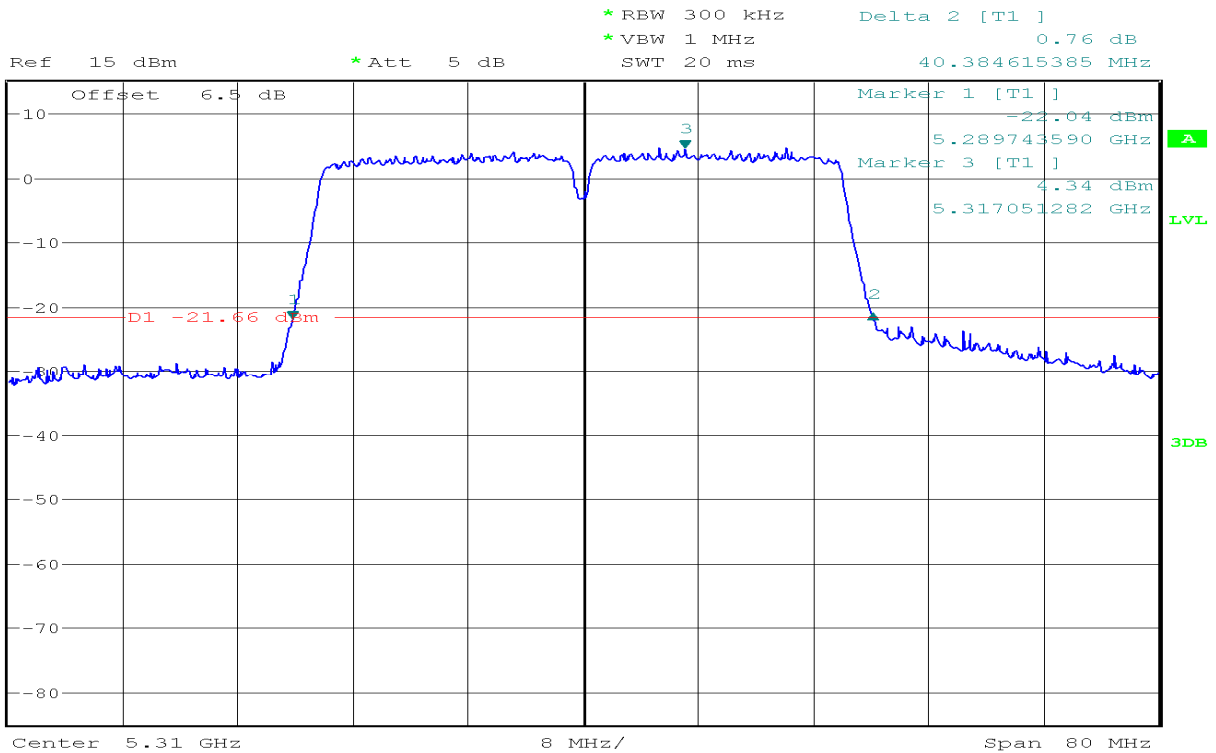

5470~5725MHz

CH Low



Ref 15 dBm * Att 5 dB * RBW 300 kHz Delta 2 [T1] 0.77 dB
 * VBW 1 MHz 40.641025641 MHz
 SWT 20 ms

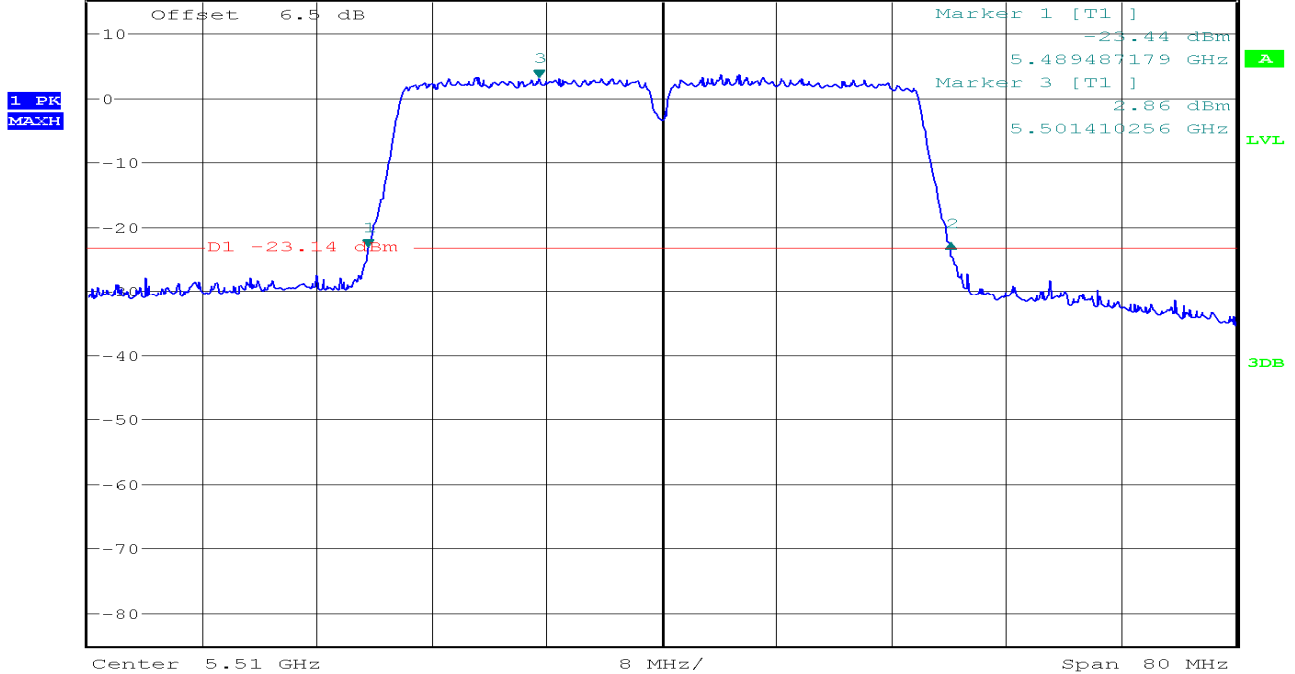

CH Mid



Ref 15 dBm * Att 5 dB * RBW 300 kHz Delta 2 [T1] 0.83 dB
 * VBW 1 MHz 40.641025641 MHz
 SWT 20 ms

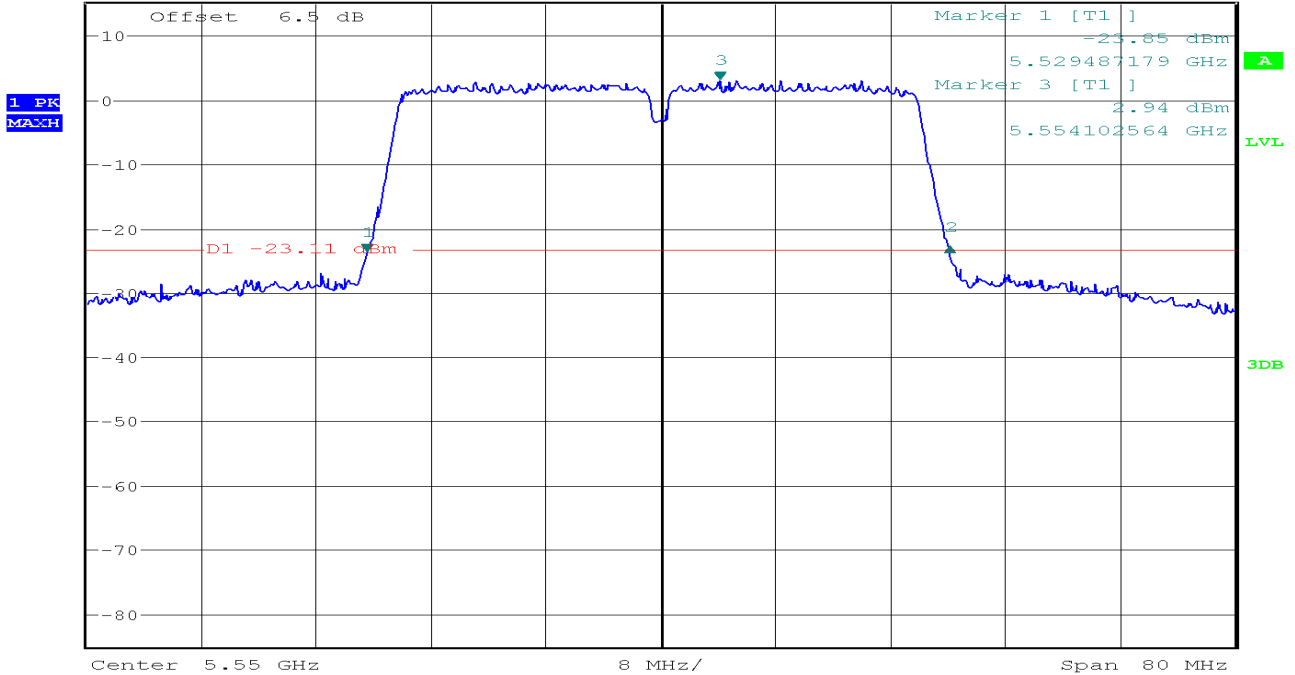

CH High

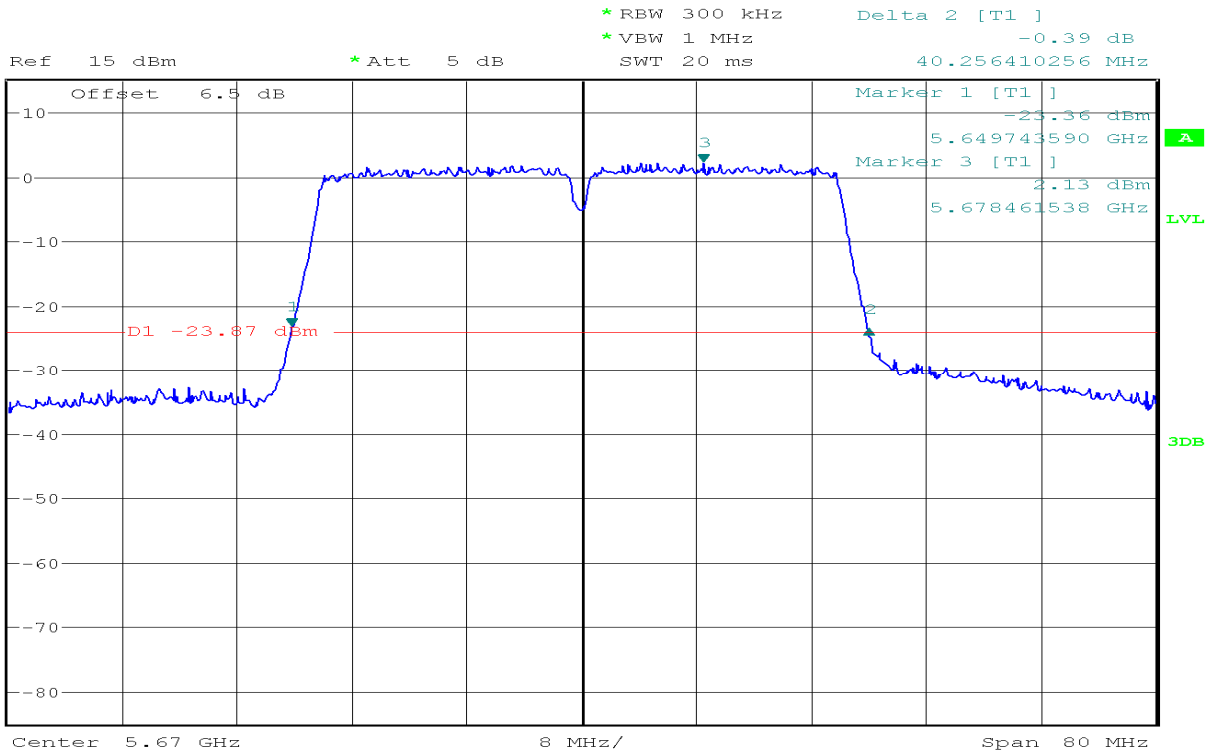

IEEE 802.11n HT40 mode / Chain 1
5150~5250MHz

CH Low

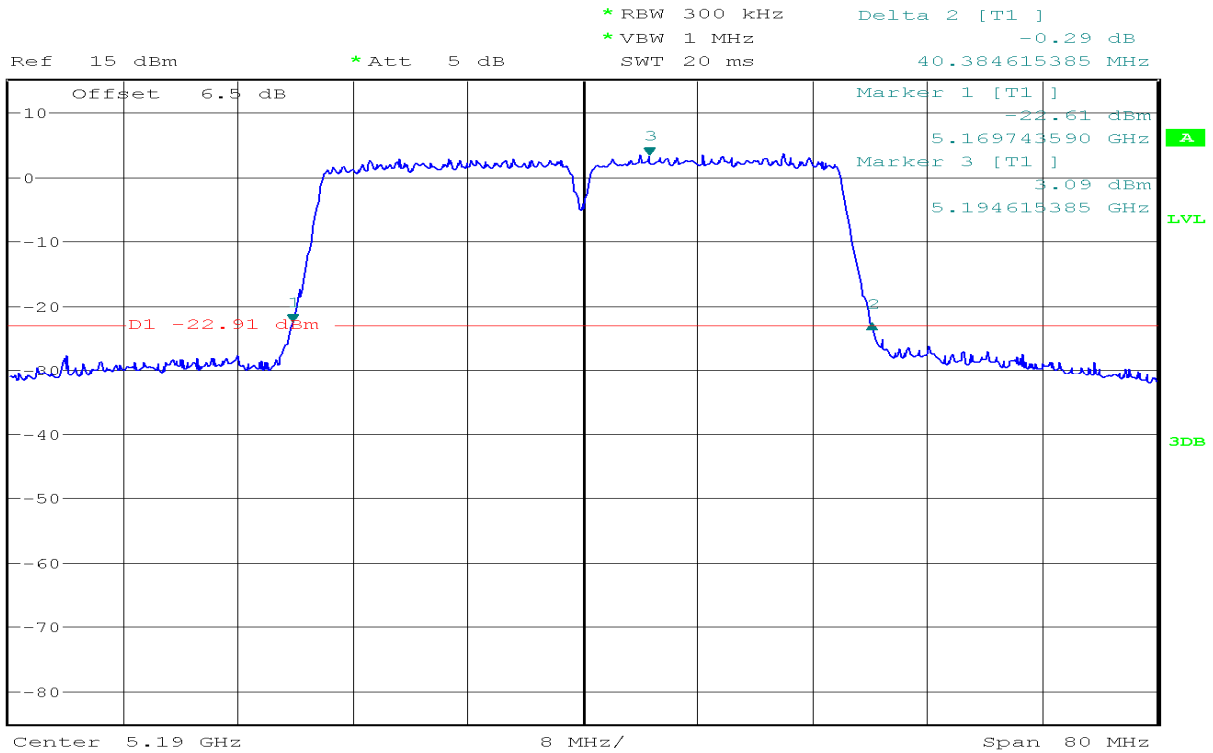

CH High

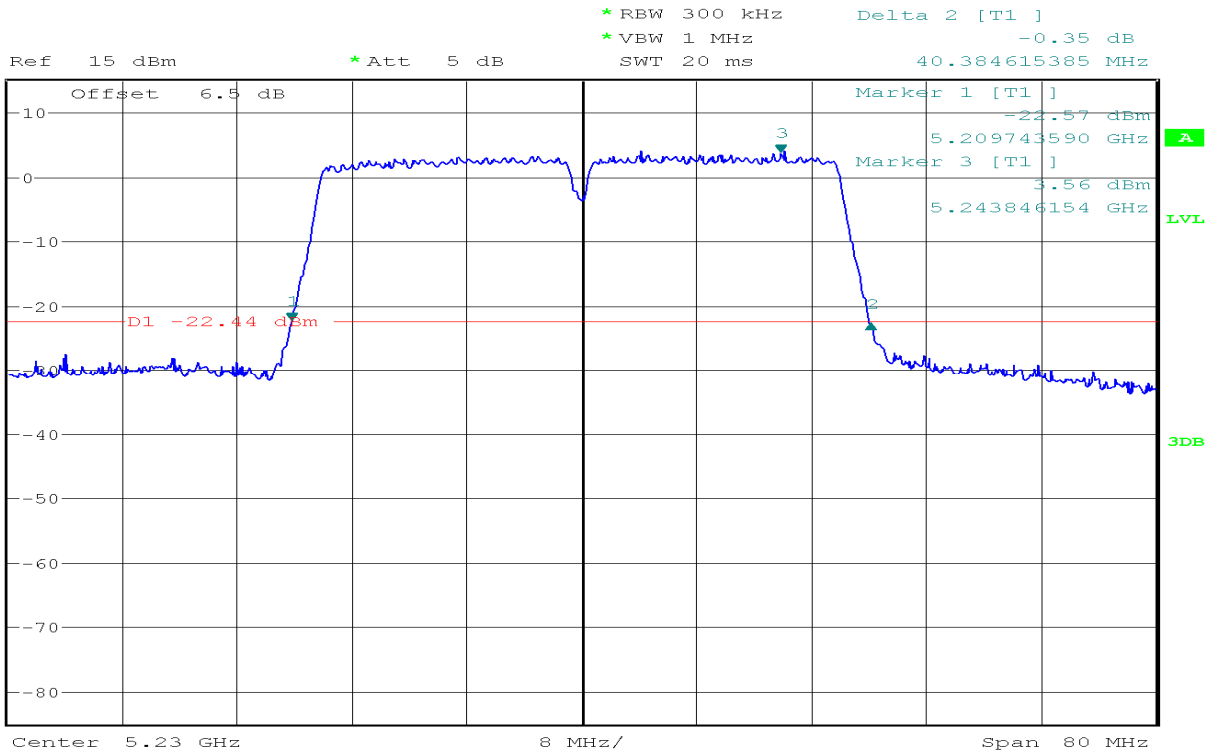

5250~5350MHz

CH Low

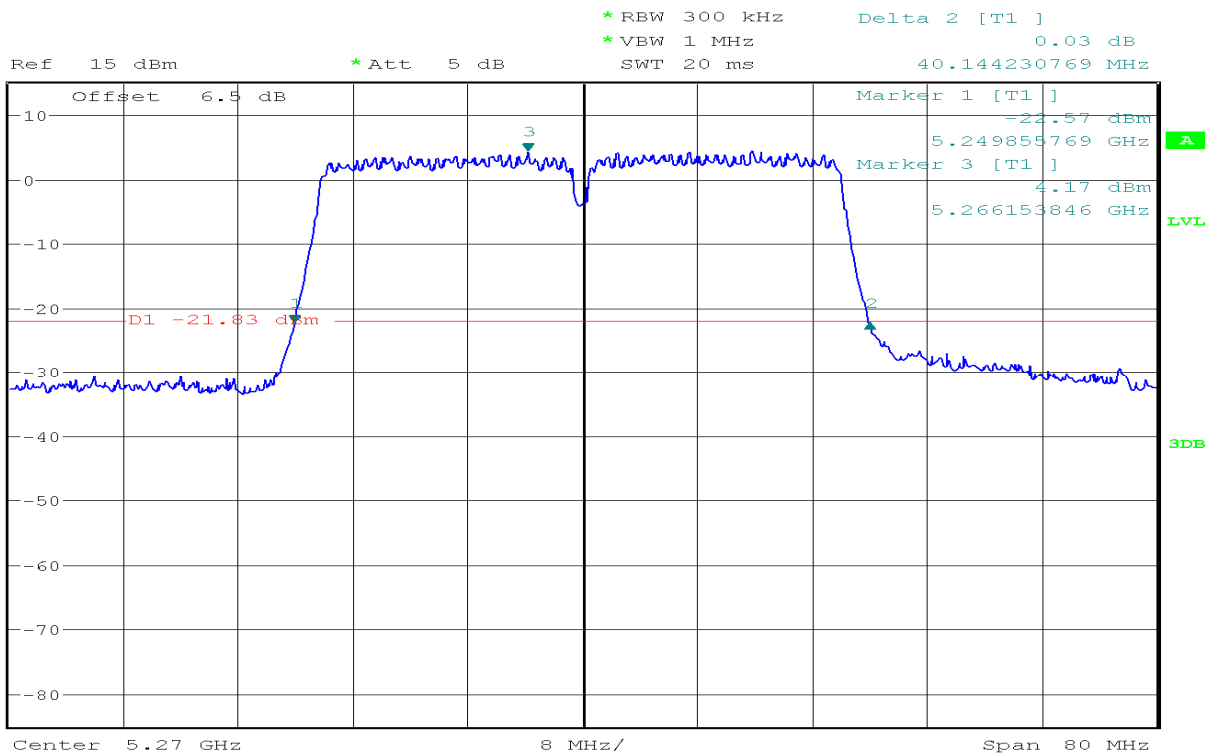

CH High

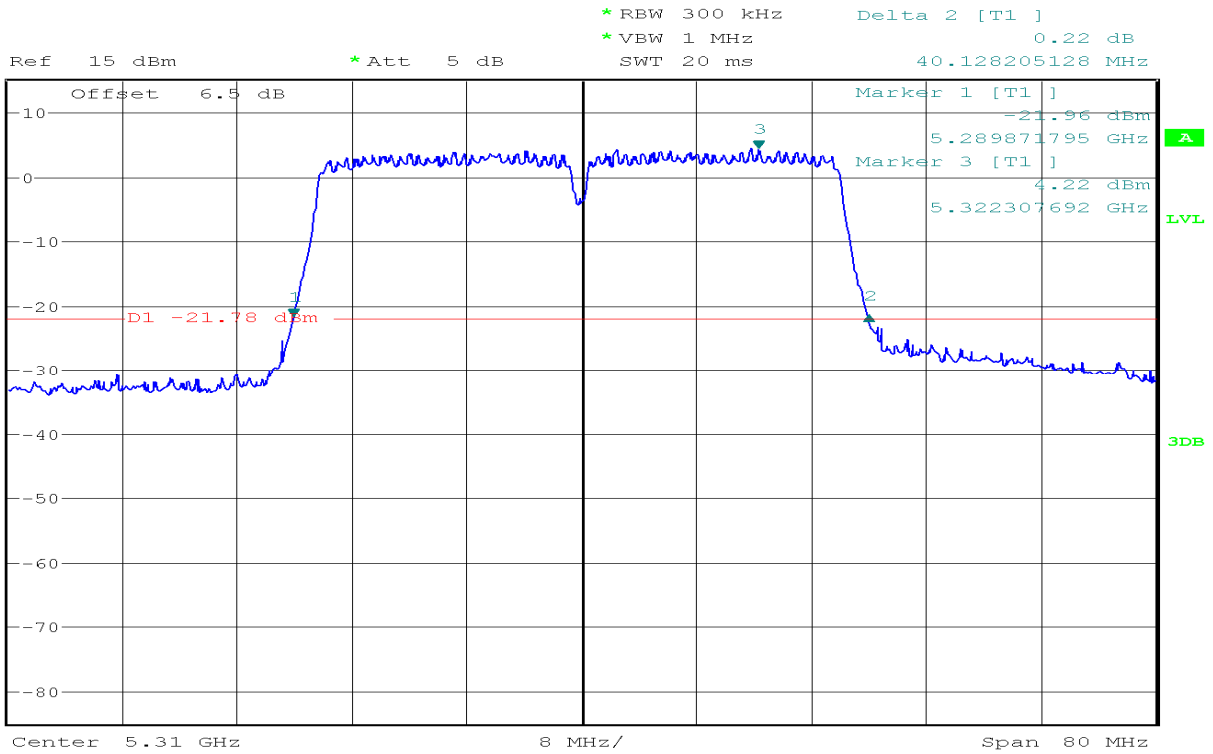

5470~5725MHz

CH Low

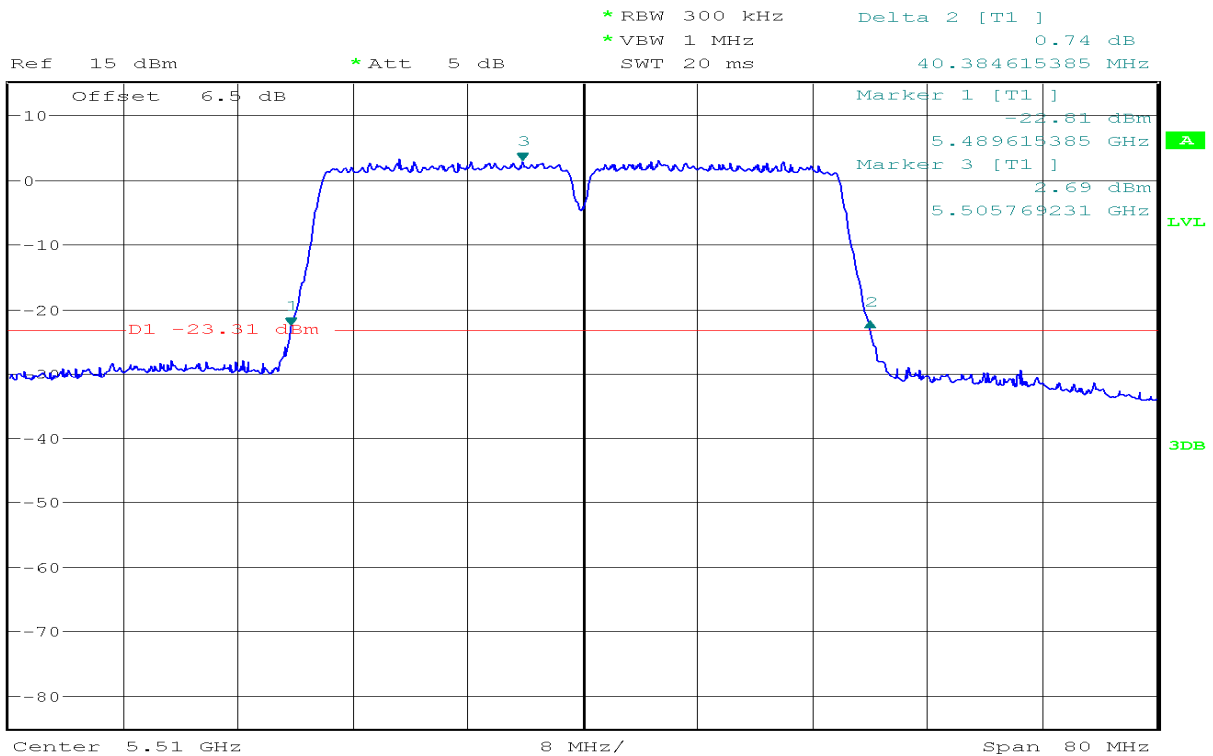

CH Mid

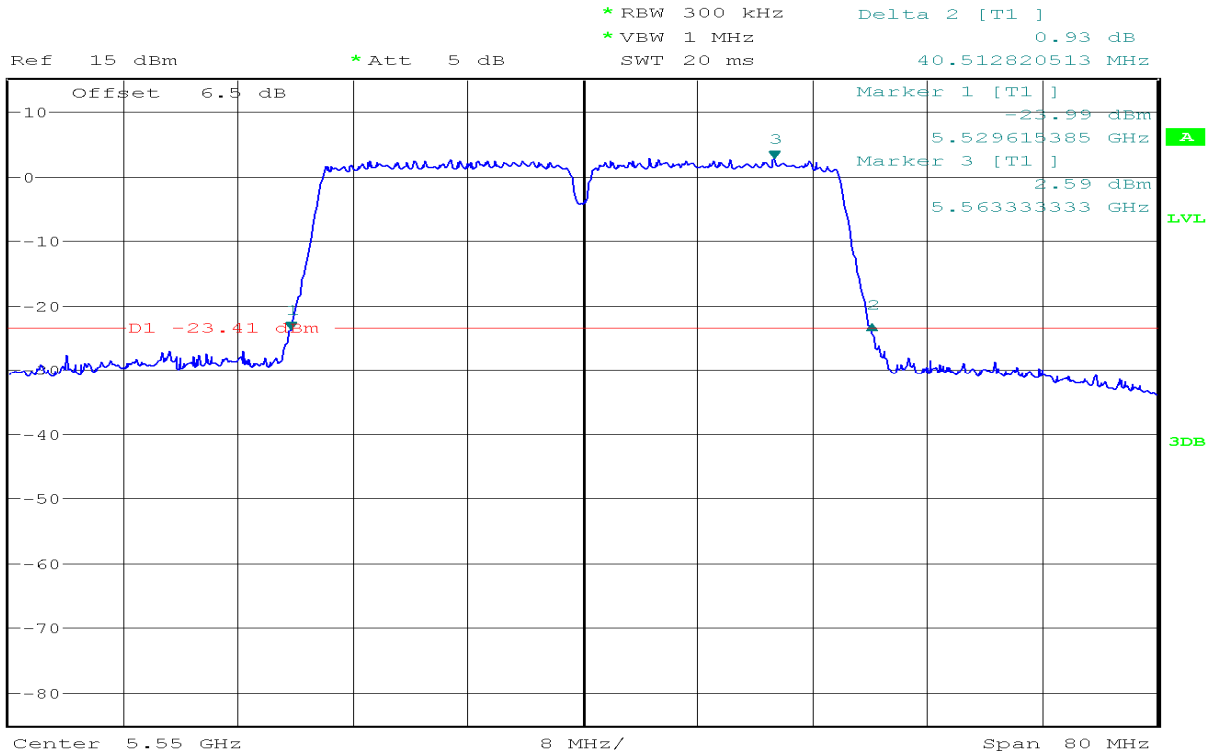

CH High

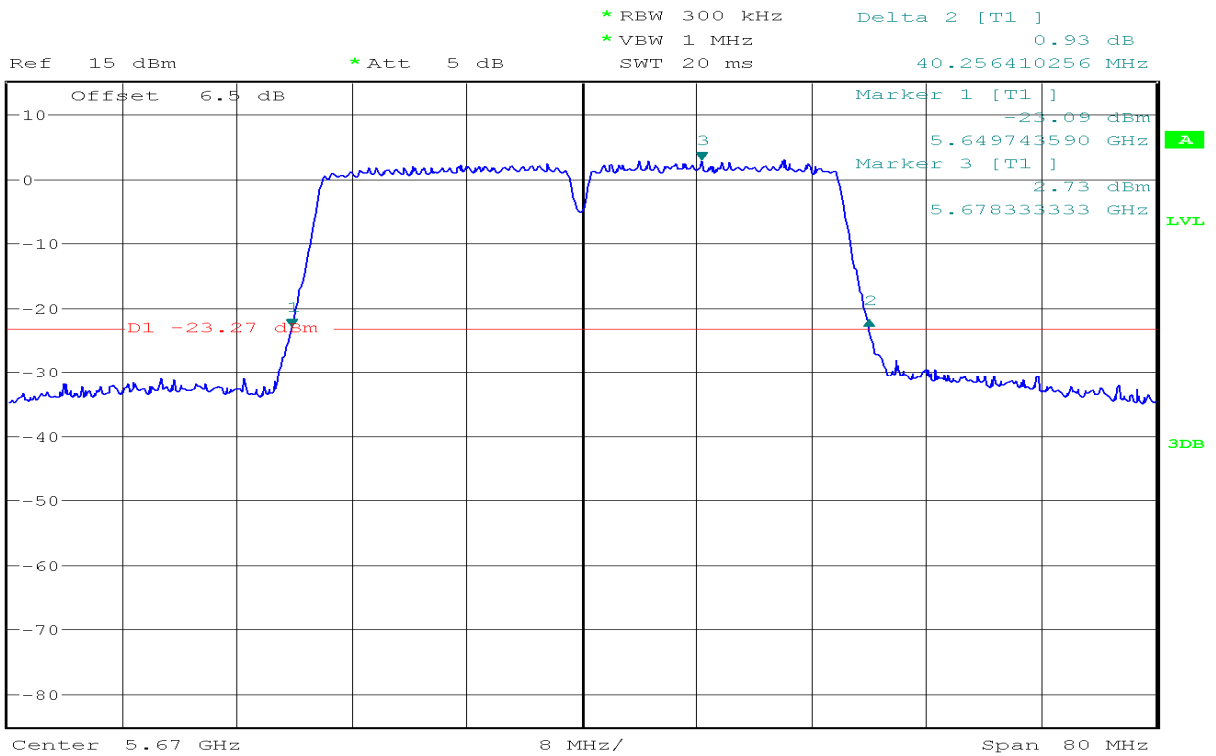

IEEE 802.11ac HT20 mode / Chain 0
5150~5250MHz

CH Low

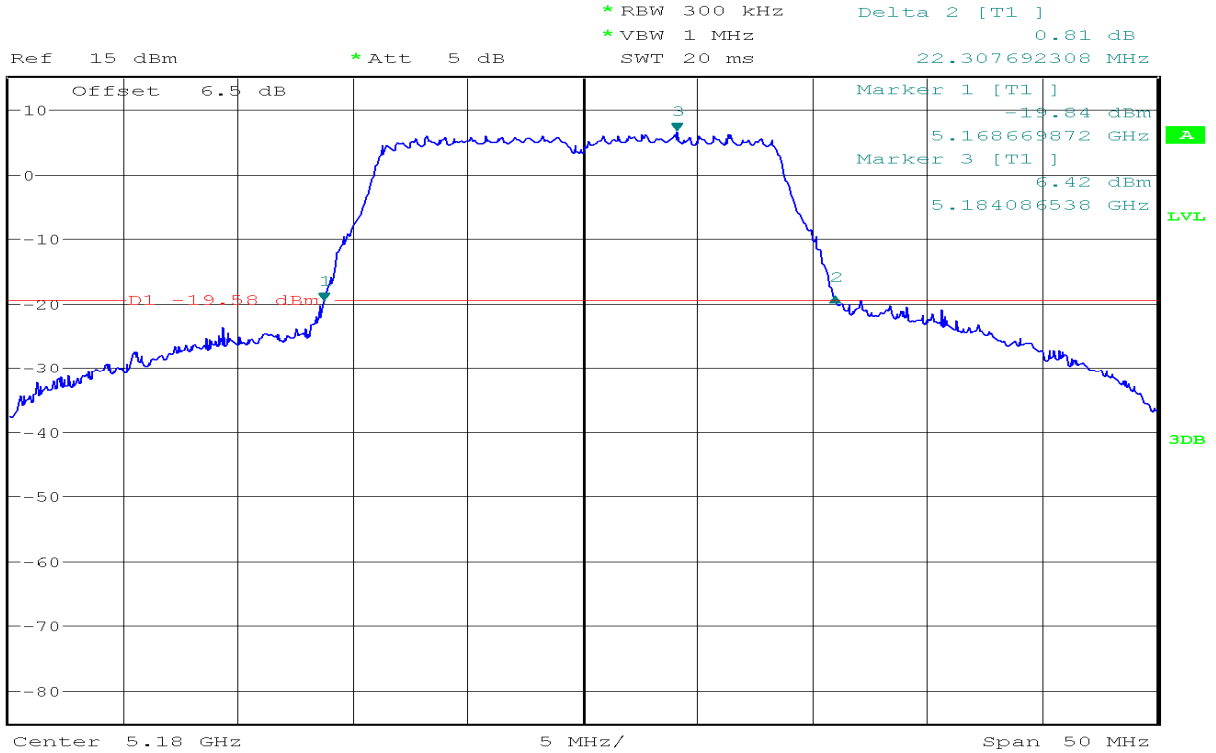

CH Mid

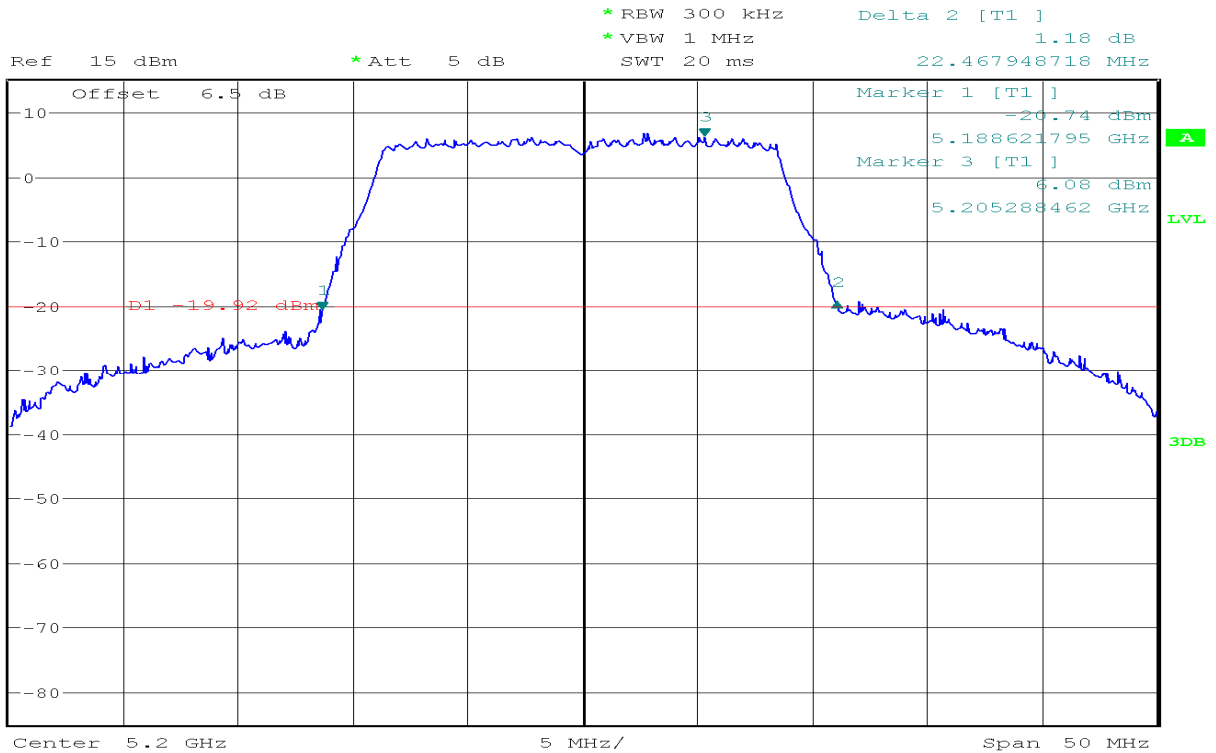

CH High

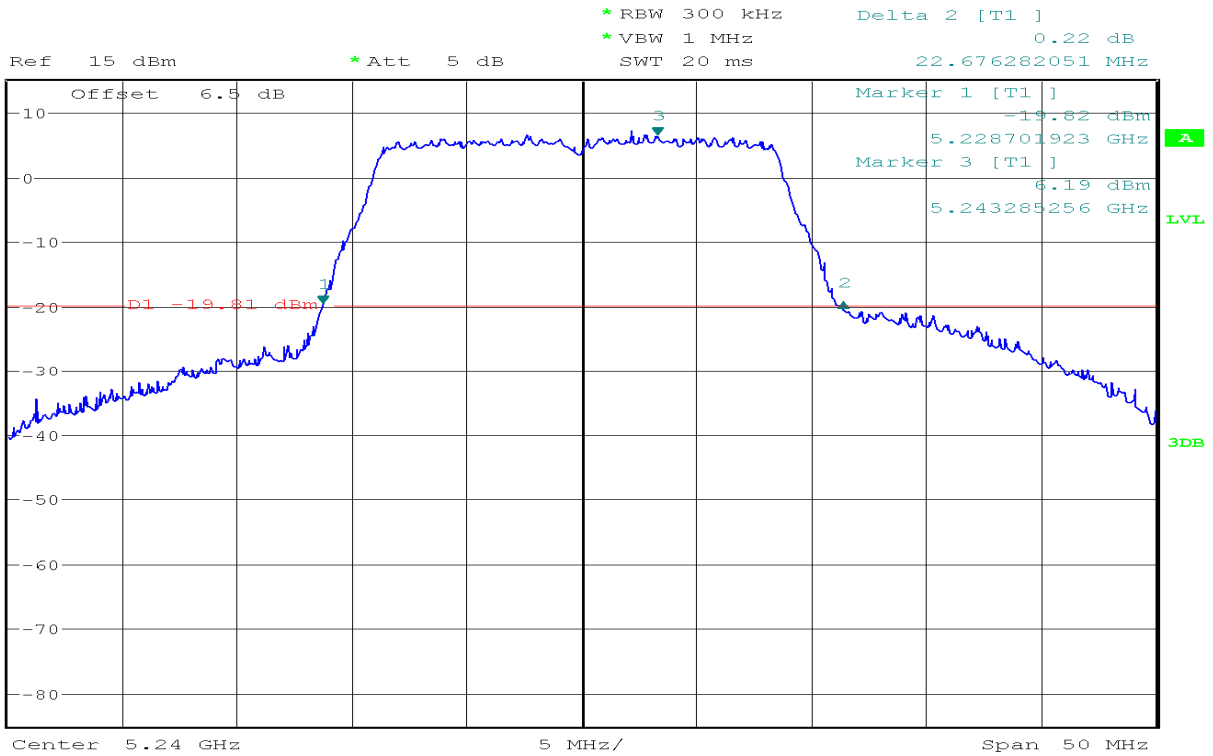

5250~5350MHz

CH Low

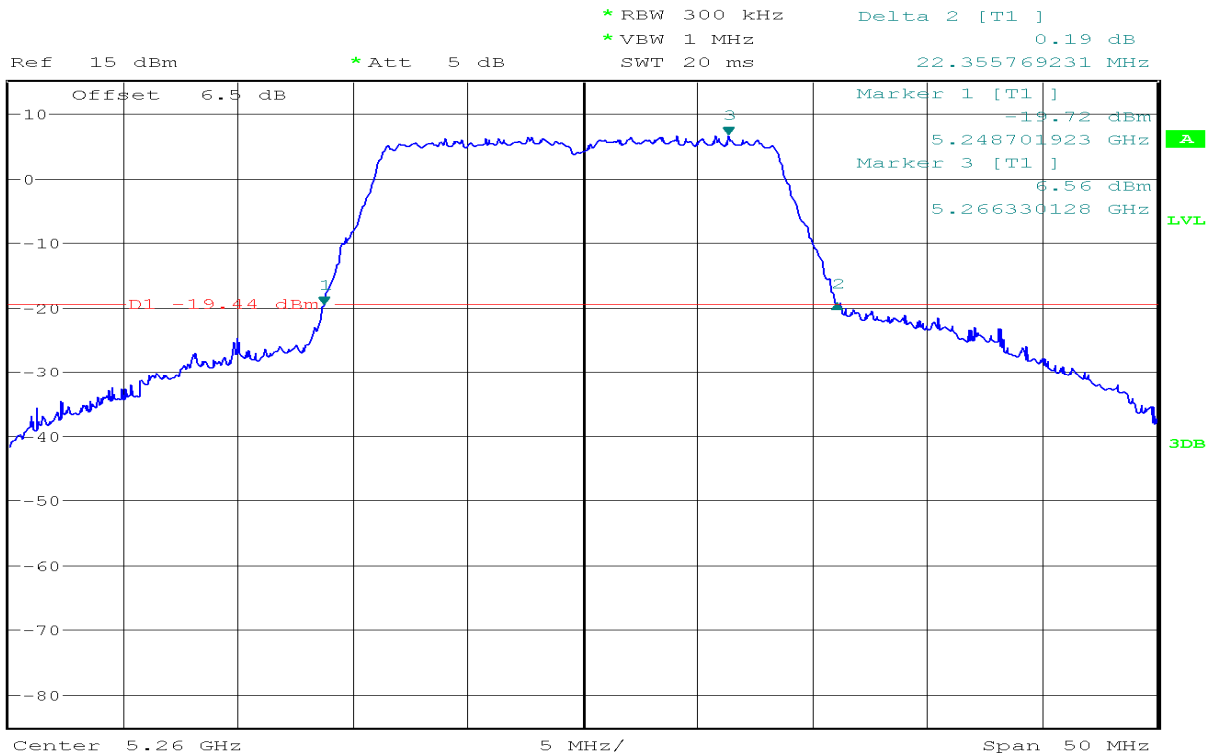

CH Mid

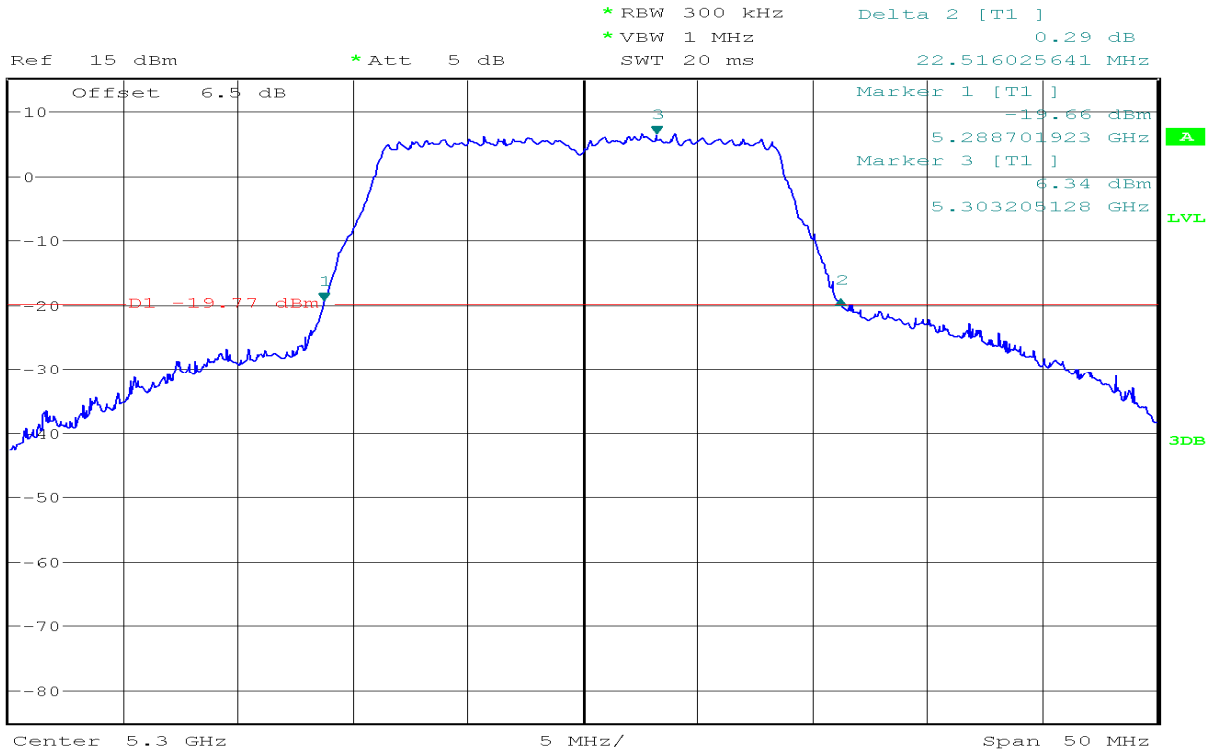

CH High

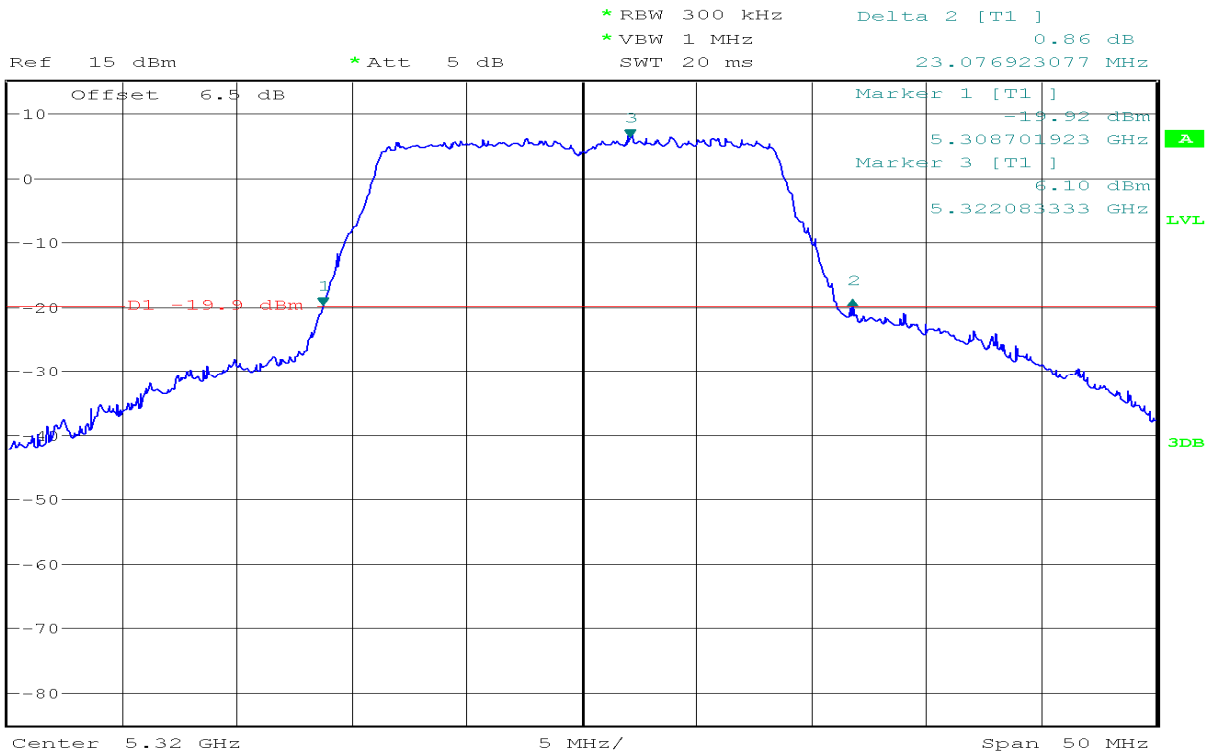

CH High

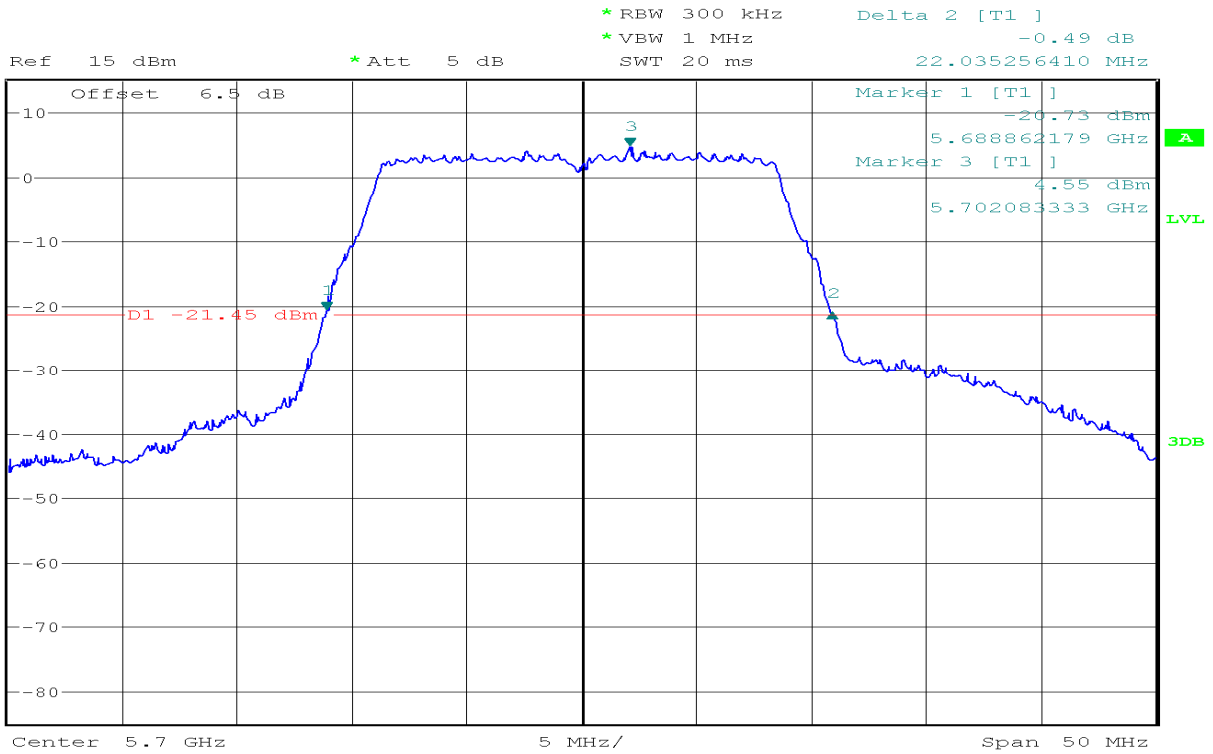

IEEE 802.11ac HT20 mode / Chain 1
5150~5250MHz

CH Low

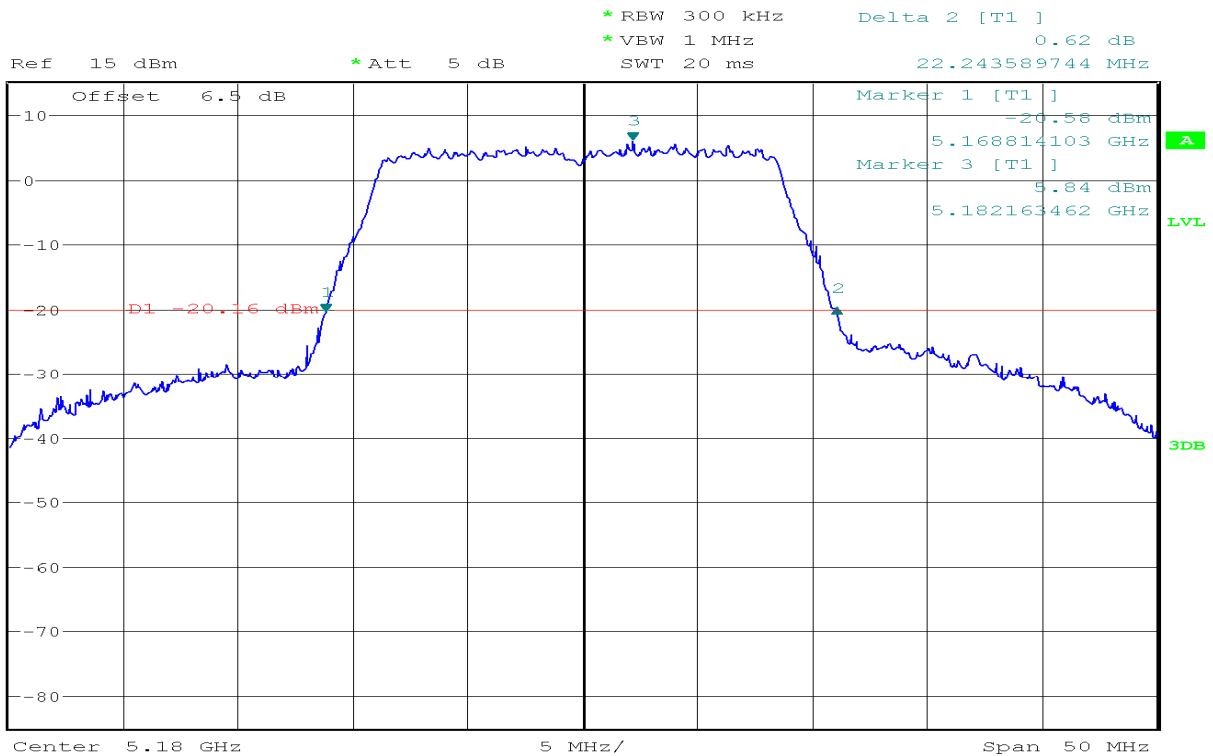

CH Mid

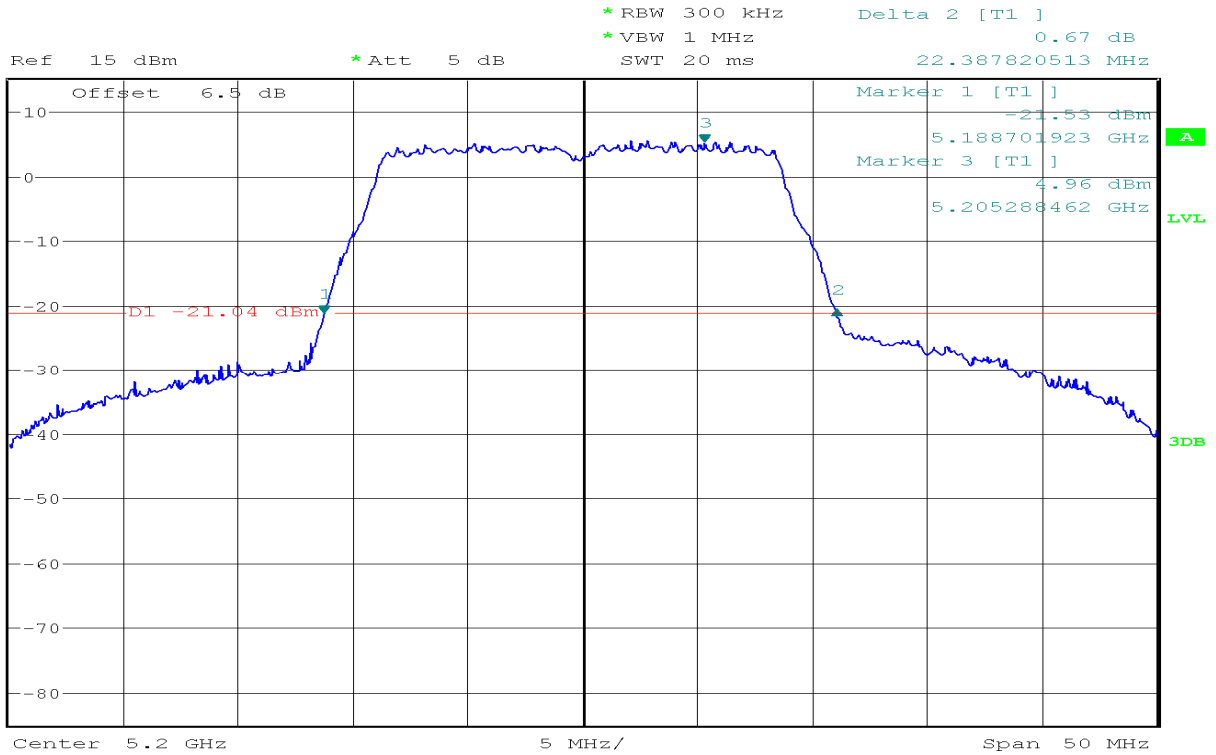

CH High

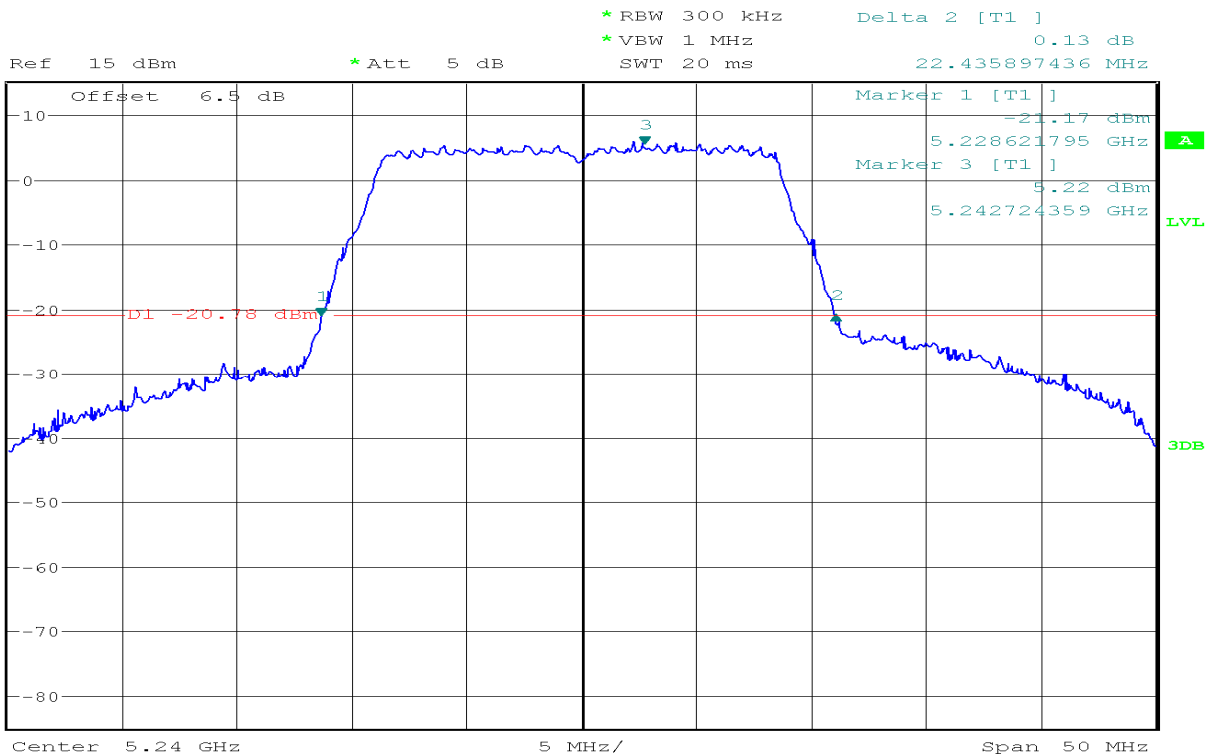

5250~5350MHz

CH Low



Ref 15 dBm *Att 5 dB *RBW 300 kHz Delta 2 [T1] 0.79 dB
 *VBW 1 MHz 22.275641026 MHz
 SWT 20 ms

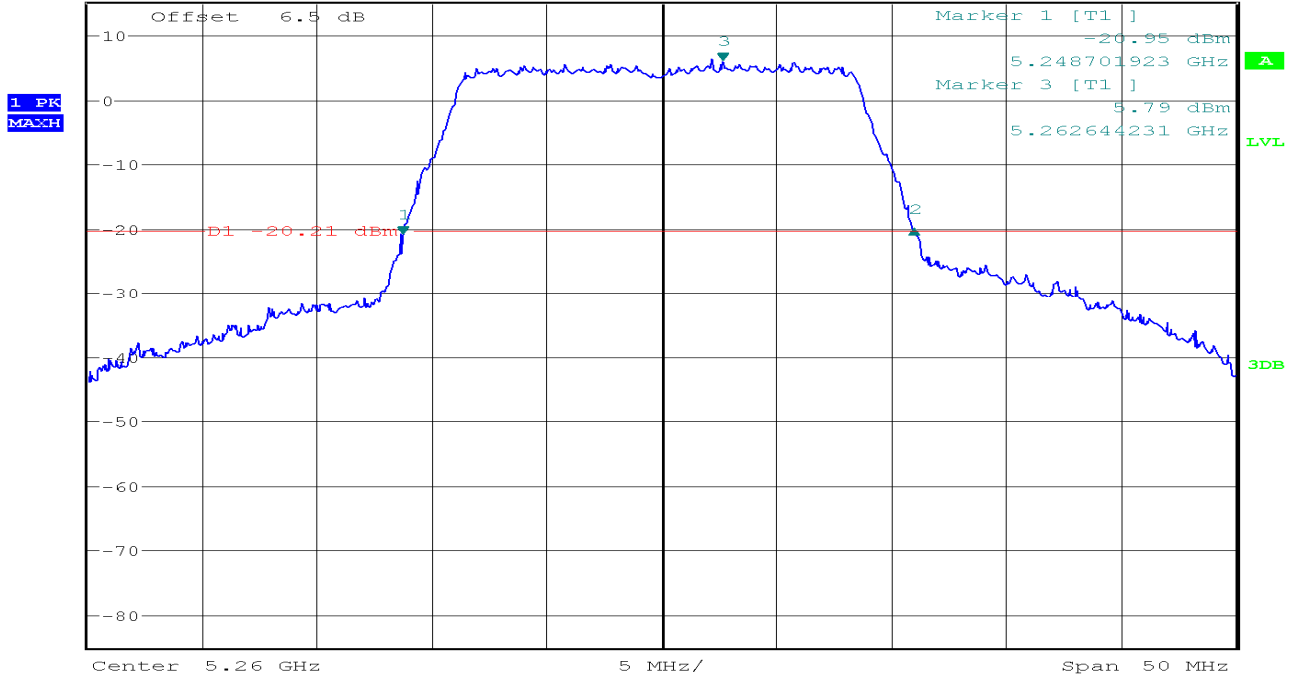

CH Mid



Ref 15 dBm *Att 5 dB *RBW 300 kHz Delta 2 [T1] 1.31 dB
 *VBW 1 MHz 22.387820513 MHz
 SWT 20 ms

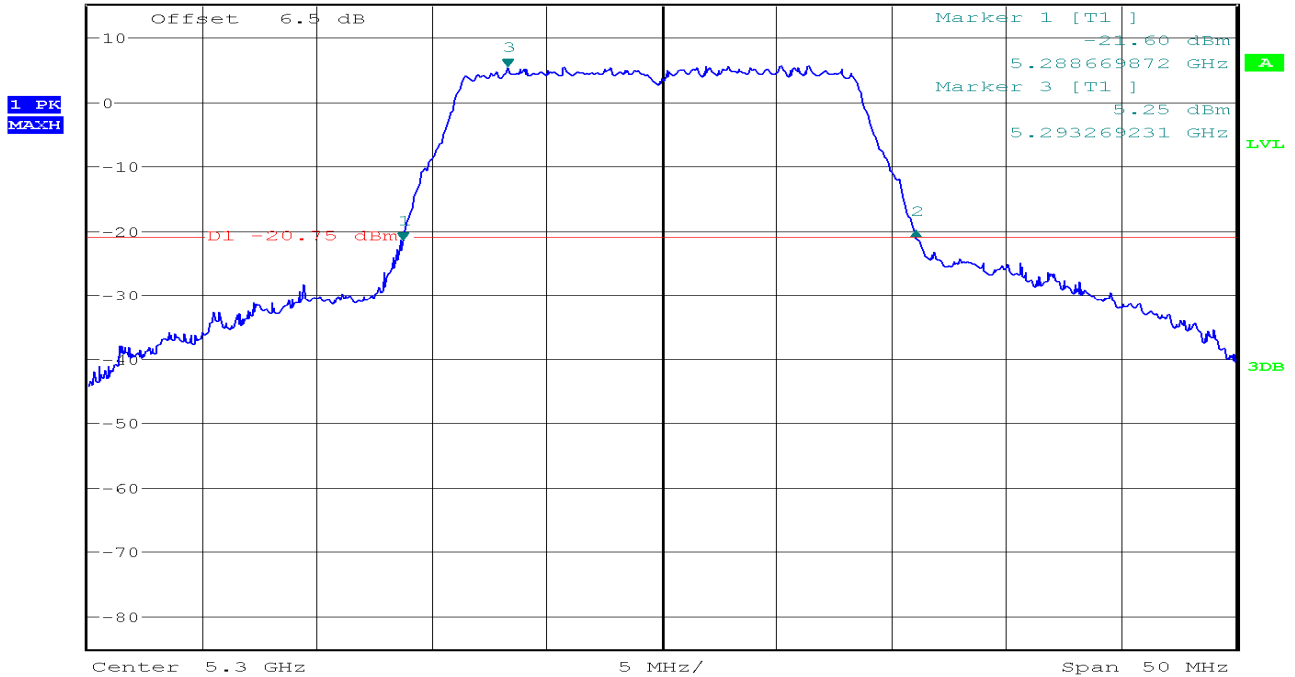

CH High

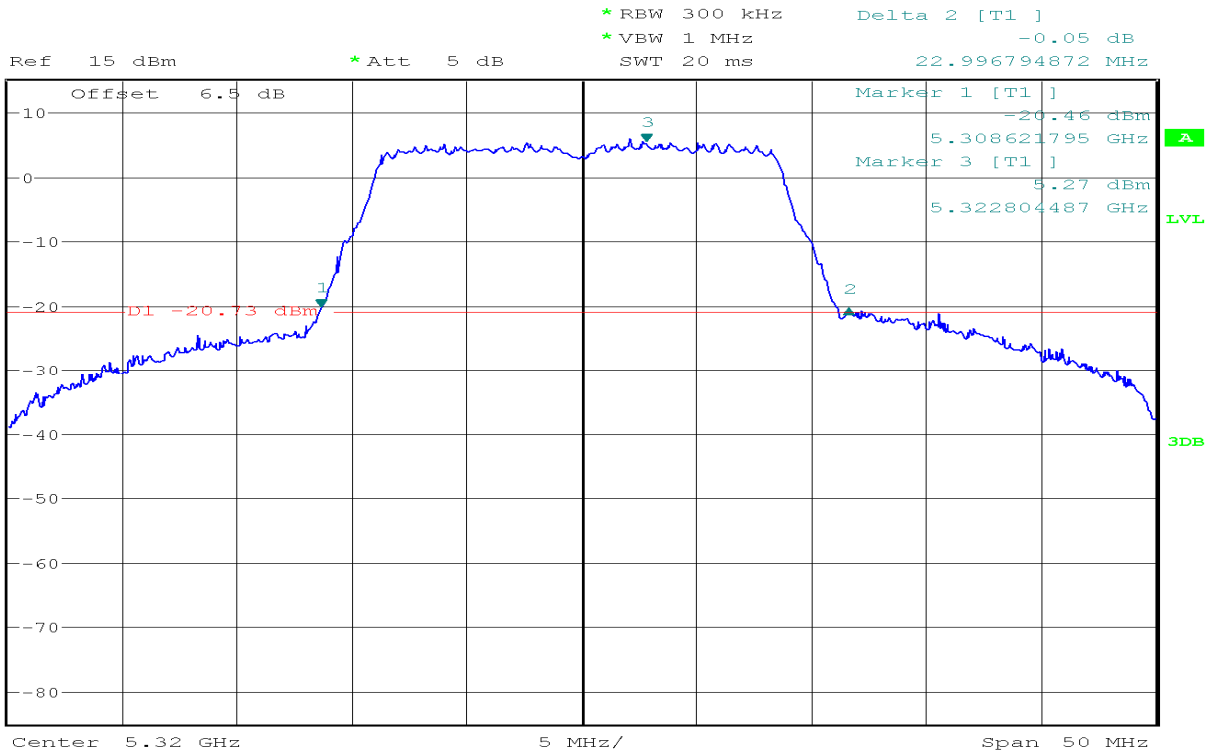

5470~5725MHz

CH Low

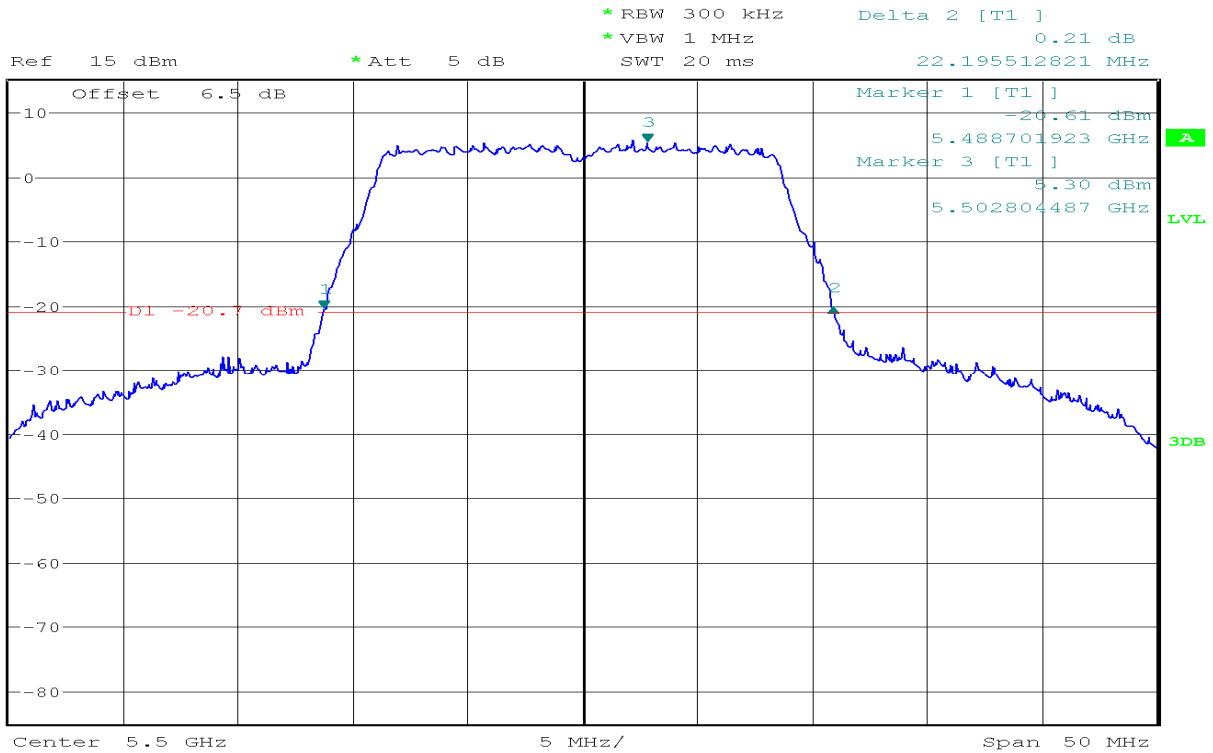

CH Mid

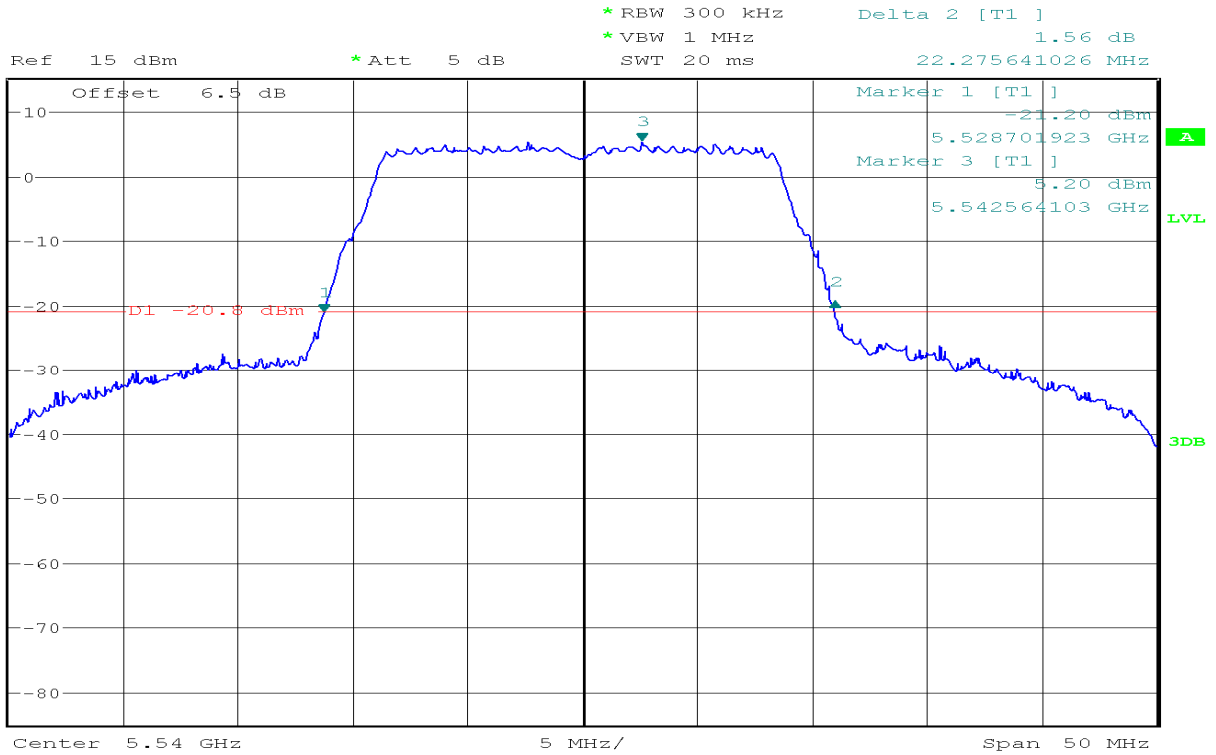

CH High

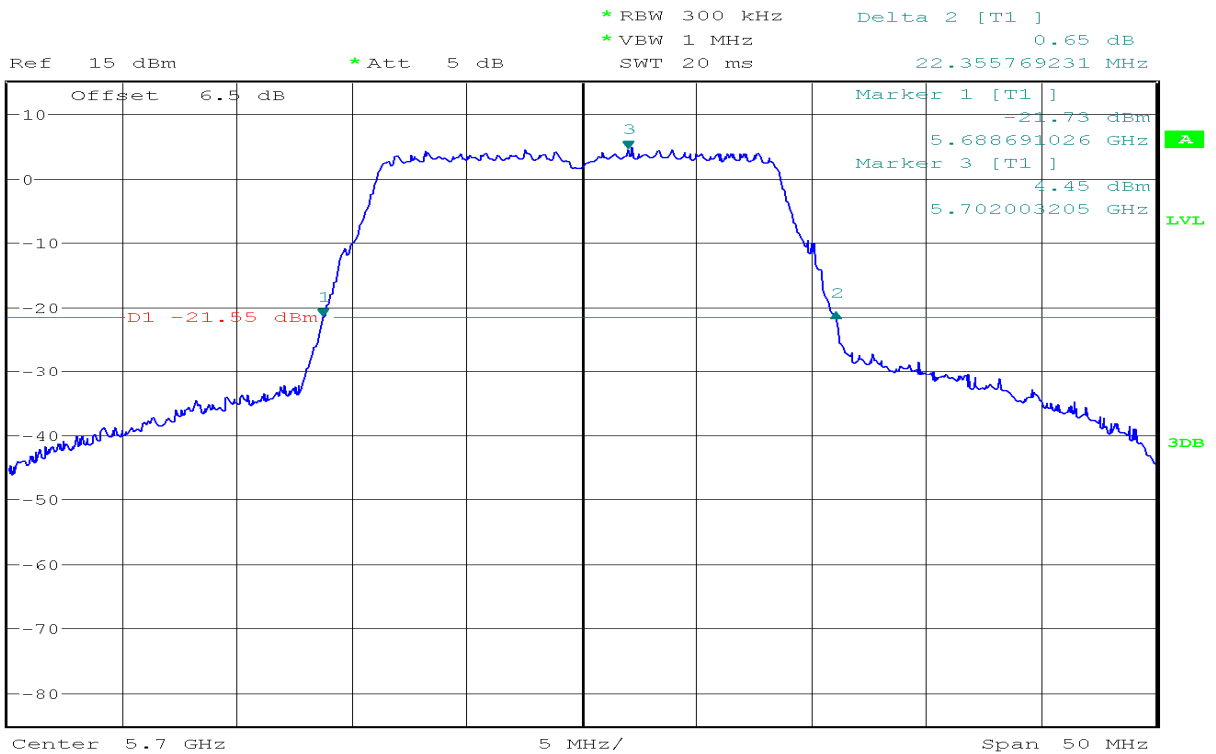

5250~5350MHz

CH Low



Ref 15 dBm * Att 5 dB * RBW 300 kHz Delta 2 [T1] -0.40 dB
 * VBW 1 MHz 40.384615385 MHz
 SWT 20 ms

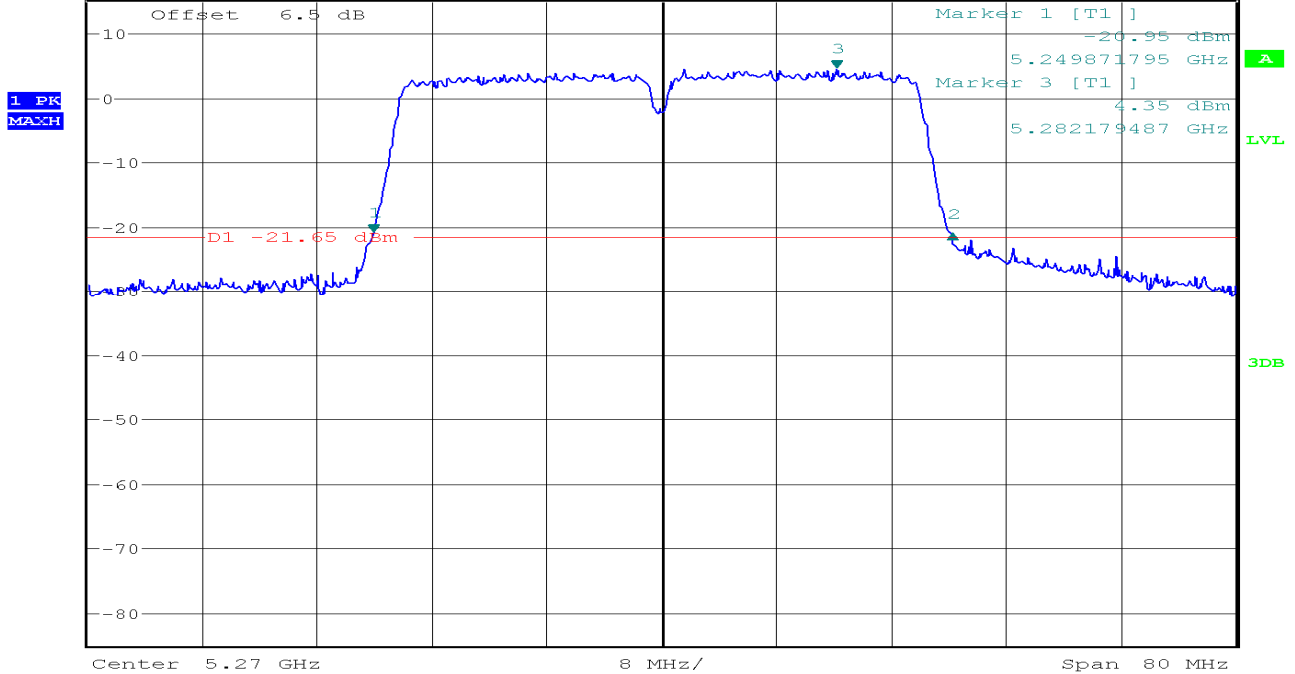

CH High



Ref 15 dBm * Att 5 dB * RBW 300 kHz Delta 2 [T1] 0.05 dB
 * VBW 1 MHz 40.641025641 MHz
 SWT 20 ms

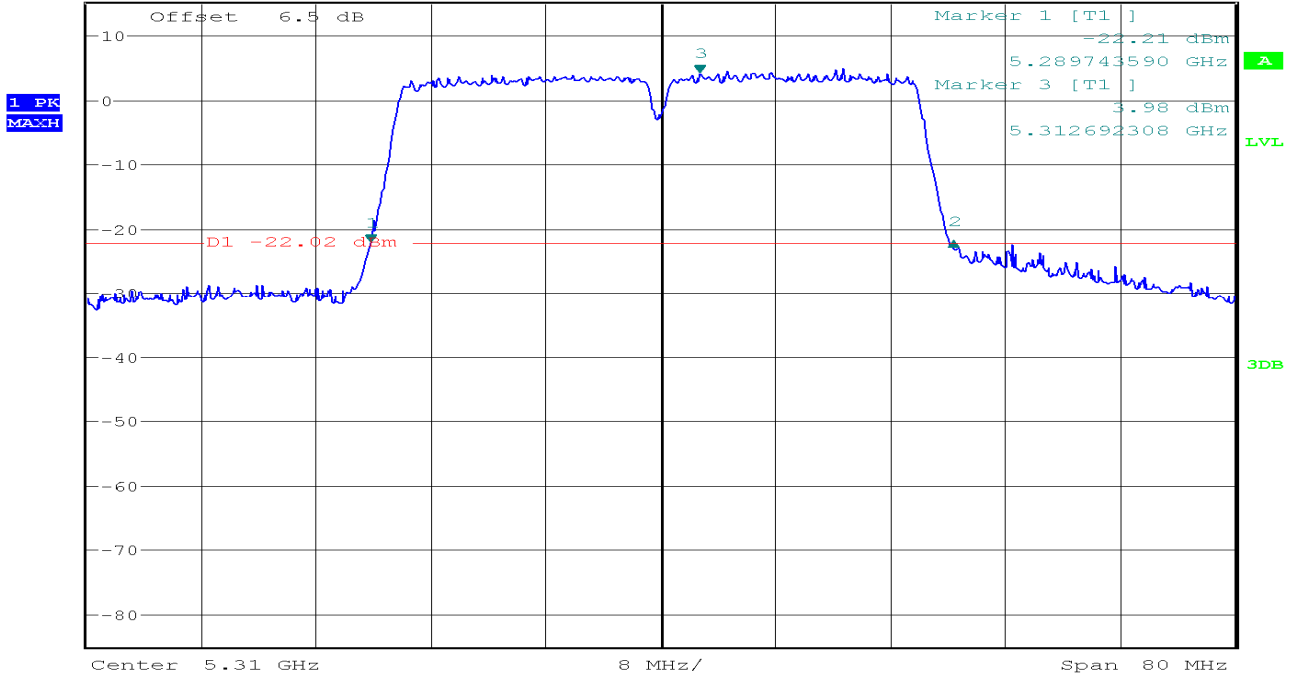

5470~5725MHz

CH Low

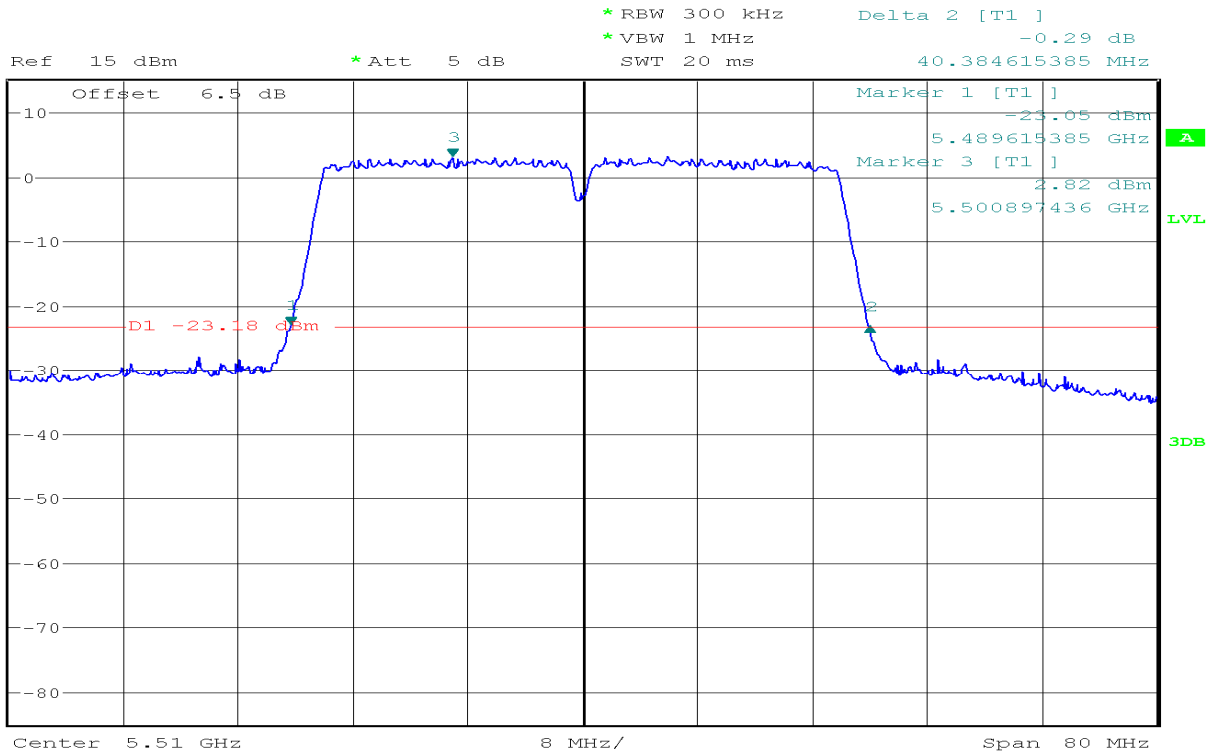

CH Mid

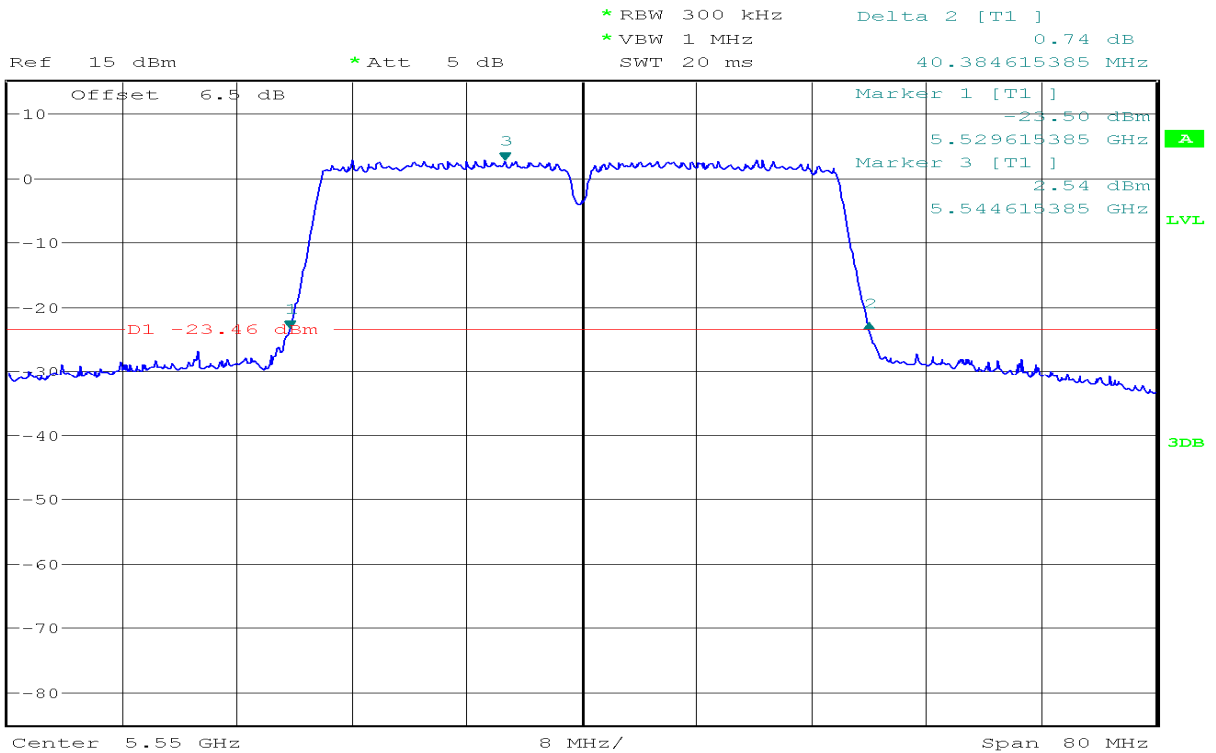

CH High



Ref 15 dBm * Att 5 dB * RBW 300 kHz Delta 2 [T1] 0.55 dB
 * VBW 1 MHz 40.256410256 MHz
 SWT 20 ms

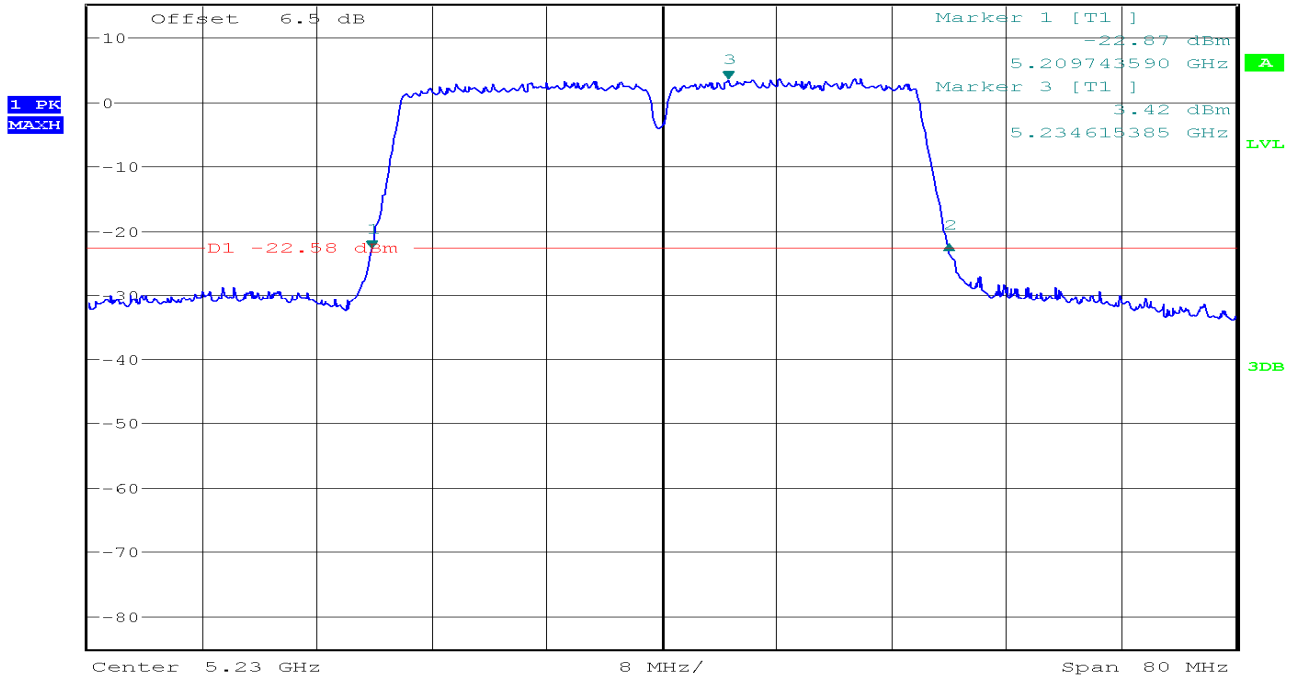

5250~5350MHz

CH Low



Ref 15 dBm * Att 5 dB * RBW 300 kHz Delta 2 [T1] 0.76 dB
 * VBW 1 MHz 40.256410256 MHz
 SWT 20 ms

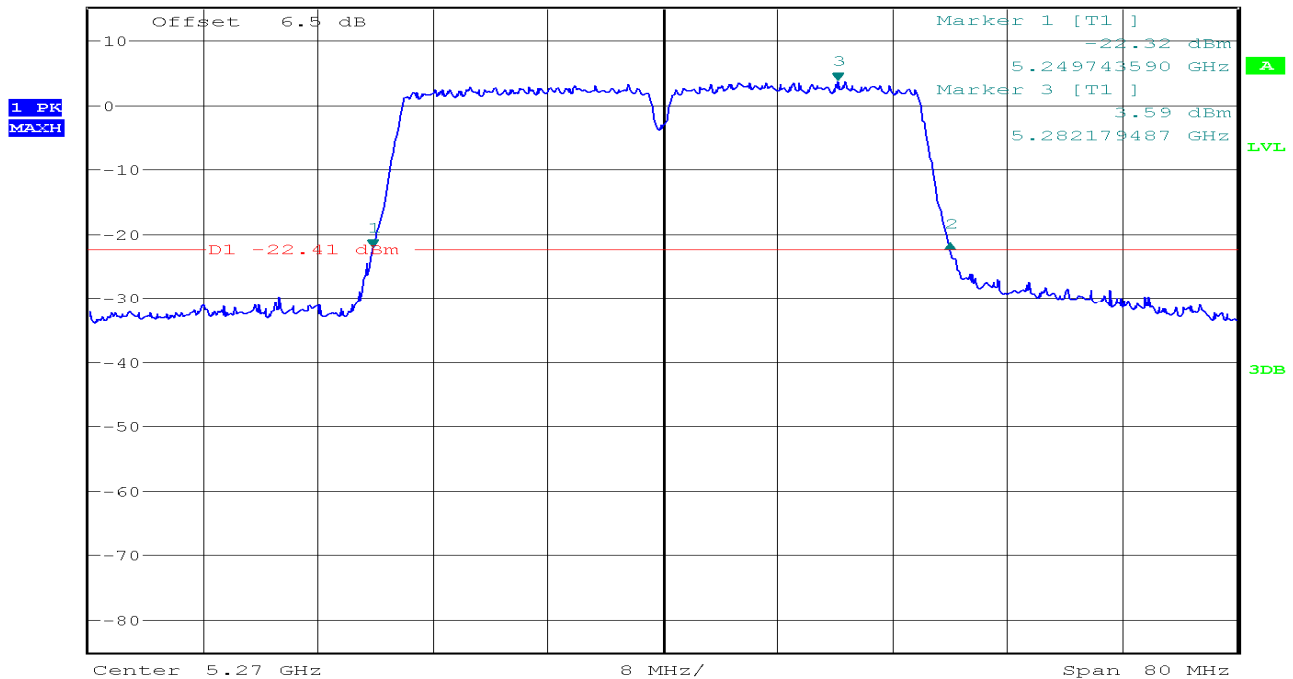

CH High



Ref 15 dBm * Att 5 dB * RBW 300 kHz Delta 2 [T1] 0.01 dB
 * VBW 1 MHz 40.256410256 MHz
 SWT 20 ms

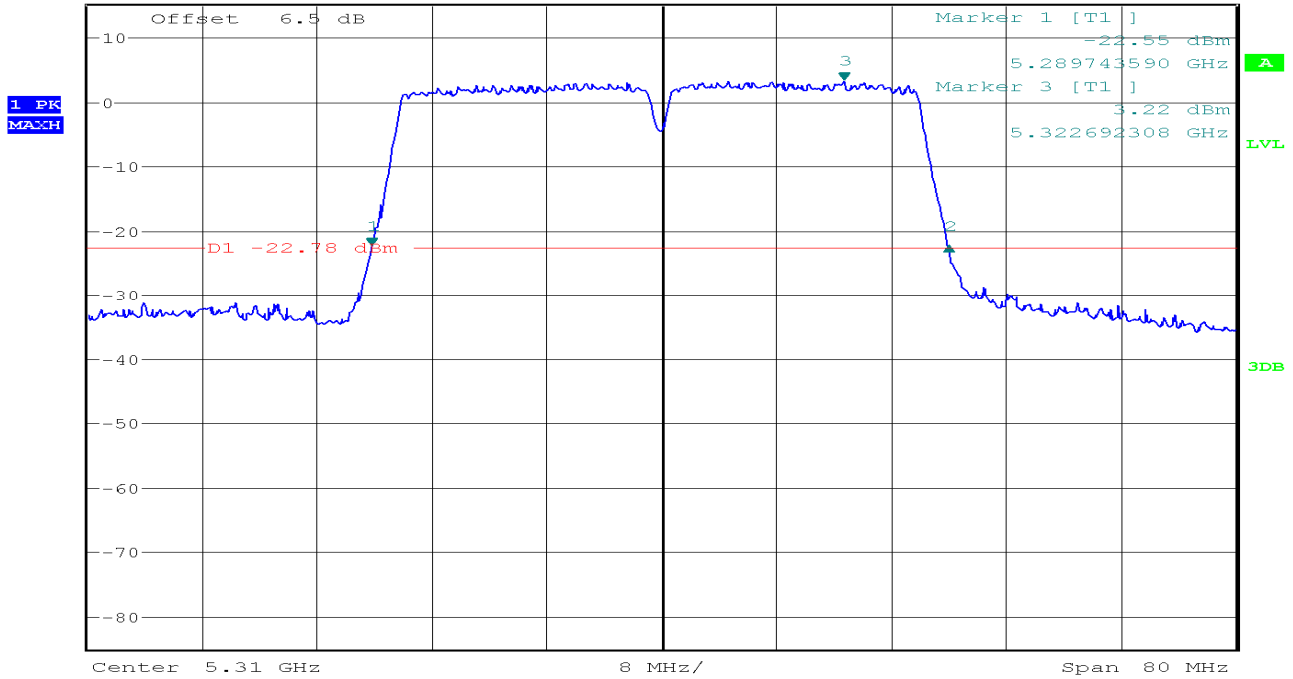

5470~5725MHz

CH Low



Ref 15 dBm * Att 5 dB * RBW 300 kHz Delta 2 [T1] 0.48 dB
 * VBW 1 MHz 40.128205128 MHz
 SWT 20 ms

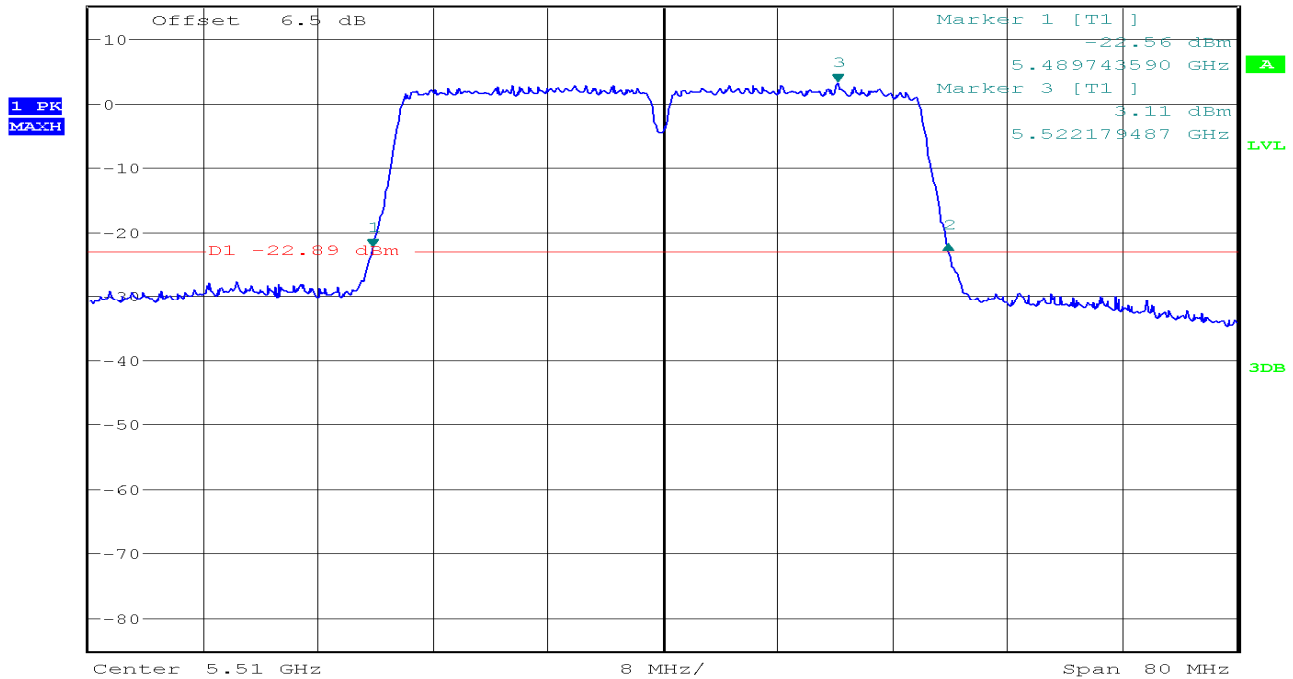

CH Mid



Ref 15 dBm * Att 5 dB * RBW 300 kHz Delta 2 [T1] -0.13 dB
 * VBW 1 MHz 40.384615385 MHz
 SWT 20 ms

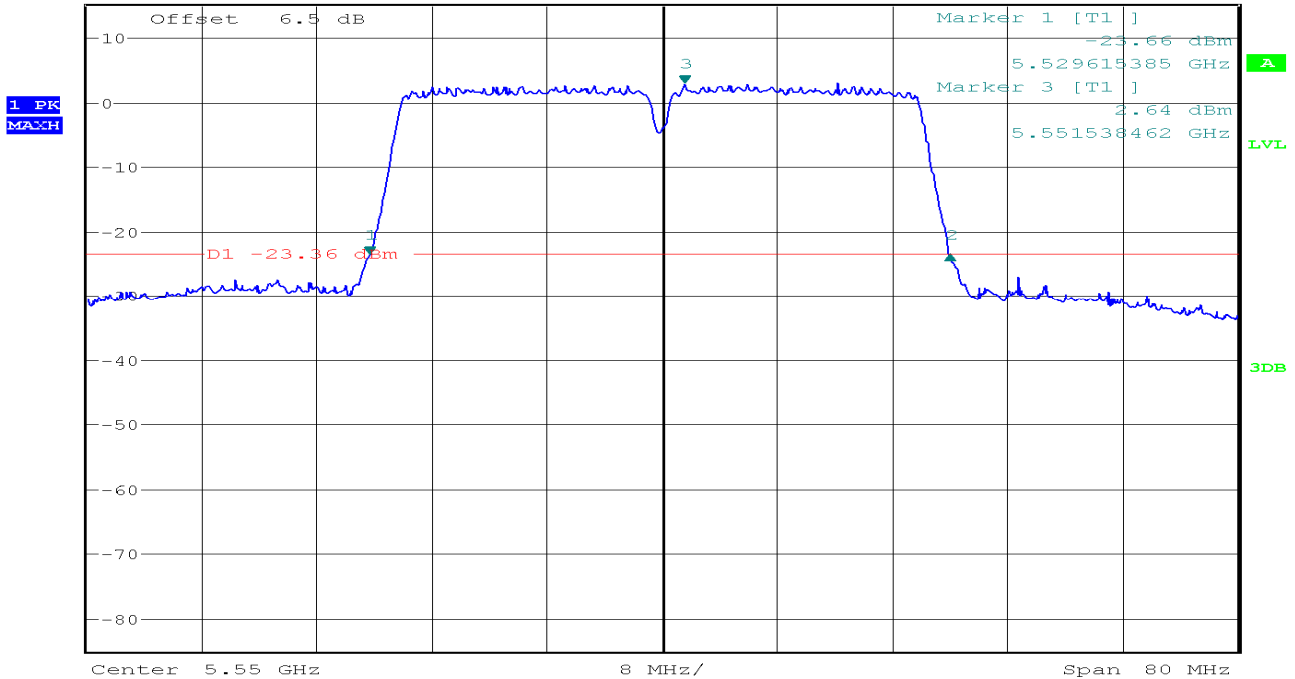

CH High



Ref 15 dBm * Att 5 dB * RBW 300 kHz Delta 2 [T1] 0.49 dB
 * VBW 1 MHz 40.256410256 MHz
 SWT 20 ms

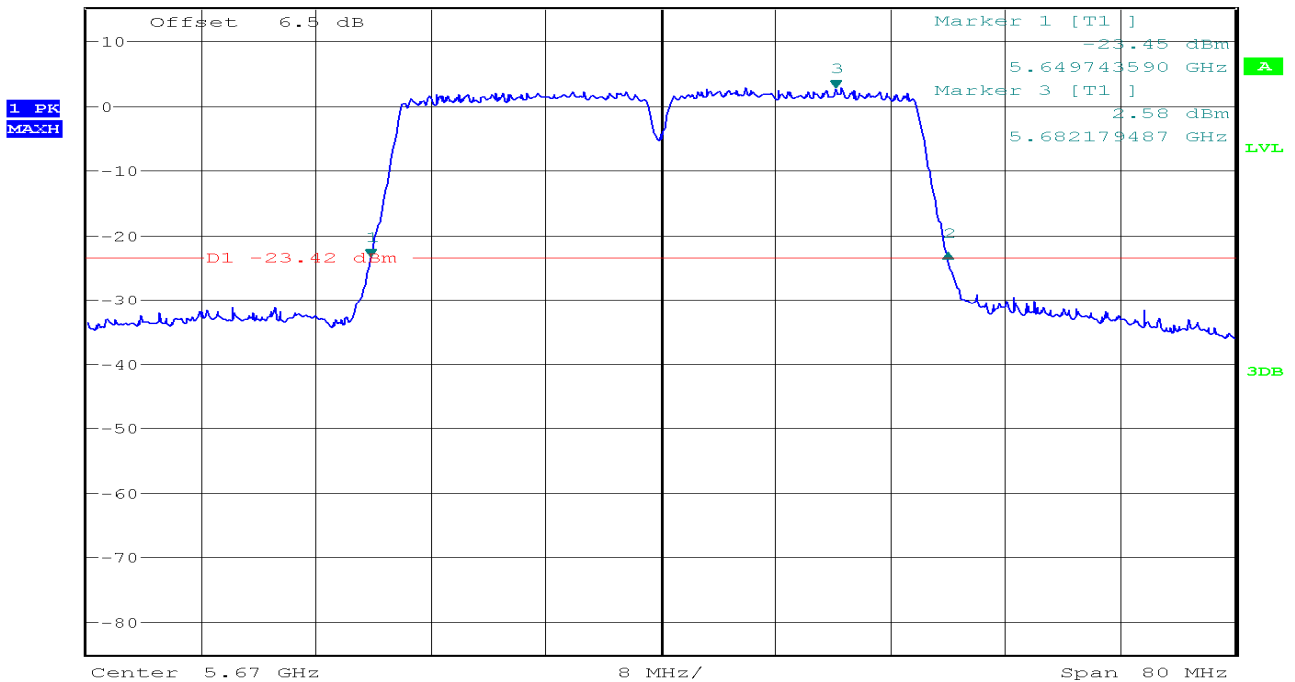

IEEE 802.11ac HT80 mode / Chain 0
5150~5250MHz

CH Mid

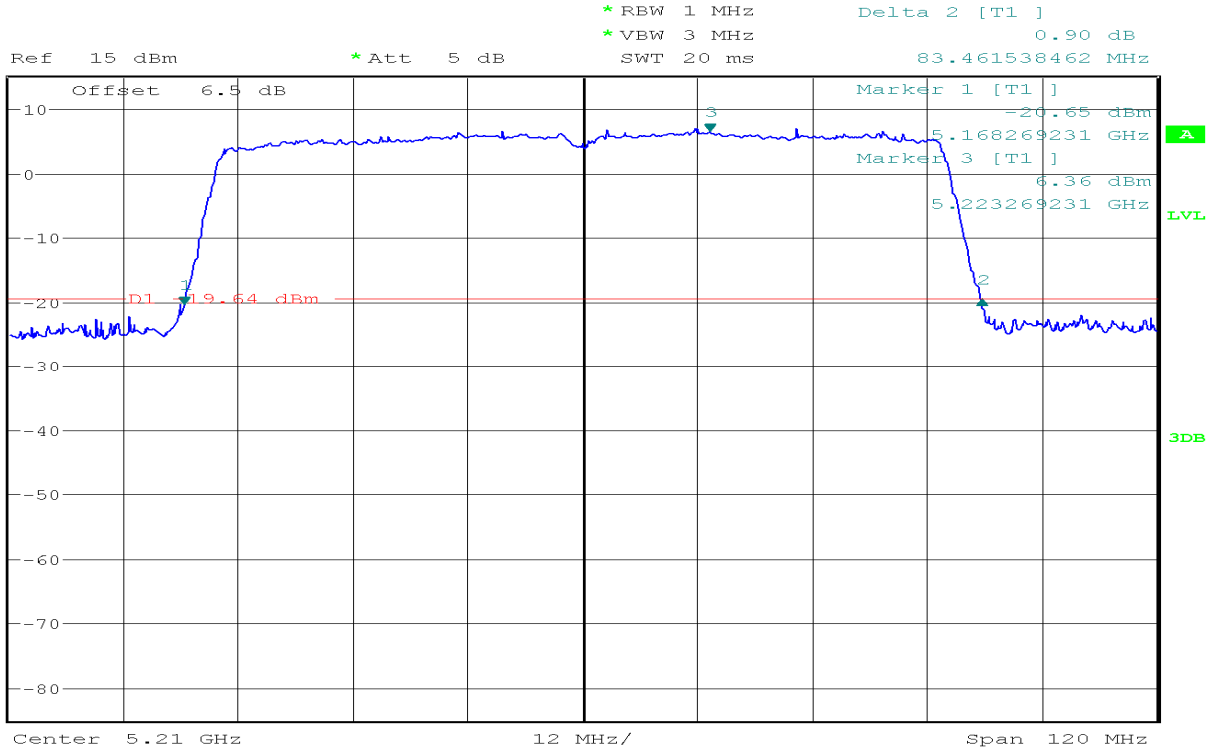

5250~5350MHz

CH Mid

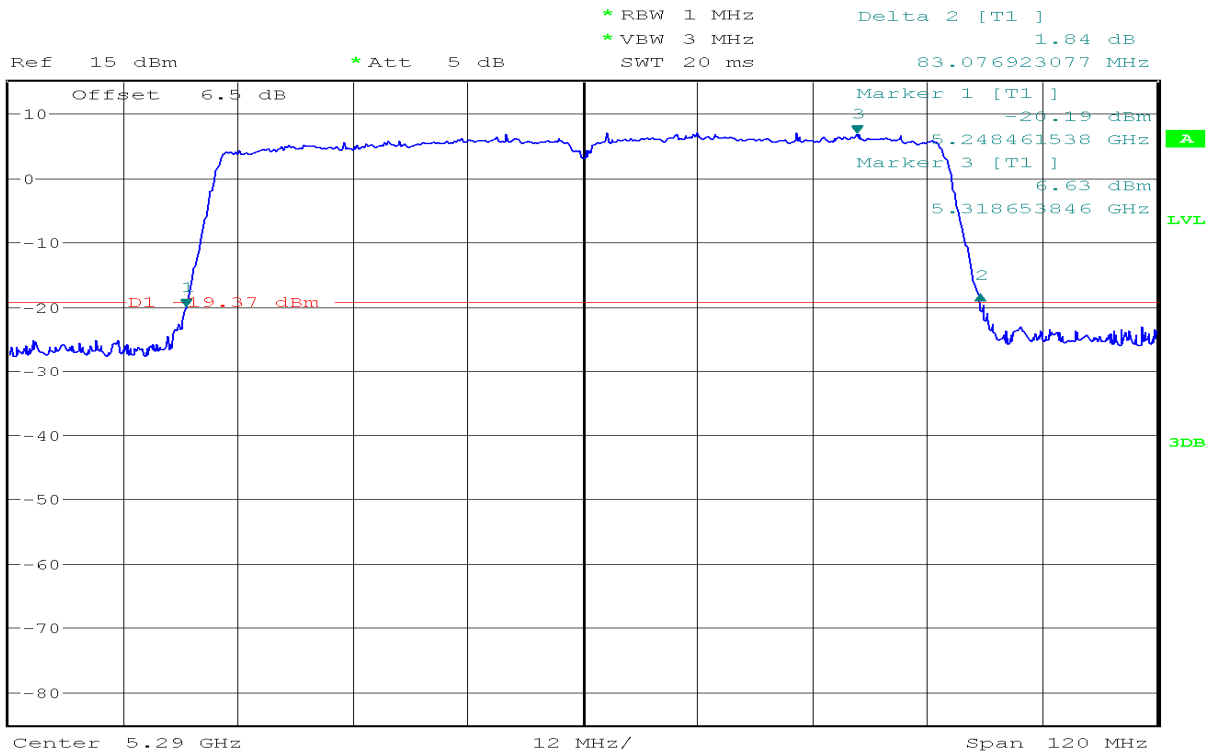

5470~5725MHz

CH Mid



Ref 15 dBm * Att 5 dB * RBW 1 MHz Delta 2 [T1] 0.37 dB
 * VBW 3 MHz 83.076923077 MHz
 SWT 20 ms

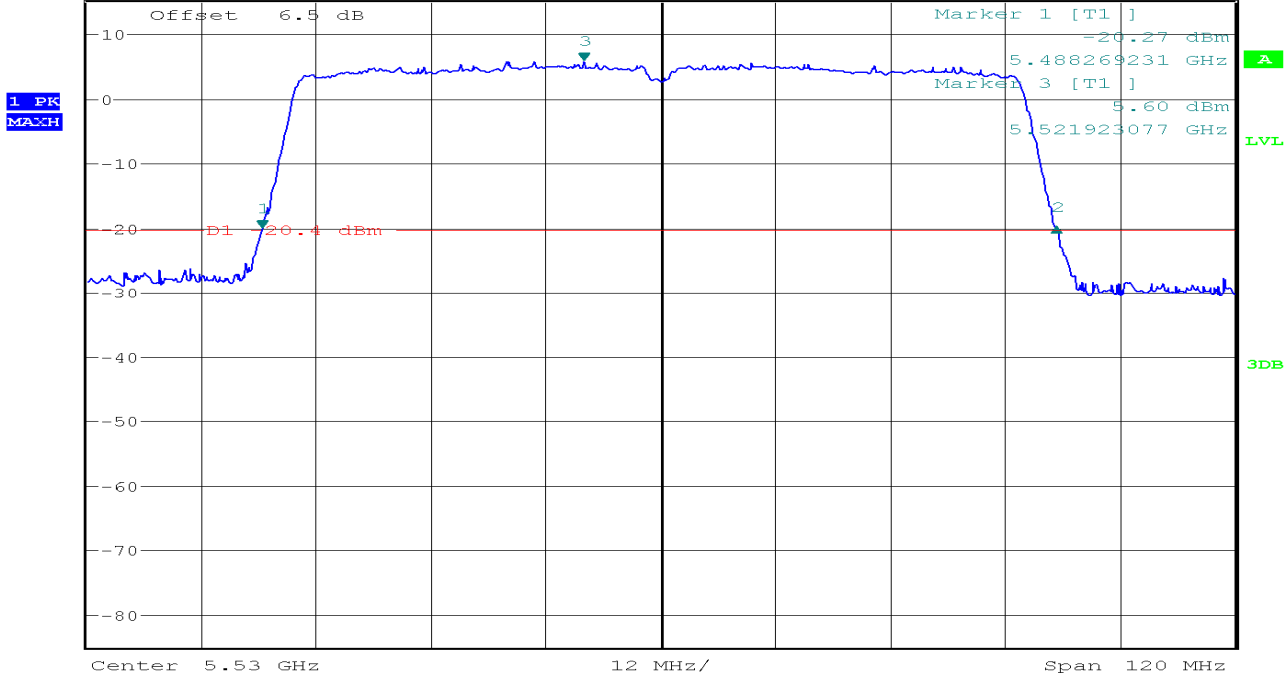

IEEE 802.11ac HT80 mode / Chain 1

5150~5250MHz

CH Mid



Ref 15 dBm * Att 5 dB * RBW 1 MHz Delta 2 [T1] 0.86 dB
 * VBW 3 MHz 83.076923077 MHz
 SWT 20 ms

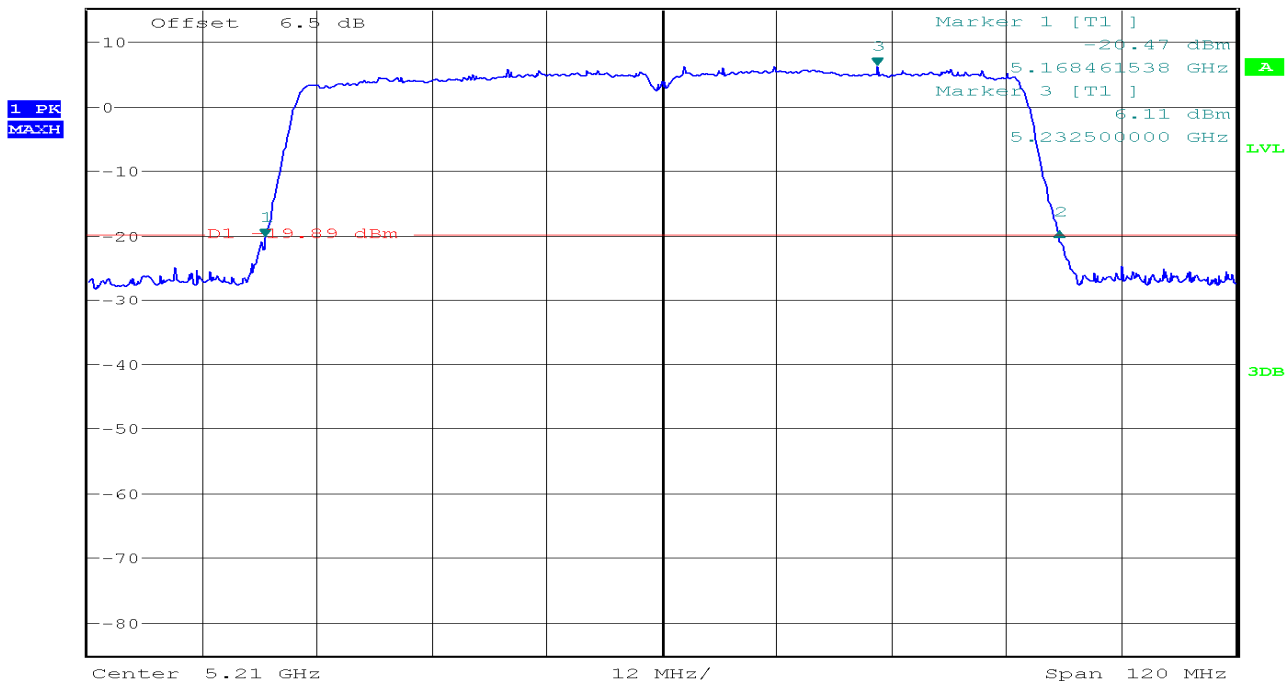

5250~5350MHz

CH Mid

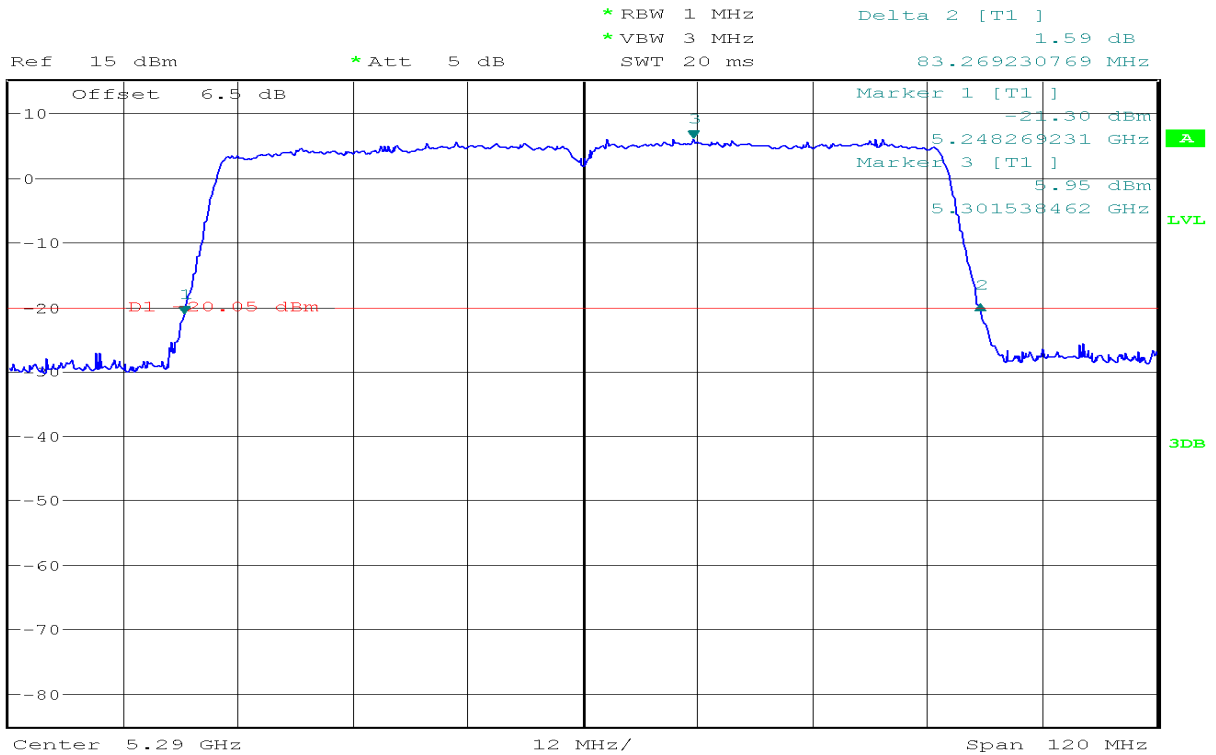

5470~5725MHz

CH Mid

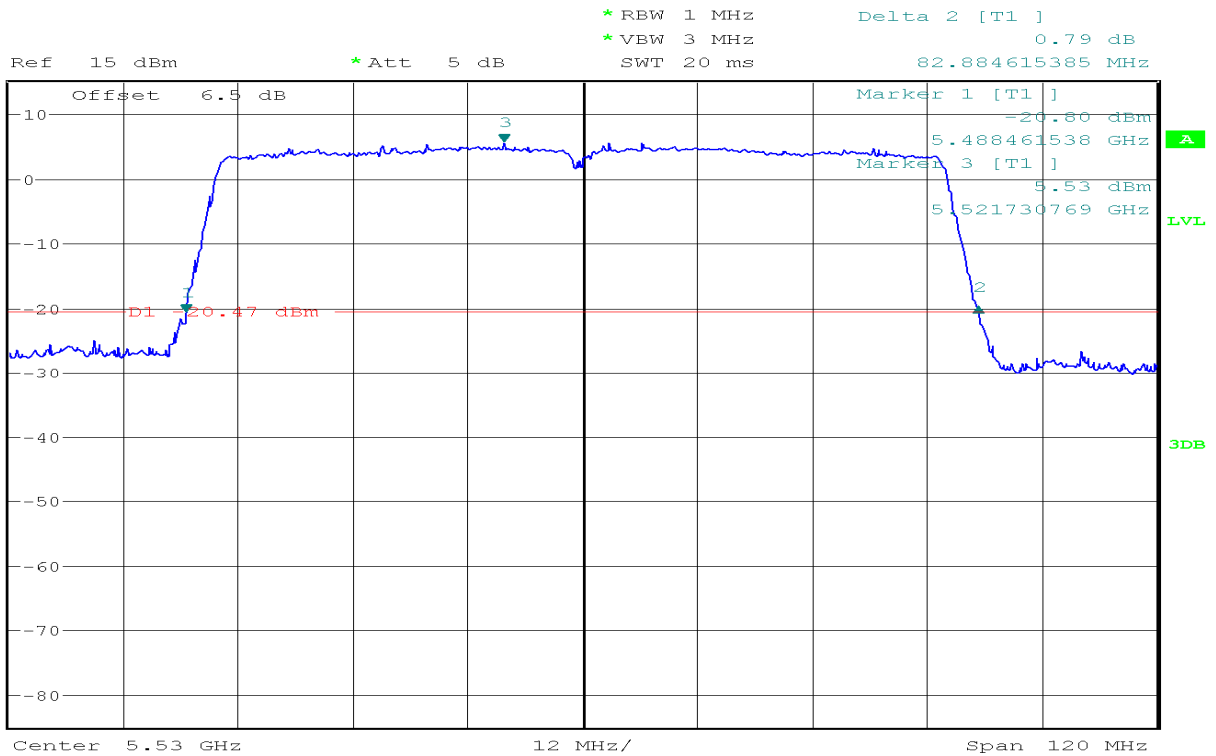

7.2 MAXIMUM CONDUCTED OUTPUT POWER

LIMIT

According to §15.407(a),

(iv) For mobile and portable client devices in the 5.15-5.25 GHz band, the maximum conducted output power over the frequency band of operation shall not exceed 250 mW provided the maximum antenna gain does not exceed 6 dBi.

If transmitting antennas of directional gain greater than 6dBi are used, both the peak transmit power and the peak power spectral density shall be reduced by the amount in dB that the directional gain of the antenna exceeds 6dBi.

EUT with two transmit antennas, each with the same directional gain 3dBi, being driven by two transmitter outputs of equal power. Directional gain is to be computed as follows:

All transmit signals are completely uncorrelated with each other, So directional gain=3dBi<6dBi.

Test Configuration

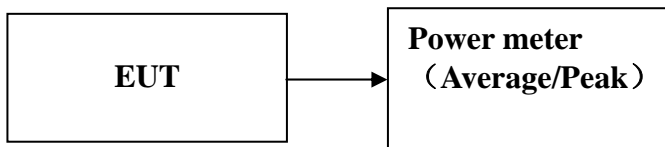

The EUT was connected to a spectrum analyzer through a 50Ω RF cable.

TEST PROCEDURE

The testing follows Method PM of FCC KDB 789033 D02 General UNII Test Procedures New Rules v01.

Method PM (Measurement using an RF average power meter):

1. Measurement is performed using a wideband RF power meter.
2. The EUT is configured to transmit continuously with a consistent duty cycle at its maximum power control level.
3. Measure the average power of the transmitter, and the average power is corrected with duty factor, $10 \log(1/x)$, where x is the duty cycle.

TEST RESULTS

No non-compliance noted

TEST RESULTS

No non-compliance noted

Test Data

Test mode: IEEE 802.11a mode

5150~5250MHz

Channel	Frequency (MHz)	Chain 0 Output Power (dBm)	Chain 1 Output Power (dBm)	Limit (dBm)
Low	5180	14.78	13.72	24.00
Mid	5200	14.79	13.82	24.00
High	5240	14.65	13.57	24.00

5250~5350MHz

Channel	Frequency (MHz)	Chain 0 Output Power (dBm)	Chain 1 Output Power (dBm)	Limit (dBm)
Low	5260	14.70	13.58	24.00
Mid	5300	14.62	13.53	24.00
High	5320	14.57	13.50	24.00

5470~5725MHz

Channel	Frequency (MHz)	Chain 0 Output Power (dBm)	Chain 1 Output Power (dBm)	Limit (dBm)
Low	5500	13.81	13.29	24.00
Mid	5540	13.63	13.24	24.00
High	5700	12.66	12.54	24.00

Test mode: IEEE 802.11n HT20MHz mode

5150~5250MHz

Channel	Frequency (MHz)	Chain 0 Output Power (dBm)	Chain 1 Output Power (dBm)	Total Maximum Conducted Output Power (dBm)	Limit (dBm)
Low	5180	14.62	13.77	17.23	24.00
Mid	5200	14.54	13.71	17.16	24.00
High	5240	14.52	13.63	17.11	24.00

5250~5350MHz

Channel	Frequency (MHz)	Chain 0 Output Power (dBm)	Chain 1 Output Power (dBm)	Total Maximum Conducted Output Power (dBm)	Limit (dBm)
Low	5260	14.43	13.40	16.96	24.00
Mid	5300	14.33	13.37	16.89	24.00
High	5320	14.37	13.29	16.87	24.00

5470~5725MHz

Channel	Frequency (MHz)	Chain 0 Output Power (dBm)	Chain 1 Output Power (dBm)	Total Maximum Conducted Output Power (dBm)	Limit (dBm)
Low	5500	13.63	13.21	16.44	24.00
Mid	5540	13.48	13.17	16.34	24.00
High	5700	12.38	12.65	15.53	24.00

Test mode: IEEE 802.11n HT40MHz mode

5150~5250MHz

Channel	Frequency (MHz)	Chain 0 Output Power (dBm)	Chain 1 Output Power (dBm)	Total Maximum Conducted Output Power (dBm)	Limit (dBm)
Low	5190	15.14	14.41	17.80	24.00
High	5230	15.10	14.11	17.64	24.00

5250~5350MHz

Channel	Frequency (MHz)	Chain 0 Output Power (dBm)	Chain 1 Output Power (dBm)	Total Maximum Conducted Output Power (dBm)	Limit (dBm)
Low	5270	15.13	14.10	17.66	24.00
High	5310	15.07	14.12	17.63	24.00

5470~5725MHz

Channel	Frequency (MHz)	Chain 0 Output Power (dBm)	Chain 1 Output Power (dBm)	Total Maximum Conducted Output Power (dBm)	Limit (dBm)
Low	5510	14.23	13.93	17.09	24.00
Mid	5550	13.97	13.79	16.89	24.00
High	5670	13.16	13.29	16.24	24.00

**Test mode: IEEE 802.11ac HT20MHz mode
5150~5250MHz**

Channel	Frequency (MHz)	Chain 0 Output Power (dBm)	Chain 1 Output Power (dBm)	Limit (dBm)
Low	5180	14.68	13.64	24.00
Mid	5200	14.64	13.76	24.00
High	5240	14.47	13.69	24.00

5250~5350MHz

Channel	Frequency (MHz)	Chain 0 Output Power (dBm)	Chain 1 Output Power (dBm)	Limit (dBm)
Low	5260	14.55	13.55	24.00
Mid	5300	14.32	13.41	24.00
High	5320	14.40	13.33	24.00

5470~5725MHz

Channel	Frequency (MHz)	Chain 0 Output Power (dBm)	Chain 1 Output Power (dBm)	Limit (dBm)
Low	5500	13.57	13.37	24.00
Mid	5540	13.39	13.08	24.00
High	5700	12.45	12.74	24.00

**Test mode: IEEE 802.11ac HT40MHz mode
5150~5250MHz**

Channel	Frequency (MHz)	Chain 0 Output Power (dBm)	Chain 1 Output Power (dBm)	Limit (dBm)
Low	5190	15.35	14.45	24.00
High	5230	15.19	14.35	24.00

5250~5350MHz

Channel	Frequency (MHz)	Chain 0 Output Power (dBm)	Chain 1 Output Power (dBm)	Limit (dBm)
Low	5270	15.12	14.19	24.00
High	5310	15.08	14.21	24.00

5470~5725MHz

Channel	Frequency (MHz)	Chain 0 Output Power (dBm)	Chain 1 Output Power (dBm)	Limit (dBm)
Low	5510	14.20	13.90	24.00
Mid	5550	13.94	13.23	24.00
High	5670	13.29	13.13	24.00

Test mode: IEEE 802.11ac HT80MHz mode

5150~5250MHz

Channel	Frequency (MHz)	Chain 0 Output Power (dBm)	Chain 1 Output Power (dBm)	Limit (dBm)
Mid	5210	14.35	13.56	24.00

5250~5350MHz

Channel	Frequency (MHz)	Chain 0 Output Power (dBm)	Chain 1 Output Power (dBm)	Limit (dBm)
Mid	5290	14.19	13.40	24.00

5470~5725MHz

Channel	Frequency (MHz)	Chain 0 Output Power (dBm)	Chain 1 Output Power (dBm)	Limit (dBm)
Mid	5530	13.15	12.97	24.00

Note:Duty factor has been offsetted with cableloss

Remark: Total Output Power (dBm) = 10*LOG(10^(Chain 0 Output Power / 10)+10^(Chain 1 Output Power /10))

7.3 BAND EDGES MEASUREMENT

LIMIT

According to §15.407(b),

- (1) The provisions of Section 15.205 of this part apply to intentional radiators operating under this section.
- (2) When measuring the emission limits, the nominal carrier frequency shall be adjusted as close to the upper and lower frequency block edges as the design of the equipment permits.

Test Configuration

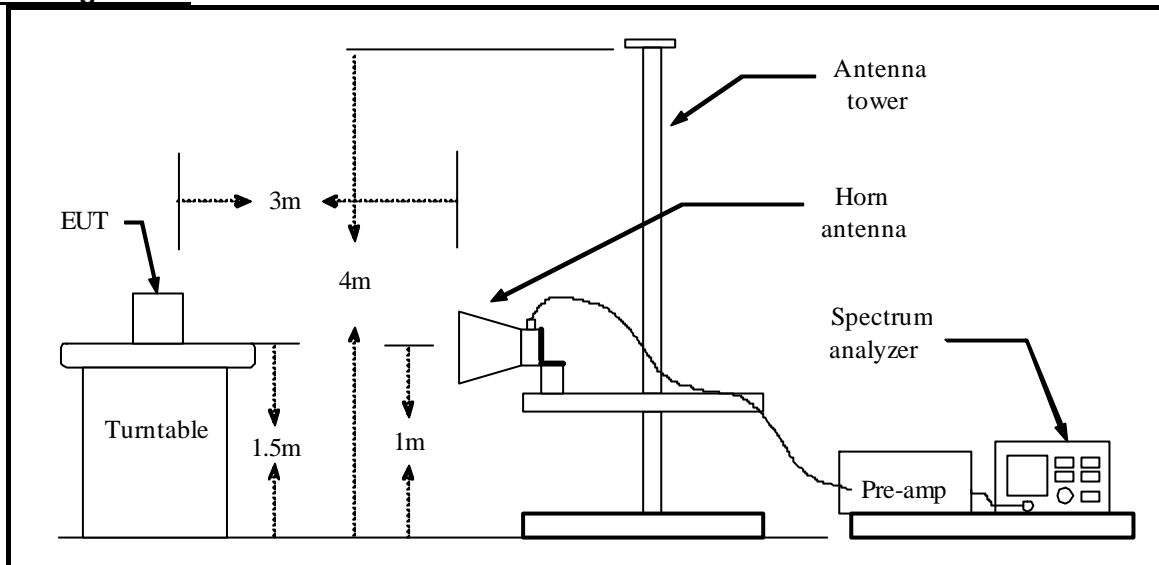

TEST PROCEDURE

1. The EUT is placed on a turntable, which is 1.5m above the ground plane.
2. The turntable shall be rotated for 360 degrees to determine the position of maximum emission level.
3. EUT is set 3m away from the receiving antenna, which is varied from 1m to 4m to find out the highest emission.
4. Set the spectrum analyzer in the following setting in order to capture the lower and upper band-edges of the emission:
 - (a) PEAK: RBW=VBW=1MHz / Sweep=AUTO
 - (b) AVERAGE: RBW=1MHz / VBW=10Hz / Sweep=AUTO

TEST RESULTS

Refer to attach spectrum analyzer data chart.

Band Edges (IEEE 802.11a mode)

5180MHz

Polarity: Vertical

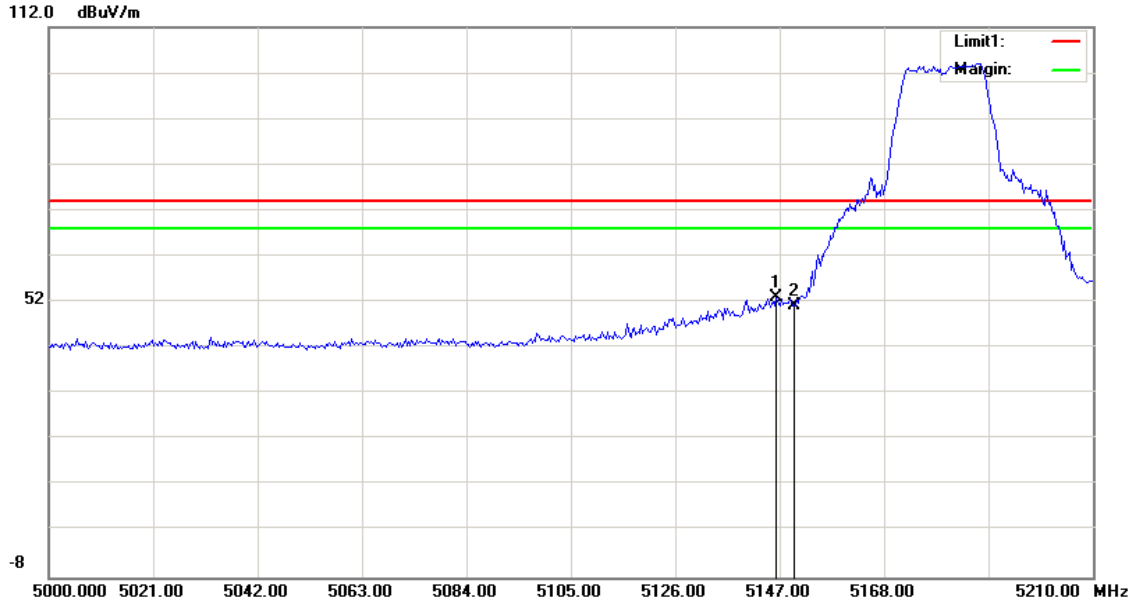

No.	Frequency (MHz)	Reading (dBuV)	Correct Factor(dB/m)	Result (dBuV/m)	Limit (dBuV/m)	Margin (dB)	Height (cm)	Degree (deg.)	Remark
1	5146.394	54.83	-1.79	53.04	74.00	-20.96	100	57	peak
2	5150.000	52.94	-1.78	51.16	74.00	-22.84	100	348	peak

Polarity: Horizontal

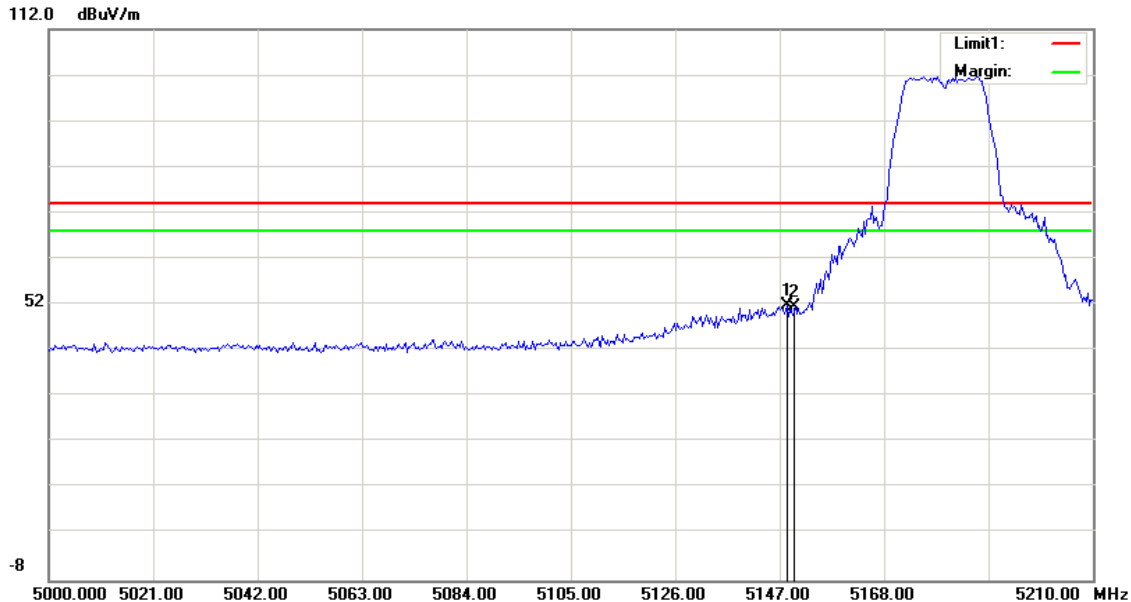

No.	Frequency (MHz)	Reading (dBuV)	Correct Factor(dB/m)	Result (dBuV/m)	Limit (dBuV/m)	Margin (dB)	Height (cm)	Degree (deg.)	Remark
1	5148.413	53.55	-1.78	51.77	74.00	-22.23	100	30	peak
2	5150.000	53.43	-1.78	51.65	74.00	-22.35	100	30	peak

5320MHz

Polarity: Vertical

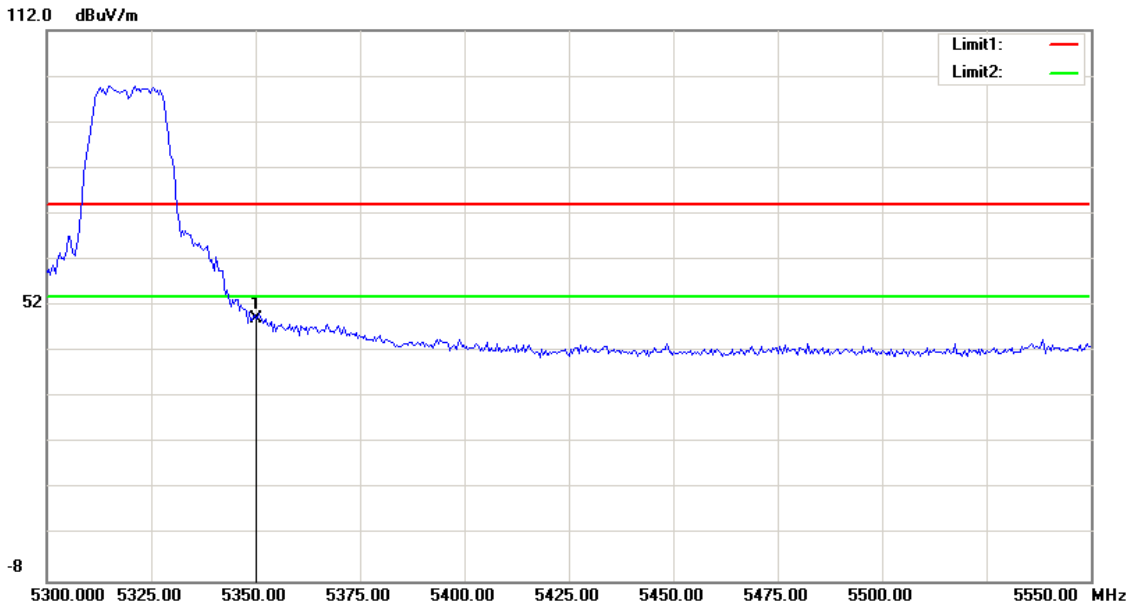

No.	Frequency (MHz)	Reading (dBuV)	Correct Factor(dB/m)	Result (dBuV/m)	Limit (dBuV/m)	Margin (dB)	Height (cm)	Degree (deg.)	Remark
1	5350.000	51.67	-2.50	49.17	74.00	-24.83	100	208	peak

Polarity: Horizontal

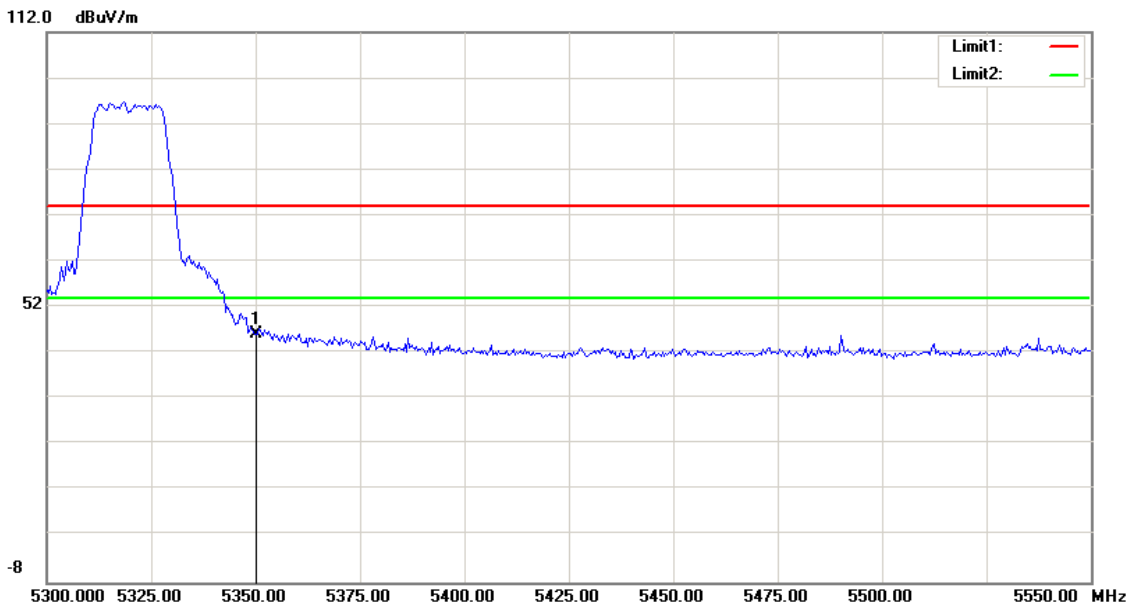

No.	Frequency (MHz)	Reading (dBuV)	Correct Factor(dB/m)	Result (dBuV/m)	Limit (dBuV/m)	Margin (dB)	Height (cm)	Degree (deg.)	Remark
1	5350.000	48.54	-2.50	46.04	74.00	-27.96	100	118	peak

5500MHz

Polarity: Vertical

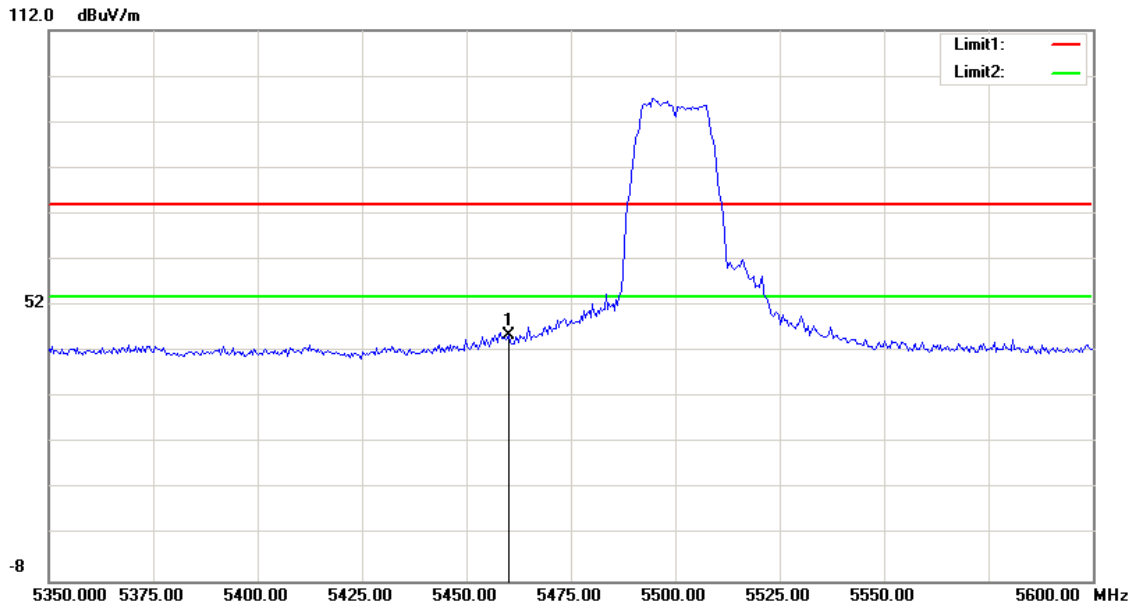

No.	Frequency (MHz)	Reading (dBuV)	Correct Factor(dB/m)	Result (dBuV/m)	Limit (dBuV/m)	Margin (dB)	Height (cm)	Degree (deg.)	Remark
1	5460.000	47.99	-2.36	45.63	74.00	-28.37	100	235	peak

Polarity: Horizontal

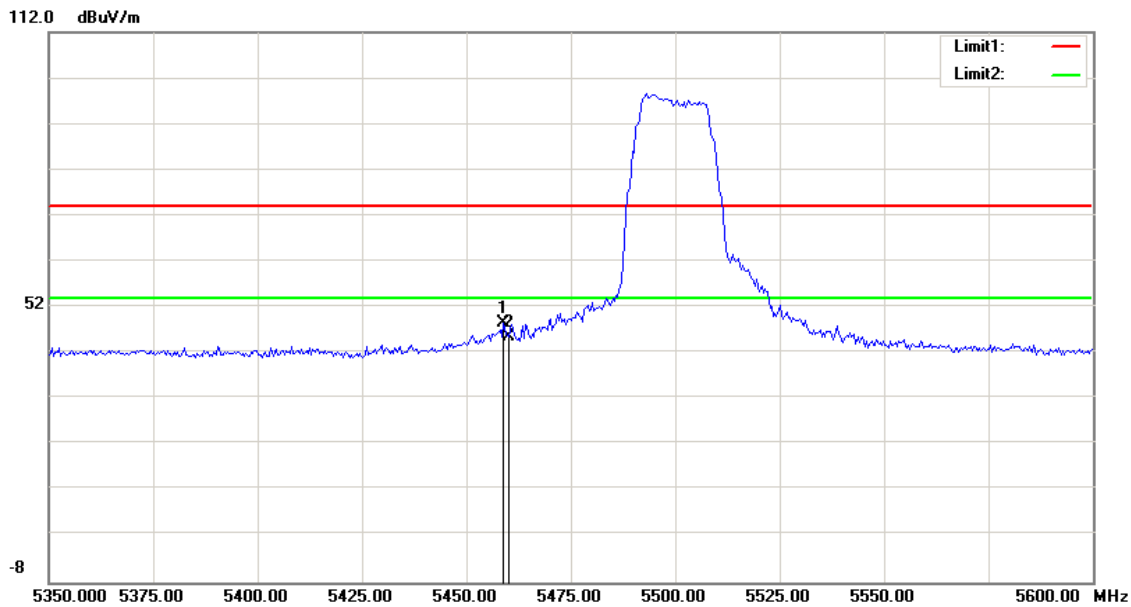

No.	Frequency (MHz)	Reading (dBuV)	Correct Factor(dB/m)	Result (dBuV/m)	Limit (dBuV/m)	Margin (dB)	Height (cm)	Degree (deg.)	Remark
1	5458.974	50.93	-2.36	48.57	74.00	-25.43	100	145	peak
2	5460.000	48.01	-2.36	45.65	74.00	-28.35	100	227	peak

Band Edges (IEEE 802.11n HT20 mode)

5180MHz

Polarity: Vertical

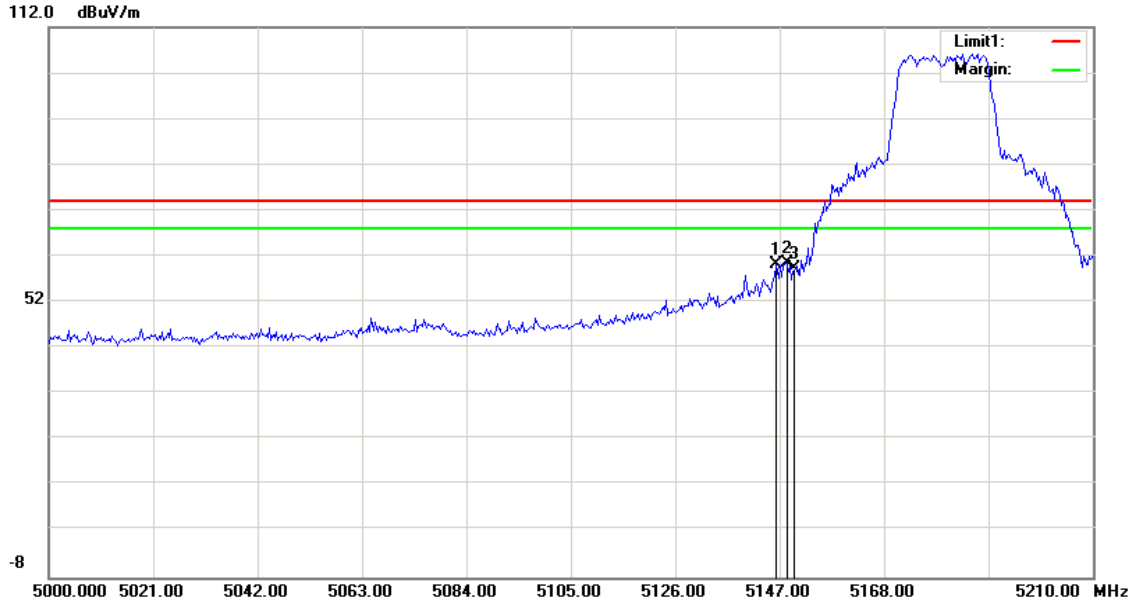

No.	Frequency (MHz)	Reading (dBuV)	Correct Factor(dB/m)	Result (dBuV/m)	Limit (dBuV/m)	Margin (dB)	Height (cm)	Degree (deg.)	Remark
1	5146.394	62.17	-1.79	60.38	74.00	-13.62	100	7	peak
2	5148.413	62.25	-1.78	60.47	74.00	-13.53	100	14	peak
3	5150.000	61.20	-1.78	59.42	74.00	-14.58	100	8	peak

Polarity: Horizontal

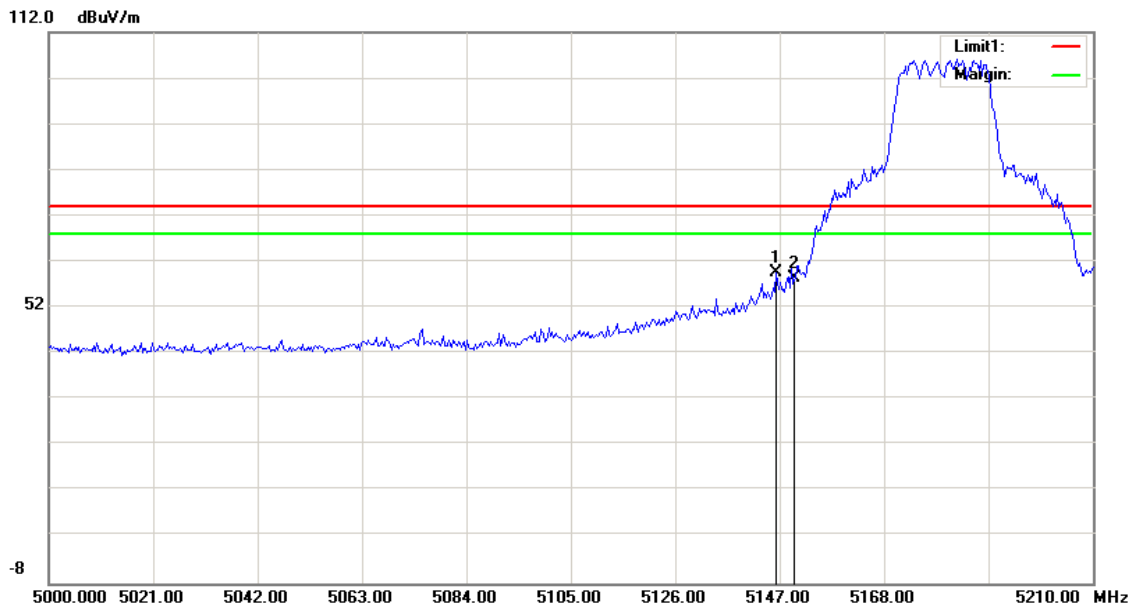

No.	Frequency (MHz)	Reading (dBuV)	Correct Factor(dB/m)	Result (dBuV/m)	Limit (dBuV/m)	Margin (dB)	Height (cm)	Degree (deg.)	Remark
1	5146.394	61.42	-1.79	59.63	74.00	-14.37	100	29	peak
2	5150.000	60.16	-1.78	58.38	74.00	-15.62	100	28	peak

5320MHz

Polarity: Vertical

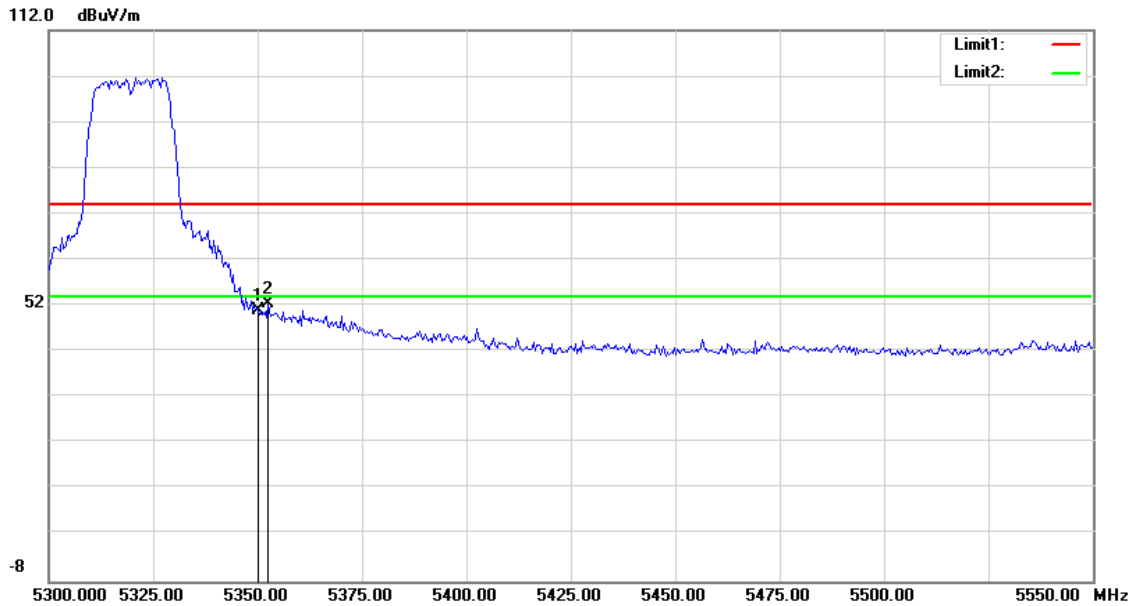

No.	Frequency (MHz)	Reading (dBuV)	Correct Factor(dB/m)	Result (dBuV/m)	Limit (dBuV/m)	Margin (dB)	Height (cm)	Degree (deg.)	Remark
1	5350.000	53.38	-2.50	50.88	74.00	-23.12	100	213	peak
2	5352.484	54.92	-2.50	52.42	74.00	-21.58	100	209	peak

Polarity: Horizontal

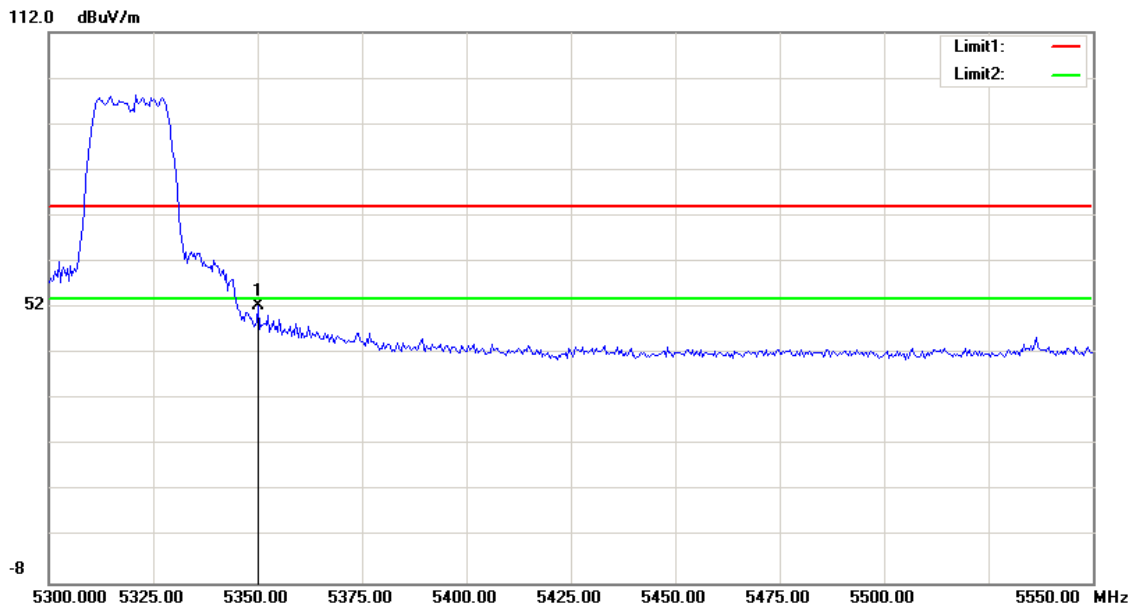

No.	Frequency (MHz)	Reading (dBuV)	Correct Factor(dB/m)	Result (dBuV/m)	Limit (dBuV/m)	Margin (dB)	Height (cm)	Degree (deg.)	Remark
1	5350.000	54.88	-2.50	52.38	74.00	-21.62	100	129	peak

5500MHz

Polarity: Vertical

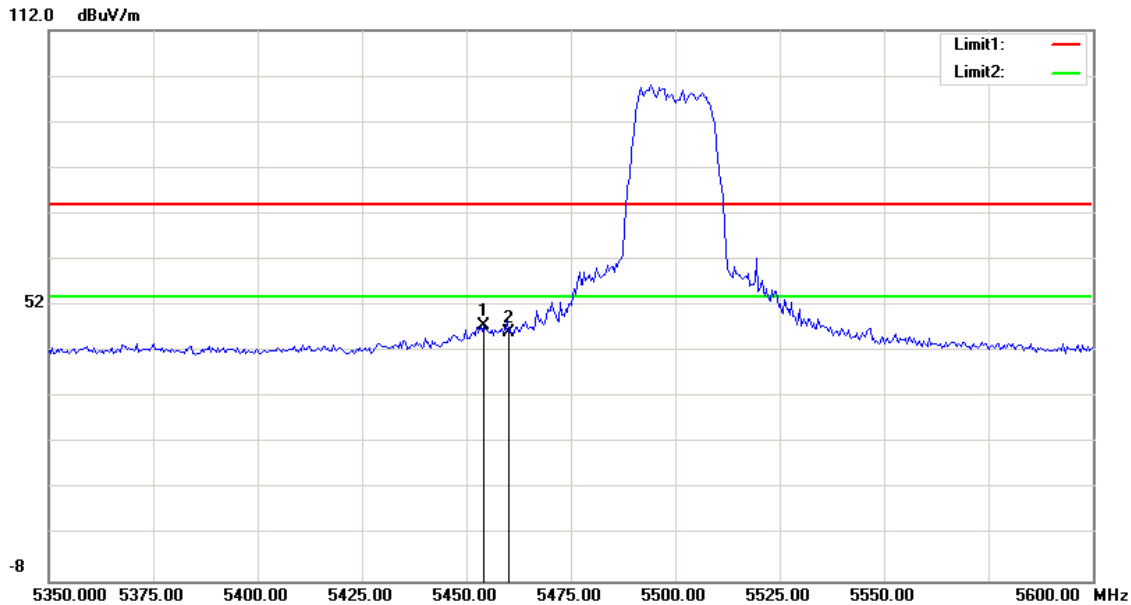

No.	Frequency (MHz)	Reading (dBuV)	Correct Factor(dB/m)	Result (dBuV/m)	Limit (dBuV/m)	Margin (dB)	Height (cm)	Degree (deg.)	Remark
1	5454.167	50.03	-2.36	47.67	74.00	-26.33	100	161	peak
2	5460.000	48.38	-2.36	46.02	74.00	-27.98	100	159	peak

Polarity: Horizontal

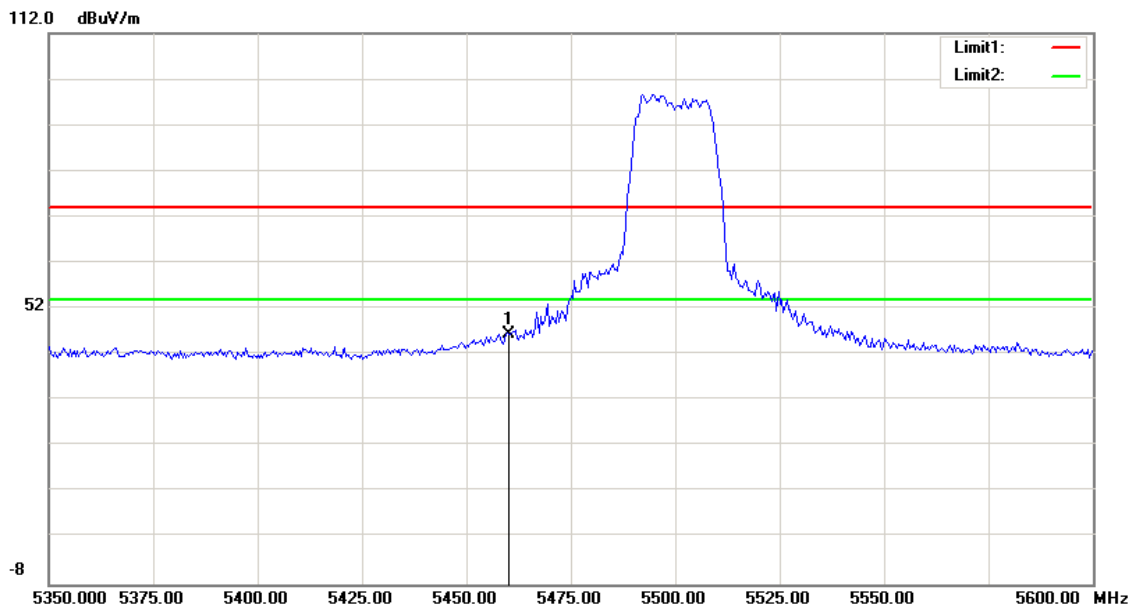

No.	Frequency (MHz)	Reading (dBuV)	Correct Factor(dB/m)	Result (dBuV/m)	Limit (dBuV/m)	Margin (dB)	Height (cm)	Degree (deg.)	Remark
1	5460.000	48.67	-2.36	46.31	74.00	-27.69	100	133	peak

Band Edges (IEEE 802.11n HT40 mode)

5190MHz

Polarity: Vertical

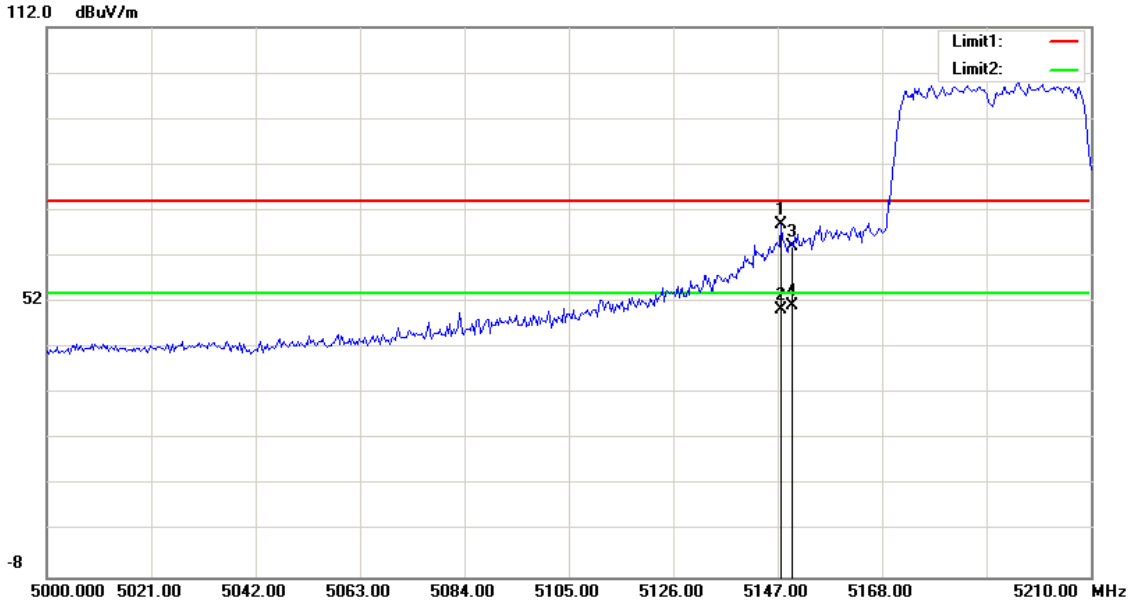

No.	Frequency (MHz)	Reading (dBuV)	Correct Factor(dB/m)	Result (dBuV/m)	Limit (dBuV/m)	Margin (dB)	Height (cm)	Degree (deg.)	Remark
1	5147.740	71.74	-2.76	68.98	74.00	-5.02	100	167	peak
2	5147.740	53.00	-2.76	50.24	54.00	-3.76	100	167	AVG
3	5150.000	66.93	-2.76	64.17	74.00	-9.83	100	166	peak
4	5150.000	54.16	-2.76	51.40	54.00	-2.60	100	166	AVG

Polarity: Horizontal

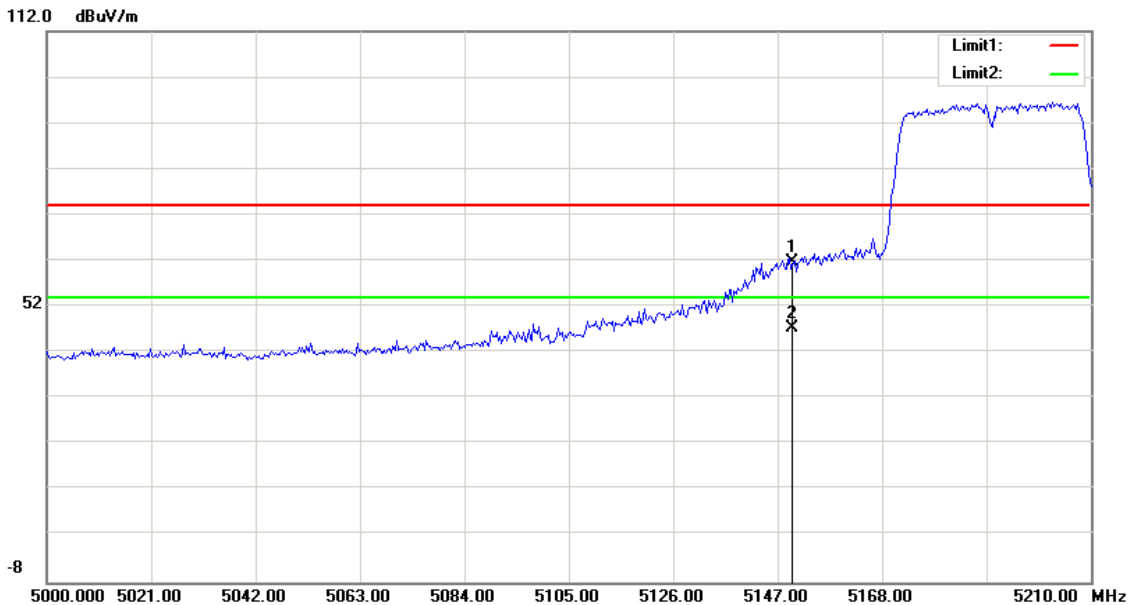

No.	Frequency (MHz)	Reading (dBuV)	Correct Factor(dB/m)	Result (dBuV/m)	Limit (dBuV/m)	Margin (dB)	Height (cm)	Degree (deg.)	Remark
1	5150.000	64.38	-2.76	61.62	74.00	-12.38	100	120	peak
2	5150.000	50.13	-2.76	47.37	54.00	-6.63	100	120	AVG

5310MHz

Polarity: Vertical

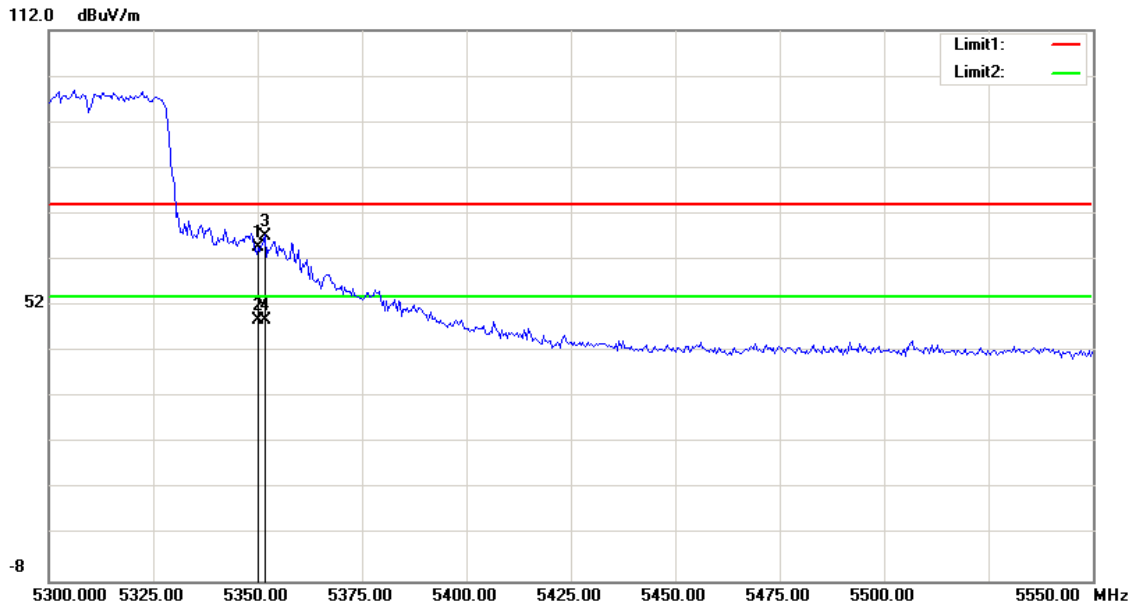

No.	Frequency (MHz)	Reading (dBuV)	Correct Factor(dB/m)	Result (dBuV/m)	Limit (dBuV/m)	Margin (dB)	Height (cm)	Degree (deg.)	Remark
1	5350.000	67.33	-2.50	64.83	74.00	-9.17	100	200	peak
2	5350.000	51.31	-2.50	48.81	54.00	-5.19	100	200	AVG
3	5351.683	69.80	-2.50	67.30	74.00	-6.70	100	202	peak
4	5351.683	51.47	-2.50	48.97	54.00	-5.03	100	202	AVG

Polarity: Horizontal

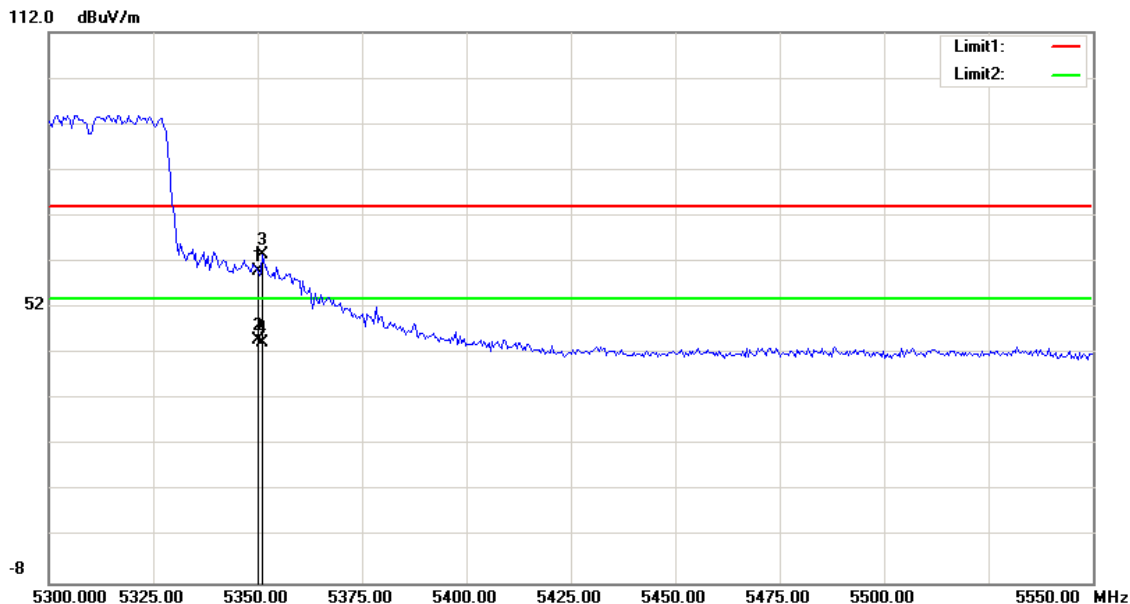

No.	Frequency (MHz)	Reading (dBuV)	Correct Factor(dB/m)	Result (dBuV/m)	Limit (dBuV/m)	Margin (dB)	Height (cm)	Degree (deg.)	Remark
1	5350.000	62.51	-2.50	60.01	74.00	-13.99	100	354	peak
2	5350.000	47.49	-2.50	44.99	54.00	-9.01	100	354	AVG
3	5351.282	66.05	-2.50	63.55	74.00	-10.45	100	48	peak
4	5351.282	46.96	-2.50	44.46	54.00	-9.54	100	48	AVG

5510MHz

Polarity: Vertical

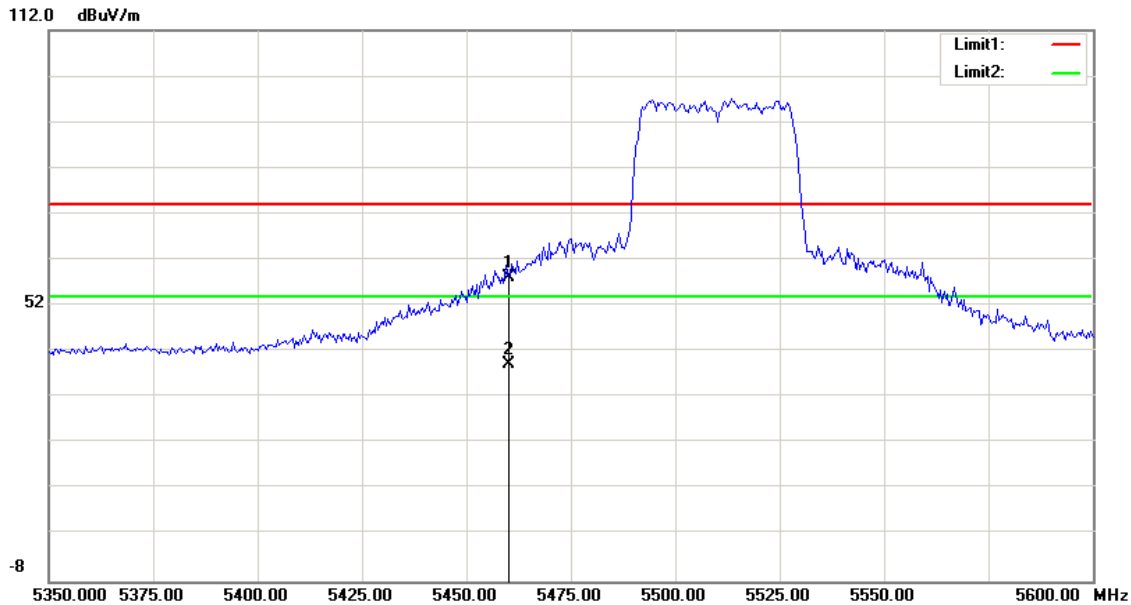

No.	Frequency (MHz)	Reading (dBuV)	Correct Factor(dB/m)	Result (dBuV/m)	Limit (dBuV/m)	Margin (dB)	Height (cm)	Degree (deg.)	Remark
1	5460.000	60.62	-2.36	58.26	74.00	-15.74	100	126	peak
2	5460.000	41.51	-2.36	39.15	54.00	-14.85	100	126	AVG

Polarity: Horizontal

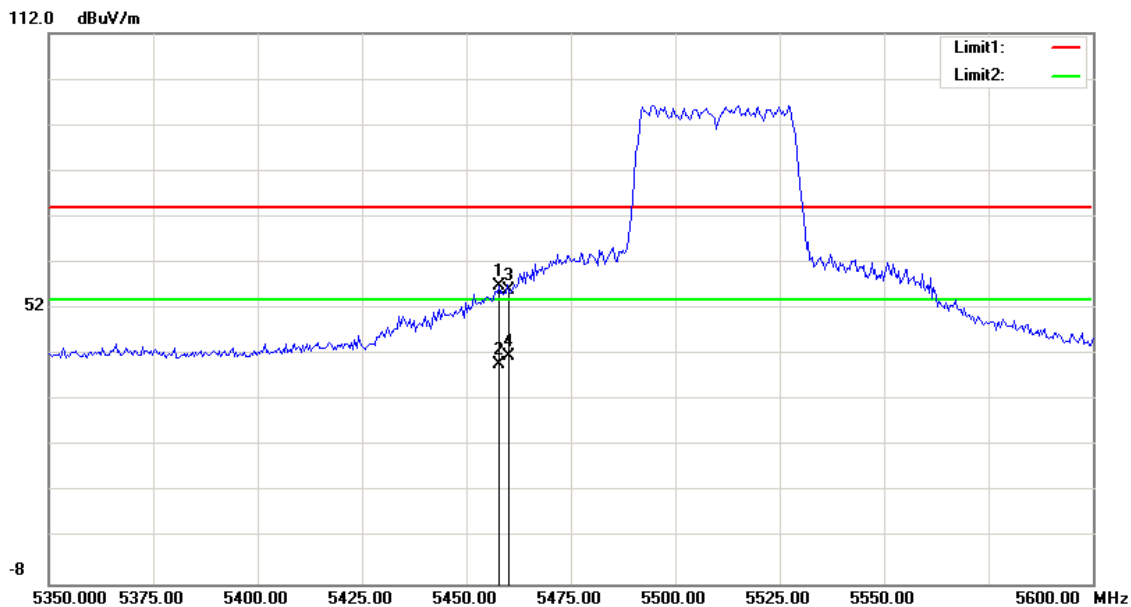

No.	Frequency (MHz)	Reading (dBuV)	Correct Factor(dB/m)	Result (dBuV/m)	Limit (dBuV/m)	Margin (dB)	Height (cm)	Degree (deg.)	Remark
1	5457.772	59.21	-2.36	56.85	74.00	-17.15	100	285	peak
2	5457.772	42.10	-2.36	39.74	54.00	-14.26	100	285	AVG
3	5460.000	58.51	-2.36	56.15	74.00	-17.85	100	114	peak
4	5460.000	43.90	-2.36	41.54	54.00	-12.46	100	114	AVG

Band Edges (IEEE 802.11ac HT20 mode)

5180MHz

Polarity: Vertical

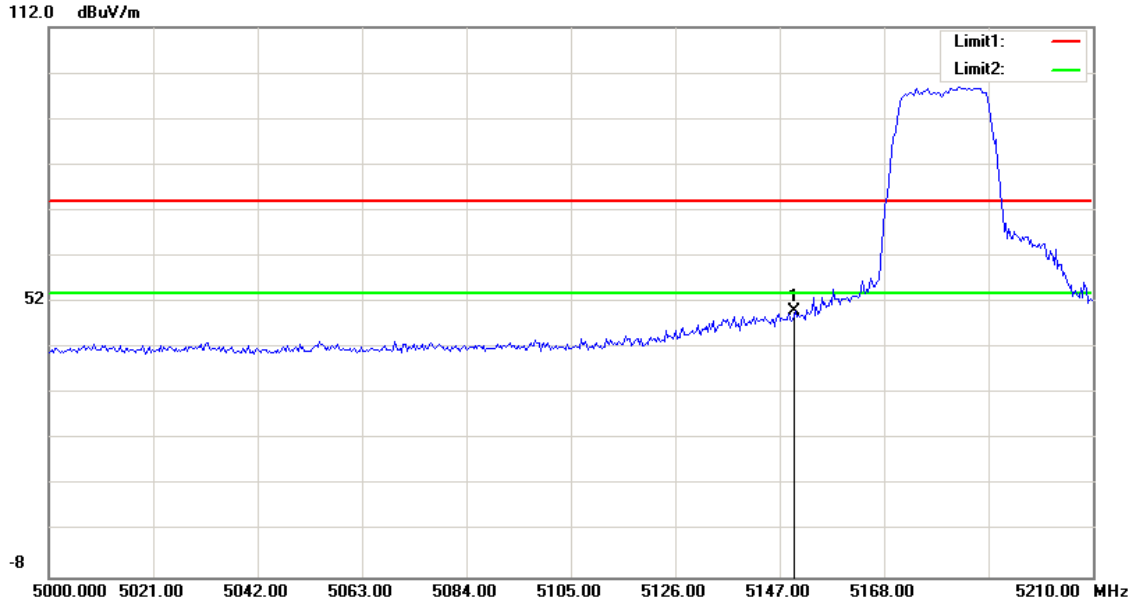

No.	Frequency (MHz)	Reading (dBuV)	Correct Factor(dB/m)	Result (dBuV/m)	Limit (dBuV/m)	Margin (dB)	Height (cm)	Degree (deg.)	Remark
1	5150.000	52.74	-2.76	49.98	74.00	-24.02	100	169	peak

Polarity: Horizontal

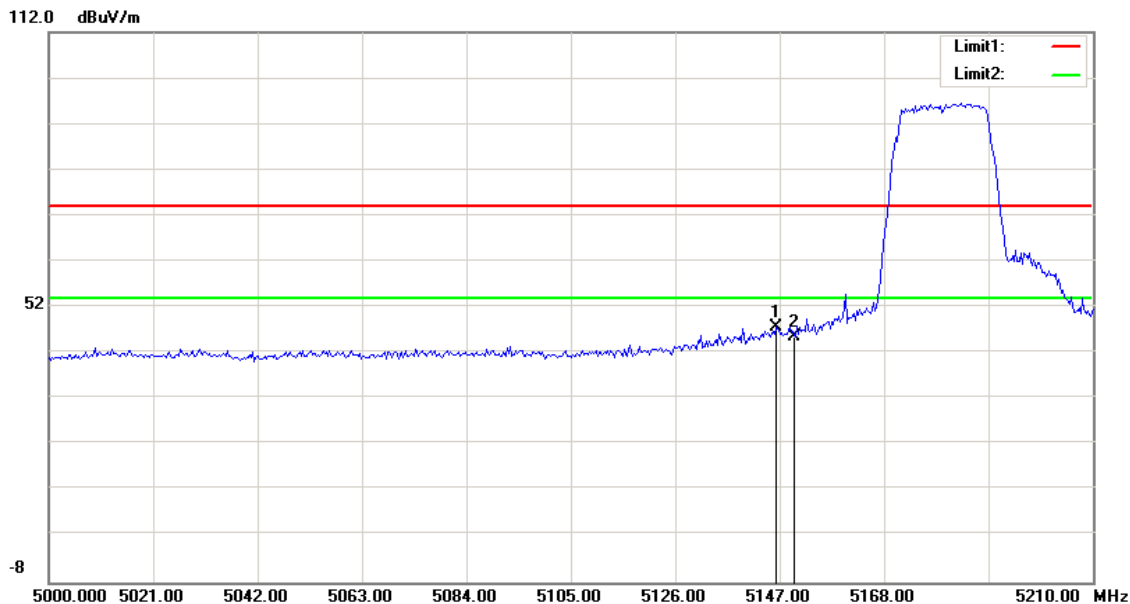

No.	Frequency (MHz)	Reading (dBuV)	Correct Factor(dB/m)	Result (dBuV/m)	Limit (dBuV/m)	Margin (dB)	Height (cm)	Degree (deg.)	Remark
1	5146.394	50.42	-2.76	47.66	74.00	-26.34	100	130	peak
2	5150.000	48.20	-2.76	45.44	74.00	-28.56	100	131	peak

5320MHz

Polarity: Vertical

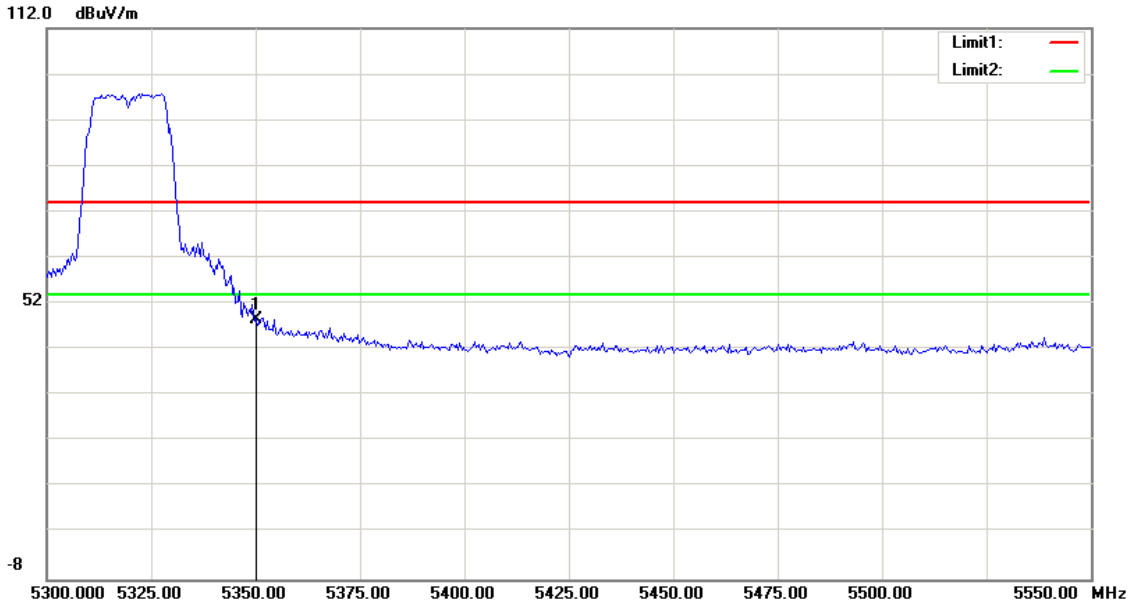

No.	Frequency (MHz)	Reading (dBuV)	Correct Factor(dB/m)	Result (dBuV/m)	Limit (dBuV/m)	Margin (dB)	Height (cm)	Degree (deg.)	Remark
1	5350.000	51.12	-2.50	48.62	74.00	-25.38	100	137	peak

Polarity: Horizontal

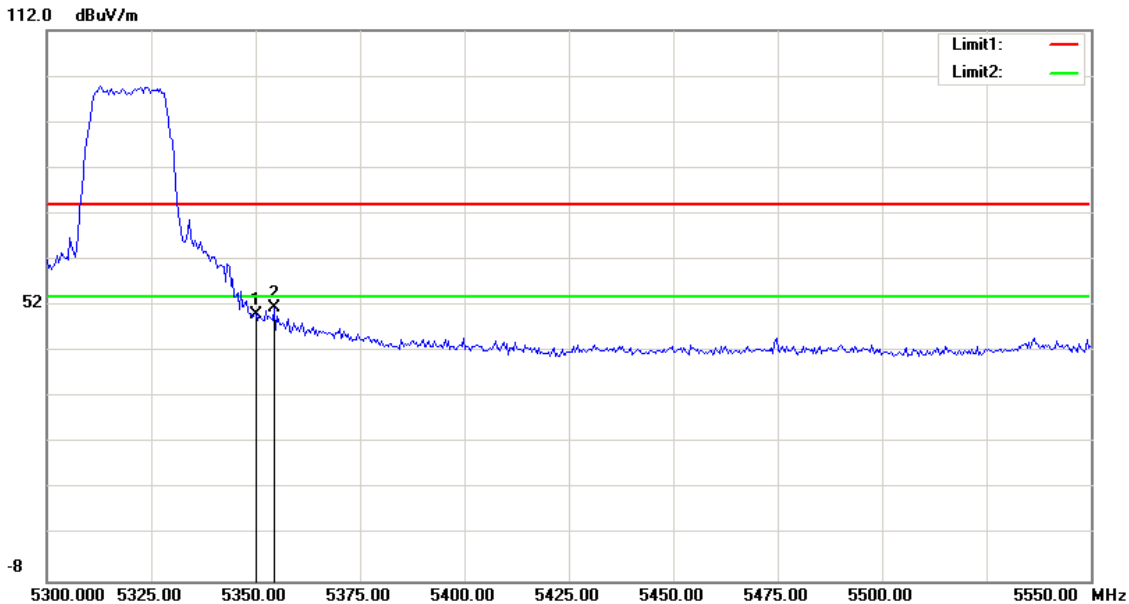

No.	Frequency (MHz)	Reading (dBuV)	Correct Factor(dB/m)	Result (dBuV/m)	Limit (dBuV/m)	Margin (dB)	Height (cm)	Degree (deg.)	Remark
1	5350.000	52.58	-2.50	50.08	74.00	-23.92	100	136	peak
	5354.487	54.02	-2.49	51.53	74.00	-22.47	100	145	peak

5500MHz

Polarity: Vertical

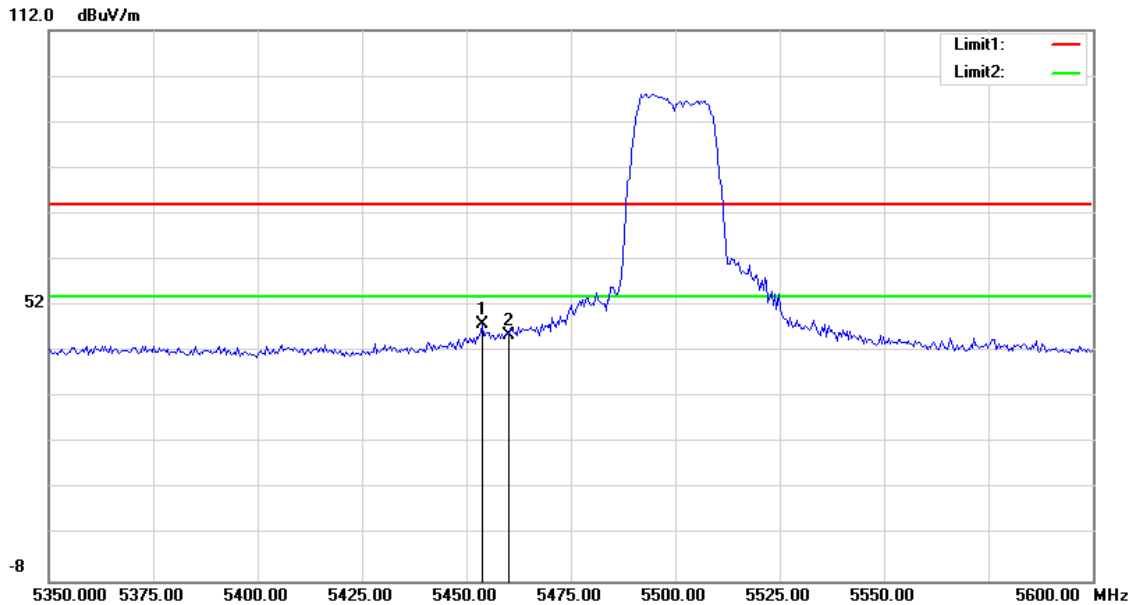

No.	Frequency (MHz)	Reading (dBuV)	Correct Factor(dB/m)	Result (dBuV/m)	Limit (dBuV/m)	Margin (dB)	Height (cm)	Degree (deg.)	Remark
1	5453.766	50.36	-2.36	48.00	74.00	-26.00	100	144	peak
2	5460.000	48.04	-2.36	45.68	74.00	-28.32	100	144	peak

Polarity: Horizontal

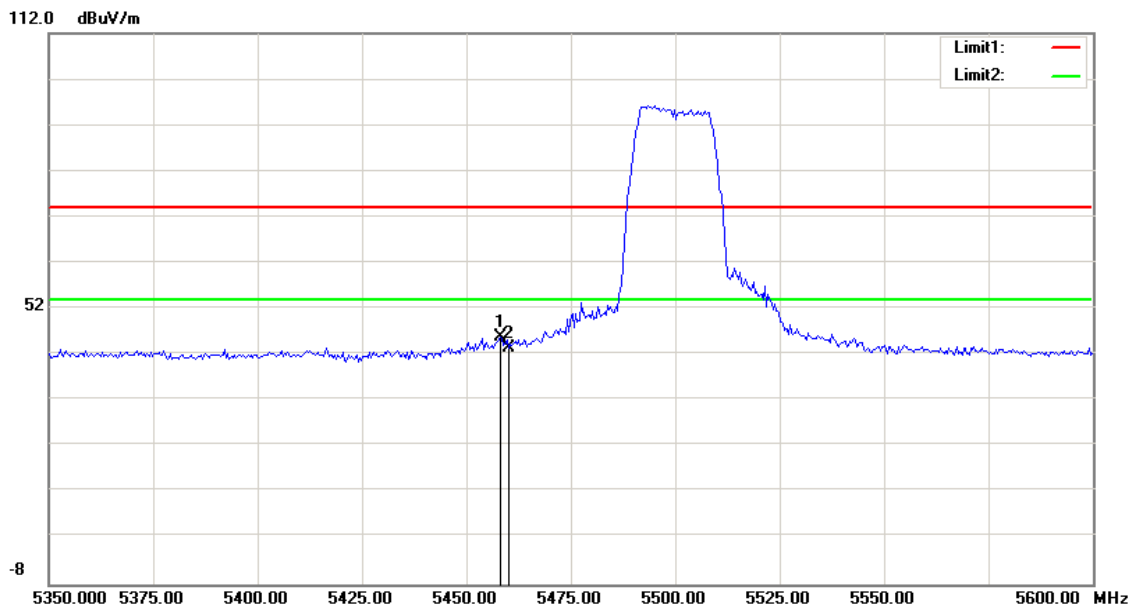

No.	Frequency (MHz)	Reading (dBuV)	Correct Factor(dB/m)	Result (dBuV/m)	Limit (dBuV/m)	Margin (dB)	Height (cm)	Degree (deg.)	Remark
1	5458.173	48.20	-2.36	45.84	74.00	-28.16	100	135	peak
	5460.000	45.78	-2.36	43.42	74.00	-30.58	100	134	peak

Band Edges (IEEE 802.11ac HT40 mode)

5190MHz

Polarity: Vertical

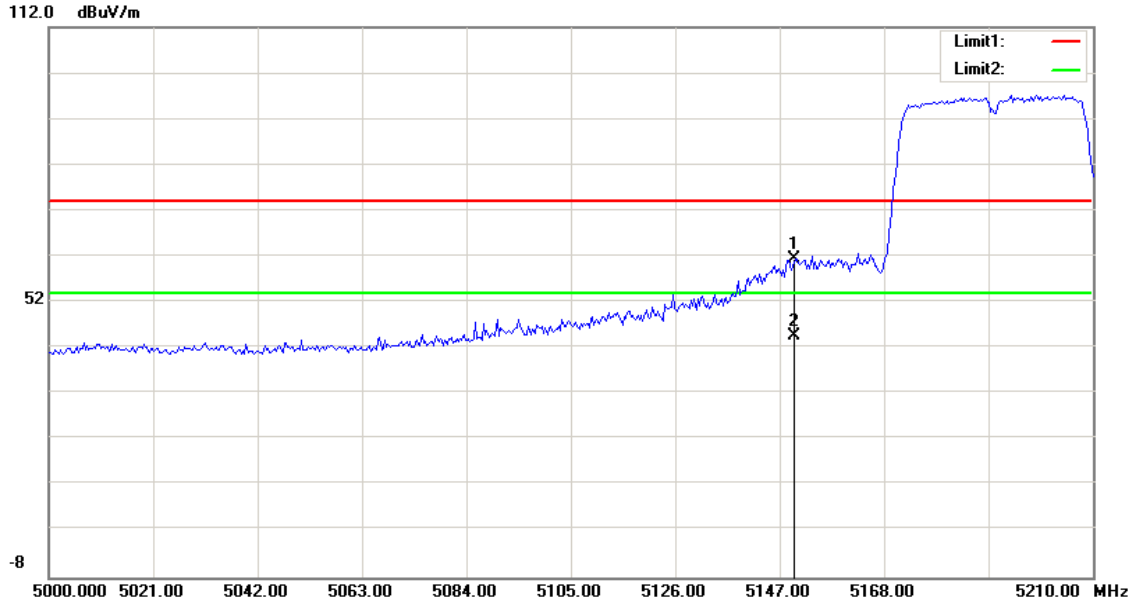

No.	Frequency (MHz)	Reading (dBuV)	Correct Factor(dB/m)	Result (dBuV/m)	Limit (dBuV/m)	Margin (dB)	Height (cm)	Degree (deg.)	Remark
1	5150.000	64.11	-2.76	61.35	74.00	-12.65	100	219	peak
2	5150.000	47.34	-2.76	44.58	54.00	-9.42	100	219	AVG

Polarity: Horizontal

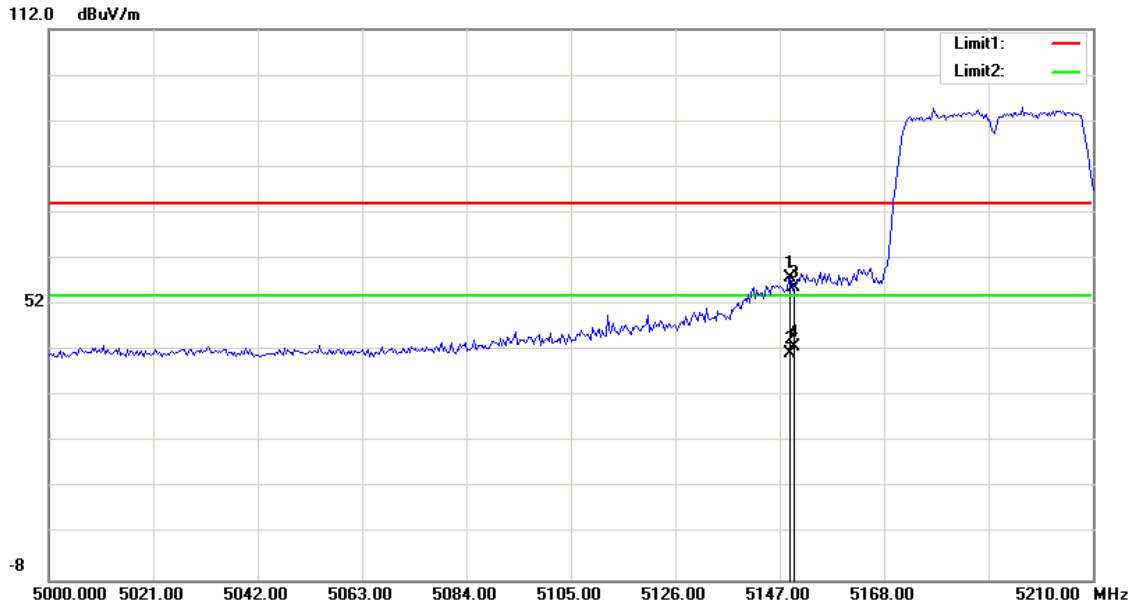

No.	Frequency (MHz)	Reading (dBuV)	Correct Factor(dB/m)	Result (dBuV/m)	Limit (dBuV/m)	Margin (dB)	Height (cm)	Degree (deg.)	Remark
1	5149.087	60.55	-2.76	57.79	74.00	-16.21	100	55	peak
2	5149.087	44.18	-2.76	41.42	54.00	-12.58	100	53	AVG
3	5150.000	58.63	-2.76	55.87	74.00	-18.13	100	131	peak
4	5150.000	45.76	-2.76	43.00	54.00	-11.00	100	129	AVG

5310MHz

Polarity: Vertical

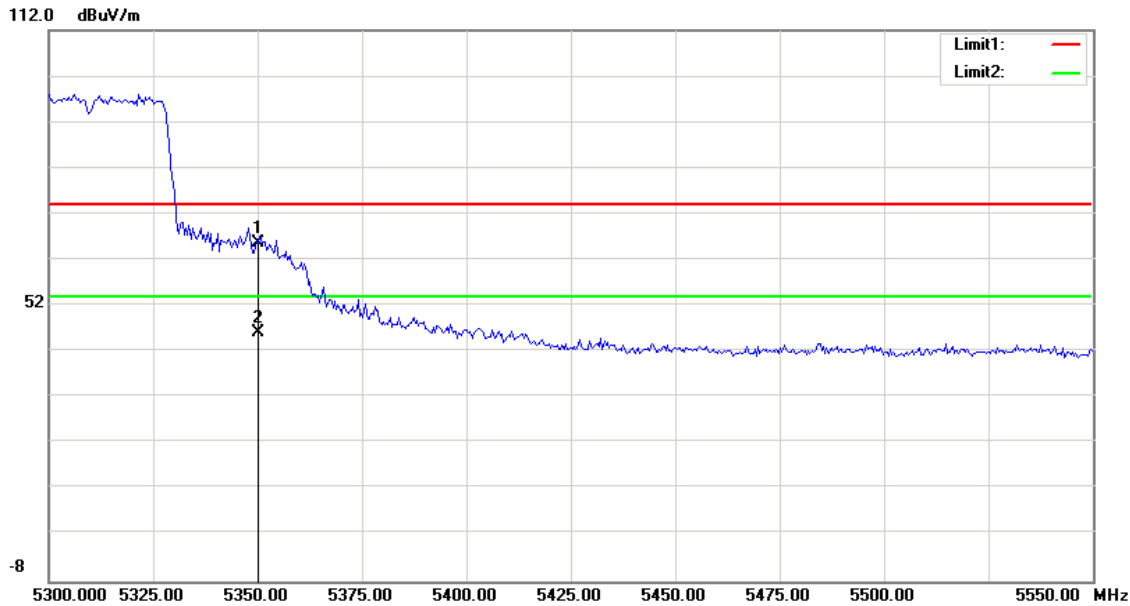

No.	Frequency (MHz)	Reading (dBuV)	Correct Factor(dB/m)	Result (dBuV/m)	Limit (dBuV/m)	Margin (dB)	Height (cm)	Degree (deg.)	Remark
1	5350.000	68.02	-2.50	65.52	74.00	-8.48	100	148	peak
2	5350.000	48.61	-2.50	46.11	54.00	-7.89	100	146	AVG

Polarity: Horizontal

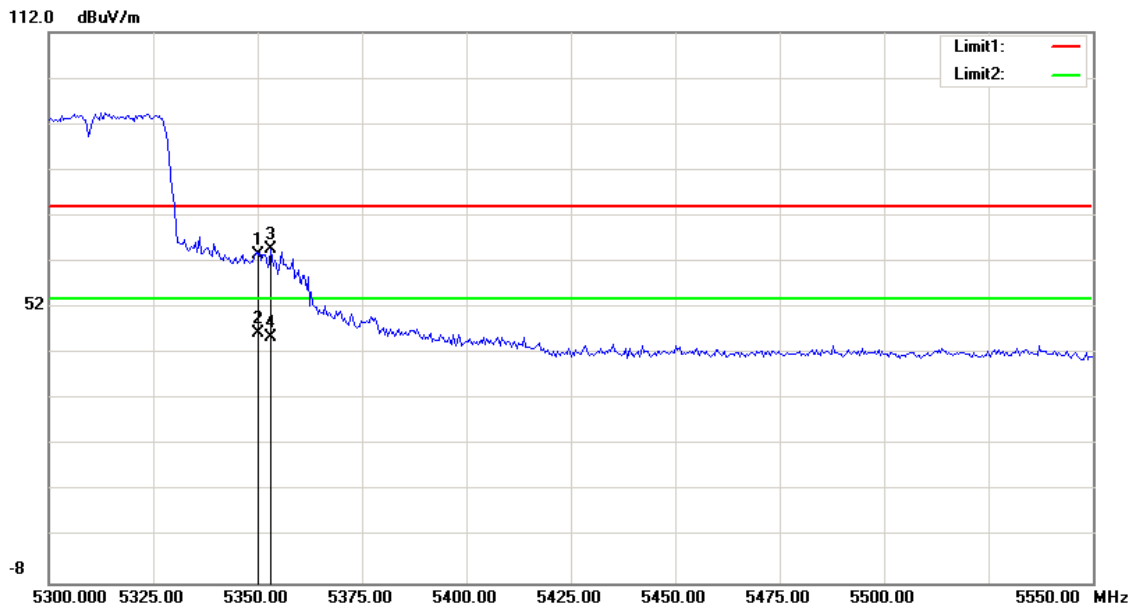

No.	Frequency (MHz)	Reading (dBuV)	Correct Factor(dB/m)	Result (dBuV/m)	Limit (dBuV/m)	Margin (dB)	Height (cm)	Degree (deg.)	Remark
1	5350.000	66.09	-2.50	63.59	74.00	-10.41	100	133	peak
2	5350.000	49.06	-2.50	46.56	54.00	-7.44	100	131	AVG
3	5353.285	67.17	-2.49	64.68	74.00	-9.32	100	132	peak
4	5353.285	48.01	-2.49	45.52	54.00	-8.48	100	131	AVG

5510MHz

Polarity: Vertical

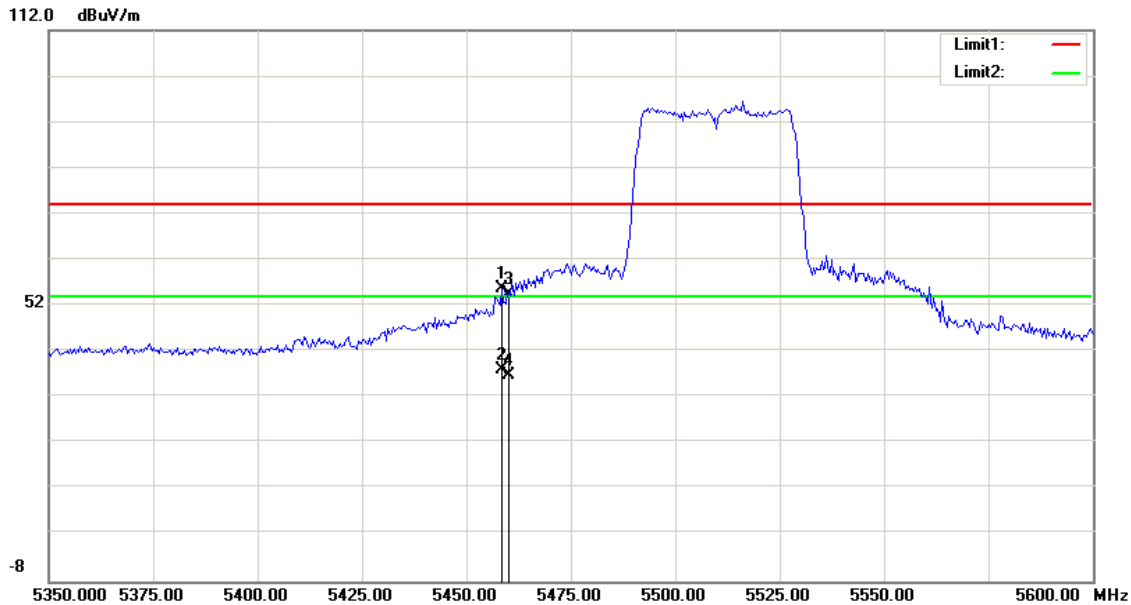

No.	Frequency (MHz)	Reading (dBuV)	Correct Factor(dB/m)	Result (dBuV/m)	Limit (dBuV/m)	Margin (dB)	Height (cm)	Degree (deg.)	Remark
1	5458.574	58.25	-2.36	55.89	74.00	-18.11	100	221	peak
2	5458.574	40.28	-2.36	37.92	54.00	-16.08	100	222	AVG
3	5460.000	56.89	-2.36	54.53	74.00	-19.47	100	147	peak
4	5460.000	39.12	-2.36	36.76	54.00	-17.24	100	145	AVG

Polarity: Horizontal

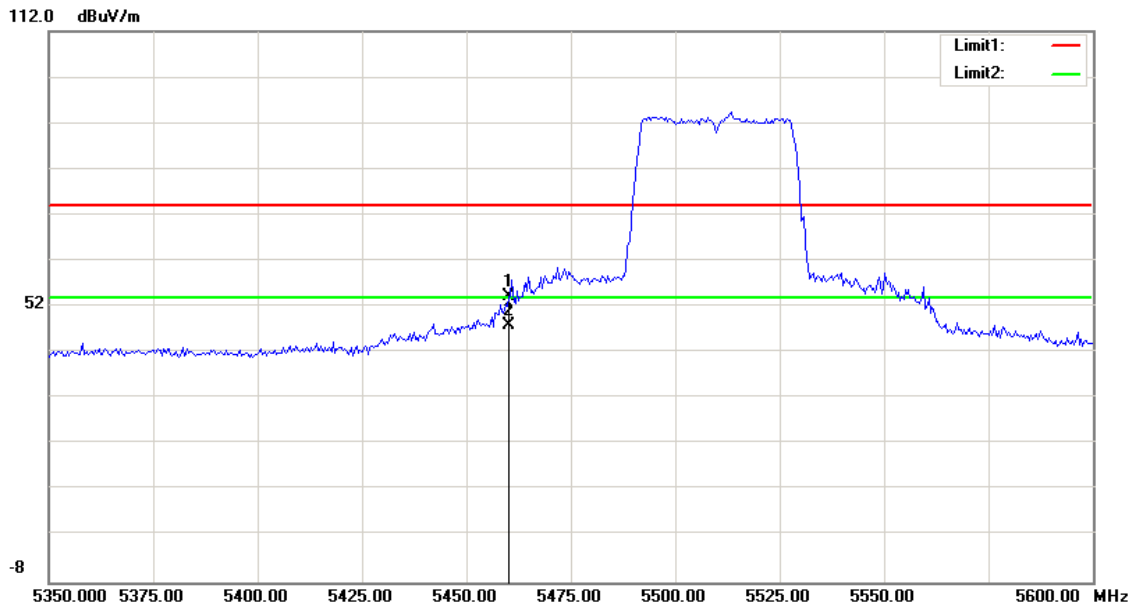

No.	Frequency (MHz)	Reading (dBuV)	Correct Factor(dB/m)	Result (dBuV/m)	Limit (dBuV/m)	Margin (dB)	Height (cm)	Degree (deg.)	Remark
1	5460.000	56.49	-2.36	54.13	74.00	-19.87	100	233	peak
2	5460.000	50.32	-2.36	47.96	54.00	-6.04	100	233	AVG

Band Edges (IEEE 802.11ac HT80 mode)

5210MHz

Polarity: Vertical

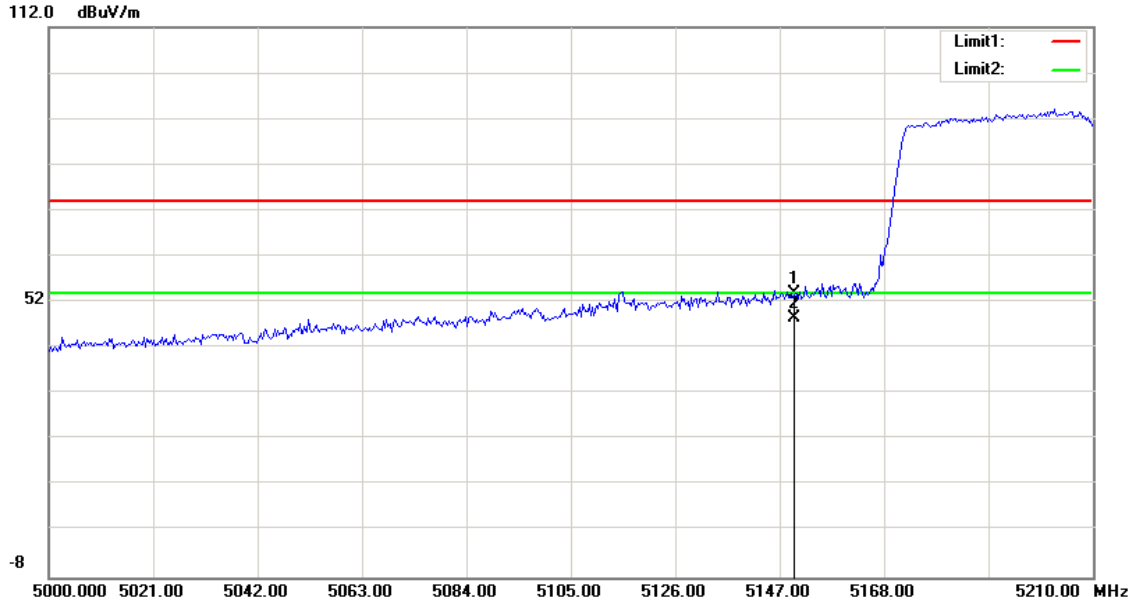

No.	Frequency (MHz)	Reading (dBuV)	Correct Factor(dB/m)	Result (dBuV/m)	Limit (dBuV/m)	Margin (dB)	Height (cm)	Degree (deg.)	Remark
1	5150.000	56.84	-2.76	54.08	74.00	-19.92	100	167	peak
2	5150.000	51.39	-2.76	48.63	54.00	-5.37	100	167	AVG

Polarity: Horizontal

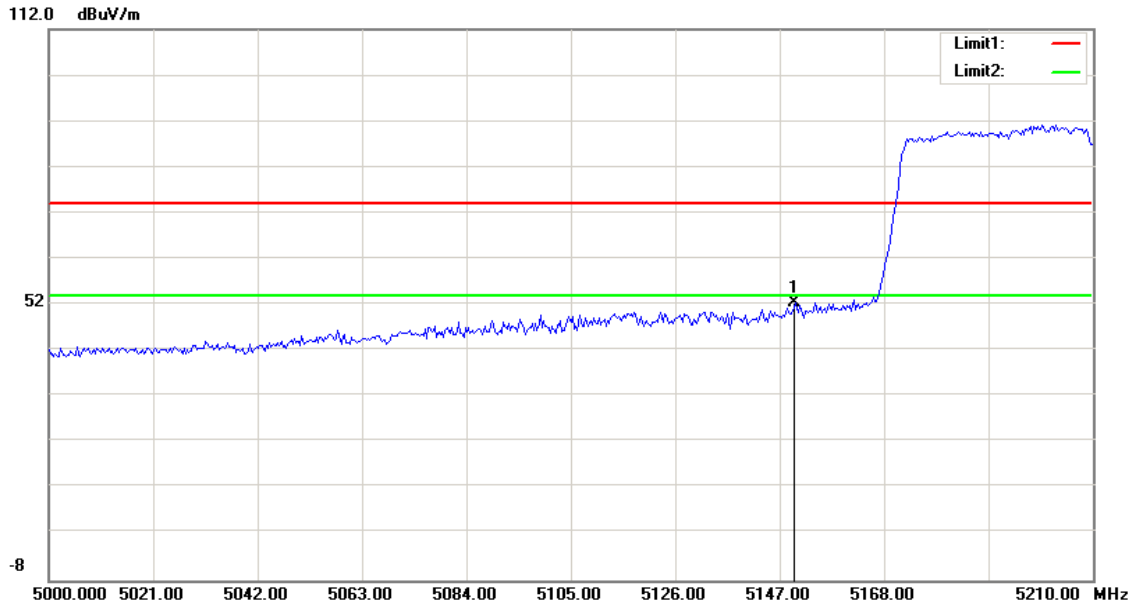

No.	Frequency (MHz)	Reading (dBuV)	Correct Factor(dB/m)	Result (dBuV/m)	Limit (dBuV/m)	Margin (dB)	Height (cm)	Degree (deg.)	Remark
1	5150.000	55.22	-2.76	52.46	74.00	-21.54	100	131	peak

5290MHz

Polarity: Vertical

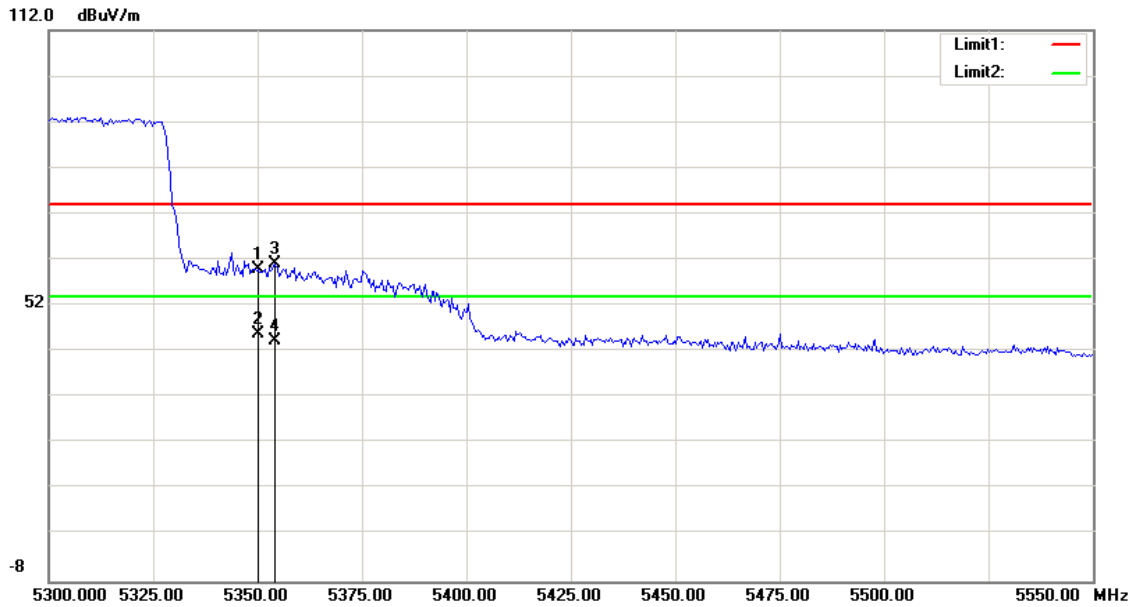

No.	Frequency (MHz)	Reading (dBuV)	Correct Factor(dB/m)	Result (dBuV/m)	Limit (dBuV/m)	Margin (dB)	Height (cm)	Degree (deg.)	Remark
1	5350.000	62.49	-2.50	59.99	74.00	-14.01	100	138	peak
2	5350.000	48.40	-2.50	45.90	54.00	-8.10	100	136	AVG
3	5354.087	63.75	-2.49	61.26	74.00	-12.74	100	143	peak
4	5354.087	46.79	-2.49	44.30	54.00	-9.70	100	144	AVG

Polarity: Horizontal

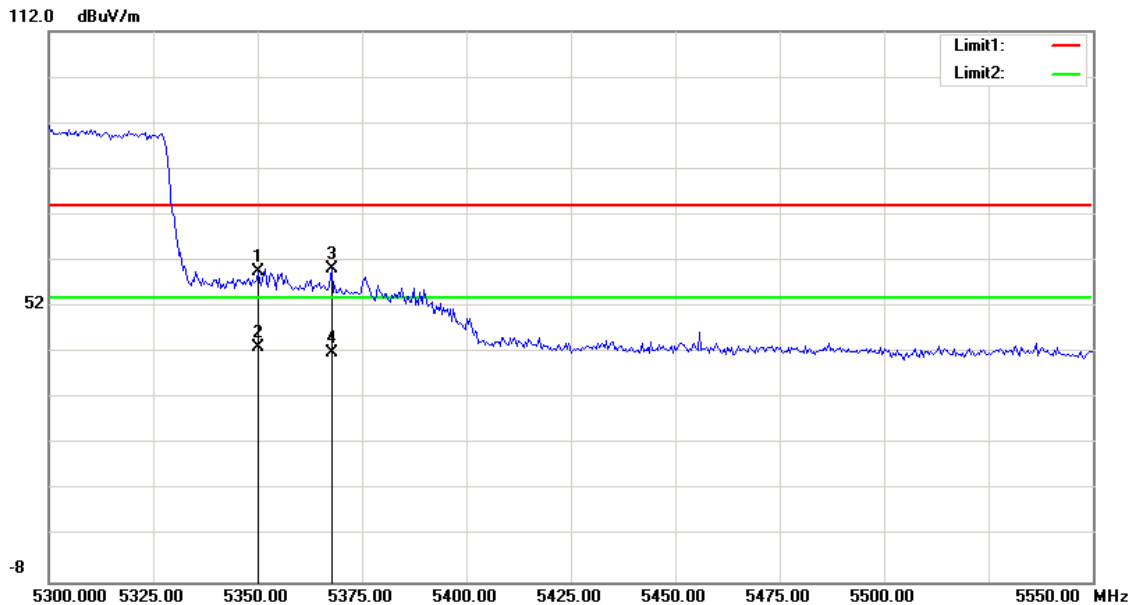

No.	Frequency (MHz)	Reading (dBuV)	Correct Factor(dB/m)	Result (dBuV/m)	Limit (dBuV/m)	Margin (dB)	Height (cm)	Degree (deg.)	Remark
1	5350.000	62.13	-2.50	59.63	74.00	-14.37	100	139	peak
2	5350.000	45.67	-2.50	43.17	54.00	-10.83	100	137	AVG
3	5367.708	62.81	-2.48	60.33	74.00	-13.67	100	133	peak
4	5367.708	44.31	-2.48	41.83	54.00	-12.17	100	131	AVG

5530MHz

Polarity: Vertical

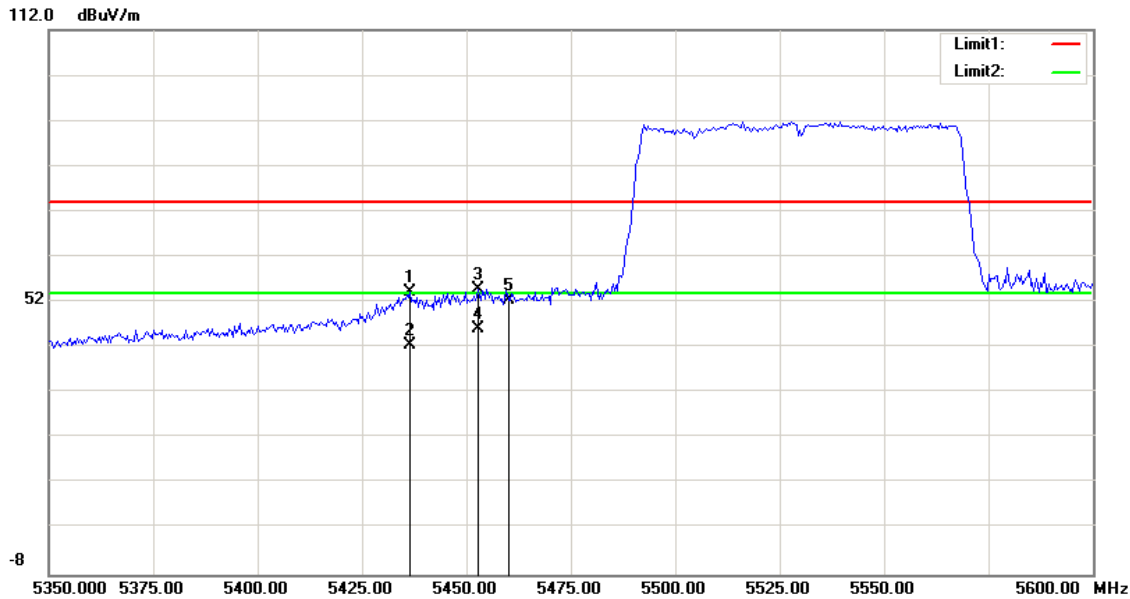

No.	Frequency (MHz)	Reading (dBuV)	Correct Factor(dB/m)	Result (dBuV/m)	Limit (dBuV/m)	Margin (dB)	Height (cm)	Degree (deg.)	Remark
1	5436.538	56.50	-2.39	54.11	74.00	-19.89	100	144	peak
2	5436.538	44.97	-2.39	42.58	54.00	-11.42	100	144	AVG
3	5452.965	57.36	-2.37	54.99	74.00	-19.01	100	144	peak
4	5452.965	48.66	-2.37	46.29	54.00	-7.71	100	144	AVG
5	5460.000	54.92	-2.36	52.56	74.00	-21.44	100	142	peak

Polarity: Horizontal

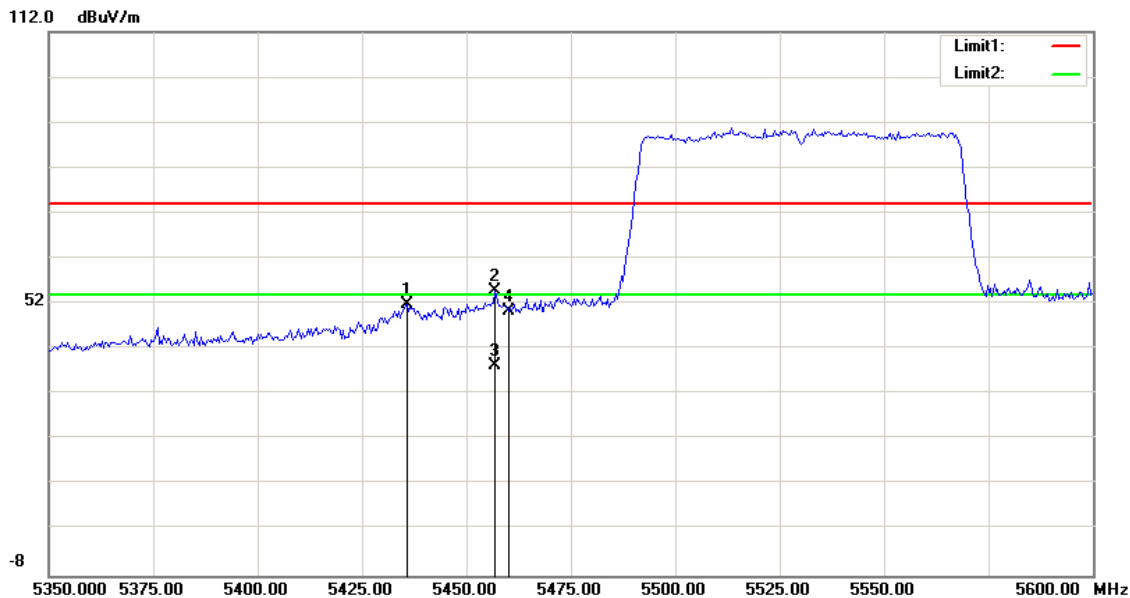

No.	Frequency (MHz)	Reading (dBuV)	Correct Factor(dB/m)	Result (dBuV/m)	Limit (dBuV/m)	Margin (dB)	Height (cm)	Degree (deg.)	Remark
1	5435.737	54.19	-2.39	51.80	74.00	-22.20	100	136	peak
2	5456.971	57.34	-2.36	54.98	74.00	-19.02	100	238	peak
3	5456.971	40.70	-2.36	38.34	54.00	-15.66	100	236	AVG
4	5460.000	52.57	-2.36	50.21	74.00	-23.79	100	130	peak

7.4 MAXIMUM POWER SPECTRAL DENSITY

LIMIT

According to §15.407(a),

For mobile and portable client devices in the 5.15-5.25 GHz band, the maximum conducted output power over the frequency band of operation shall not exceed 250 mW provided the maximum antenna gain does not exceed 6 dBi. In addition, the maximum power spectral density shall not exceed 11 dBm in any 1 megahertz band. If transmitting antennas of directional gain greater than 6 dBi are used, both the maximum conducted output power and the maximum power spectral density shall be reduced by the amount in dB that the directional gain of the antenna exceeds 6 dBi.

If transmitting antennas of directional gain greater than 6dBi are used, both the peak transmit power and the peak power spectral density shall be reduced by the amount in dB that the directional gain of the antenna exceeds 6dBi.

EUT with two transmit antennas, each with the same directional gain 3dBi, being driven by two transmitter outputs of equal power. Directional gain is to be computed as follows:

All transmit signals are completely uncorrelated with each other, So directional gain=3dBi < 6dBi.

Test Configuration

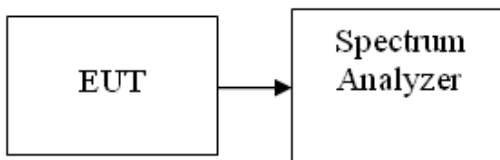

TEST PROCEDURE

1. Place the EUT on the table and set it in transmitting mode.
Remove the antenna from the EUT and then connect a low loss RF cable from the antenna port to the spectrum analyzer.
2. Set the spectrum analyzer as RBW = 1MHz, VBW = 3MHz, Span must be greater than 26dB bandwidth, adjust as necessary, Sweep= auto, Detector RMS
3. Record the max. reading.

TEST RESULTS

No non-compliance noted

Test Data

Test mode: IEEE 802.11a mode

5150~5250MHz

Channel	Frequency (MHz)	Chain 0 PPSD (dBm)	Chain 1 PPSD (dBm)	Limit (dBm)	Result
Low	5180	4.59	3.71	11.00	PASS
Mid	5200	4.70	3.83	11.00	PASS
High	5240	4.85	3.53	11.00	PASS

5250~5350MHz

Channel	Frequency (MHz)	Chain 0 PPSD (dBm)	Chain 1 PPSD (dBm)	Limit (dBm)	Result
Low	5260	4.43	3.56	11.00	PASS
Mid	5300	3.86	3.37	11.00	PASS
High	5320	4.00	3.08	11.00	PASS

5470~5725MHz

Channel	Frequency (MHz)	Chain 0 PPSD (dBm)	Chain 1 PPSD (dBm)	Limit (dBm)	Result
Low	5500	3.41	3.02	11.00	PASS
Mid	5540	3.47	3.04	11.00	PASS
High	5700	1.69	1.78	11.00	PASS

Test mode: IEEE 802.11n HT20MHz mode

5150~5250MHz

Channel	Frequency (MHz)	Chain 0 PPSD (dBm)	Chain 1 PPSD (dBm)	Total PPSD (dBm)	Limit (dBm)	Result
Low	5180	4.28	3.46	6.90	11.00	PASS
Mid	5200	4.70	3.93	7.34	11.00	PASS
High	5240	4.27	3.39	6.86	11.00	PASS

5250~5350MHz

Channel	Frequency (MHz)	Chain 0 PPSD (dBm)	Chain 1 PPSD (dBm)	Total PPSD (dBm)	Limit (dBm)	Result
Low	5260	4.11	3.23	6.70	11.00	PASS
Mid	5300	3.85	3.01	6.46	11.00	PASS
High	5320	3.84	3.25	6.57	11.00	PASS

5470~5725MHz

Channel	Frequency (MHz)	Chain 0 PPSD (dBm)	Chain 1 PPSD (dBm)	Total PPSD (dBm)	Limit (dBm)	Result
Low	5500	3.22	2.85	6.05	11.00	PASS
Mid	5540	3.17	2.87	6.03	11.00	PASS
High	5700	1.29	1.71	4.52	11.00	PASS

**Test mode: IEEE 802.11n HT40MHz mode
5150~5250MHz**

Channel	Frequency (MHz)	Chain 0 PPSD (dBm)	Chain 1 PPSD (dBm)	Total PPSD (dBm)	Limit (dBm)	Result
Low	5190	2.12	1.15	4.67	11.00	PASS
High	5230	2.18	1.20	4.73	11.00	PASS

5250~5350MHz

Channel	Frequency (MHz)	Chain 0 PPSD (dBm)	Chain 1 PPSD (dBm)	Total PPSD (dBm)	Limit (dBm)	Result
Low	5270	1.94	0.72	4.38	11.00	PASS
High	5310	1.75	0.72	4.28	11.00	PASS

5470~5725MHz

Channel	Frequency (MHz)	Chain 0 PPSD (dBm)	Chain 1 PPSD (dBm)	Total PPSD (dBm)	Limit (dBm)	Result
Low	5510	0.88	0.46	3.69	11.00	PASS
Mid	5550	0.82	0.41	3.63	11.00	PASS
High	5670	-0.37	-0.45	2.60	11.00	PASS

**Test mode: IEEE 802.11ac HT20MHz mode
5150~5250MHz**

Channel	Frequency (MHz)	Chain 0 PPSD (dBm)	Chain 1 PPSD (dBm)	Limit (dBm)	Result
Low	5180	4.32	3.40	11.00	PASS
Mid	5200	4.50	3.83	11.00	PASS
High	5240	4.26	3.32	11.00	PASS

5250~5350MHz

Channel	Frequency (MHz)	Chain 0 PPSD (dBm)	Chain 1 PPSD (dBm)	Limit (dBm)	Result
Low	5260	3.94	3.45	11.00	PASS
Mid	5300	3.71	3.01	11.00	PASS
High	5320	3.79	3.25	11.00	PASS

5470~5725MHz

Channel	Frequency (MHz)	Chain 0 PPSD (dBm)	Chain 1 PPSD (dBm)	Limit (dBm)	Result
Low	5500	3.17	2.80	11.00	PASS
Mid	5540	2.94	2.65	11.00	PASS
High	5700	1.20	1.68	11.00	PASS

**Test mode: IEEE 802.11ac HT40MHz mode
5150~5250MHz**

Channel	Frequency (MHz)	Chain 0 PPSD (dBm)	Chain 1 PPSD (dBm)	Limit (dBm)	Result
Low	5190	2.29	1.17	11.00	PASS
High	5230	2.03	0.98	11.00	PASS

5250~5350MHz

Channel	Frequency (MHz)	Chain 0 PPSD (dBm)	Chain 1 PPSD (dBm)	Limit (dBm)	Result
Low	5270	1.96	0.75	11.00	PASS
High	5310	1.86	0.68	11.00	PASS

5470~5725MHz

Channel	Frequency (MHz)	Chain 0 PPSD (dBm)	Chain 1 PPSD (dBm)	Limit (dBm)	Result
Low	5510	1.17	0.41	11.00	PASS
Mid	5550	0.64	0.35	11.00	PASS
High	5670	-0.56	-0.39	11.00	PASS

**Test mode: IEEE 802.11ac HT80MHz mode
5150~5250MHz**

Channel	Frequency (MHz)	Chain 0 PPSD (dBm)	Chain 1 PPSD (dBm)	Limit (dBm)	Result
Mid	5210	-0.91	-1.69	11.00	PASS

5250~5350MHz

Channel	Frequency (MHz)	Chain 0 PPSD (dBm)	Chain 1 PPSD (dBm)	Limit (dBm)	Result
Mid	5290	-1.20	-2.47	11.00	PASS

5470~5725MHz

Channel	Frequency (MHz)	Chain 0 PPSD (dBm)	Chain 1 PPSD (dBm)	Limit (dBm)	Result
Mid	5530	-2.25	-2.68	11.00	PASS

Note:Duty factor has been offsetted with cableloss

Remark: Total PPSD (dBm) = $10 * \text{LOG}(10^{(\text{Chain 0 PPSD} / 10)} + 10^{(\text{Chain 1 PPSD} / 10)})$

Test Plot

IEEE 802.11a mode/chain 0:

5150~5250MHz

CH Low

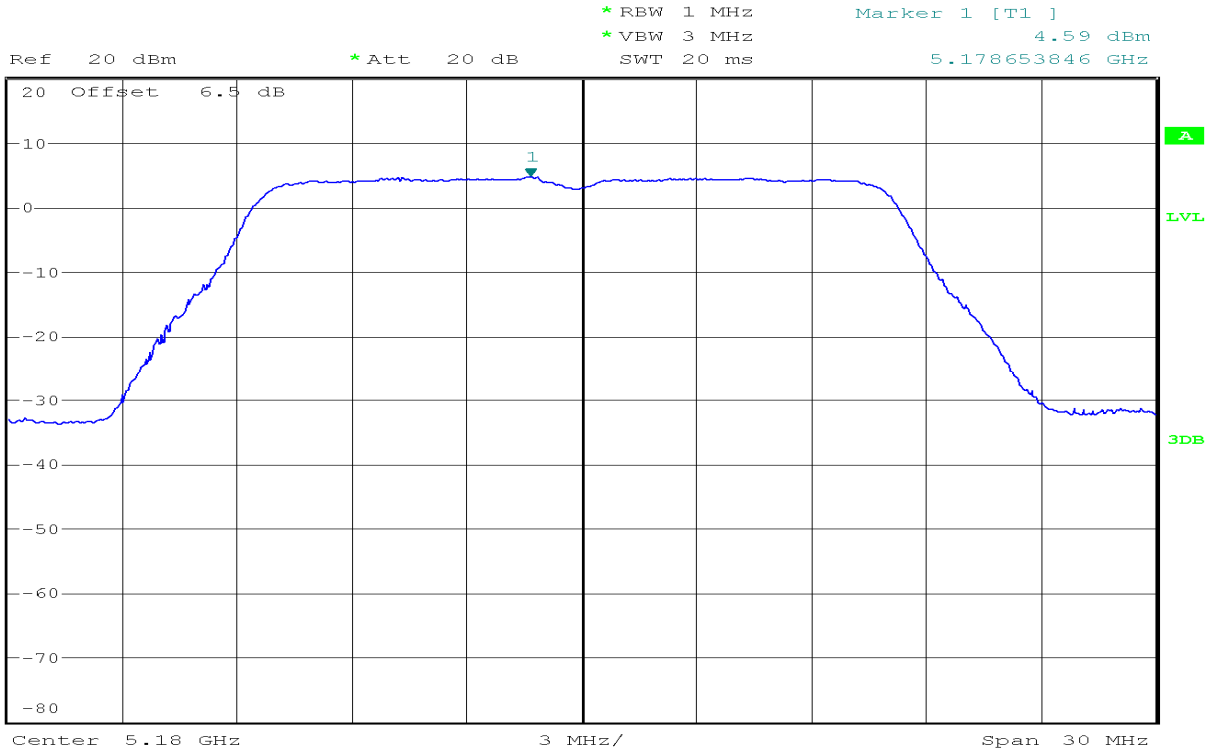

CH Mid

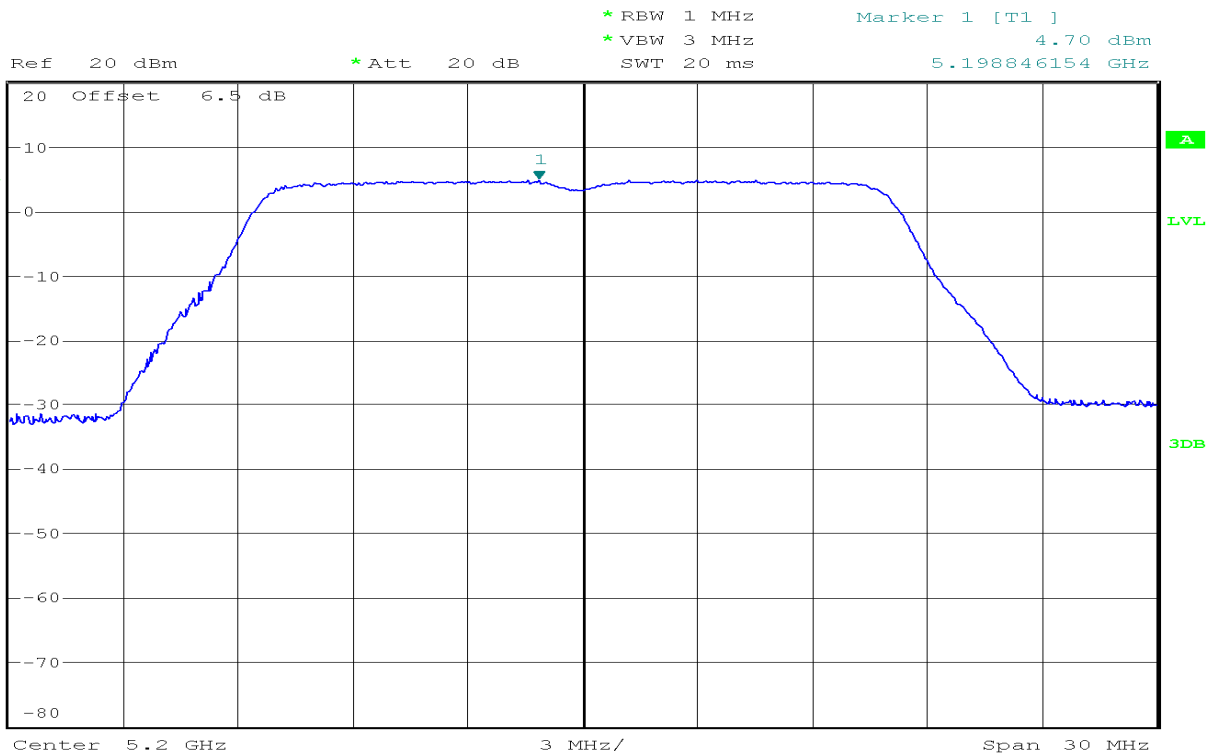

CH High



Ref 20 dBm * Att 20 dB * RBW 1 MHz Marker 1 [T1] 4.85 dBm
 * VBW 3 MHz 5.235144231 GHz
 SWT 20 ms

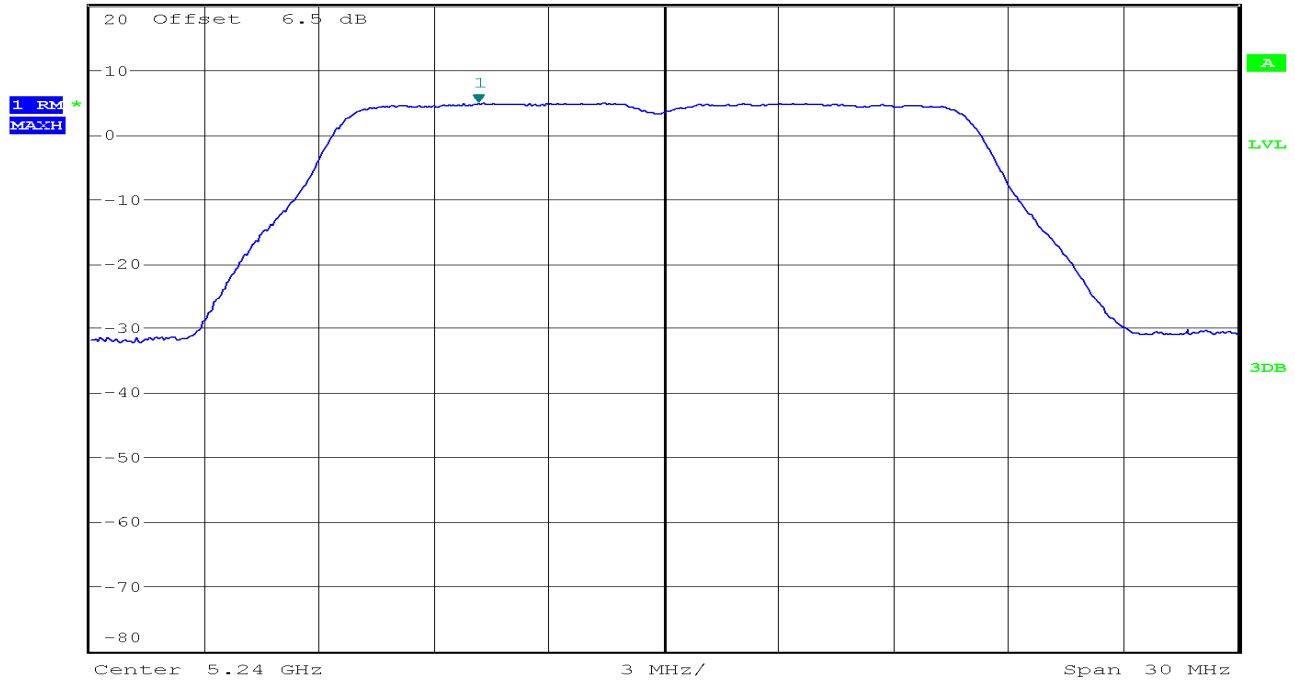

5250~5350MHz

CH Low



Ref 20 dBm * Att 20 dB * RBW 1 MHz Marker 1 [T1] 4.43 dBm
 * VBW 3 MHz 5.258701923 GHz
 SWT 20 ms

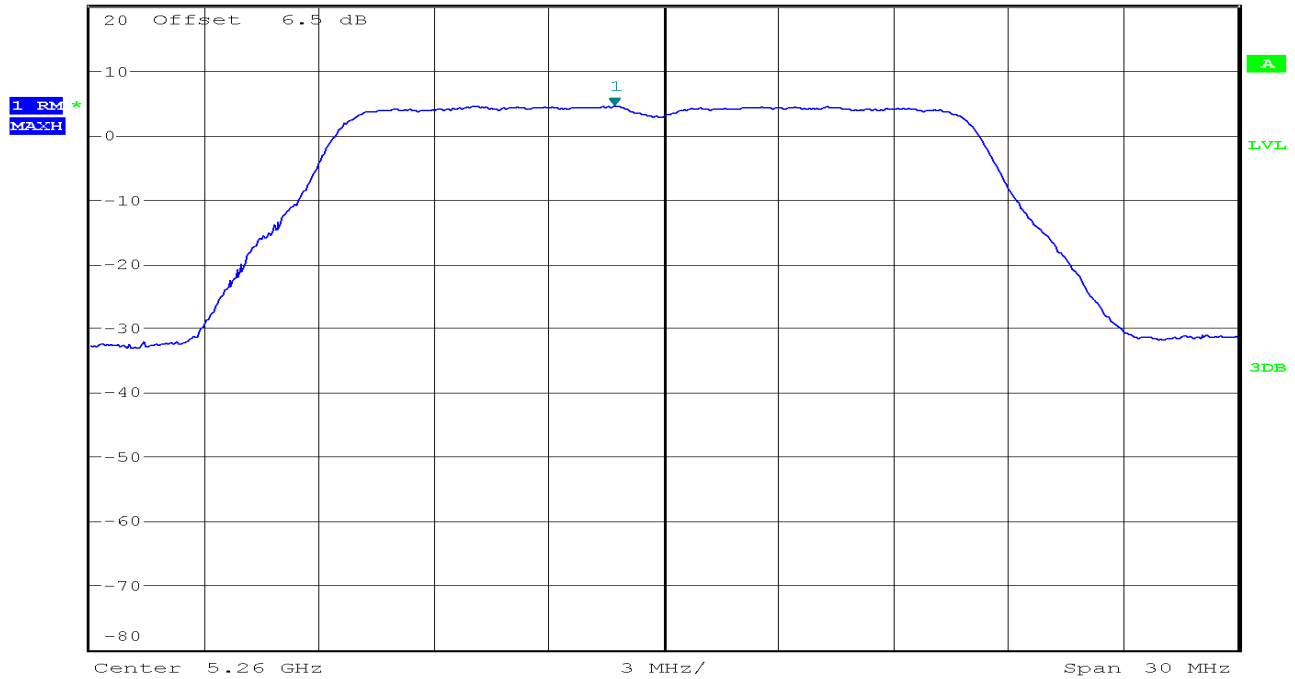

CH Mid



Ref 20 dBm * Att 20 dB * RBW 1 MHz Marker 1 [T1]
 * VBW 3 MHz 3.86 dBm
 SWT 20 ms 5.298557692 GHz

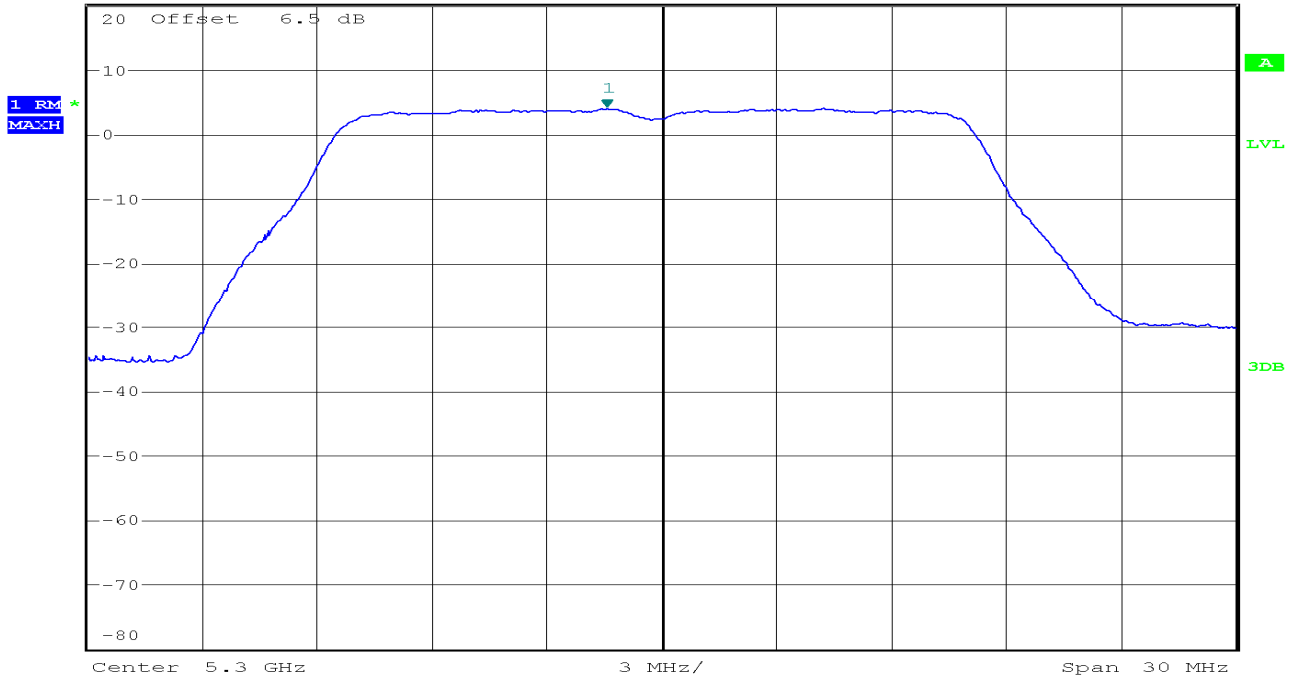

CH High



Ref 20 dBm * Att 20 dB * RBW 1 MHz Marker 1 [T1]
 * VBW 3 MHz 4.00 dBm
 SWT 20 ms 5.317307692 GHz

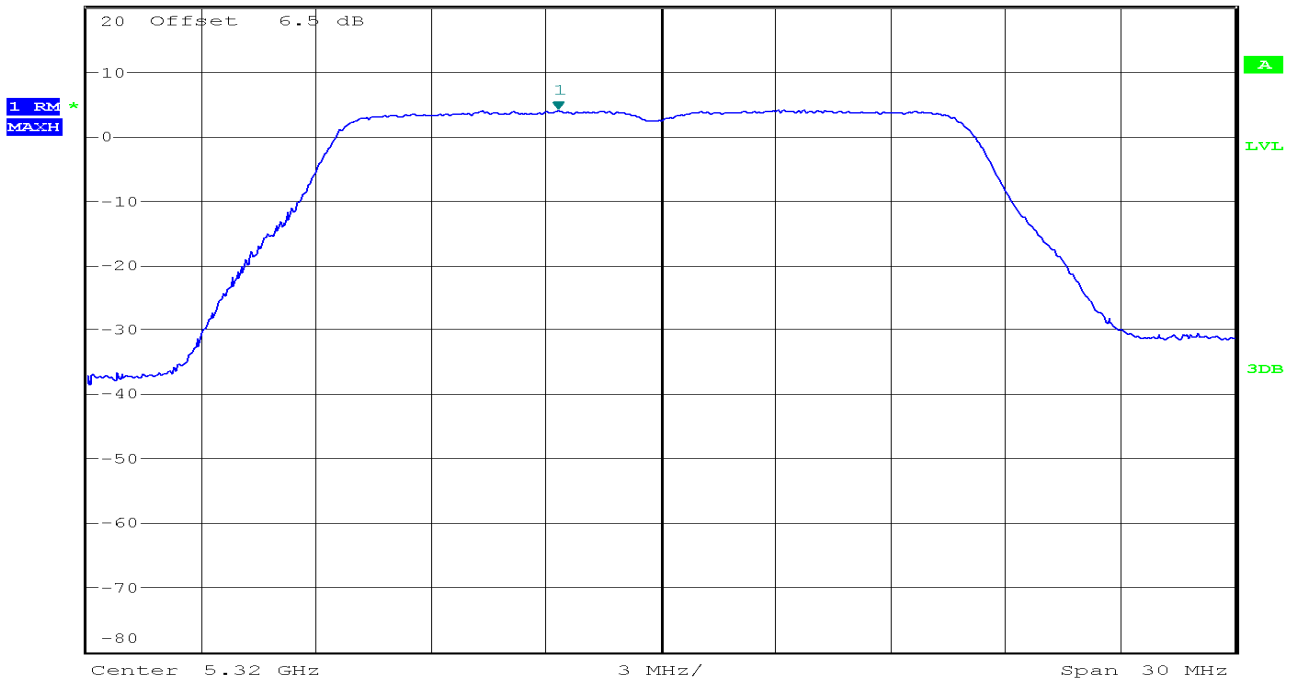

5470~5725MHz

CH Low



Ref 20 dBm * Att 20 dB * RBW 1 MHz Marker 1 [T1] 3.41 dBm
 * VBW 3 MHz 5.496250000 GHz
 SWT 20 ms

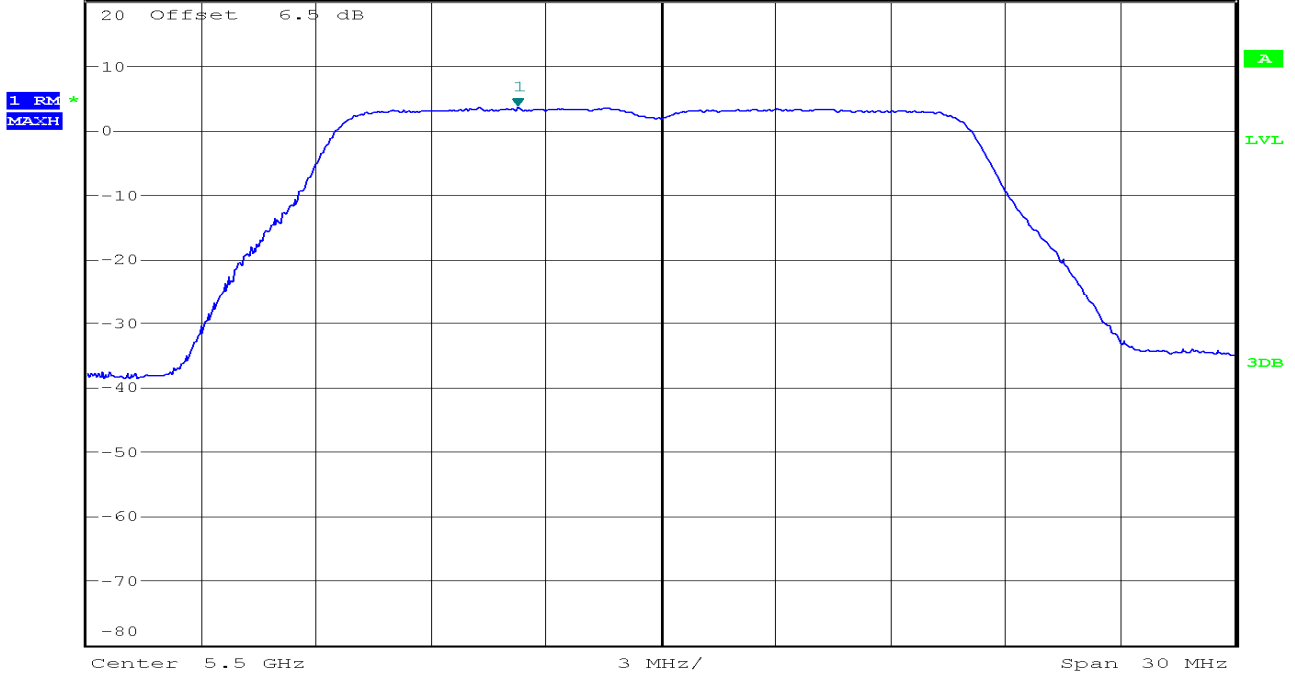

CH Mid



Ref 20 dBm * Att 20 dB * RBW 1 MHz Marker 1 [T1] 3.47 dBm
 * VBW 3 MHz 5.538461538 GHz
 SWT 20 ms

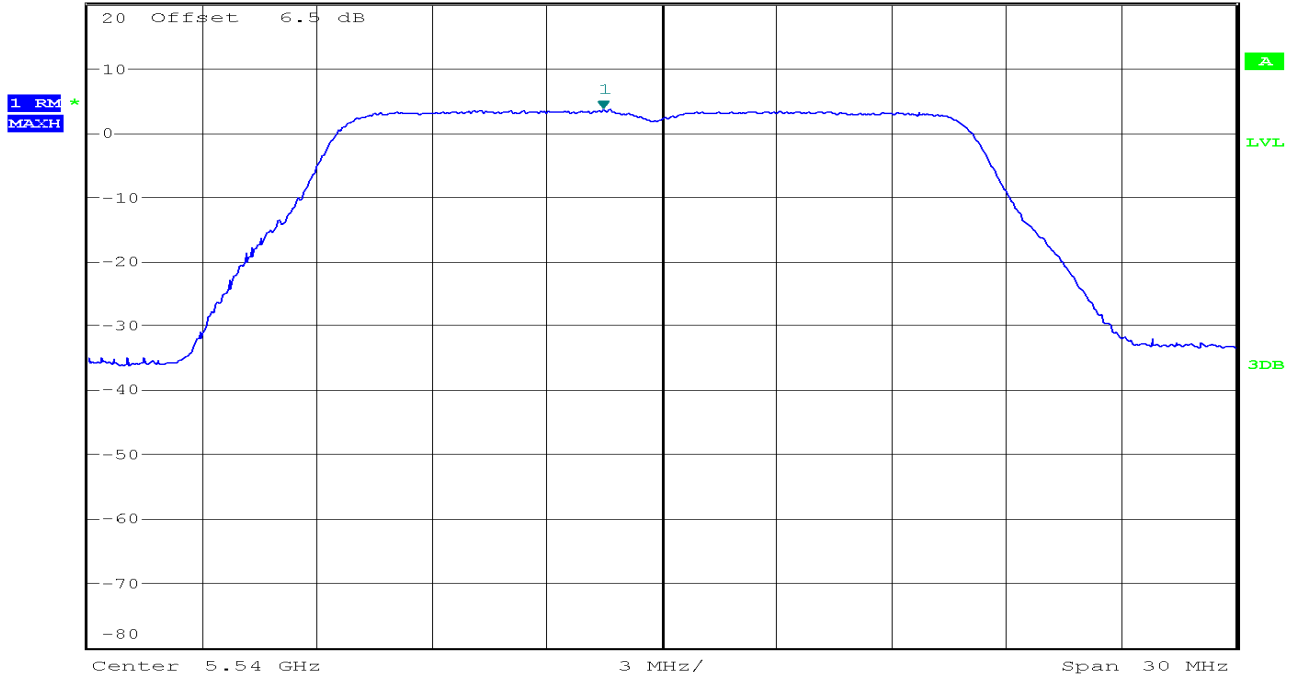

CH High



Ref 20 dBm * Att 20 dB * RBW 1 MHz Marker 1 [T1] 1.69 dBm
 * VBW 3 MHz 5.698701923 GHz
 SWT 20 ms

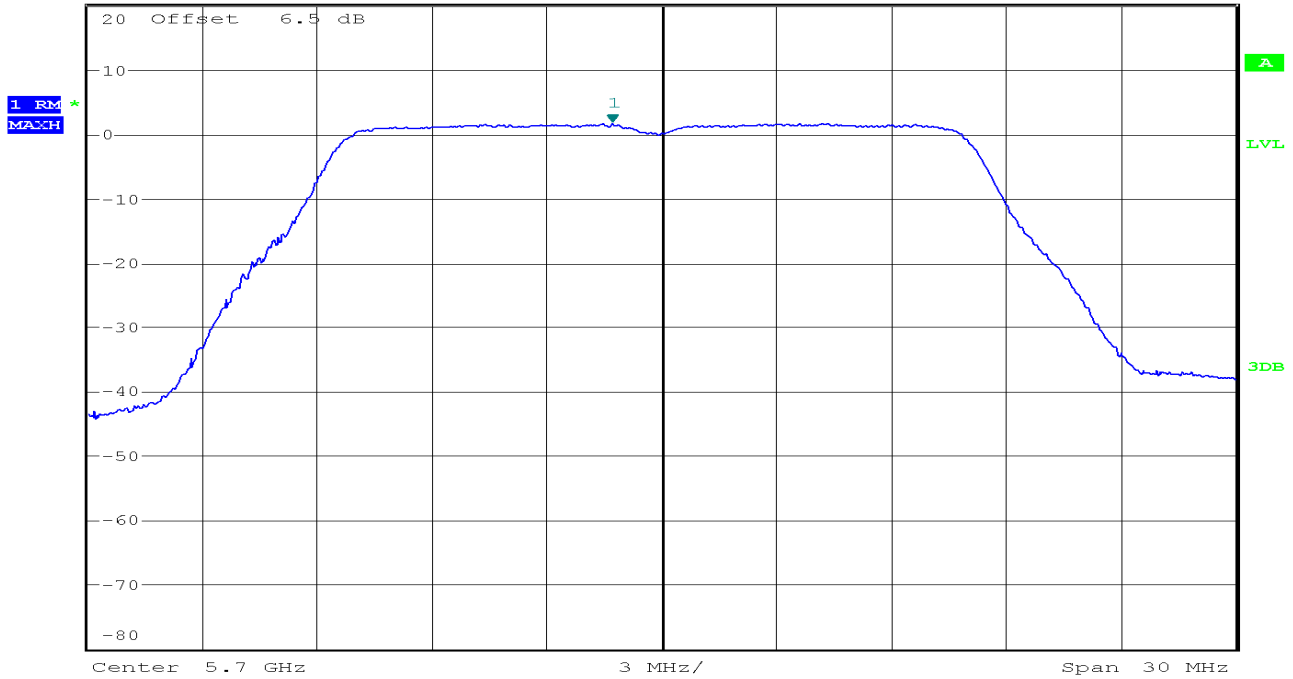

IEEE 802.11a mode/chain 1:

5150~5250MHz

CH Low



Ref 20 dBm * Att 20 dB * RBW 1 MHz Marker 1 [T1] 3.71 dBm
 * VBW 3 MHz 5.178701923 GHz
 SWT 20 ms

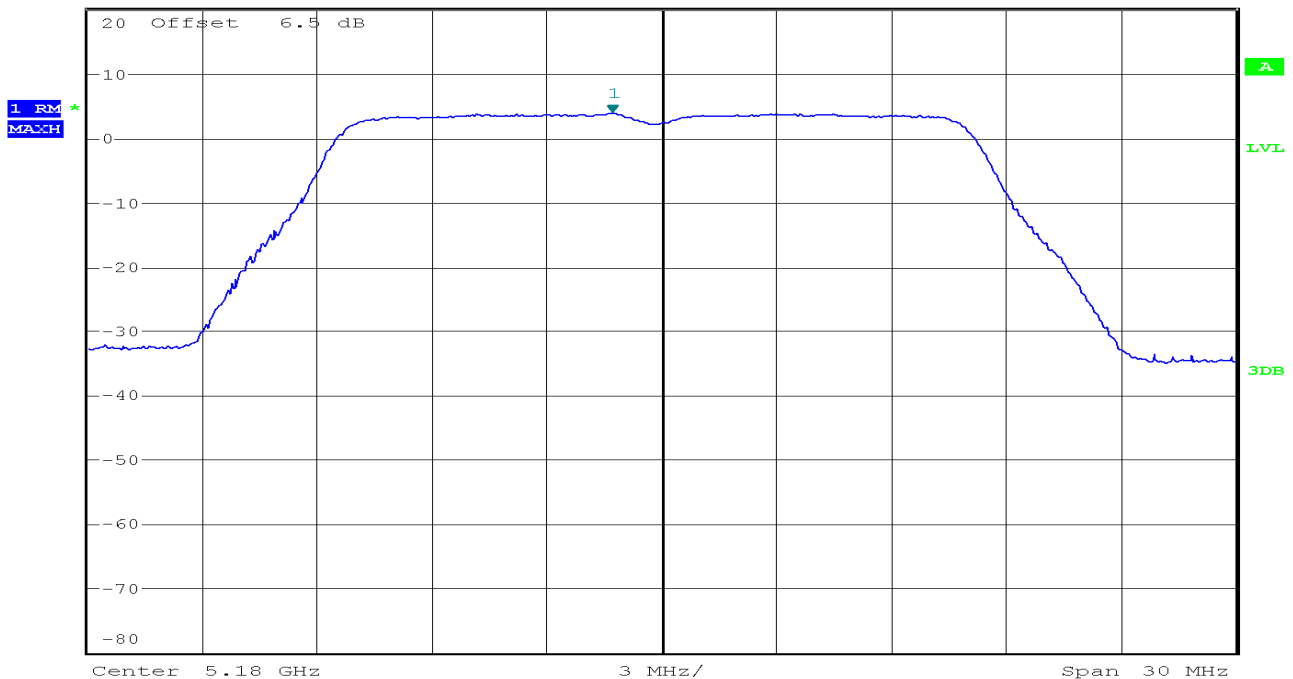

5250~5350MHz

CH Low

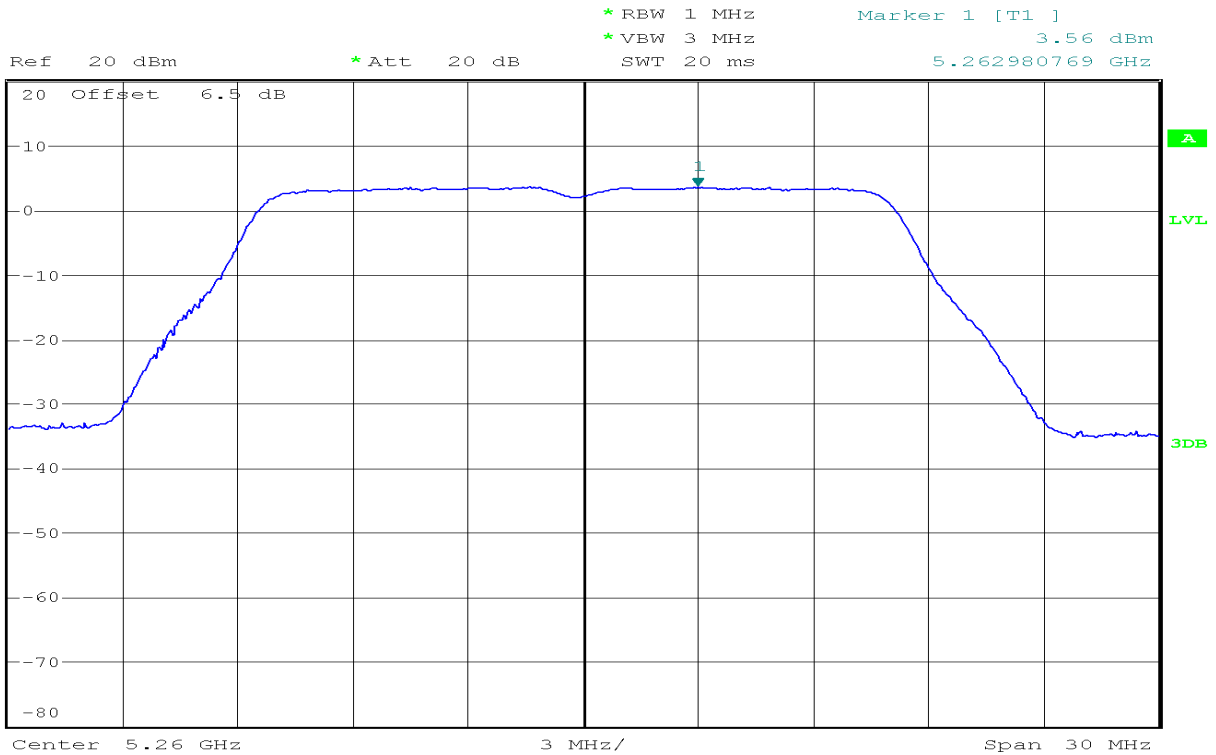

CH Mid

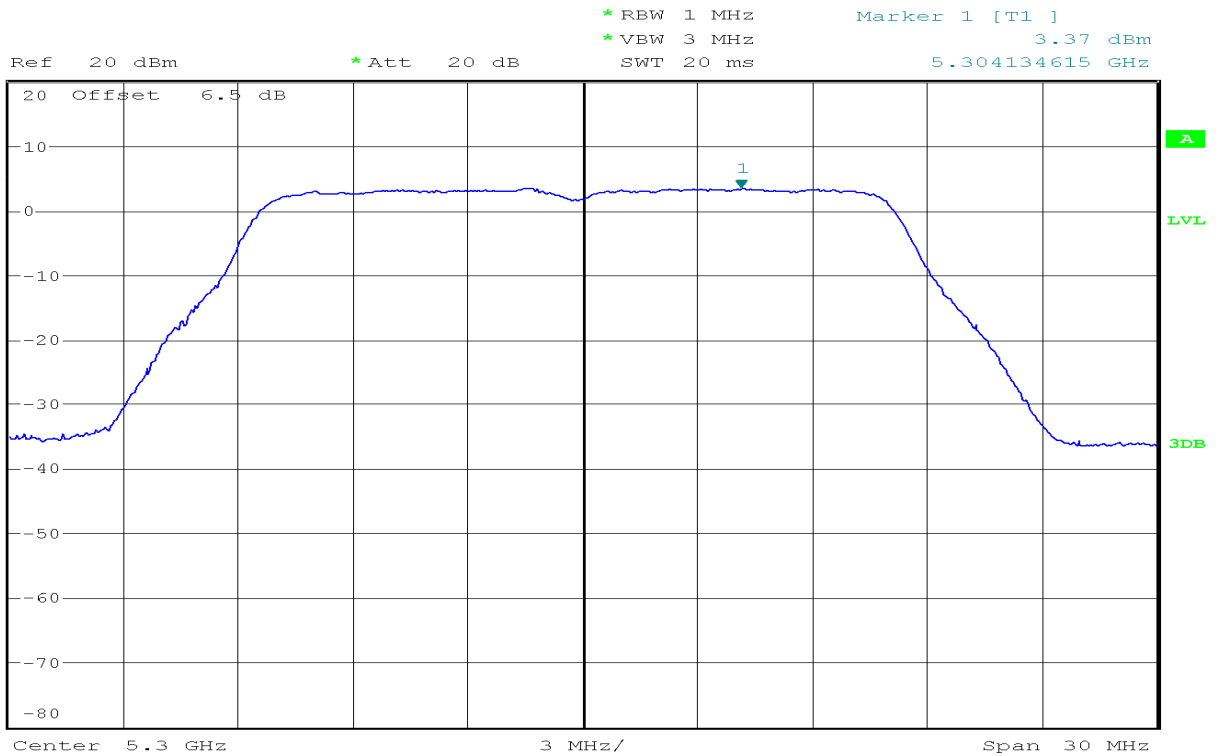

CH High



Ref 20 dBm * Att 20 dB * RBW 1 MHz Marker 1 [T1] 3.08 dBm
 * VBW 3 MHz 5.318653846 GHz
 SWT 20 ms

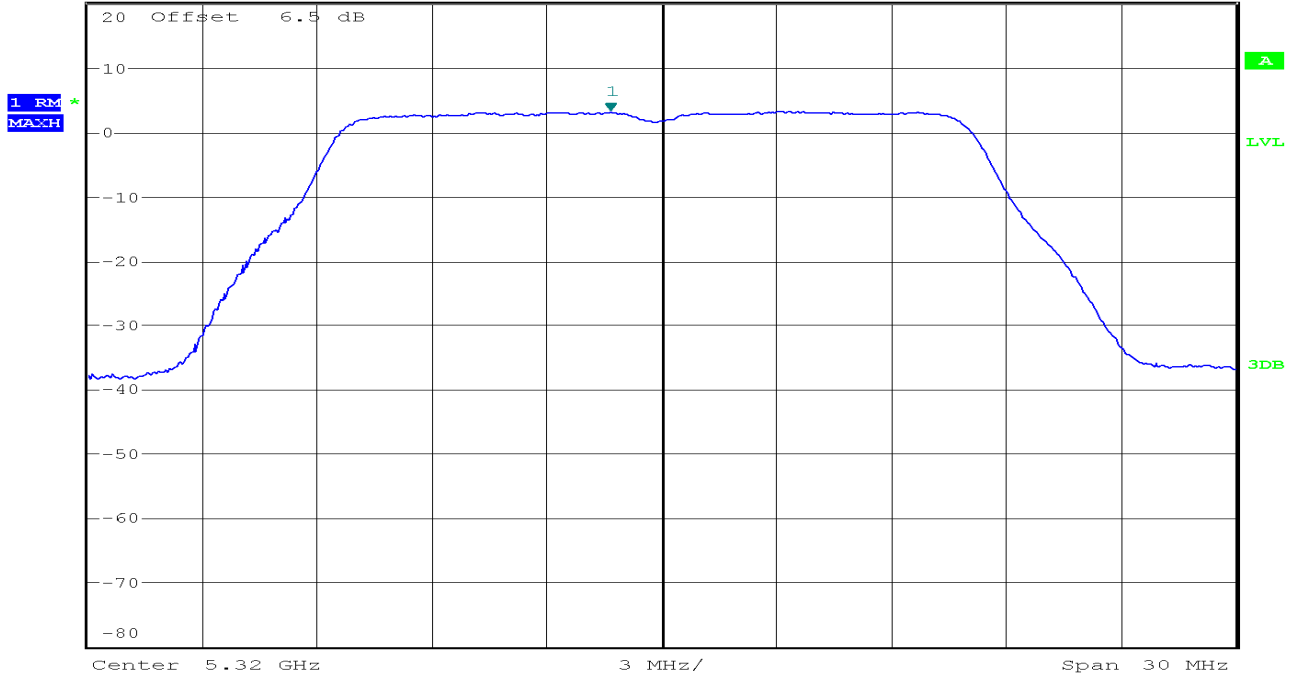

5470~5725MHz

CH Low



Ref 20 dBm * Att 20 dB * RBW 1 MHz Marker 1 [T1] 3.02 dBm
 * VBW 3 MHz 5.498798077 GHz
 SWT 20 ms

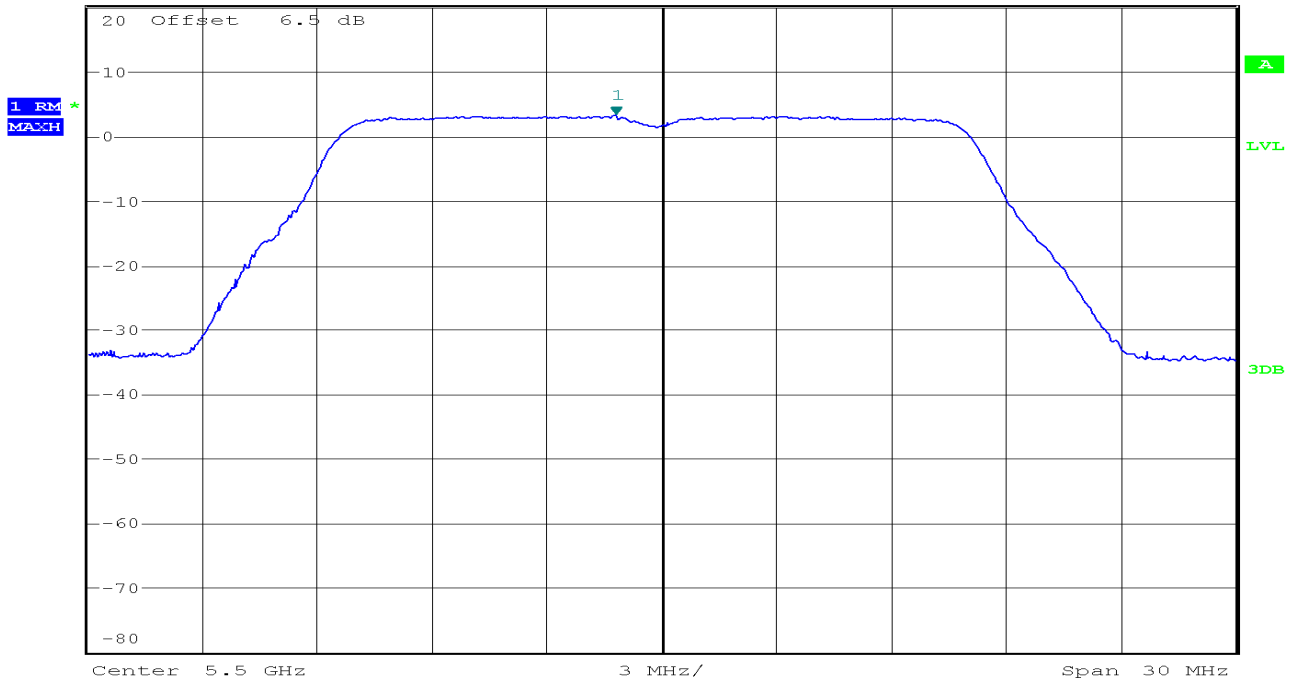

CH Mid



* RBW 1 MHz
* VBW 3 MHz
SWT 20 ms
Marker 1 [T1]
3.04 dBm
5.535096154 GHz

Ref 20 dBm * Att 20 dB

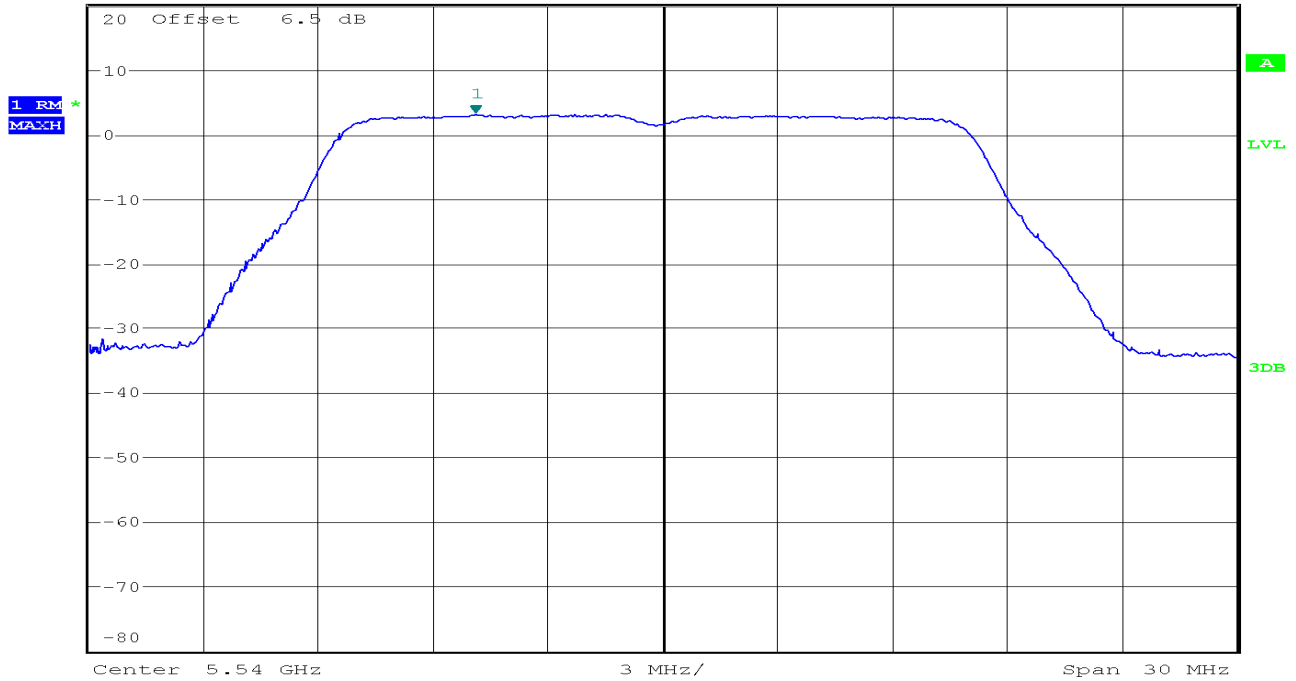

CH High



* RBW 1 MHz
* VBW 3 MHz
SWT 20 ms
Marker 1 [T1]
1.78 dBm
5.704423077 GHz

Ref 20 dBm * Att 20 dB

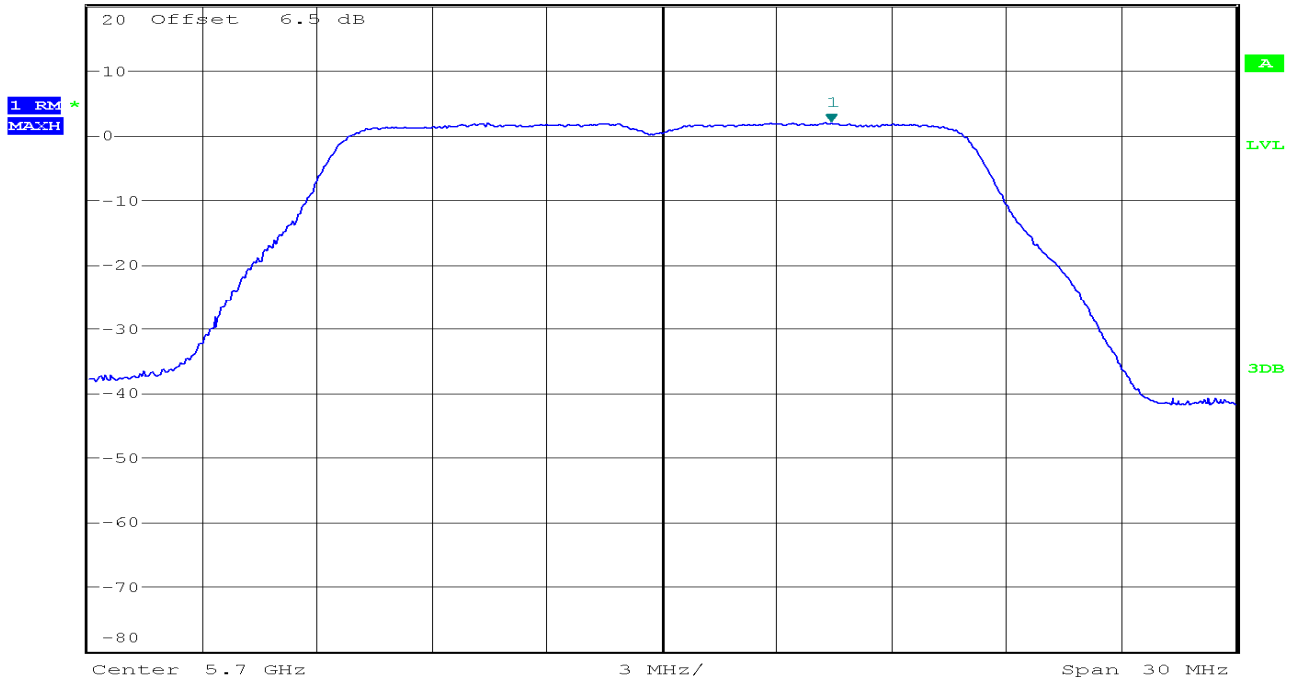

IEEE 802.11n HT20 mode / Chain 0
5150~5250MHz

CH Low



Ref 20 dBm * Att 20 dB * RBW 1 MHz Marker 1 [T1] 4.28 dBm
 * VBW 3 MHz 5.178605769 GHz
 SWT 20 ms

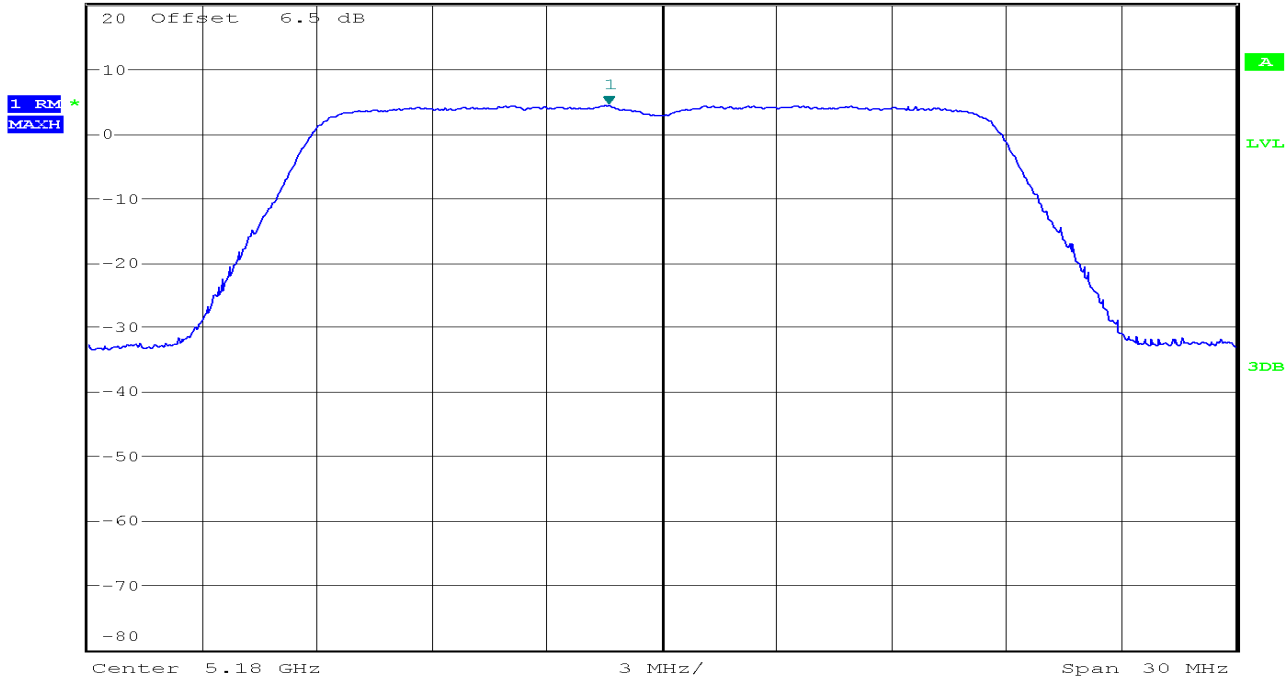

CH Mid



Ref 20 dBm * Att 20 dB * RBW 1 MHz Marker 1 [T1] 4.70 dBm
 * VBW 3 MHz 5.202355769 GHz
 SWT 20 ms

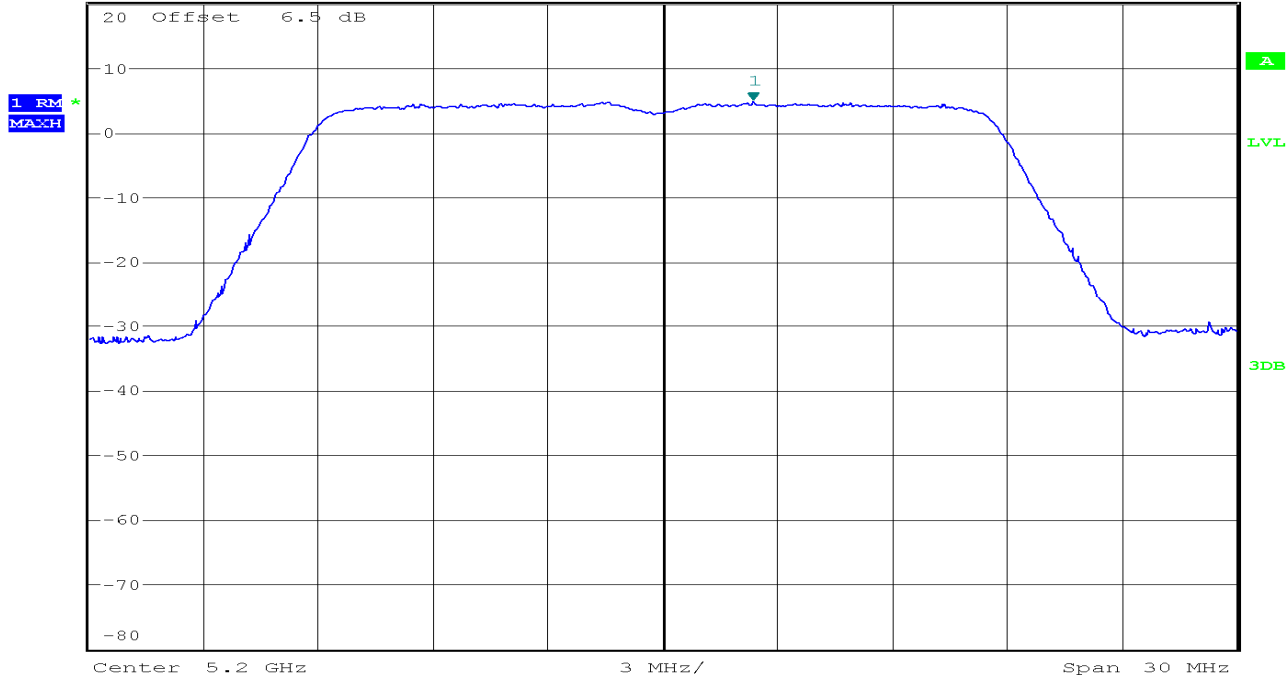

CH High



Ref 20 dBm * Att 20 dB * RBW 1 MHz Marker 1 [T1]
* VBW 3 MHz 4.27 dBm
SWT 20 ms 5.236009615 GHz

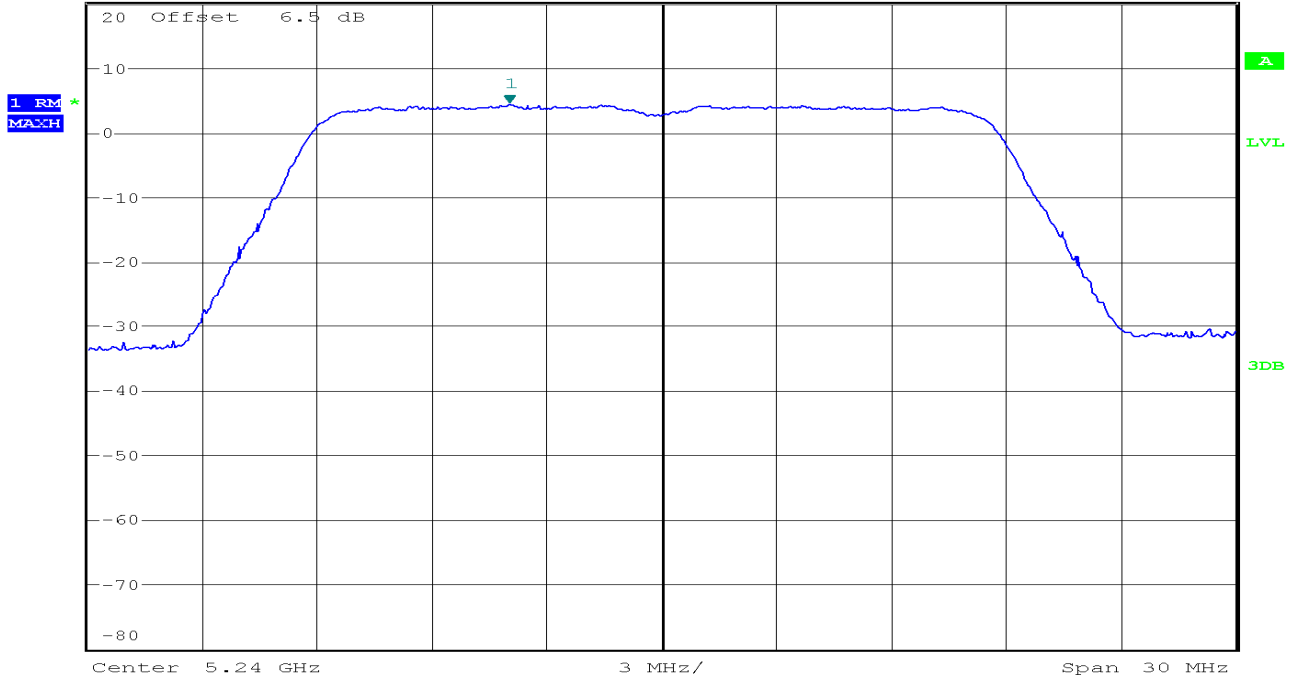

5250~5350MHz

CH Low



Ref 20 dBm * Att 20 dB * RBW 1 MHz Marker 1 [T1]
* VBW 3 MHz 4.11 dBm
SWT 20 ms 5.256057692 GHz

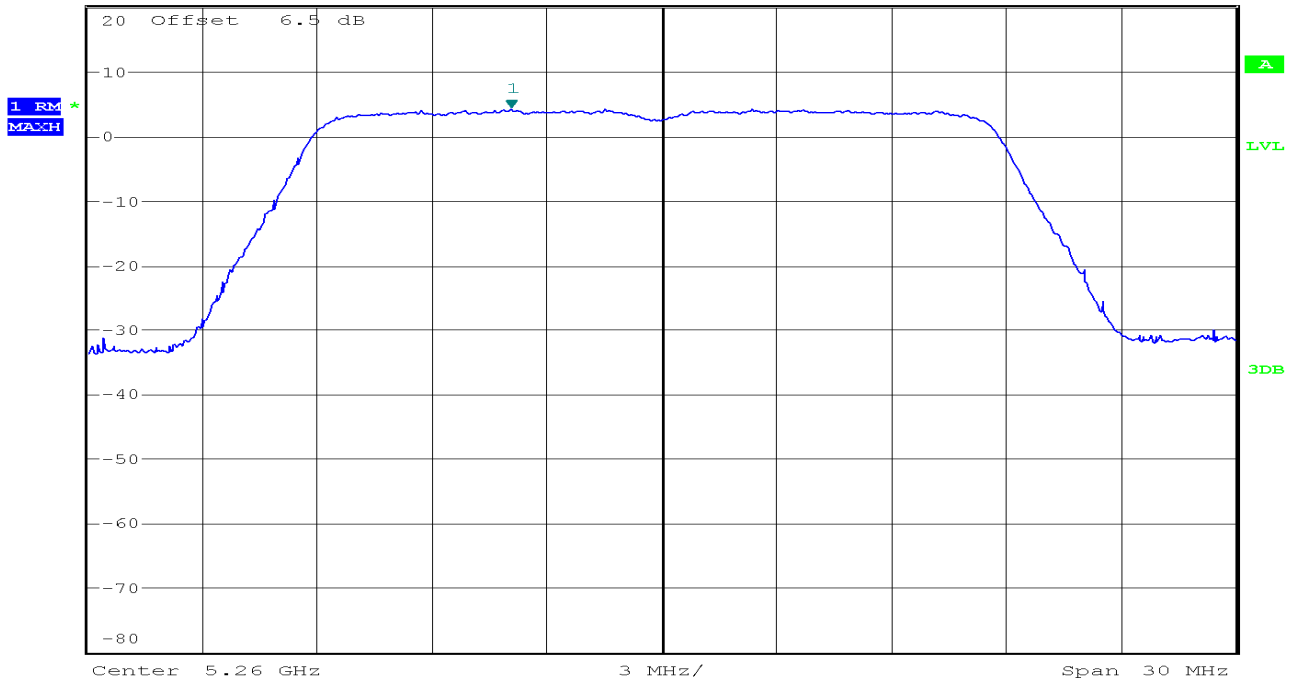

CH Mid



* RBW 1 MHz
* VBW 3 MHz
SWT 20 ms
Marker 1 [T1]
3.85 dBm
5.304807692 GHz

Ref 20 dBm * Att 20 dB

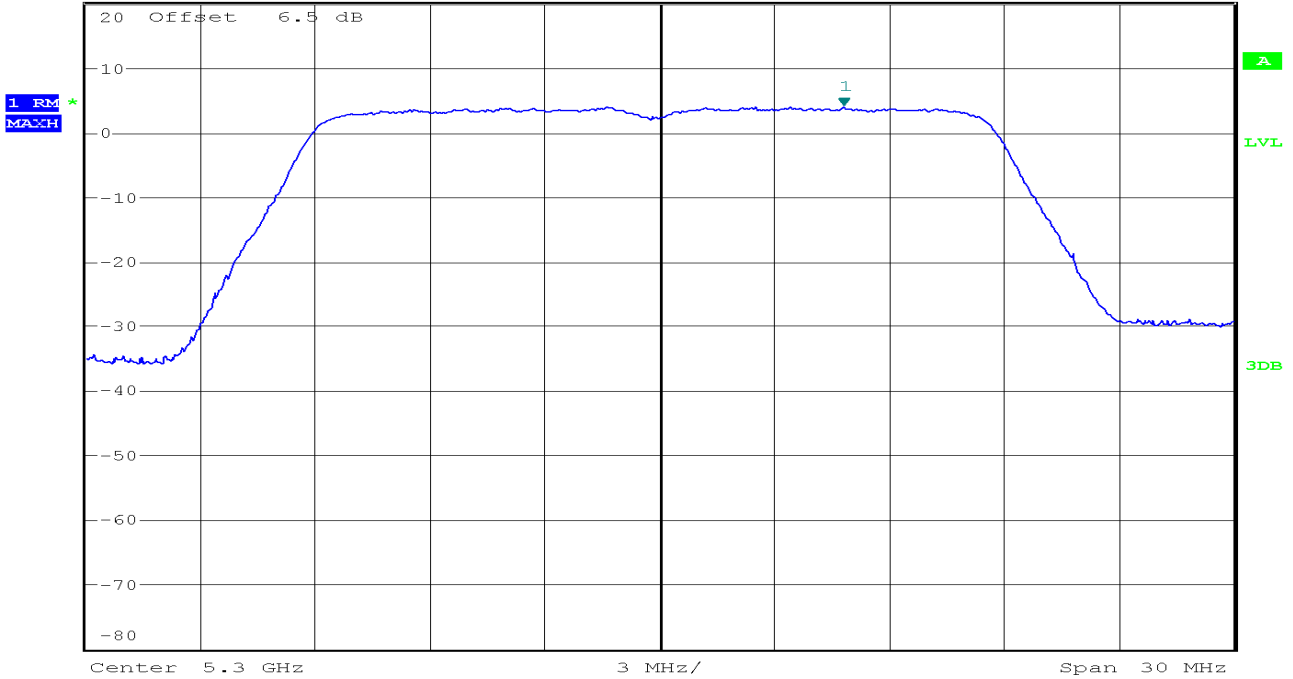

CH High



* RBW 1 MHz
* VBW 3 MHz
SWT 20 ms
Marker 1 [T1]
3.84 dBm
5.323509615 GHz

Ref 20 dBm * Att 20 dB

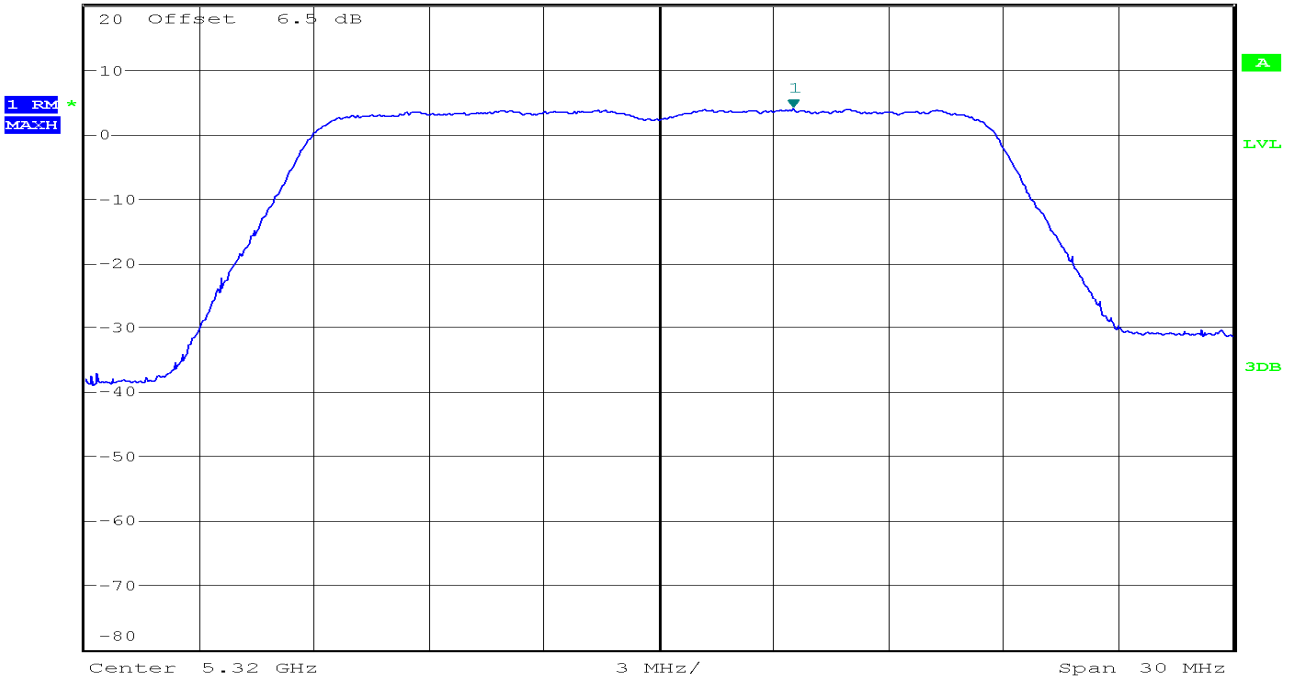

5470~5725MHz

CH Low



Ref 20 dBm * Att 20 dB * RBW 1 MHz Marker 1 [T1]
 * VBW 3 MHz 3.22 dBm
 SWT 20 ms 5.498413462 GHz

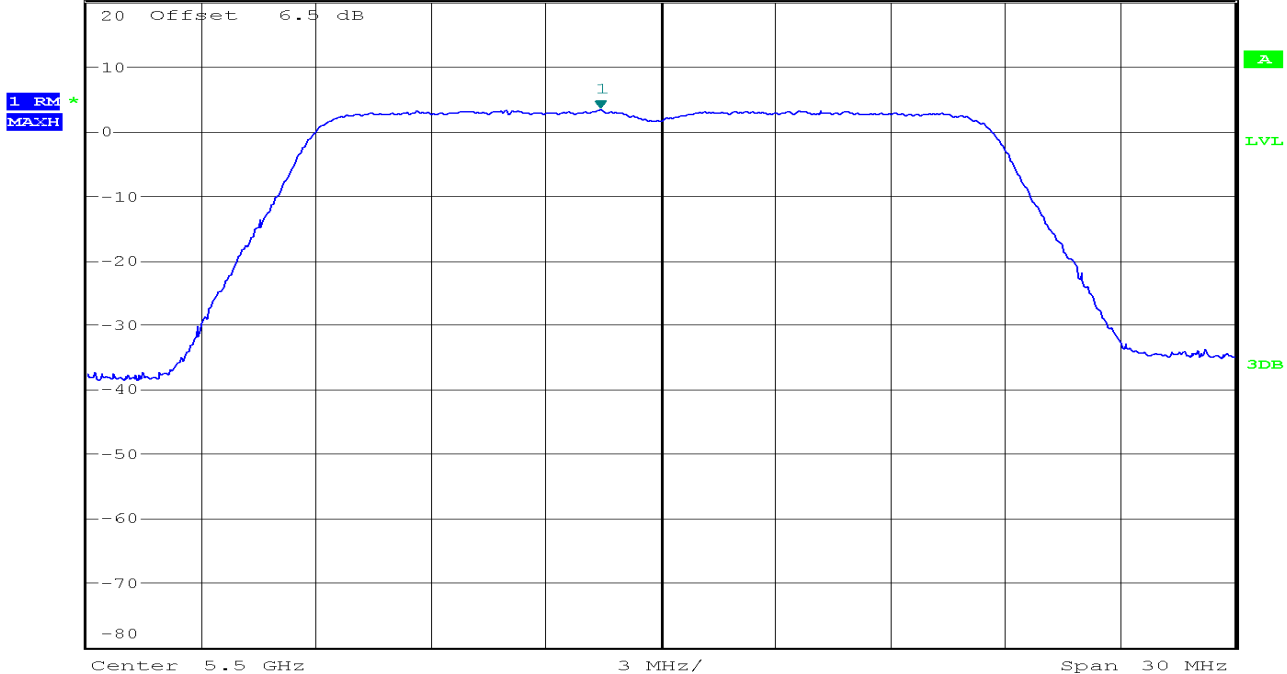

CH Mid



Ref 20 dBm * Att 20 dB * RBW 1 MHz Marker 1 [T1]
 * VBW 3 MHz 3.17 dBm
 SWT 20 ms 5.538653846 GHz

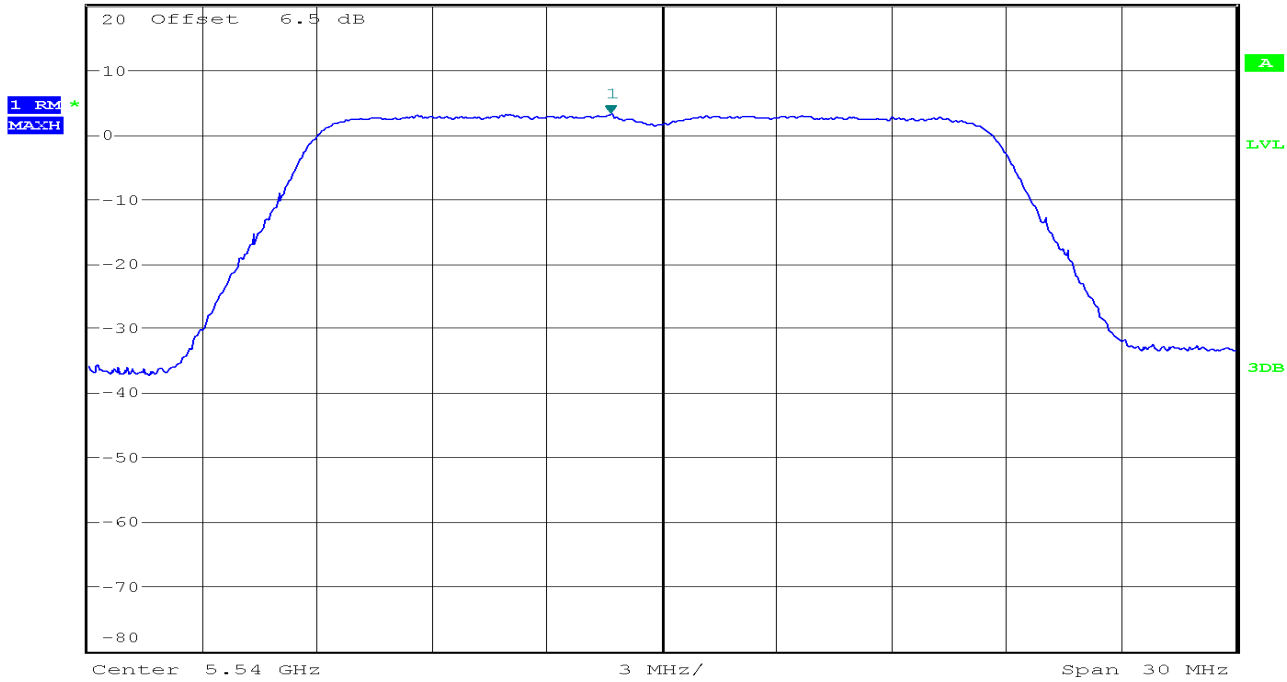

CH High



Ref 20 dBm * Att 20 dB * RBW 1 MHz Marker 1 [T1] 1.29 dBm
 * VBW 3 MHz 5.702259615 GHz
 SWT 20 ms

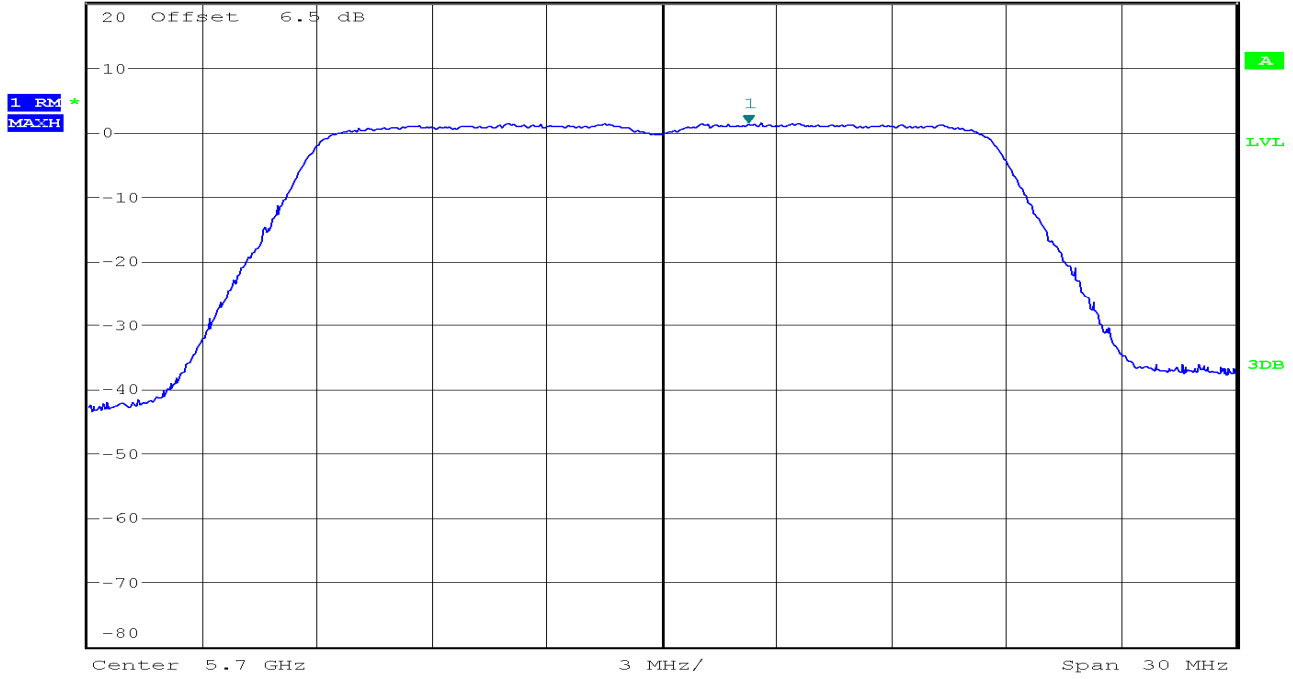

IEEE 802.11n HT20 mode / Chain 1
5150~5250MHz

CH Low



Ref 20 dBm * Att 20 dB * RBW 1 MHz Marker 1 [T1] 3.46 dBm
 * VBW 3 MHz 5.176057692 GHz
 SWT 20 ms

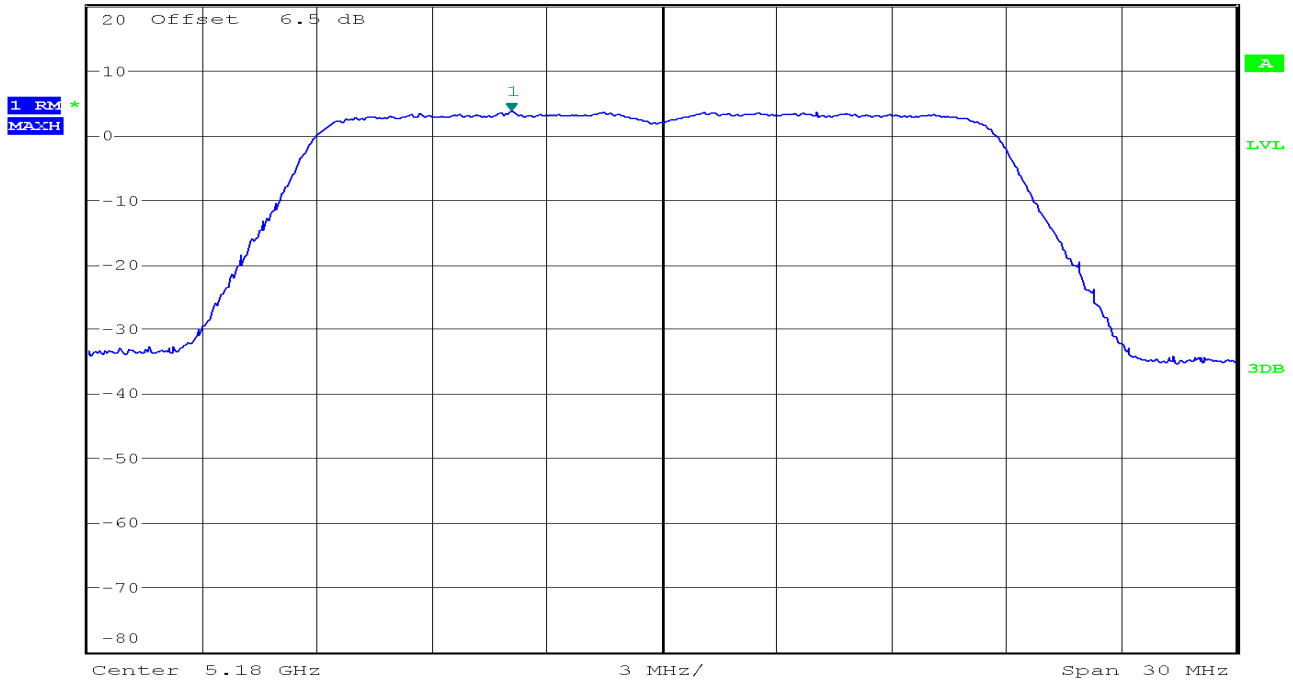

CH Mid



Ref 20 dBm * Att 20 dB * RBW 1 MHz Marker 1 [T1] 3.93 dBm
 * VBW 3 MHz SWT 20 ms 5.202548077 GHz

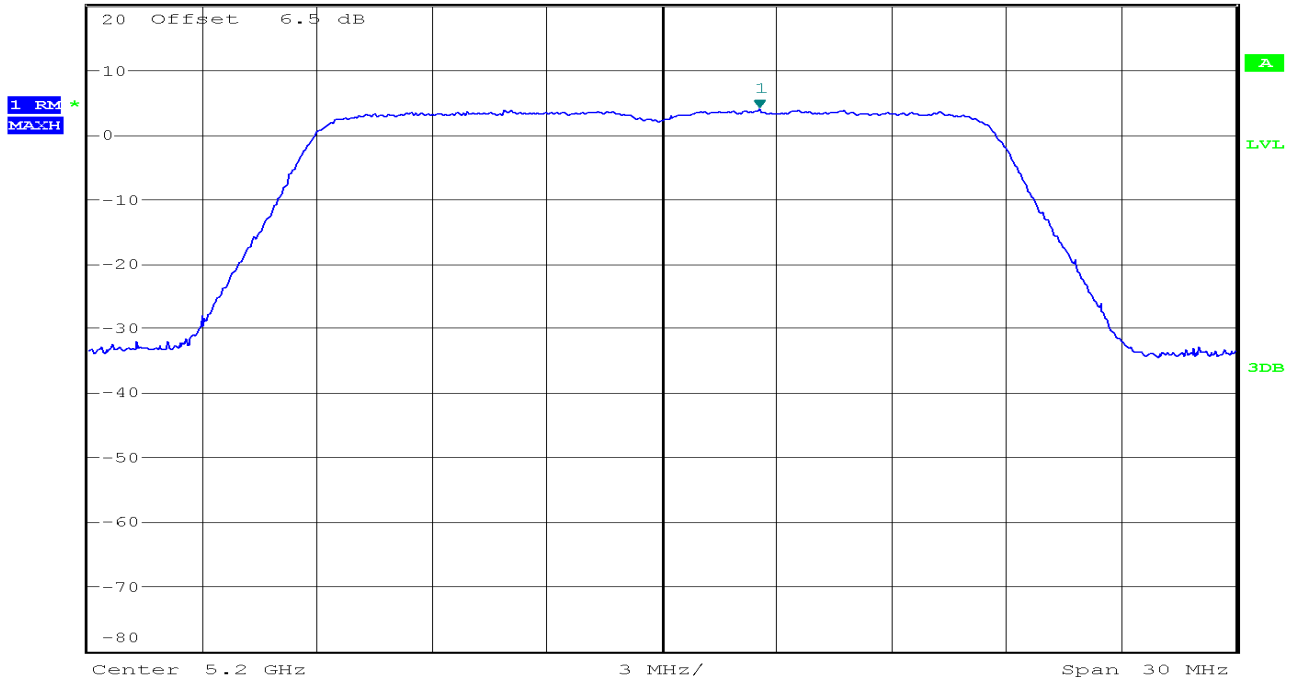

CH High



Ref 20 dBm * Att 20 dB * RBW 1 MHz Marker 1 [T1] 3.39 dBm
 * VBW 3 MHz SWT 20 ms 5.238461538 GHz

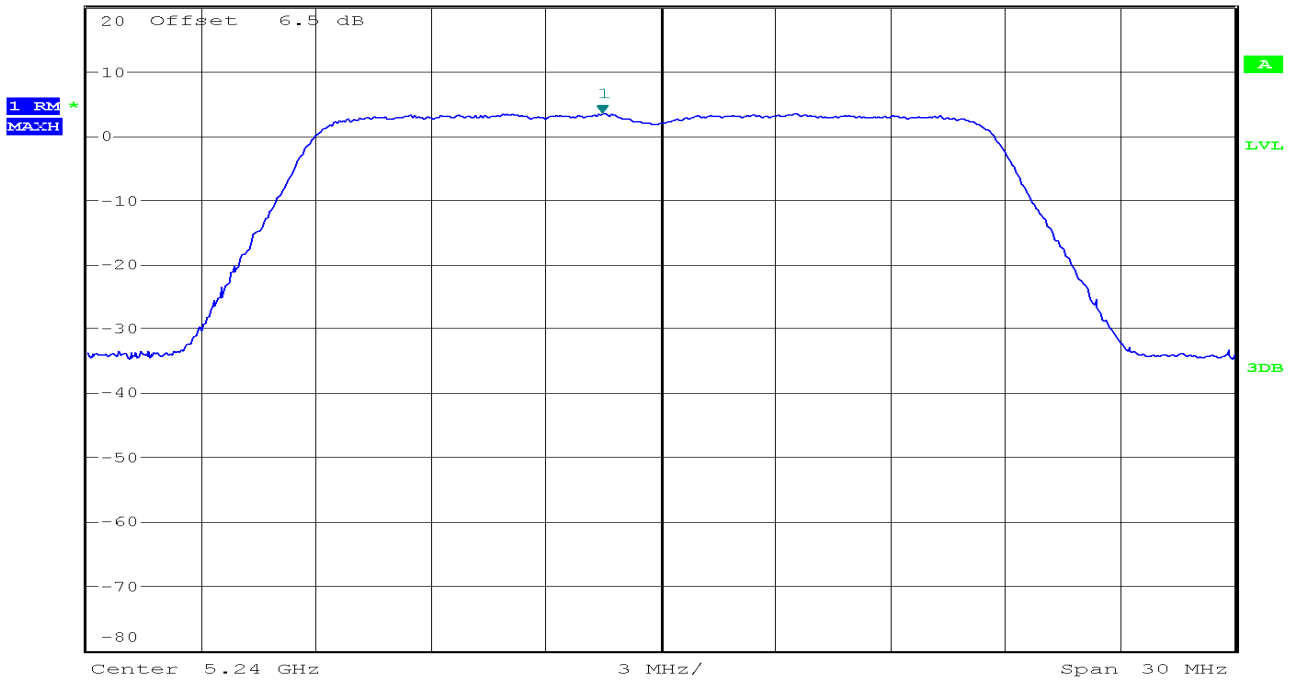

5250~5350MHz

CH Low



Ref 20 dBm * Att 20 dB * RBW 1 MHz Marker 1 [T1]
 * VBW 3 MHz 3.23 dBm
 SWT 20 ms 5.261250000 GHz

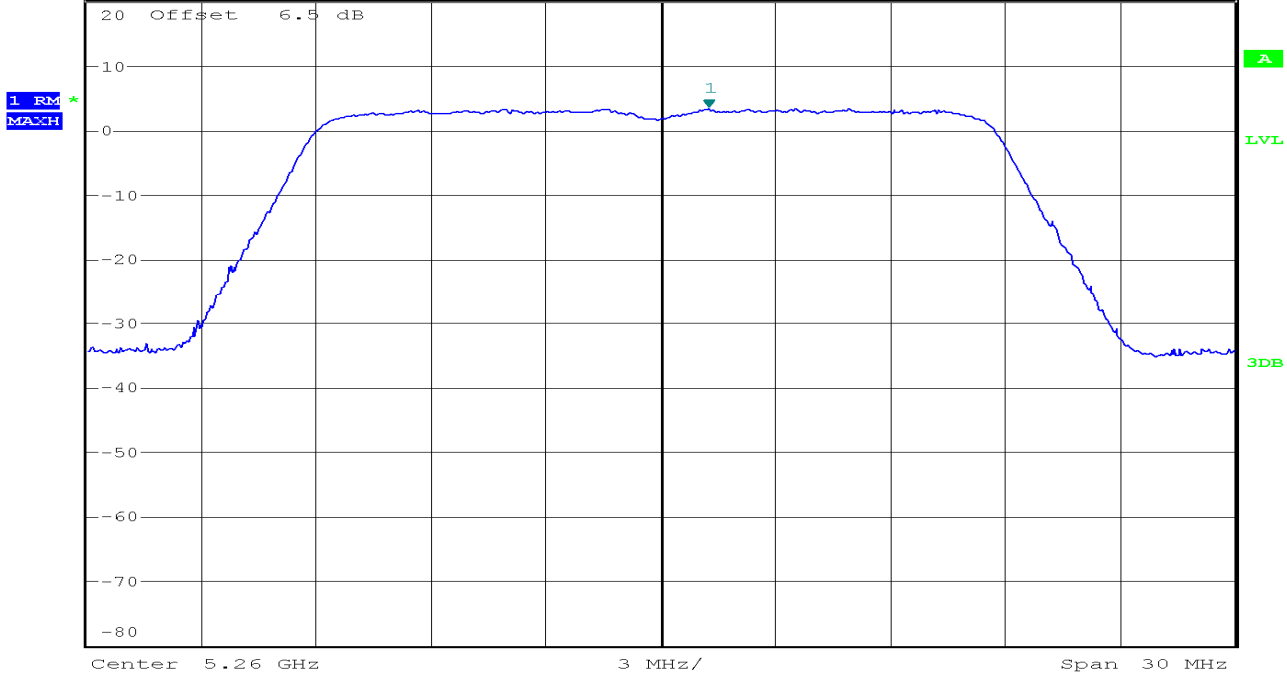

CH Mid



Ref 20 dBm * Att 20 dB * RBW 1 MHz Marker 1 [T1]
 * VBW 3 MHz 3.01 dBm
 SWT 20 ms 5.298557692 GHz

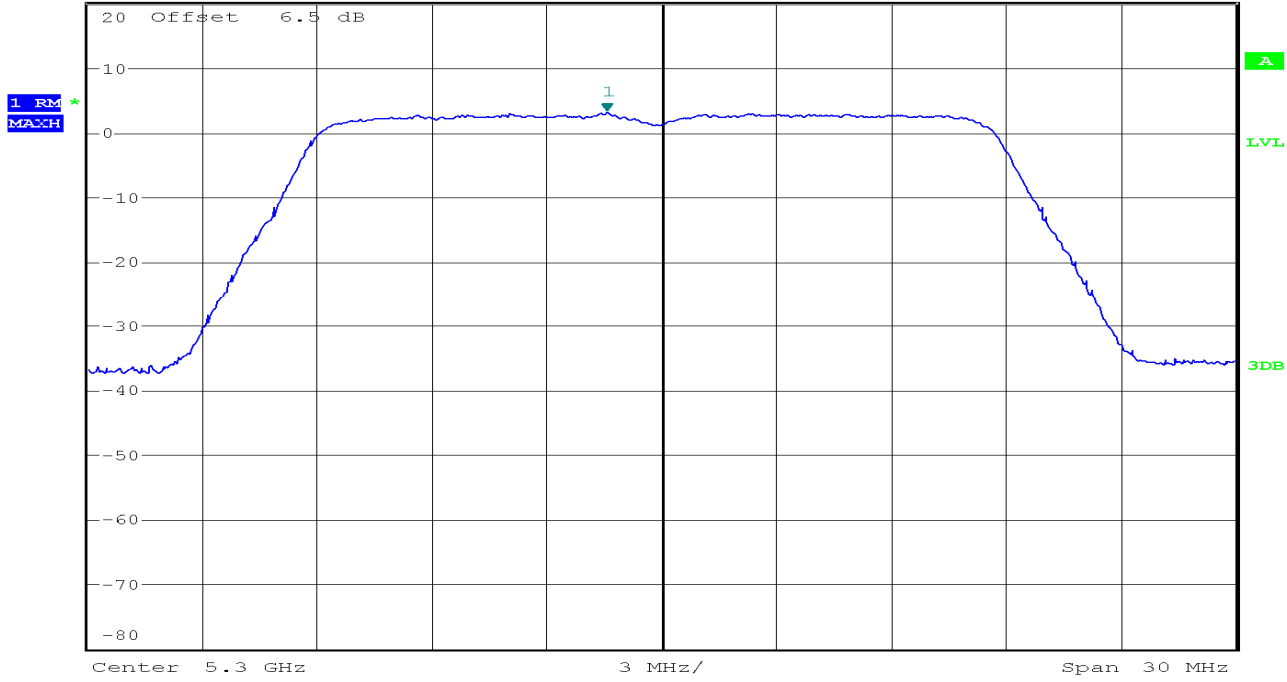

CH High



Ref 20 dBm * Att 20 dB * RBW 1 MHz Marker 1 [T1] 3.25 dBm
 * VBW 3 MHz 5.323605769 GHz
 SWT 20 ms

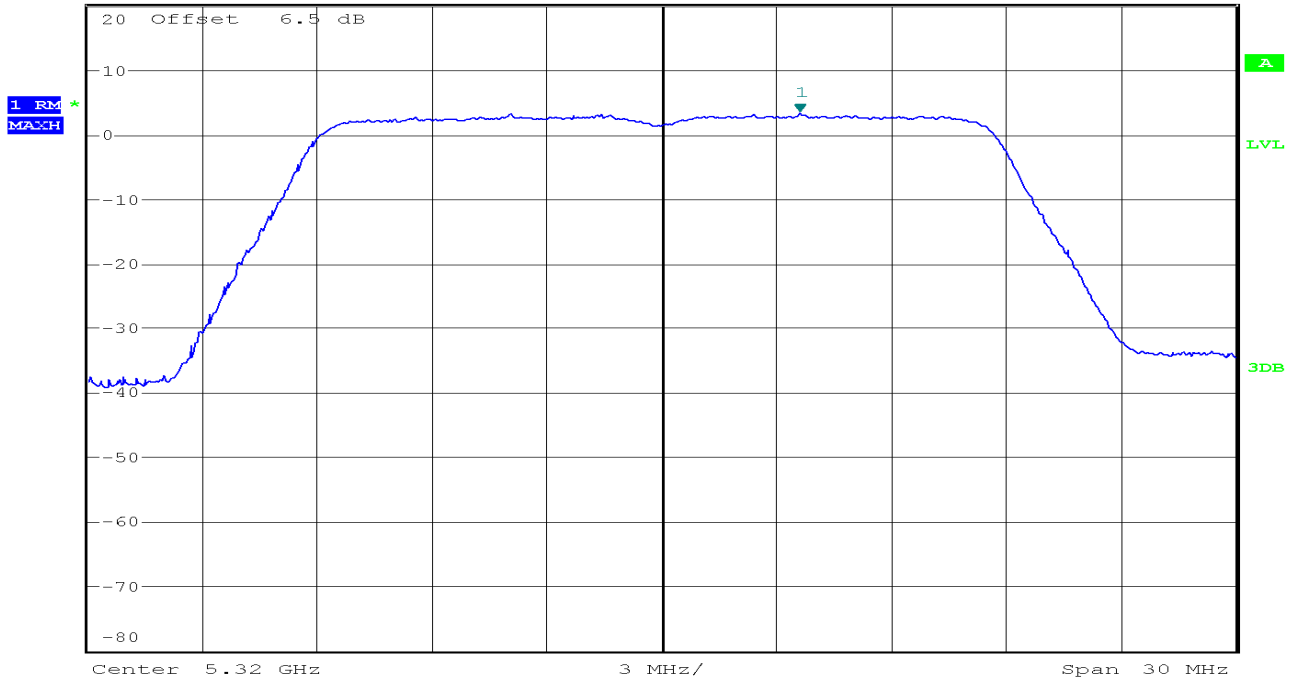

5470~5725MHz

CH Low



Ref 20 dBm * Att 20 dB * RBW 1 MHz Marker 1 [T1] 2.85 dBm
 * VBW 3 MHz 5.498461538 GHz
 SWT 20 ms

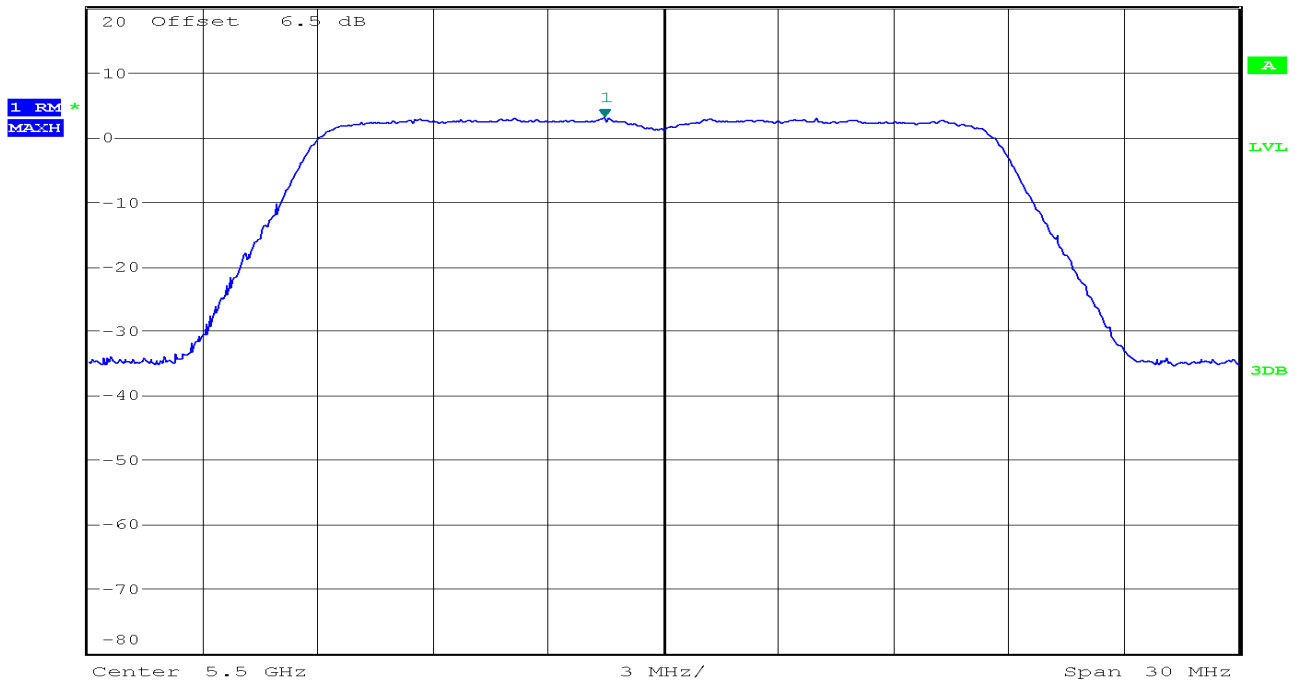

CH Mid



* RBW 1 MHz
 * VBW 3 MHz
 Marker 1 [T1]
 2.87 dBm
 5.538509615 GHz

Ref 20 dBm * Att 20 dB SWT 20 ms

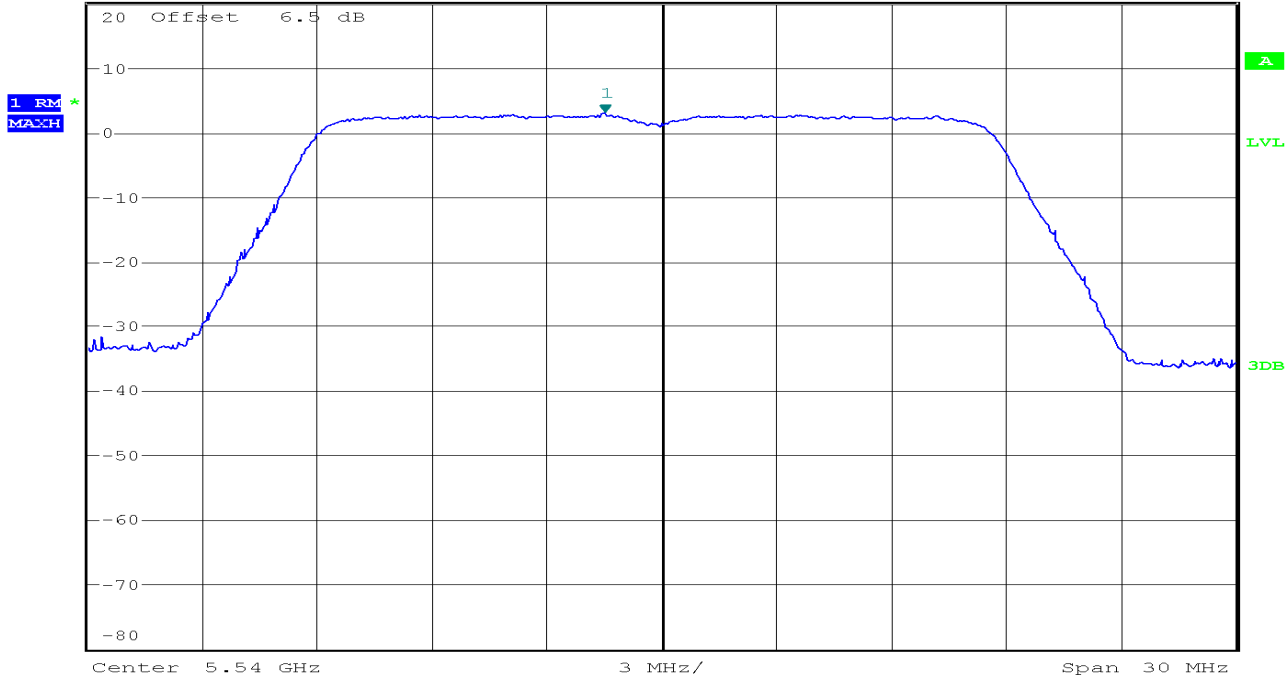

CH High



* RBW 1 MHz
 * VBW 3 MHz
 Marker 1 [T1]
 1.71 dBm
 5.703557692 GHz

Ref 20 dBm * Att 20 dB SWT 20 ms

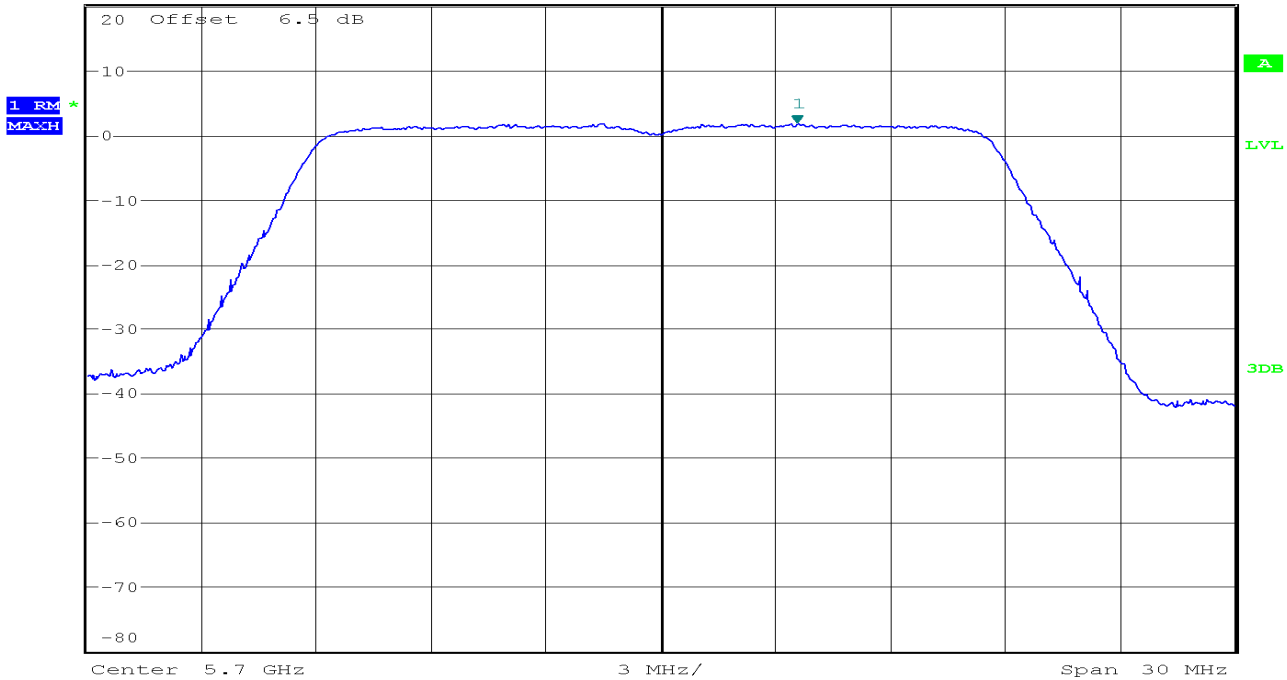

IEEE 802.11n HT40 mode / Chain 0
5150~5250MHz

CH Low

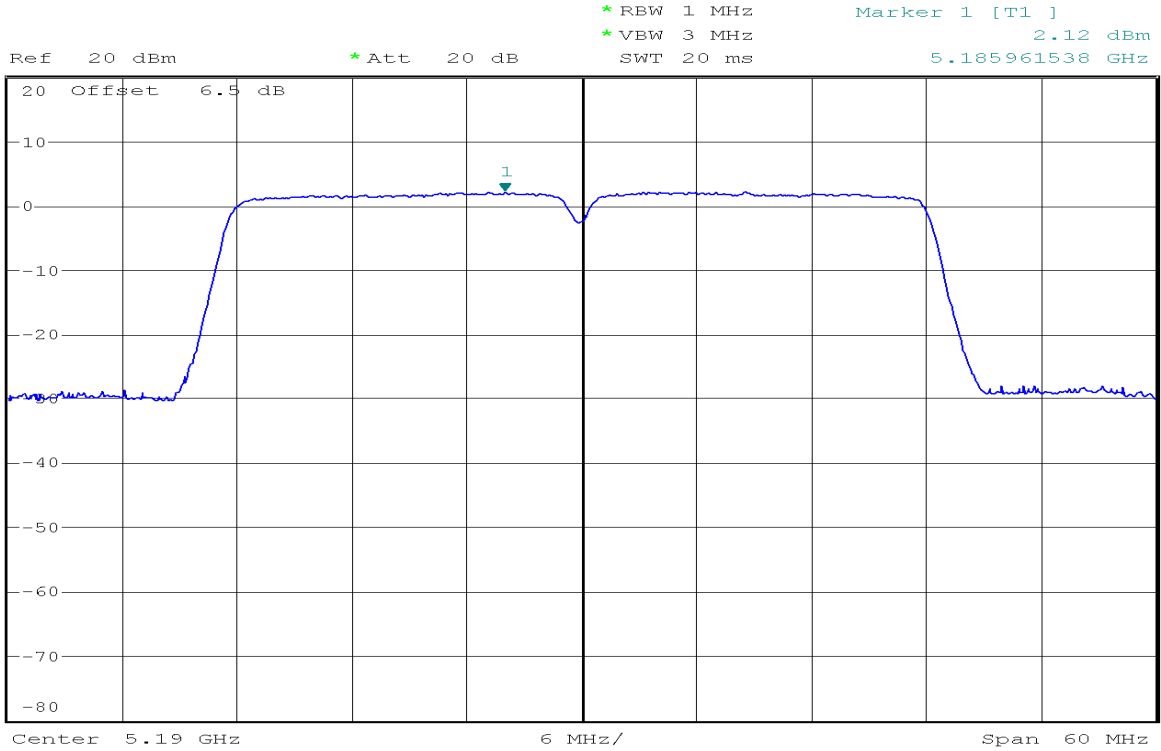

CH High

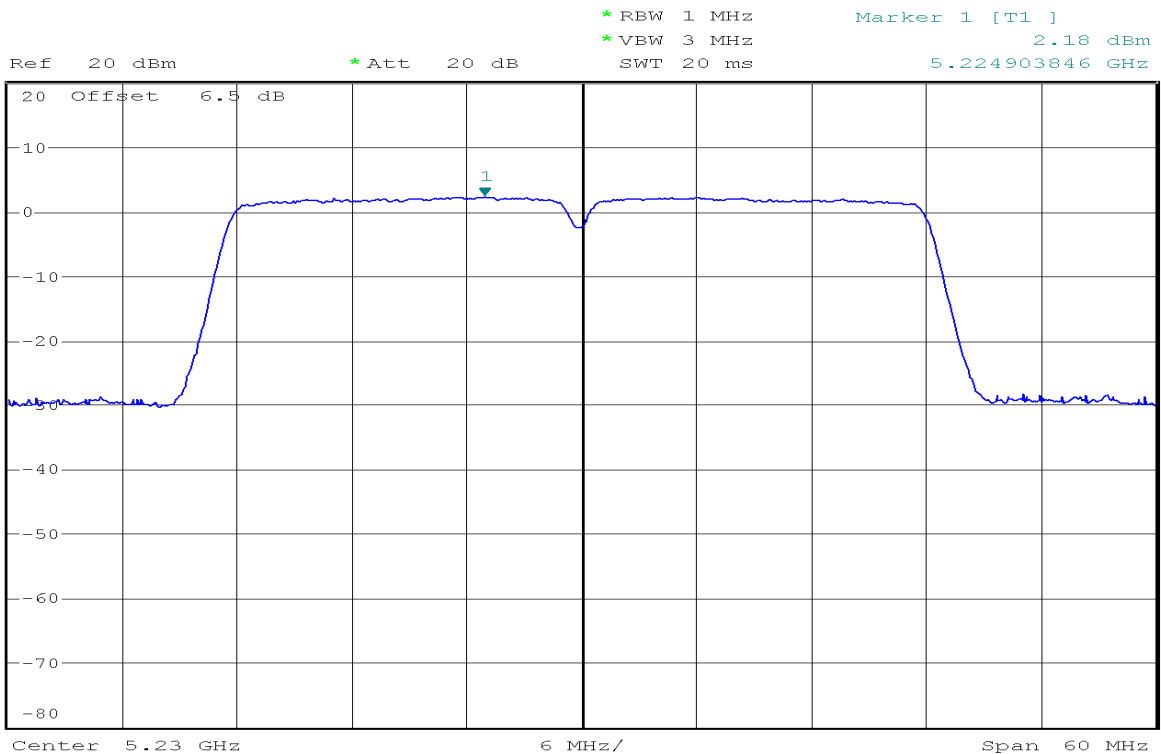

5250~5350MHz

CH Low



Ref 20 dBm * Att 20 dB * RBW 1 MHz Marker 1 [T1] 1.94 dBm
 * VBW 3 MHz 5.274423077 GHz
 SWT 20 ms

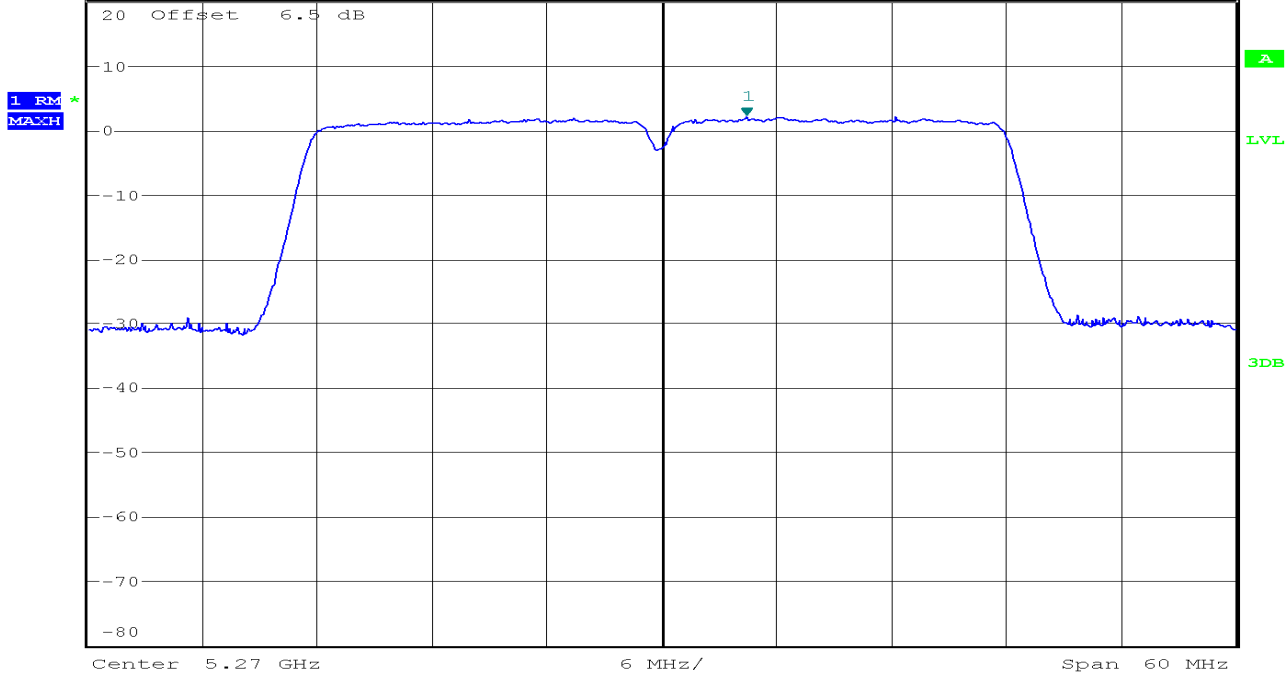

CH High



Ref 20 dBm * Att 20 dB * RBW 1 MHz Marker 1 [T1] 1.75 dBm
 * VBW 3 MHz 5.315961538 GHz
 SWT 20 ms

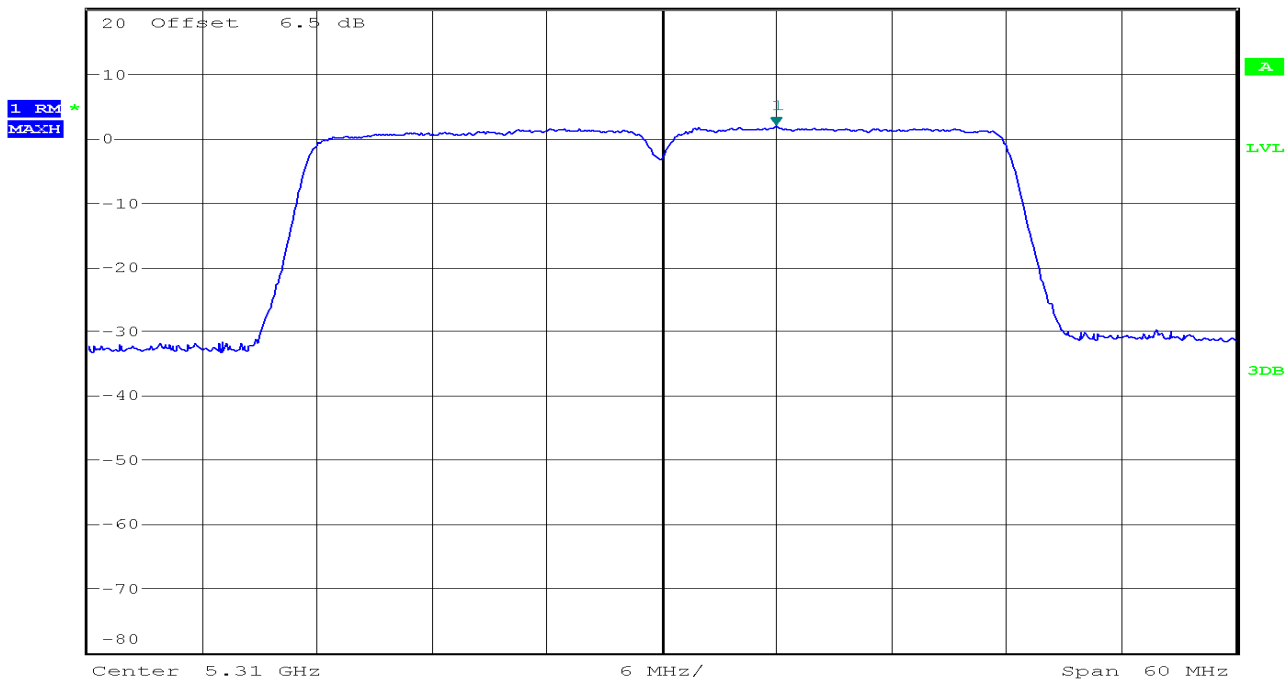

5470~5725MHz

CH Low



Ref 20 dBm * Att 20 dB * RBW 1 MHz Marker 1 [T1]
 * VBW 3 MHz 0.88 dBm
 SWT 20 ms 5.505865385 GHz

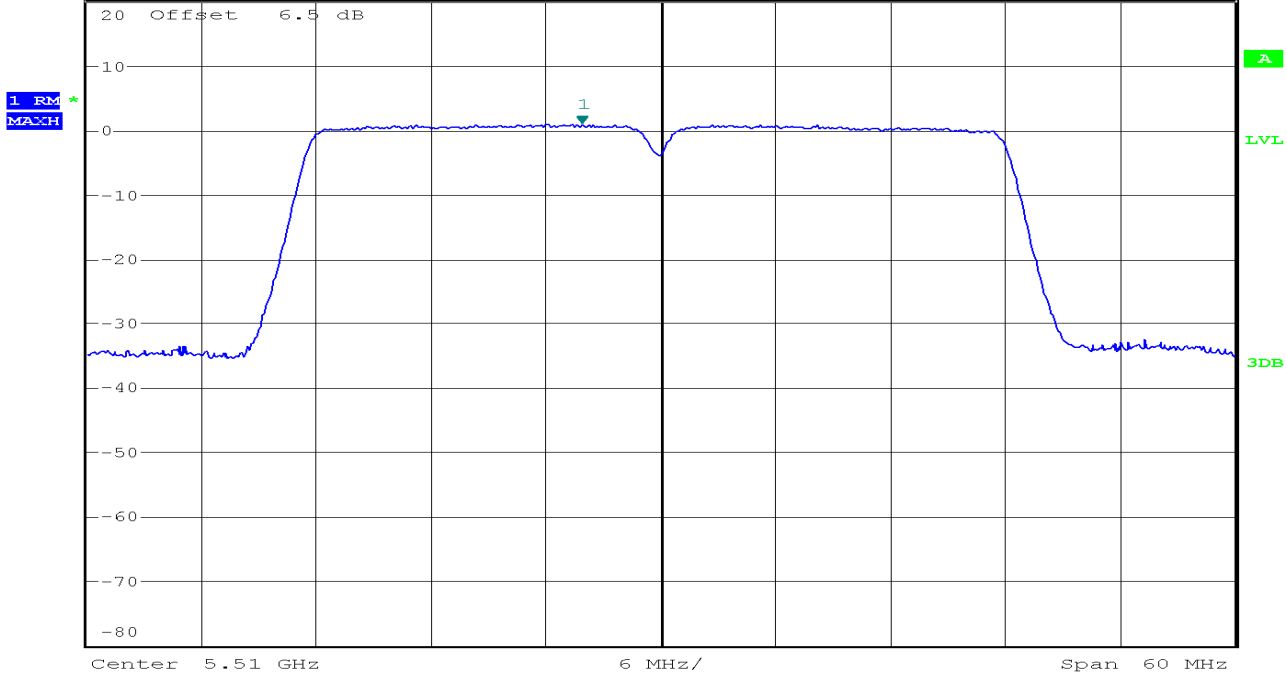

CH Mid



Ref 20 dBm * Att 20 dB * RBW 1 MHz Marker 1 [T1]
 * VBW 3 MHz 0.82 dBm
 SWT 20 ms 5.546153846 GHz

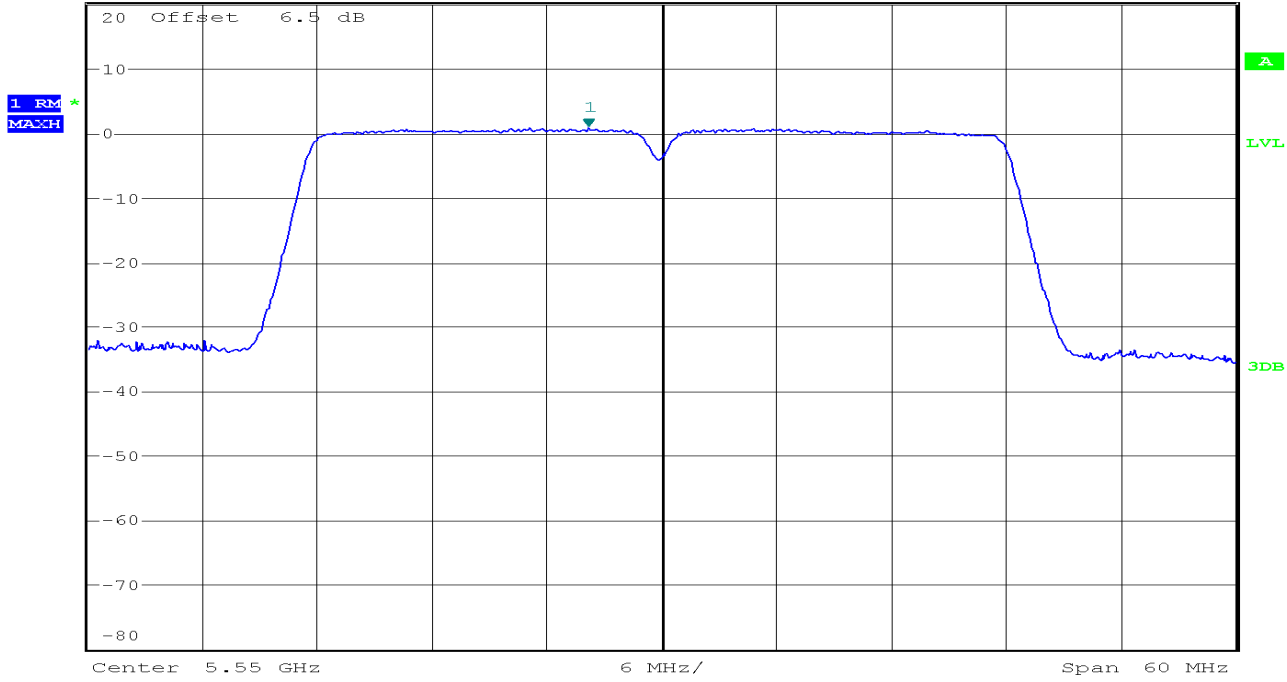

CH High



Ref 20 dBm * Att 20 dB * RBW 1 MHz Marker 1 [T1]
 * VBW 3 MHz -0.37 dBm
 SWT 20 ms 5.673942308 GHz

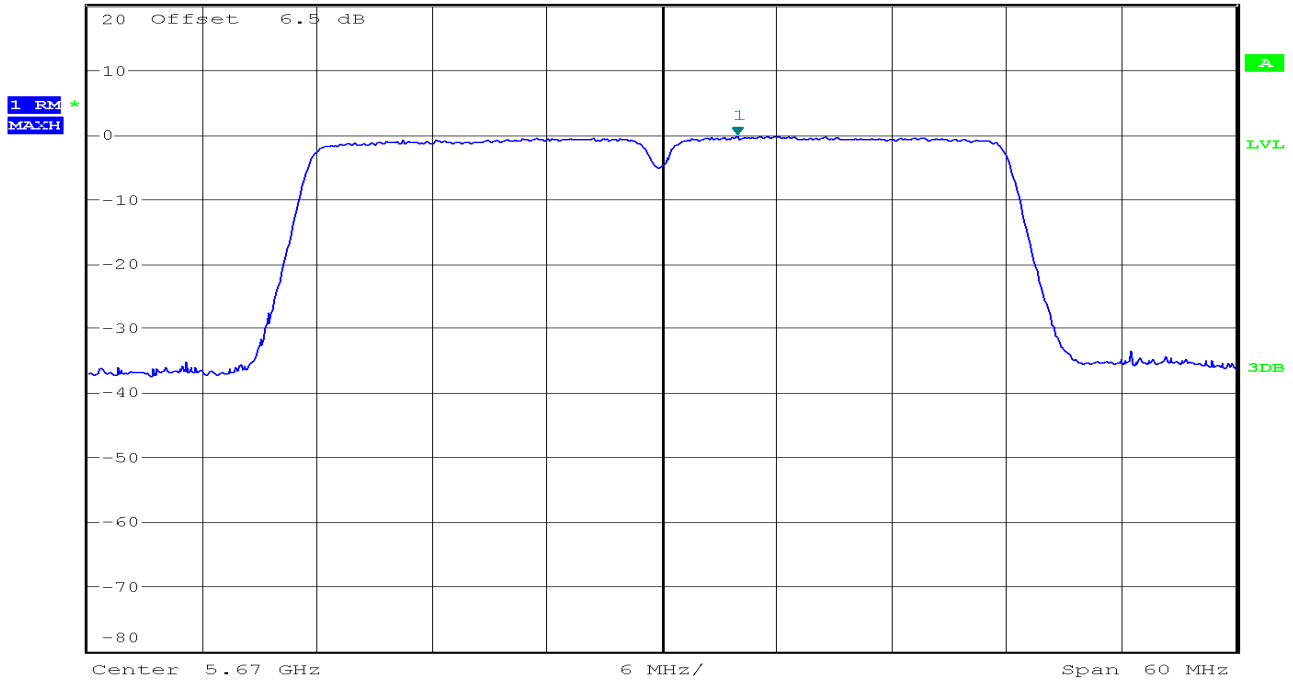

IEEE 802.11n HT40 mode / Chain 1
5150~5250MHz

CH Low



Ref 20 dBm * Att 20 dB * RBW 1 MHz Marker 1 [T1]
 * VBW 3 MHz 1.15 dBm
 SWT 20 ms 5.202692308 GHz

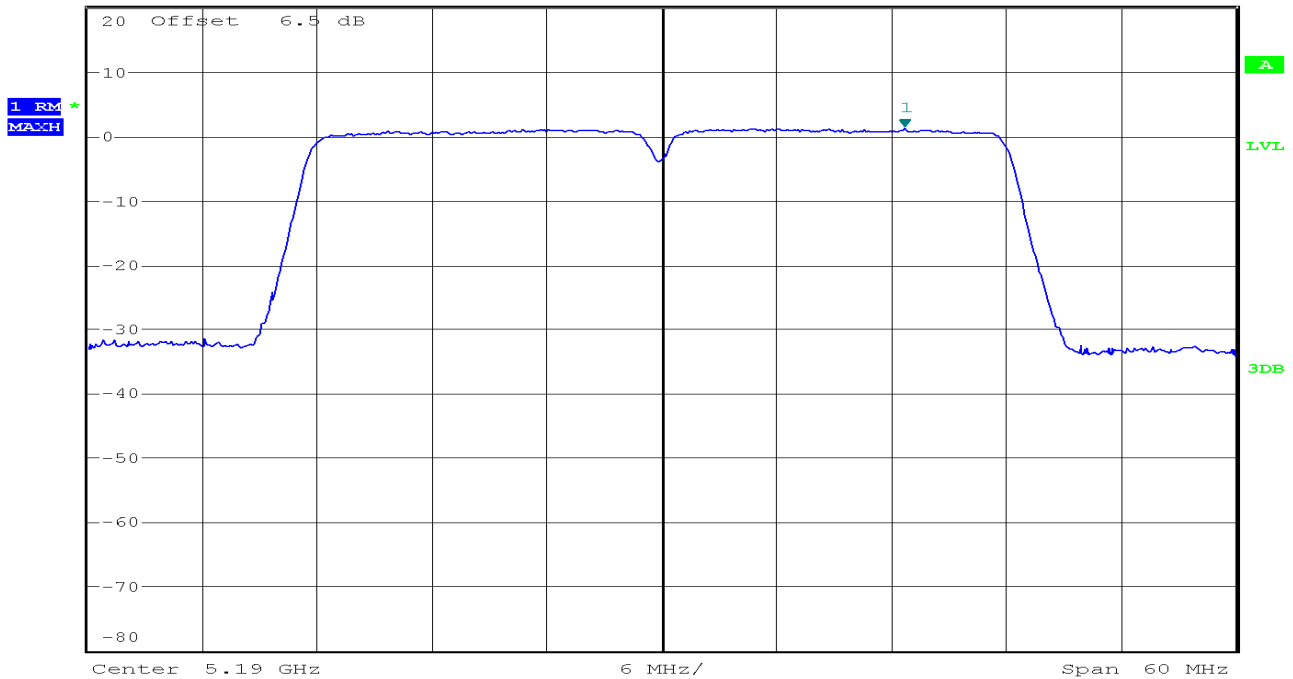

CH High



Ref 20 dBm * Att 20 dB * RBW 1 MHz Marker 1 [T1]
 * VBW 3 MHz 1.20 dBm
 SWT 20 ms 5.236153846 GHz

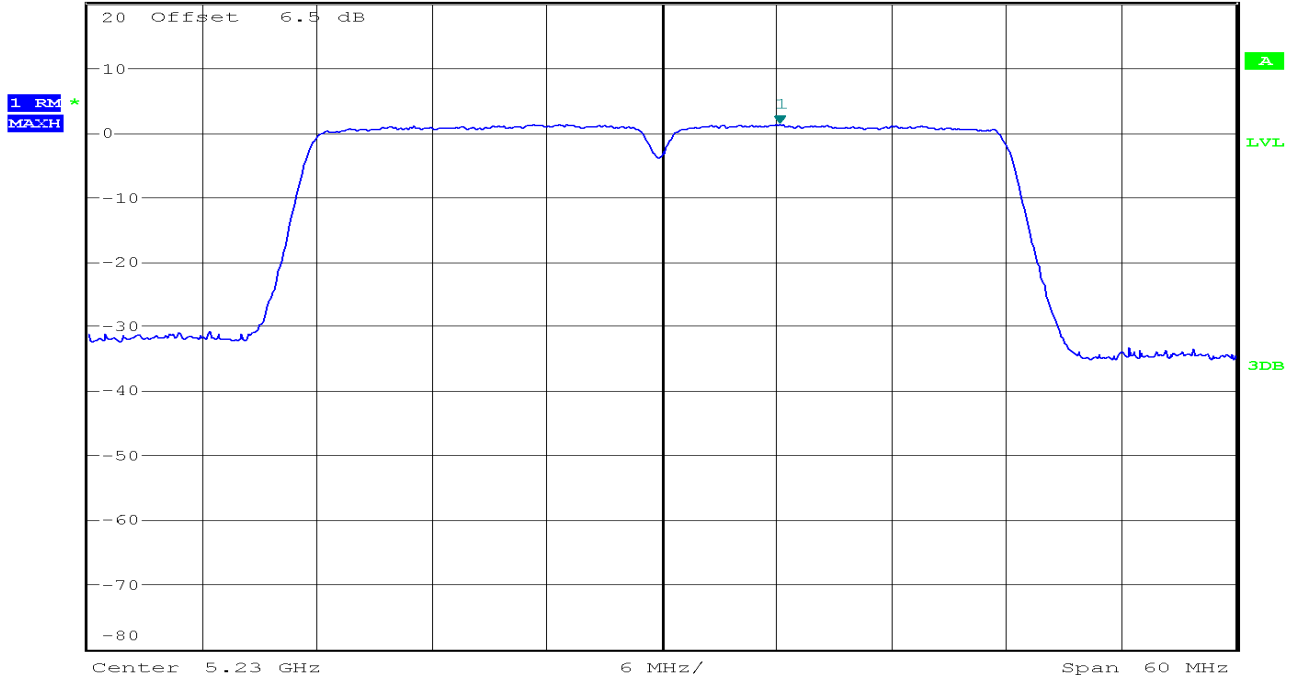

5250~5350MHz

CH Low



Ref 20 dBm * Att 20 dB * RBW 1 MHz Marker 1 [T1]
 * VBW 3 MHz 0.72 dBm
 SWT 20 ms 5.275576923 GHz

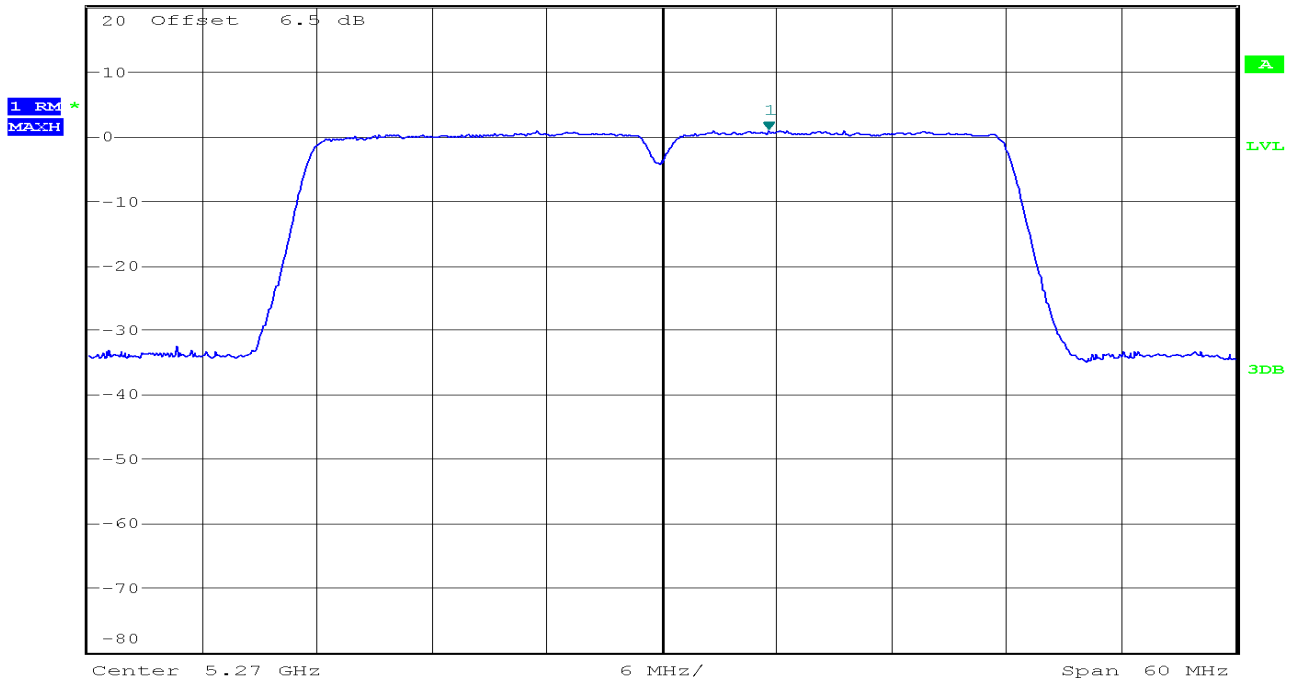

CH High



Ref 20 dBm * Att 20 dB * RBW 1 MHz Marker 1 [T1] 0.72 dBm
 * VBW 3 MHz SWT 20 ms 5.316057692 GHz

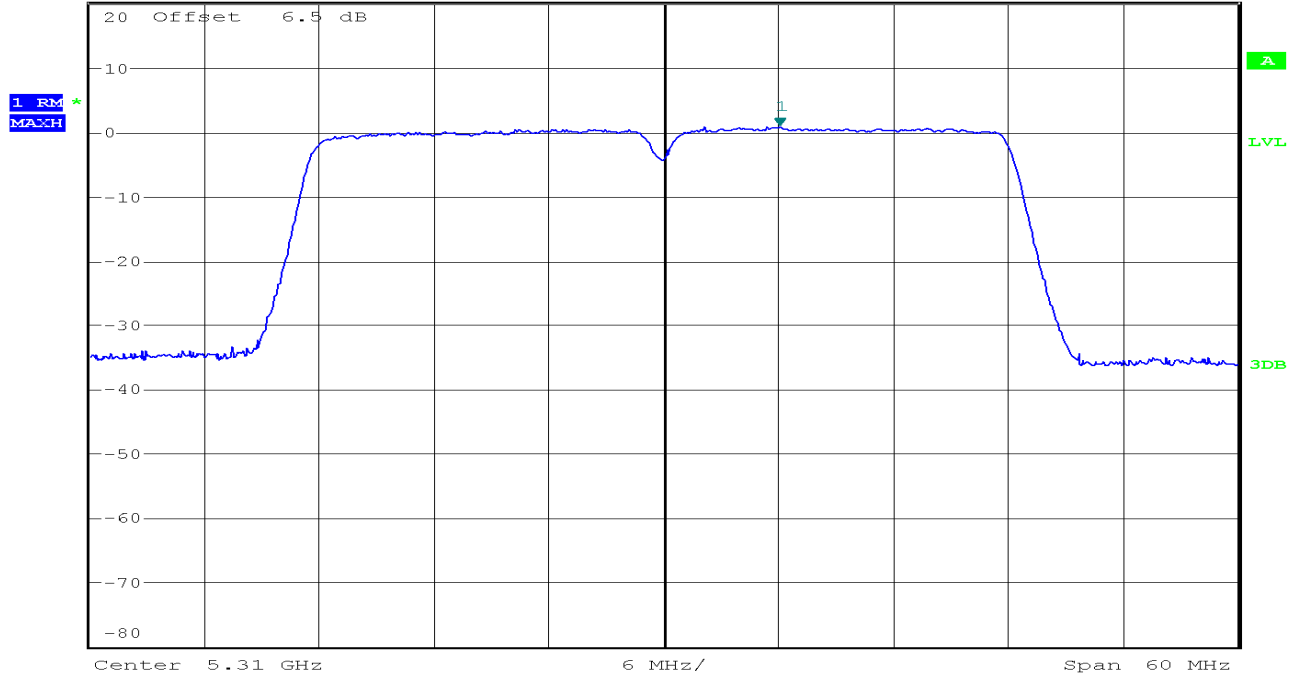

5470~5725MHz

CH Low



Ref 20 dBm * Att 20 dB * RBW 1 MHz Marker 1 [T1] 0.46 dBm
 * VBW 3 MHz SWT 20 ms 5.505192308 GHz

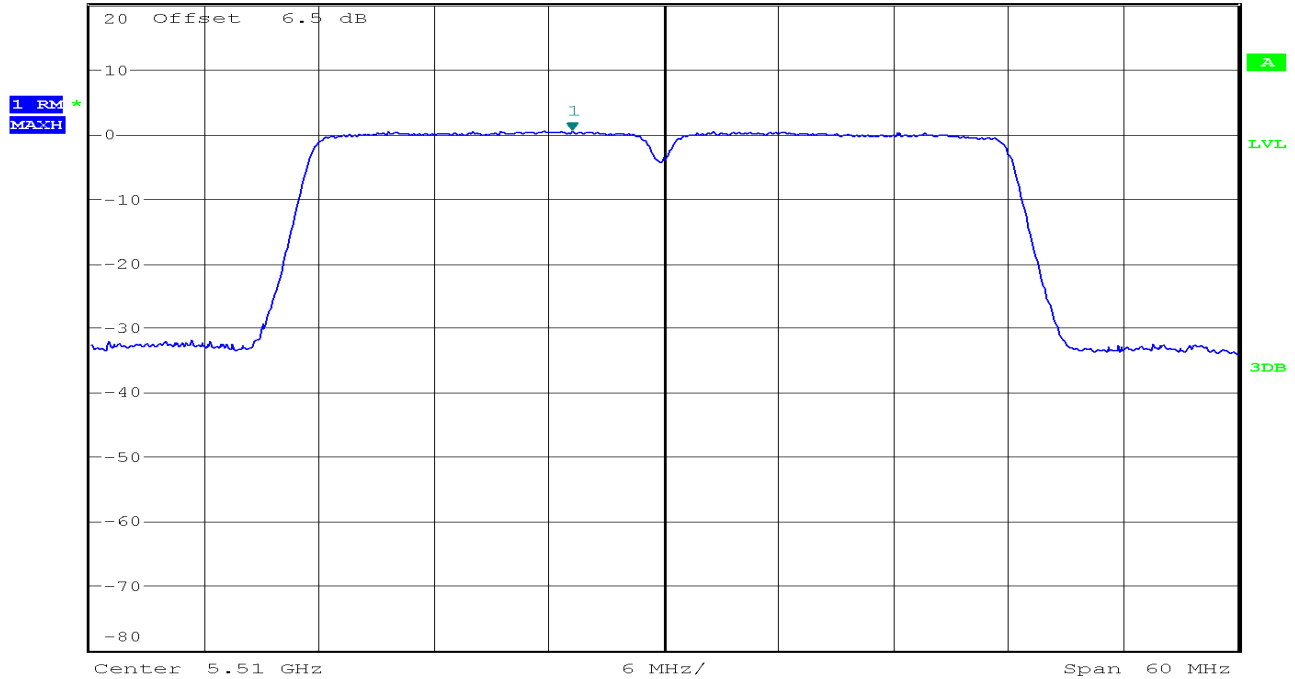

CH Mid



* RBW 1 MHz
* VBW 3 MHz
SWT 20 ms
Marker 1 [T1]
0.41 dBm
5.545769231 GHz

Ref 20 dBm * Att 20 dB

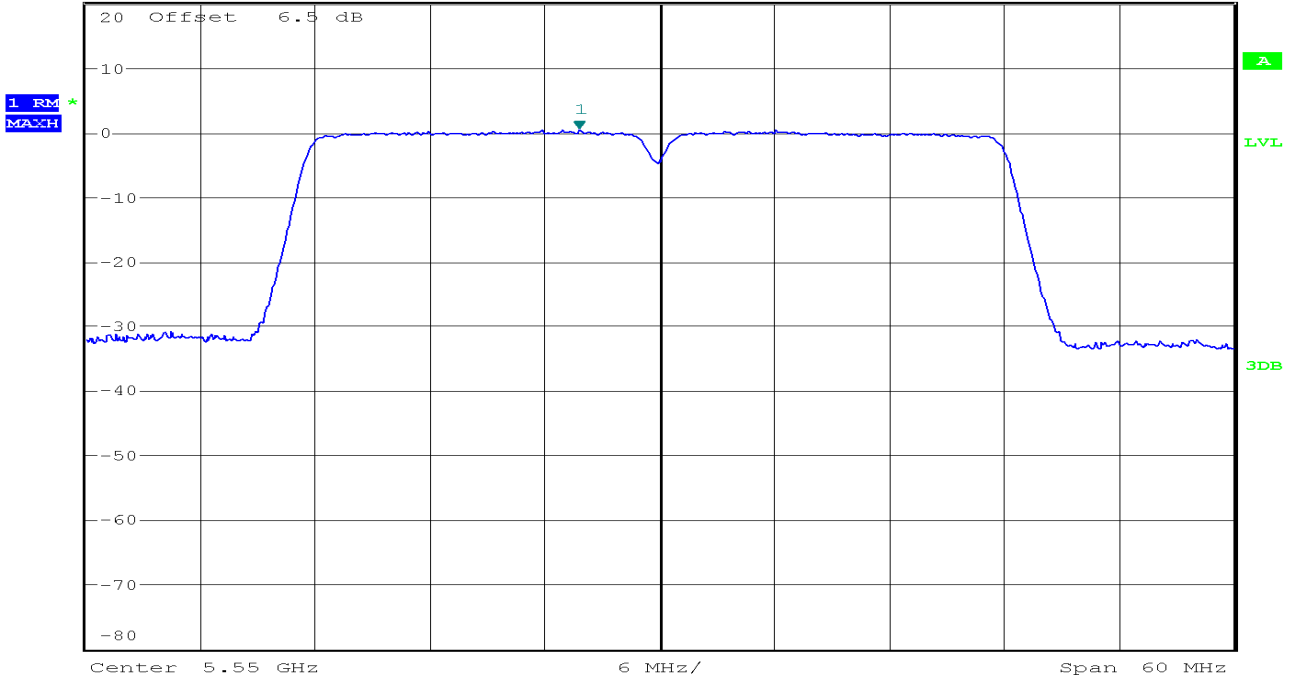

CH High



* RBW 1 MHz
* VBW 3 MHz
SWT 20 ms
Marker 1 [T1]
-0.45 dBm
5.675576923 GHz

Ref 20 dBm * Att 20 dB

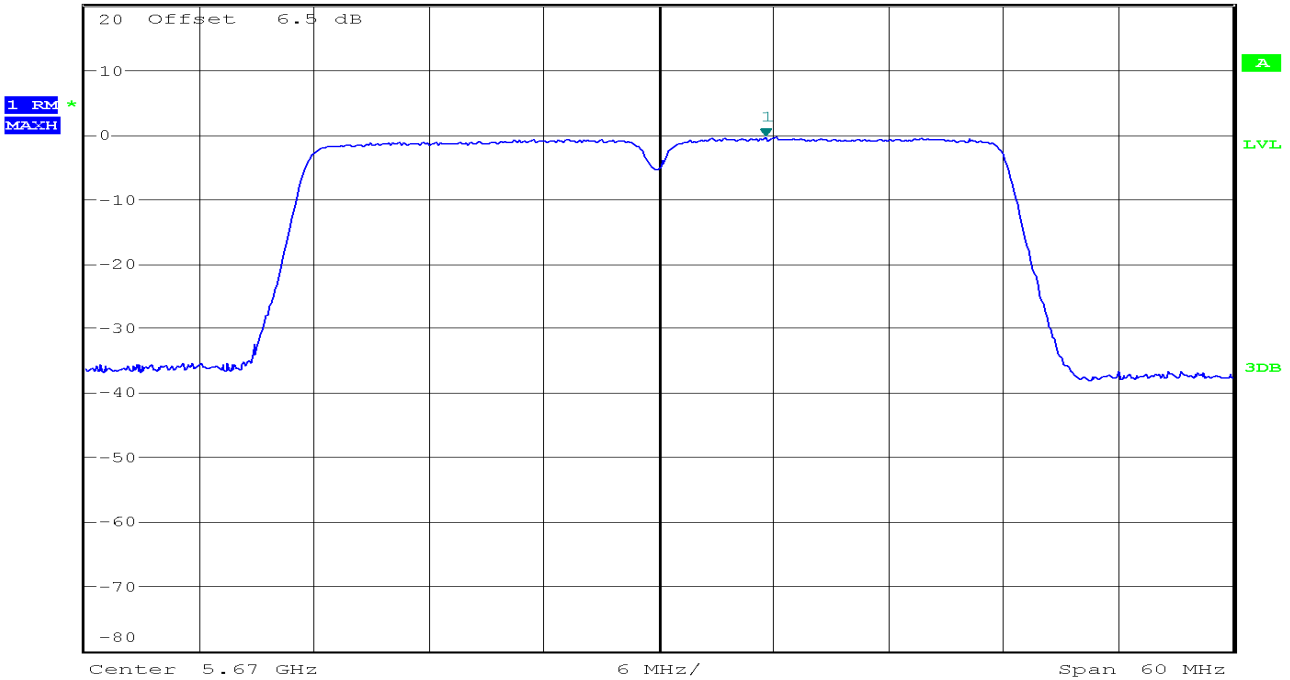

IEEE 802.11ac HT20 mode / Chain 0
5150~5250MHz

CH Low

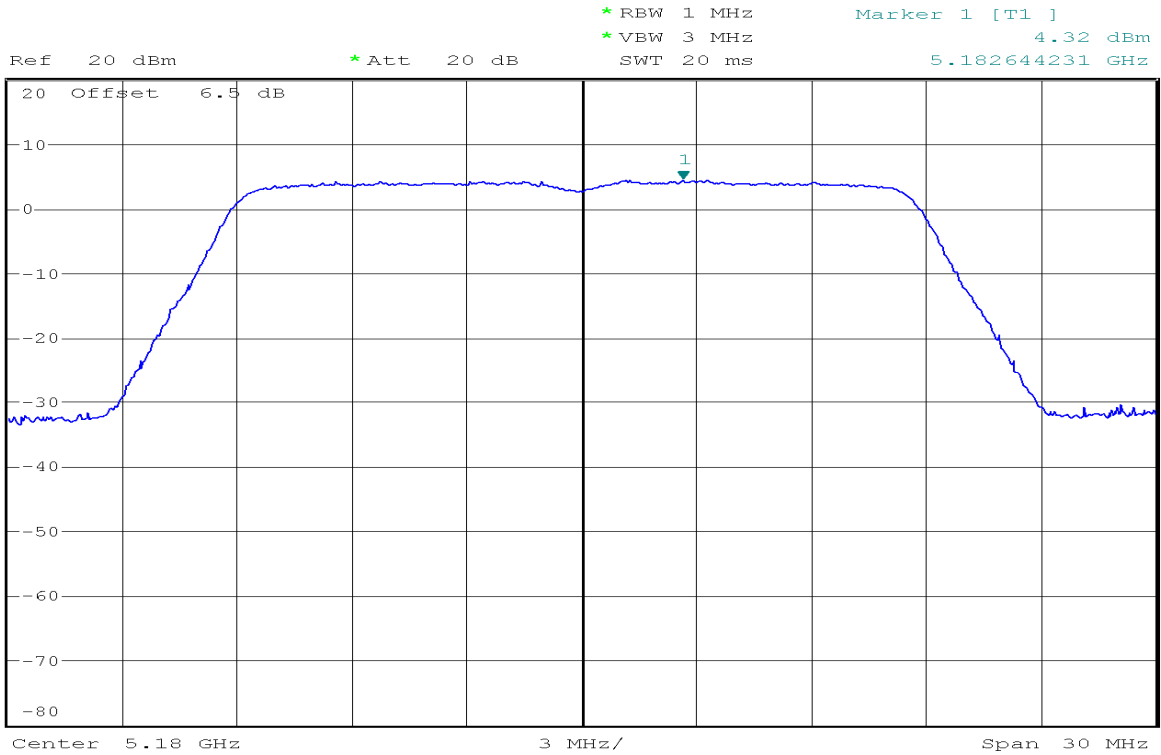

CH Mid

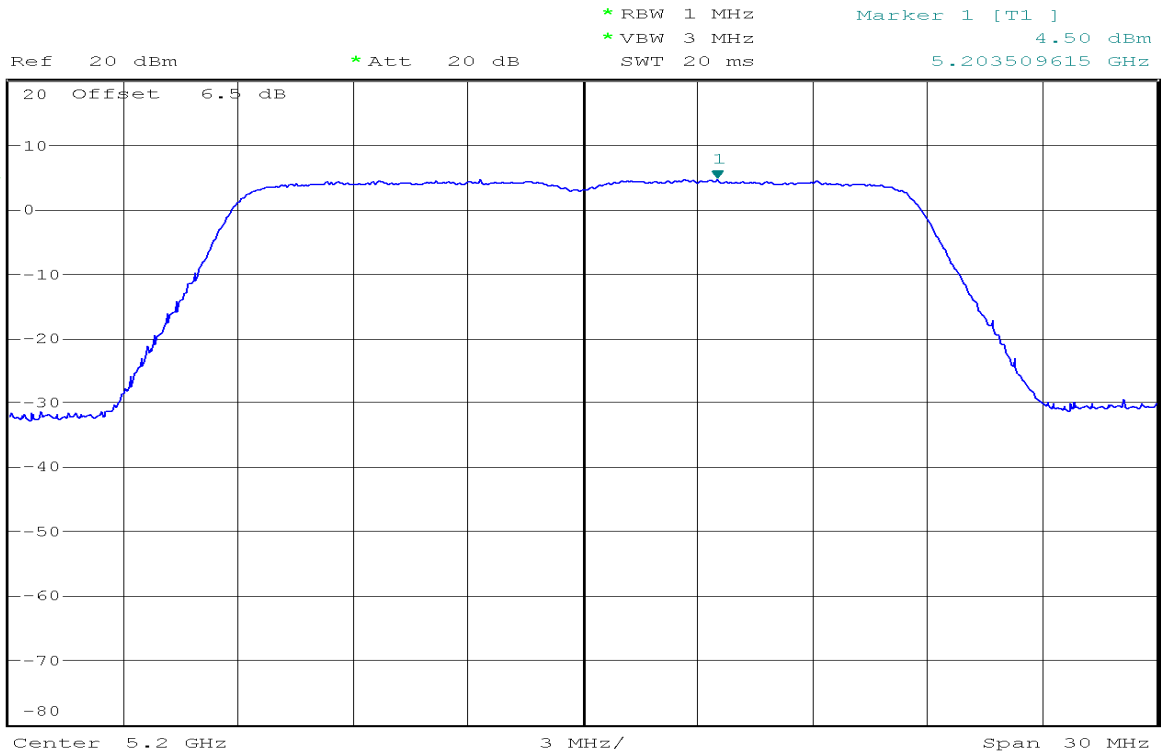

CH High



Ref 20 dBm * Att 20 dB * RBW 1 MHz * VBW 3 MHz * SWT 20 ms Marker 1 [T1] 4.26 dBm 5.235000000 GHz

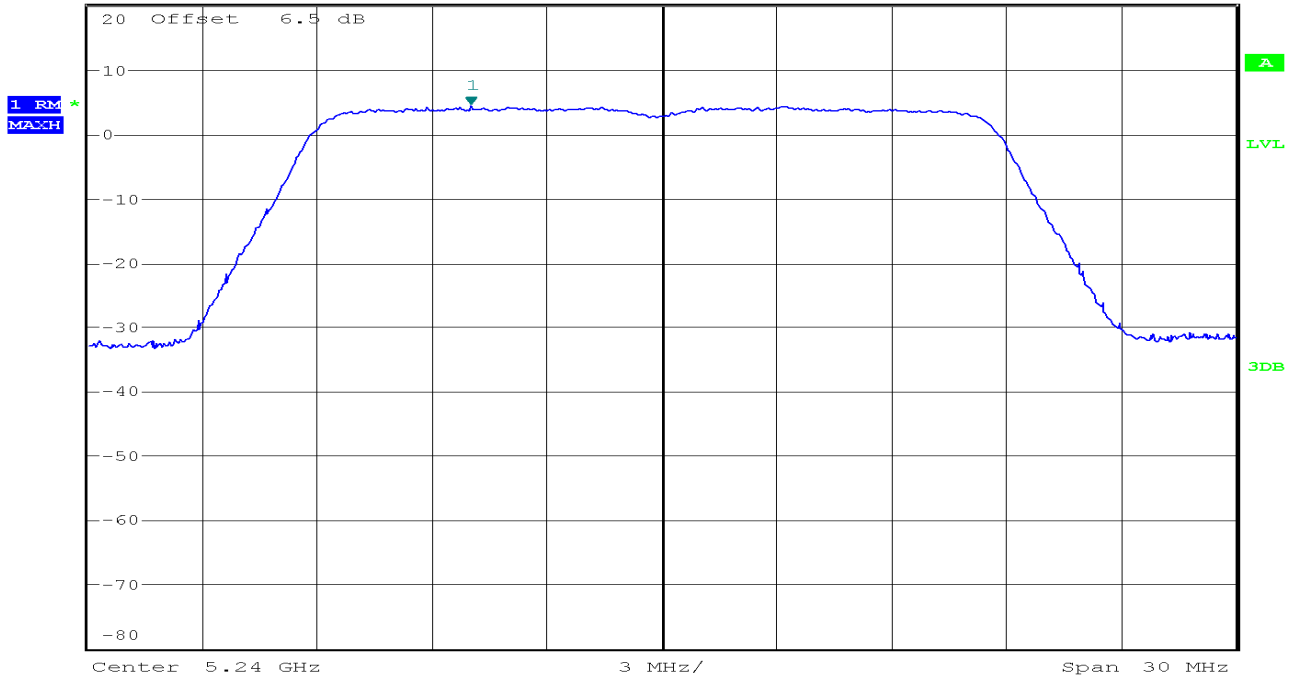

5250~5350MHz

CH Low



Ref 20 dBm * Att 20 dB * RBW 1 MHz * VBW 3 MHz * SWT 20 ms Marker 1 [T1] 3.94 dBm 5.262980769 GHz

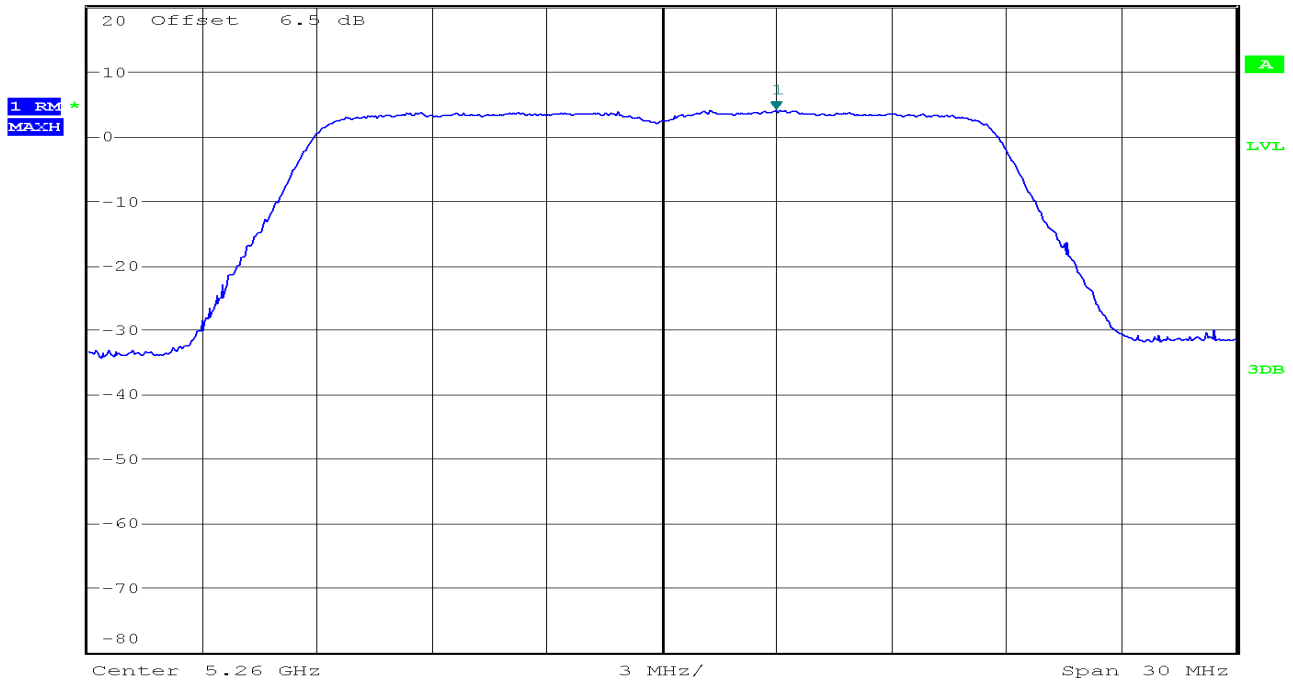

CH Mid



* RBW 1 MHz
* VBW 3 MHz
SWT 20 ms
Marker 1 [T1]
3.71 dBm
5.302355769 GHz

Ref 20 dBm * Att 20 dB

1 RM
MATH *

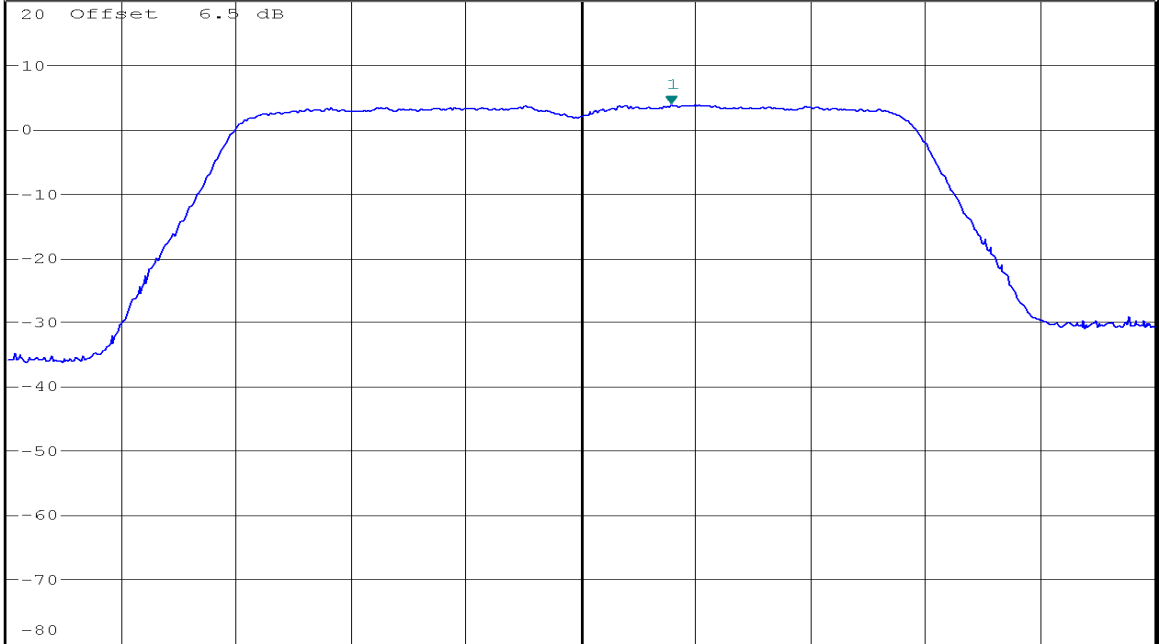

Center 5.3 GHz 3 MHz/ Span 30 MHz

CH High



* RBW 1 MHz
* VBW 3 MHz
SWT 20 ms
Marker 1 [T1]
3.79 dBm
5.321201923 GHz

Ref 20 dBm * Att 20 dB

1 RM
MATH *

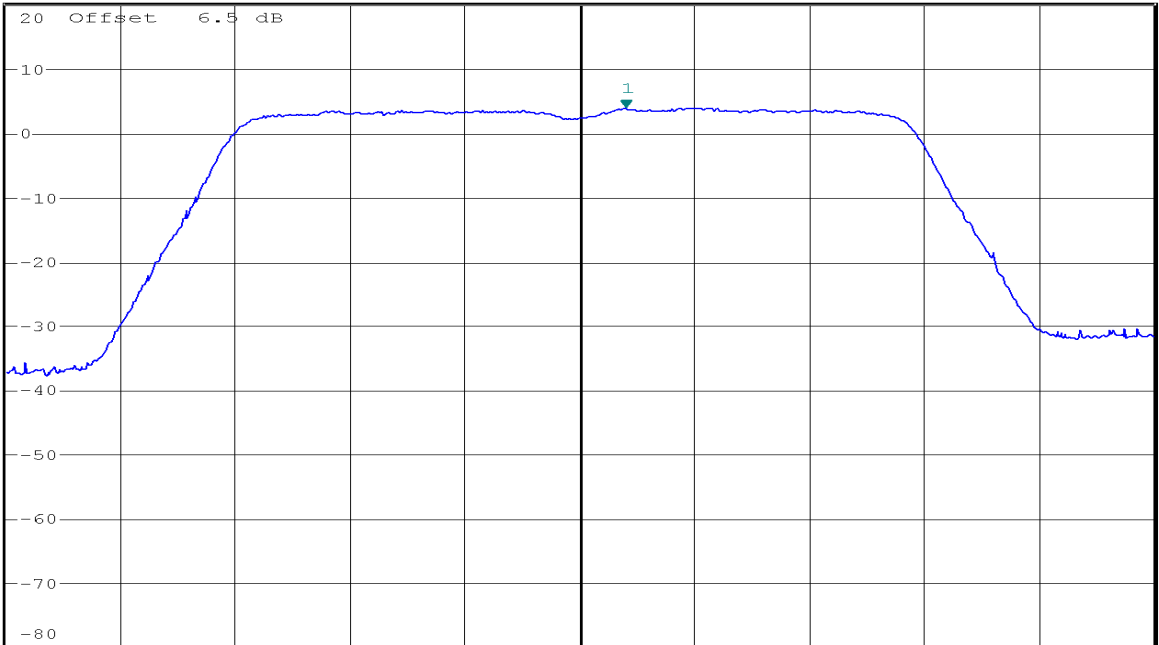

Center 5.32 GHz 3 MHz/ Span 30 MHz

5470~5725MHz

CH Low



Ref 20 dBm * Att 20 dB * RBW 1 MHz Marker 1 [T1]
 * VBW 3 MHz 3.17 dBm
 SWT 20 ms 5.494759615 GHz

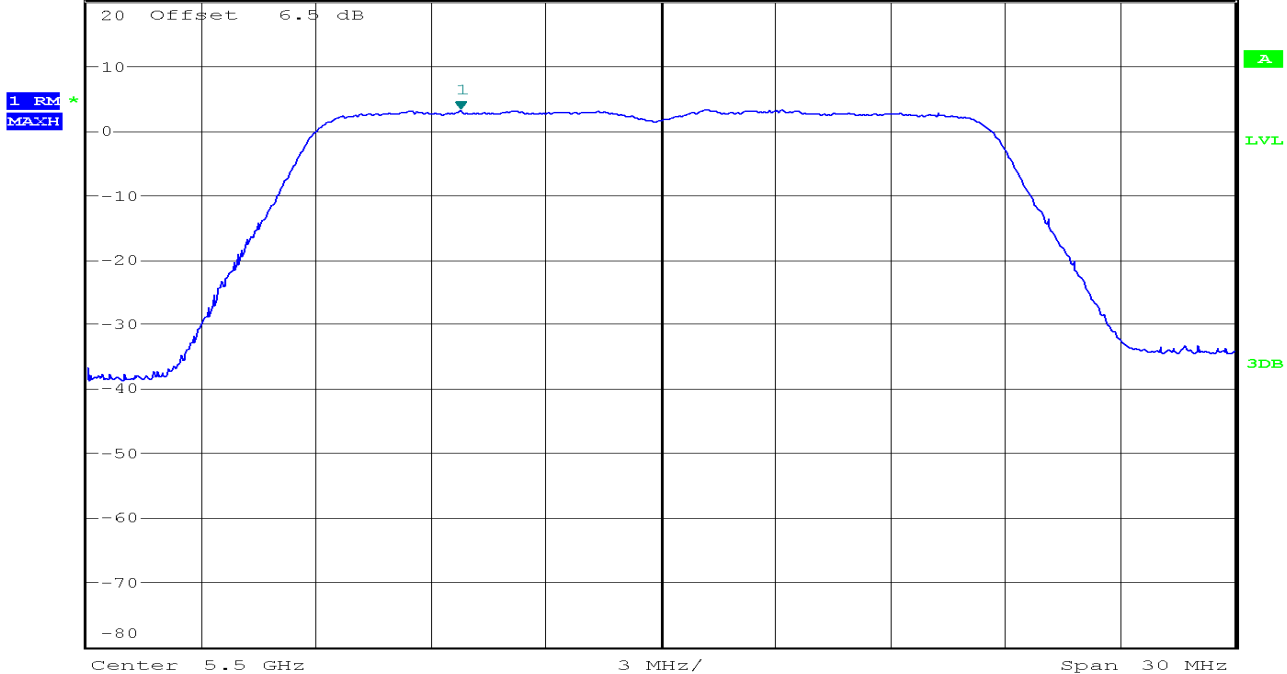

CH Mid



Ref 20 dBm * Att 20 dB * RBW 1 MHz Marker 1 [T1]
 * VBW 3 MHz 2.94 dBm
 SWT 20 ms 5.541105769 GHz

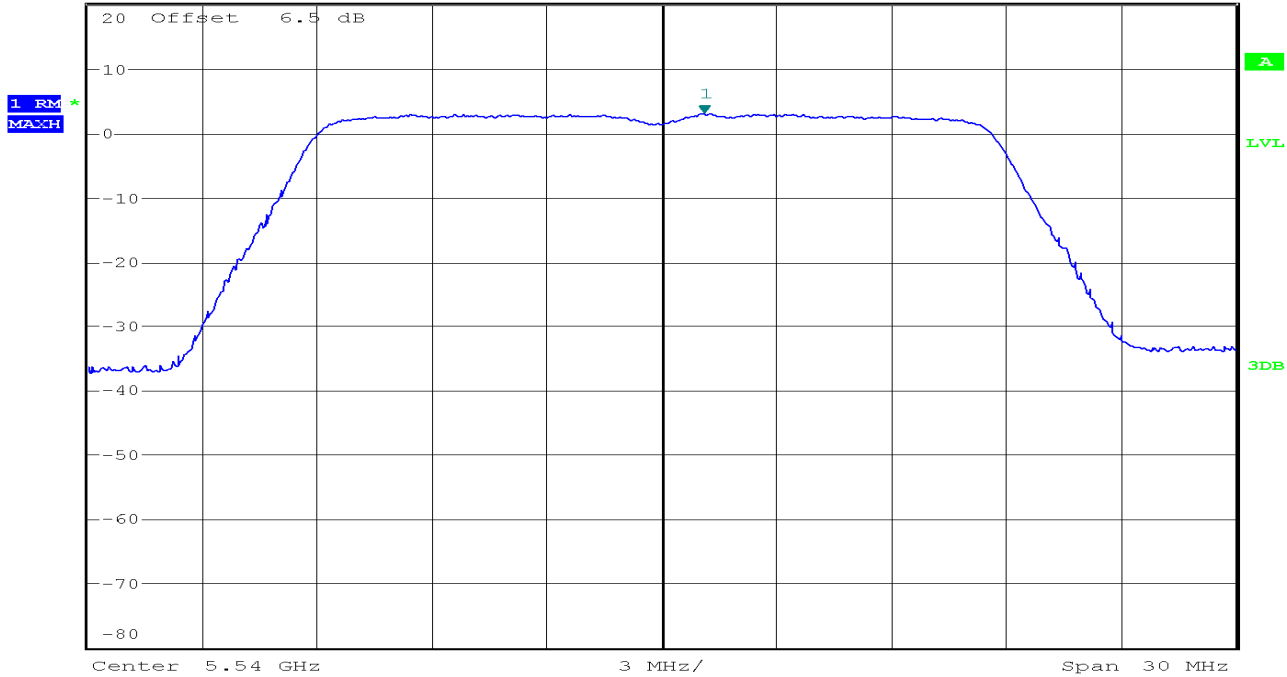

CH High



Ref 20 dBm * Att 20 dB * RBW 1 MHz Marker 1 [T1] 1.20 dBm
 * VBW 3 MHz 5.702980769 GHz
 SWT 20 ms

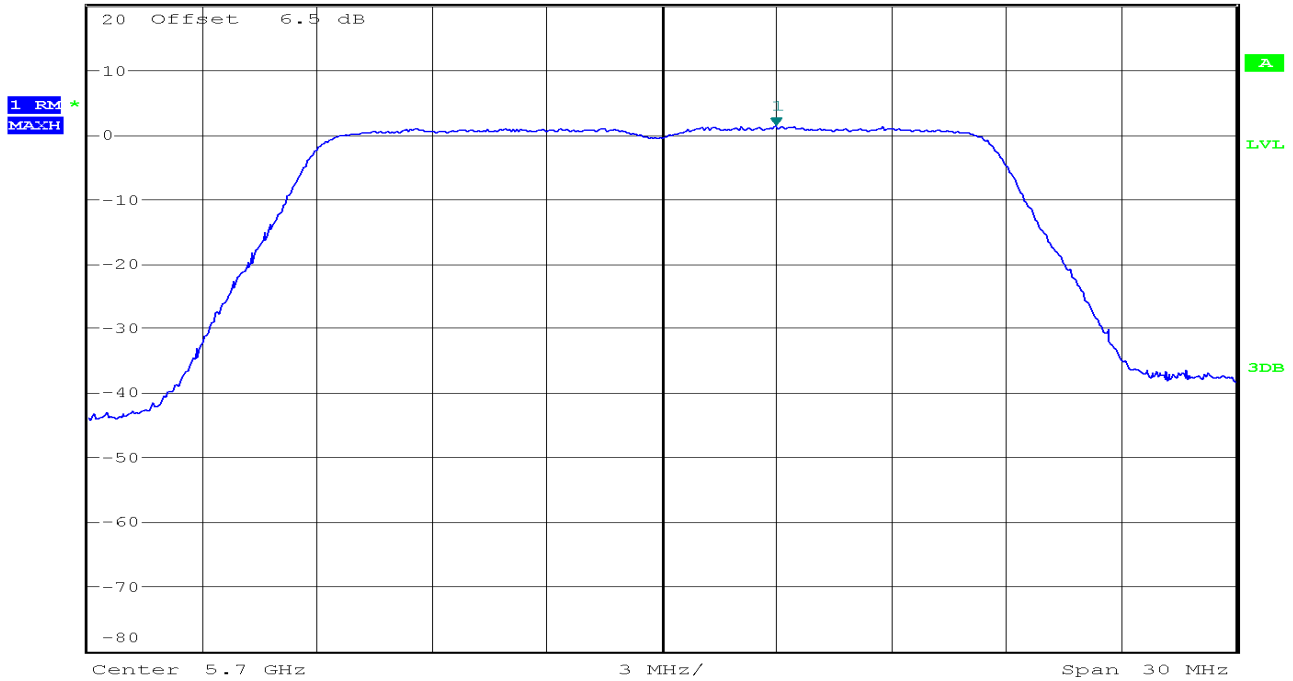

IEEE 802.11ac HT20 mode / Chain 1
5150~5250MHz

CH Low



Ref 20 dBm * Att 20 dB * RBW 1 MHz Marker 1 [T1] 3.40 dBm
 * VBW 3 MHz 5.182980769 GHz
 SWT 20 ms

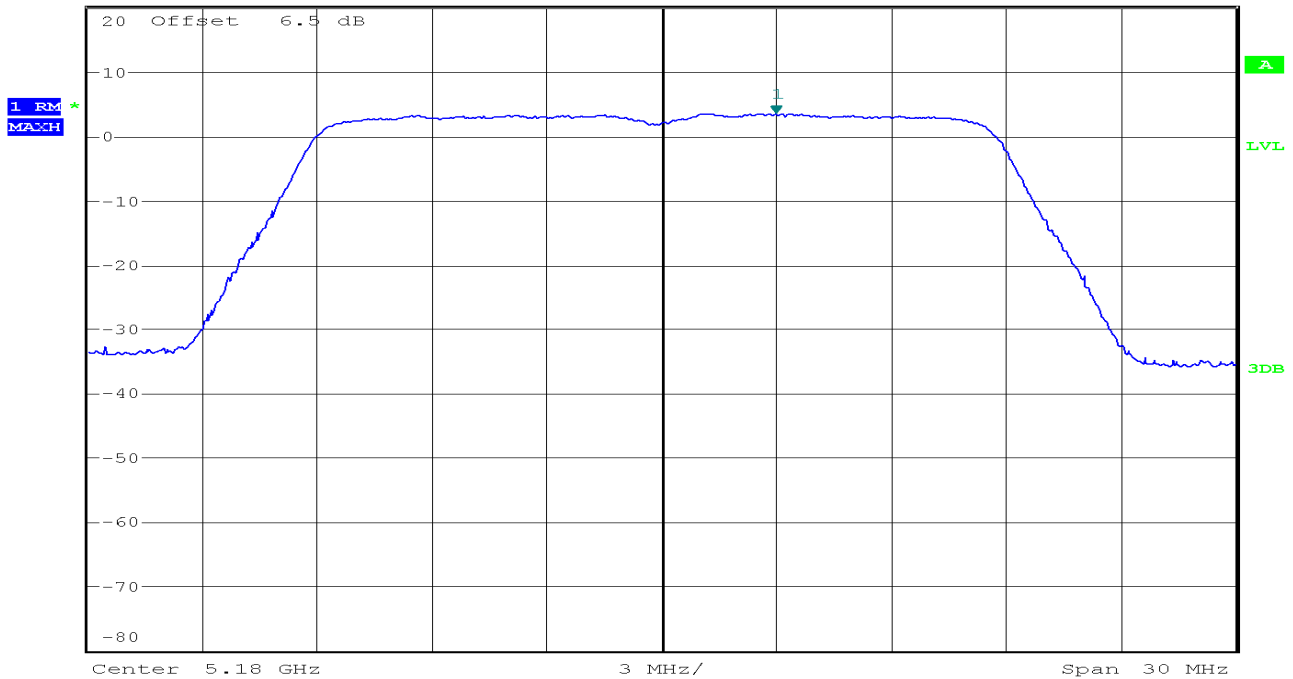

CH Mid



Ref 20 dBm * Att 20 dB * RBW 1 MHz Marker 1 [T1] 3.83 dBm
 * VBW 3 MHz 5.202403846 GHz
 SWT 20 ms

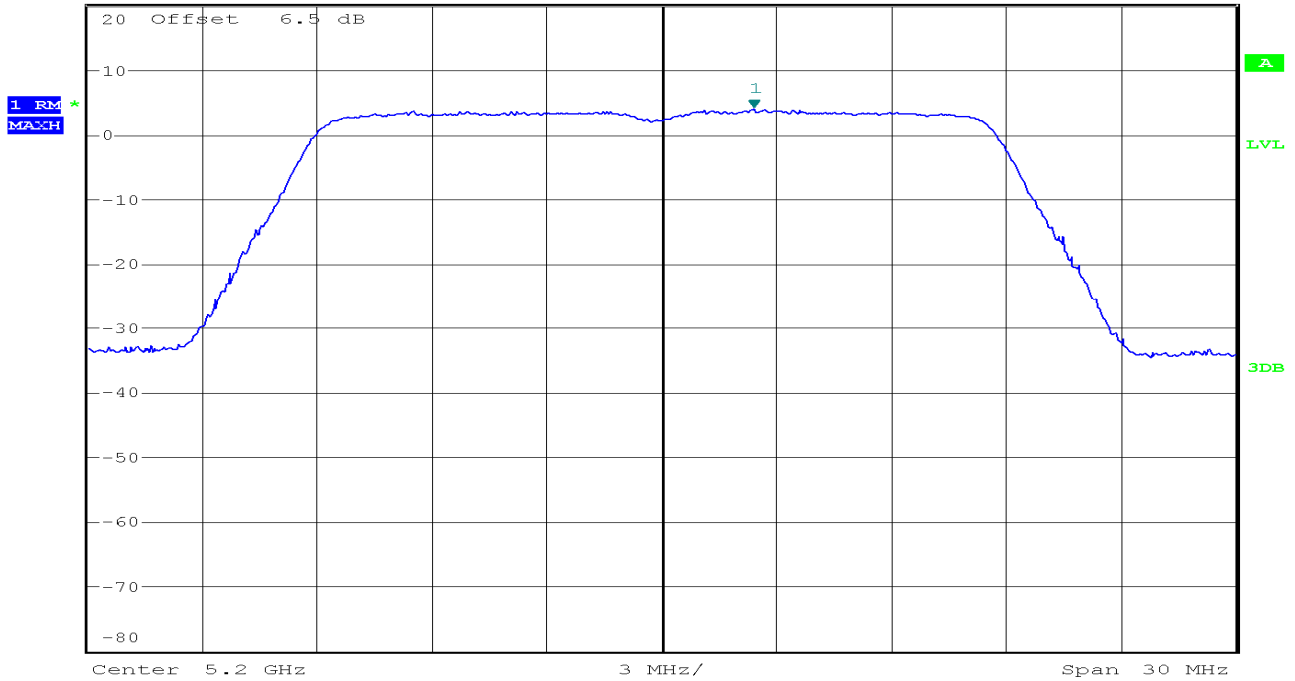

CH High



Ref 20 dBm * Att 20 dB * RBW 1 MHz Marker 1 [T1] 3.32 dBm
 * VBW 3 MHz 5.242451923 GHz
 SWT 20 ms

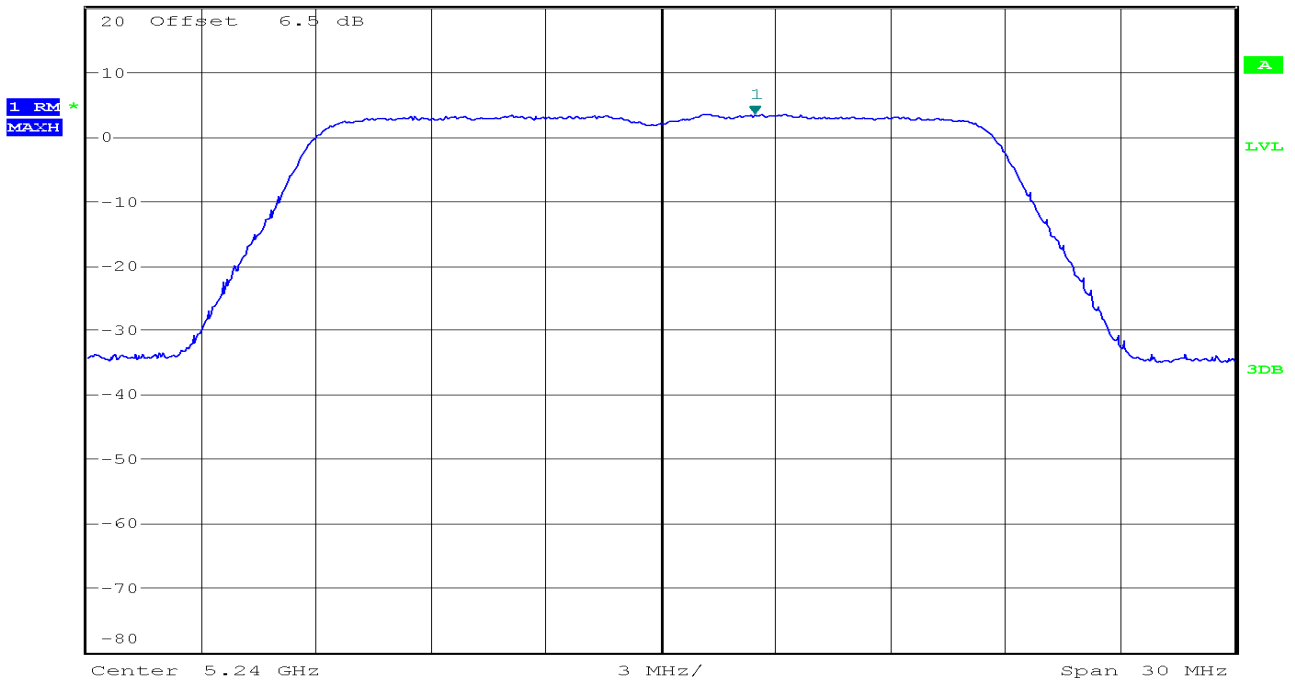

5250~5350MHz

CH Low



Ref 20 dBm * Att 20 dB * RBW 1 MHz Marker 1 [T1]
 * VBW 3 MHz 3.45 dBm
 SWT 20 ms 5.261153846 GHz

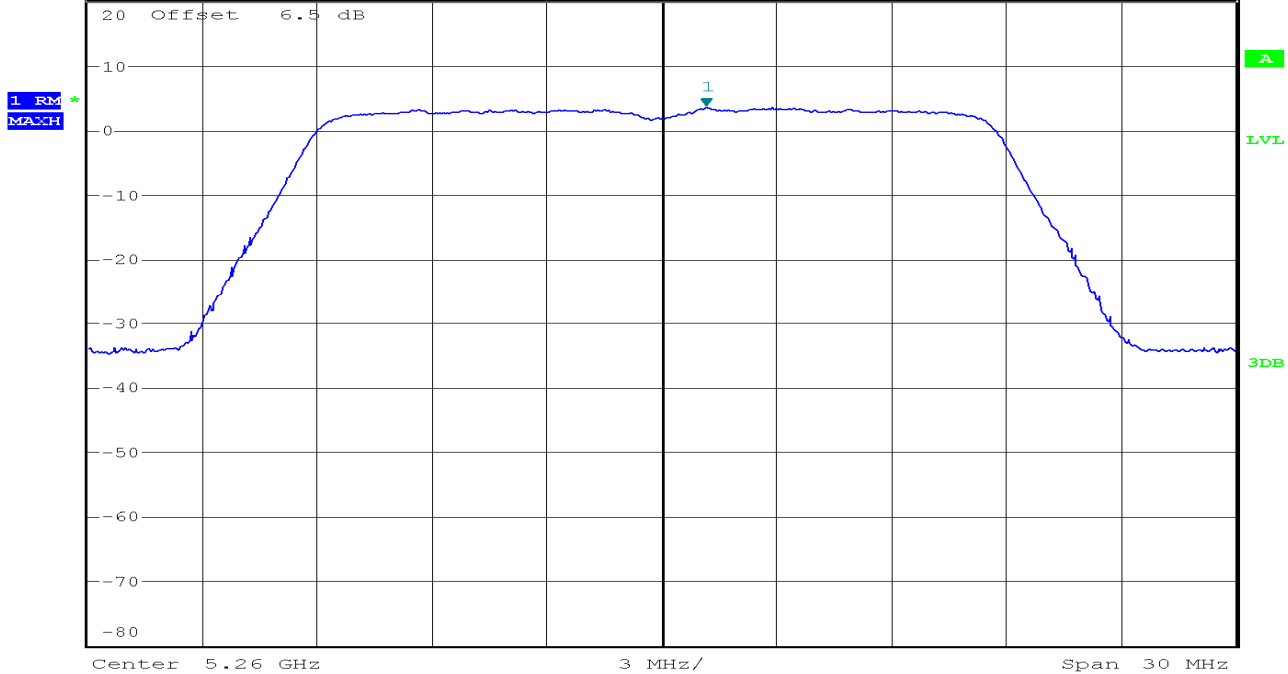

CH Mid



Ref 20 dBm * Att 20 dB * RBW 1 MHz Marker 1 [T1]
 * VBW 3 MHz 3.01 dBm
 SWT 20 ms 5.302451923 GHz

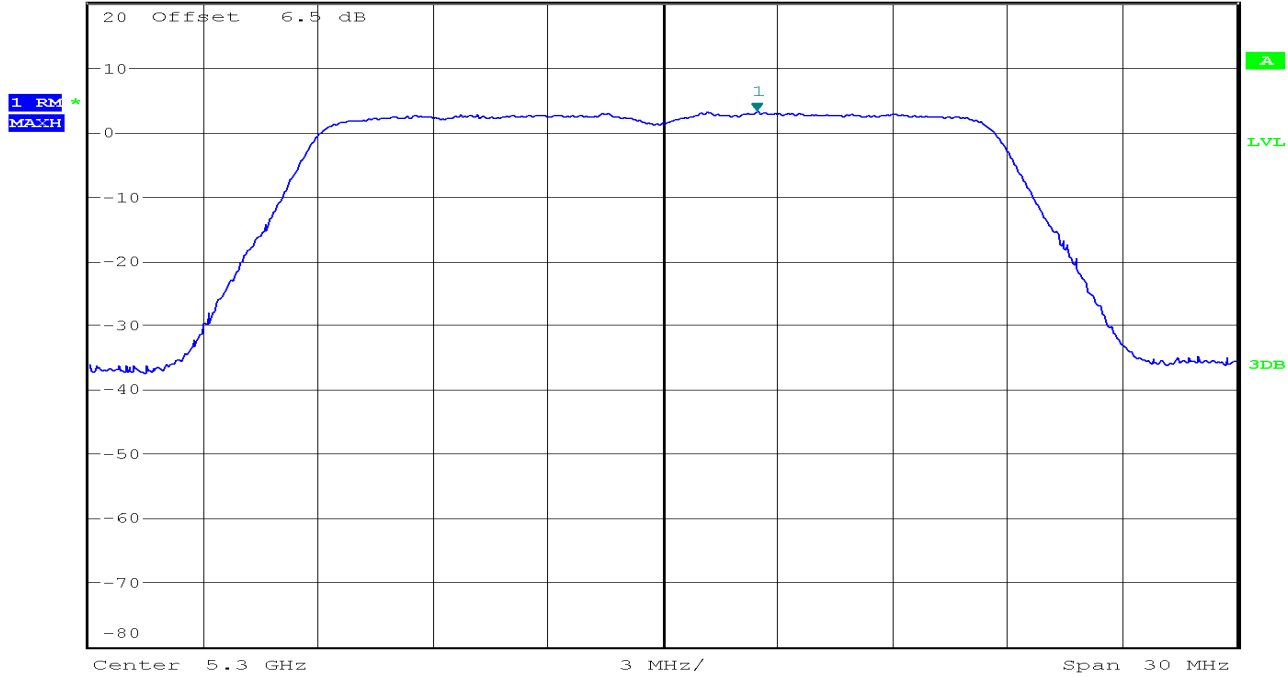

CH High



Ref 20 dBm * Att 20 dB * RBW 1 MHz Marker 1 [T1] 3.25 dBm
 * VBW 3 MHz 5.323461538 GHz
 SWT 20 ms

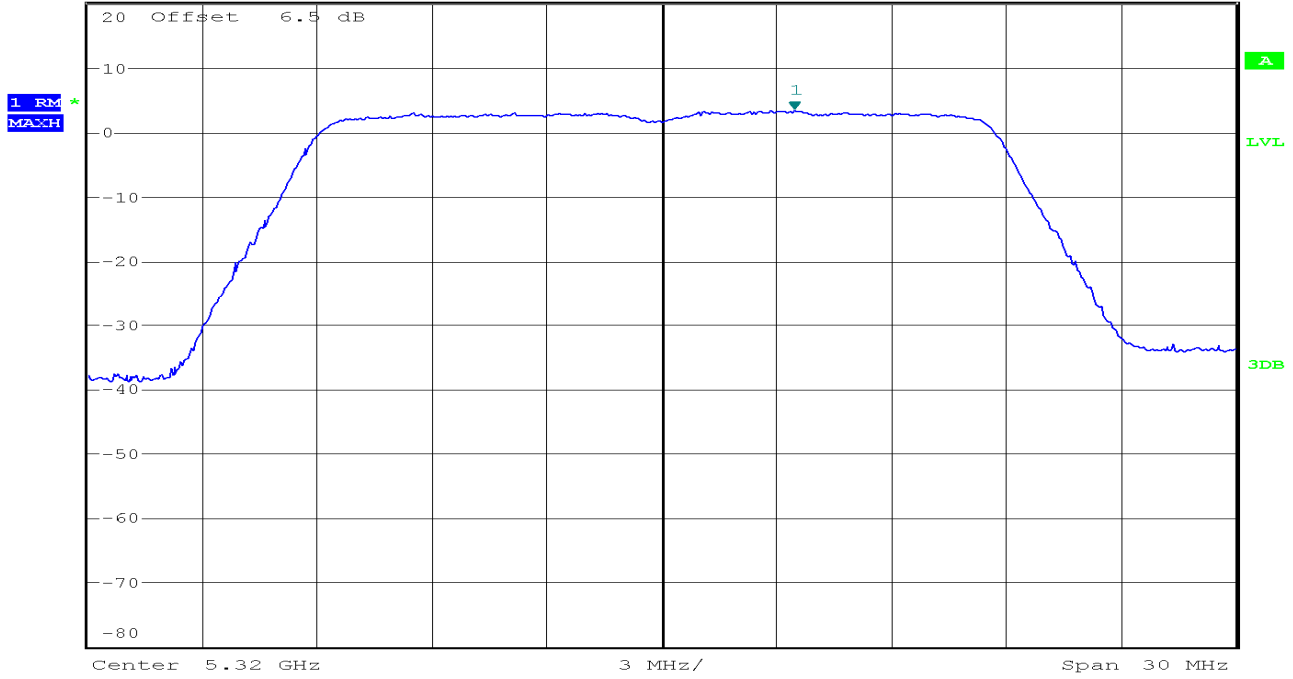

5470~5725MHz

CH Low



Ref 20 dBm * Att 20 dB * RBW 1 MHz Marker 1 [T1] 2.80 dBm
 * VBW 3 MHz 5.501201923 GHz
 SWT 20 ms

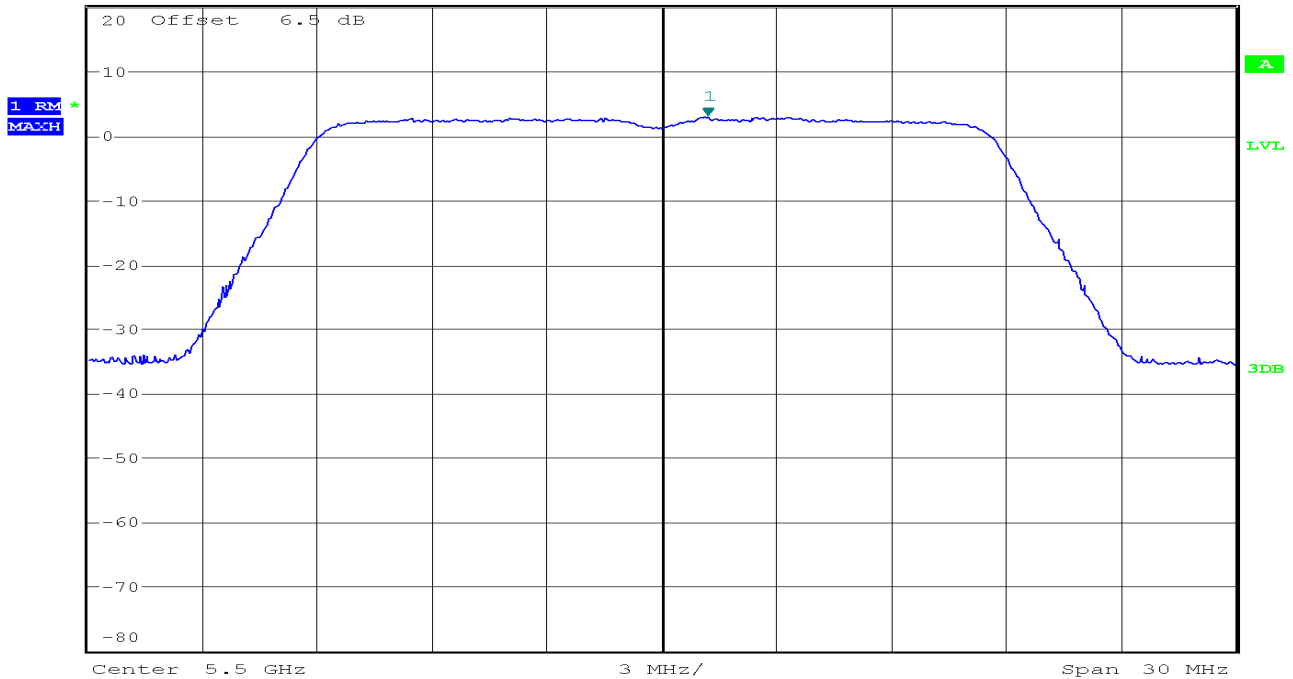

CH Mid



Ref 20 dBm * Att 20 dB * RBW 1 MHz Marker 1 [T1]
* VBW 3 MHz 2.65 dBm
SWT 20 ms 5.541105769 GHz

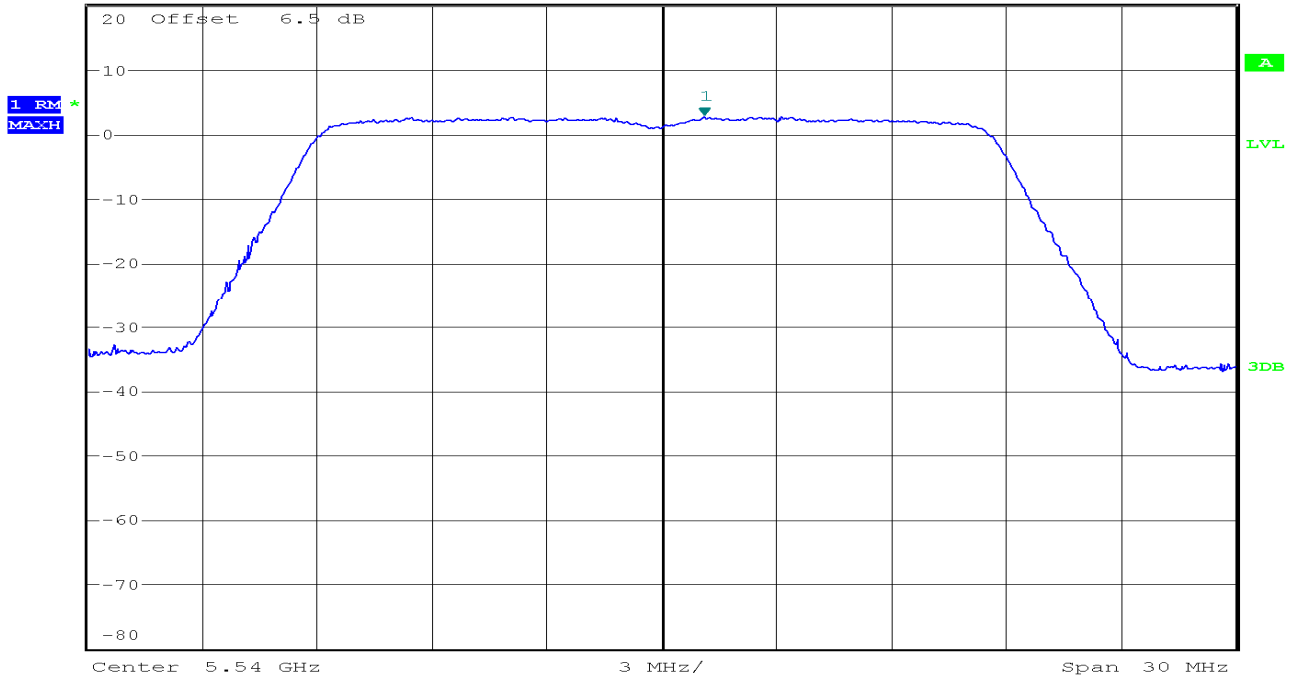

CH High



Ref 20 dBm * Att 20 dB * RBW 1 MHz Marker 1 [T1]
* VBW 3 MHz 1.68 dBm
SWT 20 ms 5.701201923 GHz

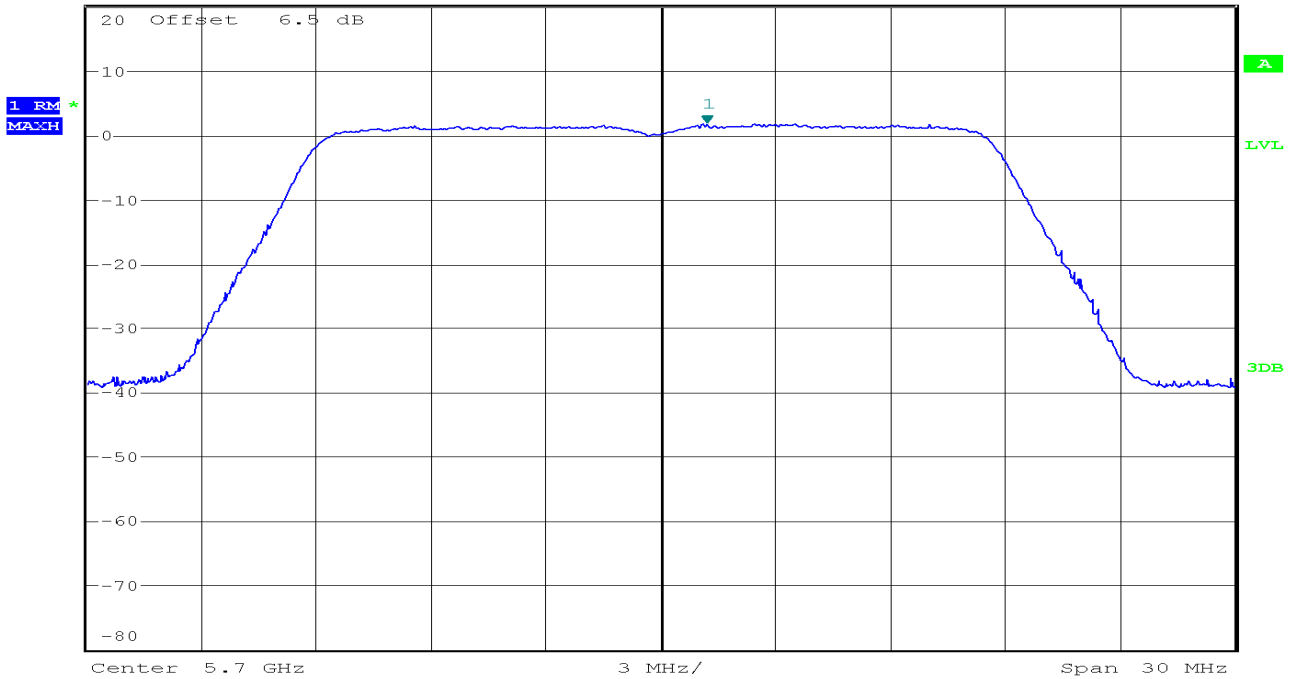

IEEE 802.11ac HT40 mode / Chain 0
5150~5250MHz

CH Low

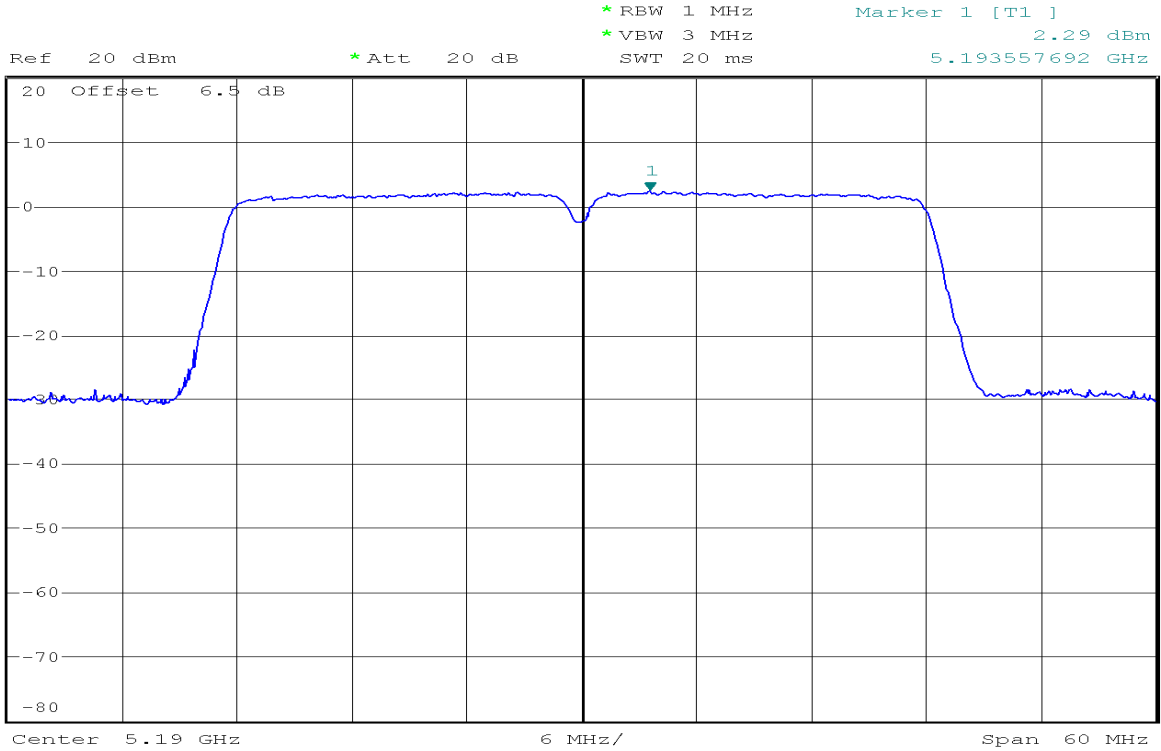

CH High

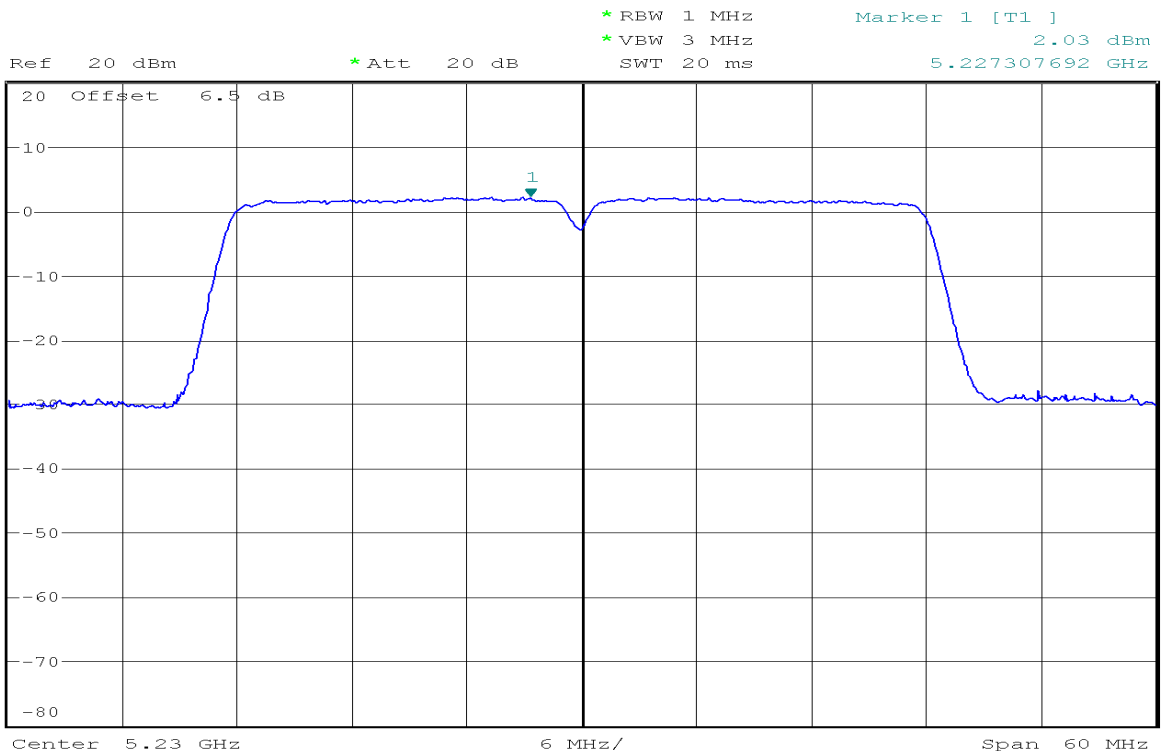

5250~5350MHz

CH Low

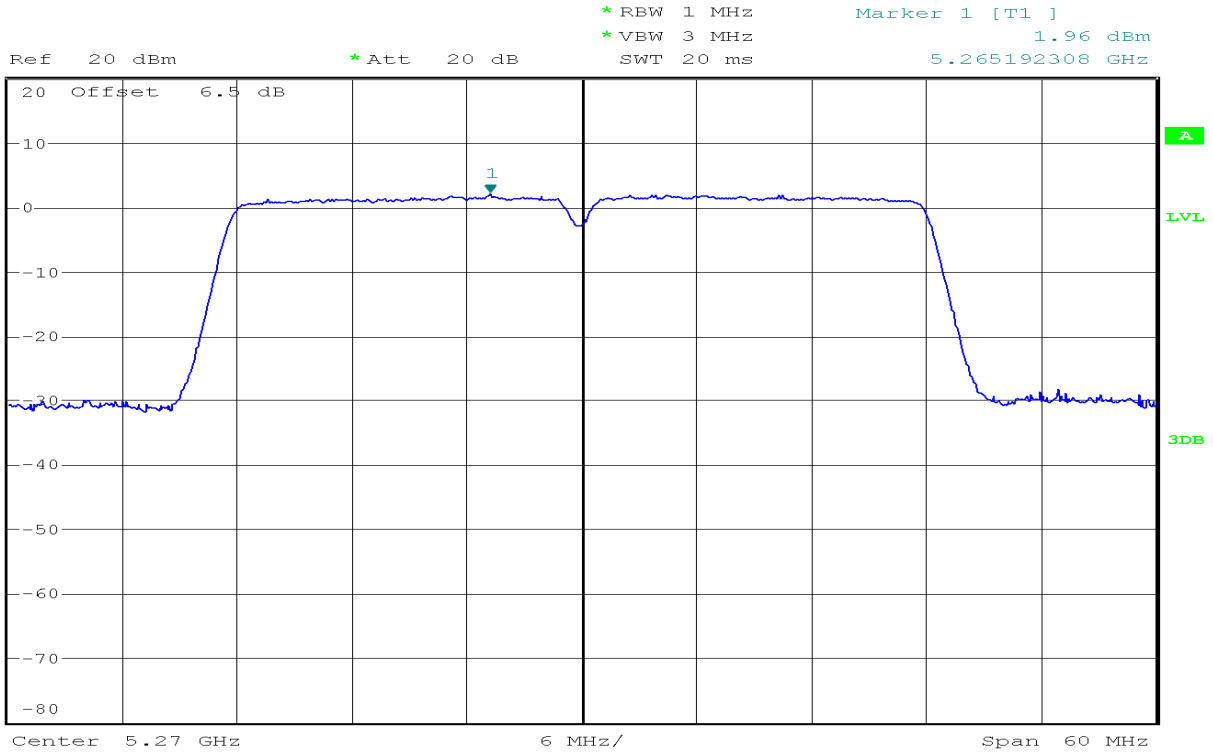

CH High

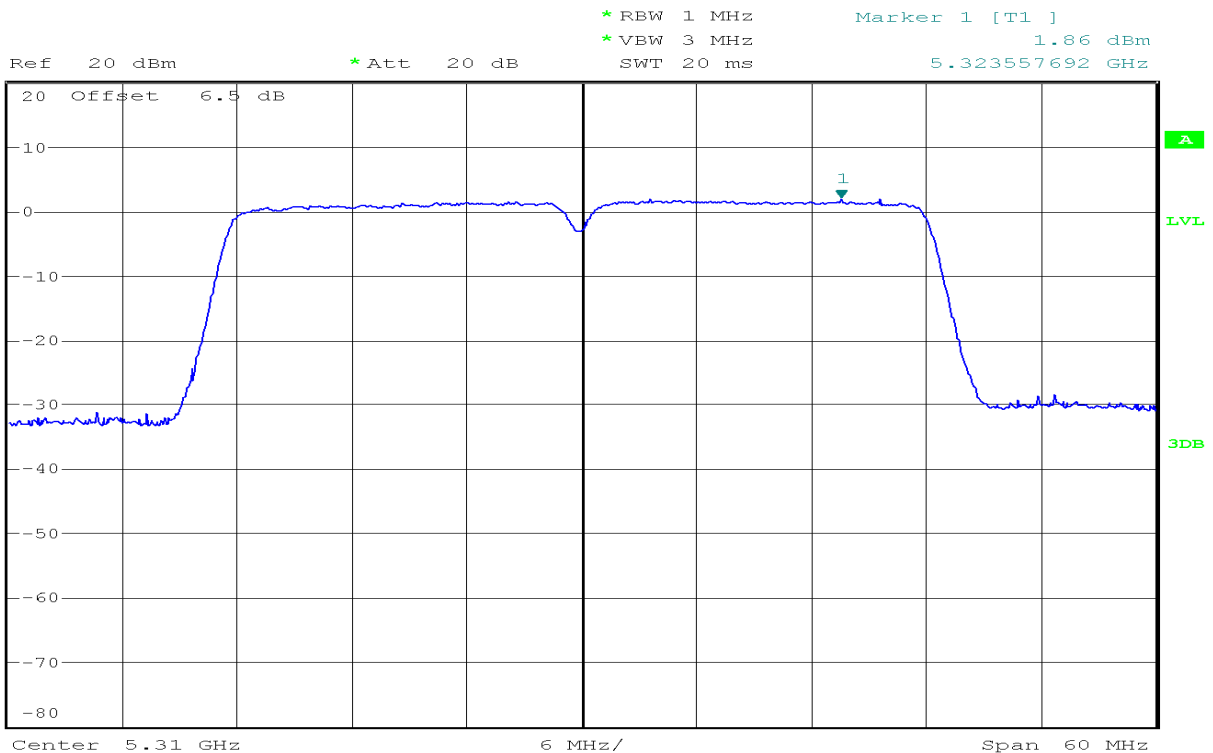

5470~5725MHz

CH Low



Ref 20 dBm * Att 20 dB * RBW 1 MHz * VBW 3 MHz SWT 20 ms Marker 1 [T1] 1.17 dBm 5.514903846 GHz

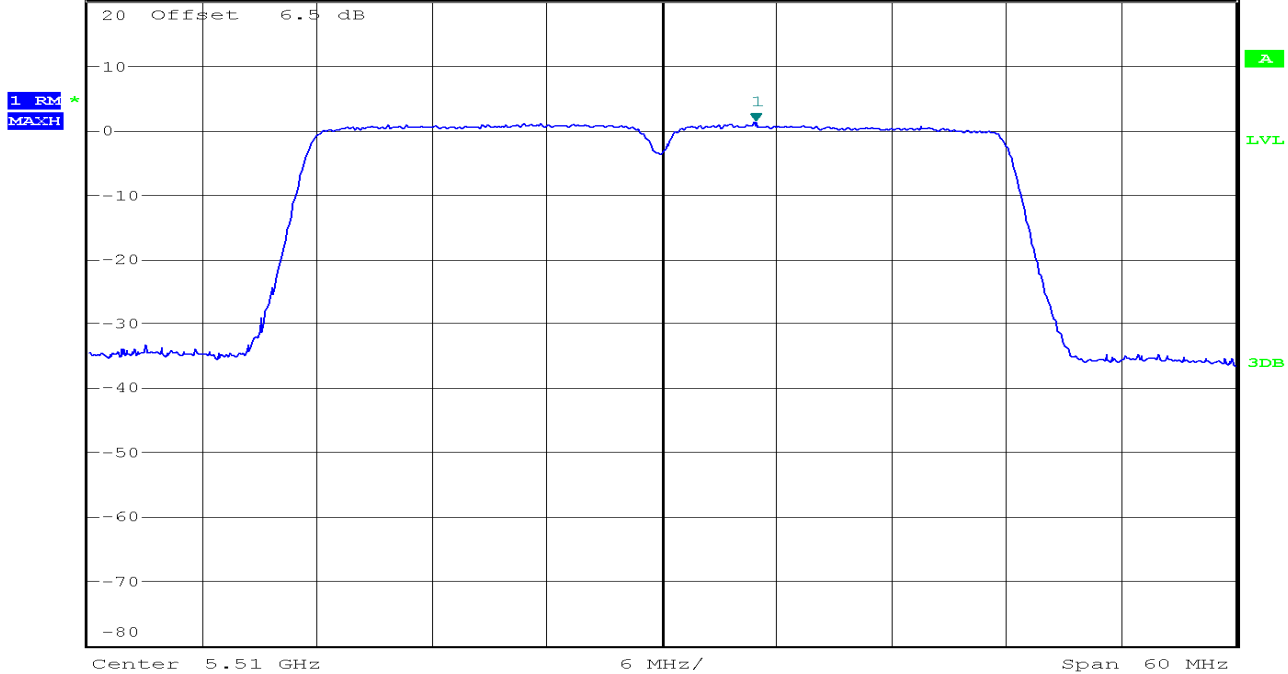

CH Mid



Ref 20 dBm * Att 20 dB * RBW 1 MHz * VBW 3 MHz SWT 20 ms Marker 1 [T1] 0.64 dBm 5.556923077 GHz

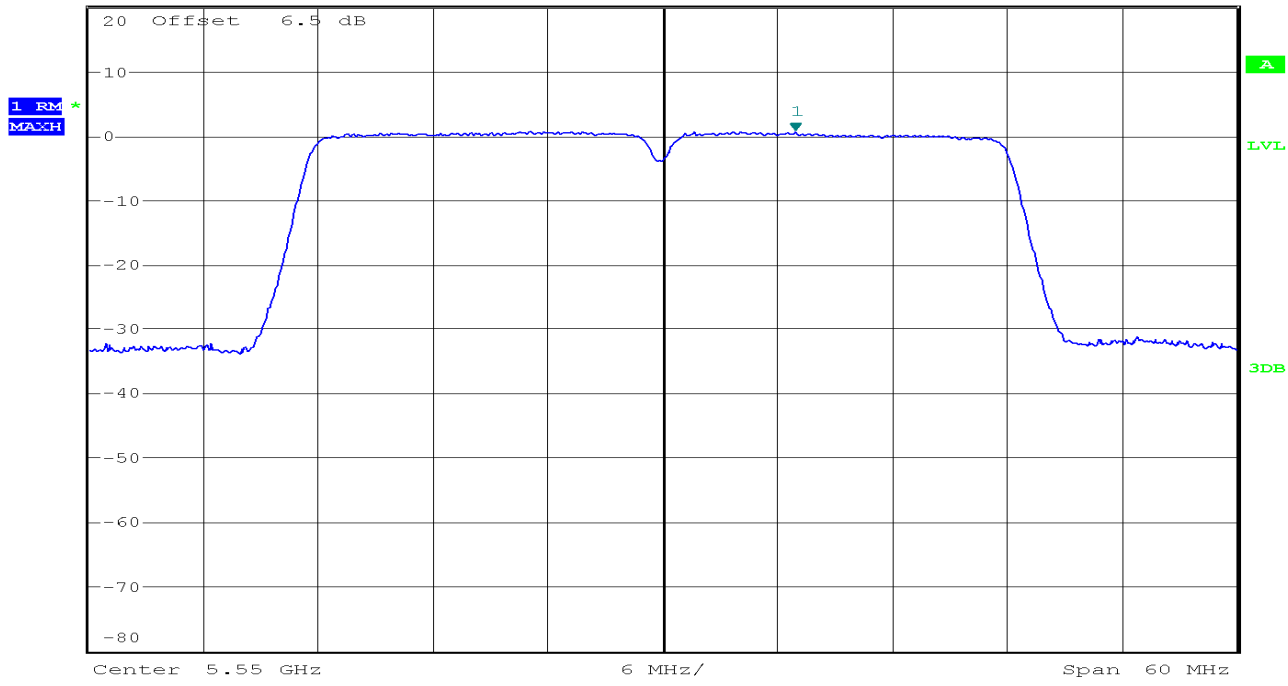

CH High



Ref 20 dBm * Att 20 dB * RBW 1 MHz Marker 1 [T1]
 * VBW 3 MHz -0.56 dBm
 SWT 20 ms 5.676826923 GHz

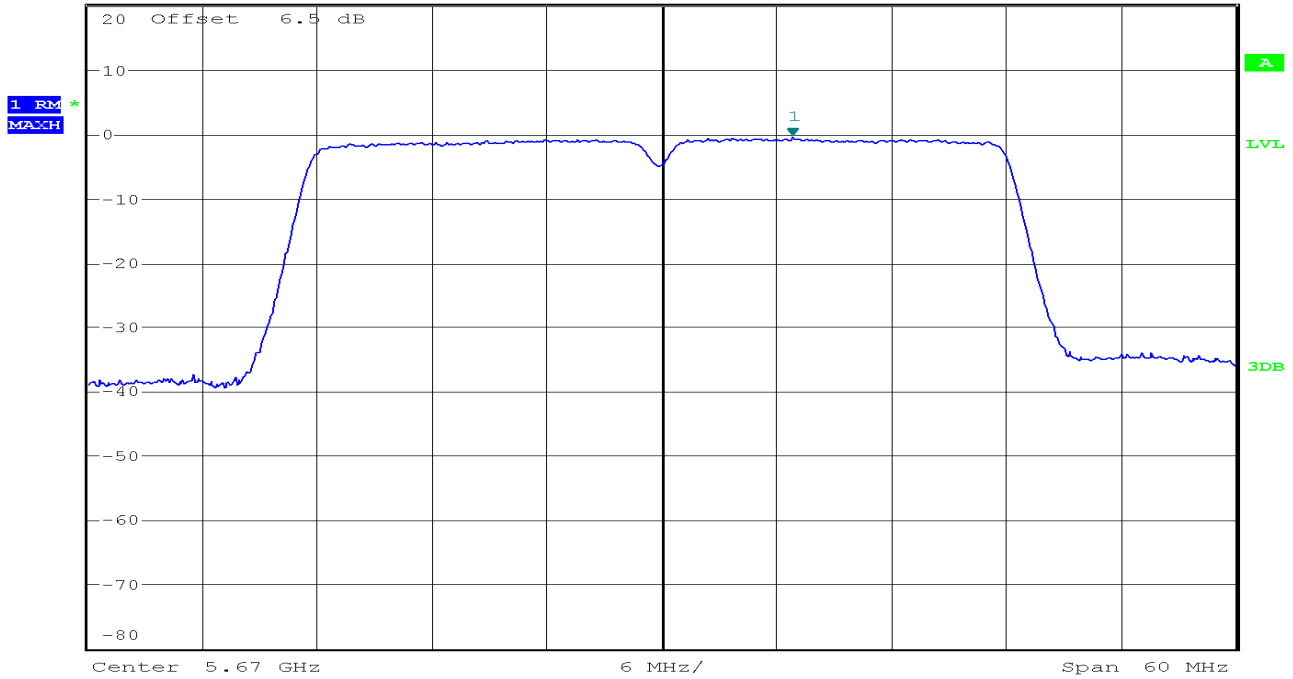

IEEE 802.11ac HT40 mode / Chain 1
5150~5250MHz

CH Low



Ref 20 dBm * Att 20 dB * RBW 1 MHz Marker 1 [T1]
 * VBW 3 MHz 1.17 dBm
 SWT 20 ms 5.195192308 GHz

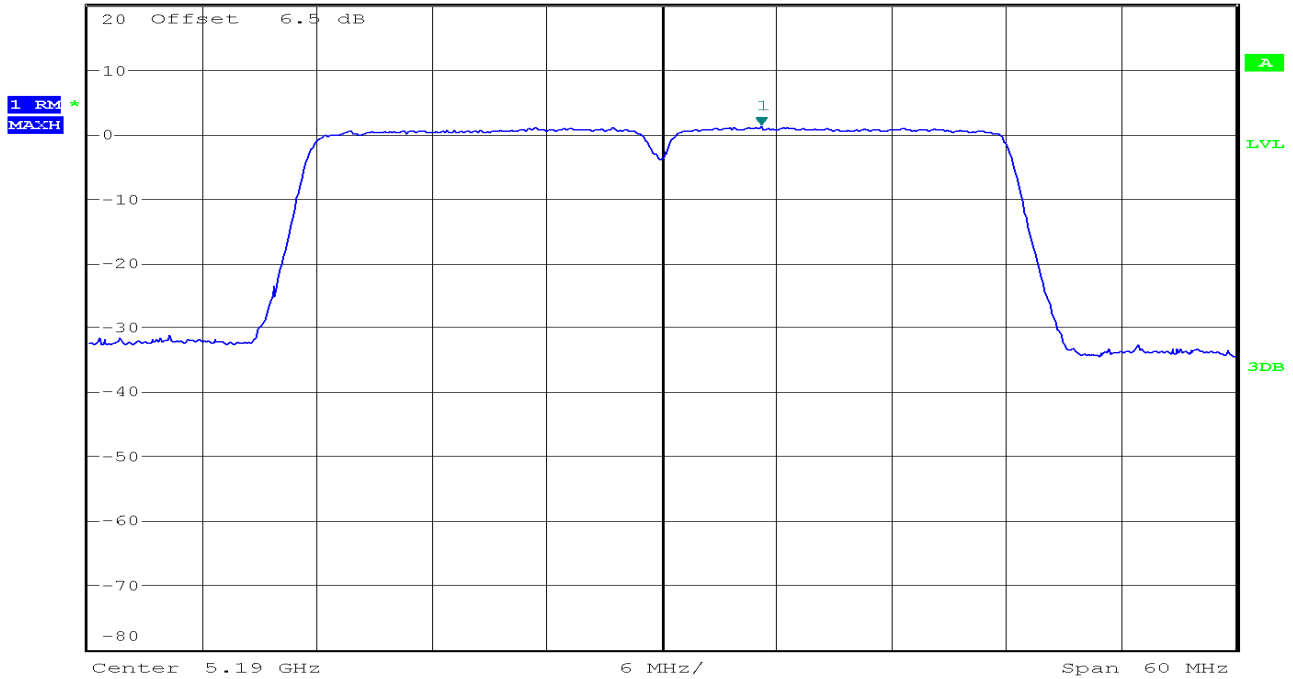

CH High



Ref 20 dBm * Att 20 dB * RBW 1 MHz Marker 1 [T1] 0.98 dBm
 * VBW 3 MHz SWT 20 ms 5.223269231 GHz

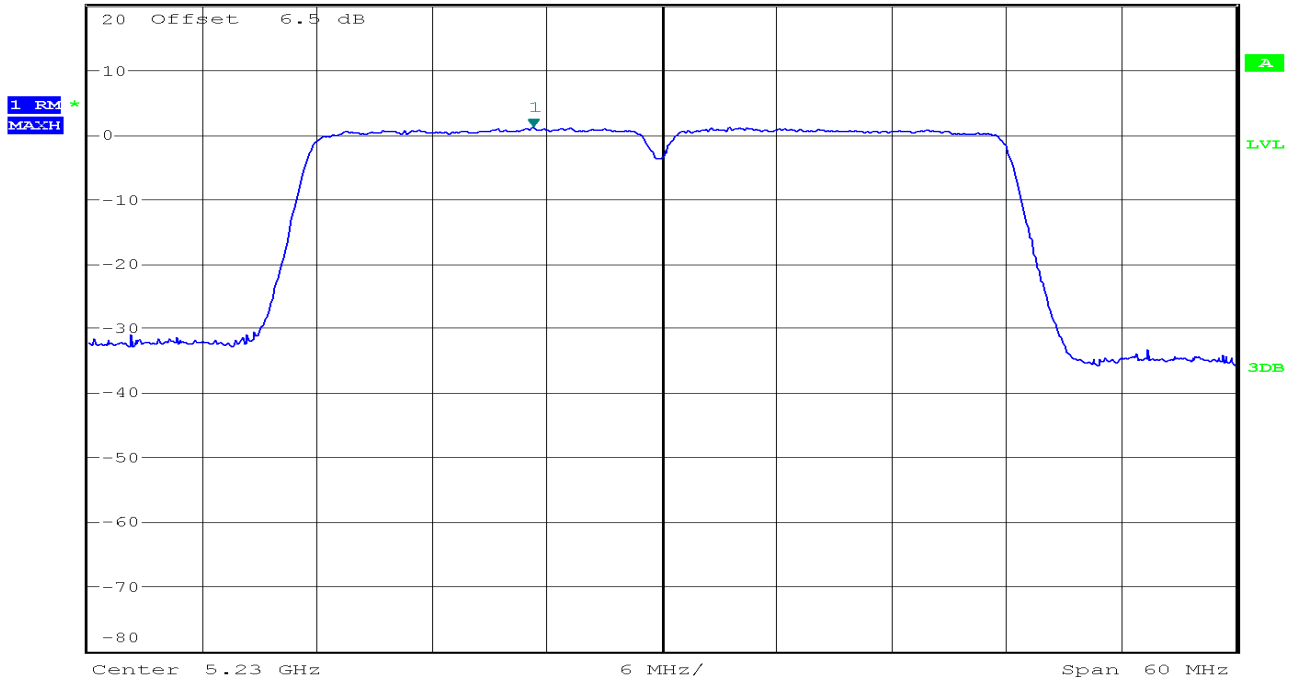

5250~5350MHz

CH Low



Ref 20 dBm * Att 20 dB * RBW 1 MHz Marker 1 [T1] 0.75 dBm
 * VBW 3 MHz SWT 20 ms 5.276153846 GHz

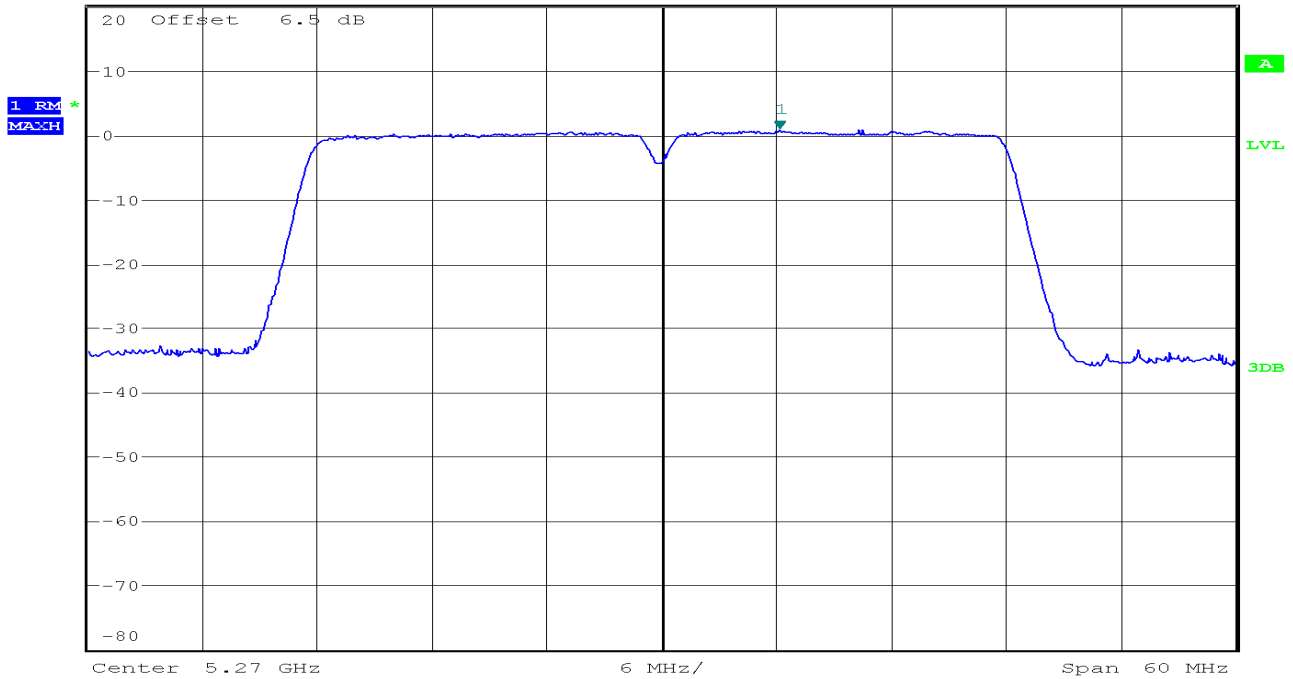

CH High



Ref 20 dBm * Att 20 dB * RBW 1 MHz Marker 1 [T1] 0.68 dBm
 * VBW 3 MHz SWT 20 ms 5.314615385 GHz

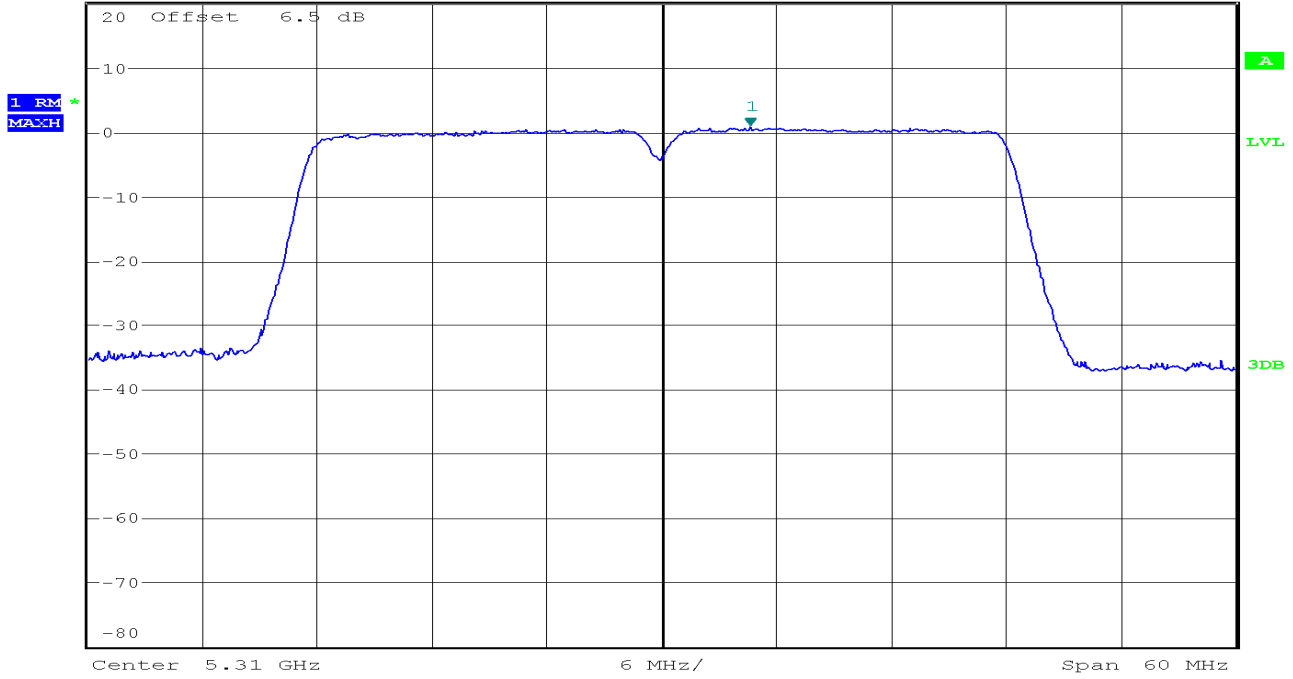

5470~5725MHz

CH Low



Ref 20 dBm * Att 20 dB * RBW 1 MHz Marker 1 [T1] 0.41 dBm
 * VBW 3 MHz SWT 20 ms 5.514423077 GHz

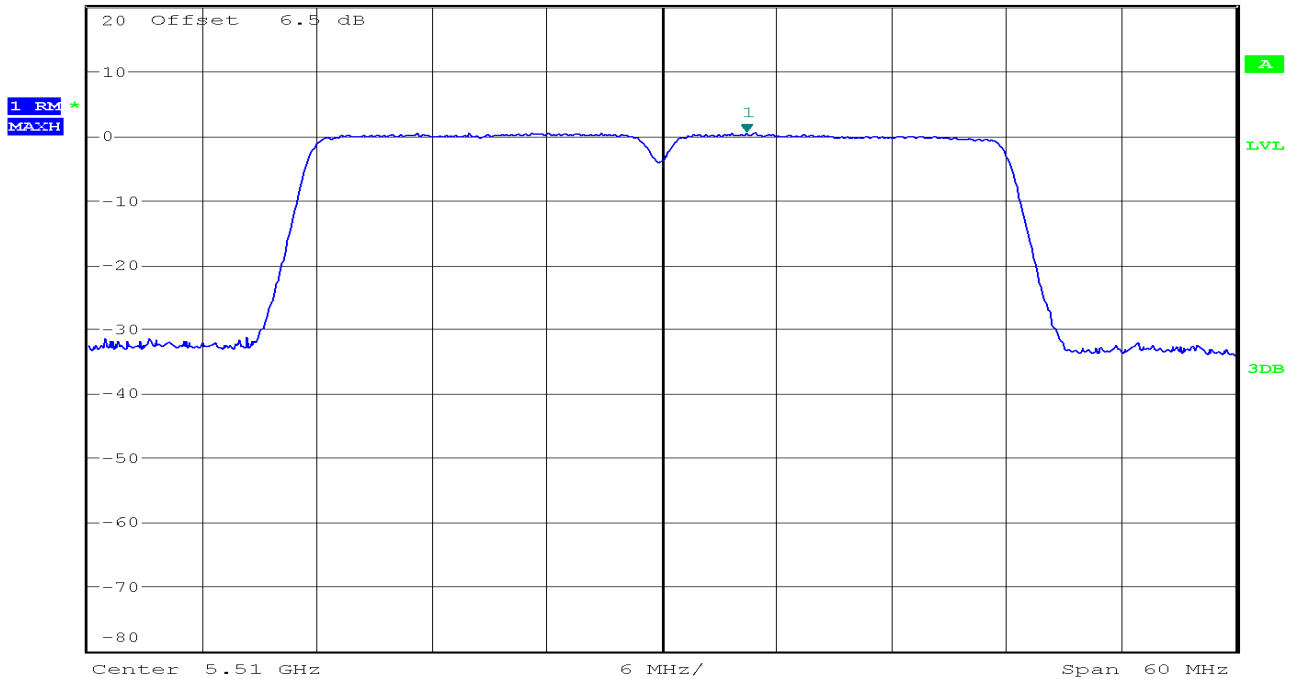

CH Mid



* RBW 1 MHz
* VBW 3 MHz
SWT 20 ms
Marker 1 [T1]
0.35 dBm
5.543173077 GHz

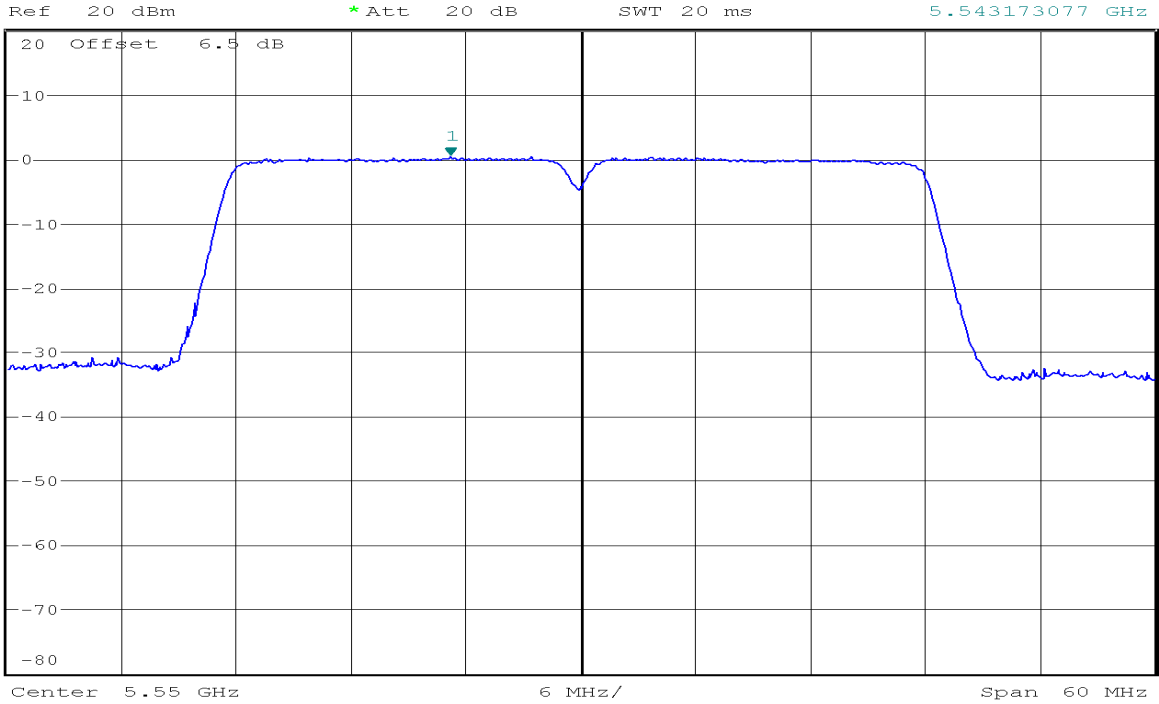

CH High



* RBW 1 MHz
* VBW 3 MHz
SWT 20 ms
Marker 1 [T1]
-0.39 dBm
5.683846154 GHz

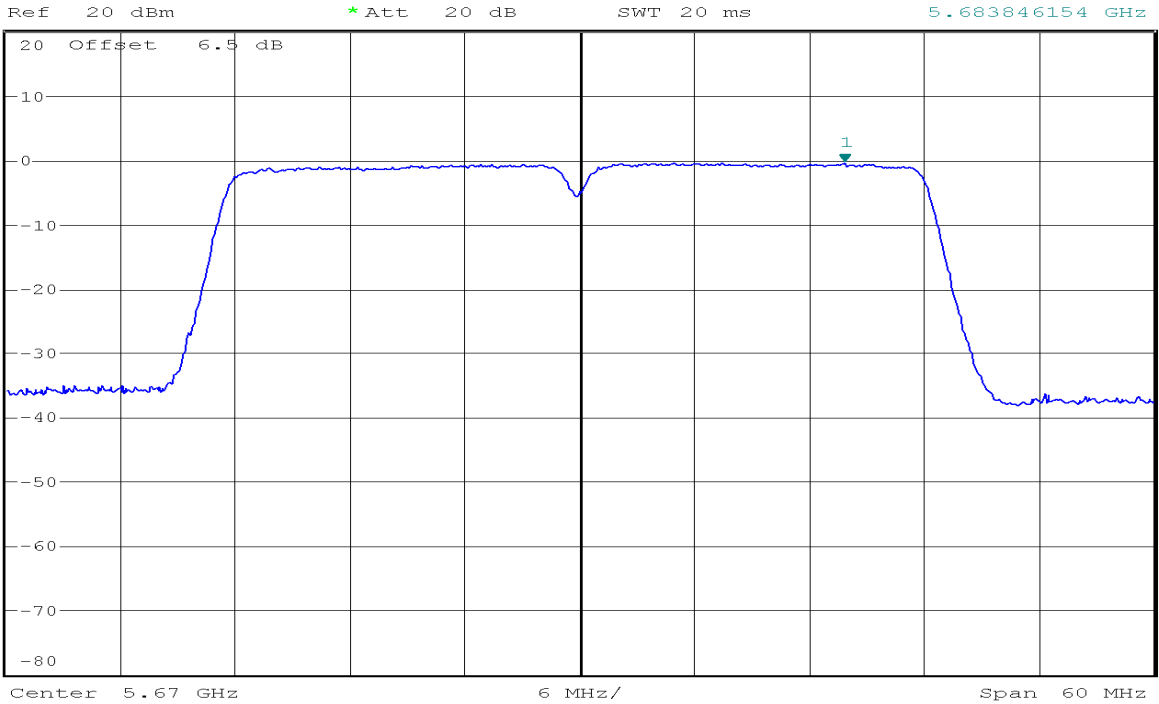

IEEE 802.11ac HT80 mode / Chain 0
5150~5250MHz

CH Mid

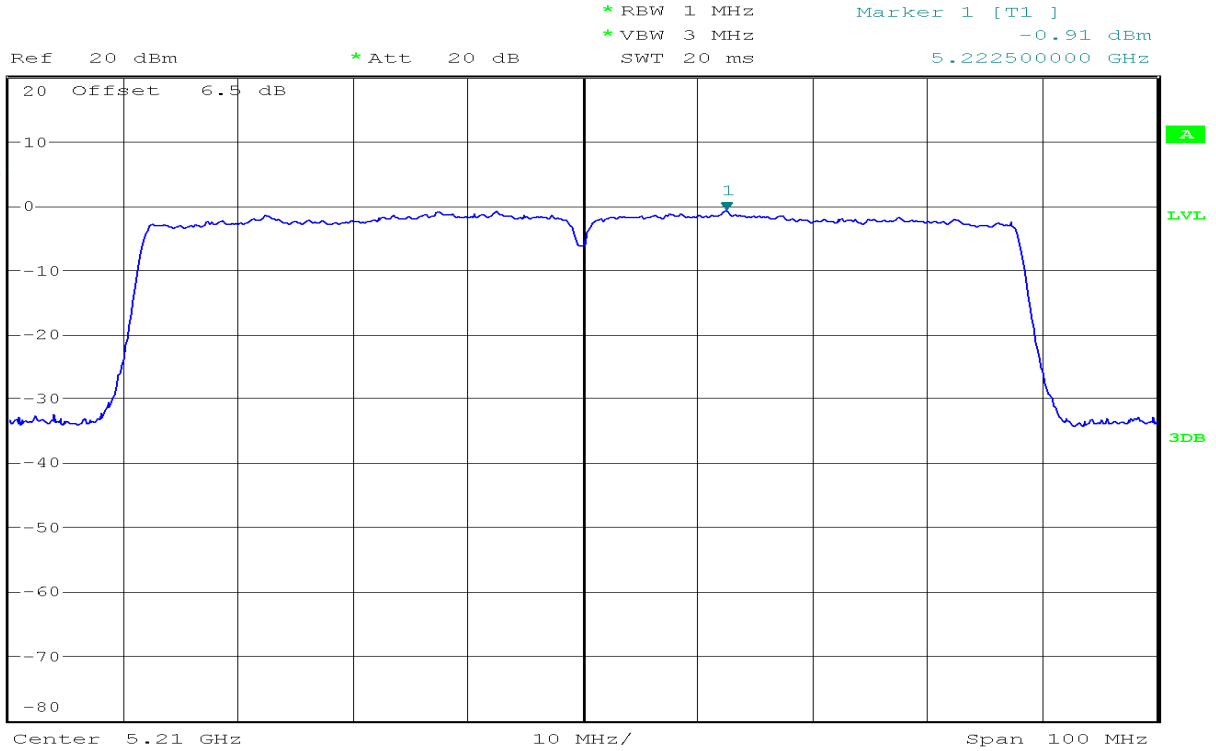

5250~5350MHz

CH Mid

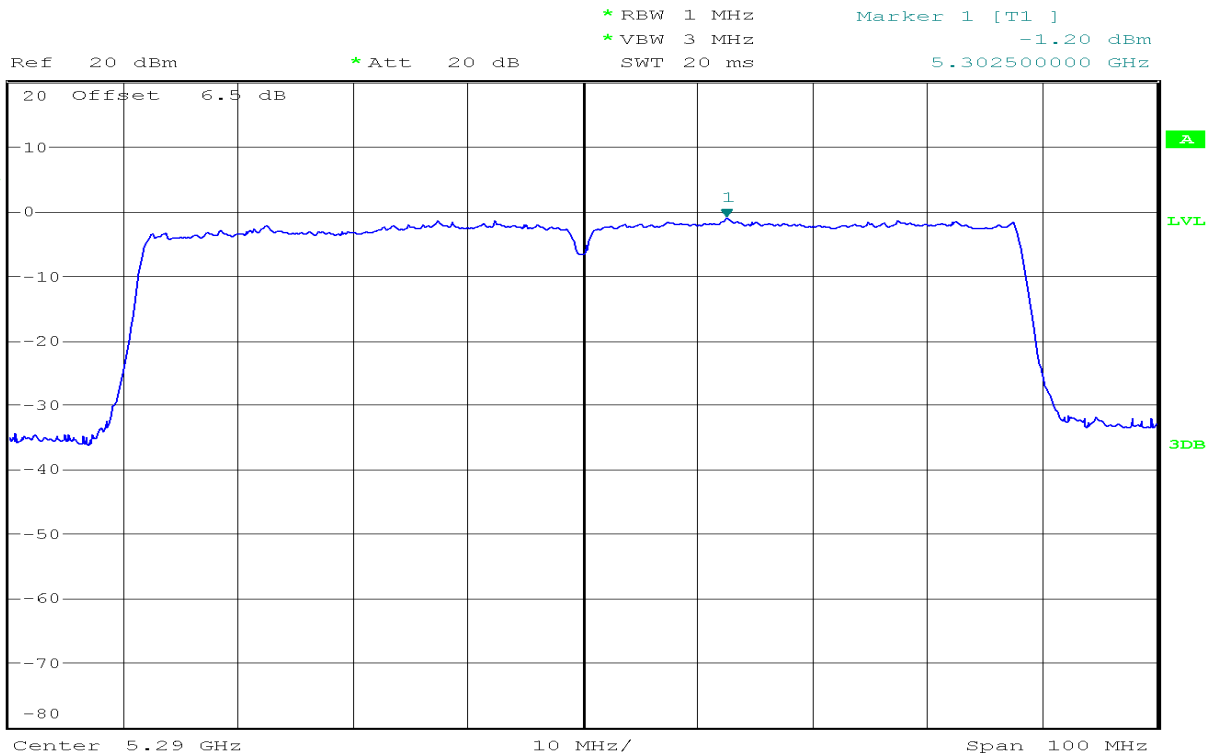

5470~5725MHz

CH Mid



Ref 20 dBm * Att 20 dB * RBW 1 MHz Marker 1 [T1] -2.25 dBm
 * VBW 3 MHz SWT 20 ms 5.522307692 GHz

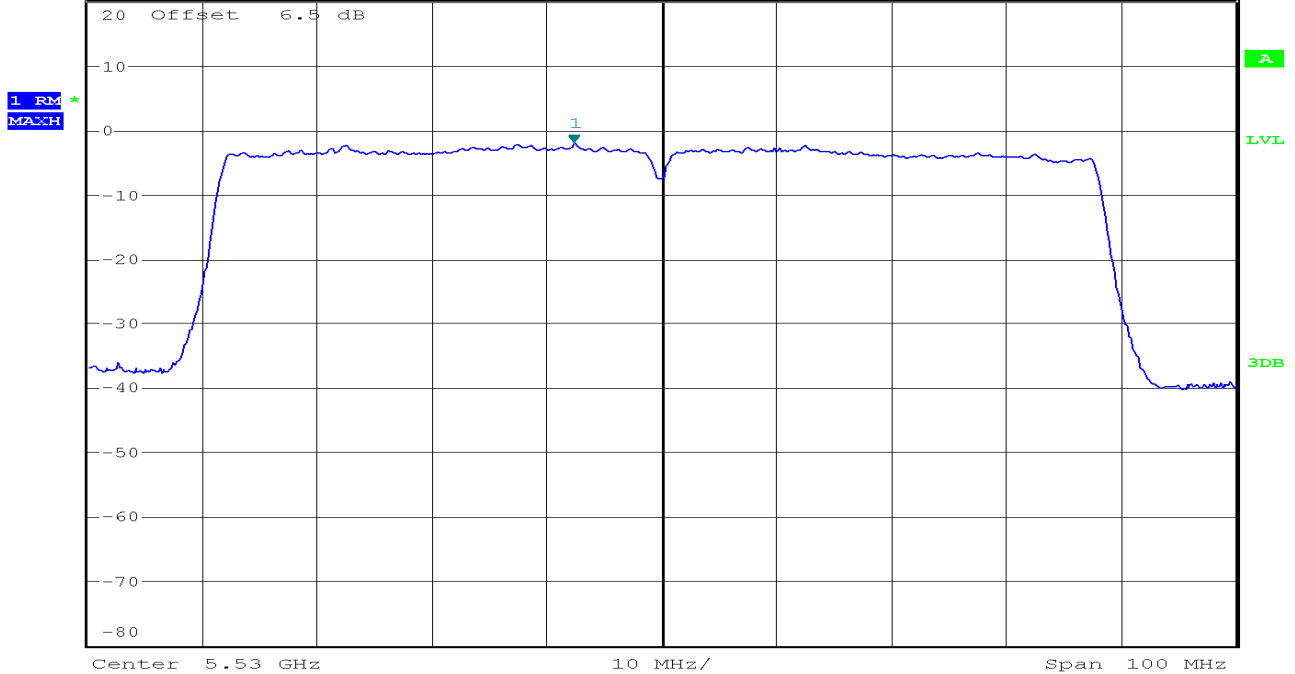

IEEE 802.11ac HT80 mode / Chain 1
5150~5250MHz

CH Mid



Ref 20 dBm * Att 20 dB * RBW 1 MHz Marker 1 [T1] -1.69 dBm
 * VBW 3 MHz SWT 20 ms 5.222339744 GHz

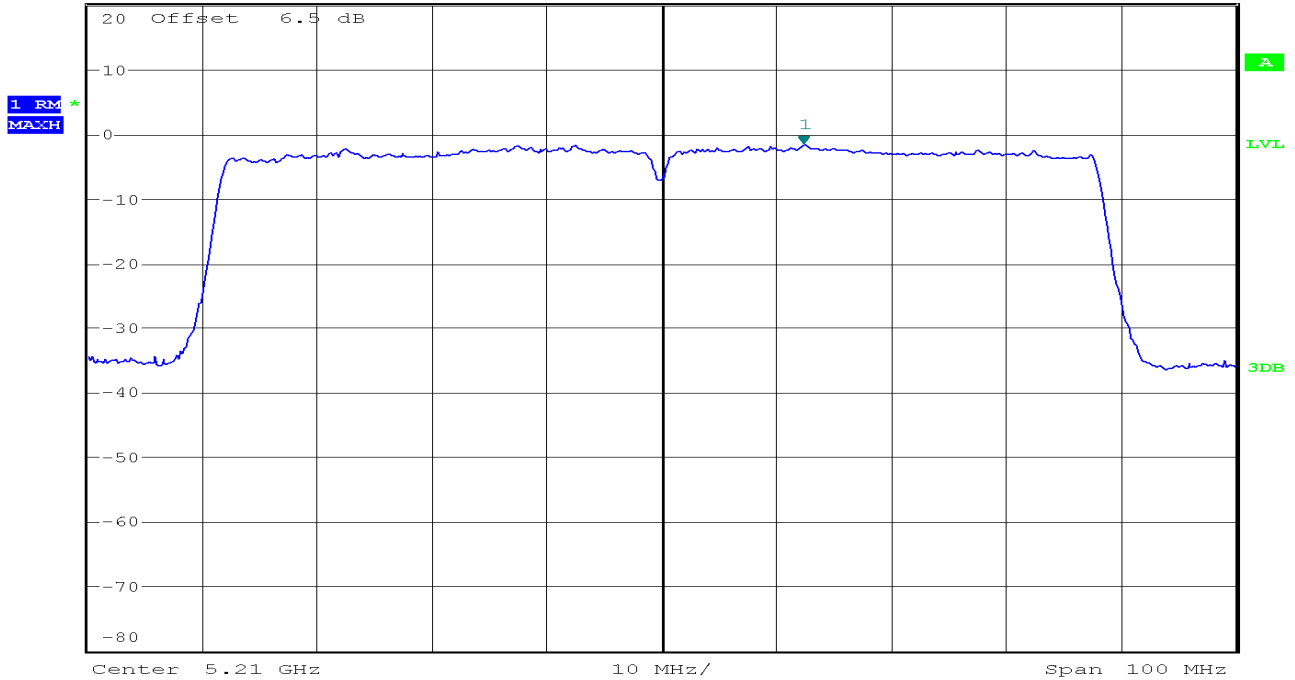

5250~5350MHz

CH Mid



Ref 20 dBm * Att 20 dB * RBW 1 MHz Marker 1 [T1]
 * VBW 3 MHz -2.47 dBm
 SWT 20 ms 5.302500000 GHz

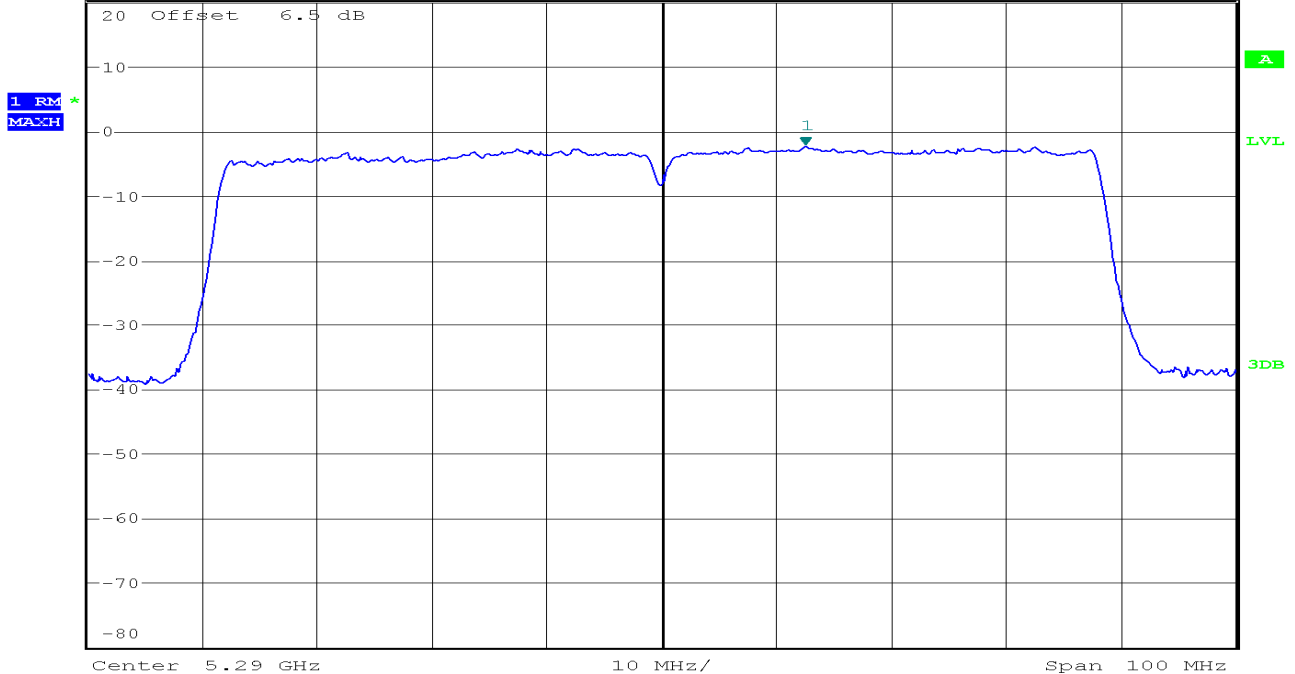

5470~5725MHz

CH Mid



Ref 20 dBm * Att 20 dB * RBW 1 MHz Marker 1 [T1]
 * VBW 3 MHz -2.68 dBm
 SWT 20 ms 5.522307692 GHz

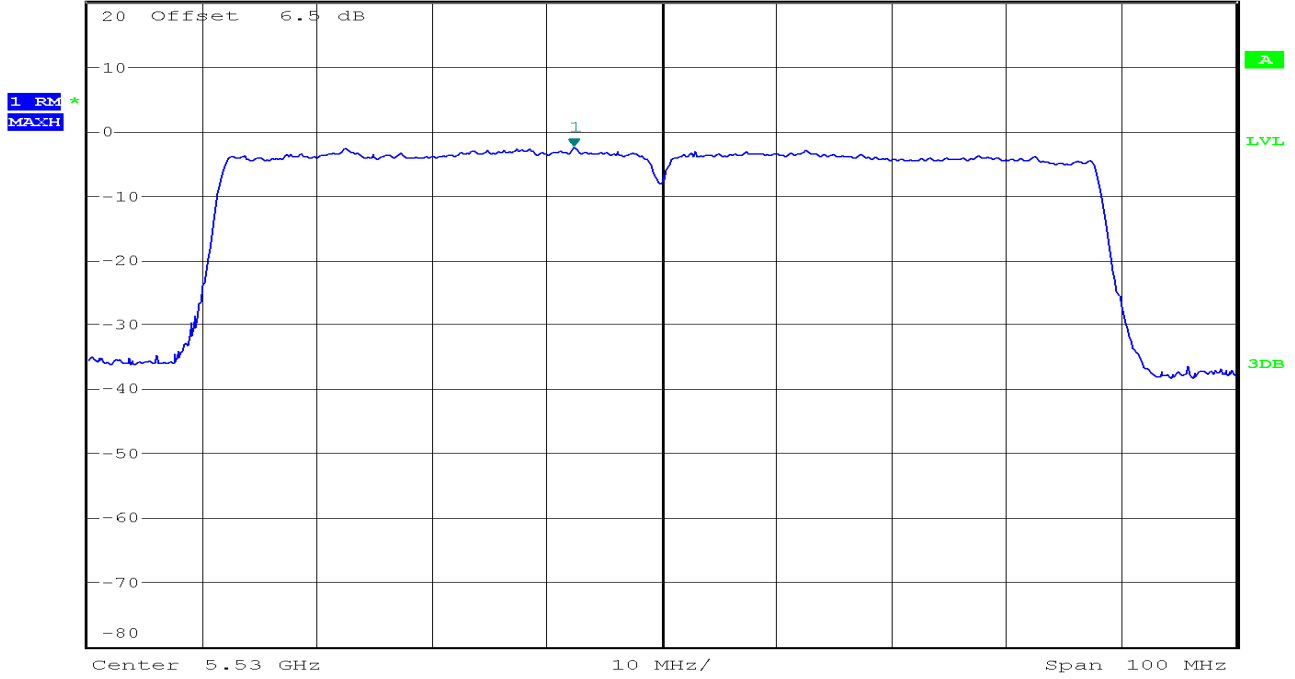

7.5 FREQUENCY STABILITY MEASUREMENT

LIMIT

According to §15.407(g), Manufacturers of U-NII devices are responsible for ensuring frequency stability such that an emission is maintained within the band of operation under all conditions of normal operation as specified in the user's manual.

TEST CONFIGURATION

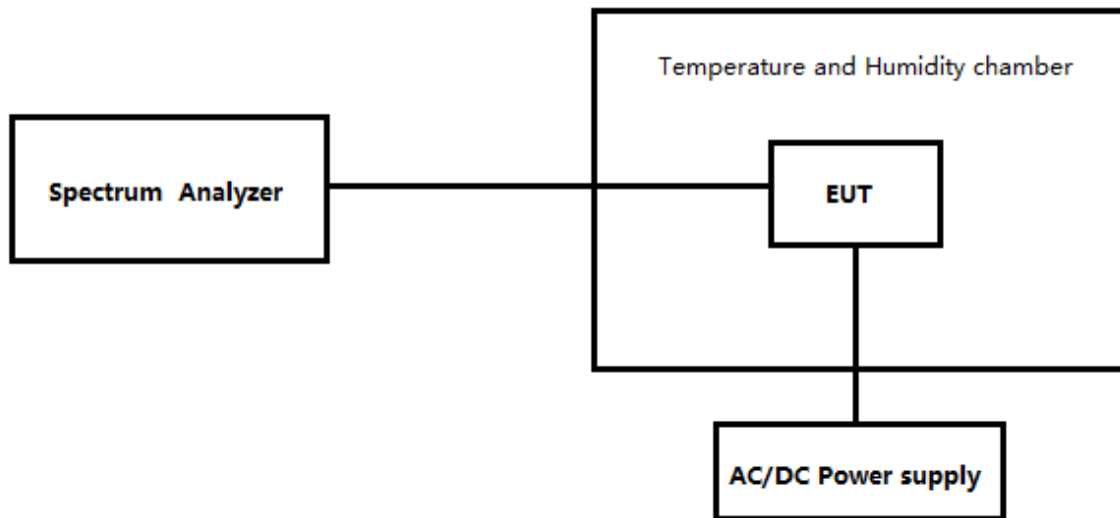

TEST PROCEDURE

1. To ensure emission at the band edge is maintained within the authorized band, those values shall be measured by radiation emissions at upper and lower frequency points, and finally compensated by frequency deviation as procedures below.
2. The EUT was operated at the maximum output power, and connected to the spectrum analyzer, which is set to maximum hold function and peak detector. The peak value of the power envelope was measured and noted. The upper and lower frequency points were respectively measured relatively 10dB lower than the measured peak value.
3. The frequency deviation was calculated by adding the upper frequency point and the lower frequency point divided by two. Those detailed values of frequency deviation are provided in table below.

TEST RESULTS

U-NII-1-(5150MHz-5250MHz)					
Freq.(MHz)	Center Frequency (MHz)	Frequency Deviation (MHz)	Frequency Stability (ppm)	Temperature (°C)	Voltage (V)
5180	5180.000	0.000	0.00	25	V _{min}
5180	5180.000	0.000	0.00	25	V _{max}
5180	5180.000	0.000	0.00	25	V _{nor}
5180	5180.000	0.000	0.00	-10	V _{nor}
5180	5179.991	-0.009	-1.74	40	V _{nor}

U-NII-2A-(5250MHz-5350MHz)					
Freq.(MHz)	Center Frequency (MHz)	Frequency Deviation (MHz)	Frequency Stability (ppm)	Temperature (°C)	Voltage (V)
5320	5320.000	0.000	0.00	25	V _{min}
5320	5320.000	0.000	0.00	25	V _{max}
5320	5320.000	0.000	0.00	25	V _{nor}
5320	5319.968	-0.032	-6.02	-10	V _{nor}
5320	5320.000	0.000	0.00	40	V _{nor}

U-NII-2C-(5470MHz-5725MHz)					
Freq.(MHz)	Center Frequency (MHz)	Frequency Deviation (MHz)	Frequency Stability (ppm)	Temperature (°C)	Voltage (V)
5500	5500.000	0.000	0.00	25	V _{min}
5500	5500.000	0.000	0.00	25	V _{max}
5500	5500.013	0.013	2.36	25	V _{nor}
5500	5500.000	0.000	0.00	-10	V _{nor}
5500	5500.000	0.000	0.00	40	V _{nor}

7.6 RADIATED UNDESIRABLE EMISSION

LIMIT

Radiated emissions from 9 kHz to 25 GHz were measured according to the methods defines in ANSI C63.10-2013. The EUT was placed above the ground plane, 0.8 meter for frequency below 1GHz and 1.5 meter for frequency above 1GHz. The interface cables and equipment positions were varied within limits of reasonable applications to determine the positions producing maximum radiated emissions

1. According to §15.209(a), except as provided elsewhere in this Subpart, the emissions from an intentional radiator shall not exceed the field strength levels specified in the following table:

FREQUENCIES(MHz)	FIELD STRENGTH (microvolts/meter)	MEASUREMENT DISTANCE(meters)
0.009~0.490	2400/F(kHz)	300
0.490~1.705	24000/F(kHz)	30
1.705~30.0	30	30
30~88	100	3
88~216	150	3
216~960	200	3
Above 960	500	3

Remark: Except as provided in paragraph (g), fundamental emissions from intentional radiators operating under this Section shall not be located in the frequency bands 54-72 MHz, 76-88 MHz, 174-216 MHz or 470-806 MHz. However, operation within these frequency bands is permitted under other sections of this Part, e.g., Sections 15.231 and 15.241.

2. In the emission table above, the tighter limit applies at the band edges.

Frequency (MHz)	Field Strength (µV/m at 3-meter)	Field Strength (dBµV/m at 3-meter)
30-88	100	40
88-216	150	43.5
216-960	200	46
Above 960	500	54

Test Configuration

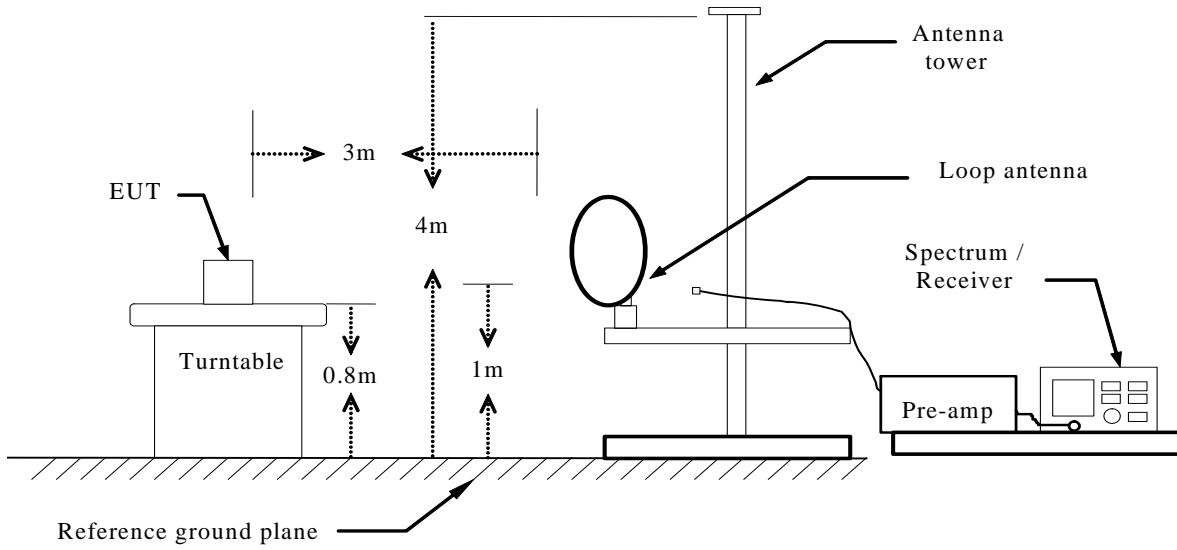
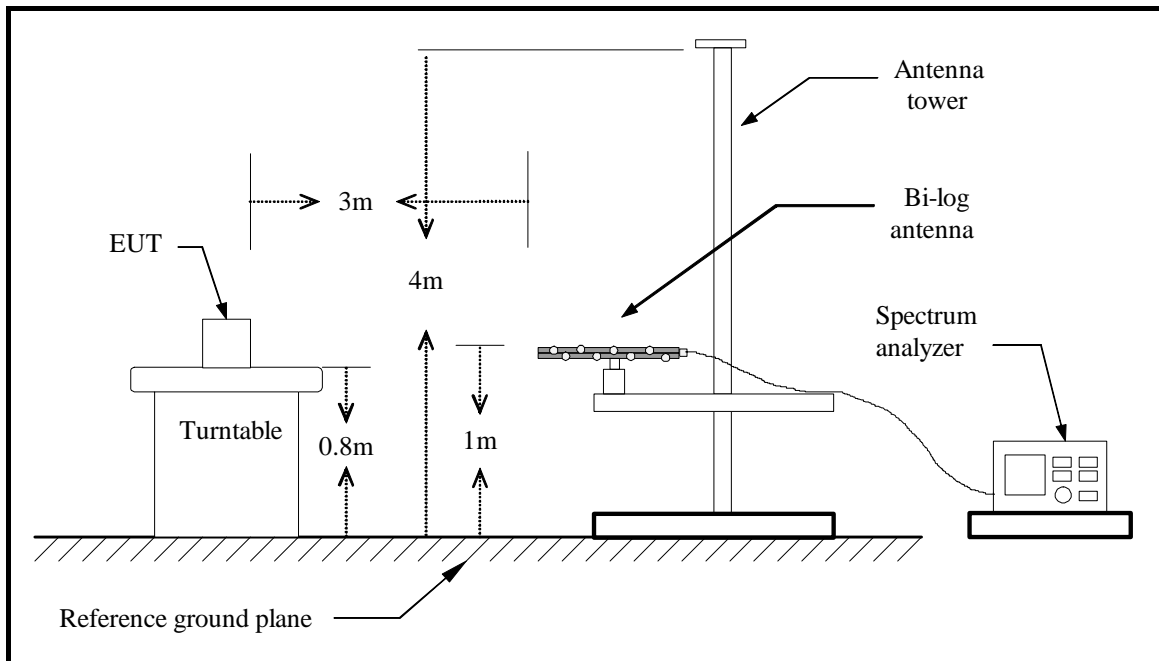
Below 30MHz**Below 1 GHz**

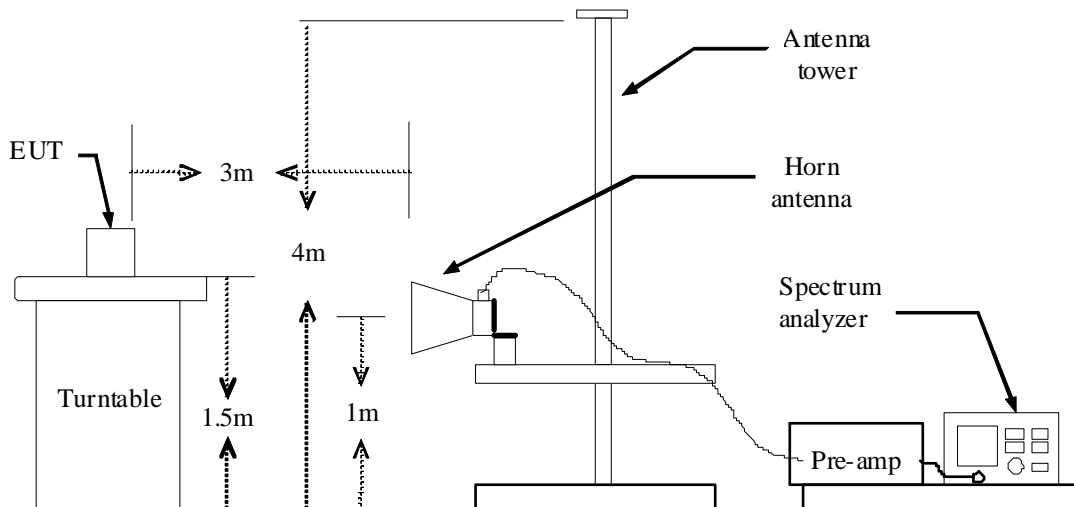
Above 1 GHz**TEST PROCEDURE**

1. The EUT is placed on a turntable above ground plane, which is 0.8 meter for frequency below 1GHz and 1.5 meter for frequency above 1GHz.
2. The turntable shall be rotated for 360 degrees to determine the position of maximum emission level.
3. EUT is set 3m away from the receiving antenna, which is varied from 1m to 4m to find out the highest emissions.
4. Maximum procedure was performed on the six highest emissions to ensure EUT compliance.
5. And also, each emission was to be maximized by changing the polarization of receiving antenna both horizontal and vertical.
6. Set the spectrum analyzer in the following setting as:

Below 1GHz:

RBW=100kHz / VBW=300kHz / Sweep=AUTO

Above 1GHz:

(a) PEAK: RBW=VBW=1MHz / Sweep=AUTO

(b) AVERAGE: RBW=1MHz / VBW=10Hz / Sweep=AUTO

7. Repeat above procedures until the measurements for all frequencies are complete.

TEST RESULTS

Below 30MHz

The interference of the frequency value is lower than the limit below 20 db, measured as the background noise values and will not be recorded.

Below 1 GHz

Operation Mode:	Normal Link	Test Date:	206-4-12
Temperature:	25°C	Tested by:	Lily.Wang
Humidity:	48% RH	Polarity:	Ver. / Hor.

Frequency (MHz)	Ant. Pol. (H/V)	Reading (dBuV)	Correction Factor (dB/m)	Result (dBuV/m)	Limit (dBuV/m)	Margin (dB)	Remark
32.9100	V	16.32	19.19	35.51	40.00	-4.49	peak
95.9600	V	24.35	9.55	33.90	40.00	-6.10	peak
114.3900	V	22.61	10.30	32.91	40.00	-7.09	peak
197.8100	V	23.48	12.24	35.72	40.00	-4.28	peak
701.2400	V	21.72	21.54	43.26	47.00	-3.74	QP
793.3900	V	23.96	22.78	46.74	47.00	-0.26	QP
31.9400	H	14.55	19.70	34.25	40.00	-5.75	peak
70.7400	H	25.48	8.66	34.14	40.00	-5.86	peak
116.3300	H	23.49	10.35	33.84	40.00	-6.16	peak
149.3100	H	18.57	11.11	29.68	40.00	-10.32	peak
701.2400	H	23.32	21.54	44.86	47.00	-2.14	peak
792.4200	H	20.05	22.77	42.82	47.00	-4.18	peak

Remark:

1. Measuring frequencies from 30 MHz to the 1GHz.(no emission found from the lowest internal used/generated frequency to 30MHz)
2. Radiated emissions measured were made with an instrument using peak/quasi-peak detector mode.
3. Quasi-peak test would be performed if the peak result were greater than the quasi-peak limit or as required by the applicant.
4. Measurements above show only up to 6 maximum emissions noted, or would be lesser, with " N/A " remark, if no specific emissions from the EUT are recorded (ie: margin>20dB from the applicable limit) and considered that's already beyond the background noise floor.
5. Margin (dB) = Remark result (dBuV/m) – Quasi-peak limit (dBuV/m).

Above 1 GHz

5150~5250MHz

Operation Mode:	Tx / IEEE 802.11a mode CH Low	Test Date:	2016-4-12
Temperature:	25°C	Tested by:	Lily.Wang
Humidity:	55% RH	Polarity:	Ver. / Hor.

Horizontal

No.	Frequency (MHz)	Reading (dBuV)	Correct Factor(dB/m)	Result (dBuV/m)	Limit (dBuV/m)	Margin (dB)	Height (cm)	Degree (deg.)	Remark
1	10453.526	40.18	5.98	46.16	74.00	-27.84	100	357	peak
2	15302.885	39.52	4.27	43.79	74.00	-30.21	100	199	peak
N/A									

Vertical

No.	Frequency (MHz)	Reading (dBuV)	Correct Factor(dB/m)	Result (dBuV/m)	Limit (dBuV/m)	Margin (dB)	Height (cm)	Degree (deg.)	Remark
1	10290.064	40.61	6.12	46.73	74.00	-27.27	100	210	peak
2	15330.128	40.09	4.10	44.19	74.00	-29.81	100	0	peak
N/A									

Operation Mode:	Tx / IEEE 802.11a mode CH Mid	Test Date:	2016-4-12
Temperature:	25°C	Tested by:	Lily.Wang
Humidity:	55% RH	Polarity:	Ver. / Hor.

Horizontal

No.	Frequency (MHz)	Reading (dBuV)	Correct Factor(dB/m)	Result (dBuV/m)	Limit (dBuV/m)	Margin (dB)	Height (cm)	Degree (deg.)	Remark
1	10290.064	40.79	6.12	46.91	74.00	-27.09	100	337	peak
2	15466.346	39.67	3.25	42.92	74.00	-31.08	100	38	peak
N/A									

Vertical

No.	Frequency (MHz)	Reading (dBuV)	Correct Factor(dB/m)	Result (dBuV/m)	Limit (dBuV/m)	Margin (dB)	Height (cm)	Degree (deg.)	Remark
1	10535.256	41.23	5.92	47.15	74.00	-26.85	100	118	peak
2	15057.692	38.57	5.78	44.35	74.00	-29.65	100	211	peak
N/A									

Operation Mode:	Tx / IEEE 802.11a mode CH High	Test Date:	2016-4-12
Temperature:	25°C	Tested by:	Lily.Wang
Humidity:	55% RH	Polarity:	Ver. / Hor.

Horizontal

No.	Frequency (MHz)	Reading (dBuV)	Correct Factor(dB/m)	Result (dBuV/m)	Limit (dBuV/m)	Margin (dB)	Height (cm)	Degree (deg.)	Remark
1	10753.205	39.88	5.73	45.61	74.00	-28.39	100	324	peak
2	15466.346	38.96	3.25	42.21	74.00	-31.79	100	1	peak
N/A									

Vertical

No.	Frequency (MHz)	Reading (dBuV)	Correct Factor(dB/m)	Result (dBuV/m)	Limit (dBuV/m)	Margin (dB)	Height (cm)	Degree (deg.)	Remark
1	10725.961	40.22	5.76	45.98	74.00	-28.02	100	148	peak
2	15221.154	40.67	4.77	45.44	74.00	-28.56	100	72	peak
N/A									

5250~5350MHz

Operation Mode:	Tx / IEEE 802.11a mode CH Low	Test Date:	2016-4-12
Temperature:	25°C	Tested by:	Lily.Wang
Humidity:	55% RH	Polarity:	Ver. / Hor.

Horizontal

No.	Frequency (MHz)	Reading (dBuV)	Correct Factor(dB/m)	Result (dBuV/m)	Limit (dBuV/m)	Margin (dB)	Height (cm)	Degree (deg.)	Remark
1	10508.013	41.18	5.94	47.12	74.00	-26.88	100	3	peak
2	13123.397	39.97	9.41	49.38	74.00	-24.62	100	356	peak
N/A									

Vertical

No.	Frequency (MHz)	Reading (dBuV)	Correct Factor(dB/m)	Result (dBuV/m)	Limit (dBuV/m)	Margin (dB)	Height (cm)	Degree (deg.)	Remark
1	10344.551	40.77	6.07	46.84	74.00	-27.16	100	161	peak
2	13096.154	39.81	9.50	49.31	74.00	-24.69	100	305	peak
N/A									

Operation Mode:	Tx / IEEE 802.11a mode CH Mid	Test Date:	2016-4-12
Temperature:	25°C	Tested by:	Lily.Wang
Humidity:	55% RH	Polarity:	Ver. / Hor.

Horizontal

No.	Frequency (MHz)	Reading (dBuV)	Correct Factor(dB/m)	Result (dBuV/m)	Limit (dBuV/m)	Margin (dB)	Height (cm)	Degree (deg.)	Remark
1	11189.103	40.07	5.06	45.13	74.00	-28.87	100	75	peak
2	15384.615	39.91	3.76	43.67	74.00	-30.33	100	126	peak
N/A									

Vertical

No.	Frequency (MHz)	Reading (dBuV)	Correct Factor(dB/m)	Result (dBuV/m)	Limit (dBuV/m)	Margin (dB)	Height (cm)	Degree (deg.)	Remark
1	10971.154	39.24	5.55	44.79	74.00	-29.21	100	230	peak
2	15411.859	39.19	3.59	42.78	74.00	-31.22	100	14	peak
N/A									

Operation Mode:	Tx / IEEE 802.11a mode CH High	Test Date:	2016-4-12
Temperature:	25°C	Tested by:	Lily.Wang
Humidity:	55% RH	Polarity:	Ver. / Hor.

Horizontal

No.	Frequency (MHz)	Reading (dBuV)	Correct Factor(dB/m)	Result (dBuV/m)	Limit (dBuV/m)	Margin (dB)	Height (cm)	Degree (deg.)	Remark
1	10644.231	40.26	5.83	46.09	74.00	-27.91	100	217	peak
2	15493.590	38.76	3.08	41.84	74.00	-32.16	100	165	peak
N/A									

Vertical

No.	Frequency (MHz)	Reading (dBuV)	Correct Factor(dB/m)	Result (dBuV/m)	Limit (dBuV/m)	Margin (dB)	Height (cm)	Degree (deg.)	Remark
1	10644.231	41.36	5.83	47.19	74.00	-26.81	100	127	peak
2	15302.885	39.46	4.27	43.73	74.00	-30.27	100	68	peak
N/A									

5470~5725MHz

Operation Mode:	Tx / IEEE 802.11a mode CH Low	Test Date:	2016-4-12
Temperature:	25°C	Tested by:	Lily.Wang
Humidity:	55% RH	Polarity:	Ver. / Hor.

Horizontal

No.	Frequency (MHz)	Reading (dBuV)	Correct Factor(dB/m)	Result (dBuV/m)	Limit (dBuV/m)	Margin (dB)	Height (cm)	Degree (deg.)	Remark
1	10889.423	40.02	5.62	45.64	74.00	-28.36	100	135	peak
2	17346.154	37.01	10.76	47.77	74.00	-26.23	100	97	peak
N/A									

Vertical

No.	Frequency (MHz)	Reading (dBuV)	Correct Factor(dB/m)	Result (dBuV/m)	Limit (dBuV/m)	Margin (dB)	Height (cm)	Degree (deg.)	Remark
1	11270.833	41.89	4.85	46.74	74.00	-27.26	100	289	peak
2	15902.244	36.01	0.56	36.57	74.00	-37.43	100	243	peak
N/A									

Operation Mode:	Tx / IEEE 802.11a mode CH Mid	Test Date:	2016-4-12
Temperature:	25°C	Tested by:	Lily.Wang
Humidity:	55% RH	Polarity:	Ver. / Hor.

Horizontal

No.	Frequency (MHz)	Reading (dBuV)	Correct Factor(dB/m)	Result (dBuV/m)	Limit (dBuV/m)	Margin (dB)	Height (cm)	Degree (deg.)	Remark
1	11243.590	41.37	4.92	46.29	74.00	-27.71	100	333	peak
2	16991.987	37.58	7.49	45.07	74.00	-28.93	100	243	peak
N/A									

Vertical

No.	Frequency (MHz)	Reading (dBuV)	Correct Factor(dB/m)	Result (dBuV/m)	Limit (dBuV/m)	Margin (dB)	Height (cm)	Degree (deg.)	Remark
1	11679.487	39.03	3.82	42.85	74.00	-31.15	100	303	peak
2	14540.064	38.14	6.26	44.40	74.00	-29.60	100	144	peak
N/A									

Operation Mode:	Tx / IEEE 802.11a mode CH High	Test Date:	2016-4-12
Temperature:	25°C	Tested by:	Lily.Wang
Humidity:	55% RH	Polarity:	Ver. / Hor.

Horizontal

No.	Frequency (MHz)	Reading (dBuV)	Correct Factor(dB/m)	Result (dBuV/m)	Limit (dBuV/m)	Margin (dB)	Height (cm)	Degree (deg.)	Remark
1	12197.115	39.35	4.36	43.71	74.00	-30.29	100	216	peak
2	15439.103	38.78	3.42	42.20	74.00	-31.80	100	85	peak
N/A									

Vertical

No.	Frequency (MHz)	Reading (dBuV)	Correct Factor(dB/m)	Result (dBuV/m)	Limit (dBuV/m)	Margin (dB)	Height (cm)	Degree (deg.)	Remark
1	11870.192	41.28	3.35	44.63	74.00	-29.37	100	198	peak
2	15411.859	39.17	3.59	42.76	74.00	-31.24	100	189	peak
N/A									

5150~5250MHz

Operation Mode:	TX / IEEE 802.11n HT20 mode /CH Low	Test Date:	2016-4-12
Temperature:	25°C	Tested by:	Lily.Wang
Humidity:	55% RH	Polarity:	Ver. / Hor.

Horizontal

No.	Frequency (MHz)	Reading (dBuV)	Correct Factor(dB/m)	Result (dBuV/m)	Limit (dBuV/m)	Margin (dB)	Height (cm)	Degree (deg.)	Remark
1	10044.872	40.65	6.32	46.97	74.00	-27.03	100	38	peak
2	15302.885	38.78	4.27	43.05	74.00	-30.95	100	236	peak
N/A									

Vertical

No.	Frequency (MHz)	Reading (dBuV)	Correct Factor(dB/m)	Result (dBuV/m)	Limit (dBuV/m)	Margin (dB)	Height (cm)	Degree (deg.)	Remark
1	10371.795	40.59	6.05	46.64	74.00	-27.36	100	50	peak
2	15030.449	38.47	5.95	44.42	74.00	-29.58	100	11	peak
N/A									

Operation Mode:	TX / IEEE 802.11n HT20 mode /CH Mid	Test Date:	2016-4-12
Temperature:	25°C	Tested by:	Lily.Wang
Humidity:	55% RH	Polarity:	Ver. / Hor.

Horizontal

No.	Frequency (MHz)	Reading (dBuV)	Correct Factor(dB/m)	Result (dBuV/m)	Limit (dBuV/m)	Margin (dB)	Height (cm)	Degree (deg.)	Remark
1	10589.744	39.87	5.87	45.74	74.00	-28.26	100	313	peak
2	15112.180	39.09	5.45	44.54	74.00	-29.46	100	317	peak
N/A									

Vertical

No.	Frequency (MHz)	Reading (dBuV)	Correct Factor(dB/m)	Result (dBuV/m)	Limit (dBuV/m)	Margin (dB)	Height (cm)	Degree (deg.)	Remark
1	10508.013	40.47	5.94	46.41	74.00	-27.59	100	137	peak
2	14948.718	39.66	6.15	45.81	74.00	-28.19	100	168	peak
N/A									

Operation Mode:	TX / IEEE 802.11n HT20 mode /CH High	Test Date:	2016-4-12
Temperature:	25°C	Tested by:	Lily.Wang
Humidity:	55% RH	Polarity:	Ver. / Hor.

Horizontal

No.	Frequency (MHz)	Reading (dBuV)	Correct Factor(dB/m)	Result (dBuV/m)	Limit (dBuV/m)	Margin (dB)	Height (cm)	Degree (deg.)	Remark
1	10535.256	40.61	5.92	46.53	74.00	-27.47	100	201	peak
2	15275.641	39.60	4.43	44.03	74.00	-29.97	100	360	peak
N/A									

Vertical

No.	Frequency (MHz)	Reading (dBuV)	Correct Factor(dB/m)	Result (dBuV/m)	Limit (dBuV/m)	Margin (dB)	Height (cm)	Degree (deg.)	Remark
1	10753.205	40.34	5.73	46.07	74.00	-27.93	100	341	peak
2	15411.859	39.21	3.59	42.80	74.00	-31.20	100	165	peak
N/A									

5250~5350MHz

Operation Mode:	TX / IEEE 802.11n HT20 mode /CH Low	Test Date:	2016-4-12
Temperature:	25°C	Tested by:	Lily.Wang
Humidity:	55% RH	Polarity:	Ver. / Hor.

Horizontal

No.	Frequency (MHz)	Reading (dBuV)	Correct Factor(dB/m)	Result (dBuV/m)	Limit (dBuV/m)	Margin (dB)	Height (cm)	Degree (deg.)	Remark
1	12850.961	40.77	8.82	49.59	74.00	-24.41	100	49	peak
2	17591.346	38.60	13.04	51.64	74.00	-22.36	100	25	peak
N/A									

Vertical

No.	Frequency (MHz)	Reading (dBuV)	Correct Factor(dB/m)	Result (dBuV/m)	Limit (dBuV/m)	Margin (dB)	Height (cm)	Degree (deg.)	Remark
1	10508.013	41.09	5.94	47.03	74.00	-26.97	100	116	peak
2	14894.231	38.96	6.17	45.13	74.00	-28.87	100	314	peak
N/A									

Operation Mode:	TX / IEEE 802.11n HT20 mode /CH Mid	Test Date:	2016-4-12
Temperature:	25°C	Tested by:	Lily.Wang
Humidity:	55% RH	Polarity:	Ver. / Hor.

Horizontal

No.	Frequency (MHz)	Reading (dBuV)	Correct Factor(dB/m)	Result (dBuV/m)	Limit (dBuV/m)	Margin (dB)	Height (cm)	Degree (deg.)	Remark
1	11189.103	40.82	5.06	45.88	74.00	-28.12	100	220	peak
2	15466.346	38.72	3.25	41.97	74.00	-32.03	100	354	peak
N/A									

Vertical

No.	Frequency (MHz)	Reading (dBuV)	Correct Factor(dB/m)	Result (dBuV/m)	Limit (dBuV/m)	Margin (dB)	Height (cm)	Degree (deg.)	Remark
1	11243.590	40.11	4.92	45.03	74.00	-28.97	100	285	peak
2	15548.077	40.56	2.75	43.31	74.00	-30.69	100	274	peak
N/A									

Operation Mode:	TX / IEEE 802.11n HT20 mode /CH High	Test Date:	2016-4-12
Temperature:	25°C	Tested by:	Lily.Wang
Humidity:	55% RH	Polarity:	Ver. / Hor.

Horizontal

No.	Frequency (MHz)	Reading (dBuV)	Correct Factor(dB/m)	Result (dBuV/m)	Limit (dBuV/m)	Margin (dB)	Height (cm)	Degree (deg.)	Remark
1	10508.013	40.58	5.94	46.52	74.00	-27.48	100	175	peak
2	15384.615	39.70	3.76	43.46	74.00	-30.54	100	272	peak
N/A									

Vertical

No.	Frequency (MHz)	Reading (dBuV)	Correct Factor(dB/m)	Result (dBuV/m)	Limit (dBuV/m)	Margin (dB)	Height (cm)	Degree (deg.)	Remark
1	10889.423	39.36	5.62	44.98	74.00	-29.02	100	105	peak
2	15439.103	39.19	3.42	42.61	74.00	-31.39	100	182	peak
N/A									

5470~5725MHz

Operation Mode:	TX / IEEE 802.11n HT20 mode /CH Low	Test Date:	2016-4-12
Temperature:	25°C	Tested by:	Lily.Wang
Humidity:	55% RH	Polarity:	Ver. / Hor.

Horizontal

No.	Frequency (MHz)	Reading (dBuV)	Correct Factor(dB/m)	Result (dBuV/m)	Limit (dBuV/m)	Margin (dB)	Height (cm)	Degree (deg.)	Remark
1	11461.539	39.46	4.37	43.83	74.00	-30.17	100	10	peak
2	14649.039	42.10	6.23	48.33	74.00	-25.67	100	242	peak
N/A									

Vertical

No.	Frequency (MHz)	Reading (dBuV)	Correct Factor(dB/m)	Result (dBuV/m)	Limit (dBuV/m)	Margin (dB)	Height (cm)	Degree (deg.)	Remark
1	10998.397	40.24	5.53	45.77	74.00	-28.23	100	247	peak
2	13232.372	41.67	9.04	50.71	74.00	-23.29	100	84	peak
N/A									

Operation Mode:	TX / IEEE 802.11n HT20 mode /CH Mid	Test Date:	2016-4-12
Temperature:	25°C	Tested by:	Lily.Wang
Humidity:	55% RH	Polarity:	Ver. / Hor.

Horizontal

No.	Frequency (MHz)	Reading (dBuV)	Correct Factor(dB/m)	Result (dBuV/m)	Limit (dBuV/m)	Margin (dB)	Height (cm)	Degree (deg.)	Remark
1	11951.923	40.90	3.14	44.04	74.00	-29.96	100	111	peak
2	13232.372	41.31	9.04	50.35	74.00	-23.65	100	301	peak
N/A									

Vertical

No.	Frequency (MHz)	Reading (dBuV)	Correct Factor(dB/m)	Result (dBuV/m)	Limit (dBuV/m)	Margin (dB)	Height (cm)	Degree (deg.)	Remark
1	10916.667	40.24	5.60	45.84	74.00	-28.16	100	247	peak
2	16637.821	37.82	4.80	42.62	74.00	-31.38	100	242	peak
N/A									

Operation Mode:	TX / IEEE 802.11n HT20 mode /CH High	Test Date:	2016-4-12
Temperature:	25°C	Tested by:	Lily.Wang
Humidity:	55% RH	Polarity:	Ver. / Hor.

Horizontal

No.	Frequency (MHz)	Reading (dBuV)	Correct Factor(dB/m)	Result (dBuV/m)	Limit (dBuV/m)	Margin (dB)	Height (cm)	Degree (deg.)	Remark
1	12006.410	40.47	3.06	43.53	74.00	-30.47	100	316	peak
2	15357.372	39.16	3.93	43.09	74.00	-30.91	100	343	peak
N/A									

Vertical

No.	Frequency (MHz)	Reading (dBuV)	Correct Factor(dB/m)	Result (dBuV/m)	Limit (dBuV/m)	Margin (dB)	Height (cm)	Degree (deg.)	Remark
1	11897.436	39.82	3.28	43.10	74.00	-30.90	100	84	peak
2	15384.615	39.76	3.76	43.52	74.00	-30.48	100	255	peak
N/A									

5150~5250MHz

Operation Mode:	TX / IEEE 802.11n HT40 mode /CH Low	Test Date:	2016-4-12
Temperature:	25°C	Tested by:	Lily.Wang
Humidity:	55% RH	Polarity:	Ver. / Hor.

Horizontal

No.	Frequency (MHz)	Reading (dBuV)	Correct Factor(dB/m)	Result (dBuV/m)	Limit (dBuV/m)	Margin (dB)	Height (cm)	Degree (deg.)	Remark
1	10017.628	40.53	6.35	46.88	74.00	-27.12	100	16	peak
2	15030.449	39.99	5.95	45.94	74.00	-28.06	100	140	peak
N/A									

Vertical

No.	Frequency (MHz)	Reading (dBuV)	Correct Factor(dB/m)	Result (dBuV/m)	Limit (dBuV/m)	Margin (dB)	Height (cm)	Degree (deg.)	Remark
1	10290.064	40.88	6.12	47.00	74.00	-27.00	100	351	peak
2	15248.397	40.88	4.60	45.48	74.00	-28.52	100	118	peak
N/A									

Operation Mode:	TX / IEEE 802.11n HT40 mode /CH High	Test Date:	2016-4-12
Temperature:	25°C	Tested by:	Lily.Wang
Humidity:	55% RH	Polarity:	Ver. / Hor.

Horizontal

No.	Frequency (MHz)	Reading (dBuV)	Correct Factor(dB/m)	Result (dBuV/m)	Limit (dBuV/m)	Margin (dB)	Height (cm)	Degree (deg.)	Remark
1	10644.231	40.65	5.83	46.48	74.00	-27.52	100	0	peak
2	15357.372	39.10	3.93	43.03	74.00	-30.97	100	144	peak
N/A									

Vertical

No.	Frequency (MHz)	Reading (dBuV)	Correct Factor(dB/m)	Result (dBuV/m)	Limit (dBuV/m)	Margin (dB)	Height (cm)	Degree (deg.)	Remark
1	10862.180	39.14	5.64	44.78	74.00	-29.22	100	359	peak
2	15384.615	39.93	3.76	43.69	74.00	-30.31	100	359	peak
N/A									

5250~5350MHz

Operation Mode:	TX / IEEE 802.11n HT40 mode /CH Low	Test Date:	2016-4-12
Temperature:	25°C	Tested by:	Lily.Wang
Humidity:	55% RH	Polarity:	Ver. / Hor.

Horizontal

No.	Frequency (MHz)	Reading (dBuV)	Correct Factor(dB/m)	Result (dBuV/m)	Limit (dBuV/m)	Margin (dB)	Height (cm)	Degree (deg.)	Remark
1	12605.769	39.87	7.15	47.02	74.00	-26.98	100	147	peak
2	14921.474	39.75	6.16	45.91	74.00	-28.09	100	79	peak
N/A									

Vertical

No.	Frequency (MHz)	Reading (dBuV)	Correct Factor(dB/m)	Result (dBuV/m)	Limit (dBuV/m)	Margin (dB)	Height (cm)	Degree (deg.)	Remark
1	11243.590	41.09	4.92	46.01	74.00	-27.99	100	327	peak
2	16883.013	37.89	6.66	44.55	74.00	-29.45	100	334	peak
N/A									

Operation Mode:	TX / IEEE 802.11n HT40 mode /CH High	Test Date:	2016-4-12
Temperature:	25°C	Tested by:	Lily.Wang
Humidity:	55% RH	Polarity:	Ver. / Hor.

Horizontal

No.	Frequency (MHz)	Reading (dBuV)	Correct Factor(dB/m)	Result (dBuV/m)	Limit (dBuV/m)	Margin (dB)	Height (cm)	Degree (deg.)	Remark
1	10834.936	39.98	5.67	45.65	74.00	-28.35	100	273	peak
2	15520.833	38.82	2.92	41.74	74.00	-32.26	100	134	peak
N/A									

Vertical

No.	Frequency (MHz)	Reading (dBuV)	Correct Factor(dB/m)	Result (dBuV/m)	Limit (dBuV/m)	Margin (dB)	Height (cm)	Degree (deg.)	Remark
1	11080.128	39.94	5.33	45.27	74.00	-28.73	100	5	peak
2	15520.833	39.93	2.92	42.85	74.00	-31.15	100	204	peak
N/A									

5470~5725MHz

Operation Mode:	TX / IEEE 802.11n HT40 mode /CH Low	Test Date:	2016-4-12
Temperature:	25°C	Tested by:	Lily.Wang
Humidity:	55% RH	Polarity:	Ver. / Hor.

Horizontal

No.	Frequency (MHz)	Reading (dBuV)	Correct Factor(dB/m)	Result (dBuV/m)	Limit (dBuV/m)	Margin (dB)	Height (cm)	Degree (deg.)	Remark
1	12741.987	41.03	8.07	49.10	74.00	-24.90	100	324	peak
2	17536.859	37.62	12.53	50.15	74.00	-23.85	100	152	peak
N/A									

Vertical

No.	Frequency (MHz)	Reading (dBuV)	Correct Factor(dB/m)	Result (dBuV/m)	Limit (dBuV/m)	Margin (dB)	Height (cm)	Degree (deg.)	Remark
1	10562.500	42.29	5.89	48.18	74.00	-25.82	100	310	peak
2	17291.667	38.00	10.26	48.26	74.00	-25.74	100	360	peak
N/A									

Operation Mode:	TX / IEEE 802.11n HT40 mode /CH Mid	Test Date:	2016-4-12
Temperature:	25°C	Tested by:	Lily.Wang
Humidity:	55% RH	Polarity:	Ver. / Hor.

Horizontal

No.	Frequency (MHz)	Reading (dBuV)	Correct Factor(dB/m)	Result (dBuV/m)	Limit (dBuV/m)	Margin (dB)	Height (cm)	Degree (deg.)	Remark
1	11107.372	39.52	4.29	43.81	74.00	-30.19	100	13	peak
2	15330.128	36.97	3.66	40.63	74.00	-33.37	100	21	peak
N/A	N/A								

Vertical

No.	Frequency (MHz)	Reading (dBuV)	Correct Factor(dB/m)	Result (dBuV/m)	Limit (dBuV/m)	Margin (dB)	Height (cm)	Degree (deg.)	Remark
1	11325.320	39.13	4.00	43.13	74.00	-30.87	100	119	peak
2	15520.833	37.66	2.75	40.41	74.00	-33.59	100	67	peak
3	N/A								

Operation Mode:	TX / IEEE 802.11n HT40 mode /CH High	Test Date:	2016-4-12
Temperature:	25°C	Tested by:	Lily.Wang
Humidity:	55% RH	Polarity:	Ver. / Hor.

Horizontal

No.	Frequency (MHz)	Reading (dBuV)	Correct Factor(dB/m)	Result (dBuV/m)	Limit (dBuV/m)	Margin (dB)	Height (cm)	Degree (deg.)	Remark
1	12442.308	39.23	6.03	45.26	74.00	-28.74	100	18	peak
2	15411.859	39.50	3.59	43.09	74.00	-30.91	100	0	peak
N/A									

Vertical

No.	Frequency (MHz)	Reading (dBuV)	Correct Factor(dB/m)	Result (dBuV/m)	Limit (dBuV/m)	Margin (dB)	Height (cm)	Degree (deg.)	Remark
1	11706.731	39.72	3.76	43.48	74.00	-30.52	100	23	peak
2	16283.654	37.87	2.11	39.98	74.00	-34.02	100	209	peak
N/A									

5150~5250MHz

Operation Mode:	TX / IEEE 802.11ac VHT20 mode /CH Low	Test Date:	2016-4-12
Temperature:	25°C	Tested by:	Lily.Wang
Humidity:	55% RH	Polarity:	Ver. / Hor.

Horizontal

No.	Frequency (MHz)	Reading (dBuV)	Correct Factor(dB/m)	Result (dBuV/m)	Limit (dBuV/m)	Margin (dB)	Height (cm)	Degree (deg.)	Remark
1	10044.872	40.38	6.32	46.70	74.00	-27.30	100	169	peak
2	15112.180	38.90	5.45	44.35	74.00	-29.65	100	21	peak
N/A									

Vertical

No.	Frequency (MHz)	Reading (dBuV)	Correct Factor(dB/m)	Result (dBuV/m)	Limit (dBuV/m)	Margin (dB)	Height (cm)	Degree (deg.)	Remark
1	10262.820	40.36	6.14	46.50	74.00	-27.50	100	285	peak
2	15275.641	40.26	4.43	44.69	74.00	-29.31	100	241	peak
N/A									

Operation Mode:	TX / IEEE 802.11ac VHT20 mode /CH Mid	Test Date:	2016-4-12
Temperature:	25°C	Tested by:	Lily.Wang
Humidity:	55% RH	Polarity:	Ver. / Hor.

Horizontal

No.	Frequency (MHz)	Reading (dBuV)	Correct Factor(dB/m)	Result (dBuV/m)	Limit (dBuV/m)	Margin (dB)	Height (cm)	Degree (deg.)	Remark
1	10480.769	40.75	5.96	46.71	74.00	-27.29	100	222	peak
2	15139.423	39.79	5.28	45.07	74.00	-28.93	100	23	peak
N/A									

Vertical

No.	Frequency (MHz)	Reading (dBuV)	Correct Factor(dB/m)	Result (dBuV/m)	Limit (dBuV/m)	Margin (dB)	Height (cm)	Degree (deg.)	Remark
1	10698.718	40.04	5.78	45.82	74.00	-28.18	100	14	peak
2	15275.641	39.92	4.43	44.35	74.00	-29.65	100	117	peak
N/A									

Operation Mode:	TX / IEEE 802.11ac VHT20 mode /CH High	Test Date:	2016-4-12
Temperature:	25°C	Tested by:	Lily.Wang
Humidity:	55% RH	Polarity:	Ver. / Hor.

Horizontal

No.	Frequency (MHz)	Reading (dBuV)	Correct Factor(dB/m)	Result (dBuV/m)	Limit (dBuV/m)	Margin (dB)	Height (cm)	Degree (deg.)	Remark
1	10644.231	40.55	5.83	46.38	74.00	-27.62	100	236	peak
2	15520.833	39.39	2.92	42.31	74.00	-31.69	100	164	peak
N/A									

Vertical

No.	Frequency (MHz)	Reading (dBuV)	Correct Factor(dB/m)	Result (dBuV/m)	Limit (dBuV/m)	Margin (dB)	Height (cm)	Degree (deg.)	Remark
1	10698.718	40.16	5.78	45.94	74.00	-28.06	100	358	peak
2	15439.103	38.92	3.42	42.34	74.00	-31.66	100	275	peak
N/A									

5250~5350MHz

Operation Mode:	TX / IEEE 802.11ac VHT20 mode /CH Low	Test Date:	2016-4-12
Temperature:	25°C	Tested by:	Lily.Wang
Humidity:	55% RH	Polarity:	Ver. / Hor.

Horizontal

No.	Frequency (MHz)	Reading (dBuV)	Correct Factor(dB/m)	Result (dBuV/m)	Limit (dBuV/m)	Margin (dB)	Height (cm)	Degree (deg.)	Remark
1	10126.603	41.14	6.25	47.39	74.00	-26.61	100	129	peak
2	14703.526	39.22	6.22	45.44	74.00	-28.56	100	359	peak
N/A									

Vertical

No.	Frequency (MHz)	Reading (dBuV)	Correct Factor(dB/m)	Result (dBuV/m)	Limit (dBuV/m)	Margin (dB)	Height (cm)	Degree (deg.)	Remark
1	13096.154	40.45	9.50	49.95	74.00	-24.05	100	32	peak
2	17019.231	37.35	7.73	45.08	74.00	-28.92	100	206	peak
N/A									

Operation Mode:	TX / IEEE 802.11ac VHT20 mode /CH Mid	Test Date:	2016-4-12
Temperature:	25°C	Tested by:	Lily.Wang
Humidity:	55% RH	Polarity:	Ver. / Hor.

Horizontal

No.	Frequency (MHz)	Reading (dBuV)	Correct Factor(dB/m)	Result (dBuV/m)	Limit (dBuV/m)	Margin (dB)	Height (cm)	Degree (deg.)	Remark
1	11161.859	40.73	5.12	45.85	74.00	-28.15	100	91	peak
2	15548.077	39.54	2.75	42.29	74.00	-31.71	100	258	peak
N/A									

Vertical

No.	Frequency (MHz)	Reading (dBuV)	Correct Factor(dB/m)	Result (dBuV/m)	Limit (dBuV/m)	Margin (dB)	Height (cm)	Degree (deg.)	Remark
1	10780.449	40.13	5.71	45.84	74.00	-28.16	100	322	peak
2	15575.320	37.96	2.58	40.54	74.00	-33.46	100	297	peak
N/A									

Operation Mode:	TX / IEEE 802.11ac VHT20 mode /CH High	Test Date:	2016-4-12
Temperature:	25°C	Tested by:	Lily.Wang
Humidity:	55% RH	Polarity:	Ver. / Hor.

Horizontal

No.	Frequency (MHz)	Reading (dBuV)	Correct Factor(dB/m)	Result (dBuV/m)	Limit (dBuV/m)	Margin (dB)	Height (cm)	Degree (deg.)	Remark
1	10943.910	40.44	5.58	46.02	74.00	-27.98	100	51	peak
2	15766.026	39.34	1.40	40.74	74.00	-33.26	100	28	peak
N/A									

Vertical

No.	Frequency (MHz)	Reading (dBuV)	Correct Factor(dB/m)	Result (dBuV/m)	Limit (dBuV/m)	Margin (dB)	Height (cm)	Degree (deg.)	Remark
1	11161.859	39.63	5.12	44.75	74.00	-29.25	100	256	peak
2	15520.833	39.15	2.92	42.07	74.00	-31.93	100	149	peak
N/A									

5470~5725MHz

Operation Mode:	TX / IEEE 802.11ac VHT20 mode /CH Low	Test Date:	2016-4-12
Temperature:	25°C	Tested by:	Lily.Wang
Humidity:	55% RH	Polarity:	Ver. / Hor.

Horizontal

No.	Frequency (MHz)	Reading (dBuV)	Correct Factor(dB/m)	Result (dBuV/m)	Limit (dBuV/m)	Margin (dB)	Height (cm)	Degree (deg.)	Remark
1	12741.987	39.97	8.07	48.04	74.00	-25.96	100	324	peak
2	16828.526	36.81	6.25	43.06	74.00	-30.94	100	13	peak
N/A									

Vertical

No.	Frequency (MHz)	Reading (dBuV)	Correct Factor(dB/m)	Result (dBuV/m)	Limit (dBuV/m)	Margin (dB)	Height (cm)	Degree (deg.)	Remark
1	12687.500	40.40	7.70	48.10	74.00	-25.90	100	248	peak
2	14812.500	38.52	6.19	44.71	74.00	-29.29	100	359	peak
N/A									

Operation Mode:	TX / IEEE 802.11ac VHT20 mode /CH Mid	Test Date:	2016-4-12
Temperature:	25°C	Tested by:	Lily.Wang
Humidity:	55% RH	Polarity:	Ver. / Hor.

Horizontal

No.	Frequency (MHz)	Reading (dBuV)	Correct Factor(dB/m)	Result (dBuV/m)	Limit (dBuV/m)	Margin (dB)	Height (cm)	Degree (deg.)	Remark
1	12442.308	39.92	6.03	45.95	74.00	-28.05	100	59	peak
2	16201.923	39.25	1.48	40.73	74.00	-33.27	100	353	peak
N/A									

Vertical

No.	Frequency (MHz)	Reading (dBuV)	Correct Factor(dB/m)	Result (dBuV/m)	Limit (dBuV/m)	Margin (dB)	Height (cm)	Degree (deg.)	Remark
1	12387.820	38.80	5.66	44.46	74.00	-29.54	100	136	peak
2	15766.026	37.52	1.40	38.92	74.00	-35.08	100	97	peak
N/A									

Operation Mode:	TX / IEEE 802.11ac VHT20 mode /CH High	Test Date:	2016-4-12
Temperature:	25°C	Tested by:	Lily.Wang
Humidity:	55% RH	Polarity:	Ver. / Hor.

Horizontal

No.	Frequency (MHz)	Reading (dBuV)	Correct Factor(dB/m)	Result (dBuV/m)	Limit (dBuV/m)	Margin (dB)	Height (cm)	Degree (deg.)	Remark
1	12469.551	39.08	6.22	45.30	74.00	-28.70	100	8	peak
2	15439.103	39.42	3.42	42.84	74.00	-31.16	100	189	peak
N/A									

Vertical

No.	Frequency (MHz)	Reading (dBuV)	Correct Factor(dB/m)	Result (dBuV/m)	Limit (dBuV/m)	Margin (dB)	Height (cm)	Degree (deg.)	Remark
1	12605.769	39.43	7.15	46.58	74.00	-27.42	100	303	peak
2	15766.026	37.29	1.40	38.69	74.00	-35.31	100	41	peak
N/A									

5150~5250MHz

Operation Mode:	TX / IEEE 802.11ac VHT40 mode /CH Low	Test Date:	2016-4-12
Temperature:	25°C	Tested by:	Lily.Wang
Humidity:	55% RH	Polarity:	Ver. / Hor.

Horizontal

No.	Frequency (MHz)	Reading (dBuV)	Correct Factor(dB/m)	Result (dBuV/m)	Limit (dBuV/m)	Margin (dB)	Height (cm)	Degree (deg.)	Remark
1	10480.769	40.64	5.96	46.60	74.00	-27.40	100	233	peak
2	15193.910	39.57	4.94	44.51	74.00	-29.49	100	196	peak
N/A									

Vertical

No.	Frequency (MHz)	Reading (dBuV)	Correct Factor(dB/m)	Result (dBuV/m)	Limit (dBuV/m)	Margin (dB)	Height (cm)	Degree (deg.)	Remark
1	10290.064	40.79	6.12	46.91	74.00	-27.09	100	258	peak
2	15357.372	40.00	3.93	43.93	74.00	-30.07	100	87	peak
N/A									

Operation Mode:	TX / IEEE 802.11ac VHT40 mode /CH High	Test Date:	2016-4-12
Temperature:	25°C	Tested by:	Lily.Wang
Humidity:	55% RH	Polarity:	Ver. / Hor.

Horizontal

No.	Frequency (MHz)	Reading (dBuV)	Correct Factor(dB/m)	Result (dBuV/m)	Limit (dBuV/m)	Margin (dB)	Height (cm)	Degree (deg.)	Remark
1	10344.551	40.50	6.07	46.57	74.00	-27.43	100	243	peak
2	15302.885	39.69	4.27	43.96	74.00	-30.04	100	252	peak
N/A									

Vertical

No.	Frequency (MHz)	Reading (dBuV)	Correct Factor(dB/m)	Result (dBuV/m)	Limit (dBuV/m)	Margin (dB)	Height (cm)	Degree (deg.)	Remark
1	10535.256	39.81	5.92	45.73	74.00	-28.27	100	179	peak
2	15275.641	40.75	4.43	45.18	74.00	-28.82	100	143	peak
N/A									

5250~5350MHz

Operation Mode:	TX / IEEE 802.11ac VHT40 mode /CH Low	Test Date:	2016-4-12
Temperature:	25°C	Tested by:	Lily.Wang
Humidity:	55% RH	Polarity:	Ver. / Hor.

Horizontal

No.	Frequency (MHz)	Reading (dBuV)	Correct Factor(dB/m)	Result (dBuV/m)	Limit (dBuV/m)	Margin (dB)	Height (cm)	Degree (deg.)	Remark
1	10807.692	40.94	5.69	46.63	74.00	-27.37	100	191	peak
2	14894.231	38.49	6.17	44.66	74.00	-29.34	100	154	peak
N/A									

Vertical

No.	Frequency (MHz)	Reading (dBuV)	Correct Factor(dB/m)	Result (dBuV/m)	Limit (dBuV/m)	Margin (dB)	Height (cm)	Degree (deg.)	Remark
1	11107.372	41.27	5.26	46.53	74.00	-27.47	100	297	peak
2	15411.859	39.03	3.59	42.62	74.00	-31.38	100	0	peak
N/A									

Operation Mode:	TX / IEEE 802.11ac VHT40 mode /CH High	Test Date:	2016-4-12
Temperature:	25°C	Tested by:	Lily.Wang
Humidity:	55% RH	Polarity:	Ver. / Hor.

Horizontal

No.	Frequency (MHz)	Reading (dBuV)	Correct Factor(dB/m)	Result (dBuV/m)	Limit (dBuV/m)	Margin (dB)	Height (cm)	Degree (deg.)	Remark
1	11052.885	40.80	5.40	46.20	74.00	-27.80	100	133	peak
2	15439.103	38.86	3.42	42.28	74.00	-31.72	100	181	peak
N/A									

Vertical

No.	Frequency (MHz)	Reading (dBuV)	Correct Factor(dB/m)	Result (dBuV/m)	Limit (dBuV/m)	Margin (dB)	Height (cm)	Degree (deg.)	Remark
1	11270.833	40.86	4.85	45.71	74.00	-28.29	100	280	peak
2	15520.833	38.94	2.92	41.86	74.00	-32.14	100	144	peak
N/A									

5470~5725MHz

Operation Mode:	TX / IEEE 802.11ac VHT40 mode /CH Low	Test Date:	2016-4-12
Temperature:	25°C	Tested by:	Lily.Wang
Humidity:	55% RH	Polarity:	Ver. / Hor.

Horizontal

No.	Frequency (MHz)	Reading (dBuV)	Correct Factor(dB/m)	Result (dBuV/m)	Limit (dBuV/m)	Margin (dB)	Height (cm)	Degree (deg.)	Remark
1	11815.705	39.11	3.48	42.59	74.00	-31.41	100	50	peak
2	15493.590	37.52	3.08	40.60	74.00	-33.40	100	287	peak
N/A									

Vertical

No.	Frequency (MHz)	Reading (dBuV)	Correct Factor(dB/m)	Result (dBuV/m)	Limit (dBuV/m)	Margin (dB)	Height (cm)	Degree (deg.)	Remark
1	11134.615	39.33	5.19	44.52	74.00	-29.48	100	44	peak
2	15629.808	35.12	2.24	37.36	74.00	-36.64	100	276	peak
N/A									

Operation Mode:	TX / IEEE 802.11ac VHT40 mode /CH Mid	Test Date:	2016-4-12
Temperature:	25°C	Tested by:	Lily.Wang
Humidity:	55% RH	Polarity:	Ver. / Hor.

Horizontal

No.	Frequency (MHz)	Reading (dBuV)	Correct Factor(dB/m)	Result (dBuV/m)	Limit (dBuV/m)	Margin (dB)	Height (cm)	Degree (deg.)	Remark
1	11325.320	39.87	4.00	43.87	74.00	-30.13	100	28	peak
2	15520.833	37.83	2.75	40.58	74.00	-33.42	100	265	peak
N/A	N/A								

Vertical

No.	Frequency (MHz)	Reading (dBuV)	Correct Factor(dB/m)	Result (dBuV/m)	Limit (dBuV/m)	Margin (dB)	Height (cm)	Degree (deg.)	Remark
1	11407.051	38.62	3.90	42.52	74.00	-31.48	100	259	peak
2	15466.346	36.76	3.01	39.77	74.00	-34.23	100	95	peak
N/A	N/A								

Operation Mode:	TX / IEEE 802.11ac VHT40 mode /CH High	Test Date:	2016-4-12
Temperature:	25°C	Tested by:	Lily.Wang
Humidity:	55% RH	Polarity:	Ver. / Hor.

Horizontal

No.	Frequency (MHz)	Reading (dBuV)	Correct Factor(dB/m)	Result (dBuV/m)	Limit (dBuV/m)	Margin (dB)	Height (cm)	Degree (deg.)	Remark
1	12469.551	39.15	6.22	45.37	74.00	-28.63	100	313	peak
2	15330.128	39.52	4.10	43.62	74.00	-30.38	100	296	peak
N/A									

Vertical

No.	Frequency (MHz)	Reading (dBuV)	Correct Factor(dB/m)	Result (dBuV/m)	Limit (dBuV/m)	Margin (dB)	Height (cm)	Degree (deg.)	Remark
1	12442.308	39.22	6.03	45.25	74.00	-28.75	100	245	peak
2	15384.615	38.50	3.76	42.26	74.00	-31.74	100	172	peak
N/A									

5150~5250MHz

Operation Mode:	TX / IEEE 802.11ac VHT80 mode /CH Mid	Test Date:	2016-4-12
Temperature:	25°C	Tested by:	Lily.Wang
Humidity:	55% RH	Polarity:	Ver. / Hor.

Horizontal

No.	Frequency (MHz)	Reading (dBuV)	Correct Factor(dB/m)	Result (dBuV/m)	Limit (dBuV/m)	Margin (dB)	Height (cm)	Degree (deg.)	Remark
1	10099.359	40.61	6.28	46.89	74.00	-27.11	100	207	peak
2	15248.397	40.90	4.60	45.50	74.00	-28.50	100	256	peak
N/A									

Vertical

No.	Frequency (MHz)	Reading (dBuV)	Correct Factor(dB/m)	Result (dBuV/m)	Limit (dBuV/m)	Margin (dB)	Height (cm)	Degree (deg.)	Remark
1	10290.064	40.21	6.12	46.33	74.00	-27.67	100	2	peak
2	15221.154	39.64	4.77	44.41	74.00	-29.59	100	198	peak
N/A									

5250~5350MHz

Operation Mode:	TX / IEEE 802.11ac VHT80 mode /CH Mid	Test Date:	2016-4-12
Temperature:	25°C	Tested by:	Lily.Wang
Humidity:	55% RH	Polarity:	Ver. / Hor.

Horizontal

No.	Frequency (MHz)	Reading (dBuV)	Correct Factor(dB/m)	Result (dBuV/m)	Limit (dBuV/m)	Margin (dB)	Height (cm)	Degree (deg.)	Remark
1	11134.615	39.75	5.19	44.94	74.00	-29.06	100	72	peak
2	15275.641	40.30	4.43	44.73	74.00	-29.27	100	295	peak
N/A									

Vertical

No.	Frequency (MHz)	Reading (dBuV)	Correct Factor(dB/m)	Result (dBuV/m)	Limit (dBuV/m)	Margin (dB)	Height (cm)	Degree (deg.)	Remark
1	11270.833	39.69	4.85	44.54	74.00	-29.46	100	5	peak
2	15302.885	40.23	4.27	44.50	74.00	-29.50	100	9	peak
N/A									

5470~5725MHz

Operation Mode:	TX / IEEE 802.11ac VHT80 mode /CH Mid	Test Date:	2016-4-12
Temperature:	25°C	Tested by:	Lily.Wang
Humidity:	55% RH	Polarity:	Ver. / Hor.

Horizontal

No.	Frequency (MHz)	Reading (dBuV)	Correct Factor(dB/m)	Result (dBuV/m)	Limit (dBuV/m)	Margin (dB)	Height (cm)	Degree (deg.)	Remark
1	12469.551	39.32	6.22	45.54	74.00	-28.46	100	144	peak
2	16256.410	38.17	1.90	40.07	74.00	-33.93	100	331	peak
N/A									

Vertical

No.	Frequency (MHz)	Reading (dBuV)	Correct Factor(dB/m)	Result (dBuV/m)	Limit (dBuV/m)	Margin (dB)	Height (cm)	Degree (deg.)	Remark
1	12605.769	39.74	7.15	46.89	74.00	-27.11	100	349	peak
2	16256.410	37.94	1.90	39.84	74.00	-34.16	100	338	peak
N/A									

7.7 POWERLINE CONDUCTED EMISSIONS

LIMIT

According to §15.207(a), except as shown in paragraphs (b) and (c) of this section, for an intentional radiator that is designed to be connected to the public utility (AC) power line, the radio frequency voltage that is conducted back onto the AC power line on any frequency or frequencies within the band 150 kHz to 30 MHz shall not exceed the limits in the following table, as measured using a 50 μ H/50 ohms line impedance stabilization network (LISN). Compliance with the provisions of this paragraph shall be based on the measurement of the radio frequency voltage between each power line and ground at the power terminal. The lower limit applies at the boundary between the frequency ranges.

Frequency Range (MHz)	Limits (dB μ V)	
	Quasi-peak	Average
0.15 to 0.50	66 to 56*	56 to 46*
0.50 to 5	56	46
5 to 30	60	50

* Decreases with the logarithm of the frequency.

TEST CONFIGURATION

See test photographs attached in Appendix 1 for the actual connections between EUT and support equipment.

TEST PROCEDURE

1. The EUT was placed on a table, which is 0.8m above ground plane.
2. Maximum procedure was performed on the six highest emissions to ensure EUT compliance.
3. Repeat above procedures until all frequency measured were complete.

TEST RESULTS

The initial step in collecting conducted data is a spectrum analyzer peak scan of the measurement range. Significant peaks are then marked as shown on the following data page, and these signals are then quasi-peaked.

Test Data

Job No.:	C151118R01	Date:	2016-4-29
Model No.:	NP2000	Time:	AM 09:17:53
Standard:	FCC Class B	Temp.(C)/Hum.(%):	22(C)/48%
Test item:	Conduction test	Test By:	Lily.Wang
Line:	L1	Test Voltage:	AC 120V/60Hz
Model:		Description:	

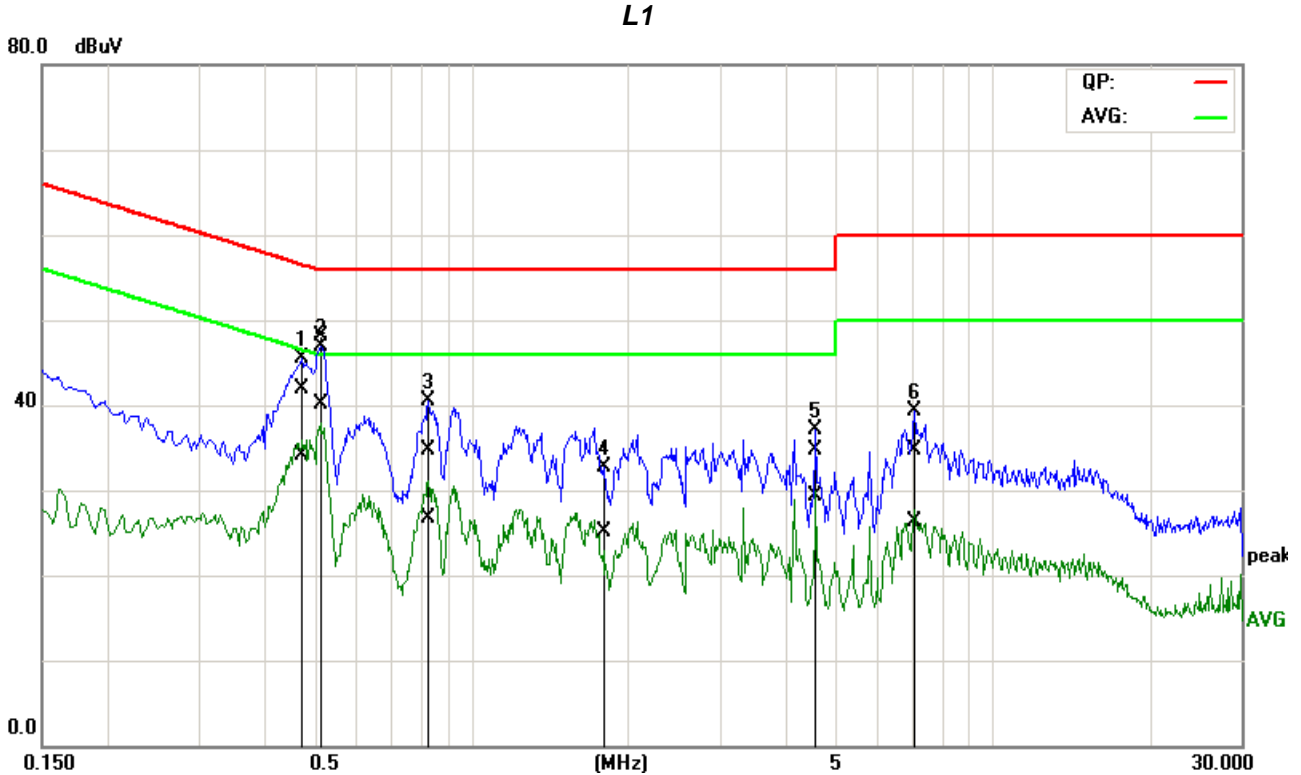

No.	Frequency (MHz)	QuasiPeak reading (dBuV)	Average reading (dBuV)	Correction factor (dB)	QuasiPeak result (dBuV)	Average result (dBuV)	QuasiPeak limit (dBuV)	Average limit (dBuV)	QuasiPeak margin (dB)	Average margin (dB)	Remark
1	0.4716	22.03	14.24	19.81	41.84	34.05	56.49	46.49	-14.65	-12.44	Pass
2*	0.5112	28.33	20.33	19.81	48.14	40.14	56.00	46.00	-7.86	-5.86	Pass
3	0.8183	14.85	6.84	19.80	34.65	26.64	56.00	46.00	-21.35	-19.36	Pass
4	1.7989	12.84	5.25	19.83	32.67	25.08	56.00	46.00	-23.33	-20.92	Pass
5	4.5777	14.79	9.46	19.92	34.71	29.38	56.00	46.00	-21.29	-16.62	Pass
6	7.0742	14.81	6.34	19.92	34.73	26.26	60.00	50.00	-25.27	-23.74	Pass

Note: 1. L1 = Line One (Live Line) / L2 = Line Two (Neutral Line).

Job No.:	C151118R01	Date:	2016-4-29
Model No.:	NP2000	Time:	AM 09:22:45
Standard:	FCC Class B	Temp.(C)/Hum.(%):	22(C)/48%
Test item:	Conduction test	Test By:	Lily.Wang
Line:	L2	Test Voltage:	AC 120V/60Hz
Model:		Description:	

L2

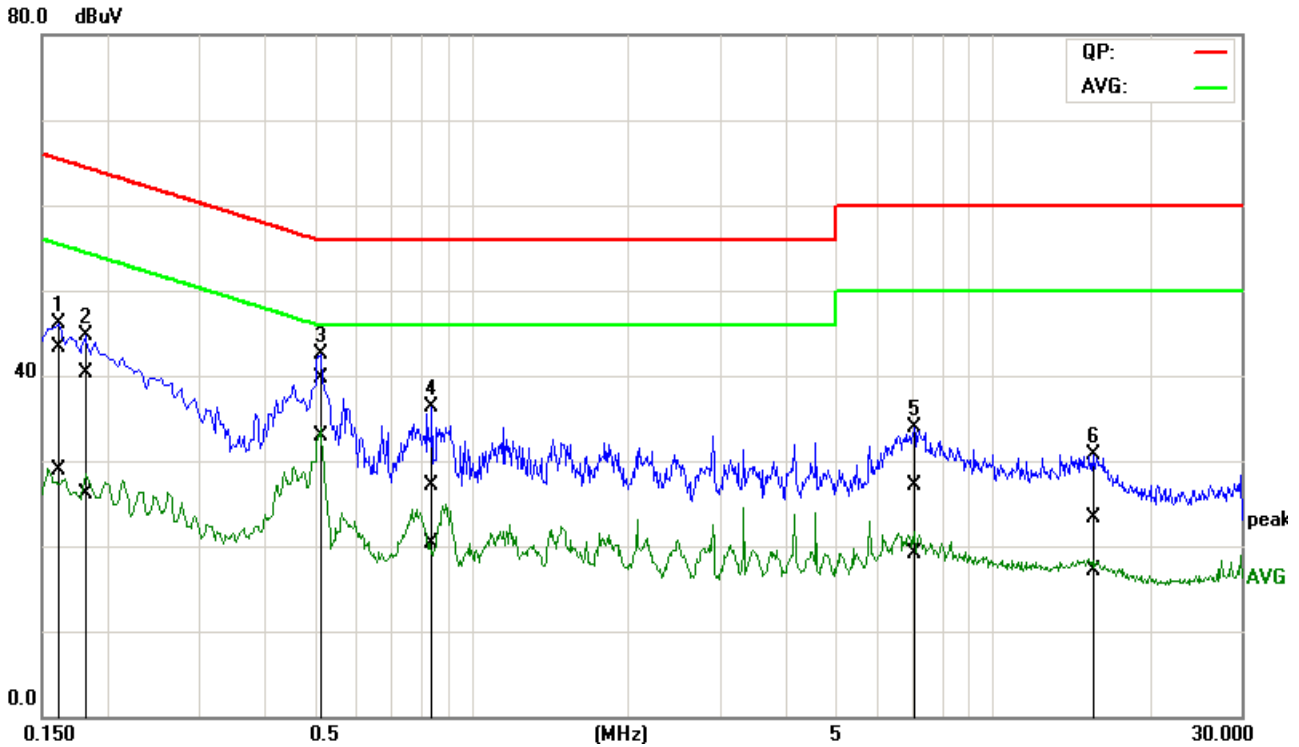

No.	Frequency (MHz)	QuasiPeak reading (dBuV)	Average reading (dBuV)	Correction factor (dB)	QuasiPeak result (dBuV)	Average result (dBuV)	QuasiPeak limit (dBuV)	Average limit (dBuV)	QuasiPeak margin (dB)	Average margin (dB)	Remark
1	0.1598	23.55	9.13	19.74	43.29	28.87	65.47	55.47	-22.18	-26.60	Pass
2	0.1810	20.60	6.28	19.74	40.34	26.02	64.43	54.44	-24.09	-28.42	Pass
3*	0.5148	19.98	13.16	19.75	39.73	32.91	56.00	46.00	-16.27	-13.09	Pass
4	0.8329	7.41	0.52	19.74	27.15	20.26	56.00	46.00	-28.85	-25.74	Pass
5	7.0894	7.15	-0.82	19.89	27.04	19.07	60.00	50.00	-32.96	-30.93	Pass
6	15.5751	2.89	-3.20	20.33	23.22	17.13	60.00	50.00	-36.78	-32.87	Pass

Note: 1. L1 = Line One (Live Line) / L2 = Line Two (Neutral Line).

Job No.:	C151118R01	Date:	2016-4-29
Model No.:	NP2000	Time:	AM 09:28:21
Standard:	FCC Class B	Temp.(C)/Hum.(%):	22(C)/48%
Test item:	Conduction test	Test By:	Lily.Wang
Line:	L1	Test Voltage:	AC 240V/60Hz
Model:		Description:	

L1

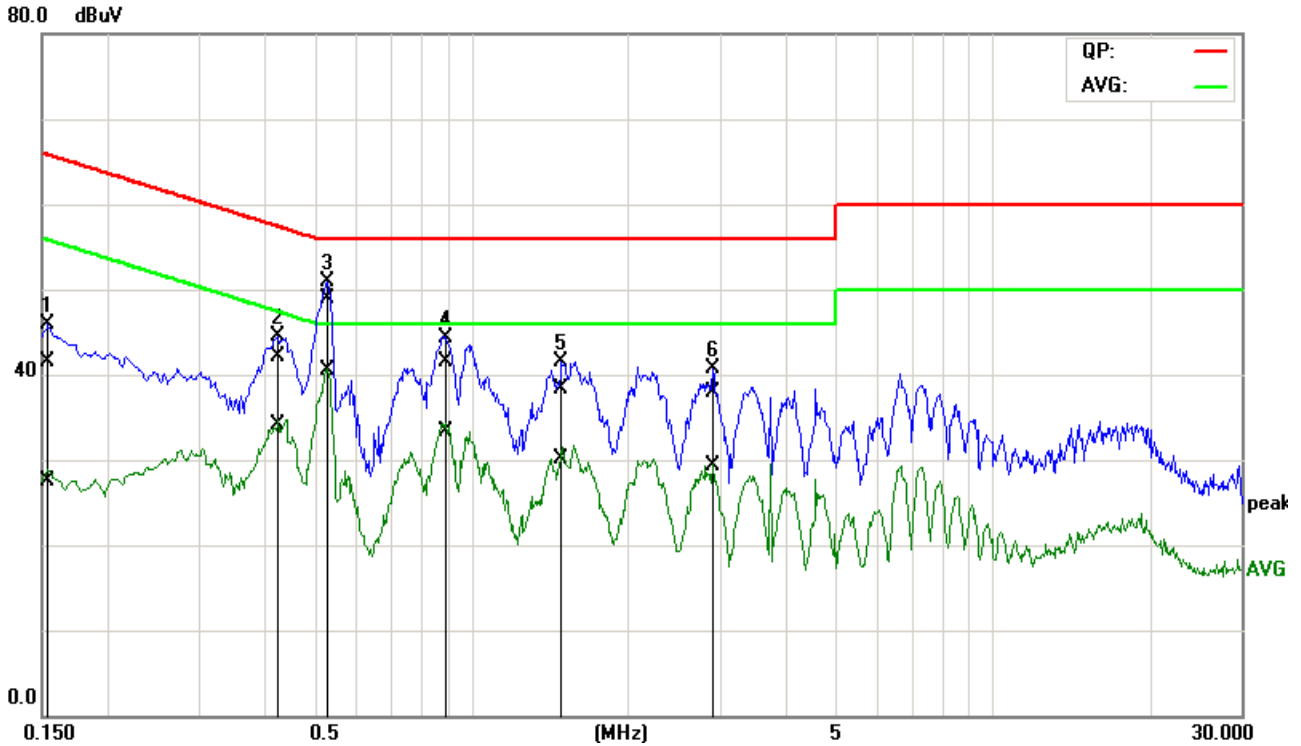

No.	Frequency (MHz)	QuasiPeak reading (dBuV)	Average reading (dBuV)	Correction factor (dB)	QuasiPeak result (dBuV)	Average result (dBuV)	QuasiPeak limit (dBuV)	Average limit (dBuV)	QuasiPeak margin (dB)	Average margin (dB)	Remark
1	0.1522	21.77	7.65	19.79	41.56	27.44	65.87	55.88	-24.31	-28.44	Pass
2	0.4271	22.26	14.37	19.81	42.07	34.18	57.31	47.31	-15.24	-13.13	Pass
3*	0.5276	29.15	20.64	19.81	48.96	40.45	56.00	46.00	-7.04	-5.55	Pass
4	0.8989	21.78	13.49	19.79	41.57	33.28	56.00	46.00	-14.43	-12.72	Pass
5	1.4976	18.43	10.29	19.81	38.24	30.10	56.00	46.00	-17.76	-15.90	Pass
6	2.9113	18.09	9.32	19.89	37.98	29.21	56.00	46.00	-18.02	-16.79	Pass

Note: 1. L1 = Line One (Live Line) / L2 = Line Two (Neutral Line).

Job No.:	C151118R01	Date:	2016-4-29
Model No.:	NP2000	Time:	AM 09:33:33
Standard:	FCC Class B	Temp.(C)/Hum.(%):	22(C)/48%
Test item:	Conduction test	Test By:	Lily.Wang
Line:	L2	Test Voltage:	AC 240V/60Hz
Model:		Description:	

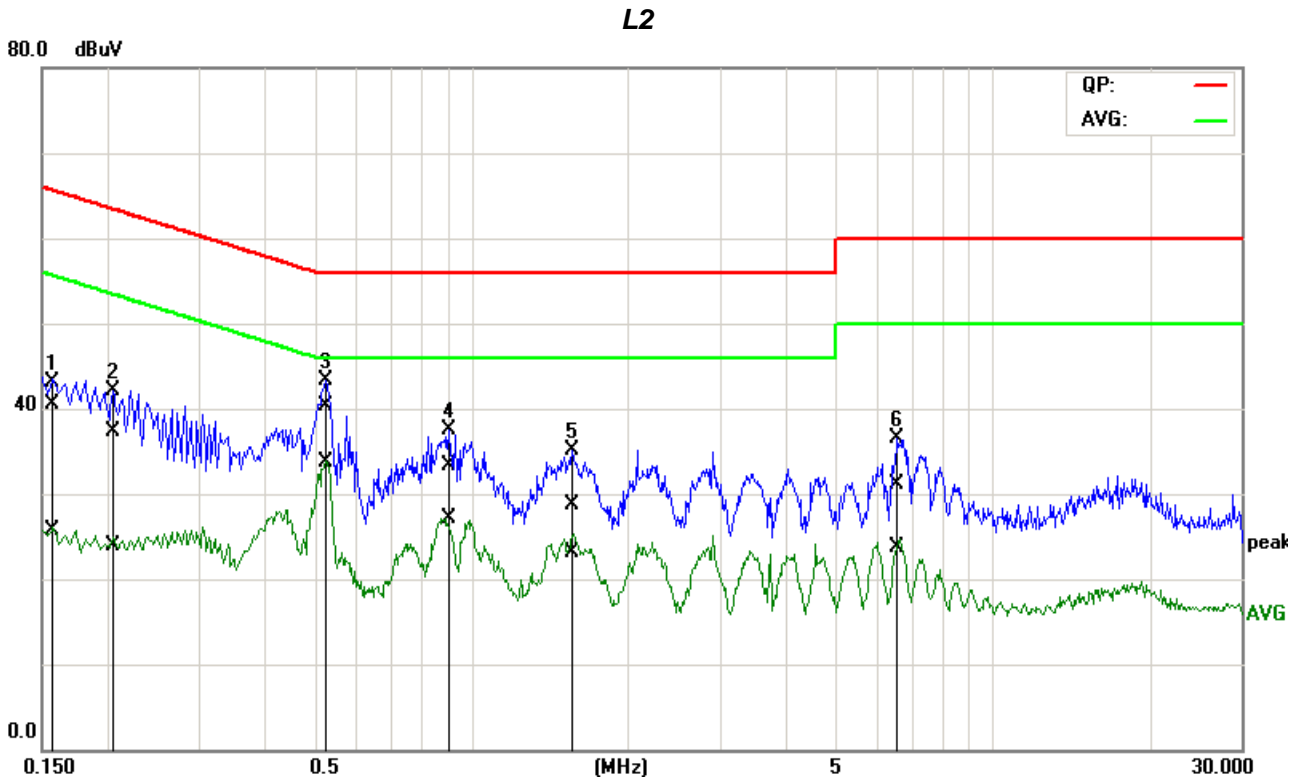

No.	Frequency (MHz)	QuasiPeak reading (dBuV)	Average reading (dBuV)	Correction factor (dB)	QuasiPeak result (dBuV)	Average result (dBuV)	QuasiPeak limit (dBuV)	Average limit (dBuV)	QuasiPeak margin (dB)	Average margin (dB)	Remark
1	0.1544	20.77	6.00	19.74	40.51	25.74	65.75	55.76	-25.24	-30.02	Pass
2	0.2034	17.47	4.10	19.74	37.21	23.84	63.47	53.47	-26.26	-29.63	Pass
3*	0.5226	20.60	13.97	19.75	40.35	33.72	56.00	46.00	-15.65	-12.28	Pass
4	0.8916	13.54	7.34	19.74	33.28	27.08	56.00	46.00	-22.72	-18.92	Pass
5	1.5386	8.93	3.42	19.75	28.68	23.17	56.00	46.00	-27.32	-22.83	Pass
6	6.5813	11.28	3.82	19.87	31.15	23.69	60.00	50.00	-28.85	-26.31	Pass

Note: 1. L1 = Line One (Live Line) / L2 = Line Two (Neutral Line).

END OF REPORT