



June 5, 2003

FEDERAL COMMUNICATIONS COMMISSION

7435 Oakland Mills Road
Columbia, MD 21046
USA



31040/SIT



C-1376



46390-2049



200093-0



00-034



Subject: Type Acceptance Application under FCC CFR 47, Parts 2 and 90 (Subpart I) - Non-Broadcast Radio Services in the Frequency Band 928 - 941 MHz (Paging Services).

**Applicant: KAVAL WIRELESS TECHNOLOGIES INC.
Product: RF Fiber Interface Module
Model: US900P
FCC ID: H6M-US900P**

Dear Sir/Madam,

As appointed agent for **KAVAL WIRELESS TECHNOLOGIES INC.**, we would like to submit the application to the Federal Communications Commission for certification of the above product. Please review all necessary files uploaded to FCC OET site for detailed information.

If you have any queries, please do not hesitate to contact us by our TOLL FREE numbers:

OUR TELEPHONE NO.: 1-877-765-4173

Yours truly,

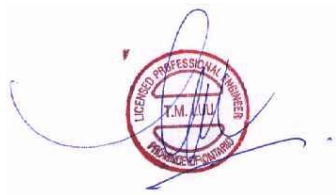

Tri Minh Luu, P. Eng.,
V.P., Engineering

TML/DH

Encl.

3000 Bristol Circle,
Oakville, Ontario,
Canada L6H 6G4

Tel.: (905) 829-1570
Fax.: (905) 829-8050

Website: www.ultratech-labs.com
Email: vic@ultratech-labs.com



31040/SIT



C-1376



46390-2049



200093-0



00-034



entela

3000 Bristol Circle,
Oakville, Ontario,
Canada L6H 6G4

Tel.: (905) 829-1570
Fax.: (905) 829-8050

Website: www.ultratech-labs.com
Email: vic@ultratech-labs.com

June 5, 2003

KAVAL WIRELESS TECHNOLOGIES INC.

60 Gough Road
Markham, Ontario
Canada, L3R 8X7

Attn.: Mr. Alan Aslett

Subject: Type Acceptance Application under FCC CFR 47, Parts 2 and 90 (Subpart I) - Non-Broadcast Radio Services in the Frequency Band 928 - 941 MHz (Paging Services).

Product: RF Fiber Interface Module
Model: US900P
FCC ID: H6M-US900P

Dear Mr. Aslett,

The product sample has been tested in accordance with **FCC CFR 47, Parts 2 and 90 (Subpart I) - Non-Broadcast Radio Services in the Frequency Band 928 - 941 MHz (Paging Base Station Band)**, and the results and observation were recorded in the engineering report, Our File No.: KTI-026FCC90

Enclosed you will find copy of the engineering report. If you have any queries, please do not hesitate to contact us.

Yours truly,

Tri Minh Luu, P.Eng
Vice President - Engineering

Encl.

ENGINEERING TEST REPORT

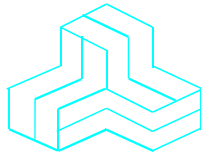

RF Fiber Interface Module Model No.: US900P FCC ID: H6M-US900P

Applicant: KAVAL WIRELESS TECHNOLOGIES INC.
60 Gough Road
Markham, Ontario
Canada, L3R 8X7

Tested in Accordance With

**Federal Communications Commission (FCC)
PAGING RADIO SERVICES
CFR 47, Parts 2 and 90 (Subpart I)
928 - 941 MHz Band**

UltraTech's File No.: KTI-026FCC90

This Test report is Issued under the Authority of
Tri M. Luu, Professional Engineer,
Vice President of Engineering
UltraTech Group of Labs

Date: June 5, 2003



Report Prepared by: Tri M. Luu

Tested by: Mr. Hung Trinh, EMI/RFI Technician

Issued Date: June 5, 2003

Test Dates: May 16 - May 21, 2003

- *The results in this Test Report apply only to the sample(s) tested, and the sample tested is randomly selected.*
- *This report must not be used by the client to claim product endorsement by NVLAP or any agency of the US Government.*

UltraTech

3000 Bristol Circle, Oakville, Ontario, Canada, L6H 6G4
Tel.: (905) 829-1570 Fax.: (905) 829-8050
Website: www.ultratech-labs.com Email: vic@ultratech-labs.com Email: tri@ultratech-labs.com



31040/SIT



C-1376



46390-2049



200093-0



00-034



TABLE OF CONTENTS

EXHIBIT 1.	SUBMITTAL CHECK LIST.....	1
EXHIBIT 2.	INTRODUCTION	2
2.1.	SCOPE.....	2
2.2.	NORMATIVE REFERENCES	2
EXHIBIT 3.	PERFORMANCE ASSESSMENT.....	3
3.1.	CLIENT INFORMATION	3
3.2.	EQUIPMENT UNDER TEST (EUT) INFORMATION.....	4
3.3.	EUT'S TECHNICAL SPECIFICATIONS.....	5
3.4.	LIST OF EUT'S PORTS	6
3.4.1.	<i>US900P Remote RF Module.....</i>	<i>6</i>
3.5.	MODIFICATIONS INCORPORATED IN THE EUT FOR COMPLIANCE PURPOSES.....	6
3.6.	ANCILLARY EQUIPMENT	6
3.7.	DRAWING OF TEST SETUP	7
EXHIBIT 4.	EUT OPERATING CONDITIONS AND CONFIGURATIONS DURING TESTS.....	8
4.1.	CLIMATE TEST CONDITIONS	8
4.2.	OPERATIONAL TEST CONDITIONS & ARRANGEMENT FOR TEST SIGNALS.....	8
EXHIBIT 5.	SUMMARY OF TEST RESULTS	9
5.1.	LOCATION OF TESTS	9
5.2.	APPLICABILITY & SUMMARY OF EMC EMISSION TEST RESULTS	9
EXHIBIT 6.	MEASUREMENTS, EXAMINATIONS & TEST DATA FOR EMC EMISSIONS	10
6.1.	TEST PROCEDURES	10
6.2.	MEASUREMENT UNCERTAINTIES	10
6.3.	MEASUREMENT EQUIPMENT USED:.....	10
6.4.	ESSENTIAL/PRIMARY FUNCTIONS AS DECLARED BY THE MANUFACTURER:	10
6.5.	RF POWER OUTPUT @ FCC 2.1046 & 90.205	11
6.5.1.	<i>Limits @ FCC 90.205.....</i>	<i>11</i>
6.5.2.	<i>Method of Measurements.....</i>	<i>11</i>
6.5.3.	<i>Test Equipment List</i>	<i>11</i>
6.5.4.	<i>Test Arrangement.....</i>	<i>11</i>
6.5.5.	<i>Test Data.....</i>	<i>12</i>
6.6.	RF EXPOSURE REQUIRMENTS @ 1.1310 & 2.1091	23
6.6.1.	<i>Limits</i>	<i>23</i>
6.6.2.	<i>Method of Measurements.....</i>	<i>23</i>
6.6.3.	<i>Test Data.....</i>	<i>24</i>
6.7.	EMISSION MASK @ FCC 2.1049, 90.208 & 90.210	25
6.7.1.	<i>Limits @ FCC 90.209 & 90.210.....</i>	<i>25</i>
6.7.2.	<i>Method of Measurements.....</i>	<i>25</i>
6.7.3.	<i>Test Equipment List</i>	<i>25</i>
6.7.4.	<i>Test Arrangement.....</i>	<i>25</i>
6.7.5.	<i>Test Data.....</i>	<i>26</i>
6.8.	TRANSMITTER ANTENNA POWER SPURIOUS/HARMONIC CONDUCTED EMISSIONS @ FCC 90.210	44

6.8.1.	<i>Limits @ 90.210</i>	44
6.8.2.	<i>Method of Measurements</i>	44
6.8.3.	<i>Test Equipment List</i>	44
6.8.4.	<i>Test Arrangement</i>	44
6.8.5.	<i>Test Data</i>	45
6.9.	TRANSMITTER SPURIOUS/HARMONIC RADIATED EMISSIONS @ FCC 90.210.....	66
6.9.1.	<i>Limits @ 90.210</i>	66
6.9.2.	<i>Method of Measurements</i>	66
6.9.3.	<i>Test Equipment List</i>	66
6.9.4.	<i>Photographs of Test Setup</i>	66
6.9.5.	<i>Test Data</i>	67
EXHIBIT 7.	MEASUREMENT UNCERTAINTY	68
7.1.	RADIATED EMISSION MEASUREMENT UNCERTAINTY.....	68
EXHIBIT 8.	MEASUREMENT METHODS	69
8.1.	CONDUCTED POWER MEASUREMENTS.....	69
8.2.	RADIATED POWER MEASUREMENTS (ERP & EIRP) USING SUBSTITUTION METHOD.....	70
8.2.1.	<i>Maximizing RF Emission Level (E-Field)</i>	70
8.2.2.	<i>Measuring the EIRP of Spurious/Harmonic Emissions using Substitution Method</i>	71
8.3.	SPURIOUS EMISSIONS (CONDUCTED).....	73
8.4.	EMISSION MASK.....	73

EXHIBIT 1. SUBMITTAL CHECK LIST

Annex No.	Exhibit Type	Description of Contents	Quality Check (OK)
1 through 8	Test Report	<ul style="list-style-type: none"> Exhibit 1: Submittal check lists Exhibit 2: Introduction Exhibit 3: Performance Assessment Exhibit 4: EUT Operation and Configuration during Tests Exhibit 5: Summary of test Results Exhibit 6: Measurement Data Exhibit 7: Measurement Uncertainty Exhibit 8: Measurement Methods 	OK
1	Test Setup Photos	Photos # 1 to 4	OK
2	External Photos of EUT	Photos # 1 to 4	OK
3	Internal Photos of EUT	Photos of 1 to 19	OK
4	Cover Letters	<ul style="list-style-type: none"> Letter from Ultratech for Certification Request Letter from the Applicant to appoint Ultratech to act as an agent Letter from the Applicant to request for Confidentiality Filing 	OK
5	Attestation Statements	<ul style="list-style-type: none"> N/A 	N/A
6	ID Label/Location Info	<ul style="list-style-type: none"> ID Label Location of ID Label 	OK
7	Block Diagrams	<ul style="list-style-type: none"> Block diagrams 1 of 1 	OK
8	Schematic Diagrams	<ul style="list-style-type: none"> Schematic diagrams 3 of 3 	OK
9	Parts List/Tune Up Info	Parts List/Tune Up Info	N/A Component values have shown on the schematics
10	Operational Description	Operational Description	OK
11	RF Exposure Info	RF Exposure Info	OK
12	Users Manual	Users Manual	OK

ULTRATECH GROUP OF LABS

3000 Bristol Circle, Oakville, Ontario, Canada L6H 6G4
 Tel. #: 905-829-1570, Fax. #: 905-829-8050, Email: vic@ultratech-labs.com, Website: <http://www.ultratech-labs.com>

File #: KTI-026FCC90
 June 5, 2003

- All test results contained in this engineering test report are traceable to National Institute of Standards and Technology (NIST)

EXHIBIT 2. INTRODUCTION

2.1. SCOPE

Reference:	FCC Parts 2 and 90 (Subpart I): 2002
Title	Telecommunication - Code of Federal Regulations, CFR 47, Parts 2 & 90
Purpose of Test:	To gain FCC Certification Authorization for Radio operating in the frequency band 928 - 941 MHz (Paging Services).
Test Procedures	Both conducted and radiated emissions measurements were conducted in accordance with American National Standards Institute ANSI C63.4 - American National Standard for Methods of Measurement of Radio-Noise Emissions from Low-Voltage Electrical and Electronic Equipment in the Range of 9 kHz to 40 GHz.

2.2. NORMATIVE REFERENCES

Publication	Year	Title
FCC CFR Parts 2 & 90	2002	Code of Federal Regulations – Telecommunication
ANSI C63.4	1992	American National Standard for Methods of Measurement of Radio-Noise Emissions from Low-Voltage Electrical and Electronic Equipment in the Range of 9 kHz to 40 GHz
CISPR 22 & EN 55022	1997 1998	Limits and Methods of Measurements of Radio Disturbance Characteristics of Information Technology Equipment
CISPR 16-1		Specification for Radio Disturbance and Immunity measuring apparatus and methods

ULTRATECH GROUP OF LABS

3000 Bristol Circle, Oakville, Ontario, Canada L6H 6G4
 Tel. #: 905-829-1570, Fax. #: 905-829-8050, Email: vic@ultratech-labs.com, Website: <http://www.ultratech-labs.com>

File #: KTI-026FCC90
 June 5, 2003

- All test results contained in this engineering test report are traceable to National Institute of Standards and Technology (NIST)

EXHIBIT 3. PERFORMANCE ASSESSMENT

3.1. CLIENT INFORMATION

APPLICANT	
Name:	KAVAL WIRELESS TECHNOLOGIES INC.
Address:	60 Gough Road Markham, Ontario Canada, L3R 8X7
Contact Person:	Mr. Alan Aslett Phone #: 905-946-3397 Fax #: 905-946-3392 Email Address: asslet@kaval.com

MANUFACTURER	
Name:	KAVAL WIRELESS TECHNOLOGIES INC.
Address:	60 Gough Road Markham, Ontario Canada, L3R 8X7
Contact Person:	Mr. Alan Aslett Phone #: 905-946-3397 Fax #: 905-946-3392 Email Address: asslet@kaval.com

ULTRATECH GROUP OF LABS

3000 Bristol Circle, Oakville, Ontario, Canada L6H 6G4
Tel. #: 905-829-1570, Fax. #: 905-829-8050, Email: vic@ultratech-labs.com, Website: <http://www.ultratech-labs.com>

File #: **KT1-026FCC90**
June 5, 2003

- *All test results contained in this engineering test report are traceable to National Institute of Standards and Technology (NIST)*

3.2. EQUIPMENT UNDER TEST (EUT) INFORMATION

The following information (with the exception of the Date of Receipt) has been supplied by the applicant.

Brand Name:	KAVAL WIRELESS TECHNOLOGIES INC.
Product Name:	RF Fiber Interface Module
Model Name or Number:	US900P
Trade Name	LinkNet UniServ Unit (USU)
Serial Number:	Pre-porduction
Type of Equipment:	Paging Radio Services
External Power Supply:	Kaval Model UDS-PS01 External AC./DC power supply
Transmitting/Receiving Antenna Type:	Non-integral
Equipment Type:	Base station (fixed use)
Intended Operating Environment:	Commercial, light industry & heavy industry

Description of EUT and Theory of Operation:

The LinkNet UniServ Unit (USU) System is a USU RF to Fiber Modules which provides a single-band link from a Head-End Distribution center to multiple local antennae. RF Signals are distributed over a pair of Single-Mode Fiber-Optic Distribution Lines. The Remote Module Fiber Optic I/O's are band specific, but the Head-End Fiber-Optic I/O's are not. The Head-End I/O's may be used for any band

The LinkNet UniServ Unit (USU) System consists of the following:

- (1) Kaval Remote RF Module, Model US900P, 800 MHz Paging Services (896 – 902 MHz and 928 - 941 MHz)
- (2) Kaval Power Supply, Model US-PS01, AC IN: 120V 60Hz , DC Out: 28 V
- (3) Kaval Head End RF Module, Model LNKFIB-03 or LNKFIB-H04

Model LNKFIB-03: This is a 1U high, 19” Rack-mount providing low signal level interface between Head-End RF Modules and 8 Paris of Single-Mode Fiber-Optic Distribution Lines. The 8 Fiber-Optic Pairs are in 2 groups of four, with the RF connections combined inside the Module in those groupings.

Model LNKFIB-04: This is a 1U high, 19” Rack-mount providing low signal level interface between Head-End RF Modules and 8 Paris of Single-Mode Fiber-Optic Distribution Lines. The 4 Fiber-Optic Pairs are combined inside the Module.

**** Note: Since Model LNKFIB-03 and LNKFIB-04 are family units, the Model LNKFIB-03 is used for testing for worst case.

3.3. EUT'S TECHNICAL SPECIFICATIONS

UPLINK BAND (896-902 MHz)	
Note: The uplink band 896-902 MHz is not intended for rf communication through air. Therefore, tests applied to this band are not applicable.	
Operating Frequency Range:	896 - 902 MHz
16KRF Input/Output Impedance:	50 Ohms
RF Input Power Rating:	-40 dBm maximum for single and multiple channels
Duty Cycle:	100%
Modulation Type:	Suitable for UNMODULATED, TDMA, GSM, F8E & F8D
Antenna Connector Type:	N/A. Not intended for connection to the transmit/receive antenna
Antenna Description:	N/A. Not intended for connection to the transmit/receive antenna

UPLINK BAND (928 - 941 MHz)	
Operating Frequency Range:	928 - 941 MHz, 25 kHz Channel Spacing
RF Input/Output Impedance:	50 Ohms
RF Input Power Rating:	<ul style="list-style-type: none"> • 1 Channel input: -7.2 dBm maximum • 2 Channel inputs: -6.0 dBm maximum • 3 Channel inputs: -8.7 dBm
RF Output Power Rating:	<ul style="list-style-type: none"> • 1 Channel output: +17 dBm maximum • 2 Channel outputs: +18 dBm maximum • 3 Channel outputs: +15 dBm maximum <p style="text-align: center;">See Users Manual for more power ratings of multiple channel input/output</p>
Duty Cycle:	100%
Occupied Bandwidth (99%):	15.7 kHz (F8E) 17.9 kHz (F8D)
Emission Designation*:	16K0F8E 19K0F8D
Antenna Connector Type:	SMA
Antenna Description:	¼ Wave Dipole Antenna, Gain: 0 dBi

ULTRATECH GROUP OF LABS

3000 Bristol Circle, Oakville, Ontario, Canada L6H 6G4
 Tel. #: 905-829-1570, Fax. #: 905-829-8050, Email: vic@ultratech-labs.com, Website: <http://www.ultratech-labs.com>

File #: **KTI-026FCC90**
 June 5, 2003

▪ All test results contained in this engineering test report are traceable to National Institute of Standards and Technology (NIST)

3.4. LIST OF EUT'S PORTS

3.4.1. US900P Remote RF Module

Port Number	EUT's Port Description	Number of Identical Ports	Connector Type	Cable Type (Shielded/Non-shielded)
1	28 Vdc Ports	2	2C -Terminal	Shielded
2	RF Input/Output Port	1	SMA	Shielded
3	RSS-232 # 1 Port	1	DB9	Shielded
4	RSS-232 # 2 Port	1	DB9	Shielded
5	User I/O Port	1	DB15	Shielded
6	Photodiode & Laser	1	2C - Terminal	Shielded

3.5. MODIFICATIONS INCORPORATED IN THE EUT FOR COMPLIANCE PURPOSES

None

3.6. ANCILLARY EQUIPMENT

None

3.7. DRAWING OF TEST SETUP

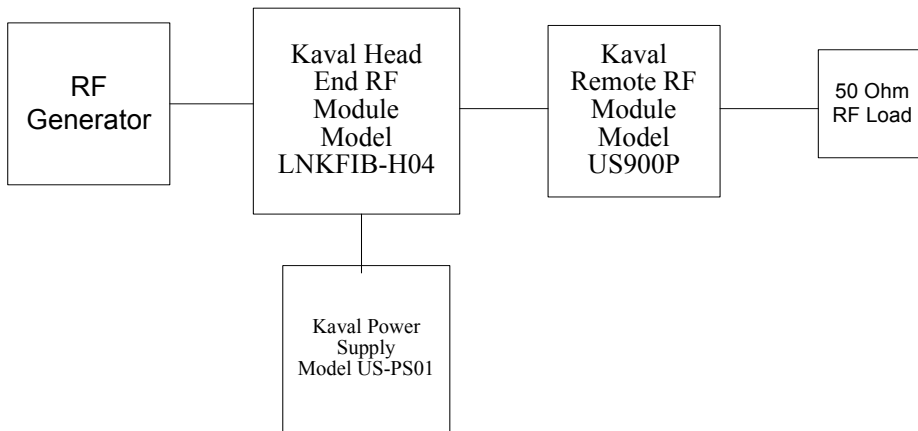

EXHIBIT 4. EUT OPERATING CONDITIONS AND CONFIGURATIONS DURING TESTS

4.1. CLIMATE TEST CONDITIONS

The climate conditions of the test environment are as follows:

Temperature:	21°C
Humidity:	51%
Pressure:	102 kPa
Power input source:	28 Vdc

4.2. OPERATIONAL TEST CONDITIONS & ARRANGEMENT FOR TEST SIGNALS

Operating Modes:	The RF signal was applied to the RX input port at its maximum rated value, the RF output was then measured and compared with RF input signal for compliance purpose.
Special Test Software:	N/A
Special Hardware Used:	N/A
Transmitter Test Antenna:	The EUT is tested with the transmitter antenna port terminated to a 50 Ohms RF Load.

Transmitter Test Signals	
Frequency Band(s):	Near lowest, near middle & near highest frequencies each frequency bands that the transmitter covers:
<ul style="list-style-type: none"> • 928 - 941 MHz 	<ul style="list-style-type: none"> • 928, 934.5 & 941 MHz
Transmitter Wanted Output Test Signals:	
<ul style="list-style-type: none"> ▪ RF Power Output (measured maximum output power): ▪ Normal Test Modulation ▪ Modulating signal source: 	<ul style="list-style-type: none"> ▪ Maximum as rated by manufacturer ▪ All available modulations ▪ External

EXHIBIT 5. SUMMARY OF TEST RESULTS

5.1. LOCATION OF TESTS

All of the measurements described in this report were performed at Ultratech Group of Labs located in the city of Oakville, Province of Ontario, Canada.

- AC Powerline Conducted Emissions were performed in UltraTech's shielded room, 16'(L) by 12'(W) by 12'(H).
- Radiated Emissions were performed at the Ultratech's 3 Meter Open Field Test Site (OFTS) situated in the Town of Oakville, province of Ontario.
- The above sites have been calibrated in accordance with ANSI C63.4, and found to be in compliance with the requirements of Sec. 2.948 of the FCC Rules. The descriptions and site measurement data of the Oakville Open Field Test Site has been filed with FCC office (FCC File No.: 31040/SIT 1300B3) and Industry Canada office (Industry Canada File No.: IC2049). Last Date of Site Calibration: Aug. 10, 2002.

5.2. APPLICABILITY & SUMMARY OF EMC EMISSION TEST RESULTS

FCC PARAGRAPH.	TEST REQUIREMENTS	APPLICABILITY (YES/NO)
90.205 & 2.1046	RF Power Output	Yes
1.1307, 1.1310, 2.1091 & 2.1093	RF Exposure Limit	Yes
90.213 & 2.1055	Frequency Stability	Not applicable for Amplifier/Extender. The RF Output frequency is 100% the same as the RF input signal. There is no frequency translation.
90.242(b)(8) & 2.1047(a)	Audio Frequency Response	Not applicable for Amplifier/Extender
90.210 & 2.1047(b)	Modulation Limiting	Not applicable for Amplifier/Extender
90.210 & 2.1049	Emission Limitation & Emission Mask	Yes
90.210, 2.1057 & 2.1051	Emission Limits - Spurious Emissions at Antenna Terminal	Yes
90.210, 2.1057 & 2.1053	Emission Limits - Field Strength of Spurious Emissions	Yes

RF Fiber Interface Module, Model No.: US900P, by **KAVAL WIRELESS TECHNOLOGIES INC.** has also been tested and found to comply with **FCC Part 15, Subpart B - Radio Receivers and Class A Digital Devices**. The engineering test report has been documented and kept in file and it is available anytime upon FCC request.

ULTRATECH GROUP OF LABS

3000 Bristol Circle, Oakville, Ontario, Canada L6H 6G4
 Tel. #: 905-829-1570, Fax. #: 905-829-8050, Email: vic@ultratech-labs.com, Website: <http://www.ultratech-labs.com>

File #: **KTI-026FCC90**
 June 5, 2003

- All test results contained in this engineering test report are traceable to National Institute of Standards and Technology (NIST)

EXHIBIT 6. MEASUREMENTS, EXAMINATIONS & TEST DATA FOR EMC EMISSIONS

6.1. TEST PROCEDURES

This section contains test results only. Details of test methods and procedures can be found in Exhibit 8 of this report

6.2. MEASUREMENT UNCERTAINTIES

The measurement uncertainties stated were calculated in accordance with requirements of UKAS Document NIS 81 with a confidence level of 95%. Please refer to Exhibit 7 for Measurement Uncertainties.

6.3. MEASUREMENT EQUIPMENT USED:

The measurement equipment used complied with the requirements of the Standards referenced in the Methods & Procedures ANSI C63.4:1992 and CISPR 16-1.

6.4. ESSENTIAL/PRIMARY FUNCTIONS AS DECLARED BY THE MANUFACTURER:

The essential function of the EUT is to correctly communicate data to and from radios over RF link.

6.5. RF POWER OUTPUT @ FCC 2.1046 & 90.205

6.5.1. Limits @ FCC 90.205

Please refer to FCC CFR 47, Part 90, Subpart I, Para. 90.205 for specification details.

6.5.2. Method of Measurements

Please refer to Exhibit 8, § 8.1 (Conducted) for test procedures and test setup.

6.5.3. Test Equipment List

Test Instruments	Manufacturer	Model No.	Serial No.	Frequency Range
Spectrum Analyzer/ EMI Receiver	Hewlett Packard	HP 8593EM	3412A00103	9 kHz – 26.5 GHz
Power Divider	Weinschel	1515	LW400	DC – 18 GHz
3 x RF Signal Generators	Fluke	6061A	...	10 kHz – 1050 MHz

6.5.4. Test Arrangement

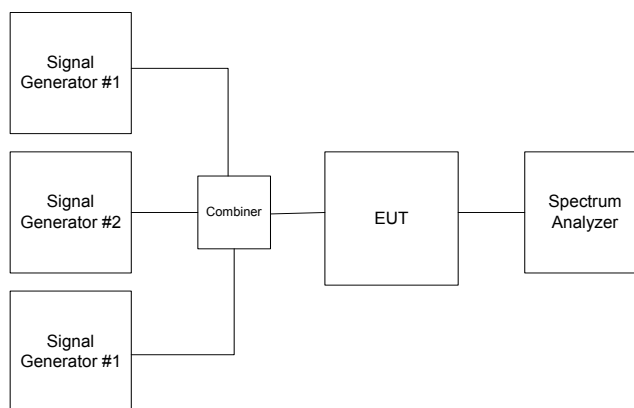

6.5.5. Test Data

6.5.5.1. PEAK RF INPUT & OUTPUT POWERS IN 928 - 941 MHz Band (Downlink)

Frequency (MHz)	Number of In/Out Channels	Modulation	Manufacturer's Maximum RF Input (conducted) (dBm)	Maximum RF Output (conducted) (dBm)	Maximum Antenna Gain allowed (dBi)	Maximum ERP with 0 dBi Gain (dBm)	Manufacturer's Maximum RF Output Rating (conducted) (dBm)
928	1	F8E	-7.2	17.0	0	14.9	17.0
934.5	1	F8E	-10.2	17.0	0	14.9	17.0
941	1	F8E	-8.8	17.0	0	14.9	17.0
928	1	F8D	-7.2	17.0	0	14.9	17.0
934.5	1	F8D	-10.2	17.0	0	14.9	17.0
941	1	F8D	-8.8	17.0	0	14.9	17.0

Note:

- (1) The manufacturer rates its maximum RF Input of whatever that the maximum RF output of 17 dBm can be achieved.

6.5.5.2. INTERMODULATION IN & PEAK ERP POWERS IN 928 - 941 MHz Band (Uplink)

Frequency (MHz)	Number of In/Out Channels	Modulation	Manufacturer's Maximum RF Input (conducted) (dBm)	Maximum RF Output (conducted) (dBm)	Maximum Antenna Gain allowed (dBi)	Maximum EIRP Measured (dBm)	Manufacturer's Maximum RF Output Rating (conducted) (dBm)
928 MHz	1	No modulation	-7.2	17.0	0	17	17
928, 928.0125	2	No modulation	-6.0	18.0	0	18	18
928, 928.0125, 928.0250	3	No modulation	-8.7	15.0	0	15	15
934.5	1	No modulation	-10.2	17.0	0	17	17
934.5, 934.5125	2	No modulation	-8.8	18.0	0	18	18
934.5, 934.5125, 934.5250	3	No modulation	-11.7	15.0	0	15	15
941	1	No modulation	-8.8	17.0	0	17	17
941, 940.9875	2	No modulation	-7.3	18.0	0	18	18
941, 940.9875, 940..9750	3	No modulation	-10.4	15.0	0	15	15

Note:

- (1) The multiple channel RF power ratings are measured whenever the IM component levels reaches -13 dBm or multiple RF input power reaches the manufacturer's maximum rating as specified on Page 3 of the Users Manual whichever is first achieved..
- (2) Refer to Plots # 1 to 9 for detailed measurements of I.M.

Plot #1: Intermodulation with 1 RF Input in 928 – 941 MHz
RF Input: -7.16 dBm, Fc: 928 MHz

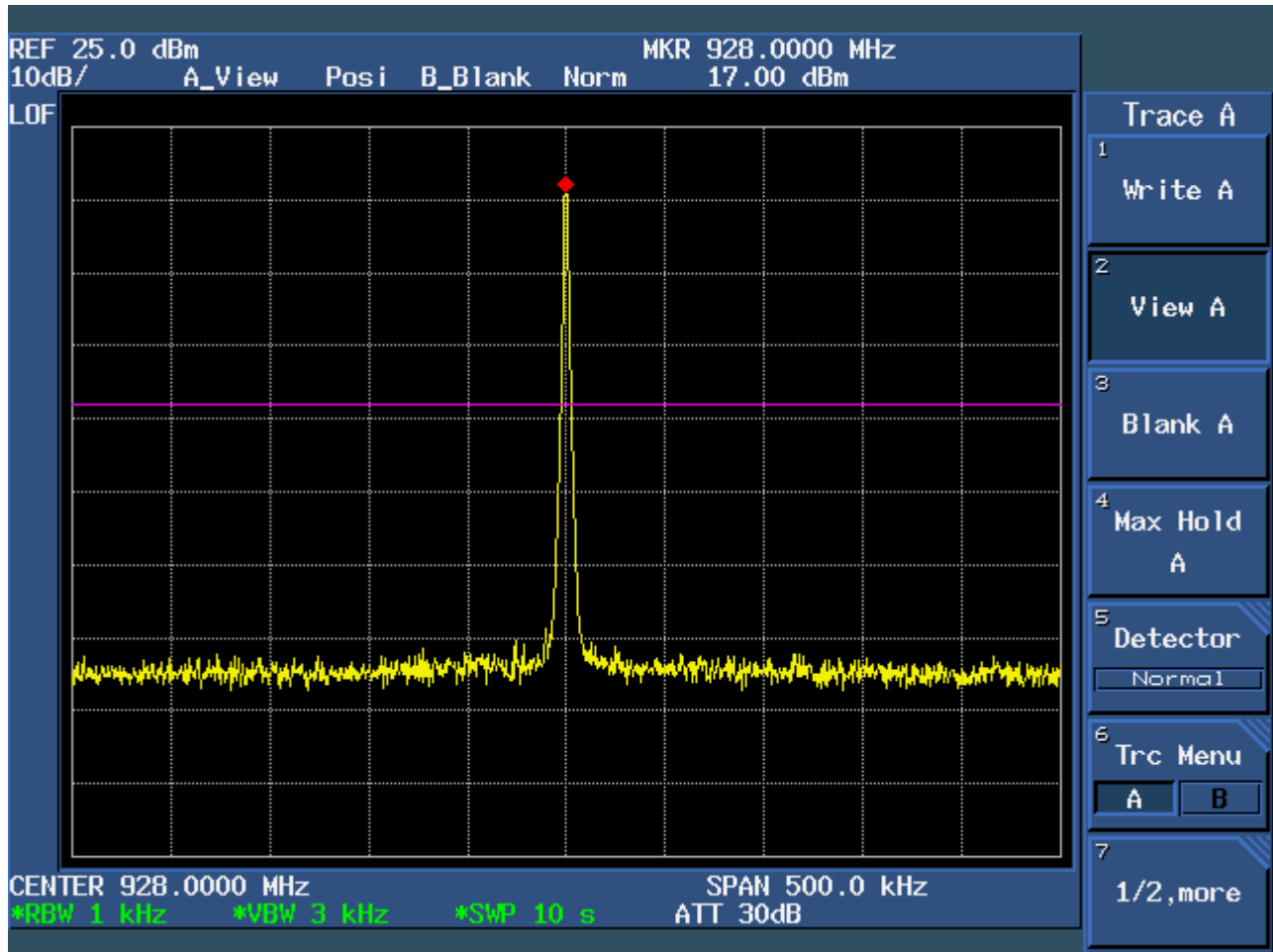

ULTRATECH GROUP OF LABS

3000 Bristol Circle, Oakville, Ontario, Canada L6H 6G4
Tel. #: 905-829-1570, Fax. #: 905-829-8050, Email: vic@ultratech-labs.com, Website: <http://www.ultratech-labs.com>

File #: KT1-026FCC90

June 5, 2003

- All test results contained in this engineering test report are traceable to National Institute of Standards and Technology (NIST)

Plot #2: Intermodulation with 2 RF Input in 928 – 941 MHz
RF Input: (1) –6.04 dBm, (2) –6.49 dBm
Fc: 928 MHz & Fc + 12.5 kHz

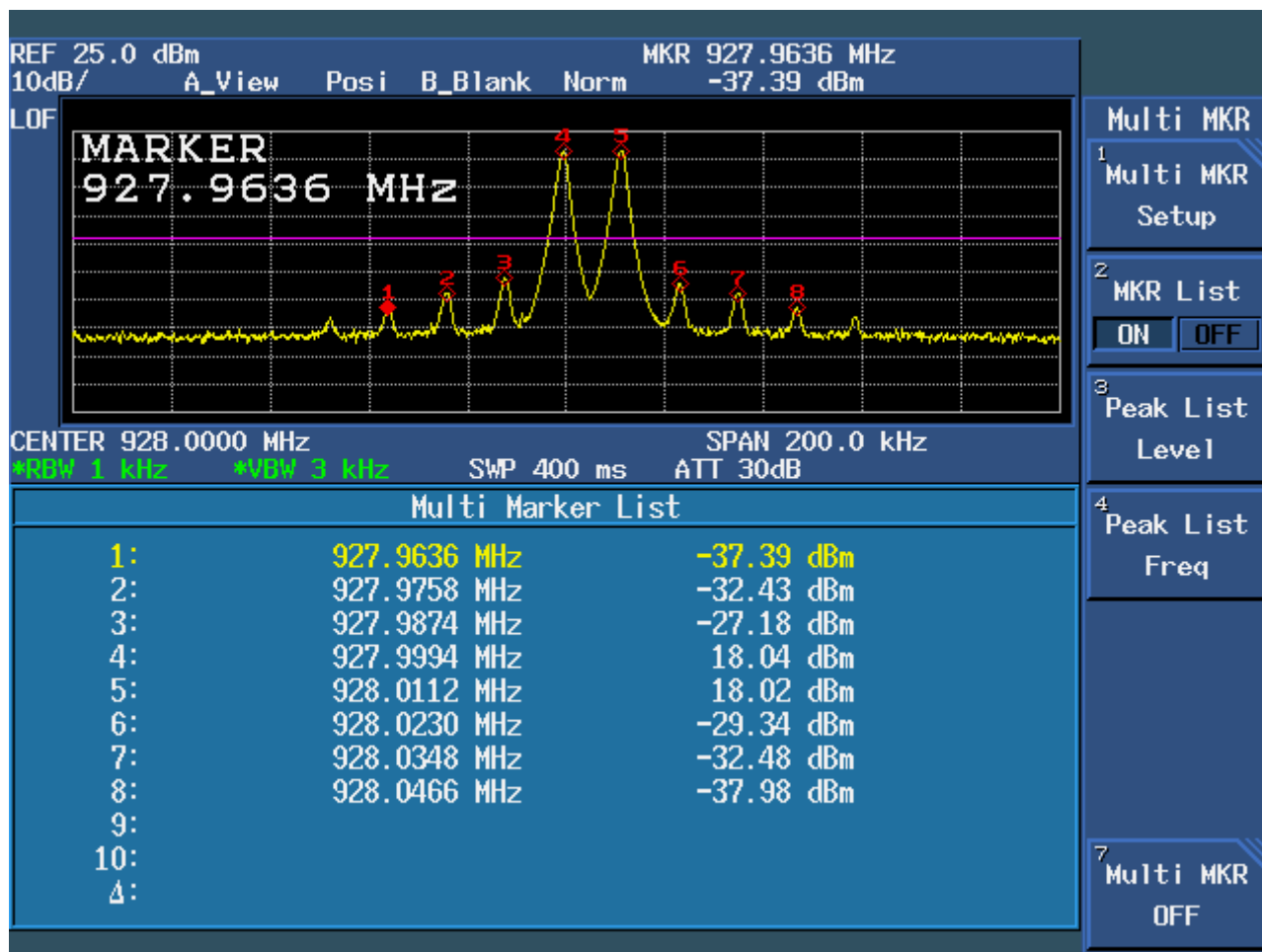

ULTRATECH GROUP OF LABS

3000 Bristol Circle, Oakville, Ontario, Canada L6H 6G4
 Tel. #: 905-829-1570, Fax. #: 905-829-8050, Email: vic@ultratech-labs.com, Website: <http://www.ultratech-labs.com>

File #: KT1-026FCC90
 June 5, 2003

- All test results contained in this engineering test report are traceable to National Institute of Standards and Technology (NIST)

Plot #4: Intermodulation with 1 RF Input in 928 – 941 MHz
RF Input: -10.19 dBm, Fc: 934.5 MHz

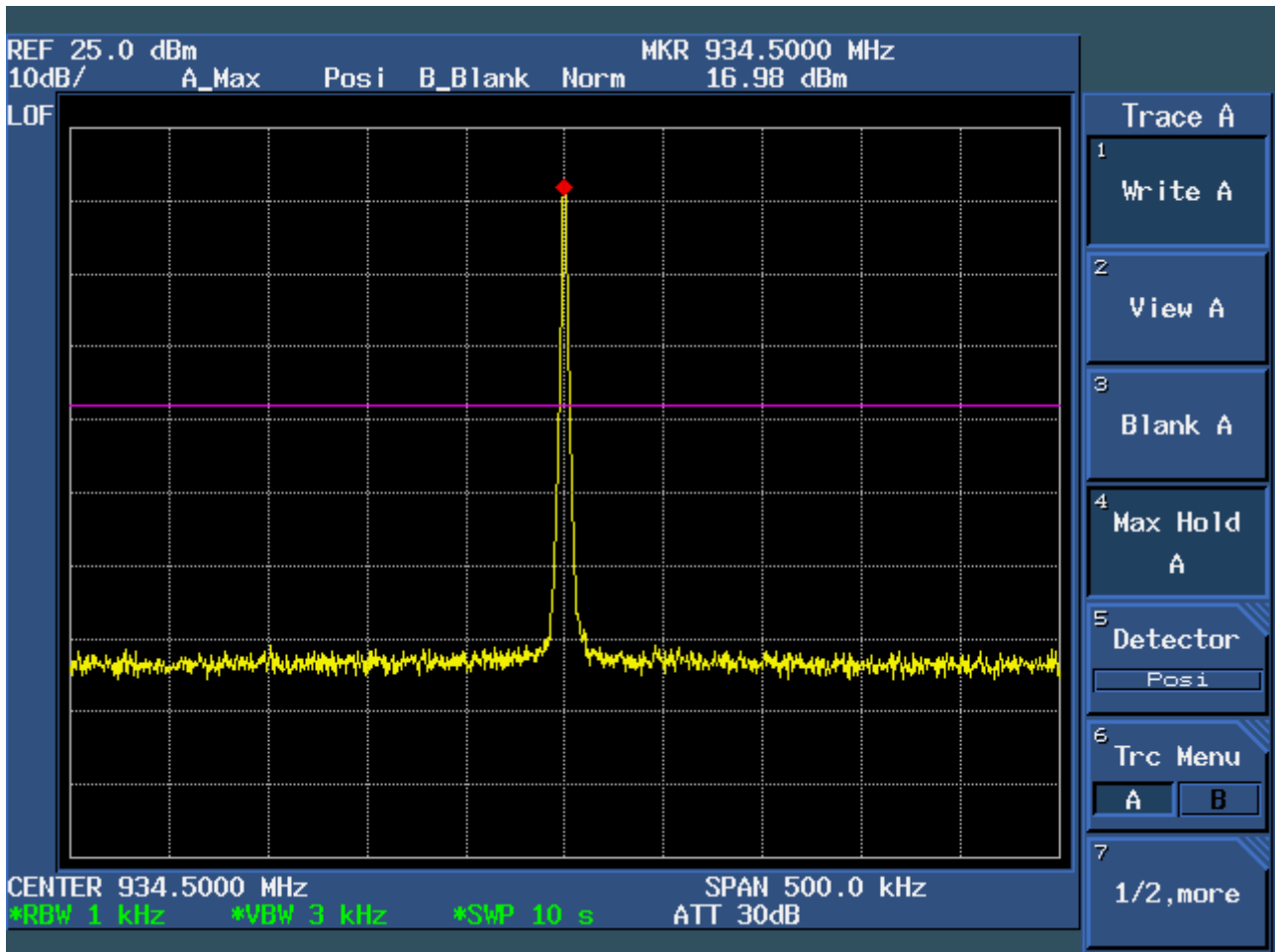

ULTRATECH GROUP OF LABS

3000 Bristol Circle, Oakville, Ontario, Canada L6H 6G4
Tel. #: 905-829-1570, Fax. #: 905-829-8050, Email: vic@ultratech-labs.com, Website: <http://www.ultratech-labs.com>

File #: KTI-026FCC90

June 5, 2003

- All test results contained in this engineering test report are traceable to National Institute of Standards and Technology (NIST)

Plot #5: Intermodulation with 2 RF Input in 928 – 941 MHz
RF Input: (1) –9.02 dBm, (2) –8.81 dBm
Fc: 934.5 MHz & Fc + 12.5 kHz

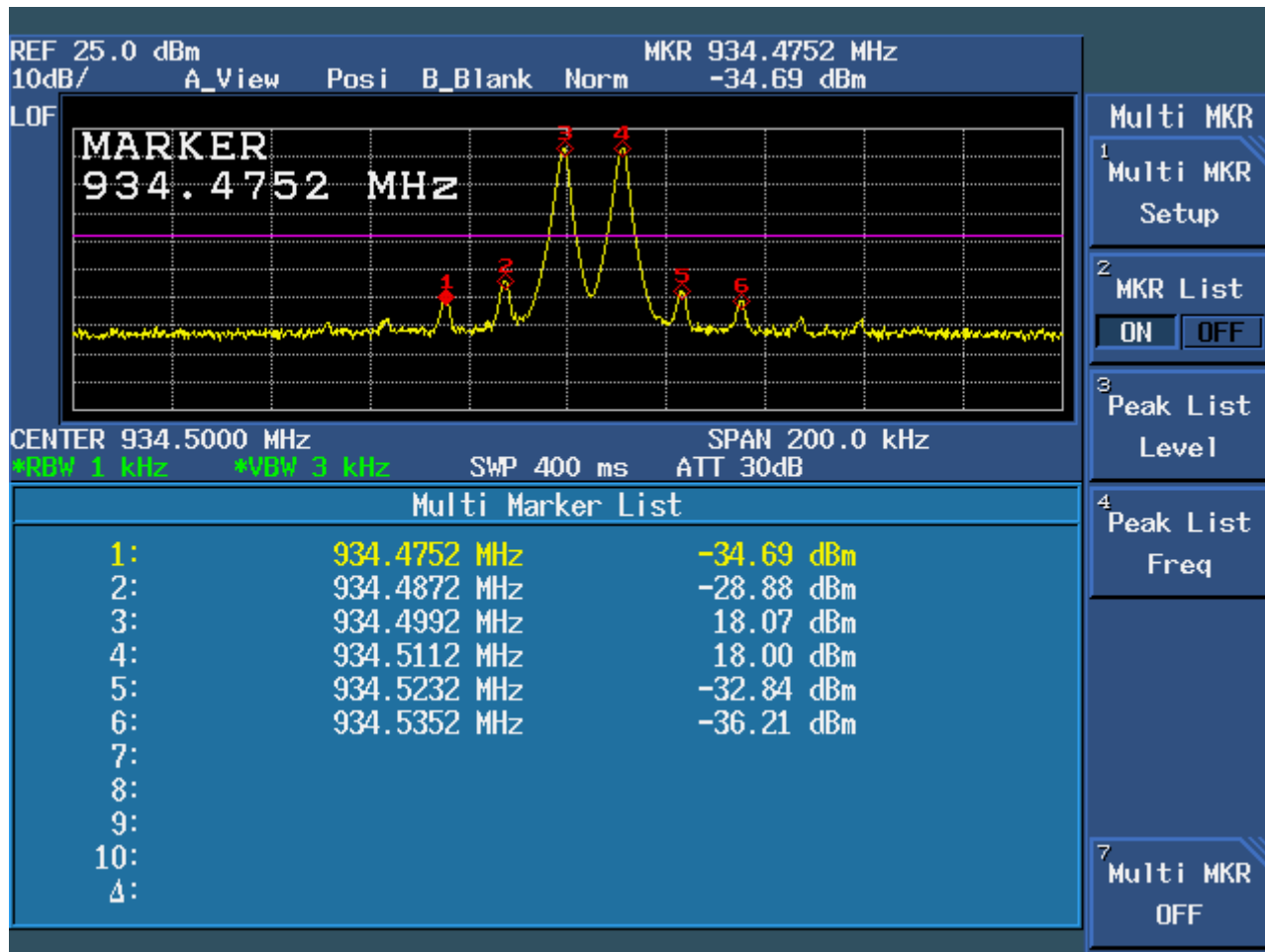

ULTRATECH GROUP OF LABS

3000 Bristol Circle, Oakville, Ontario, Canada L6H 6G4
 Tel. #: 905-829-1570, Fax. #: 905-829-8050, Email: vic@ultratech-labs.com, Website: <http://www.ultratech-labs.com>

File #: KTI-026FCC90
 June 5, 2003

- All test results contained in this engineering test report are traceable to National Institute of Standards and Technology (NIST)

Plot #6: Intermodulation with 3 RF Input in 928 – 941 MHz
RF Input: (1) –11.7 dBm, (2) –11.7 dBm, (3) –12.1 dBm
Fc: 934.5 MHz, Fc + 12.5 kHz & Fc – 12.5 kHz

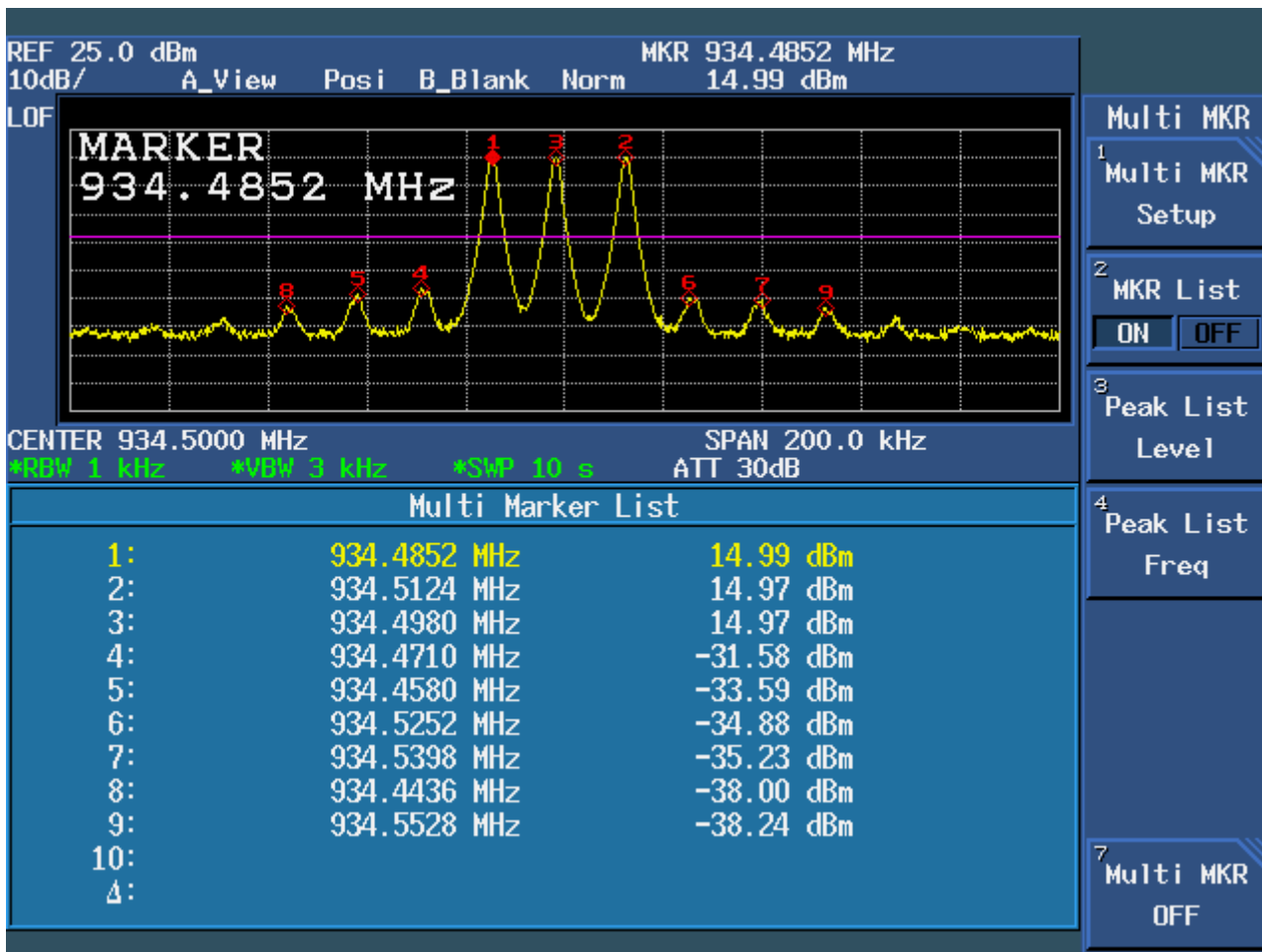

ULTRATECH GROUP OF LABS

3000 Bristol Circle, Oakville, Ontario, Canada L6H 6G4
 Tel. #: 905-829-1570, Fax. #: 905-829-8050, Email: vic@ultratech-labs.com, Website: <http://www.ultratech-labs.com>

File #: KTI-026FCC90
 June 5, 2003

- All test results contained in this engineering test report are traceable to National Institute of Standards and Technology (NIST)

Plot #7: Intermodulation with 1 RF Input in 928 – 941 MHz
RF Input: -8.75 dBm, Fc: 941 MHz

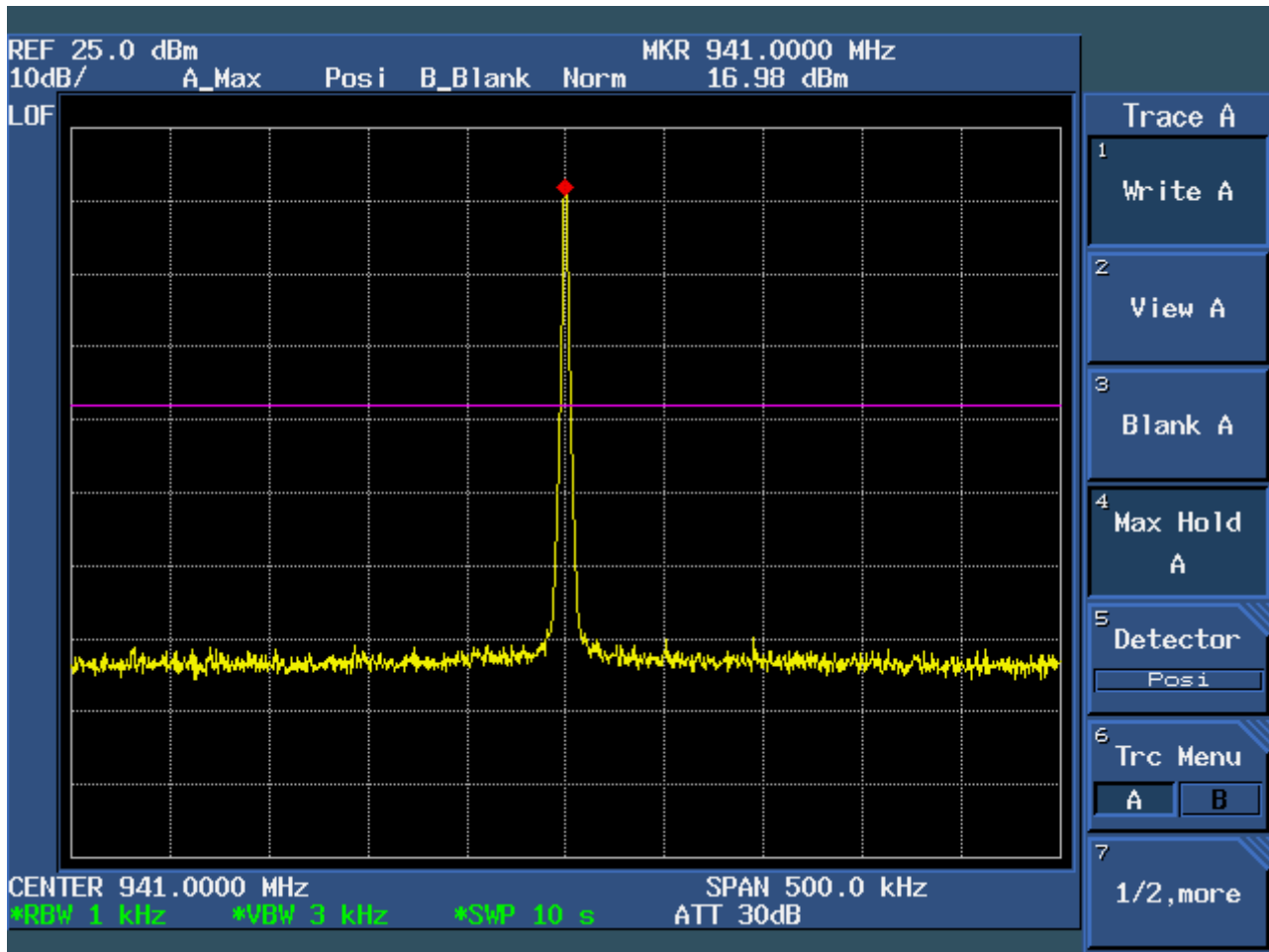

ULTRATECH GROUP OF LABS

3000 Bristol Circle, Oakville, Ontario, Canada L6H 6G4
Tel. #: 905-829-1570, Fax. #: 905-829-8050, Email: vic@ultratech-labs.com, Website: <http://www.ultratech-labs.com>

File #: KT1-026FCC90
June 5, 2003

- All test results contained in this engineering test report are traceable to National Institute of Standards and Technology (NIST)

Plot #8: Intermodulation with 2 RF Input in 928 – 941 MHz
RF Input: (1) -7.73 dBm, (2) -7.33 dBm
Fc: 941 MHz & Fc - 12.5 kHz

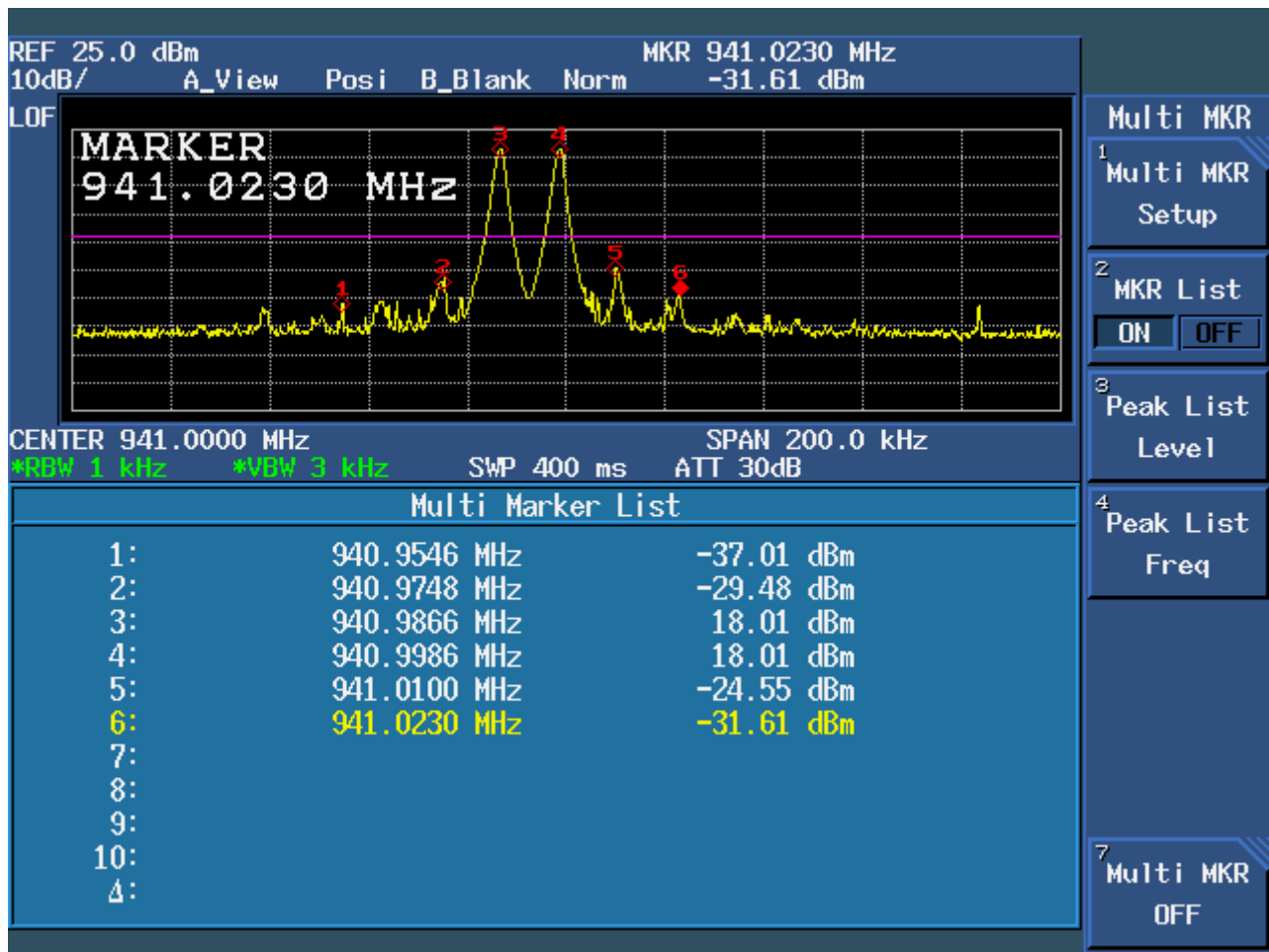

ULTRATECH GROUP OF LABS

3000 Bristol Circle, Oakville, Ontario, Canada L6H 6G4
 Tel. #: 905-829-1570, Fax. #: 905-829-8050, Email: vic@ultratech-labs.com, Website: <http://www.ultratech-labs.com>

File #: KTI-026FCC90
 June 5, 2003

- All test results contained in this engineering test report are traceable to National Institute of Standards and Technology (NIST)

6.6. RF EXPOSURE REQUIRMENTS @ 1.1310 & 2.1091

6.6.1. Limits

- **FCC 1.1310**:- The criteria listed in the following table shall be used to evaluate the environmental impact of human exposure to radio-frequency (RF) radiation as specified in 1.1307(b).

LIMITS FOR MAXIMUM PERMISSIBLE EXPOSURE (MPE)				
Frequency Range (MHz)	Electric Field Strength (V/m)	Magnetic Field Strength (A/m)	Power Density (mW/cm ²)	Average Time (minutes)
(B) Limits for General Population/Uncontrolled Exposure				
300-1500	F/1500	6

F = Frequency in MHz

6.6.2. Method of Measurements

Refer to FCC @ 1.1310, 2.1091 and Public Notice DA 00-705 (March 30, 2000)

- In order to demonstrate compliance with MPE requirements (see Section 2.1091), the following information is typically needed:
 - (1) Calculation that estimates the minimum separation distance (20 cm or more) between an antenna and persons required to satisfy power density limits defined for free space.
 - (2) Antenna installation and device operating instructions for installers (professional/unskilled users), and the parties responsible for ensuring compliance with the RF exposure requirement
 - (3) Any caution statements and/or warning labels that are necessary in order to comply with the exposure limits
 - (4) Any other RF exposure related issues that may affect MPE compliance

- *All test results contained in this engineering test report are traceable to National Institute of Standards and Technology (NIST)*

Calculation Method of RF Safety Distance:

$$S = PG/4\pi r^2 = EIRP/4\pi r^2$$

Where: P: power input to the antenna in mW
 EIRP: Equivalent (effective) isotropic radiated power.
 S: power density mW/cm²
 G: numeric gain of antenna relative to isotropic radiator
 r: distance to centre of radiation in cm

FCC radio frequency exposure limits may be exceeded at distances closer than r cm from the antenna of this device

$$r = \sqrt{PG/4\pi S}$$

FCC radio frequency exposure limits may not be exceeded at distances closer than r cm from the antenna of this device

- For portable transmitters (see Section 2.1093), or devices designed to operate next to a person's body, compliance is determined with respect to the SAR limit (define in the body tissues) for near-field exposure conditions. If the maximum average output power, operating condition configurations and exposure conditions are comparable to those of existing Paging and PCS phones., an SAR evaluation may be required in order to determine if such a device complies with SAR limit. When SAR evaluation data is not available, and the additional supporting information cannot assure compliance, the Commission may request that an SAR evaluation be performed, as provided for in Section 1.1307(d)

6.6.3. Test Data

Antenna Gain Limit specified by Manufacturer: 0 dBi

Frequency (MHz)	Measured Maximum Peak RF Conducted Power (dBm)	Calculated EIRP (dBm)	Laboratory's Recommended Minimum RF Safety Distance r (cm)
928 & 928.0125	18	18	2.9

Note 1: RF EXPOSURE DISTANCE LIMITS: $r = (PG/4\pi S)^{1/2} = (EIRP/4\pi S)^{1/2}$
 $S = F/1500 = 928/1500 = 0.618 \text{ mW/cm}^2$

Evaluation of RF Exposure Compliance Requirements	
RF Exposure Requirements	Compliance with FCC Rules
Minimum calculated separation distance between antenna and persons required: 2.9 cm	Manufacturer's instruction for separation distance between antenna and persons required: 20 cm. Please refer to page # 18 of the Users/ Manual and FCC RF Exposure folder

6.7. EMISSION MASK @ FCC 2.1049, 90.208 & 90.210

6.7.1. Limits @ FCC 90.209 & 90.210

Emissions shall be attenuated below the mean output power of the transmitter as follows:

FREQUENCY RANGE (MHz)	Maximum Authorized BW (KHz)	CHANNEL SPACING (KHz)	Recommended Max. FREQ. DEVIATION (KHz)	FCC APPLICABLE MASK @ FCC 90.210
929-930	20	25	5	MASK B (Voice) & MASK G (Data)
935-940	12.5	13.6	2.5	MASK I (Voice) & MASK J (Data)

6.7.2. Method of Measurements

Refer to Exhibit 8, § 8.4 of this report for measurement details

6.7.3. Test Equipment List

Test Instruments	Manufacturer	Model No.	Serial No.	Frequency Range
EMI Receiver/ EMI Receiver	Hewlett Packard	HP 8593EM	3412A00103	9 kHz – 26.5 GHz
Attenuator(s)	Bird	DC – 22 GHz
Audio Oscillator	Hewlett Packard	HP 204C	0989A08798	DC to 1.2 MHz

6.7.4. Test Arrangement

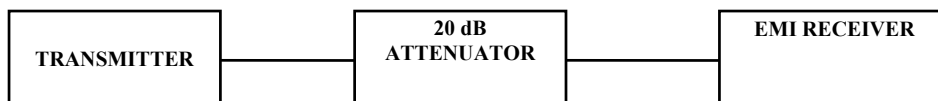

6.7.5. Test Data

Remark: Since the device under test is an amplifier, the comparison test of rf input and output signals are conducted for compliance with FCC Rules.

6.7.5.1. 20 dB Bandwidth and Gain of the Amplifier

Refer to Plot # 10 for detailed measurements of 20 dB and maximum gain of the Amplifier

6.7.5.2. 99% Bandwidth - RF Output versus RF Input in 928 - 941 MHz Band

Note: Please refer to Plots # 11 & 12 below for RF input signal characteristics fro comparison with the RF output

Frequency (MHz)	Modulation	99% Bandwidth of RF Input Signal (MHz)	99% Bandwidth of RF Output Signal (MHz)	Measurement Plot Number
928	F8E	15.7	15.7	13
934.5	F8E	15.7	15.7	14
941	F8E	15.7	15.7	15
928	F8D	17.7	17.9	16
934.5	F8D	17.7	17.9	17
941	F8D	17.7	17.8	18

6.7.5.3. Emission Mask and Band-edge Emissions

Conforms.

Plots 19 to 26 show the Comparison of Emissions Masks of the Input and Output Signals to ensure the output signal meet the FCC requirements.

Plot #10: 20 dB BW of the 928 – 941 MHz band pass gain
RF Input: -10.19 dBm, Tracking from 910 – 960 MHz
Max. Gain: 27.2 dB
Marker 1: 923.85 MHz, Marker 2: 946.20 MHz, Marker 3: 934.5 MHz

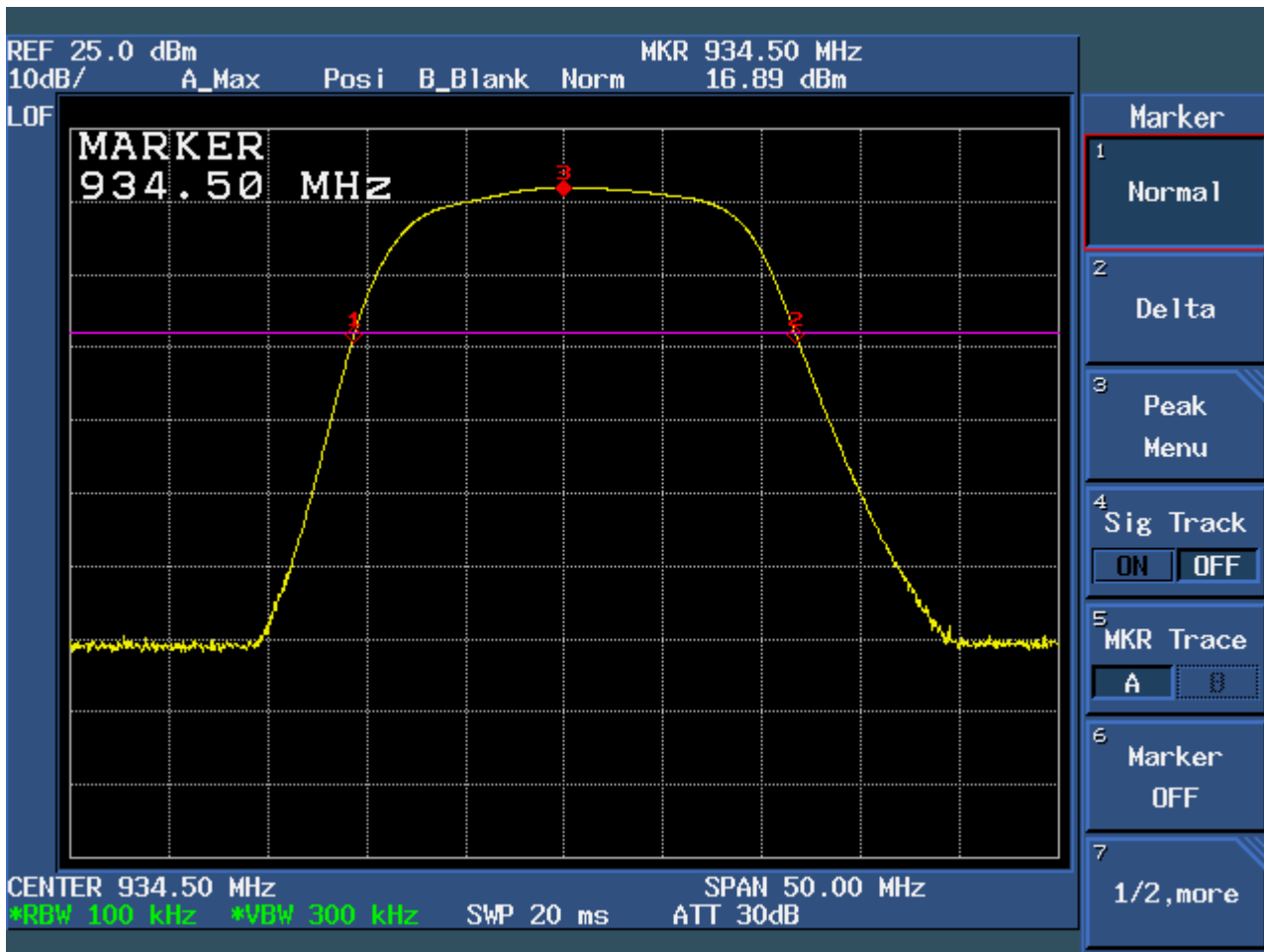

ULTRATECH GROUP OF LABS

3000 Bristol Circle, Oakville, Ontario, Canada L6H 6G4
Tel. #: 905-829-1570, Fax. #: 905-829-8050, Email: vic@ultratech-labs.com, Website: <http://www.ultratech-labs.com>

File #: KTI-026FCC90
June 5, 2003

- All test results contained in this engineering test report are traceable to National Institute of Standards and Technology (NIST)

Plot #11: 99 % OBW RF Input
Frequency: 934.5 MHz (928 - 941 MHz)
Modulation: FM modulation with 2.5 kHz Sine Wave signal, 5 kHz deviation



ULTRATECH GROUP OF LABS

3000 Bristol Circle, Oakville, Ontario, Canada L6H 6G4
 Tel. #: 905-829-1570, Fax. #: 905-829-8050, Email: vic@ultratech-labs.com, Website: <http://www.ultratech-labs.com>

File #: KT1-026FCC90
 June 5, 2003

- All test results contained in this engineering test report are traceable to National Institute of Standards and Technology (NIST)

Plot #12: 99 % OBW RF Input
 Frequency: 934.5 MHz (928 - 941 MHz)
 Modulation: FM modulation with 9600 b/s random data source, 5 kHz deviation



ULTRATECH GROUP OF LABS

3000 Bristol Circle, Oakville, Ontario, Canada L6H 6G4
 Tel. #: 905-829-1570, Fax. #: 905-829-8050, Email: vic@ultratech-labs.com, Website: <http://www.ultratech-labs.com>

File #: KT1-026FCC90
 June 5, 2003

- All test results contained in this engineering test report are traceable to National Institute of Standards and Technology (NIST)

Plot #13: 99 % OBW RF Output
Frequency: 928 MHz (928 - 941 MHz)
Modulation: FM modulation with 2.5 kHz Sine Wave signal, 5 kHz deviation



- All test results contained in this engineering test report are traceable to National Institute of Standards and Technology (NIST)

Plot #14: 99 % OBW RF Output
Frequency: 934.5 MHz (928 - 941 MHz)
Modulation: FM modulation with 2.5 kHz Sine Wave signal, 5 kHz deviation



▪ All test results contained in this engineering test report are traceable to National Institute of Standards and Technology (NIST)

Plot #15: 99 % OBW RF Output
Frequency: 941 MHz (928 - 941 MHz)
Modulation: FM modulation with 2.5 kHz Sine Wave signal, 5 kHz deviation

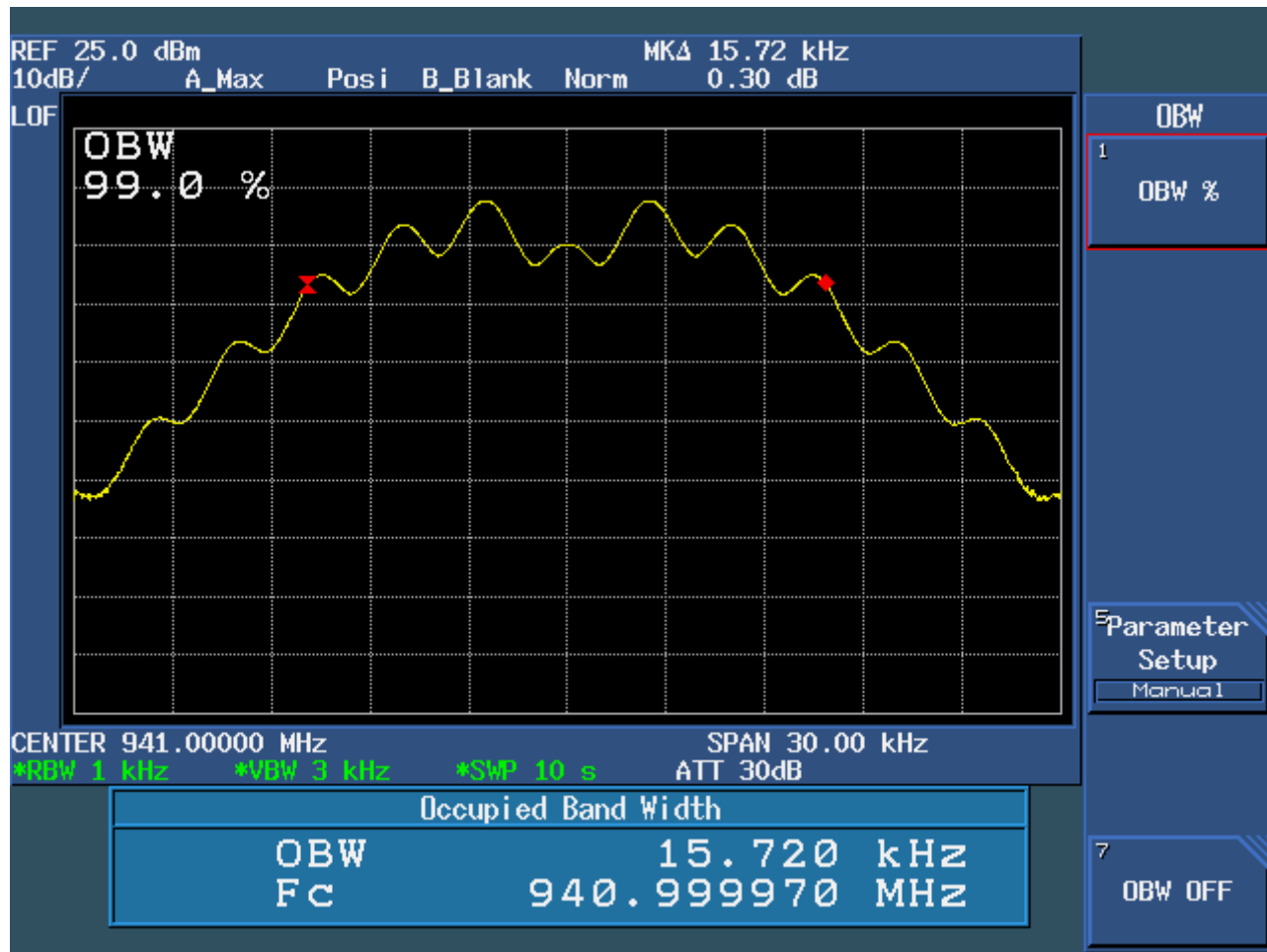

Plot #16: 99 % OBW RF Output
Frequency: 928 MHz (928 - 941 MHz)
Modulation: FM modulation with 9600 b/s random data source, 5 kHz deviation



- All test results contained in this engineering test report are traceable to National Institute of Standards and Technology (NIST)

Plot #17: 99 % OBW RF Output
Frequency: 934.5 MHz (928 - 941 MHz)
Modulation: FM modulation with 9600 b/s random data source, 5 kHz deviation



ULTRATECH GROUP OF LABS

3000 Bristol Circle, Oakville, Ontario, Canada L6H 6G4
 Tel. #: 905-829-1570, Fax. #: 905-829-8050, Email: vic@ultratech-labs.com, Website: <http://www.ultratech-labs.com>

File #: KTI-026FCC90

June 5, 2003

- All test results contained in this engineering test report are traceable to National Institute of Standards and Technology (NIST)

Plot #18: 99 % OBW RF Output
Frequency: 941 MHz (928 - 941 MHz)
Modulation: FM modulation with 9600 b/s random data source, 5 kHz deviation

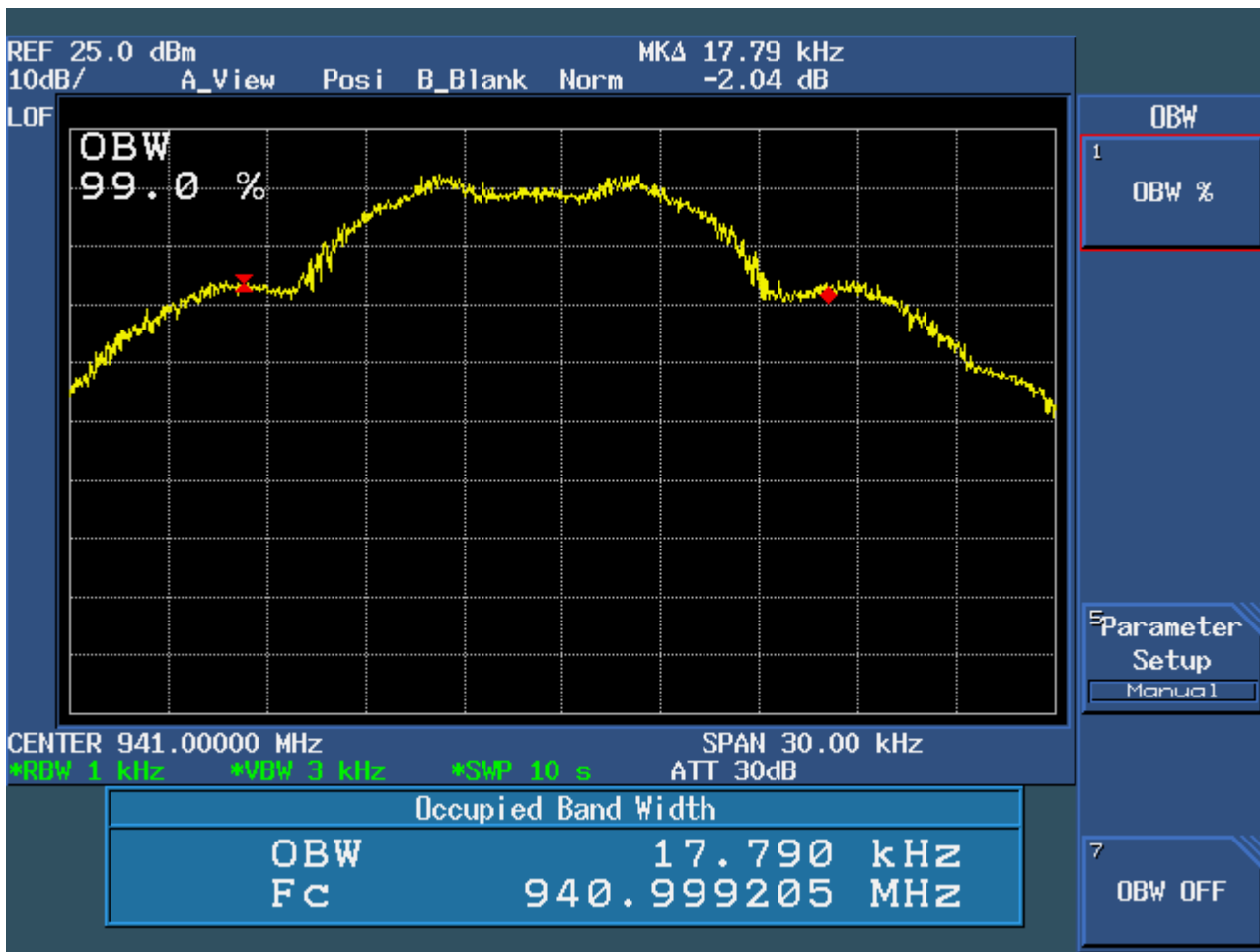

Plot #19:

ULTRATECH GROUP OF LABS

3000 Bristol Circle, Oakville, Ontario, Canada L6H 6G4
Tel. #: 905-829-1570, Fax. #: 905-829-8050, Email: vic@ultratech-labs.com, Website: <http://www.ultratech-labs.com>

File #: KT1-026FCC90
June 5, 2003

- *All test results contained in this engineering test report are traceable to National Institute of Standards and Technology (NIST)*

Plot 20: Emission Mask B, RF Output
Frequency: 929.5 MHz (929 - 930 MHz)
Modulation: FM modulation with 2.5 kHz Sine Wave signal, 5 kHz deviation

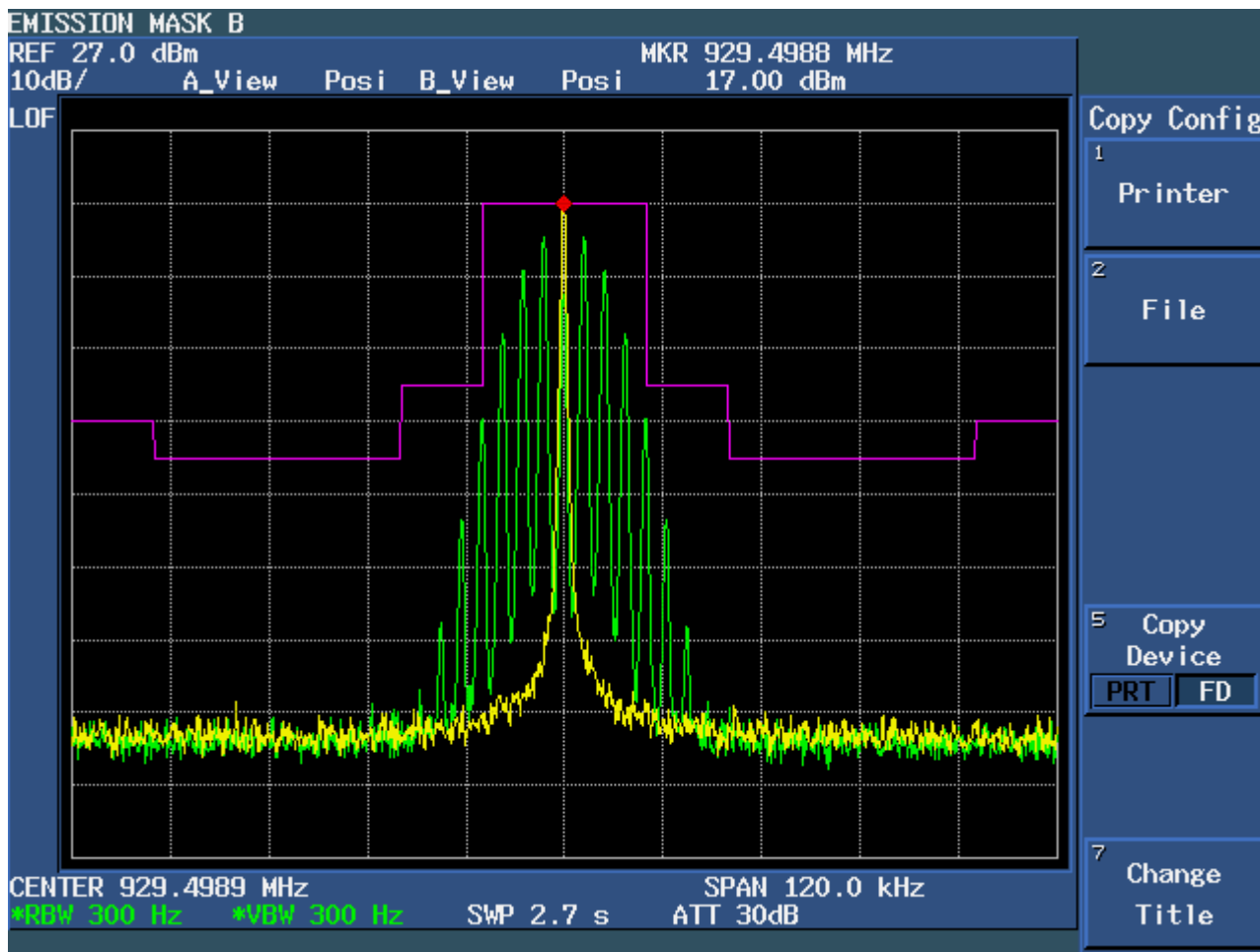

ULTRATECH GROUP OF LABS

3000 Bristol Circle, Oakville, Ontario, Canada L6H 6G4
Tel. #: 905-829-1570, Fax. #: 905-829-8050, Email: vic@ultratech-labs.com, Website: <http://www.ultratech-labs.com>

File #: KTI-026FCC90
June 5, 2003

- All test results contained in this engineering test report are traceable to National Institute of Standards and Technology (NIST)

Plot 21:

ULTRATECH GROUP OF LABS

3000 Bristol Circle, Oakville, Ontario, Canada L6H 6G4
Tel. #: 905-829-1570, Fax. #: 905-829-8050, Email: vic@ultratech-labs.com, Website: <http://www.ultratech-labs.com>

File #: KT1-026FCC90
June 5, 2003

- *All test results contained in this engineering test report are traceable to National Institute of Standards and Technology (NIST)*

Plot # 22: Emission Mask G, RF Output
Frequency: 929.5 MHz (929 - 930 MHz)
Modulation: FM modulation with 9600 b/s random data source, 5 kHz deviation

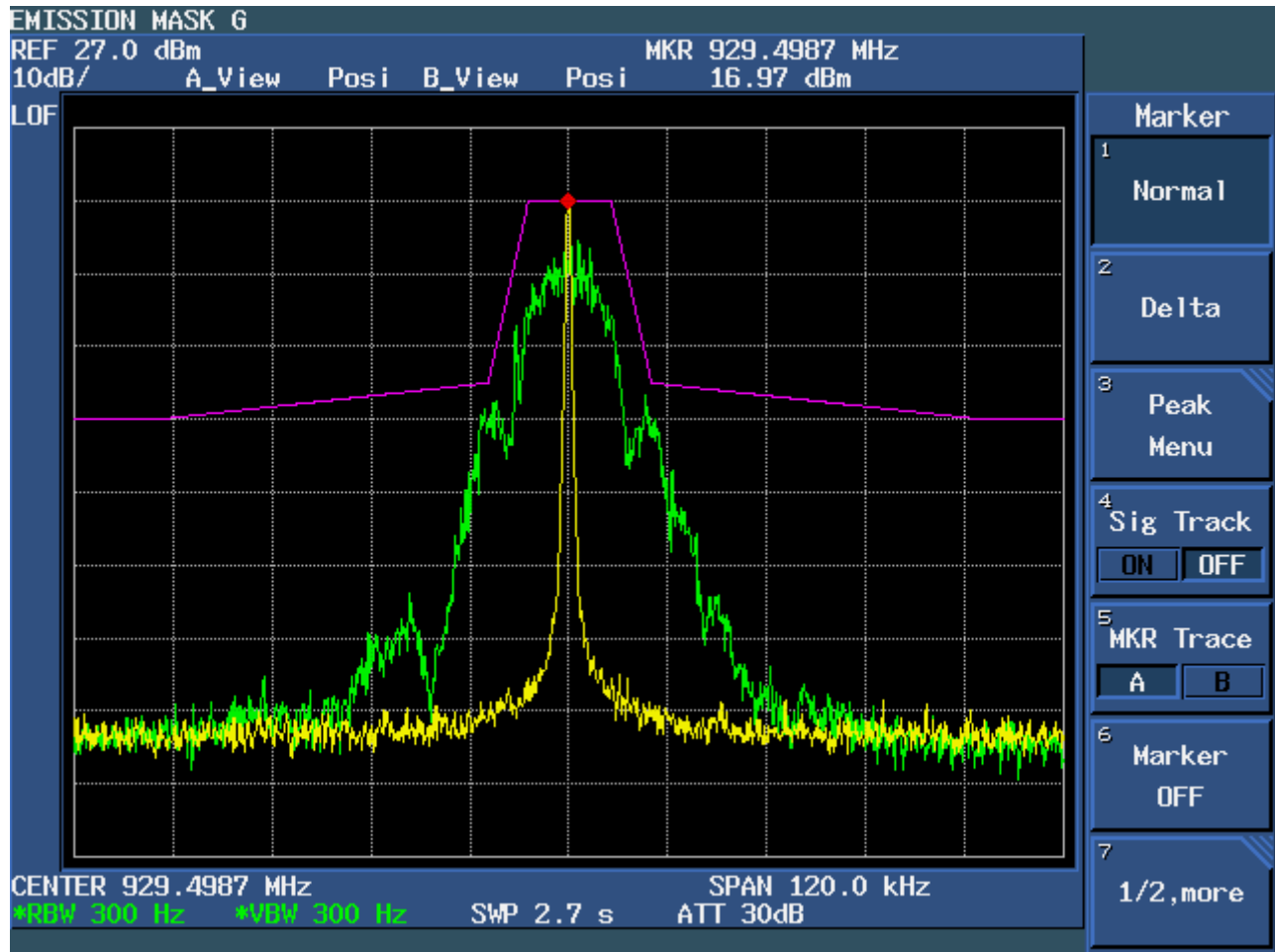

ULTRATECH GROUP OF LABS

3000 Bristol Circle, Oakville, Ontario, Canada L6H 6G4
Tel. #: 905-829-1570, Fax. #: 905-829-8050, Email: vic@ultratech-labs.com, Website: <http://www.ultratech-labs.com>

File #: KTI-026FCC90
June 5, 2003

- All test results contained in this engineering test report are traceable to National Institute of Standards and Technology (NIST)

Plot #23:

ULTRATECH GROUP OF LABS

3000 Bristol Circle, Oakville, Ontario, Canada L6H 6G4
Tel. #: 905-829-1570, Fax. #: 905-829-8050, Email: vic@ultratech-labs.com, Website: <http://www.ultratech-labs.com>

File #: KT1-026FCC90
June 5, 2003

- *All test results contained in this engineering test report are traceable to National Institute of Standards and Technology (NIST)*

Plot #24: Emission Mask I, RF Output
Frequency: 937.5 MHz (935 - 940 MHz)
Modulation: FM modulation with 2.5 kHz Sine Wave signal, 2.5 kHz deviation

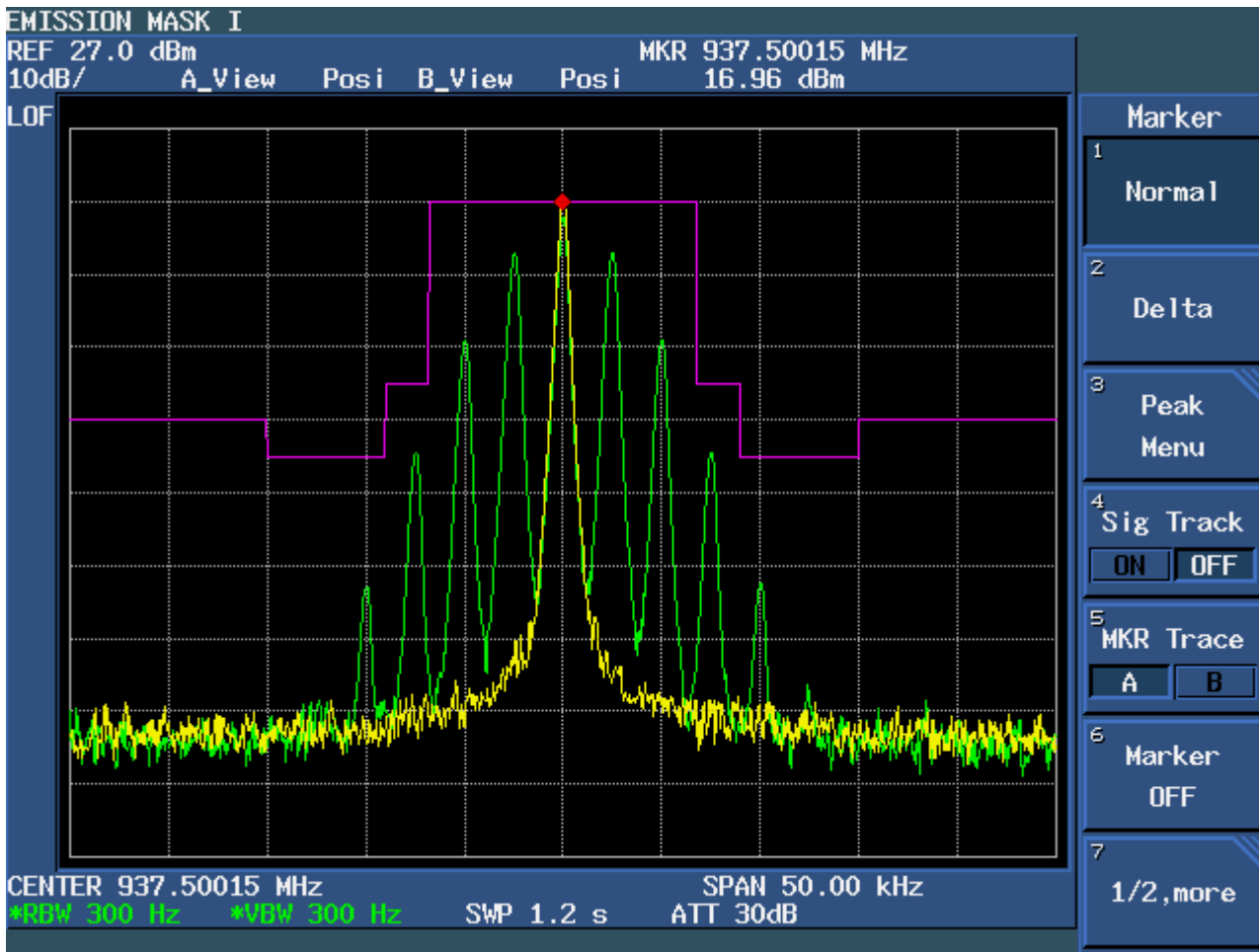

ULTRATECH GROUP OF LABS

3000 Bristol Circle, Oakville, Ontario, Canada L6H 6G4
Tel. #: 905-829-1570, Fax. #: 905-829-8050, Email: vic@ultratech-labs.com, Website: <http://www.ultratech-labs.com>

File #: KT1-026FCC90

June 5, 2003

- All test results contained in this engineering test report are traceable to National Institute of Standards and Technology (NIST)

Plot # 25:

ULTRATECH GROUP OF LABS

3000 Bristol Circle, Oakville, Ontario, Canada L6H 6G4
Tel. #: 905-829-1570, Fax. #: 905-829-8050, Email: vic@ultratech-labs.com, Website: <http://www.ultratech-labs.com>

File #: **KTI-026FCC90**
June 5, 2003

- *All test results contained in this engineering test report are traceable to National Institute of Standards and Technology (NIST)*

Plot #26: Emission Mask J, RF Output
Frequency: 937.5 MHz (935 - 940 MHz)
Modulation: FM modulation with 9600 b/s random data source, 5 kHz deviation

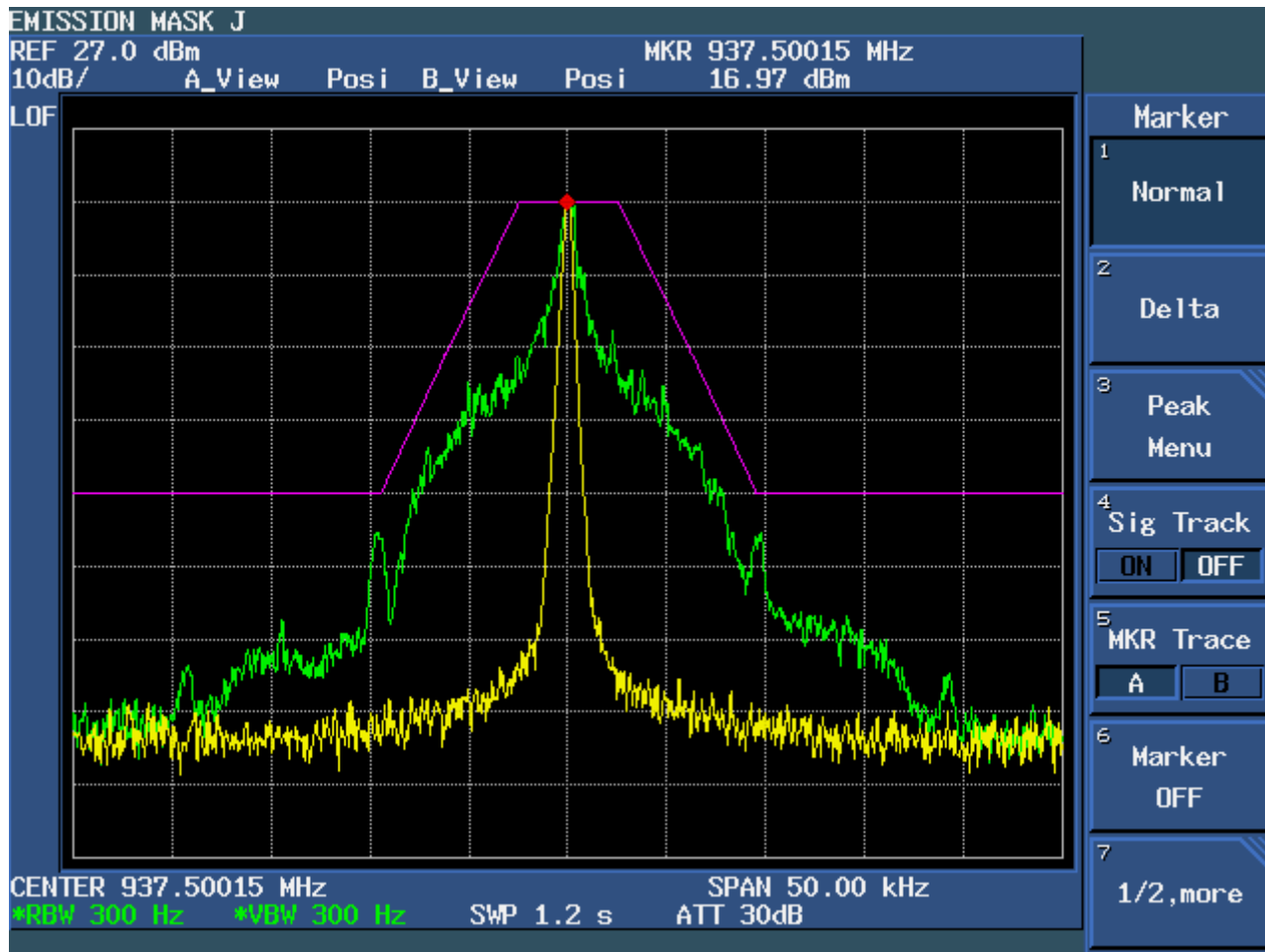

ULTRATECH GROUP OF LABS

3000 Bristol Circle, Oakville, Ontario, Canada L6H 6G4
Tel. #: 905-829-1570, Fax. #: 905-829-8050, Email: vic@ultratech-labs.com, Website: <http://www.ultratech-labs.com>

File #: KT1-026FCC90
June 5, 2003

- All test results contained in this engineering test report are traceable to National Institute of Standards and Technology (NIST)

6.8. TRANSMITTER ANTENNA POWER SPURIOUS/HARMONIC CONDUCTED EMISSIONS @ FCC 90.210

6.8.1. Limits @ 90.210

Emissions shall be attenuated below the mean output power of the transmitter as follows:

FCC Rules	Frequency Range	Attenuation Limit (dBc)
90.210(b)(g)	929-930	43 + 10log(P in Watt)
90210(i)(j)	935-940	50 + 10log(P in Watts)

6.8.2. Method of Measurements

Refer to Exhibit 8 § 8.3 of this report for measurement details

6.8.3. Test Equipment List

Test Instruments	Manufacturer	Model No.	Serial No.	Frequency Range
Spectrum Analyzer/ EMI Receiver	Hewlett Packard	HP 8593EM	3412A00103	9 kHz – 26.5 GHz
Attenuator(s)	Bird	DC – 22 GHz
Audio Oscillator	Hewlett Packard	HP 204C	0989A08798	DC to 1.2 MHz
Highpass Filter, Microphase	Microphase	CR220HID	IIT11000AC	Cut-off Frequency at 600 MHz, 1.3 GHz or 4 GHz

6.8.4. Test Arrangement

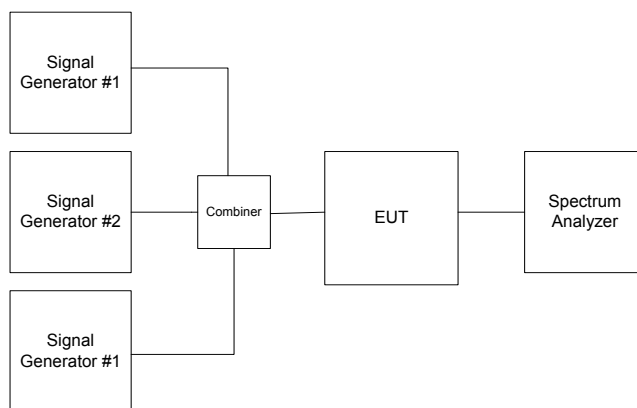

6.8.5. Test Data

Remarks:

- (1) Based on our prescans, there was no difference in rf spurious emissions at the antenna port with unmodulated, FM voice modulated and FM Data modulated RF outputs. Therefore, the unmodulated rf out put was tested and represent for all.
- (2) For worst case, the limit of $50 + 10\log(P \text{ in Watts})$ will be used throughout the tests.

6.8.5.1. Downlink Band 928 - 941 MHz: Test Centre Frequency: 928 MHz, Modulation: UNMODULATED

Fundamental Frequency: 928 MHz (single channel input/output)					
RF Input Power: -7.2 dBm					
RF Output Power: +17 dBm as maximum rated by the manufacturer					
Modulation: unmodulated					
FREQUENCY (MHz)	TRANSMITTER CONDUCTED ANTENNA EMISSIONS		LIMIT (dBc)	MARGIN (dB)	PASS/ FAIL
	(dBm)	(dBc)			
2784	-53.9	-70.9	-37.0	-33	PASS
<ul style="list-style-type: none"> • The emissions were scanned from 10 MHz to 10 GHz and no rf spurious emissions less than 40 dB below the limits were found. • Refer to Plots # 27-28 for Spurious emissions outside the Permitted Band 928 - 941 MHz. 					

Fundamental Frequencies: 928 & 928.0125 MHz (2 channel inputs/outputs)					
RF Input Power: -6.0 dBm/channel as maximum rated by the manufacturer					
RF Output Power: +18 dBm/channel or +24.2 dBm (total power of 2 channels)					
Modulation: unmodulated					
FREQUENCY (MHz)	TRANSMITTER CONDUCTED ANTENNA EMISSIONS		LIMIT (dBc)	MARGIN (dB)	PASS/ FAIL
	(dBm)	(dBc)			
2784	-21.0	-45.2	-44.2	-1.0	PASS
<ul style="list-style-type: none"> • The emissions were scanned from 10 MHz to 10 GHz and all rf spurious emissions less than 40 dB below the limits were recorded. • Refer to Plots # 29-30 for Spurious emissions outside the Permitted Band 928 - 941 MHz. 					

Fundamental Frequencies: 928, 928.0125 & 928.0250 MHz (3 channel inputs/outputs)					
RF Input Power: -8.7 dBm/channel as maximum rated by the manufacturer					
RF Output Power: +15 dBm/channel or +24.1 dBm (total power of 3 channels)					
Modulation: unmodulated					
FREQUENCY (MHz)	TRANSMITTER CONDUCTED ANTENNA EMISSIONS		LIMIT (dBc)	MARGIN (dB)	PASS/ FAIL
	(dBm)	(dBc)			
2784	-21.1	-45.1	-44.1	-1.0	PASS
<ul style="list-style-type: none"> • The emissions were scanned from 10 MHz to 10 GHz and all rf spurious emissions less than 40 dB below the limits were recorded. • Refer to Plots # 31-32 for Spurious emissions outside the Permitted Band 928 - 941 MHz. 					

6.8.5.2. Downlink Band 928 - 941 MHz: Test Centre Frequency: 934.5 MHz, Modulation: UNMODULATED

Fundamental Frequency: 934.5 MHz (single channel input/output)					
RF Input Power: -10.2 dBm					
RF Output Power: +17 dBm as maximum rated by the manufacturer					
Modulation: unmodulated					
FREQUENCY (MHz)	TRANSMITTER CONDUCTED ANTENNA EMISSIONS		LIMIT (dBc)	MARGIN (dB)	PASS/ FAIL
	(dBm)	(dBc)			
2803.5	-57.0	-74.0	-37.0	-37.0	PASS
<ul style="list-style-type: none"> The emissions were scanned from 10 MHz to 10 GHz and no rf spurious emissions less than 40 dB below the limits were found. Refer to Plots # 33-34 for Spurious emissions outside the Permitted Band 928 - 941 MHz. 					

Fundamental Frequencies: 934.5 & 934.5.0125 MHz (2 channel inputs/outputs)					
RF Input Power: -8.8 dBm/channel as maximum rated by the manufacturer					
RF Output Power: +18 dBm/channel or +24.3 dBm (total power of 2 channels)					
Modulation: unmodulated					
FREQUENCY (MHz)	TRANSMITTER CONDUCTED ANTENNA EMISSIONS		LIMIT (dBc)	MARGIN (dB)	PASS/ FAIL
	(dBm)	(dBc)			
2803.5	-22.40	-46.7	-44.3	-2.4	PASS
<ul style="list-style-type: none"> The emissions were scanned from 10 MHz to 10 GHz and all rf spurious emissions less than 40 dB below the limits were recorded. Refer to Plots # 35-36 for Spurious emissions outside the Permitted Band 928 - 941 MHz. 					

Fundamental Frequencies: 934.4875, 934.5, 934.0125 MHz (3 channel inputs/outputs)					
RF Input Power: -11.7 dBm/channel as maximum rated by the manufacturer					
RF Output Power: +15 dBm/channel or +24.0 dBm (total power of 3 channels)					
Modulation: unmodulated					
FREQUENCY (MHz)	TRANSMITTER CONDUCTED ANTENNA EMISSIONS		LIMIT (dBc)	MARGIN (dB)	PASS/ FAIL
	(dBm)	(dBc)			
2803.5	-25.1	-49.1	-44.0	-5.1	PASS
<ul style="list-style-type: none"> The emissions were scanned from 10 MHz to 10 GHz and all rf spurious emissions less than 40 dB below the limits were recorded. Refer to Plots # 37-38 for Spurious emissions outside the Permitted Band 928 - 941 MHz. 					

ULTRATECH GROUP OF LABS

3000 Bristol Circle, Oakville, Ontario, Canada L6H 6G4
 Tel. #: 905-829-1570, Fax. #: 905-829-8050, Email: vic@ultratech-labs.com, Website: <http://www.ultratech-labs.com>

File #: KTI-026FCC90
 June 5, 2003

- All test results contained in this engineering test report are traceable to National Institute of Standards and Technology (NIST)

6.8.5.3. Downlink Band 928 - 941 MHz: Test Centre Frequency: 941 MHz, Modulation: UNMODULATED

Fundamental Frequency: 941 MHz (single channel input/output)					
RF Input Power: -8.8 dBm					
RF Output Power: +17 dBm as maximum rated by the manufacturer					
Modulation: unmodulated					
FREQUENCY (MHz)	TRANSMITTER CONDUCTED ANTENNA EMISSIONS		LIMIT (dBc)	MARGIN (dB)	PASS/ FAIL
	(dBm)	(dBc)			
2823	-59.3	76.3	-37.0	-39.3	PASS
<ul style="list-style-type: none"> The emissions were scanned from 10 MHz to 10 GHz and no rf spurious emissions less than 40 dB below the limits were found. Refer to Plots # 39-40 for Spurious emissions outside the Permitted Band 928 - 941 MHz. 					

Fundamental Frequencies: 940.9875 & 941 MHz (2 channel inputs/outputs)					
RF Input Power: -7.3 dBm/channel as maximum rated by the manufacturer					
RF Output Power: +18 dBm/channel or +24.2 dBm (total power of 2 channels)					
Modulation: unmodulated					
FREQUENCY (MHz)	TRANSMITTER CONDUCTED ANTENNA EMISSIONS		LIMIT (dBc)	MARGIN (dB)	PASS/ FAIL
	(dBm)	(dBc)			
2823	-26.5	-50.7	-44.2	-6.5	PASS
<ul style="list-style-type: none"> The emissions were scanned from 10 MHz to 10 GHz and all rf spurious emissions less than 40 dB below the limits were recorded. Refer to Plots # 41-42 for Spurious emissions outside the Permitted Band 928 - 941 MHz. 					

Fundamental Frequencies: 940.9750, 940.9875 & 941 MHz (3 channel inputs/outputs)					
RF Input Power: -10.4 dBm/channel as maximum rated by the manufacturer					
RF Output Power: +15 dBm/channel or +24.0 dBm (total power of 3 channels)					
Modulation: unmodulated					
FREQUENCY (MHz)	TRANSMITTER CONDUCTED ANTENNA EMISSIONS		LIMIT (dBc)	MARGIN (dB)	PASS/ FAIL
	(dBm)	(dBc)			
2823	-27.8	-51.8	-44.0	-7.8	PASS
<ul style="list-style-type: none"> The emissions were scanned from 10 MHz to 10 GHz and all rf spurious emissions less than 40 dB below the limits were recorded. Refer to Plots # 43-44 for Spurious emissions outside the Permitted Band 928 - 941 MHz. 					

Plot # 27: Spurious Emissions Conducted @ 928 – 941 MHz Output with 1 RF Input signals
Fc: 928 MHz

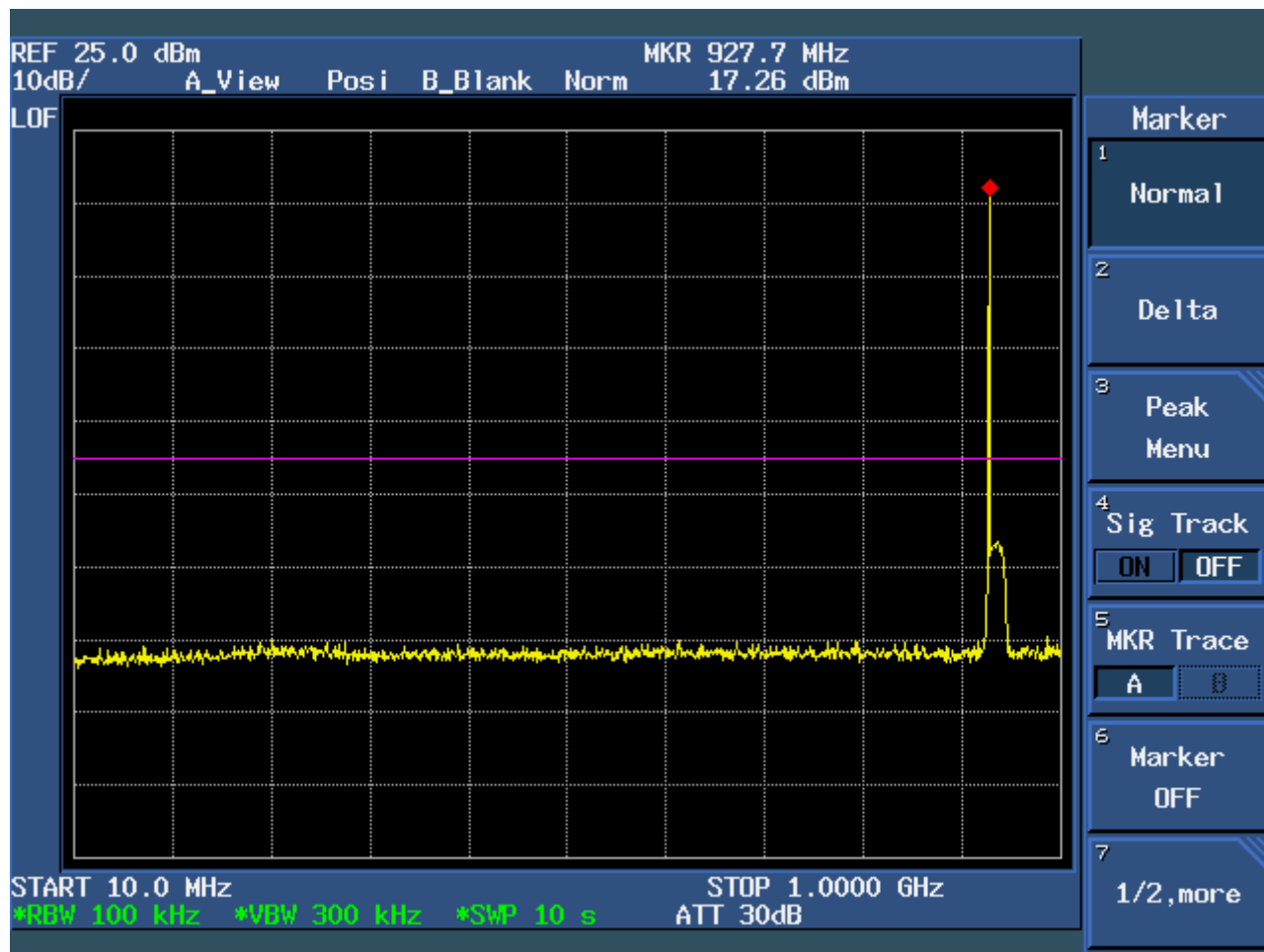

ULTRATECH GROUP OF LABS

3000 Bristol Circle, Oakville, Ontario, Canada L6H 6G4
Tel. #: 905-829-1570, Fax. #: 905-829-8050, Email: vic@ultratech-labs.com, Website: <http://www.ultratech-labs.com>

File #: KT1-026FCC90
June 5, 2003

- All test results contained in this engineering test report are traceable to National Institute of Standards and Technology (NIST)

Plot #28: Spurious Emissions Conducted @ 928 – 941 MHz Output with 1 RF Input signals
Fc: 928 MHz

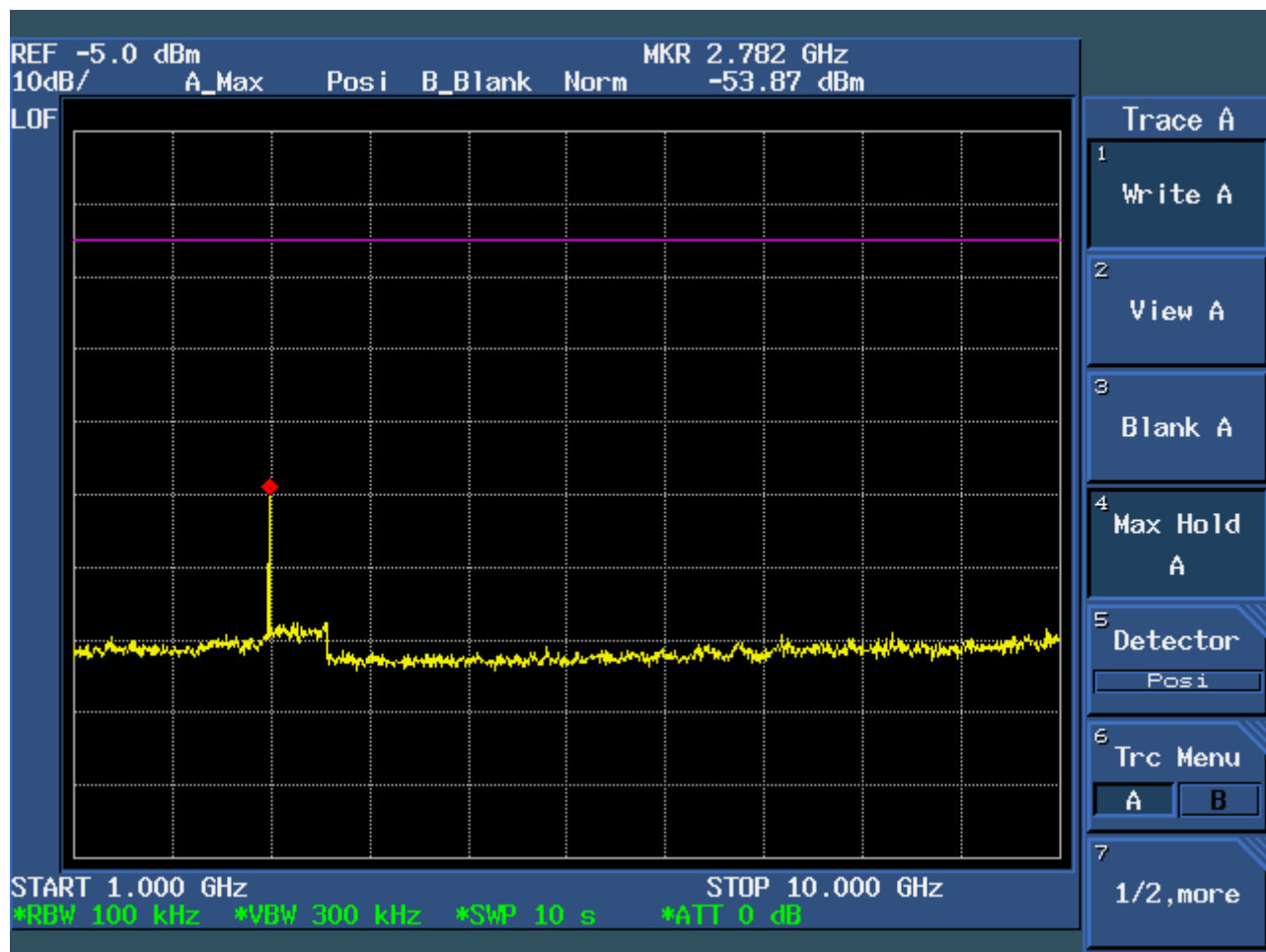

ULTRATECH GROUP OF LABS

3000 Bristol Circle, Oakville, Ontario, Canada L6H 6G4
Tel. #: 905-829-1570, Fax. #: 905-829-8050, Email: vic@ultratech-labs.com, Website: <http://www.ultratech-labs.com>

File #: KT1-026FCC90
June 5, 2003

- All test results contained in this engineering test report are traceable to National Institute of Standards and Technology (NIST)

Plot # 29: Spurious Emissions Conducted @ 928 – 941 MHz Output with 2 RF Input signals
Fc: 928 MHz, Fc + 12.5 kHz

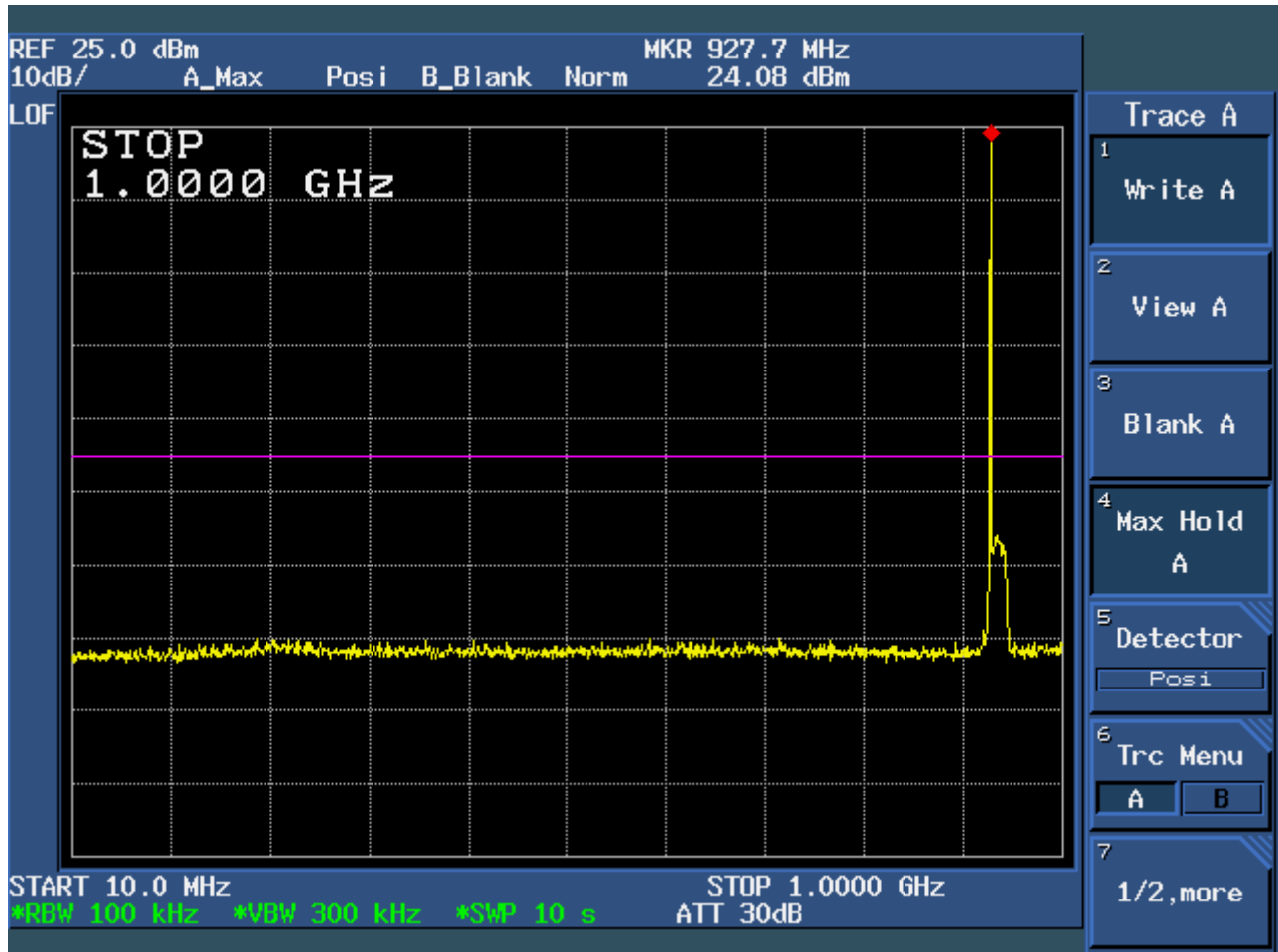

ULTRATECH GROUP OF LABS

3000 Bristol Circle, Oakville, Ontario, Canada L6H 6G4
Tel. #: 905-829-1570, Fax. #: 905-829-8050, Email: vic@ultratech-labs.com, Website: <http://www.ultratech-labs.com>

File #: KTI-026FCC90

June 5, 2003

- All test results contained in this engineering test report are traceable to National Institute of Standards and Technology (NIST)

Plot # 30: Spurious Emissions Conducted @ 928 – 941 MHz Output with 2 RF Input signals
Fc: 928 MHz, Fc + 12.5 kHz

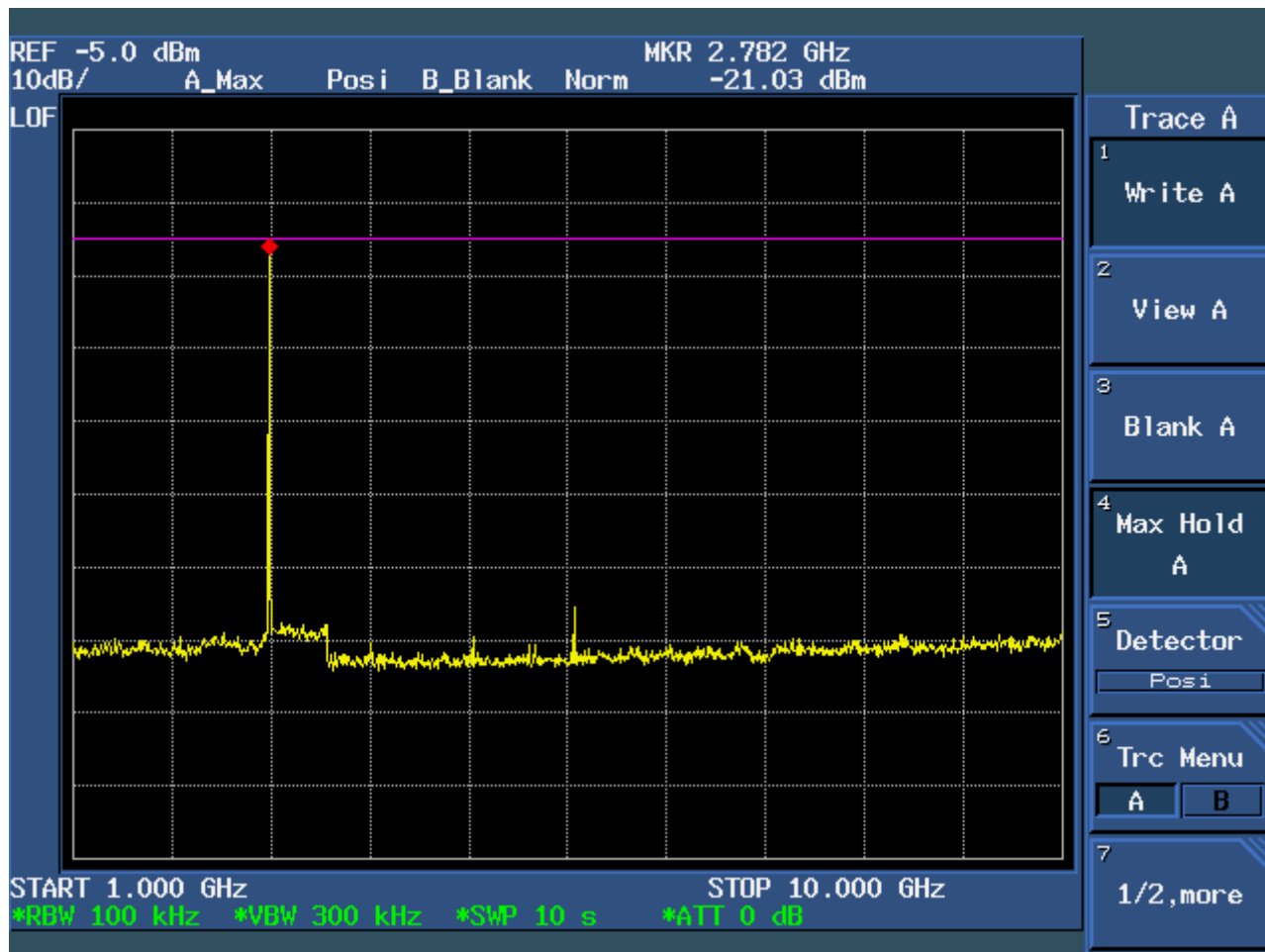

ULTRATECH GROUP OF LABS

3000 Bristol Circle, Oakville, Ontario, Canada L6H 6G4
Tel. #: 905-829-1570, Fax. #: 905-829-8050, Email: vic@ultratech-labs.com, Website: <http://www.ultratech-labs.com>

File #: KTI-026FCC90
June 5, 2003

- All test results contained in this engineering test report are traceable to National Institute of Standards and Technology (NIST)

Plot # 31: Spurious Emissions Conducted @ 928 – 941 MHz Output with 3 RF Input signals
Fc: 928 MHz, Fc + 12.5 kHz, & Fc + 25 kHz

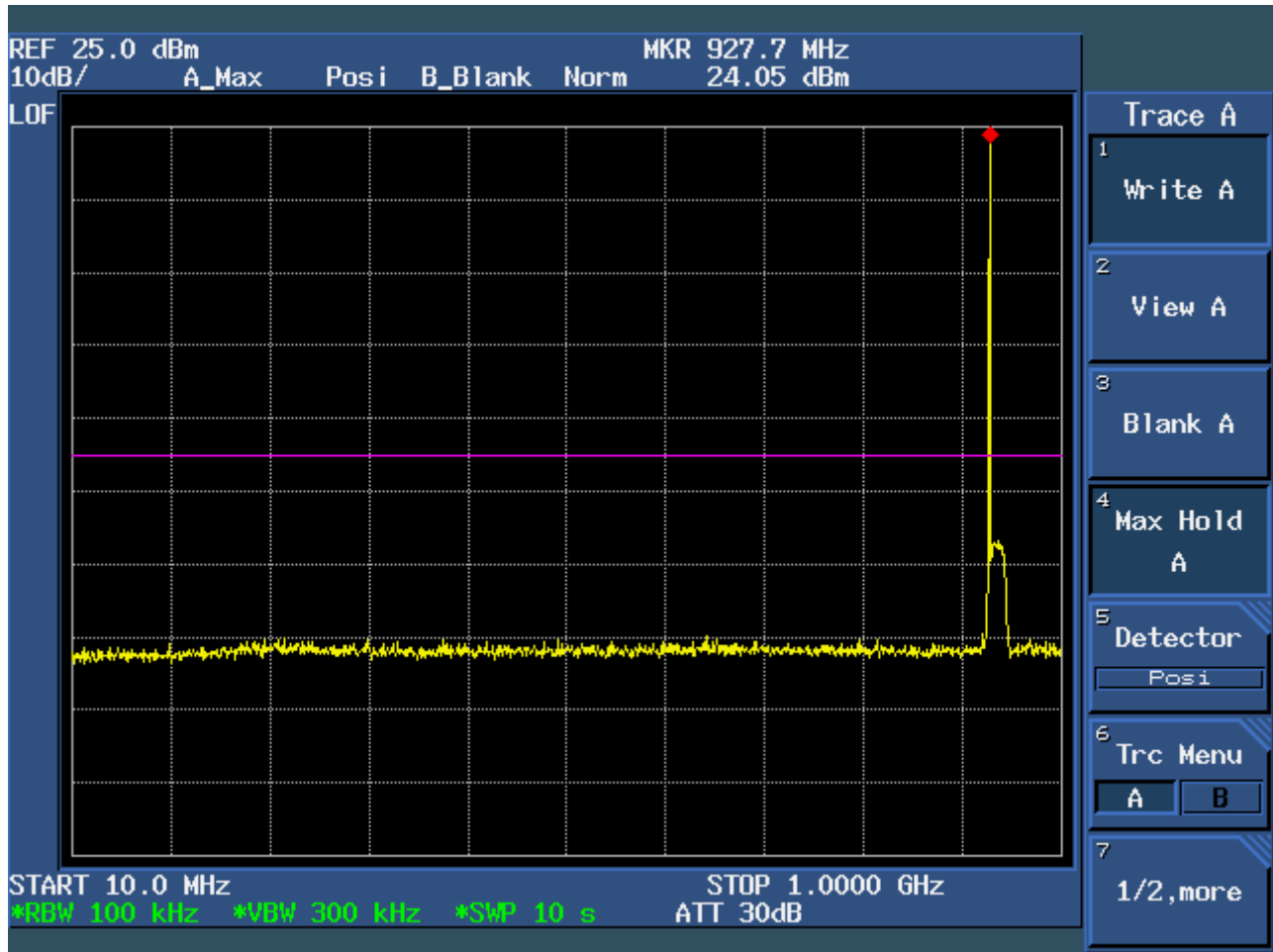

ULTRATECH GROUP OF LABS

3000 Bristol Circle, Oakville, Ontario, Canada L6H 6G4
Tel. #: 905-829-1570, Fax. #: 905-829-8050, Email: vic@ultratech-labs.com, Website: <http://www.ultratech-labs.com>

File #: KTI-026FCC90

June 5, 2003

- All test results contained in this engineering test report are traceable to National Institute of Standards and Technology (NIST)

Plot #32: Spurious Emissions Conducted @ 928 – 941 MHz Output with 3 RF Input signals
Fc: 928 MHz, Fc + 12.5 kHz, & Fc + 25 kHz

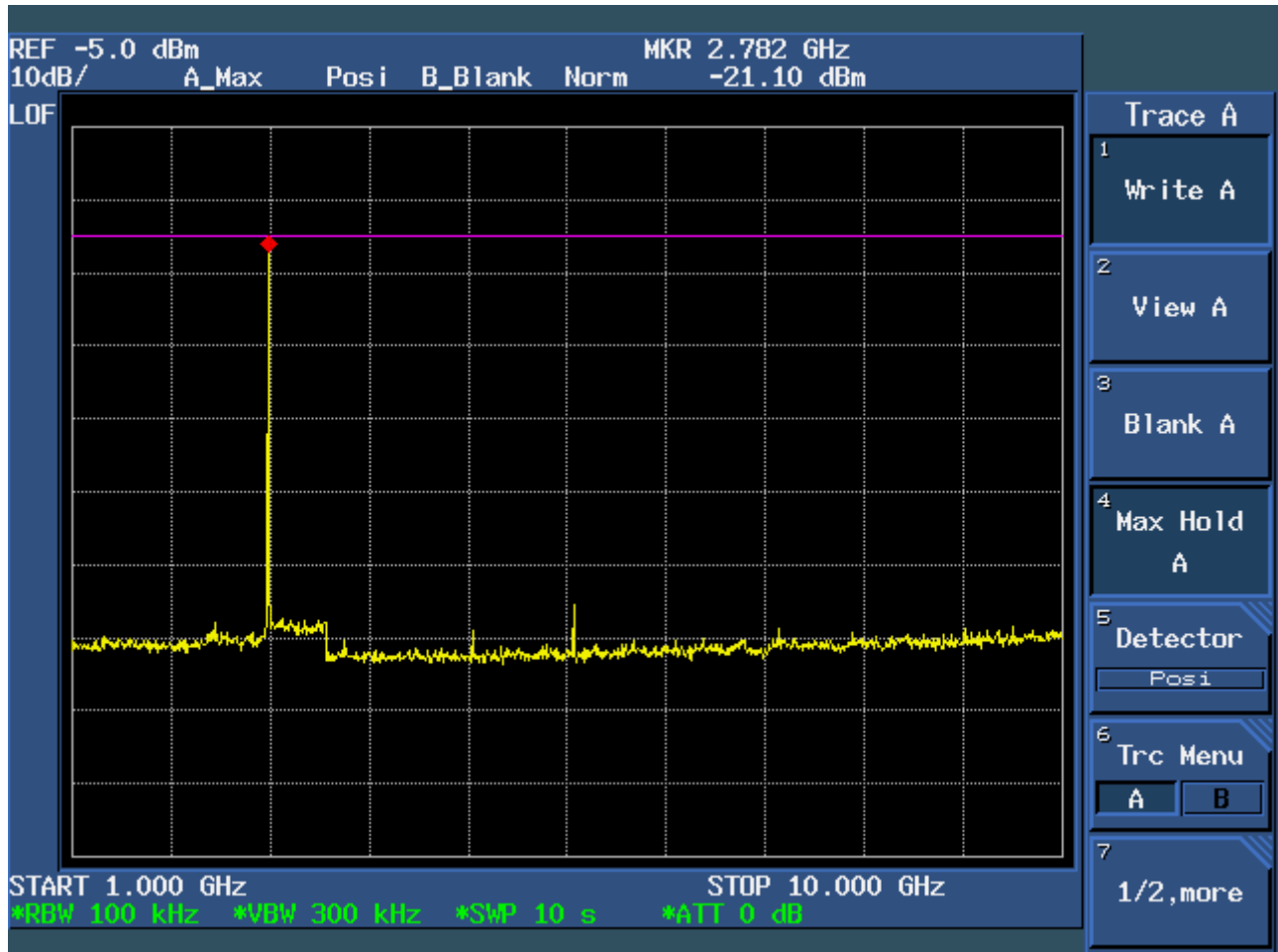

ULTRATECH GROUP OF LABS

3000 Bristol Circle, Oakville, Ontario, Canada L6H 6G4
Tel. #: 905-829-1570, Fax. #: 905-829-8050, Email: vic@ultratech-labs.com, Website: <http://www.ultratech-labs.com>

File #: KTI-026FCC90
June 5, 2003

- All test results contained in this engineering test report are traceable to National Institute of Standards and Technology (NIST)

Plot # 33: Spurious Emissions Conducted @ 928 – 941 MHz Output with 1 RF Input signals
Fc: 934.5 MHz

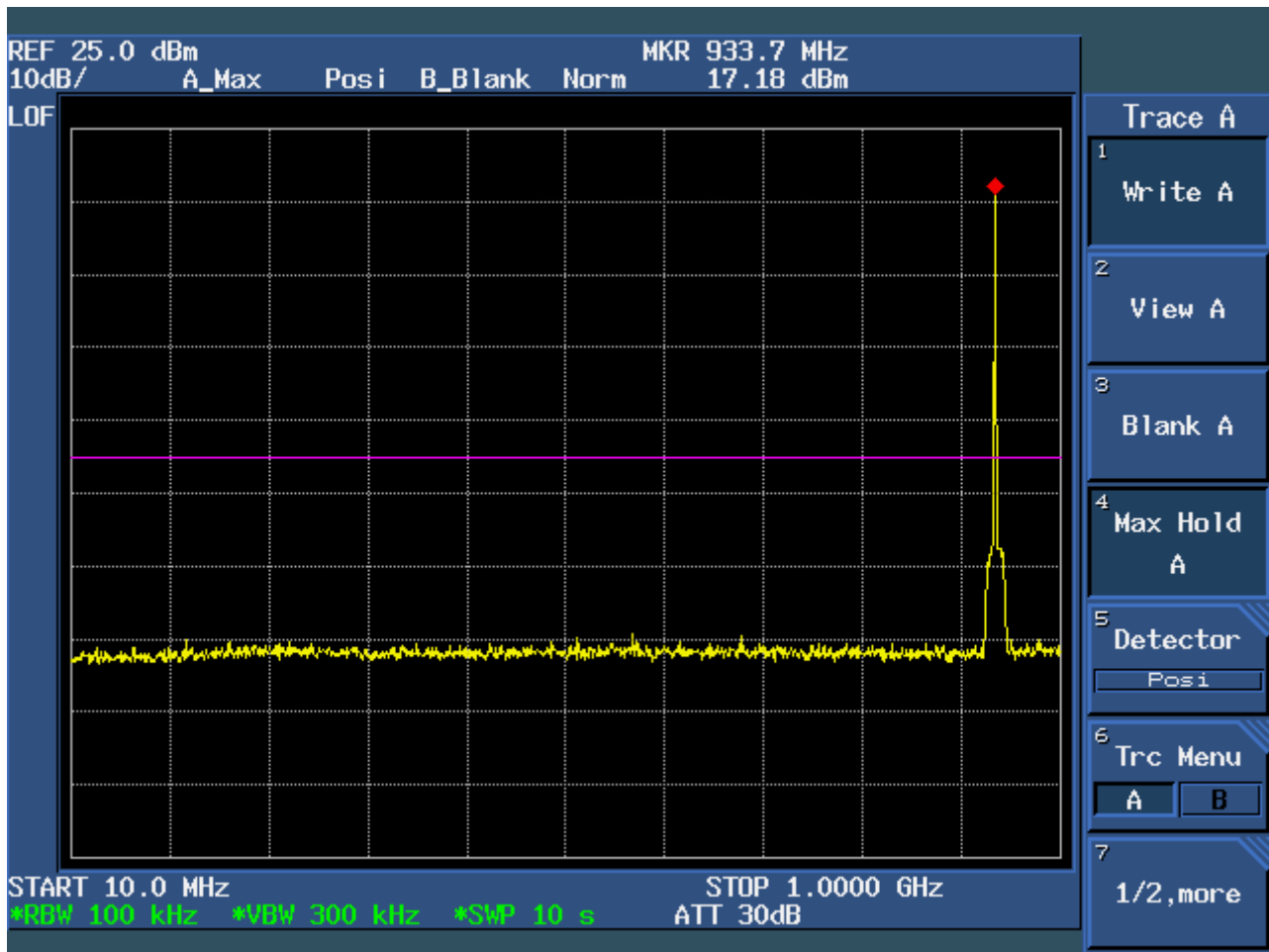

ULTRATECH GROUP OF LABS

3000 Bristol Circle, Oakville, Ontario, Canada L6H 6G4
Tel. #: 905-829-1570, Fax. #: 905-829-8050, Email: vic@ultratech-labs.com, Website: <http://www.ultratech-labs.com>

File #: KTI-026FCC90
June 5, 2003

- All test results contained in this engineering test report are traceable to National Institute of Standards and Technology (NIST)

Plot # 34: Spurious Emissions Conducted @ 928 – 941 MHz Output with 1 RF Input signals
Fc: 934.5 MHz

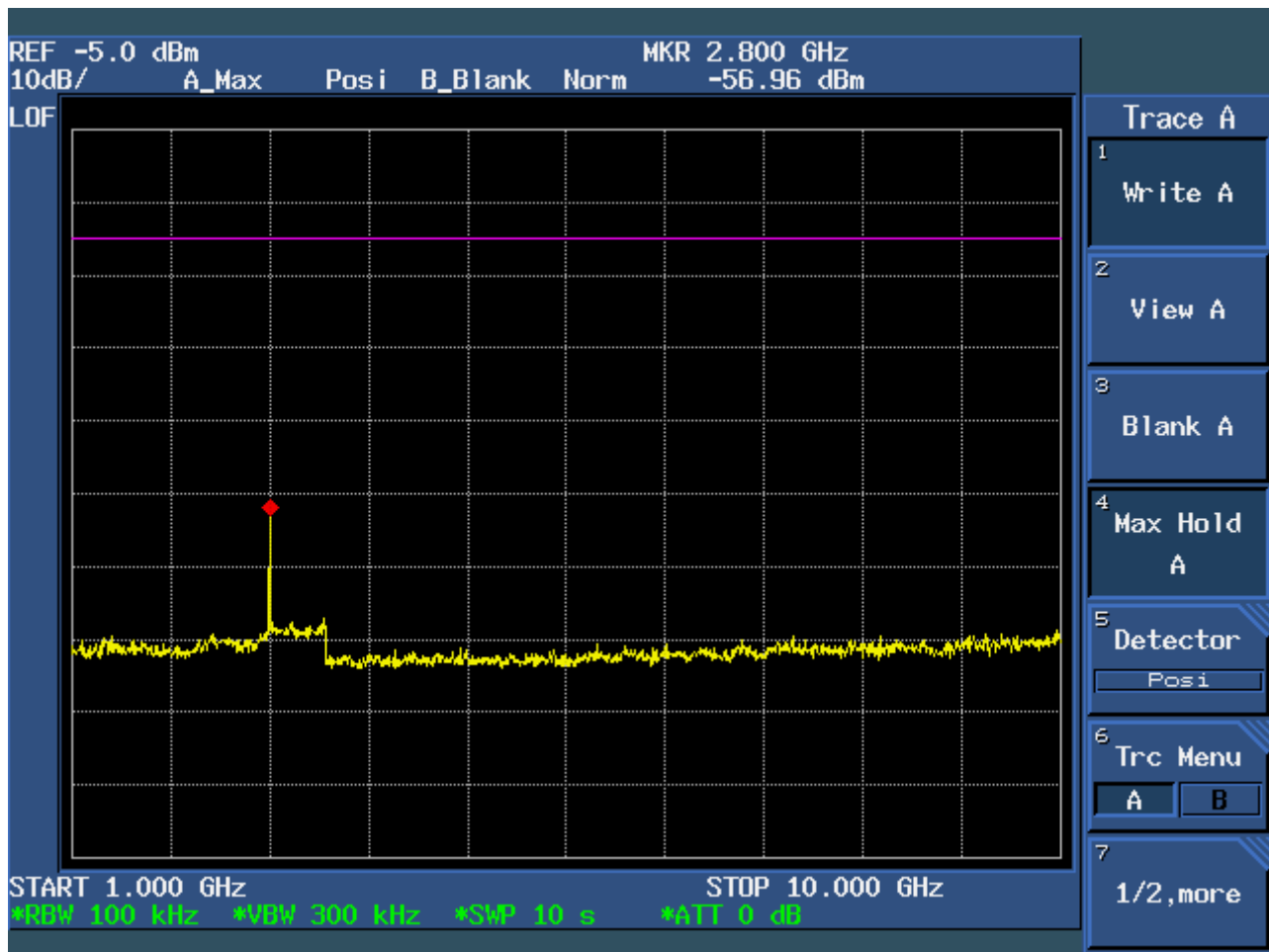

ULTRATECH GROUP OF LABS

3000 Bristol Circle, Oakville, Ontario, Canada L6H 6G4
Tel. #: 905-829-1570, Fax. #: 905-829-8050, Email: vic@ultratech-labs.com, Website: <http://www.ultratech-labs.com>

File #: KTI-026FCC90

June 5, 2003

- All test results contained in this engineering test report are traceable to National Institute of Standards and Technology (NIST)

Plot # 35: Spurious Emissions Conducted @ 928 – 941 MHz Output with 2 RF Input signals
Fc: 934.5 MHz, Fc + 12.5 kHz

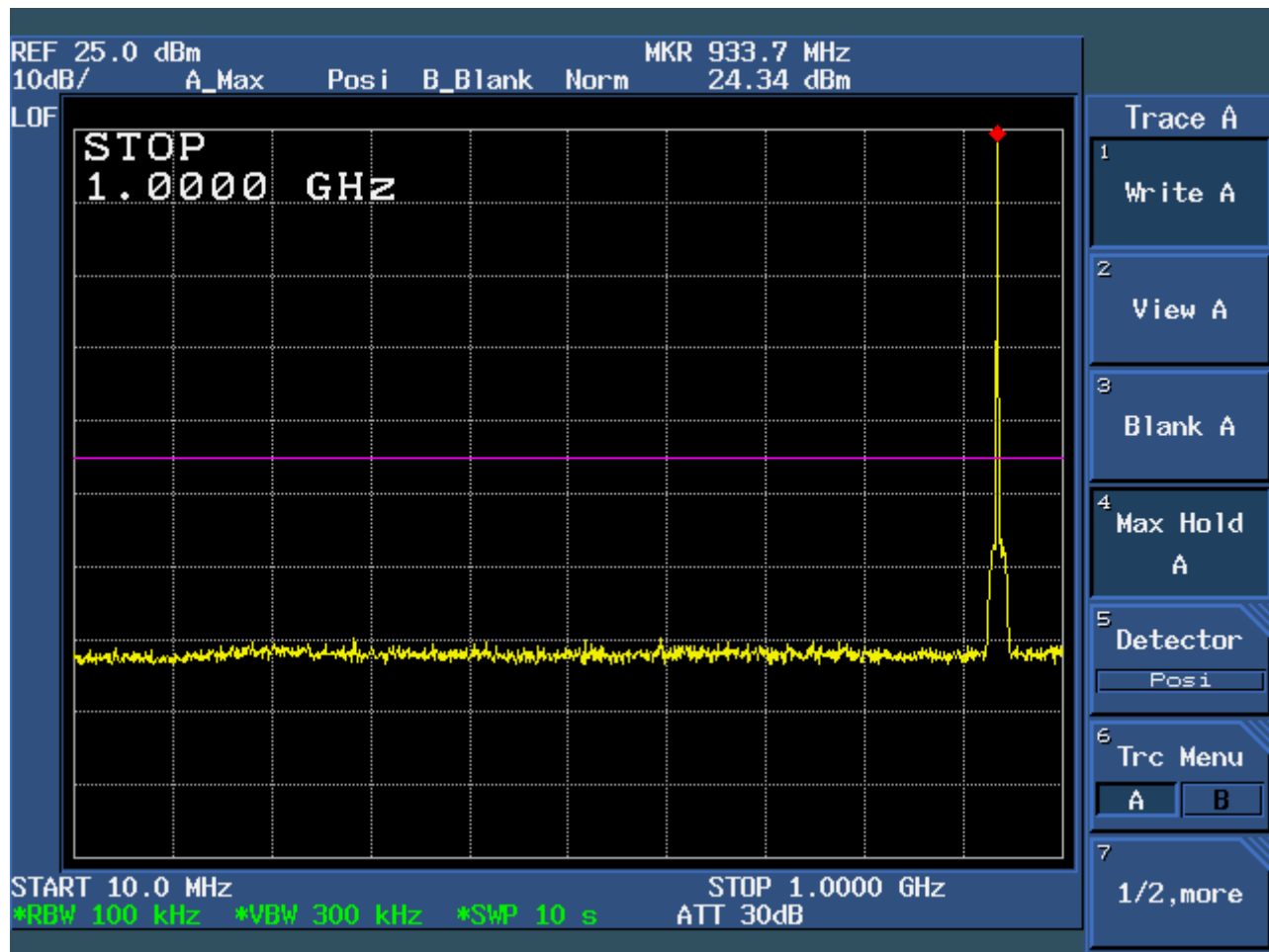

ULTRATECH GROUP OF LABS

3000 Bristol Circle, Oakville, Ontario, Canada L6H 6G4
Tel. #: 905-829-1570, Fax. #: 905-829-8050, Email: vic@ultratech-labs.com, Website: <http://www.ultratech-labs.com>

File #: KT1-026FCC90
June 5, 2003

- All test results contained in this engineering test report are traceable to National Institute of Standards and Technology (NIST)

Plot # 36: Spurious Emissions Conducted @ 928 – 941 MHz Output with 2 RF Input signals
Fc: 934.5 MHz, Fc + 12.5 kHz

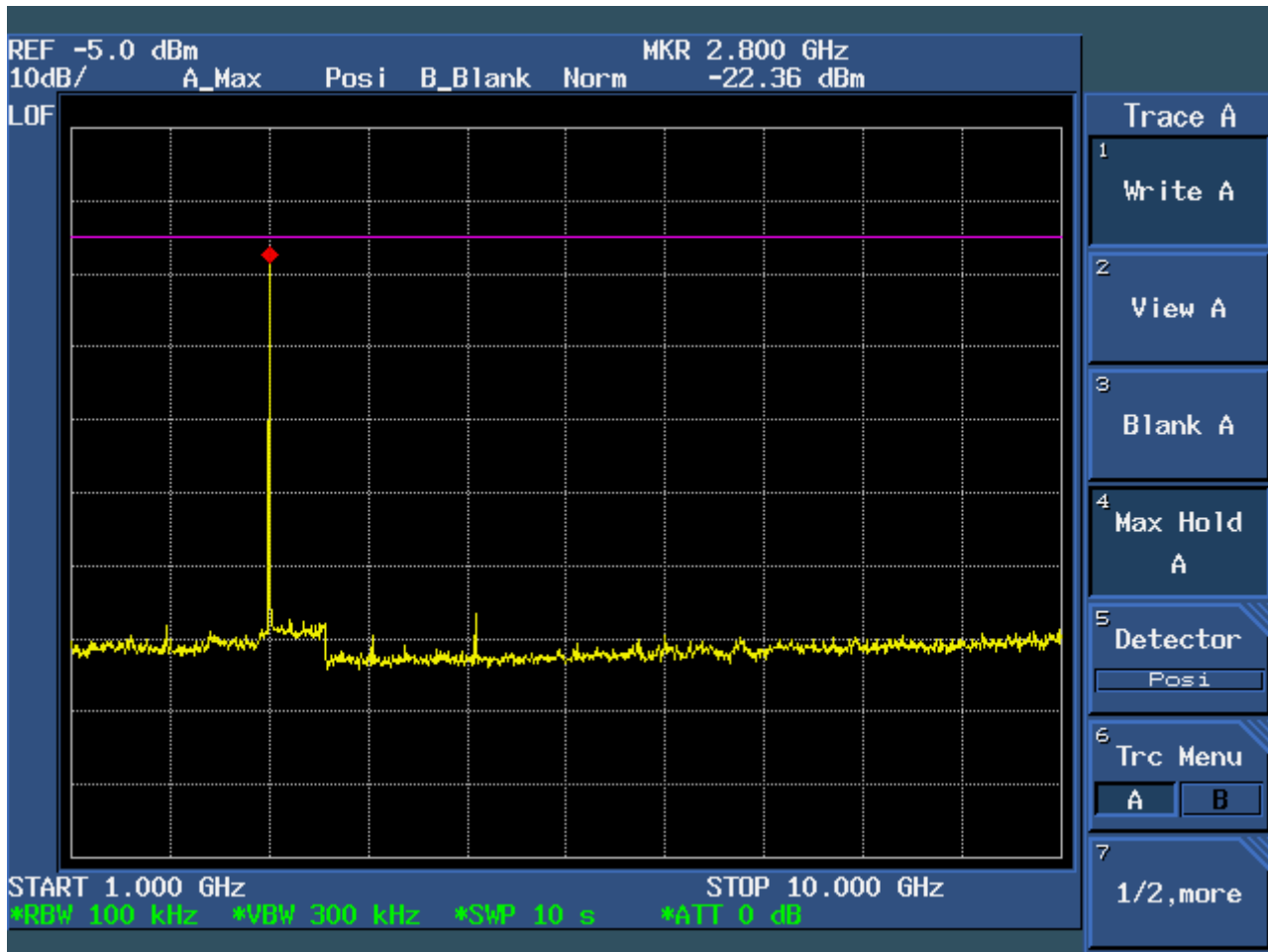

ULTRATECH GROUP OF LABS

3000 Bristol Circle, Oakville, Ontario, Canada L6H 6G4
Tel. #: 905-829-1570, Fax. #: 905-829-8050, Email: vic@ultratech-labs.com, Website: <http://www.ultratech-labs.com>

File #: KT1-026FCC90
June 5, 2003

- All test results contained in this engineering test report are traceable to National Institute of Standards and Technology (NIST)

Plot # 37: Spurious Emissions Conducted @ 928 – 941 MHz Output with 3 RF Input signals
Fc: 934.5 MHz, Fc + 12.5 kHz, & Fc – 12.5 kHz

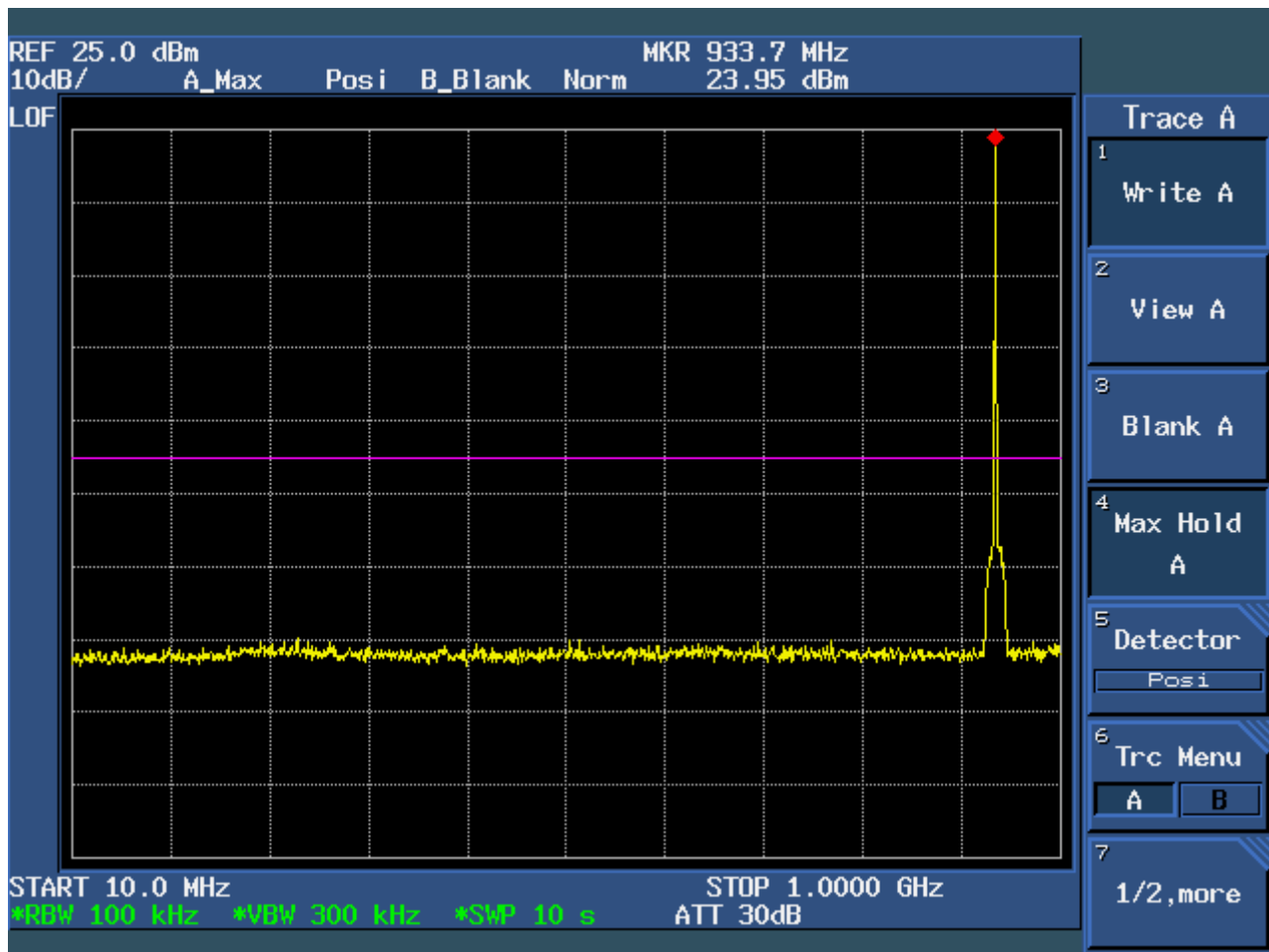

ULTRATECH GROUP OF LABS

3000 Bristol Circle, Oakville, Ontario, Canada L6H 6G4
Tel. #: 905-829-1570, Fax. #: 905-829-8050, Email: vic@ultratech-labs.com, Website: <http://www.ultratech-labs.com>

File #: KT1-026FCC90

June 5, 2003

- All test results contained in this engineering test report are traceable to National Institute of Standards and Technology (NIST)

Plot # 38: Spurious Emissions Conducted @ 928 – 941 MHz Output with 3 RF Input signals
Fc: 934.5 MHz, Fc + 12.5 kHz, & Fc – 12.5 kHz

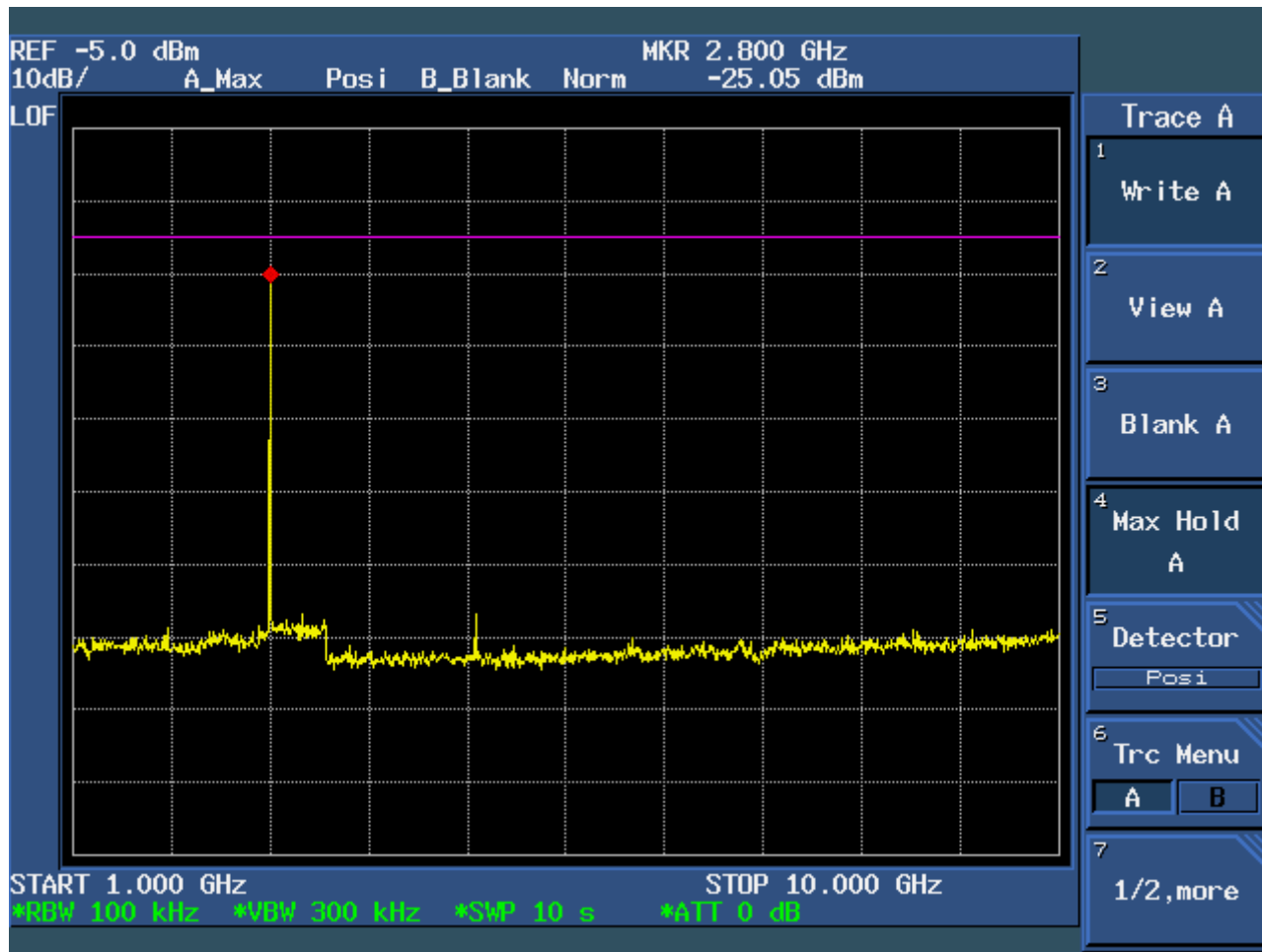

ULTRATECH GROUP OF LABS

3000 Bristol Circle, Oakville, Ontario, Canada L6H 6G4
Tel. #: 905-829-1570, Fax. #: 905-829-8050, Email: vic@ultratech-labs.com, Website: <http://www.ultratech-labs.com>

File #: KT1-026FCC90
June 5, 2003

- All test results contained in this engineering test report are traceable to National Institute of Standards and Technology (NIST)

Plot # 39: Spurious Emissions Conducted @ 928 – 941 MHz Output with 1 RF Input signals
Fc: 941 MHz

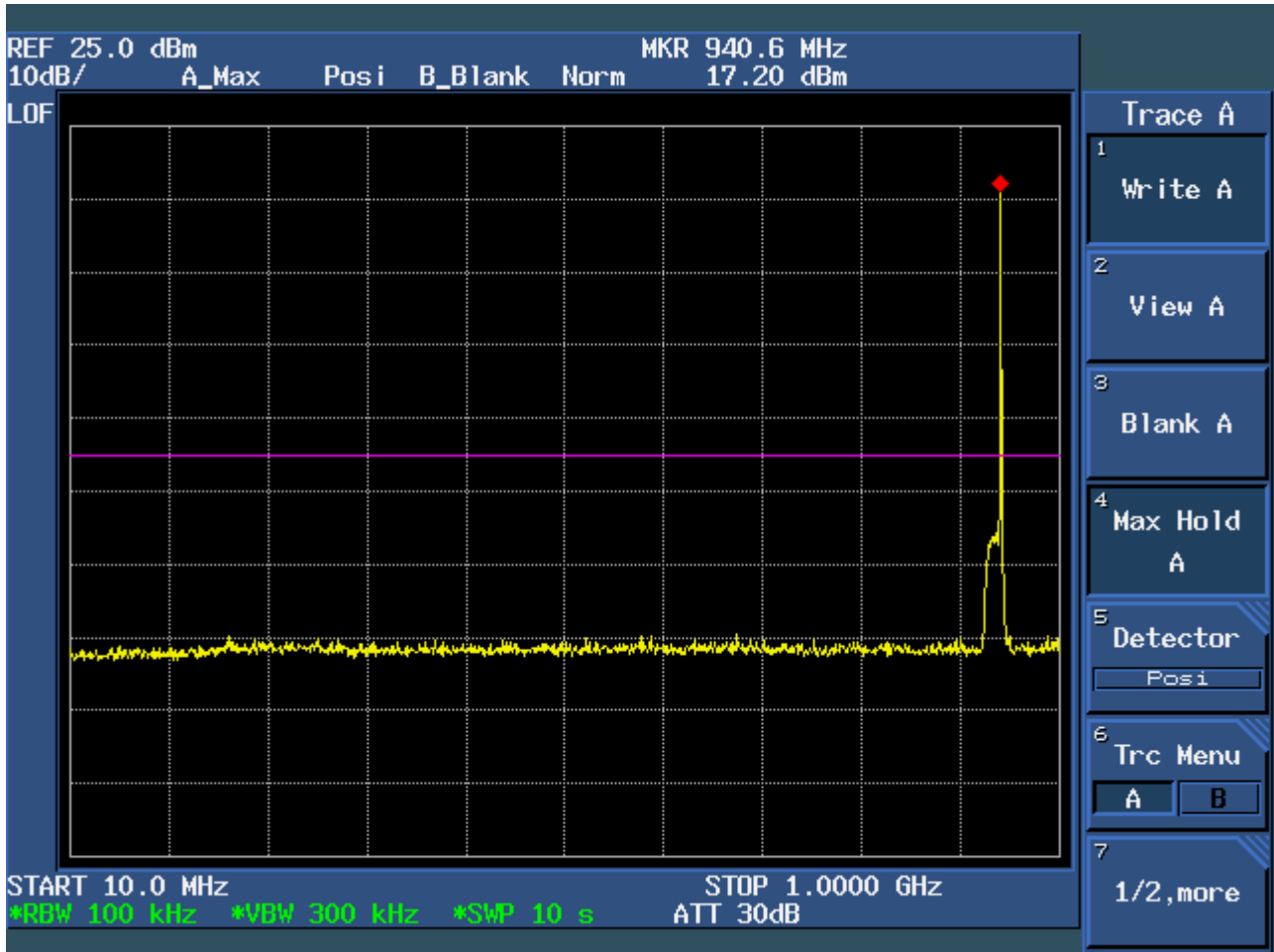

ULTRATECH GROUP OF LABS

3000 Bristol Circle, Oakville, Ontario, Canada L6H 6G4
Tel. #: 905-829-1570, Fax. #: 905-829-8050, Email: vic@ultratech-labs.com, Website: <http://www.ultratech-labs.com>

File #: KT1-026FCC90

June 5, 2003

- All test results contained in this engineering test report are traceable to National Institute of Standards and Technology (NIST)

**Plot # 40: Spurious Emissions Conducted @ 928 – 941 MHz Output with 1 RF Input signals
Fc: 941 MHz**

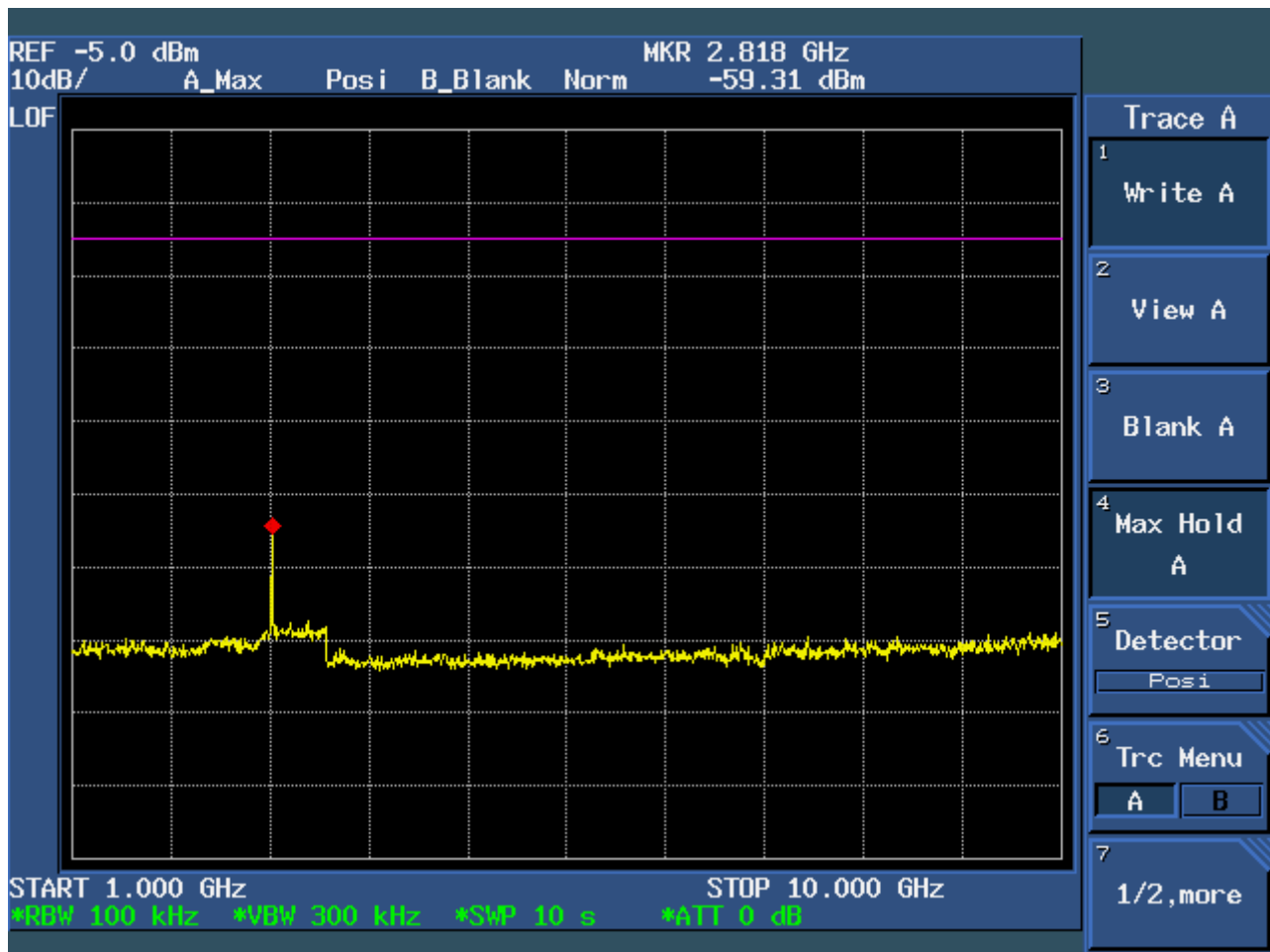

ULTRATECH GROUP OF LABS

3000 Bristol Circle, Oakville, Ontario, Canada L6H 6G4
Tel. #: 905-829-1570, Fax. #: 905-829-8050, Email: vic@ultratech-labs.com, Website: <http://www.ultratech-labs.com>

File #: KT1-026FCC90
June 5, 2003

- All test results contained in this engineering test report are traceable to National Institute of Standards and Technology (NIST)

Plot # 41: Spurious Emissions Conducted @ 928 – 941 MHz Output with 2 RF Input signals
Fc: 941 MHz, Fc - 12.5 kHz

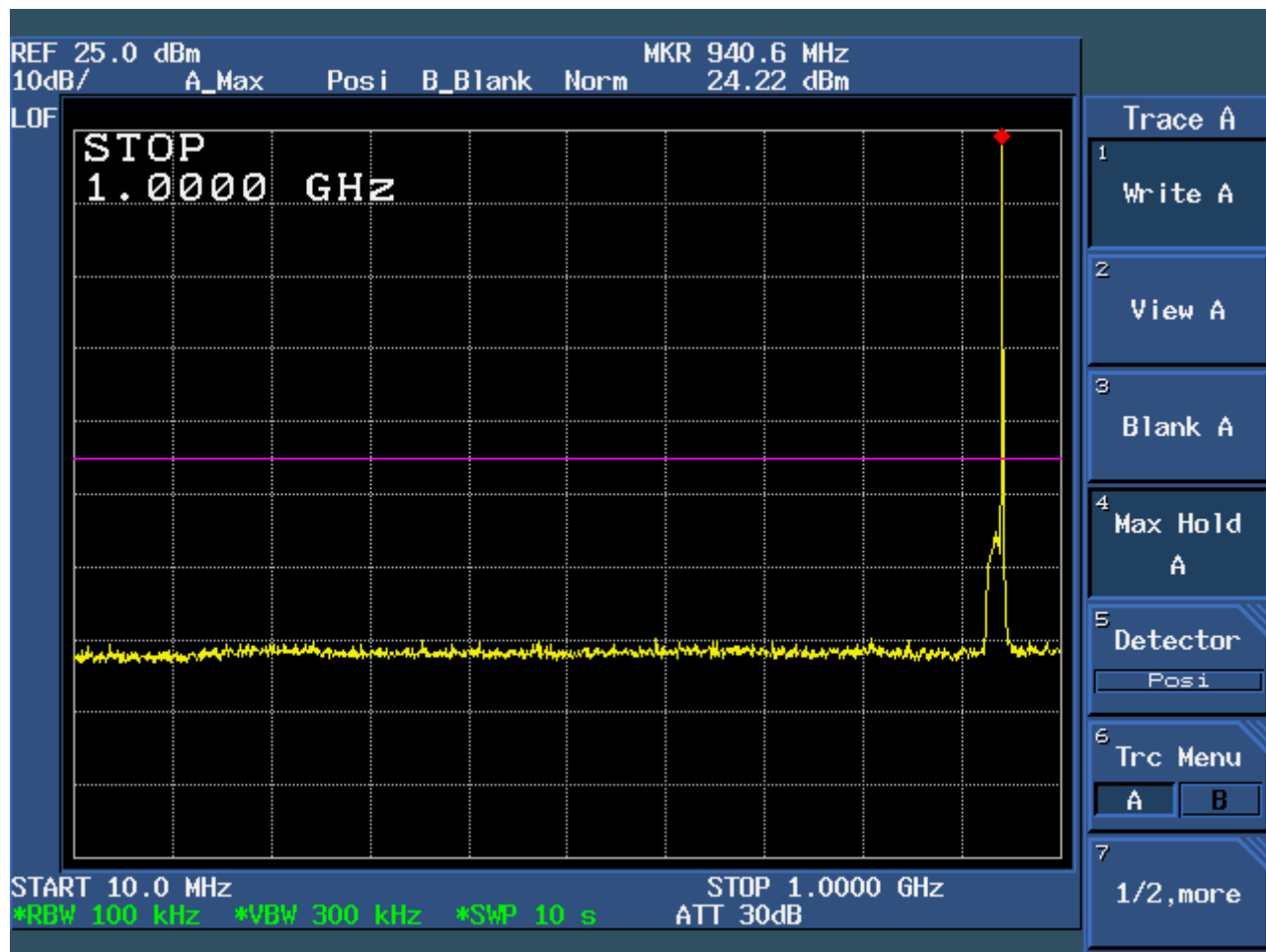

ULTRATECH GROUP OF LABS

3000 Bristol Circle, Oakville, Ontario, Canada L6H 6G4
Tel. #: 905-829-1570, Fax. #: 905-829-8050, Email: vic@ultratech-labs.com, Website: <http://www.ultratech-labs.com>

File #: KTI-026FCC90
June 5, 2003

- All test results contained in this engineering test report are traceable to National Institute of Standards and Technology (NIST)

Plot # 42: Spurious Emissions Conducted @ 928 – 941 MHz Output with 2 RF Input signals
Fc: 941 MHz, Fc - 12.5 kHz

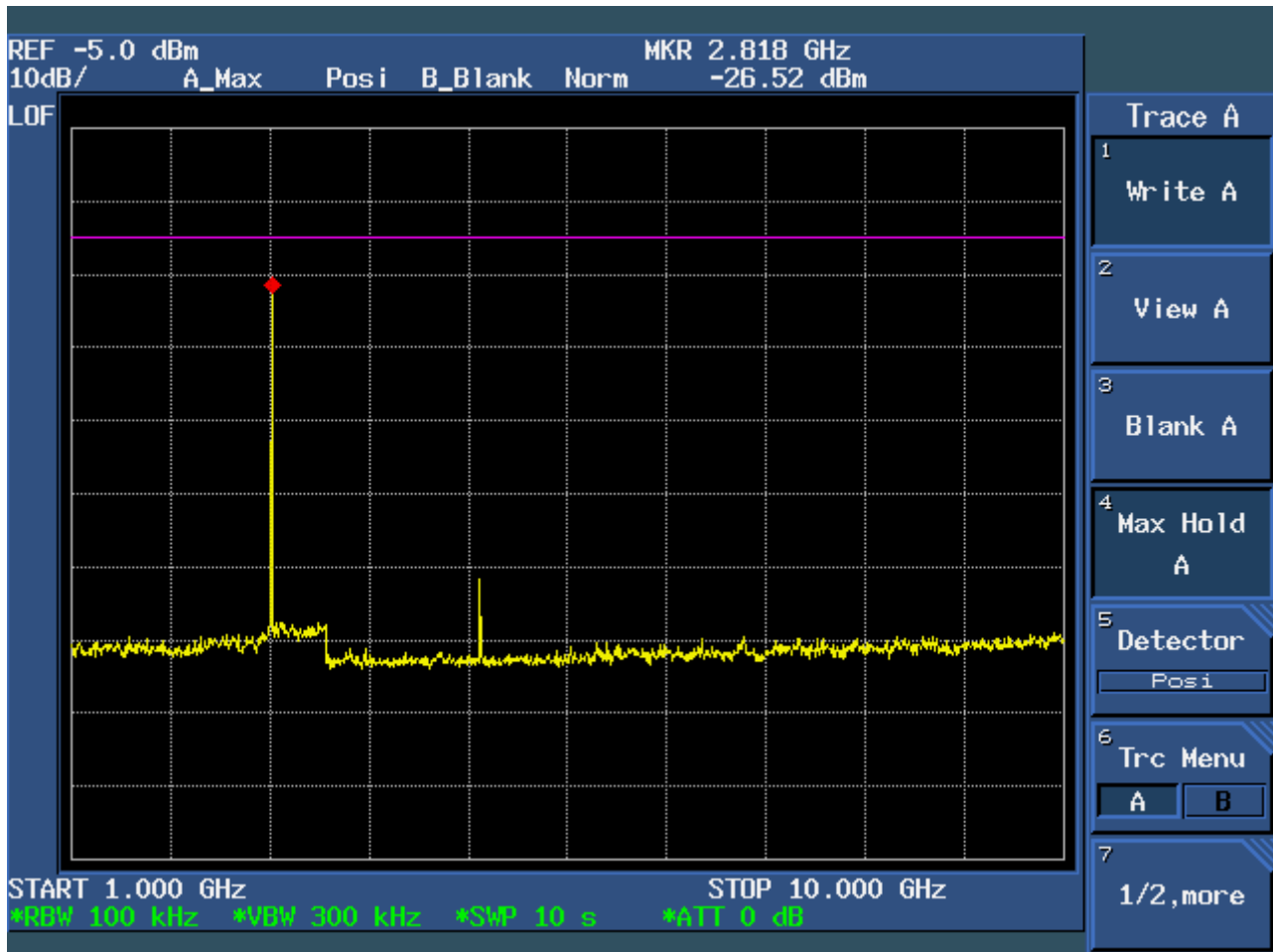

ULTRATECH GROUP OF LABS

3000 Bristol Circle, Oakville, Ontario, Canada L6H 6G4
Tel. #: 905-829-1570, Fax. #: 905-829-8050, Email: vic@ultratech-labs.com, Website: <http://www.ultratech-labs.com>

File #: KT1-026FCC90

June 5, 2003

- All test results contained in this engineering test report are traceable to National Institute of Standards and Technology (NIST)

Plot #43: Spurious Emissions Conducted @ 928 – 941 MHz Output with 3 RF Input signals
Fc: 941 MHz, Fc - 25 kHz, & Fc - 12.5 kHz

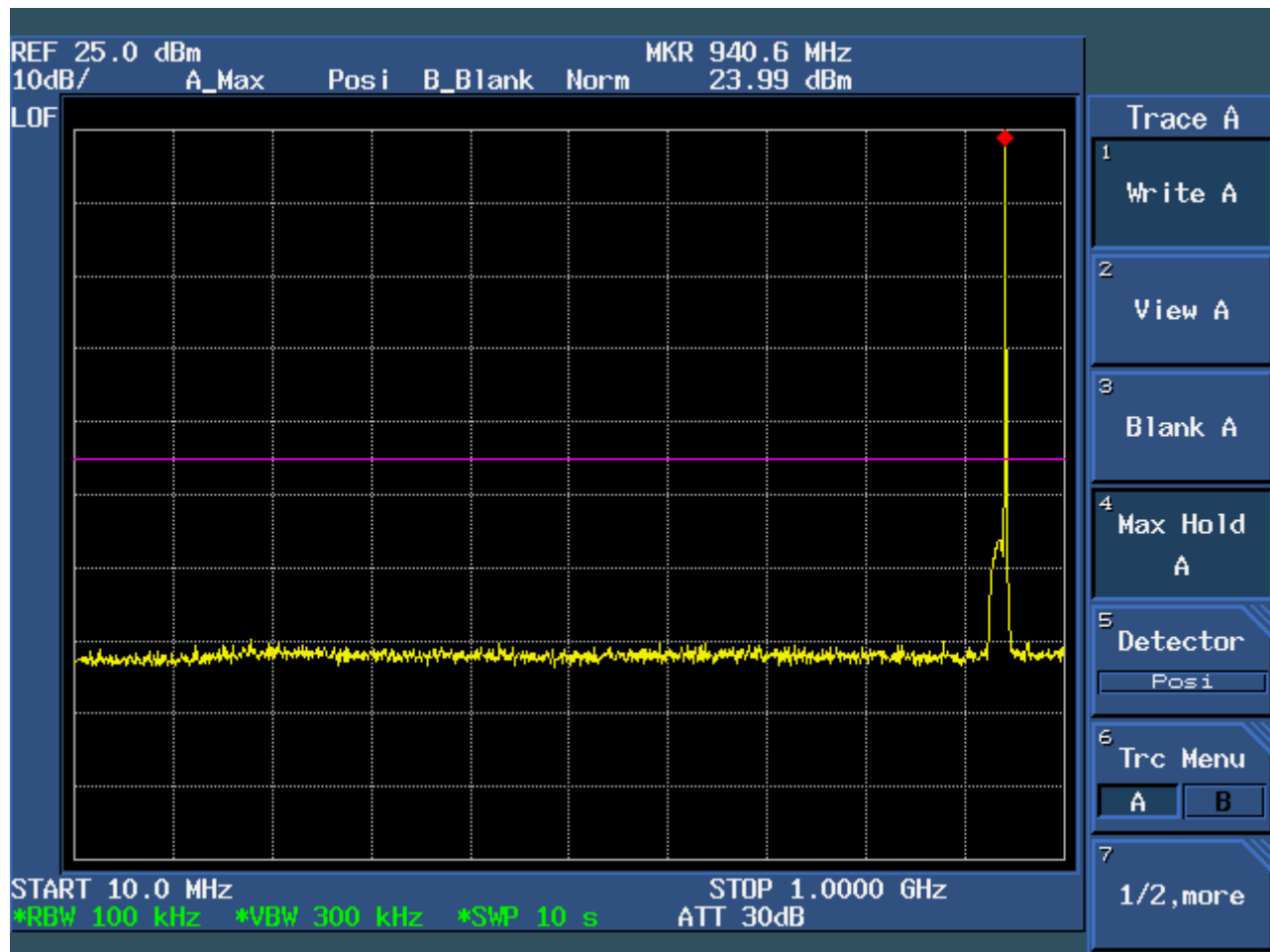

ULTRATECH GROUP OF LABS

3000 Bristol Circle, Oakville, Ontario, Canada L6H 6G4
Tel. #: 905-829-1570, Fax. #: 905-829-8050, Email: vic@ultratech-labs.com, Website: <http://www.ultratech-labs.com>

File #: KTI-026FCC90
June 5, 2003

- All test results contained in this engineering test report are traceable to National Institute of Standards and Technology (NIST)

Plot # 44: Spurious Emissions Conducted @ 928 – 941 MHz Output with 3 RF Input signals
Fc: 941 MHz, Fc - 25 kHz, & Fc – 12.5 kHz

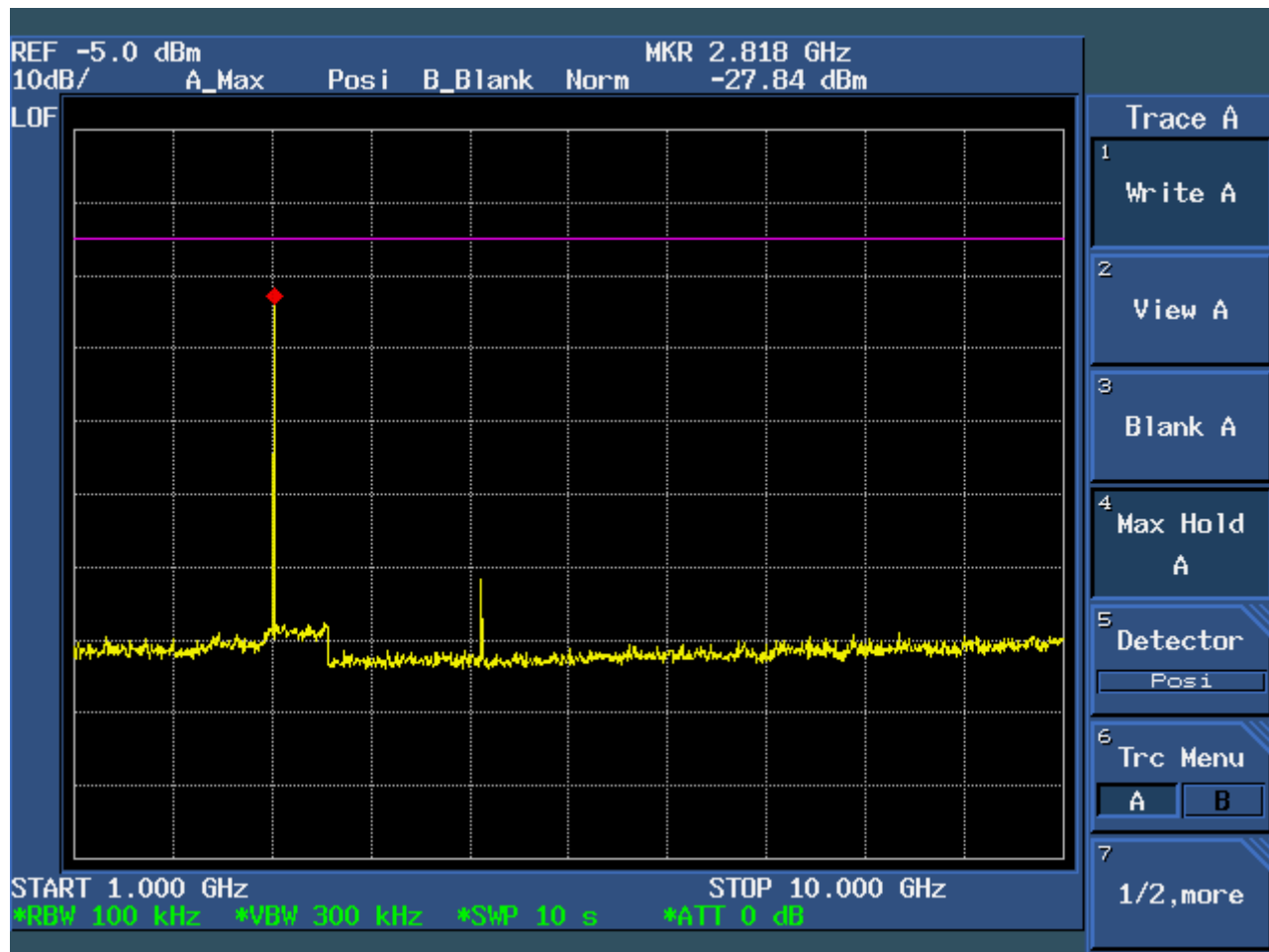

ULTRATECH GROUP OF LABS

3000 Bristol Circle, Oakville, Ontario, Canada L6H 6G4
Tel. #: 905-829-1570, Fax. #: 905-829-8050, Email: vic@ultratech-labs.com, Website: <http://www.ultratech-labs.com>

File #: KTI-026FCC90
June 5, 2003

- All test results contained in this engineering test report are traceable to National Institute of Standards and Technology (NIST)

6.9. TRANSMITTER SPURIOUS/HARMONIC RADIATED EMISSIONS @ FCC 90.210

6.9.1. Limits @ 90.210

Emissions shall be attenuated below the mean output power of the transmitter as follows:

FCC Rules	Frequency Range	Attenuation Limit (dBc)
90.210(b)(g)	929-930	43 + 10log(P in Watt)
90210(i)(j)	935-940	50 + 10log(P in Watts)

6.9.2. Method of Measurements

Refer to Exhibit 8 § 8.2 of this report for measurement details

The spurious/harmonic ERP measurements are using substitution method specified in Exhibit 8, § 8.2 of this report and its value in dBc is calculated as follows:

- (1) If the transmitter's antenna is an integral part of the EUT, the ERP is measured using substitution method.
- (2) If the transmitter's antenna is non-integral and diverse, the lowest ERP of the carrier with 0 dBi antenna gain is used for calculation of the spurious/harmonic emissions in dBc:
 Lowest ERP of the carrier = EIRP – 2.15 dB = Pc + G - 2.15 dB = xxx dBm (conducted) + 0 dBi – 2.15 dB
- (3) Spurious /harmonic emissions levels expressed in dBc (dB below carrier) are as follows:

$$\text{ERP of spurious/harmonic (dBc)} = \text{ERP of carrier (dBm)} - \text{ERP of spurious/harmonic emission (dBm)}$$

6.9.3. Test Equipment List

Test Instruments	Manufacturer	Model No.	Serial No.	Frequency Range
Spectrum Analyzer/ EMI Receiver	Advantest	R3271	15050203	100 Hz to 32 GHz with external mixer for frequency above 32 GHz
Microwave Amplifier	Hewlett Packard	HP 83017A	3116A00661	1 GHz to 26.5 GHz
Active Loop Antenna	EMCO	6507	8906-1167	1 kHz – 30 MHz
Biconilog Antenna	EMCO	3143	1029	20 MHz to 2 GHz
Horn Antenna	EMCO	3155	9701-5061	1 GHz – 18 GHz

6.9.4. Photographs of Test Setup

Please refer to Photos # 1 and 2 in Annex 1 for detailed information of the test setup

ULTRATECH GROUP OF LABS

3000 Bristol Circle, Oakville, Ontario, Canada L6H 6G4
 Tel. #: 905-829-1570, Fax. #: 905-829-8050, Email: vic@ultratech-labs.com, Website: <http://www.ultratech-labs.com>

File #: KT1-026FCC90
 June 5, 2003

- All test results contained in this engineering test report are traceable to National Institute of Standards and Technology (NIST)

6.9.5. Test Data

Remarks: Since the Transmitter Spurious Conducted Emissions in earlier section shows the test configuration of 2unmodulated input/output channels as the worst results. Therefore, the radiated emissions will be performed with this test configuration as worst case.

6.9.5.1.1. Downlink Band 928 - 941 MHz: Test Frequencies: 928 & 928.0125 MHz, Modulation: unmodulated (for worst case)

Fundamental Frequency: 928 MHz (single channel input/output)					
RF Input Power: -7.2 dBm					
RF Output Power: +17 dBm as maximum rated by the manufacturer					
Modulation: unmodulated					
FREQUENCY (MHz)	TRANSMITTER CONDUCTED ANTENNA EMISSIONS		LIMIT (dBc)	MARGIN (dB)	PASS/ FAIL
	(dBm)	(dBc)			
10 – 10000	**	***	-36.3	**	PASS
<ul style="list-style-type: none"> The emissions were scanned at 3 meters from 10 MHz to 10 GHz and no spurious emissions less than 40 dB below the limits were found. 					

6.9.5.1.2. Downlink Band 928 - 941 MHz: Test Frequencies: 934.5 & 934.5125 MHz Modulation: unmodulated (for worst case)

Fundamental Frequencies: 934.5 & 934.5.0125 MHz (2 channel inputs/outputs)					
RF Input Power: -8.8 dBm/channel as maximum rated by the manufacturer					
RF Output Power: +18 dBm/channel or +24.3 dBm (total power of 2 channels)					
Modulation: unmodulated					
FREQUENCY (MHz)	TRANSMITTER CONDUCTED ANTENNA EMISSIONS		LIMIT (dBc)	MARGIN (dB)	PASS/ FAIL
	(dBm)	(dBc)			
10 – 10000	**	***	-37.1	**	PASS
<ul style="list-style-type: none"> The emissions were scanned at 3 meters from 10 MHz to 10 GHz and no spurious emissions less than 40 dB below the limits were found. 					

6.9.5.1.3. Downlink Band 928 - 941 MHz: Test Frequencies: 940.9875 & 941 MHz, Modulation: unmodulated (for worst case)

Fundamental Frequencies: 940.9875 & 941 MHz (2 channel inputs/outputs)					
RF Input Power: -7.3 dBm/channel as maximum rated by the manufacturer					
RF Output Power: +18 dBm/channel or +24.2 dBm (total power of 2 channels)					
Modulation: unmodulated					
FREQUENCY (MHz)	TRANSMITTER CONDUCTED ANTENNA EMISSIONS		LIMIT (dBc)	MARGIN (dB)	PASS/ FAIL
	(dBm)	(dBc)			
10 – 10000	**	***	-37.4	**	PASS
<ul style="list-style-type: none"> The emissions were scanned at 3 meters from 10 MHz to 10 GHz and no spurious emissions less than 40 dB below the limits were found. 					

EXHIBIT 7. MEASUREMENT UNCERTAINTY

The measurement uncertainties stated were calculated in accordance with the requirements of NIST Technical Note 1297 and NIS 81 (1994)

7.1. RADIATED EMISSION MEASUREMENT UNCERTAINTY

CONTRIBUTION (Radiated Emissions)	PROBABILITY DISTRIBUTION	UNCERTAINTY (+ dB)	
		3 m	10 m
Antenna Factor Calibration	Normal (k=2)	± 1.0	± 1.0
Cable Loss Calibration	Normal (k=2)	± 0.3	± 0.5
EMI Receiver specification	Rectangular	± 1.5	± 1.5
Antenna Directivity	Rectangular	+0.5	+0.5
Antenna factor variation with height	Rectangular	± 2.0	± 0.5
Antenna phase center variation	Rectangular	0.0	± 0.2
Antenna factor frequency interpolation	Rectangular	± 0.25	± 0.25
Measurement distance variation	Rectangular	± 0.6	± 0.4
Site imperfections	Rectangular	± 2.0	± 2.0
Mismatch: Receiver VRC $\Gamma_1 = 0.2$ Antenna VRC $\Gamma_R = 0.67(Bi) 0.3 (Lp)$ Uncertainty limits $20\text{Log}(1 \pm \Gamma_1 \Gamma_R)$	U-Shaped	+1.1 -1.25	± 0.5
System repeatability	Std. Deviation	± 0.5	± 0.5
Repeatability of EUT		-	-
Combined standard uncertainty	Normal	+2.19 / -2.21	+1.74 / -1.72
Expanded uncertainty U	Normal (k=2)	+4.38 / -4.42	+3.48 / -3.44

Calculation for maximum uncertainty when 3m biconical antenna including a factor of k=2 is used:

$$U = 2u_c(y) = 2x(+2.19) = +4.38 \text{ dB} \quad \text{And} \quad U = 2u_c(y) = 2x(-2.21) = -4.42 \text{ dB}$$

EXHIBIT 8. MEASUREMENT METHODS

8.1. CONDUCTED POWER MEASUREMENTS

- The following shall be applied to the combination(s) of the radio device and its intended antenna(e).
- If the RF level is user adjustable, all measurements shall be made with the highest power level available to the user for that combination.
- The following method of measurement shall apply to both conducted and radiated measurements.
- The radiated measurements are performed at the Ultratech Calibrated Open Field Test Site.
- The measurement shall be performed using normal operation of the equipment with modulation.

Test procedure shall be as follows:

Step 1: Duty Cycle measurements if the transmitter's transmission is transient

- Using a EMI Receiver with the frequency span set to 0 Hz and the sweep time set at a suitable value to capture the envelope peaks and the duty cycle of the transmitter output signal;
- The duty cycle of the transmitter, $x = \text{Tx on} / (\text{Tx on} + \text{Tx off})$ with $0 < x < 1$, is measure and recorded in the test report. For the purpose of testing, the equipment shall be operated with a duty cycle that is equal or more than 0.1.

Step 2: Calculation of Average EIRP. See Figure 1

- The average output power of the transmitter shall be determined using a wideband, calibrated RF average power meter with the power sensor with an integration period that exceeds the repetition period of the transmitter by a factor 5 or more. The observed value shall be recorded as "A" (in dBm);
- The e.i.r.p. shall be calculated from the above measured power output "A", the observed duty cycle x, and the applicable antenna assembly gain "G" in dBi, according to the formula:

$$\text{EIRP} = \text{A} + \text{G} + 10\log(1/x)$$

$$\{ X = 1 \text{ for continuous transmission } \Rightarrow 10\log(1/x) = 0 \text{ dB} \}$$

Figure 1.

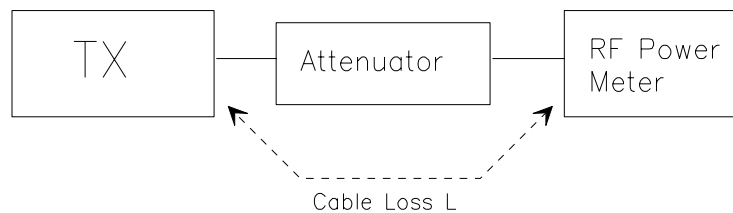

- All test results contained in this engineering test report are traceable to National Institute of Standards and Technology (NIST)

8.2. RADIATED POWER MEASUREMENTS (ERP & EIRP) USING SUBSTITUTION METHOD

8.2.1. Maximizing RF Emission Level (E-Field)

- (a) The measurements was performed with full rf output power and modulation.
- (b) Test was performed at listed 3m open area test site (listed with FCC, IC, ITI, NVLAP, ACA & VCCI).
- (c) The transmitter under test was placed at the specified height on a non-conducting turntable (80 cm height)
- (d) The BICONILOG antenna (20 MHz to 1 GHz) or HORN antenna (1 GHz to 18 GHz) was used for measuring.
- (e) Load an appropriate correction factors file in EMI Receiver for correcting the field strength reading level

Total Correction Factor recorded in the EMI Receiver = Cable Loss + Antenna Factor
E (dBuV/m) = Reading (dBuV) + Total Correction Factor (dB/m)

- (f) Set the EMI Receiver #1 and #2 as follows:

Center Frequency:	test frequency
Resolution BW:	100 kHz
Video BW:	same
Detector Mode:	positive
Average:	off
Span:	3 x the signal bandwidth

- (g) The test antenna was lowered or raised from 1 to 4 meters until the maximum signal level was detected.
- (h) The transmitter was rotated through 360° about a vertical axis until a higher maximum signal was received.
- (i) The test antenna was lowered or raised again from 1 to 4 meters until a maximum was obtained. This level was recorded.
- (j) The recorded reading was corrected to the true field strength level by adding the antenna factor, cable loss and subtracting the pre-amplifier gain.
- (k) The above steps were repeated with both transmitters' antenna and test receiving antenna placed in vertical and horizontal polarization. Both readings with the antennas placed in vertical and horizontal polarization shall be recorded.
- (l) Repeat for all different test signal frequencies

8.2.2. Measuring the EIRP of Spurious/Harmonic Emissions using Substitution Method

- (a) Set the EMI Receiver (for measuring E-Field) and Receiver #2 (for measuring EIRP) as follows:

Center Frequency: equal to the signal source
Resolution BW: 10 kHz
Video BW: same
Detector Mode: positive
Average: off
Span: 3 x the signal bandwidth

- (b) Load an appropriate correction factors file in EMI Receiver for correcting the field strength reading level

Total Correction Factor recorded in the EMI Receiver = Cable Loss + Antenna Factor
 $E \text{ (dBuV/m)} = \text{Reading (dBuV)} + \text{Total Correction Factor (dB/m)}$

- (c) Select the frequency and E-field levels obtained in the Section 8.2.1 for ERP/EIRP measurements.
(d) Substitute the EUT by a signal generator and one of the following transmitting antenna (substitution antenna):
♦ DIPOLE antenna for frequency from 30-1000 MHz or
♦ HORN antenna for frequency above 1 GHz }.
(e) Mount the transmitting antenna at 1.5 meter high from the ground plane.
(f) Use one of the following antenna as a receiving antenna:
♦ DIPOLE antenna for frequency from 30-1000 MHz or
♦ HORN antenna for frequency above 1 GHz }.
(g) If the DIPOLE antenna is used, tune it's elements to the frequency as specified in the calibration manual.
(h) Adjust both transmitting and receiving antenna in a VERTICAL polarization.
(i) Tune the EMI Receivers to the test frequency.
(j) Lower or raise the test antenna from 1 to 4 meters until the maximum signal level was detected.
(k) The transmitter was rotated through 360° about a vertical axis until a higher maximum signal was received.
(l) Lower or raise the test antenna from 1 to 4 meters until the maximum signal level was detected.
(m) Adjust input signal to the substitution antenna until an equal or a known related level to that detected from the transmitter was obtained in the test receiver.
(n) Record the power level read from the Average Power Meter and calculate the ERP/EIRP as follows:

$$P = P1 - L1 = (P2 + L2) - L1 = P3 + A + L2 - L1$$

$$EIRP = P + G1 = P3 + L2 - L1 + A + G1$$

$$ERP = EIRP - 2.15 \text{ dB}$$

$$\text{Total Correction factor in EMI Receiver \# 2} = L2 - L1 + G1$$

Where: P: Actual RF Power fed into the substitution antenna port after corrected.
P1: Power output from the signal generator
P2: Power measured at attenuator A input
P3: Power reading on the Average Power Meter
EIRP: EIRP after correction
ERP: ERP after correction

- (o) Adjust both transmitting and receiving antenna in a HORIZONTAL polarization, then repeat step (k) to (o)
(p) Repeat step (d) to (o) for different test frequency
(q) Repeat steps (c) to (j) with the substitution antenna oriented in horizontal polarization.
(r) Actual gain of the EUT's antenna is the difference of the measured EIRP and measured RF power at the RF port. Correct the antenna gain if necessary.:

Figure 2

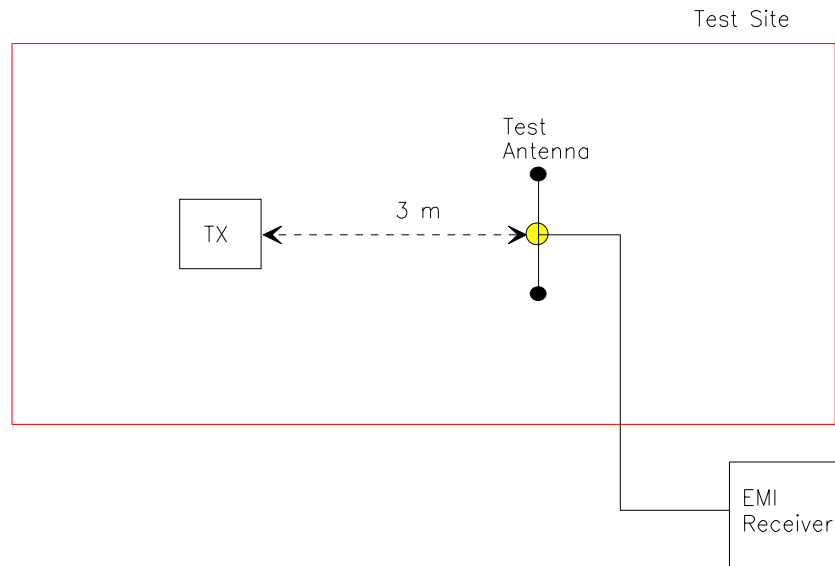
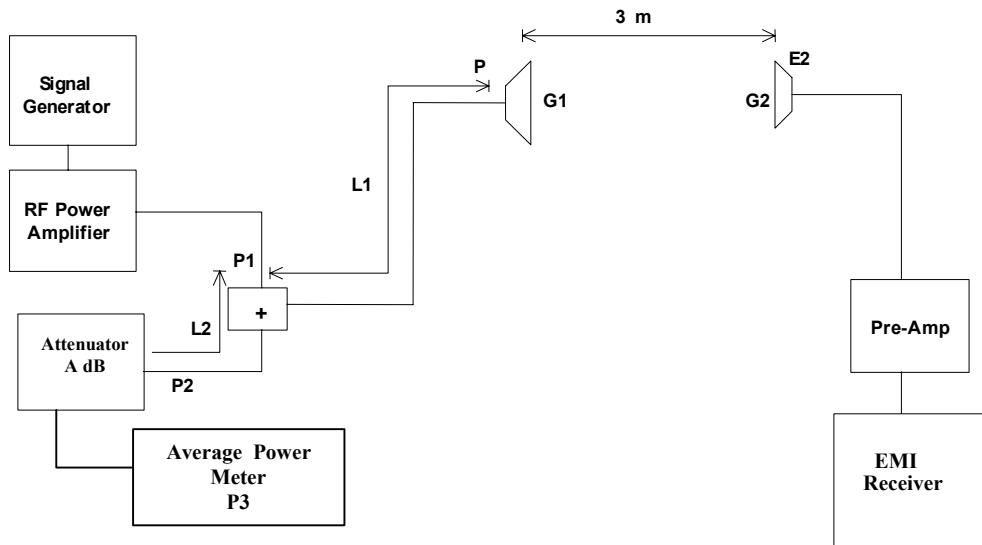

Figure 3



8.3. SPURIOUS EMISSIONS (CONDUCTED)

The transmitter spurious and harmonic emissions were scanned. The spurious and harmonic emissions were measured with the EMI Receiver controls set as RBW = 100 kHz (for frequencies < 1 GHz) and 1 MHz (for frequencies > 1GHz), VBW \geq RBW and SWEEP TIME = AUTO). The transmitter was operated at a full rated power output, and modulated as follows:

- **Frequency spectrum to be investigated:-** The spectrum was investigated from the lowest radio generated in the equipment up to at least the 10th harmonic of the carrier frequency or to the highest frequency practicable in the present state of the art of measuring techniques, whichever is lower. Particular attention should be paid to harmonics and subharmonics of the carrier frequency. Radiation at the frequencies of multiplier stages should be checked. The amplitude of spurious emissions which are attenuated more than 40 dB below the permissible value need not be reported.
- **Spurious Emissions at Antenna Terminal:-** The radio frequency voltage or powers generated within the equipment and appearing on a spurious frequency shall be checked at the equipment output terminals when properly loaded with a suitable artificial antenna. Curves or equivalent data shall show the magnitude of the harmonic and other spurious emission that can be detected when the equipment is operated under the conditions as appropriate. The magnitude of spurious emissions which are attenuated more than 40 dB below the permissible value need not be specified.

8.4. EMISSION MASK

Voice or Digital Modulation Through a Voice Input Port @ 2.1049(c)(i):- The transmitter was modulated by a 2.5 KHz tone signal at an input level 16 dB greater than that required to produce 50% modulation (e.g.: ± 2.5 KHz peak deviation at 1 KHz modulating frequency). The input level was established at the frequency of maximum response of the audio modulating circuit.

Digital Modulation Through a Data Input Port @ 2.1049(h):- Transmitters employing digital modulation techniques - when modulated by an input signal such that its amplitude and symbol rate represent the maximum rated conditions under which the equipment will be operated. The signal shall be applied through any filter networks, pseudo-random generators or other devices required in normal service. Additionally, the Emission Masks shall be shown for operation with any devices used for modifying the spectrum when such devices are operational at the discretion of the user.

The following EMI Receiver bandwidth shall be used for measurement of Emission Mask/Out-of-Band Emission Measurements:

- (1) For 25 kHz Channel Spacing: RBW = 300 Hz
- (2) For 12.5 kHz or 6.25 kHz Channel Spacings: RBW = 100 Hz

The all cases the Video Bandwidth shall be equal or greater than the measuring bandwidth.