

ENGINEERING TEST REPORT

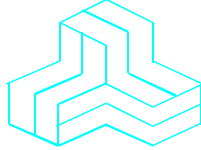

LINKnet OFR400 RF Module (Repeater/Translator)

Model No.: OFR400

FCC ID: H6M-OFR400

Applicant: **KAVAL TELECOM INC.**
60 Gough Road
Markham, Ontario
Canada, L3R 8X7

Tested in Accordance With

**Federal Communications Commission (FCC)
CFR 47, PARTS 2 and 90 (Subpart I)**

UltraTech's File No.: KTI-006FTX

This Test report is Issued under the Authority of
Tri M. Luu, Professional Engineer,
Vice President of Engineering
UltraTech Group of Labs



Date: May 10, 2000

Report Prepared by: Tri M. Luu

Tested by: Mr. Hung Trinh, EMI/RFI
Technician

Issued Date: May 09, 2000

Test Dates: May 12 - May 15, 2000

The results in this Test Report apply only to the sample(s) tested, and the sample tested is randomly selected.

UltraTech

3000 Bristol Circle, Oakville, Ontario, Canada, L6H 6G4
Telephone (905) 829-1570 Facsimile (905) 829-8050

Website: www.ultratech-labs.com Email: vhk.ultratech@sympatico.ca

TABLE OF CONTENTS

EXHIBIT 1. SUBMITTAL CHECK LIST	3
EXHIBIT 2. INTRODUCTION	5
2.1. SCOPE	5
2.2. NORMATIVE REFERENCES	5
EXHIBIT 3. PERFORMANCE ASSESSMENT.....	6
3.1. CLIENT INFORMATION	6
3.2. EQUIPMENT UNDER TEST (EUT) INFORMATION.....	6
3.3. EUT'S TECHNICAL SPECIFICATIONS.....	7
3.4. LIST OF EUT'S PORTS	7
3.5. SPECIAL CHANGES ON THE EUT'S HARDWARE/SOFTWARE FOR TESTING PURPOSES.....	8
3.6. MODIFICATIONS INCORPORATED IN THE EUT FOR COMPLIANCE PURPOSES	8
3.7. RELATED SUBMITAL(S)/GRANT(S).....	8
3.8. ANCILLARY EQUIPMENT	8
3.9. TEST SETUP FOR EQUIPMENT UNDER TEST.....	9
EXHIBIT 4. EUT OPERATING CONDITIONS AND CONFIGURATIONS DURING TESTS.....	10
4.1. CLIMATE TEST CONDITIONS	10
4.2. OPERATIONAL TEST CONDITIONS & ARRANGEMENT FOR TEST SIGNALS.....	10
EXHIBIT 5. SUMMARY OF TEST RESULTS.....	11
5.1. LOCATION OF TESTS	11
5.2. APPLICABILITY & SUMMARY OF EMC EMISSION TEST RESULTS	11
EXHIBIT 6. MEASUREMENTS, EXAMINATIONS & TEST DATA FOR EMC EMISSIONS.....	12
6.1. TEST PROCEDURES.....	12
6.2. MEASUREMENT UNCERTAINTIES.....	12
6.3. MEASUREMENT EQUIPMENT USED:.....	12
6.4. ESSENTIAL/PRIMARY FUNCTIONS AS DECLARED BY THE MANUFACTURER:.....	12
6.5. RF POWER OUTPUT @ FCC 2.985 & 90.205	13
6.5.1. <i>Limits @ FCC 90.205</i>	13
6.5.2. <i>Method of Measurements</i>	13
6.5.3. <i>Test Equipment List</i>	13
6.5.4. <i>Test Arrangement</i>	13
6.5.5. <i>Test Data</i>	13
6.6. FREQUENCY STABILITY @ FCC 2.995 & 90.213	14
6.6.1. <i>Limits @ FCC 90.213</i>	14
6.6.2. <i>Method of Measurements</i>	14
6.6.3. <i>Test Equipment List</i>	14
6.6.4. <i>Test Arrangement</i>	14
6.6.5. <i>Test Data</i>	15
6.7. MODULATION LIMITING @ FCC 2.987(B) & 90.210	19
6.7.1. <i>Limits @ FCC 2.987(b) and 90.210</i>	19
6.7.2. <i>Method of Measurements</i>	19
6.7.3. <i>Test Equipment List</i>	19
6.7.4. <i>Test Arrangement</i>	19

ULTRATECH GROUP OF LABS

3000 Bristol Circle, Oakville, Ontario, Canada L6H 6G4
Tel. #: 905-829-1570, Fax. #: 905-829-8050, Email: vhk.ultratech@sympatico.ca, Website: <http://www.ultratech-labs.com>

File #: KTI-006FTX

May 15, 2000

- Assessed by ITI (UK) Competent Body, NVLAP (USA) Accreditation Body & ACA/AUSTEL (Australia)
- Recognized/Listed by FCC (USA), Industry Canada (Canada)
- All test results contained in this engineering test report are traceable to National Institute of Standards and Technology (NIST)

6.7.5.	Test Data	20
6.8.	EMISSION LIMITATION & EMISSION MASK @ FCC 2.989, 90.209 & 90.910.....	21
6.8.1.	Limits @ 90.209 & 90.910	21
6.8.2.	Method of Measurements	21
6.8.3.	Test Equipment List.....	21
6.8.4.	Test Arrangement.....	21
6.8.5.	Test Data	21
6.8.6.	Plots.....	21
6.9.	TRANSMITTER ANTENNA POWER SPURIOUS/HARMONIC CONDUCTED EMISSIONS @ FCC 90.210.....	22
6.9.1.	Limits @ 90.210.....	22
6.9.2.	Method of Measurements	22
6.9.3.	Test Equipment List.....	22
6.9.4.	Test Arrangement.....	22
6.9.5.	Test Data	23
6.9.5.1.	Near lowest frequency 450 MHz, RF Input Power = -30 dBm, RF Output Power = 9.0 Watts, Modulation: FM with 2.5 kHz sine wave signal.	23
6.9.5.2.	Near lowest frequency 450 MHz, RF Input Power = -30 dBm, RF Output Power = 9.0 Watts, Modulation: FM with 9600 b/s random data (external source).....	23
6.9.5.3.	Near lowest frequency 460 MHz, RF Input Power = -30 dBm, RF Output Power = 8.5 Watts, Modulation: FM with 2.5 kHz sine wave signal.	24
6.9.5.4.	Near lowest frequency 460 MHz, RF Input Power = -30 dBm, RF Output Power = 8.5 Watts, Modulation: FM with 9600 b/s random data (external source).....	24
6.9.5.5.	Near lowest frequency 470 MHz, RF Input Power = -30 dBm, RF Output Power = 8.3 Watts, Modulation: FM with 2.5 kHz sine wave signal.	25
6.9.5.6.	Near lowest frequency 470 MHz, RF Input Power = -30 dBm, RF Output Power = 8.3 Watts, Modulation: FM with 9600 b/s random data (external source).....	25
6.9.6.	Plots.....	25
6.10.	TRANSMITTER SPURIOUS/HARMONIC RADIATED EMISSIONS @ FCC 90.210	26
6.10.1.	Limits @ FCC 90.210	26
6.10.2.	Method of Measurements	26
6.10.3.	Test Equipment List.....	26
6.10.4.	Test Arrangement.....	27
6.10.5.	Test Data	27
6.10.5.1.	Near lowest frequency 450 MHz, RF Input Power = -30 dBm, RF Output Power =9.0 Watts, Modulation: FM with 2.5 kHz sine wave signal.	27
6.10.5.2.	Near lowest frequency 460 MHz, RF Input Power = -30 dBm, RF Output Power =8.5 Watts, Modulation: FM with 9600 b/s random data.....	27
6.10.5.3.	Near lowest frequency 470 MHz, RF Input Power = -30 dBm, RF Output Power =8.3 Watts, Modulation: FM with 2.5 kHz sine wave signal.	28
6.10.6.	Plots.....	28
6.10.7.	Photographs of Test Setup.....	28
EXHIBIT 7.	MEASUREMENT UNCERTAINTY.....	29
7.1.	RADIATED EMISSION MEASUREMENT UNCERTAINTY	29
EXHIBIT 8.	MEASUREMENT METHODS.....	30
8.1.	EFFECTIVE RADIATED POWER (ERP) MEASUREMENTS	30
8.2.	FREQUENCY STABILITY.....	32
8.3.	EMISSION MASK.....	33
8.4.	SPURIOUS EMISSIONS (CONDUCTED).....	33
8.5.	SPURIOUS EMISSIONS (RADIATED).....	34

ULTRATECH GROUP OF LABS

3000 Bristol Circle, Oakville, Ontario, Canada L6H 6G4
Tel. #: 905-829-1570, Fax. #: 905-829-8050, Email: vhk.ultratech@sympatico.ca, Website: <http://www.ultratech-labs.com>

File #: KTI-006FTX
May 15, 2000

- Assessed by ITI (UK) Competent Body, NVLAP (USA) Accreditation Body & ACA/AUSTEL (Australia)
- Recognized/Listed by FCC (USA), Industry Canada (Canada)
- All test results contained in this engineering test report are traceable to National Institute of Standards and Technology (NIST)

EXHIBIT 1. SUBMITTAL CHECK LIST

Exhibit No.	Exhibit Type	Description of Contents	Quality Check (OK)
1 through 8	Test Report	<ul style="list-style-type: none"> ▪ Exhibit 1: Submittal check lists ▪ Exhibit 2: Introduction ▪ Exhibit 3: Performance Assessment ▪ Exhibit 4: EUT Operation and Configuration during Tests ▪ Exhibit 5: Summary of test Results ▪ Exhibit 6: Measurement Data ▪ Exhibit 7: Measurement Uncertainty ▪ Exhibit 8: Measurement Methods 	Ok Ok Ok Ok Ok Ok Ok Ok
9	Test Report - Plots of Measurement Data	Plots # 1 through 18	Ok
10	Test Setup Photos	Photos # 1 and 2	Ok
11	External Photos of EUT	Photos # 1 to 6	Ok
12	Internal Photos of EUT	Photos 1 to 19	Ok
13	Cover Letters	<ul style="list-style-type: none"> ▪ Letter from Ultratech for Certification Request ▪ Letter from the Applicant to appoint Ultratech to act as an agent ▪ Letter from the Applicant to request for Confidentiality Filing 	Ok Ok Ok
14	Attestation Statements	<ul style="list-style-type: none"> ▪ Manufacturer's Declaration for Equipment Specifications, Installation (if it is professionally installed) and Production Quality Production Assurance. ▪ Manufacturer's Declaration of Conformity (FCC DoC) for compliance with FCC Part 15, Sub. B, Class B - Computing Devices - if required 	None N/A
15	Application Forms	<ul style="list-style-type: none"> ▪ Form 731 ▪ Form 159 ▪ Confirmation of Exhibits sent to FCC ▪ Status of Exhibits sent to FCC 	Electronic filing Ok Ok
16	ID Label/Location Info	<ul style="list-style-type: none"> ▪ ID Label ▪ Location of ID Label 	Ok Ok
17	Block Diagrams	Please refer to the User's Manual for details	Ok
18	Schematic Diagrams	Schematic diagrams	Ok
19	Parts List/Tune Up Info		None
20	Operational Description	Please refer to the User's Manual for details	
21	RF Exposure Info	Please refer to the User's Manual for	

ULTRATECH GROUP OF LABS

3000 Bristol Circle, Oakville, Ontario, Canada L6H 6G4
 Tel. #: 905-829-1570, Fax. #: 905-829-8050, Email: vhk.ultratech@sympatico.ca, Website: <http://www.ultratech-labs.com>

File #: KTI-006FTX
 May 15, 2000

- Assessed by ITI (UK) Competent Body, NVLAP (USA) Accreditation Body & ACA/AUSTEL (Australia)
- Recognized/Listed by FCC (USA), Industry Canada (Canada)
- All test results contained in this engineering test report are traceable to National Institute of Standards and Technology (NIST)

		detailed antenna instruction & RF exposure warnings	
22	Users Manual		Ok

ULTRATECH GROUP OF LABS

3000 Bristol Circle, Oakville, Ontario, Canada L6H 6G4
Tel. #: 905-829-1570, Fax. #: 905-829-8050, Email: vhk.ultratech@sympatico.ca, Website: <http://www.ultratech-labs.com>

File #: KTI-006FTX
May 15, 2000

- Assessed by ITI (UK) Competent Body, NVLAP (USA) Accreditation Body & ACA/AUSTEL (Australia)
- Recognized/Listed by FCC (USA), Industry Canada (Canada)
- *All test results contained in this engineering test report are traceable to National Institute of Standards and Technology (NIST)*

EXHIBIT 2. INTRODUCTION

2.1. SCOPE

Reference:	FCC Parts 2 and 90 (Subpart 90): 1999
Title	Telecommunication - Code of Federal Regulations, CFR 47, Parts 2 & 90
Purpose of Test:	To gain FCC Certification Authorization for Radio operating in the frequency bands 450-512 MHz.
Test Procedures	Both conducted and radiated emissions measurements were conducted in accordance with American National Standards Institute ANSI C63.4 - American National Standard for Methods of Measurement of Radio-Noise Emissions from Low-Voltage Electrical and Electronic Equipment in the Range of 9 kHz to 40 GHz.

2.2. NORMATIVE REFERENCES

Publication	YEAR	Title
FCC CFR Parts 0-19, 80-End	1998	Code of Federal Regulations – Telecommunication
ANSI C63.4	1992	American National Standard for Methods of Measurement of Radio-Noise Emissions from Low-Voltage Electrical and Electronic Equipment in the Range of 9 kHz to 40 GHz
CISPR 22 & EN 55022	1997 1998	Limits and Methods of Measurements of Radio Disturbance Characteristics of Information Technology Equipment
CISPR 16-1		Specification for Radio Disturbance and Immunity measuring apparatus and methods

ULTRATECH GROUP OF LABS

3000 Bristol Circle, Oakville, Ontario, Canada L6H 6G4
Tel. #: 905-829-1570, Fax. #: 905-829-8050, Email: vhk.ultratech@sympatico.ca, Website: <http://www.ultratech-labs.com>

File #: KTI-006FTX
May 15, 2000

- Assessed by ITI (UK) Competent Body, NVLAP (USA) Accreditation Body & ACA/AUSTEL (Australia)
- Recognized/Listed by FCC (USA), Industry Canada (Canada)
- All test results contained in this engineering test report are traceable to National Institute of Standards and Technology (NIST)

EXHIBIT 3. PERFORMANCE ASSESSMENT

3.1. CLIENT INFORMATION

APPLICANT:	
Name:	KAVAL TELECOM INC.
Address:	60 Gough Road Markham, Ontario Canada, L3R 8X7
Contact Person:	Mr. Alan Aslett Phone #: 905-946-3397 Fax #: 905-946-3392 Email Address: aaslett@kaval.com

MANUFACTURER:	
Name:	KAVAL TELECOM INC.
Address:	60 Gough Road Markham, Ontario Canada, L3R 8X7
Contact Person:	Mr. Alan Aslett Phone #: 905-946-3397 Fax #: 905-946-3392 Email Address: aaslett@kaval.com

3.2. EQUIPMENT UNDER TEST (EUT) INFORMATION

The following information (with the exception of the Date of Receipt) has been supplied by the applicant.

Brand Name	KAVAL TELECOM INC.
Product Name	LINKnet OFR400 RF Module (Repeater/Translator)
Model Name or Number	OFR400
Serial Number	Pre-production
Type of Equipment	Radio Communication Equipment
External Power Supply	None
Transmitting/Receiving Antenna Type	Non-integral
Primary User Functions of EUT:	Radio repeater or translator in the frequency bands 450-512 MHz.

ULTRATECH GROUP OF LABS

3000 Bristol Circle, Oakville, Ontario, Canada L6H 6G4
Tel. #: 905-829-1570, Fax. #: 905-829-8050, Email: vhk.ultratech@sympatico.ca, Website: <http://www.ultratech-labs.com>

File #: KTI-006FTX
May 15, 2000

- Assessed by ITI (UK) Competent Body, NVLAP (USA) Accreditation Body & ACA/AUSTEL (Australia)
- Recognized/Listed by FCC (USA), Industry Canada (Canada)
- All test results contained in this engineering test report are traceable to National Institute of Standards and Technology (NIST)

3.3. EUTS TECHNICAL SPECIFICATIONS

TRANSMITTER	
Equipment Type:	Base station (fixed use)
Intended Operating Environment:	Commercial, light industry & heavy industry
Power Supply Requirement:	120V 60Hz
RF Output Power Rating:	10 Watts max.
Operating Frequency Range:	450-512 MHz
RF Output Impedance:	50 Ohms
Channel Spacing:	25 kHz
Occupied Bandwidth (99%):	The occupied BW is the same as the receiving RF signal
Emission Designation*:	F3E and F1D Note: The necessary BW is the same as the receiving signal
Antenna Connector Type:	SMA
Antenna Description:	Not provided by the applicant.

* For an average case of commercial telephony, the Necessary Bandwidth is calculated as follows:

3.4. LIST OF EUTS PORTS

Port Number	EUT's Port Description	Number of Identical Ports	Connector Type	Cable Type (Shielded/Non-shielded)
1	RF IN Port	1	SMA	Shielded
2	RF OUT Port	1	SMA	Shielded
3	Communication Port (Note 2)	1	DB15	Shielded

NOTES:

- (1) *Ports of the EUT which in normal operation were connected to ancillary equipment through interconnecting cables via a representative interconnecting cable to simulate the input/output characteristics. RF input/output was correctly terminated to the 50 Ohm RF Load.*
- (2) *Ports which are not connected to cables during normal intended operation (for factory/technical services uses only)*

3.5. SPECIAL CHANGES ON THE EUTS HARDWARE/SOFTWARE FOR TESTING PURPOSES

None

3.6. MODIFICATIONS INCORPORATED IN THE EUT FOR COMPLIANCE PURPOSES

None

3.7. RELATED SUBMITAL(S)/GRANT(S)

None

3.8. ANCILLARY EQUIPMENT

The EUT was tested while connected to the following representative configuration of ancillary equipment necessary to exercise the ports during tests:

Ancillary Equipment # 1	
Description:	Omnibook Laptop Computer
Brand name:	Hewlett Packard
Model Name or Number:	5500CS
Serial Number:	TW63493246
Cable Length & Type:	6 feet
Connected to EUT's Port:	RS-232 (DB25) Port

Ancillary Equipment # 2	
Description:	Synthesized Sweeper
Brand name:	Hewlett Packard
Model Name or Number:	HP83752B
Serial Number:	3610A00457
Cable Length & Type:	6 feet
Connected to EUT's Port:	RF IN, Coaxial cable

Ancillary Equipment # 3	
Description:	Data Signal Generator
Brand name:	General Electric
Model Name or Number:	9600-SW
Serial Number:	9614517
Cable Length & Type:	6 feet
Connected to Ancillary #2 Port:	Wire leads

ULTRATECH GROUP OF LABS

3000 Bristol Circle, Oakville, Ontario, Canada L6H 6G4
Tel. #: 905-829-1570, Fax. #: 905-829-8050, Email: vhk.ultratech@sympatico.ca, Website: <http://www.ultratech-labs.com>

File #: KTI-006FTX
May 15, 2000

- Assessed by ITI (UK) Competent Body, NVLAP (USA) Accreditation Body & ACA/AUSTEL (Australia)
- Recognized/Listed by FCC (USA), Industry Canada (Canada)
- All test results contained in this engineering test report are traceable to National Institute of Standards and Technology (NIST)

Ancillary Equipment # 4	
Description:	Voice Signal Generator
Brand name:	Giga-Tronics
Model Name or Number:	6061A
Serial Number:	...
Cable Length & Type:	6 feet
Connected to Ancillary #2 Port:	Coaxial

3.9. TEST SETUP FOR EQUIPMENT UNDER TEST

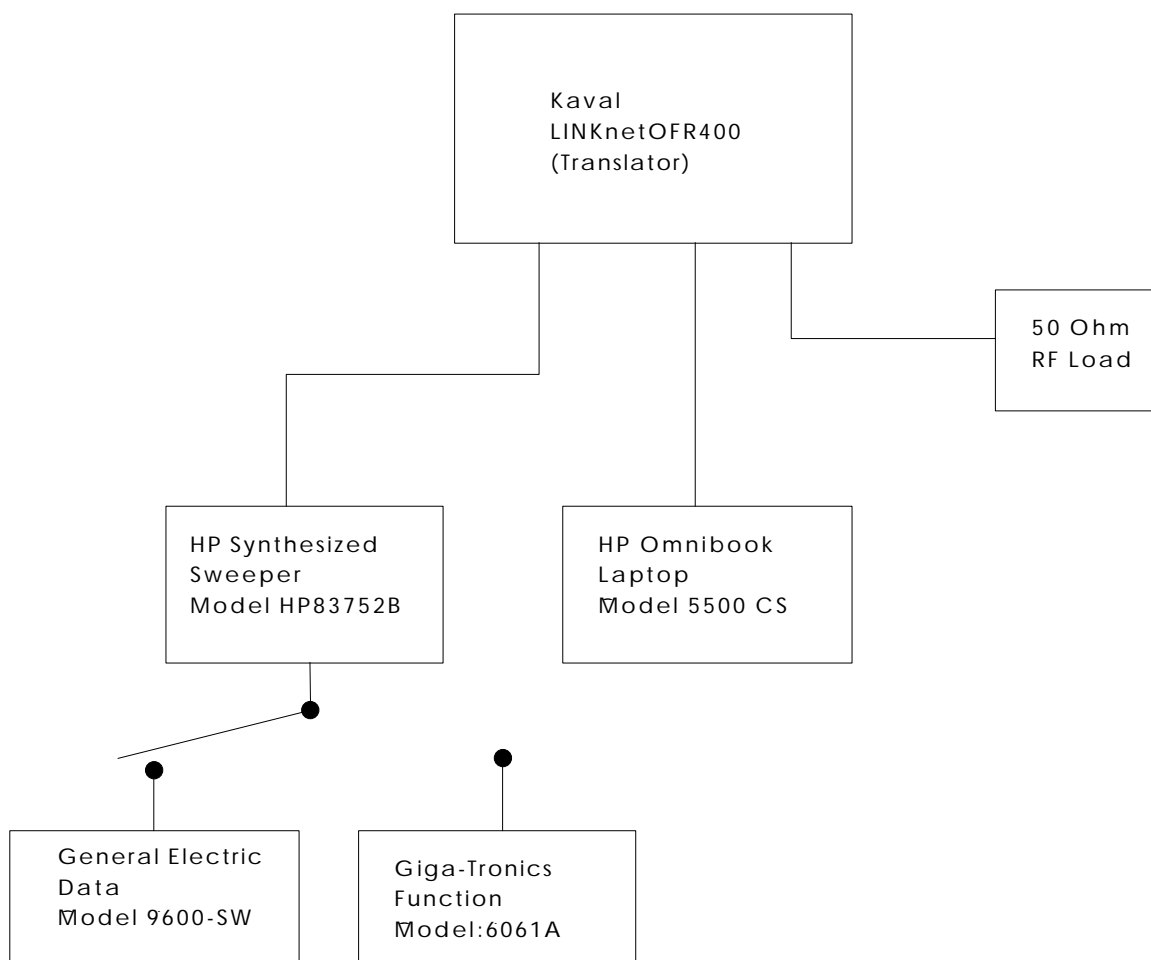

ULTRATECH GROUP OF LABS

3000 Bristol Circle, Oakville, Ontario, Canada L6H 6G4
 Tel. #: 905-829-1570, Fax. #: 905-829-8050, Email: vhk.ultratech@sympatico.ca, Website: <http://www.ultratech-labs.com>

File #: KTI-006FTX
 May 15, 2000

- Assessed by ITI (UK) Competent Body, NVLAP (USA) Accreditation Body & ACA/AUSTEL (Australia)
- Recognized/Listed by FCC (USA), Industry Canada (Canada)
- All test results contained in this engineering test report are traceable to National Institute of Standards and Technology (NIST)

EXHIBIT 4. EUT OPERATING CONDITIONS AND CONFIGURATIONS DURING TESTS

4.1. CLIMATE TEST CONDITIONS

The climate conditions of the test environment are as follows:

Temperature:	21°C
Humidity:	51%
Pressure:	102 kPa
Power input source:	120V 60Hz

4.2. OPERATIONAL TEST CONDITIONS & ARRANGEMENT FOR TEST SIGNALS

Operating Modes:	The transmitter was operated in a continuous transmission mode with the carrier modulated as specified in the Test Data.
Special Test Software:	Kaval's utility software is provided for selecting input/output channels
Special Hardware Used:	None
Transmitter Test Antenna:	The EUT is tested with the transmitter antenna port terminated to a 50 Ohm RF Load.

Transmitter Test Signals:	
Frequencies:	Near lowest, near middle & near highest frequencies each frequency bands that the transmitter covers:
<ul style="list-style-type: none"> ▪ 450-512 MHz 	<ul style="list-style-type: none"> ▪ 450, 460 and 470 MHz
Transmitter Wanted Output Test Signals:	
<ul style="list-style-type: none"> ▪ RF Power Output (measured maximum output power): ▪ Normal Test Modulation ▪ Modulating signal source: 	<ul style="list-style-type: none"> ▪ 9 Watts ▪ FM with voice and data ▪ External from the RF input source

Receiver Wanted Output Test Signals:	
<ul style="list-style-type: none"> ▪ RF Power Input Rating: 	<ul style="list-style-type: none"> ▪ -30 dBm or 0.001 mWatts max.

ULTRATECH GROUP OF LABS

3000 Bristol Circle, Oakville, Ontario, Canada L6H 6G4
 Tel. #: 905-829-1570, Fax. #: 905-829-8050, Email: vhk.ultratech@sympatico.ca, Website: <http://www.ultratech-labs.com>

File #: KTI-006FTX
 May 15, 2000

- Assessed by ITI (UK) Competent Body, NVLAP (USA) Accreditation Body & ACA/AUSTEL (Australia)
- Recognized/Listed by FCC (USA), Industry Canada (Canada)
- All test results contained in this engineering test report are traceable to National Institute of Standards and Technology (NIST)

EXHIBIT 5. SUMMARY OF TEST RESULTS

5.1. LOCATION OF TESTS

All of the measurements described in this report were performed at Ultratech Group of Labs located in the city of Oakville, Province of Ontario, Canada.

- AC Powerline Conducted Emissions were performed in UltraTech's shielded room, 16'(L) by 12'(W) by 12'(H).
- Radiated Emissions were performed at the Ultratech's 3 Meter Open Field Test Site (OFTS) situated in the Town of Oakville, province of Ontario.

The above sites have been calibrated in accordance with ANSI C63.4, and found to be in compliance with the requirements of Sec. 2.948 of the FCC Rules. The descriptions and site measurement data of the Oakville Open Field Test Site has been filed with FCC office (FCC File No.: 31040/SIT 1300B3) and Industry Canada office (Industry Canada File No.: IC2049). Last Date of Site Calibration: Sep. 20, 1999.

5.2. APPLICABILITY & SUMMARY OF EMC EMISSION TEST RESULTS

FCC PARAGRAPH.	TEST REQUIREMENTS	APPLICABILITY (YES/NO)
90.205 & 2.985	RF Power Output	Yes
90.213 & 2.995	Frequency Stability	Yes
90.242(b)(8) & 2.987(a)	Audio Frequency Response	Not applicable for the a RF translator device
90.210 & 2.987(b)	Modulation Limiting	Not applicable a RF translator device
90.209, 90.210 & 2.989	Emission Limitation & Emission Masks	Yes
90.210, 2.997 & 2.991	Emission Limits - Spurious Emissions at Antenna Terminal	Yes
90.210, 2.997 & 2.993	Emission Limits - Field Strength of Spurious Emissions	Yes
90.214	Transient Frequency Behavior	Not applicable

LINKnet OFR400 RF Module (Repeater/Translator), Model No.: OFR400, by **KAVAL TELECOM INC.** has also been tested and found to comply with **FCC Part 15, Subpart B - Radio Receivers and Class A Digital Devices**. The engineering test report has been documented and kept in file and it is available anytime upon FCC request.

ULTRATECH GROUP OF LABS

3000 Bristol Circle, Oakville, Ontario, Canada L6H 6G4
 Tel. #: 905-829-1570, Fax. #: 905-829-8050, Email: vhk.ultratech@sympatico.ca, Website: <http://www.ultratech-labs.com>

File #: KTI-006FTX
 May 15, 2000

- Assessed by ITI (UK) Competent Body, NVLAP (USA) Accreditation Body & ACA/AUSTEL (Australia)
- Recognized/Listed by FCC (USA), Industry Canada (Canada)
- All test results contained in this engineering test report are traceable to National Institute of Standards and Technology (NIST)

EXHIBIT 6. MEASUREMENTS, EXAMINATIONS & TEST DATA FOR EMC EMISSIONS

6.1. TEST PROCEDURES

This section contains test results only. Details of test methods and procedures can be found in Exhibit 7 of this report

6.2. MEASUREMENT UNCERTAINTIES

The measurement uncertainties stated were calculated in accordance with requirements of UKAS Document NIS 81 with a confidence level of 95%. Please refer to Exhibit 6 for Measurement Uncertainties.

6.3. MEASUREMENT EQUIPMENT USED:

The measurement equipment used complied with the requirements of the Standards referenced in the Methods & Procedures ANSI C63.4:1992 and CISPR 16-1.

6.4. ESSENTIAL/PRIMARY FUNCTIONS AS DECLARED BY THE MANUFACTURER:

The essential function of the EUT is to correctly communicate data to and from radios over RF link.

ULTRATECH GROUP OF LABS

3000 Bristol Circle, Oakville, Ontario, Canada L6H 6G4
Tel. #: 905-829-1570, Fax. #: 905-829-8050, Email: vhk.ultratech@sympatico.ca, Website: <http://www.ultratech-labs.com>

File #: KTI-006FTX
May 15, 2000

- Assessed by ITI (UK) Competent Body, NVLAP (USA) Accreditation Body & ACA/AUSTEL (Australia)
- Recognized/Listed by FCC (USA), Industry Canada (Canada)
- *All test results contained in this engineering test report are traceable to National Institute of Standards and Technology (NIST)*

6.5. RF POWER OUTPUT @ FCC 2.985 & 90.205

6.5.1. Limits @ FCC 90.205

Please refer to FCC CFR 47, Part 90, Subpart I, Para. 90.205 for specification details.

6.5.2. Method of Measurements

FCC @ 2.985 – The rf output power of the transmitter was measured at the RF output terminals when the transmitter is adjusted by the manufacturer in accordance with the tune-up procedure to give the values of the current and voltage on the circuit elements specified in 2.983(d)(5). The electrical characteristics of the radio frequency load attached to the output terminals was 50 Ohms.

The detailed test method is as follows:

- *The transmitter terminal was coupled to the Spectrum Analyzer through a 20 dB attenuator*
- *Power of the transmitter channel near the lowest, middle and highest of each frequency block/band were measured using the power meter, and the reading was corrected by added the calibrated attenuator's attenuation value and cable loss.*
- *The RF Output was turned on with standard modulation applied.*

6.5.3. Test Equipment List

Test Instruments	Manufacturer	Model No.	Serial No.	Frequency Range
Spectrum Analyzer/ EMI Receiver	Hewlett Packard	HP 8593EM	3412A00103	9 kHz – 26.5 GHz
Attenuator(s)	Bird	DC – 22 GHz

6.5.4. Test Arrangement

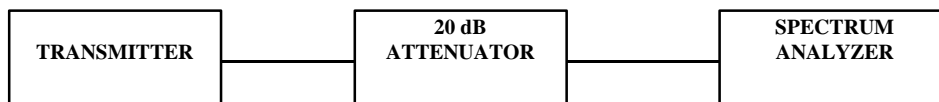

6.5.5. Test Data

OPERATING FREQUENCY BAND (MHz)	CHANNEL FREQUENCY (MHz)	FUNDAMENTAL FREQUENCY (MHz)	MEASURED AVERAGE POWER (P) (Watts)	AVERAGE POWER RATING (Watts)
450 – 512	Near lowest	450	9.0	8.0
	Near middle	460	8.5	8.0
	Near highest	470	8.3	8.0

6.6. FREQUENCY STABILITY @ FCC 2.995 & 90.213

6.6.1. Limits @ FCC 90.213

Please refer to FCC CFR 47, Part 90, Subpart I, Para. 90.213 for specification details.

FREQUENCY RANGE (MHz)	FIXED & BASE STATIONS (ppm)			MOBILE STATIONS (ppm)					
				> 2 W			≤ 2 W		
	6.25 kHz	12.5 kHz	25 kHz	6.25 kHz	12.5 kHz	25 kHz	6.25 kHz	12.5 kHz	25 kHz
403-512 MHz	0.5	1.5	2.5	1.0	2.5	5.0	1.0	2.5	5.0

6.6.2. Method of Measurements

Refer to Exhibit 7, Sec. 7.2 & FCC @ 2.995 for method of measurements

6.6.3. Test Equipment List

Test Instruments	Manufacturer	Model No.	Serial No.	Frequency Range
Spectrum Analyzer/EMI Receiver	Hewlett Packard	HP 8593EM	3412A00103	9 kHz – 26.5 GHz
Attenuator(s)	Bird	DC – 22 GHz
Temperature & Humidity Chamber	Tenney	T5	9723B	-40° to +60° C range

6.6.4. Test Arrangement

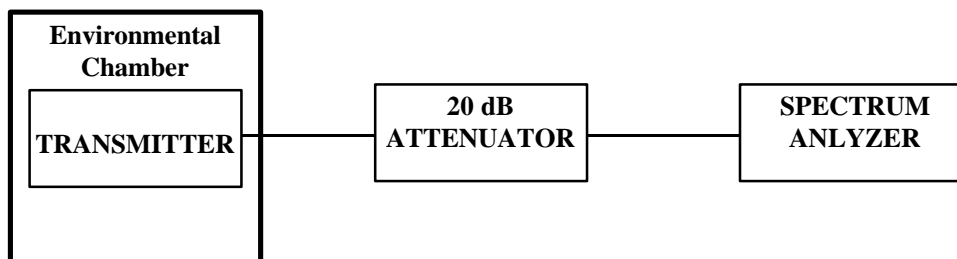

6.6.5. Test Data

Product Name	LINKnet OFR400 RF Module (Repeater/Translator)
Model No.	OFR400
Center Frequency	450 MHz (lowest of the band)
Full Power Level	9 Watts
Frequency Tolerance Limit	2.5 ppm or 450 Hz
Max. Frequency Tolerance Measured	0.089 ppm or -40 Hz
Input Voltage Rating	120V 60 Hz

		CENTER FREQUENCY & RF POWER OUTPUT VARIATION					
AMBIENT TEMP. (°C)	KEYED-ON TIME (Minutes)	Supply Voltage (Nominal) 120 Volts		Supply Voltage (85% of Nominal) 102 Volts		Supply Voltage (115% of Nominal) 138 Volts	
		Hz	dB	Hz	dB	Hz	dB
-30	0	Note 1	N/A	N/A	N/A	N/A	N/A
	1		N/A	N/A	N/A	N/A	N/A
	2		N/A	N/A	N/A	N/A	N/A
	3		N/A	N/A	N/A	N/A	N/A
	4		N/A	N/A	N/A	N/A	N/A
	5		N/A	N/A	N/A	N/A	N/A
	6		N/A	N/A	N/A	N/A	N/A
	7		N/A	N/A	N/A	N/A	N/A
	8		N/A	N/A	N/A	N/A	N/A
	9		N/A	N/A	N/A	N/A	N/A
	10		N/A	N/A	N/A	N/A	N/A
-20	0	-40	N/A	N/A	N/A	N/A	N/A
	1	-40	N/A	N/A	N/A	N/A	N/A
	2	-40	N/A	N/A	N/A	N/A	N/A
	3	-40	N/A	N/A	N/A	N/A	N/A
	4	-40	N/A	N/A	N/A	N/A	N/A
	5	-40	N/A	N/A	N/A	N/A	N/A
	6	-40	N/A	N/A	N/A	N/A	N/A
	7	-40	N/A	N/A	N/A	N/A	N/A
	8	-40	N/A	N/A	N/A	N/A	N/A
	9	-40	N/A	N/A	N/A	N/A	N/A
	10	-40	N/A	N/A	N/A	N/A	N/A
-10	0	-40	N/A	N/A	N/A	N/A	N/A
	1	-20	N/A	N/A	N/A	N/A	N/A
	2	-40	N/A	N/A	N/A	N/A	N/A
	3	-20	N/A	N/A	N/A	N/A	N/A
	4	-20	N/A	N/A	N/A	N/A	N/A
	5	-40	N/A	N/A	N/A	N/A	N/A
	6	-40	N/A	N/A	N/A	N/A	N/A

Note 1: The radio transmitter stopped working at this extreme temperature; there was no rf output.

ULTRATECH GROUP OF LABS

3000 Bristol Circle, Oakville, Ontario, Canada L6H 6G4
 Tel. #: 905-829-1570, Fax. #: 905-829-8050, Email: vhk.ultratech@sympatico.ca, Website: <http://www.ultratech-labs.com>

File #: KTI-006FTX
 May 15, 2000

- Assessed by ITI (UK) Competent Body, NVLAP (USA) Accreditation Body & ACA/AUSTEL (Australia)
- Recognized/Listed by FCC (USA), Industry Canada (Canada)
- All test results contained in this engineering test report are traceable to National Institute of Standards and Technology (NIST)

		CENTER FREQUENCY & RF POWER OUTPUT VARIATION					
AMBIENT TEMP. (°C)	KEYED-ON TIME (Minutes)	Supply Voltage (Nominal) 120 Volts		Supply Voltage (85% of Nominal) 102 Volts		Supply Voltage (115% of Nominal) 138 Volts	
		Hz	dB	Hz	dB	Hz	dB
-10	7	-40	N/A	N/A	N/A	N/A	N/A
	8	-40	N/A	N/A	N/A	N/A	N/A
	9	-40	N/A	N/A	N/A	N/A	N/A
	10	-40	N/A	N/A	N/A	N/A	N/A
0	0	-20	N/A	N/A	N/A	N/A	N/A
	1	-40	N/A	N/A	N/A	N/A	N/A
	2	-40	N/A	N/A	N/A	N/A	N/A
	3	-20	N/A	N/A	N/A	N/A	N/A
	4	-20	N/A	N/A	N/A	N/A	N/A
	5	-20	N/A	N/A	N/A	N/A	N/A
	6	-20	N/A	N/A	N/A	N/A	N/A
	7	-40	N/A	N/A	N/A	N/A	N/A
	8	-20	N/A	N/A	N/A	N/A	N/A
	9	-20	N/A	N/A	N/A	N/A	N/A
10	-20	N/A	N/A	N/A	N/A	N/A	
+10	0	-10	N/A	N/A	N/A	N/A	N/A
	1	-20	N/A	N/A	N/A	N/A	N/A
	2	-40	N/A	N/A	N/A	N/A	N/A
	3	-20	N/A	N/A	N/A	N/A	N/A
	4	-20	N/A	N/A	N/A	N/A	N/A
	5	-20	N/A	N/A	N/A	N/A	N/A
	6	-40	N/A	N/A	N/A	N/A	N/A
	7	-20	N/A	N/A	N/A	N/A	N/A
	8	-20	N/A	N/A	N/A	N/A	N/A
	9	-20	N/A	N/A	N/A	N/A	N/A
10	-20	N/A	N/A	N/A	N/A	N/A	
+20	0	-10	N/A	-10	N/A	0	N/A
	1	-10	N/A	-10	N/A	-10	N/A
	2	-10	N/A	-20	N/A	-10	N/A
	3	-10	N/A	-10	N/A	-10	N/A
	4	-10	N/A	-10	N/A	-10	N/A
	5	-10	N/A	-10	N/A	-10	N/A
	6	-10	N/A	-20	N/A	-10	N/A
	7	-10	N/A	-10	N/A	-10	N/A
	8	-10	N/A	-10	N/A	-10	N/A
	9	-10	N/A	-10	N/A	-10	N/A
10	-10	N/A	-10	N/A	-10	N/A	

ULTRATECH GROUP OF LABS

3000 Bristol Circle, Oakville, Ontario, Canada L6H 6G4
 Tel. #: 905-829-1570, Fax. #: 905-829-8050, Email: vhk.ultratech@sympatico.ca, Website: <http://www.ultratech-labs.com>

File #: KTI-006FTX
 May 15, 2000

- Assessed by ITI (UK) Competent Body, NVLAP (USA) Accreditation Body & ACA/AUSTEL (Australia)
- Recognized/Listed by FCC (USA), Industry Canada (Canada)
- All test results contained in this engineering test report are traceable to National Institute of Standards and Technology (NIST)

		CENTER FREQUENCY & RF POWER OUTPUT VARIATION					
AMBIENT TEMP.	KEYED-ON TIME	Supply Voltage (Nominal) 120 Volts		Supply Voltage (85% of Nominal) 102 Volts		Supply Voltage (115% of Nominal) 138 Volts	
+30	0	-10	N/A	N/A	N/A	N/A	N/A
	1	-20	N/A	N/A	N/A	N/A	N/A
	2	-20	N/A	N/A	N/A	N/A	N/A
	3	-40	N/A	N/A	N/A	N/A	N/A
	4	-20	N/A	N/A	N/A	N/A	N/A
	5	-20	N/A	N/A	N/A	N/A	N/A
	6	-20	N/A	N/A	N/A	N/A	N/A
	7	-20	N/A	N/A	N/A	N/A	N/A
	8	-20	N/A	N/A	N/A	N/A	N/A
	9	-20	N/A	N/A	N/A	N/A	N/A
10	-20	N/A	N/A	N/A	N/A	N/A	
+40	0	-20	N/A	N/A	N/A	N/A	N/A
	1	-40	N/A	N/A	N/A	N/A	N/A
	2	-20	N/A	N/A	N/A	N/A	N/A
	3	-20	N/A	N/A	N/A	N/A	N/A
	4	-40	N/A	N/A	N/A	N/A	N/A
	5	-40	N/A	N/A	N/A	N/A	N/A
	6	-20	N/A	N/A	N/A	N/A	N/A
	7	-20	N/A	N/A	N/A	N/A	N/A
	8	-20	N/A	N/A	N/A	N/A	N/A
	9	-20	N/A	N/A	N/A	N/A	N/A
10	-20	N/A	N/A	N/A	N/A	N/A	
+50	0	-40	N/A	N/A	N/A	N/A	N/A
	1	-10	N/A	N/A	N/A	N/A	N/A
	2	-40	N/A	N/A	N/A	N/A	N/A
	3	-40	N/A	N/A	N/A	N/A	N/A
	4	-20	N/A	N/A	N/A	N/A	N/A
	5	-20	N/A	N/A	N/A	N/A	N/A
	6	-40	N/A	N/A	N/A	N/A	N/A
	7	-20	N/A	N/A	N/A	N/A	N/A
	8	-20	N/A	N/A	N/A	N/A	N/A
	9	-20	N/A	N/A	N/A	N/A	N/A
10	-20	N/A	N/A	N/A	N/A	N/A	
+60	0	-20	N/A	N/A	N/A	N/A	N/A
	1	-20	N/A	N/A	N/A	N/A	N/A
	2	-20	N/A	N/A	N/A	N/A	N/A
	3	-20	N/A	N/A	N/A	N/A	N/A
	4	-20	N/A	N/A	N/A	N/A	N/A
	5	-20	N/A	N/A	N/A	N/A	N/A
	6	-20	N/A	N/A	N/A	N/A	N/A
	7	-20	N/A	N/A	N/A	N/A	N/A
	8	-20	N/A	N/A	N/A	N/A	N/A
	9	-20	N/A	N/A	N/A	N/A	N/A
10	-20	N/A	N/A	N/A	N/A	N/A	

ULTRATECH GROUP OF LABS

3000 Bristol Circle, Oakville, Ontario, Canada L6H 6G4
 Tel. #: 905-829-1570, Fax. #: 905-829-8050, Email: vhk.ultratech@sympatico.ca, Website: <http://www.ultratech-labs.com>

File #: KTI-006FTX
 May 15, 2000

- Assessed by ITI (UK) Competent Body, NVLAP (USA) Accreditation Body & ACA/AUSTEL (Australia)
- Recognized/Listed by FCC (USA), Industry Canada (Canada)
- All test results contained in this engineering test report are traceable to National Institute of Standards and Technology (NIST)

ULTRATECH GROUP OF LABS

3000 Bristol Circle, Oakville, Ontario, Canada L6H 6G4
Tel. #: 905-829-1570, Fax. #: 905-829-8050, Email: vhk.ultratech@sympatico.ca, Website: <http://www.ultratech-labs.com>

File #: KTI-006FTX
May 15, 2000

- Assessed by ITI (UK) Competent Body, NVLAP (USA) Accreditation Body & ACA/AUSTEL (Australia)
- Recognized/Listed by FCC (USA), Industry Canada (Canada)
- *All test results contained in this engineering test report are traceable to National Institute of Standards and Technology (NIST)*

6.7. MODULATION LIMITING @ FCC 2.987(B) & 90.210

6.7.1. Limits @ FCC 2.987(b) and 90.210

The EUT shall be installed with a modulation limiter which limits the deviation of the FM carrier less than manufacturer's setting provided that the rf output spectrum must meet the required MASK

Recommendation:

- 1.25 kHz for 6.25 kHz Channel Spacing System,
- 2.5 kHz for xxx kHz Channel Spacing ,
- 5 kHz for 25 kHz Channel Spacing System).

6.7.2. Method of Measurements

For Audio Transmitter:- The carrier frequency deviation was measured with the tone input signal level varied from 0 Vp to audio input rating level plus 16 dB at frequencies 0.1, 0.5, 1.0, 3.0 and 5.0 kHz. The maximum deviation was recorded at each test condition.

For Data Transmitter with Maximum Frequency Deviation set by Factory:- The EUT was set at maximum frequency deviation, and its peak frequency deviation was then measured using EUT's internal random data source.

6.7.3. Test Equipment List

Test Instruments	Manufacturer	Model No.	Serial No.	Frequency Range
Communication Analyzer	Rohde & Schawrz	SMF02	879988/057	400 kHz - 1000 MHz including AF & RF Signal Generators, SINAD, DISTORTION, DEVIATION meters and etc

6.7.4. Test Arrangement

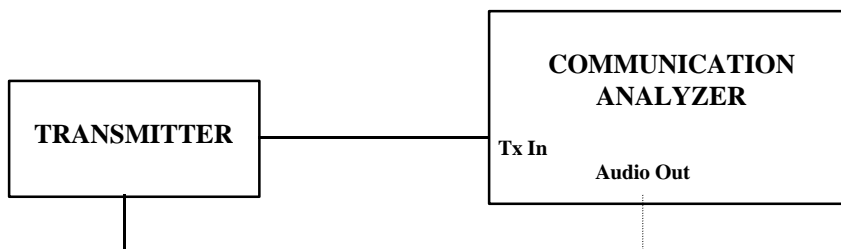

6.7.5. Test Data

Note: Since the EUT is a translator, there is no audio input signal. The demodulated signal characteristics of the RF output are the same as that of the RF input. The following tests show the comparison of the frequency deviation of the input and output signals.

Frequency Deviation of the RF Input Signal (kHz)	Frequency Deviation of the RF Output Signal (kHz)
0.1	0.1
0.5	0.5
1.9	2.0
2.9	3.0
4.0	3.9
5.0	4.9

6.8. EMISSION LIMITATION & EMISSION MASK @ FCC 2.989, 90.209 & 90.910

6.8.1. Limits @ 90.209 & 90.910

Emissions shall be attenuated below the mean output power of the transmitter as follows:

FREQUENCY RANGE (MHz)	Maximum Authorized BW (KHz)	CHANNEL SPACING (KHz)	Recommended FREQ. DEVIATION (KHz)	FCC APPLICABLE MASK
403-512	20.0	25.0	5.0	90.210(b): Mask B – Voice 90.210(c): Mask C – Data

6.8.2. Method of Measurements

Refer to Exhibit 7, Sec. 7.3 of this report for measurement details

6.8.3. Test Equipment List

Test Instruments	Manufacturer	Model No.	Serial No.	Frequency Range
Spectrum Analyzer/ EMI Receiver	Hewlett Packard	HP 8593EM	3412A00103	9 kHz – 26.5 GHz
Attenuator(s)	Bird	DC – 22 GHz
Audio Oscillator	Hewlett Packard	HP 204C	0989A08798	DC to 1.2 MHz

6.8.4. Test Arrangement

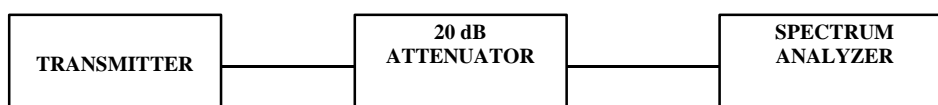

6.8.5. Test Data

Since the radio is the RF translator, the comparison tests between the RF input signal mask and RF output signal mask are conducted for compliance.

Conform. Please refer to the plots below for detailed information.

6.8.6. Plots

Please refer to Plots # 1 to 12 in Exhibit 9 for detailed test measurements.

ULTRATECH GROUP OF LABS

3000 Bristol Circle, Oakville, Ontario, Canada L6H 6G4
 Tel. #: 905-829-1570, Fax. #: 905-829-8050, Email: vhk.ultratech@sympatico.ca, Website: <http://www.ultratech-labs.com>

File #: KTI-006FTX
 May 15, 2000

- Assessed by ITI (UK) Competent Body, NVLAP (USA) Accreditation Body & ACA/AUSTEL (Australia)
- Recognized/Listed by FCC (USA), Industry Canada (Canada)
- All test results contained in this engineering test report are traceable to National Institute of Standards and Technology (NIST)

6.9. TRANSMITTER ANTENNA POWER SPURIOUS/HARMONIC CONDUCTED EMISSIONS @ FCC 90.210

6.9.1. Limits @ 90.210

Emissions shall be attenuated below the mean output power of the transmitter as follows:

FCC RULES	FREQUENCY RANGE	ATTENUATION LIMIT (dBc)
90.210(b)&(c) – Voice & data	10 MHz to Lowest frequency of the radio to 10 th harmonic of the highest frequency of the radio	43+10*log(P) or -13 dBm

6.9.2. Method of Measurements

Refer to Exhibit 7, Sec. 7.4 of this report for measurement details

6.9.3. Test Equipment List

Test Instruments	Manufacturer	Model No.	Serial No.	Frequency Range
Spectrum Analyzer/ EMI Receiver	Hewlett Packard	HP 8593EM	3412A00103	9 kHz – 26.5 GHz
Attenuator(s)	Bird	DC – 22 GHz
Audio Oscillator	Hewlett Packard	HP 204C	0989A08798	DC to 1.2 MHz
Hihpass Filter, Microphase	Microphase	CR220HID	IITI11000AC	Cut-off Frequency at 600 MHz, 1.3 GHz or 4 GHz

6.9.4. Test Arrangement

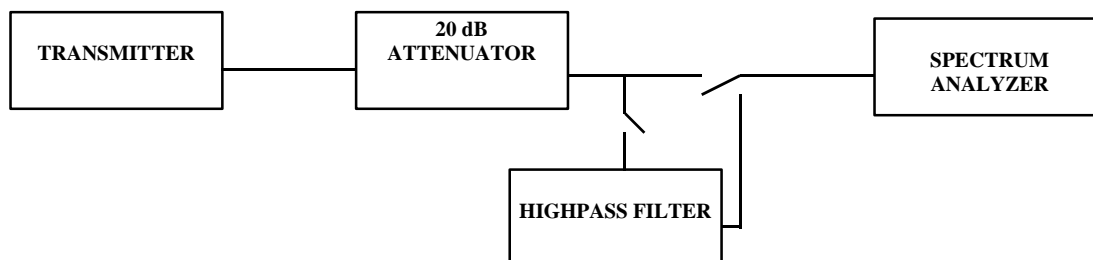

6.9.5. Test Data

6.9.5.1. Near lowest frequency 450 MHz, RF Input Power = -30 dBm, RF Output Power = 9.0 Watts, Modulation: FM with 2.5 kHz sine wave signal.

FREQUENCY (MHz)	RF LEVEL (dBm)	LIMIT (dBm)	MARGIN (dB)	PASS/ FAIL
404.60	-35.6	-13.0	-22.6	PASS
418.70	-28.6	-13.0	-15.6	PASS
434.30	-34.5	-13.0	-21.5	PASS
464.00	-35.3	-13.0	-22.3	PASS
481.00	-25.7	-13.0	-12.7	PASS
493.70	-33.7	-13.0	-20.7	PASS
900.00	-25.8	-13.0	-12.8	PASS
1350.00	-46.5	-13.0	-33.5	PASS

The emissions were scanned from 10 MHz to 5 GHz and all emissions less 30 dB below the limits were recorded.

6.9.5.2. Near lowest frequency 450 MHz, RF Input Power = -30 dBm, RF Output Power = 9.0 Watts, Modulation: FM with 9600 b/s random data (external source).

FREQUENCY (MHz)	RF LEVEL (dBm)	LIMIT (dBm)	MARGIN (dB)	PASS/ FAIL
404.60	-37.8	-13.0	-24.8	PASS
418.70	-28.4	-13.0	-15.4	PASS
434.30	-34.5	-13.0	-21.5	PASS
464.00	-35.5	-13.0	-22.5	PASS
481.00	-25.7	-13.0	-12.7	PASS
493.70	-33.4	-13.0	-20.4	PASS
900.00	-27.2	-13.0	-14.2	PASS
1350.00	-41.8	-13.0	-28.8	PASS

The emissions were scanned from 10 MHz to 5 GHz and all emissions less 30 dB below the limits were recorded.

ULTRATECH GROUP OF LABS

3000 Bristol Circle, Oakville, Ontario, Canada L6H 6G4
 Tel. #: 905-829-1570, Fax. #: 905-829-8050, Email: vhk.ultratech@sympatico.ca, Website: <http://www.ultratech-labs.com>

File #: KTI-006FTX
 May 15, 2000

- Assessed by ITI (UK) Competent Body, NVLAP (USA) Accreditation Body & ACA/AUSTEL (Australia)
- Recognized/Listed by FCC (USA), Industry Canada (Canada)
- All test results contained in this engineering test report are traceable to National Institute of Standards and Technology (NIST)

6.9.5.3. Near lowest frequency 460 MHz, RF Input Power = -30 dBm, RF Output Power = 8.5 Watts, Modulation: FM with 2.5 kHz sine wave signal.

FREQUENCY (MHz)	RF LEVEL (dBm)	LIMIT (dBm)	MARGIN (dB)	PASS/ FAIL
439.90	-29.3	-13.0	-16.3	PASS
479.50	-30.9	-13.0	-17.9	PASS
920.00	-22.3	-13.0	-9.3	PASS
1380.00	-49.3	-13.0	-36.3	PASS
3680.00	-51.7	-13.0	-38.7	PASS
4600.00	-54.5	-13.0	-41.5	PASS

The emissions were scanned from 10 MHz to 5 GHz and all emissions less 30 dB below the limits were recorded.

6.9.5.4. Near lowest frequency 460 MHz, RF Input Power = -30 dBm, RF Output Power = 8.5 Watts, Modulation: FM with 9600 b/s random data (external source).

FREQUENCY (MHz)	RF LEVEL (dBm)	LIMIT (dBm)	MARGIN (dB)	PASS/ FAIL
439.90	-29.4	-13.0	-16.4	PASS
479.50	-30.3	-13.0	-17.3	PASS
920.00	-21.6	-13.0	-8.6	PASS
1380.00	-44.6	-13.0	-31.6	PASS
3680.00	-52.3	-13.0	-39.3	PASS
4600.00	-60.0	-13.0	-47.0	PASS

The emissions were scanned from 10 MHz to 5 GHz and all emissions less 30 dB below the limits were recorded.

6.9.5.5. Near lowest frequency 470 MHz, RF Input Power = -30 dBm, RF Output Power = 8.3 Watts, Modulation: FM with 2.5 kHz sine wave signal.

FREQUENCY (MHz)	RF LEVEL (dBm)	LIMIT (dBm)	MARGIN (dB)	PASS/ FAIL
451.30	-33.3	-13.0	-20.3	PASS
459.70	-20.9	-13.0	-7.9	PASS
479.50	-21.9	-13.0	-8.9	PASS
488.00	-32.3	-13.0	-19.3	PASS
940.00	-20.2	-13.0	-7.2	PASS
1410.00	-51.8	-13.0	-38.8	PASS
3760.00	-48.3	-13.0	-35.3	PASS

The emissions were scanned from 10 MHz to 5 GHz and all emissions less 30 dB below the limits were recorded.

6.9.5.6. Near lowest frequency 470 MHz, RF Input Power = -30 dBm, RF Output Power = 8.3 Watts, Modulation: FM with 9600 b/s random data (external source).

FREQUENCY (MHz)	RF LEVEL (dBm)	LIMIT (dBm)	MARGIN (dB)	PASS/ FAIL
451.30	-33.1	-13.0	-20.1	PASS
459.70	-22.3	-13.0	-9.3	PASS
479.50	-23.3	-13.0	-10.3	PASS
488.00	-33.0	-13.0	-20.0	PASS
940.00	-20.2	-13.0	-7.2	PASS
1410.00	-47.4	-13.0	-34.4	PASS
3760.00	-53.2	-13.0	-40.2	PASS

The emissions were scanned from 10 MHz to 5 GHz and all emissions less 30 dB below the limits were recorded.

6.9.6. Plots

Please refer to Plots # 13 to 18 in Exhibit 9 for detailed test measurements.

6.10. TRANSMITTER SPURIOUS/HARMONIC RADIATED EMISSIONS @ FCC 90.210

6.10.1. Limits @ FCC 90.210

Emissions shall be attenuated below the mean output power of the transmitter as follows:

FCC RULES	FREQUENCY RANGE	ATTENUATION LIMIT (dBc)
90.210(b)&(c) – Voice & data	10 MHz to Lowest frequency of the radio to 10 th harmonic of the highest frequency of the radio	43+10*log(P) or -13 dBm

6.10.2. Method of Measurements

Refer to Exhibit 7, Sec. 7.5 of this report and ANSI C63-4:1992 for radiated emissions test method.

6.10.3. Test Equipment List

Test Instruments	Manufacturer	Model No.	Serial No.	Frequency Range
Spectrum Analyzer/ EMI Receiver	Advantest	R3271	15050203	100 Hz to 32 GHz with external mixer for frequency above 32 GHz
Microwave Amplifier	Hewlett Packard	HP 83017A		1 GHz to 26.5 GHz
Active Loop Antenna	EMCO	6507	8906-1167	1 kHz – 30 MHz
Biconilog Antenna	EMCO	3143	1029	20 MHz to 2 GHz
Horn Antenna	EMCO	3155	9701-5061	1 GHz – 18 GHz
Horn Antenna	EMCO	3160-09	..	18 GHz – 26.5 GHz
Horn Antenna	EMCO	3160-10	..	26.5 GHz – 40 GHz
Mixer	Tektronix	118-0098-00	..	18 GHz – 26.5 GHz
Mixer	Tektronix	119-0098-00	..	26.5 GHz – 40 GHz

ULTRATECH GROUP OF LABS

3000 Bristol Circle, Oakville, Ontario, Canada L6H 6G4
 Tel. #: 905-829-1570, Fax. #: 905-829-8050, Email: vhk.ultratech@sympatico.ca, Website: <http://www.ultratech-labs.com>

File #: KTI-006FTX
 May 15, 2000

- Assessed by ITI (UK) Competent Body, NVLAP (USA) Accreditation Body & ACA/AUSTEL (Australia)
- Recognized/Listed by FCC (USA), Industry Canada (Canada)
- All test results contained in this engineering test report are traceable to National Institute of Standards and Technology (NIST)

6.10.4. Test Arrangement

The following drawings show details of the test setup for radiated emissions measurements

6.10.5. Test Data

Remarks: Since there is no significant difference in RF conducted emissions when the radio receives and transmits the rf signal with FM data modulation and voice modulation, the radiated emissions will be conducted with either FM voice modulation or FM data modulation.

6.10.5.1. Near lowest frequency 450 MHz, RF Input Power = -30 dBm, RF Output Power =9.0 Watts, Modulation: FM with 2.5 kHz sine wave signal.

FREQUENCY (MHz)	RF Field Level @3m (dBuV/m)	RF Power Level (dBm)	DETECTOR USED (PEAK/QP)	ANTENNA PLANE (H/V)	LIMIT @3m (dBm)	MARGIN (dB)	PASS/FAIL
900.00	67.2	-30.3	PEAK	V	-13.0	-17.3	PASS
900.00	41.2	-56.3	PEAK	H	-13.0	-43.3	PASS
1350.00	39.7	-57.8	PEAK	V	-13.0	-44.8	PASS
1350.00	37.0	-60.5	PEAK	H	-13.0	-47.5	PASS
2250.00	42.7	-54.8	PEAK	V	-13.0	-41.8	PASS
2250.00	43.3	-54.2	PEAK	H	-13.0	-41.2	PASS

The emissions were scanned from 10 MHz to 5 GHz and all emissions less 50 dB below the limits were recorded.

6.10.5.2. Near lowest frequency 460 MHz, RF Input Power = -30 dBm, RF Output Power =8.5 Watts, Modulation: FM with 9600 b/s random data.

FREQUENCY (MHz)	RF Field Level @3m (dBuV/m)	RF Power Level (dBm)	DETECTOR USED (PEAK/QP)	ANTENNA PLANE (H/V)	LIMIT @3m (dBm)	MARGIN (dB)	PASS/FAIL
920.00	67.2	-30.3	PEAK	V	-13.0	-17.3	PASS
920.00	42.8	-54.7	PEAK	H	-13.0	-41.7	PASS
1380.00	39.7	-57.8	PEAK	V	-13.0	-44.8	PASS
1380.00	40.3	-57.2	PEAK	H	-13.0	-44.2	PASS
1840.00	42.7	-54.8	PEAK	V	-13.0	-41.8	PASS
1840.00	42.4	-55.1	PEAK	H	-13.0	-42.1	PASS

The emissions were scanned from 10 MHz to 5 GHz and all emissions less 50 dB below the limits were recorded.

6.10.5.3. Near lowest frequency 470 MHz, RF Input Power = -30 dBm, RF Output Power =8.3 Watts, Modulation: FM with 2.5 kHz sine wave signal.

FREQUENCY (MHz)	RF Field Level @3m (dBuV/m)	RF Power Level (dBm)	DETECTOR USED (PEAK/QP)	ANTENNA PLANE (H/V)	LIMIT @3m (dBm)	MARGIN (dB)	PASS/ FAIL
940.00	38.7	-58.8	PEAK	V	-13.0	-45.8	PASS
940.00	36.2	-61.3	PEAK	H	-13.0	-48.3	PASS
1410.00	40.8	-56.7	PEAK	V	-13.0	-43.7	PASS
1410.00	39.1	-58.4	PEAK	H	-13.0	-45.4	PASS
1880.00	42.4	-55.1	PEAK	V	-13.0	-42.1	PASS
1880.00	42.4	-55.1	PEAK	H	-13.0	-42.1	PASS

The emissions were scanned from 10 MHz to 5 GHz and all emissions less 50 dB below the limits were recorded.

6.10.6. Plots

None

6.10.7. Photographs of Test Setup

Please refer to Photos # 1 and 2 in Exhibit 10

EXHIBIT 7. MEASUREMENT UNCERTAINTY

The measurement uncertainties stated were calculated in accordance with the requirements of NIST Technical Note 1297 and NIS 81 (1994)

7.1. RADIATED EMISSION MEASUREMENT UNCERTAINTY

CONTRIBUTION (Radiated Emissions)	PROBABILITY DISTRIBUTION	UNCERTAINTY (\pm dB)	
		3 m	10 m
Antenna Factor Calibration	Normal (k=2)	± 1.0	± 1.0
Cable Loss Calibration	Normal (k=2)	± 0.3	± 0.5
EMI Receiver specification	Rectangular	± 1.5	± 1.5
Antenna Directivity	Rectangular	± 0.5	± 0.5
Antenna factor variation with height	Rectangular	± 2.0	± 0.5
Antenna phase center variation	Rectangular	0.0	± 0.2
Antenna factor frequency interpolation	Rectangular	± 0.25	± 0.25
Measurement distance variation	Rectangular	± 0.6	± 0.4
Site imperfections	Rectangular	± 2.0	± 2.0
Mismatch: Receiver VRC $\Gamma_1 = 0.2$ Antenna VRC $\Gamma_R = 0.67(\text{Bi}) 0.3 (\text{Lp})$ Uncertainty limits $20\text{Log}(1 \pm \Gamma_1 \Gamma_R)$	U-Shaped	+1.1 -1.25	± 0.5
System repeatability	Std. Deviation	± 0.5	± 0.5
Repeatability of EUT		-	-
Combined standard uncertainty	Normal	+2.19 / -2.21	+1.74 / -1.72
Expanded uncertainty U	Normal (k=2)	+4.38 / -4.42	+3.48 / -3.44

Calculation for maximum uncertainty when 3m biconical antenna including a factor of k=2 is used:

$$U = 2u_c(y) = 2x(+2.19) = +4.38 \text{ dB} \quad \text{And} \quad U = 2u_c(y) = 2x(-2.21) = -4.42 \text{ dB}$$

ULTRATECH GROUP OF LABS

3000 Bristol Circle, Oakville, Ontario, Canada L6H 6G4
 Tel. #: 905-829-1570, Fax. #: 905-829-8050, Email: vhk.ultratech@sympatico.ca, Website: <http://www.ultratech-labs.com>

File #: KTI-006FTX
 May 15, 2000

- Assessed by ITI (UK) Competent Body, NVLAP (USA) Accreditation Body & ACA/AUSTEL (Australia)
- Recognized/Listed by FCC (USA), Industry Canada (Canada)
- All test results contained in this engineering test report are traceable to National Institute of Standards and Technology (NIST)

EXHIBIT 8. MEASUREMENT METHODS

8.1. EFFECTIVE RADIATED POWER (ERP) MEASUREMENTS

- The following shall be applied to the combination(s) of the radio device and its intended antenna(e).
- If the RF level is user adjustable, all measurements shall be made with the highest power level available to the user for that combination.
- The following method of measurement shall apply to both conducted and radiated measurements.
- The radiated measurements are performed at the Ultratech Calibrated Open Field Test Site.
- The measurement shall be performed using normal operation of the equipment with modulation.

Test procedure shall be as follows:

Step 1: Duty Cycle measurements

- Using a spectrum analyzer with the frequency span set to 0 Hz and the sweep time set at a suitable value to capture the envelope peaks and the duty cycle of the transmitter output signal;
- The duty cycle of the transmitter, $x = \text{Tx on} / (\text{Tx on} + \text{Tx off})$ with $0 < x < 1$, is measure and recorded in the test report. For the purpose of testing, the equipment shall be operated with a duty cycle that is equal or more than 0.1.

Step 2: Calculation of Average EIRP. See Figure 1

- The average output power of the transmitter shall be determined using a wideband, calibrated RF power meter with the power sensor with an integration period that exceeds the repetition period of the transmitter by a factor 5 or more. The observed value shall be recorded as “A” (in dBm);
- The e.i.r.p. shall be calculated from the above measured power output “A”, the observed duty cycle x, and the dBi, according to the formula:

$$\text{EIRP} = \text{A} + \text{G} + 10\log(1/x)$$

Figure 1.

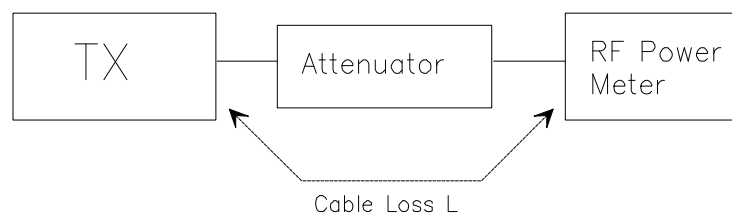

Step 3: Substitution Method. See Figure 2

- (a) The measurements was performed in the absence of modulation (un-modulated)
- (b) Test was performed at listed 3m open area test site (listed with FCC, IC, ITI, NVLAP, ACA & VCCI).
- (c) The transmitter under test was placed at the specified height on a non-conducting turntable (80 cm height)
- (d) The dipole test antenna was used and tuned to the transmitter carrier frequency.
- (e) The spectrum analyzer was tuned to transmitter carrier frequency. The test antenna was lowered or raised from 1 to 4 meters until the maximum signal level was detected.
- (f) The transmitter was rotated through 360° about a vertical axis until a higher maximum signal was received.
- (g) The test antenna was lowered or raised again from 1 to 4 meters until a maximum was obtained. This level was recorded.

ULTRATECH GROUP OF LABS

3000 Bristol Circle, Oakville, Ontario, Canada L6H 6G4
Tel. #: 905-829-1570, Fax. #: 905-829-8050, Email: vhk.ultratech@sympatico.ca, Website: <http://www.ultratech-labs.com>

File #: KTI-006FTX
May 15, 2000

- Assessed by ITI (UK) Competent Body, NVLAP (USA) Accreditation Body & ACA/AUSTEL (Australia)
- Recognized/Listed by FCC (USA), Industry Canada (Canada)
- All test results contained in this engineering test report are traceable to National Institute of Standards and Technology (NIST)

- (h) The substitution dipole antenna and the signal generator replaced the transmitter and antenna under test in the same position, and the substitution dipole antenna was placed in vertical polarization. The test dipole antenna was lowered or raised as necessary to ensure that the maximum signal is still received.
- (i) The input signal to the substitution antenna was adjusted in level until an equal or a known related level to that detected from the transmitter was obtained in the test receiver. The maximum carrier radiated power is equal to the power supply by the generator.
- (j) The substitution antenna gain and cable loss were added to the signal generator level for the corrected ERP level.
- (k) Repeat steps (c) to (j) with the substitution antenna oriented in horizontal polarization.
- (l) Actual gain of the EUT's antenna is the difference of the measured ERP and measured RF power at the RF port. Correct the antenna gain if necessary.

Figure 2

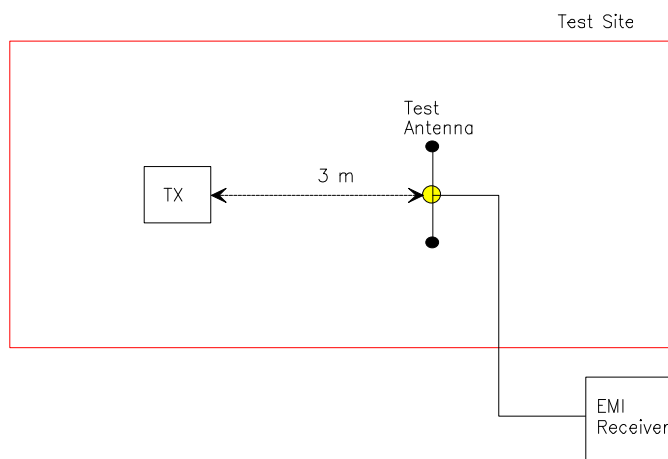
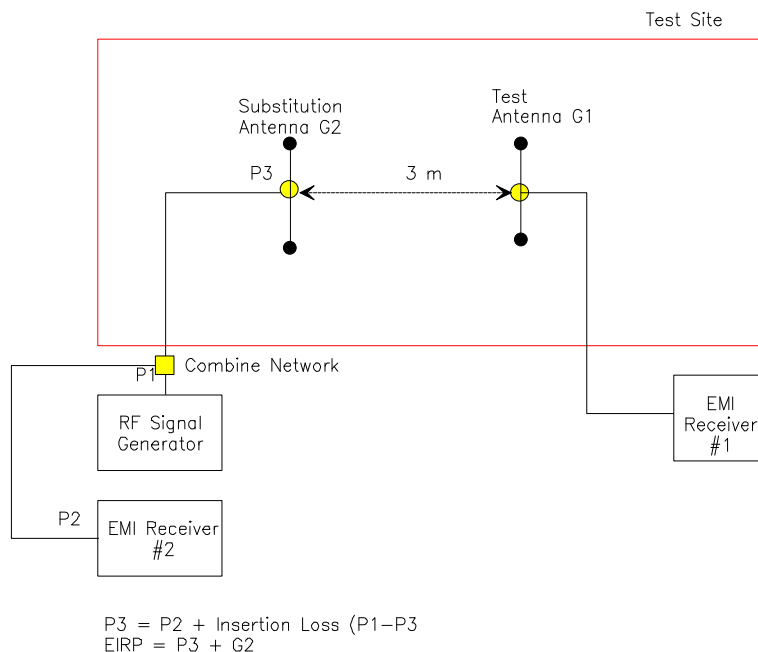

Figure 3



ULTRATECH GROUP OF LABS

3000 Bristol Circle, Oakville, Ontario, Canada L6H 6G4
 Tel. #: 905-829-1570, Fax. #: 905-829-8050, Email: vhk.ultratech@sympatico.ca, Website: <http://www.ultratech-labs.com>

File #: KTI-006FTX
 May 15, 2000

- Assessed by ITI (UK) Competent Body, NVLAP (USA) Accreditation Body & ACA/AUSTEL (Australia)
- Recognized/Listed by FCC (USA), Industry Canada (Canada)
- All test results contained in this engineering test report are traceable to National Institute of Standards and Technology (NIST)

8.2. FREQUENCY STABILITY

Refer to FCC @ 2.995.

- (a) The frequency stability shall be measured with variation of ambient temperature as follows: From -30 to +50 centigrade except that specified in subparagraph (2) & (3) of this paragraph.
- (b) Frequency measurements shall be made at extremes of the specified temperature range and at intervals of not more than 10 centigrade through the range. A period of time sufficient to stabilize all of the components of the oscillator circuit at each temperature level shall be allowed prior to frequency measurement. The short term transient effects on the frequency of the transmitter due to keying (except for broadcast transmitters) and any heating element cycling normally occurring at each ambient temperature level also shall be shown. Only the portion or portions of the transmitter containing the frequency determining and stability circuitry need be subjected to the temperature variation test.
- (d) The frequency stability supply shall be measured with variation of primary supply voltage as follows:
- (1) Vary primary supply voltage from 85 to 115 percent of the nominal value for other than hand carried battery equipment.
 - (2) For hand carried, battery powered equipment, reduce primary supply voltage to the battery operating end point which shall be specified by the manufacturer.
 - (3) The supply voltage shall be measured at the input to the cable normally provide with the equipment, or at the power supply terminals if cables are not normally provided. Effects on frequency of transmitter keying (except for broadcast transmitters) and any heating element cycling at the nominal supply voltage and at each extreme also shall be shown.
- (e) When deemed necessary, the Commission may require tests of frequency stability under conditions in addition to those specifically set out in paragraphs (a), (b), (c) and (d) of this section. (For example, measurements showing the effect of proximity to large metal objects, or of various types of antennas, may be required for portable equipment).

ULTRATECH GROUP OF LABS

3000 Bristol Circle, Oakville, Ontario, Canada L6H 6G4
Tel. #: 905-829-1570, Fax. #: 905-829-8050, Email: vhk.ultratech@sympatico.ca, Website: <http://www.ultratech-labs.com>

File #: KTI-006FTX
May 15, 2000

- Assessed by ITI (UK) Competent Body, NVLAP (USA) Accreditation Body & ACA/AUSTEL (Australia)
- Recognized/Listed by FCC (USA), Industry Canada (Canada)
- All test results contained in this engineering test report are traceable to National Institute of Standards and Technology (NIST)

8.3. EMISSION MASK

Voice or Digital Modulation Through a Voice Input Port @ 2.989(c)(i):- The transmitter was modulated by a 2.5 KHz tone signal at an input level 16 dB greater than that required to produce 50% modulation (e.g.: ± 2.5 KHz peak deviation at 1 KHz modulating frequency). The input level was established at the frequency of maximum response of the audio modulating circuit.

Digital Modulation Through a Data Input Port @ 2.989(h):- Transmitters employing digital modulation techniques - when modulated by an input signal such that its amplitude and symbol rate represent the maximum rated conditions under which the equipment will be operated. The signal shall be applied through any filter networks, pseudo-random generators or other devices required in normal service. Additionally, the Emission Masks shall be shown for operation with any devices used for modifying the spectrum when such devices are operational at the discretion of the user.

The following spectrum analyzer bandwidth shall be used for measurement of Emission Mask/Out-of-Band Emission Measurements:

- (1) For 25 kHz Channel Spacing: RBW = 300 Hz
- (2) For 12.5 kHz or 6.25 kHz Channel Spacings: RBW = 100 Hz

The all cases the Video Bandwidth shall be equal or greater than the measuring bandwidth.

8.4. SPURIOUS EMISSIONS (CONDUCTED)

With transmitter modulation characteristics described in Out-of-Band Emissions measurements @ 2.989, the transmitter spurious and harmonic emissions were scanned. The spurious and harmonic emissions were measured with the Spectrum Analyzer controls set as RBW = 30 kHz minimum , VBW \geq RBW and SWEEP TIME = AUTO). The transmitter was operated at a full rated power output, and modulated as follows:

FCC CFR 47, Para. 2.997 - Frequency spectrum to be investigated:- The spectrum was investigated from the lowest radio generated in the equipment up to at least the 10th harmonic of the carrier frequency or to the highest frequency practicable in the present state of the art of measuring techniques, whichever is lower. Particular attention should be paid to harmonics and subharmonics of the carrier frequency. Radiation at the frequencies of multiplier stages should be checked. The amplitude of spurious emissions which are attenuated more than 20 dB below the permissible value need not be reported.

FCC CFR 47, Para. 2.991 - Spurious Emissions at Antenna Terminal:- The radio frequency voltage or powers generated within the equipment and appearing on a spurious frequency shall be checked at the equipment output terminals when properly loaded with a suitable artificial antenna. Curves or equivalent data shall show the magnitude of the harmonic and other spurious emission that can be detected when the equipment is operated under the conditions specified in 2.989 as appropriate. The magnitude of spurious emissions which are attenuated more than 20 dB below the permissible value need not be specified.

ULTRATECH GROUP OF LABS

3000 Bristol Circle, Oakville, Ontario, Canada L6H 6G4
Tel. #: 905-829-1570, Fax. #: 905-829-8050, Email: vhk.ultratech@sympatico.ca, Website: <http://www.ultratech-labs.com>

File #: KTI-006FTX
May 15, 2000

- Assessed by ITI (UK) Competent Body, NVLAP (USA) Accreditation Body & ACA/AUSTEL (Australia)
- Recognized/Listed by FCC (USA), Industry Canada (Canada)
- All test results contained in this engineering test report are traceable to National Institute of Standards and Technology (NIST)

8.5. SPURIOUS EMISSIONS (RADIATED)

With transmitter modulation characteristics described in Out-of-Band Emissions measurements @ 2.989, the transmitter spurious and harmonic emissions were scanned. The spurious and harmonic emissions were measured with the Spectrum Analyzer controls set as RBW = 100 kHz minimum , VBW \geq RBW and SWEEP TIME = AUTO). The transmitter was operated at a full rated power output, and modulated as follows:

FCC CFR 47, Para. 2.997 - Frequency spectrum to be investigated:- The spectrum was investigated from the lowest radio generated in the equipment up to at least the 10th harmonic of the carrier frequency or to the highest frequency practicable in the present state of the art of measuring techniques, whichever is lower. Particular attention should be paid to harmonics and subharmonics of the carrier frequency. Radiation at the frequencies of multiplier stages should be checked. The amplitude of spurious emissions which are attenuated more than 20 dB below the permissible value need not be reported.

FCC CFR 47, Para. 2.993 - Field Strength Spurious Emissions

- (a) Measurements was made to detect spurious emissions radiated directly from the cabinet, control circuits, power leads, or intermediate circuit elements under normal conditions of installation and operation. Curves or equivalent data were supplied showing the magnitude of each harmonic and other spurious emission. For this test, single sideband, independent sideband, and controlled carrier transmitters shall be modulated under the conditions specified in paragraph 2.989(c) as appropriate. For equipment operating on frequencies below 1 GHz , an Open Field Test is normally required, with the measuring instrument antenna located in the far field at all test frequencies. In event it is either impractical or impossible to make open field measurements (e.g. a broadcast transmitter installed in a building) measurement will be accepted of the equipment as installed. Such measurements must be accompanied by a description of the site where the measurements were made showing the location of any possible source of reflections which might distort the field strength measurements. Information submitted shall include the relative radiated power of each spurious emission with the reference to the rated power output of the transmitter, assuming all emissions are radiated from half-wave dipole antennas.
- (b) Measurements specified in paragraph (a) of this section shall be made for the following equipment:
 - (1) Those in which the spurious emission are required to be 60 dB or more below the mean power of the transmitter.
 - (2) All equipment operating on frequencies higher than 25 MHz
 - (3) All equipment where the antenna is an integral part of, and attached directly to the transmitter.
 - (4) Other types of equipment as required, when deemed necessary by the Commission.

Maximizing RF Emission Level:

- (a) The measurements was performed with standard modulation
- (b) Test was performed at listed 3m open area test site (listed with FCC, IC, ITI, NVLAP, ACA & VCCI).
- (c) The transmitter under test was placed at the specified height on a non-conducting turntable (80 cm height)
- (d) The biconilog Antenna (20 MHz to 1 GHz) or Horn Antenna (1 GHz to 18 GHz) was used for measuring.
- (e) The spectrum analyzer was tuned to transmitter carrier frequency. The test antenna was lowered or raised from 1 to 4 meters until the maximum signal level was detected.
- (f) The transmitter was rotated through 360° about a vertical axis until a higher maximum signal was received.
- (g) The test antenna was lowered or raised again from 1 to 4 meters until a maximum was obtained. This level was recorded.
- (h) The recorded reading was corrected to the true field strength level by adding the antenna factor, cable loss and subtracting the pre-amplifier gain.

ULTRATECH GROUP OF LABS

3000 Bristol Circle, Oakville, Ontario, Canada L6H 6G4
Tel. #: 905-829-1570, Fax. #: 905-829-8050, Email: vhk.ultratech@sympatico.ca, Website: <http://www.ultratech-labs.com>

File #: KTI-006FTX
May 15, 2000

- Assessed by ITI (UK) Competent Body, NVLAP (USA) Accreditation Body & ACA/AUSTEL (Australia)
- Recognized/Listed by FCC (USA), Industry Canada (Canada)
- All test results contained in this engineering test report are traceable to National Institute of Standards and Technology (NIST)

- (i) The field strength level measured at 3m is converted to the power in dBm by subtracting a constant factor of 97.5 dB

METHOD OF CALCULATION FOR TRANSMITTED POWER (P) FROM THE MEASURED FIELD STRENGTH LEVEL (E):

According to IEC 801-3, the power density can be calculated as follows:

$$S = P / (4 \times \pi \times D^2) \quad \text{Where: } S: \text{ Power density in watts per square foot}$$

$$P: \text{ Transmitted power in watts}$$

$$\pi: 13.1415$$

$$D: \text{ Distance in meters}$$

The power density S (W/m^2) and electric field E (V/m) is related by:

$$S = E^2 / (120 \times \pi)$$

Accordingly, the field intensity of isotropic radiator in free space can be expressed as follows:

$$E = (30 \times P)^{1/2} / D = 5.5 \times (P)^{1/2} / D$$

For Halfwave dipole antenna or other antennas correlated to dipole in direction of maximum radiation:

$$S = (1.64 \times P) / (4 \times \pi \times D^2)$$

$$E = (49.2 \times P)^{1/2} / D = 7.01 \times (P)^{1/2} / D$$

$$P = (E \times D / 7.01)^2$$

Calculation of transmitted power P (dBm) given a measured field intensity E (dBuV/m):

$$P(W) = [E(V/m) \times D / 7.01]^2$$

$$P(mW) = P(W) \times 1000$$

$$\Rightarrow P(dBm) = 10 \log P(mW)$$

$$= 20 \log E(V/m) + 20 \log(D) - 20 \log(7.01) + 10 \log 1000$$

$$= E(dBV/m) + 20 \log D + 13$$

$$= E(dBuV/m) - 120 + 20 \log(D) + 13$$

$$= E(dBuV/m) + 20 \log(D) - 107$$

The Transmitted Power @ $D = 3$ Meters

$$P(dBm) = E(dBuV/m) - 97.5$$