



FCC 47 CFR PART 15 SUBPART C

TEST REPORT

For

Car Alarm Transmitter

Model: TX731A

Brand Name: Advance Security Inc.

Issued to

Advance Security Inc.
3F, 48 Ta An Street, Hsi Chih, Taipei Hsien,
TAIWAN R.O.C.

Issued by

Compliance Certification Services Inc.
Xndian Lab.
No.163-1, Jhongsheng Rd., Xindian Dist.,
New Taipei City, 23151 Taiwan.
TEL: (02) 2217-0894
FAX: (02) 2217-1029



Note: This report shall not be reproduced except in full, without the written approval of Compliance Certification Services Inc. This document may be altered or revised by Compliance Certification Services Inc. personnel only, and shall be noted in the revision section of the document.



TABLE OF CONTENTS

1. TEST RESULT CERTIFICATION.....	3
2. EUT DESCRIPTION	4
3. TEST METHODOLOGY	5
3.1 EUT CONFIGURATION	5
3.2 EUT EXERCISE	5
3.3 GENERAL TEST PROCEDURES	5
3.4 FCC PART 15.205 RESTRICTED BANDS OF OPERATIONS	6
3.5 DESCRIPTION OF TEST MODES	6
4. INSTRUMENT CALIBRATION.....	7
4.1 MEASURING INSTRUMENT CALIBRATION	7
4.2 MEASUREMENT EQUIPMENT USED	7
4.3 MEASUREMENT UNCERTAINTY	8
5. FACILITIES AND ACCREDITATIONS	8
5.1 FACILITIES	8
5.2 EQUIPMENT	8
5.3 TABLE OF ACCREDITATIONS AND LISTINGS	9
6. SETUP OF EQUIPMENT UNDER TEST	9
6.1 SETUP CONFIGURATION OF EUT	9
6.2 SUPPORT EQUIPMENT	9
7. FCC PART 15.231 REQUIREMENTS.....	10
7.1 20dB BANDWIDTH	10
7.2 LIMIT OF TRANSMISSION TIME	12
7.3 DUTY CYCLE CORRECTION FACTOR.....	14
7.4 RADIATED EMISSIONS	17
7.5 POWERLINE CONDUCTED EMISSIONS	25
APPENDIX I-PHOTOGRAPHS OF TEST SETUP.....	26



1. TEST RESULT CERTIFICATION

Applicant: Advance Security Inc.
 3F, 48 Ta An Street, Hsi Chih, Taipei Hsien,
 TAIWAN R.O.C.

Equipment Under Test: Car Alarm Transmitter

Brand Name: Advance Security Inc.

Model: TX731A

Date of Test: April 2, 2012 ~ April 7, 2012

APPLICABLE STANDARDS	
STANDARD	TEST RESULT
FCC 47 CFR Part 15 Subpart C	No non-compliance noted

We hereby certify that:

The above equipment was tested by Compliance Certification Services Inc. SINDIAN BU. The test data, data evaluation, test procedures, and equipment configurations shown in this report were made in accordance with the procedures given in ANSI C63.4: 2009 and the energy emitted by the sample EUT tested as described in this report is in compliance with conducted and radiated emission limits of FCC Rules Part 15.207, 15.209 and Part 15.231.

The test results of this report relate only to the tested sample identified in this report.

Approved by:

Reviewed by:

 Sam Hu
 Section Manager

 Vesta Hsu
 Supervisor of report document dept.



2. EUT DESCRIPTION

Product	Car Alarm Transmitter
Brand Name	Advance Security Inc.
Model Number	TX731A
Modulation Technique	ASK
Power Supply	6VDC Battery
Frequency Range	433.92 MHz
Antenna Specification	Helical Antenna / Gain: -2.5dbi
Associated Receiver	H50TR45

Remark:

1. *The sample selected for test was production product and was provided by manufacturer.*
2. *This submittal(s) (test report) is intended for FCC ID: H50T51 filing to comply with Section 15.207, 15.209 and 15.231 of the FCC Part 15, Subpart C Rules.*



3. TEST METHODOLOGY

The tests documented in this report were performed in accordance with ANSI C63.4 (2009) and FCC CFR 47 2.1046, 2.1047, 2.1049, 2.1051, 2.1053, 2.1055, 2.1057, 15.207, 15.209 and 15.231.

3.1 EUT CONFIGURATION

The EUT configuration for testing is installed on RF field strength measurement to meet the Commissions requirement and operating in a manner that intends to maximize its emission characteristics in a continuous normal application.

3.2 EUT EXERCISE

The EUT was operated in the engineering mode to fix the TX frequency that was for the purpose of the measurements.

3.3 GENERAL TEST PROCEDURES

Conducted Emissions

The EUT is placed on the turntable, which is 0.8 m above ground plane. According to the requirements in Section 13.1.4.1 of ANSI C63.4. Conducted emissions from the EUT measured in the frequency range between 0.15 MHz and 30MHz using CISPR Quasi-peak and average detector modes.

Radiated Emissions

The EUT is placed on a turn table, which is 0.8 m above ground plane. The turntable shall rotate 360 degrees to determine the position of maximum emission level. EUT is set 3m away from the receiving antenna, which varied from 1m to 4m to find out the highest emission. And also, each emission was to be maximized by changing the polarization of receiving antenna both horizontal and vertical. In order to find out the maximum emissions, exploratory radiated emission measurements were made according to the requirements in Section 13.1.4.1 of ANSI C63.4.



3.4 FCC PART 15.205 RESTRICTED BANDS OF OPERATIONS

(a) Except as shown in paragraph (d) of this section, only spurious emissions are permitted in any of the frequency bands listed below:

MHz	MHz	MHz	GHz
0.090 - 0.110	16.42 - 16.423	399.9 - 410	4.5 - 5.15
¹ 0.495 - 0.505	16.69475 - 16.69525	608 - 614	5.35 - 5.46
2.1735 - 2.1905	16.80425 - 16.80475	960 - 1240	7.25 - 7.75
4.125 - 4.128	25.5 - 25.67	1300 - 1427	8.025 - 8.5
4.17725 - 4.17775	37.5 - 38.25	1435 - 1626.5	9.0 - 9.2
4.20725 - 4.20775	73 - 74.6	1645.5 - 1646.5	9.3 - 9.5
6.215 - 6.218	74.8 - 75.2	1660 - 1710	10.6 - 12.7
6.26775 - 6.26825	108 - 121.94	1718.8 - 1722.2	13.25 - 13.4
6.31175 - 6.31225	123 - 138	2200 - 2300	14.47 - 14.5
8.291 - 8.294	149.9 - 150.05	2310 - 2390	15.35 - 16.2
8.362 - 8.366	156.52475 -	2483.5 - 2500	17.7 - 21.4
8.37625 - 8.38675	156.52525	2655 - 2900	22.01 - 23.12
8.41425 - 8.41475	156.7 - 156.9	3260 - 3267	23.6 - 24.0
12.29 - 12.293	162.0125 - 167.17	3332 - 3339	31.2 - 31.8
12.51975 - 12.52025	167.72 - 173.2	3345.8 - 3358	36.43 - 36.5
12.57675 - 12.57725	240 - 285	3600 - 4400	(²)
13.36 - 13.41	322 - 335.4		

¹ Until February 1, 1999, this restricted band shall be 0.490-0.510 MHz.

² Above 38.6

(b) Except as provided in paragraphs (d) and (e), the field strength of emissions appearing within these frequency bands shall not exceed the limits shown in Section 15.209. At frequencies equal to or less than 1000 MHz, compliance with the limits in Section 15.209 shall be demonstrated using measurement instrumentation employing a CISPR quasi-peak detector. Above 1000 MHz, compliance with the emission limits in Section 15.209 shall be demonstrated based on the average value of the measured emissions. The provisions in Section 15.35 apply to these measurements.

3.5 DESCRIPTION OF TEST MODES

The EUT (model: TX731A) had been tested under engineering test mode condition and the EUT staying in continuous transmitting mode.

The field strength of spurious emission was measured in the following position: EUT stand-up position (Z axis), lie-down position (X, Y axis). The worst emission was found in lie-down position (Y axis) and the worst case was recorded.



4. INSTRUMENT CALIBRATION

4.1 MEASURING INSTRUMENT CALIBRATION

The measuring equipment, which was utilized in performing the tests documented herein, has been calibrated in accordance with the manufacturer's recommendations for utilizing calibration equipment, which is traceable to recognized national standards

4.2 MEASUREMENT EQUIPMENT USED

Equipment Used for Emissions Measurement

Remark: Each piece of equipment is scheduled for calibration once a year.

Open Area Test Site Chamber #D				
Name of Equipment	Manufacturer	Model	Serial Number	Calibration Due
MEASURE RECEIVER	R&S	ESCI	101202	09/05/2012
ANTENNA (30-1000MHz)	SUNOL	JB1	A022310	10/05/2012
PRE-AMPLIFIER	EMCI	EMC330	980022	01/29/2013
CABLE (30-1000MHz)	HUBER +SUHNER	SUCOFLEX 102	33105/2	01/29/2013
CABLE (20-1000MHz)	EMCI	EMCI-C-14	CH-D#13	01/29/2013
ATTENUATOR	MCL	BW-S6W5	CH-D#14	01/29/2013
SPECTRUM ANALYZER (9kHz-30GHz)	R&S	FSP 30	100112	10/25/2012
SPECTRUM ANALYZER (9kHz-40GHz)	Agilent	E4446A	MY43360132	06/19/2012
ANTENNA (1-18GHz)	ETS	3117	00139062	10/23/2012
AMPLIFIER (1-26.5GHz)	HP	8449B	3008A01266	12/18/2012
CABLE (1-40GHz)	HUBER +SUHNER	SUCOFLEX 102	33106/2	12/18/2012
CABLE (1-40GHz)	HUBER +SUHNER	SUCOFLEX 102	33633/2	12/18/2012
CABLE (1-26.5GHz)	HUBER +SUHNER	SUCOFLEX 104PEA	33960/4PEA	12/18/2012
THERMO-HYGRO METER	TECPEL	DTM-303	NO.3	11/21/2012
Test S/W	EZ-EMC			



4.3 MEASUREMENT UNCERTAINTY

PARAMETER	UNCERTAINTY
3M Semi Anechoic Chamber / 30M~1000M	± 3.82
3M Semi Anechoic Chamber / 1G~18G	± 1.99
3M Semi Anechoic Chamber / 18G~26G	± 2.65
3M Semi Anechoic Chamber / 26G~40G	± 2.97

Remark: This uncertainty represents an expanded uncertainty expressed at approximately the 95% confidence level using a coverage factor of k=2.

5. FACILITIES AND ACCREDITATIONS

5.1 FACILITIES

All measurement facilities used to collect the measurement data are located at

No.163-1, Jhongsheng Rd., Xindian Dist., New Taipei City, 23151 Taiwan.

Tel: 886-2-2217-0894 / Fax: 886-2-2217-1029

No.11, Wugong 6th Rd., Wugu Industrial Park, Taipei Hsien 248, Taiwan

Tel: 886-2-2299-9720 / Fax: 886-2-2298-4045

No.81-1, Lane 210, Bade 2nd Rd., Luchu Hsiang, Taoyuan Hsien 338, Taiwan

Tel: 886-3-324-0332 / Fax: 886-3-324-5235

The sites are constructed in conformance with the requirements of ANSI C63.7, ANSI C63.4 and CISPR Publication 22.

5.2 EQUIPMENT

Radiated emissions are measured with one or more of the following types of linearly polarized antennas: tuned dipole, biconical, log periodic, bi-log, and/or ridged waveguide, horn. Spectrum analyzers with pre-selectors and quasi-peak detectors are used to perform radiated measurements.



Conducted emissions are measured with Line Impedance Stabilization Networks and EMI Test Receivers.

Calibrated wideband preamplifiers, coaxial cables, and coaxial attenuators are also used for making measurements.

All receiving equipment conforms to CISPR 16-1-1, CISPR 16-1-2, CISPR 16-1-3, CISPR 16-1-4 and CISPR 16-1-5.

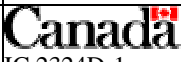

5.3 TABLE OF ACCREDITATIONS AND LISTINGS

Country	Agency	Scope of Accreditation	Logo
USA	FCC	3M Semi Anechoic Chamber (FCC MRA: TW1039) to perform FCC Part 15 measurements	 250366
Taiwan	TAF	LP0002, RTTE01, FCC Method-47 CFR Part 15 Subpart C, D, E, RSS-210, RSS-310 IDA TS SRD, AS/NZS 4268, AS/NZS 4771, TS 12.1 & 12.2, ETSI EN 300 440-1, ETSI EN 300 440-2, ETSI EN 300 328, ETSI EN 300 220-1, ETSI EN 300 220-2, ETSI EN 301 893, ETSI EN 301 489-1/3/7/17 FCC OET Bulletin 65 + Supplement C, EN 50360, EN 50361, EN 50371, RSS 102, EN 50383, EN 50385, EN 50392, IEC 62209, CNS 14958-1, CNS 14959 FCC Method -47 CFR Part 15 Subpart B IEC / EN 61000-3-2, IEC / EN 61000-3-3, IEC / EN 61000-4-2/3/4/5/6/8/11	
Canada	Industry Canada	3M Semi Anechoic Chamber (IC 2324G-1 / IC 2324G-2) to perform	

* No part of this report may be used to claim or imply product endorsement by A2LA any agency of the US Government.

6. SETUP OF EQUIPMENT UNDER TEST

6.1 SETUP CONFIGURATION OF EUT

See test photographs attached in Appendix I for the actual connections between EUT and support equipment.

6.2 SUPPORT EQUIPMENT

No.	Device Type	Brand	Model	Series No.	FCC ID	Data Cable	Power Cord

Remark:

1. All the equipment/cables were placed in the worst-case configuration to maximize the emission during the test.
2. Grounding was established in accordance with the manufacturer's requirements and conditions for the intended use.



7. FCC PART 15.231 REQUIREMENTS

7.1 20DB BANDWIDTH

LIMIT

The bandwidth of the emission shall be no wider than 0.25% of the center frequency for devices operating above 70 MHz and below 900 MHz. For devices operating above 900 MHz, the emission shall be no wider than 0.5% of the center frequency. Bandwidth is determined at the points 20 dB down from the modulated carrier.

Test Configuration

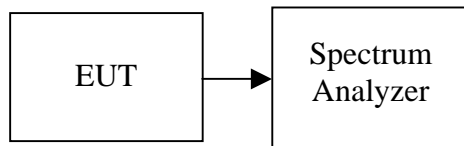

TEST PROCEDURE

The transmitter output is connected to the spectrum analyzer. The spectrum analyzer center frequency is set to the transmitter frequency. The RBW is set to 10 kHz and VBW is set 30kHz.

TEST RESULTS

No non-compliance noted.

Test Data

Frequency (MHz)	20 dB Bandwidth (kHz)	Limit (MHz)	Result
433.99	465.00	1.0850	PASS



Test Plot

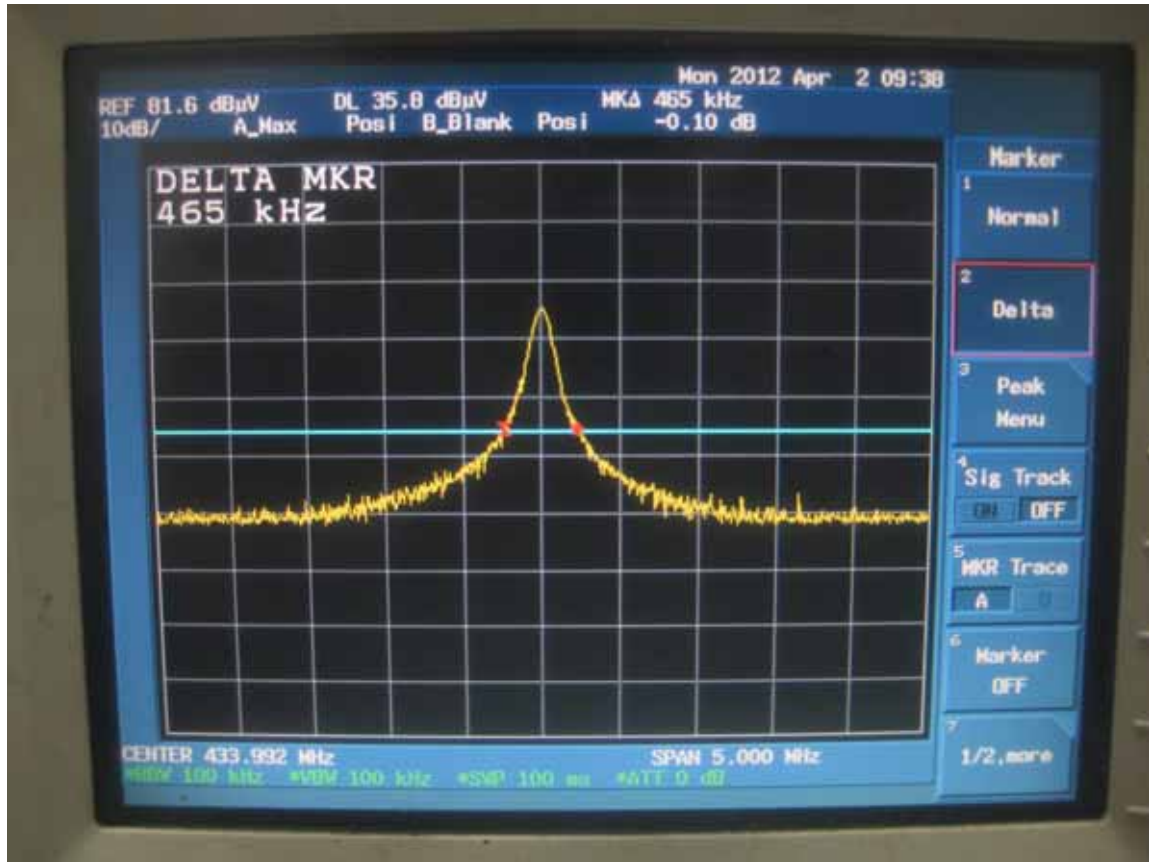



7.2 LIMIT OF TRANSMISSION TIME

LIMIT

According to 15.231 (a)(1), a manually operated transmitter shall employ a switch that will automatically deactivate the transmitter within not more than 5 seconds of being released.

Test Configuration

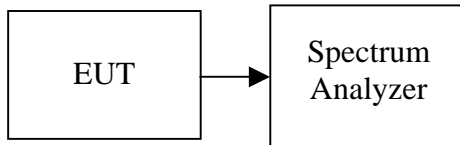

TEST PROCEDURE

The transmitter output is connected to the spectrum analyzer. The spectrum analyzer center frequency is set to the transmitter frequency. The RBW and VBW are set to 100kHz.

TEST RESULTS

No non-compliance noted

Test Data

Frequency (MHz)	Transmission time (ms)	Limit (Second)	Result
433.99	160.000	5.00	PASS



Test Plot

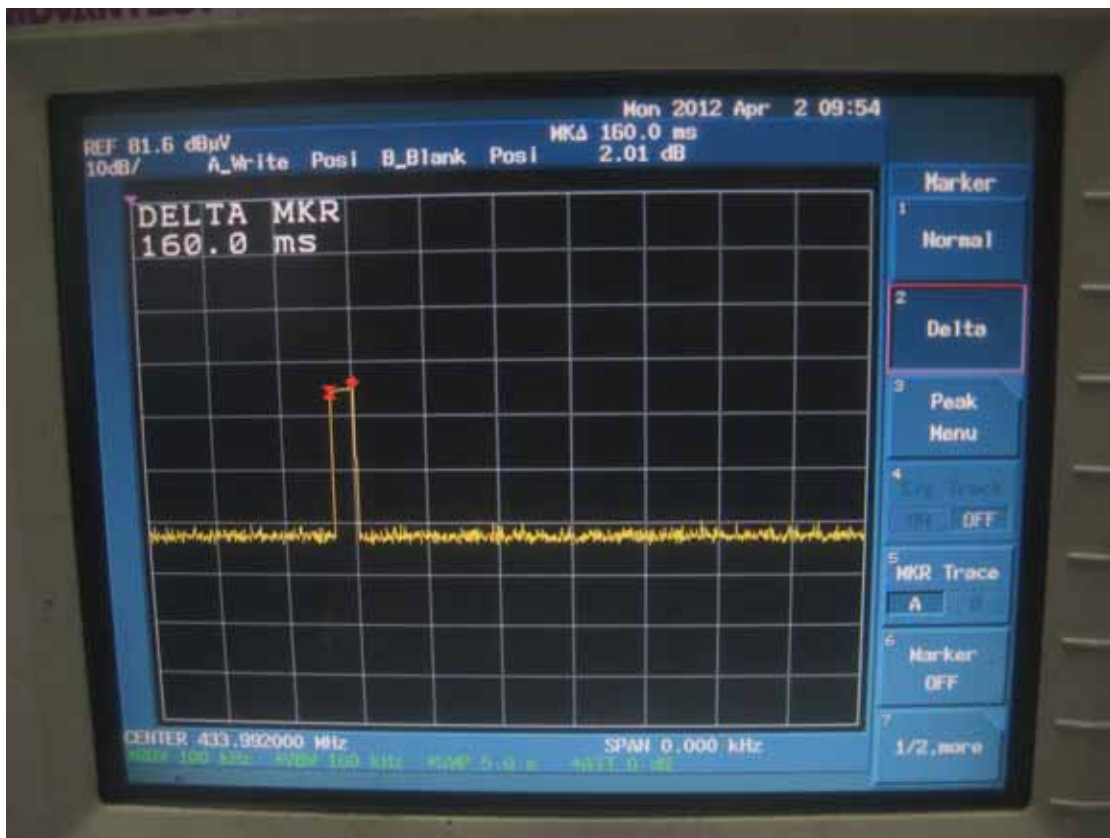



7.3 DUTY CYCLE CORRECTION FACTOR

LIMIT

Nil (No dedicated limit specified in the Rules)

Test Configuration

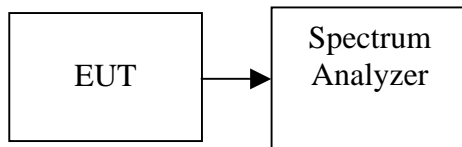

TEST PROCEDURE

1. Place the EUT on the table and set it in transmitting mode.
2. Remove the antenna from the EUT and then connect a low loss RF cable from the antenna port to the spectrum analyzer.
3. Set center frequency of spectrum analyzer = operating frequency.
4. Set the spectrum analyzer as RBW, VBW=100KHz, Span = 0Hz, Adjust Sweep = 100ms.
5. Repeat above procedures until all frequency measured were complete.

TEST RESULTS

No non-compliance noted

Test Data

$T_p = 53.44\text{ms}$

$T_{on} = (0.79 \times 2) + (0.13 \times 44) = 7.3$

Duty Cycle Correction Factor = $20 \times \log (T_{on} / T_p) = 20 \times \log (7.3/53.44) = -17.291 \text{ dB}$



Test Plot

Tp

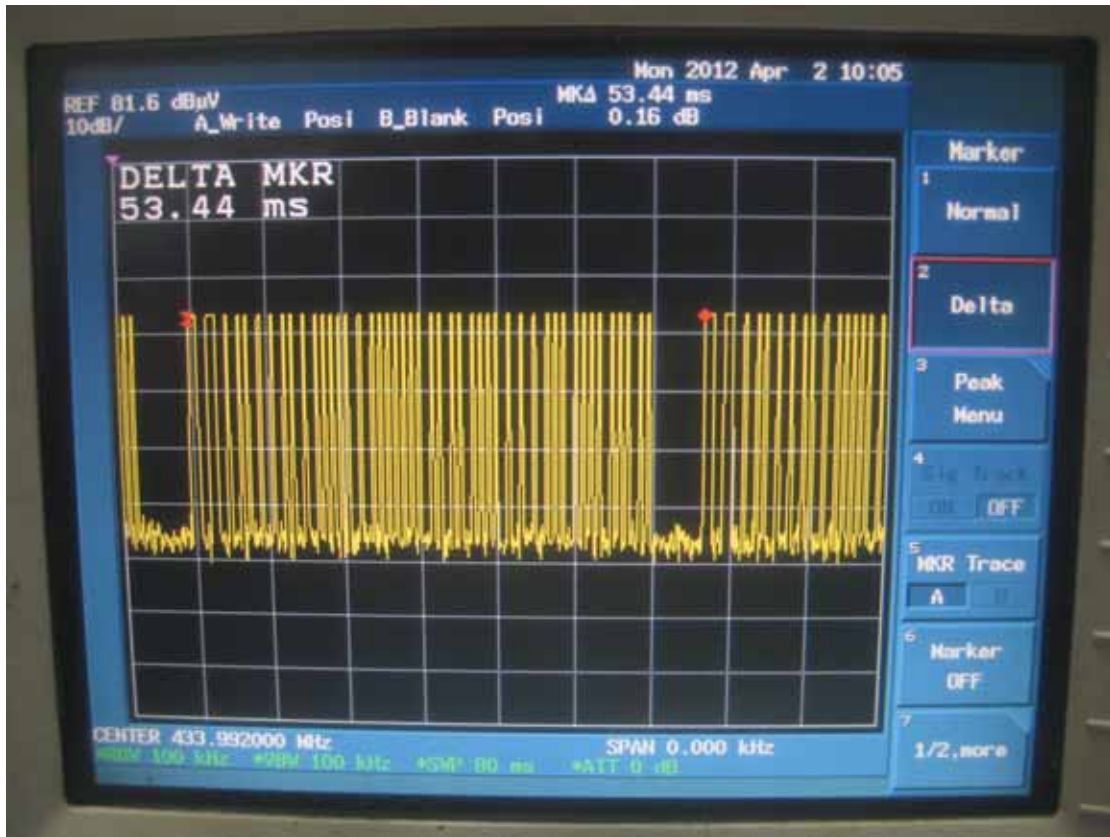

Channel Number

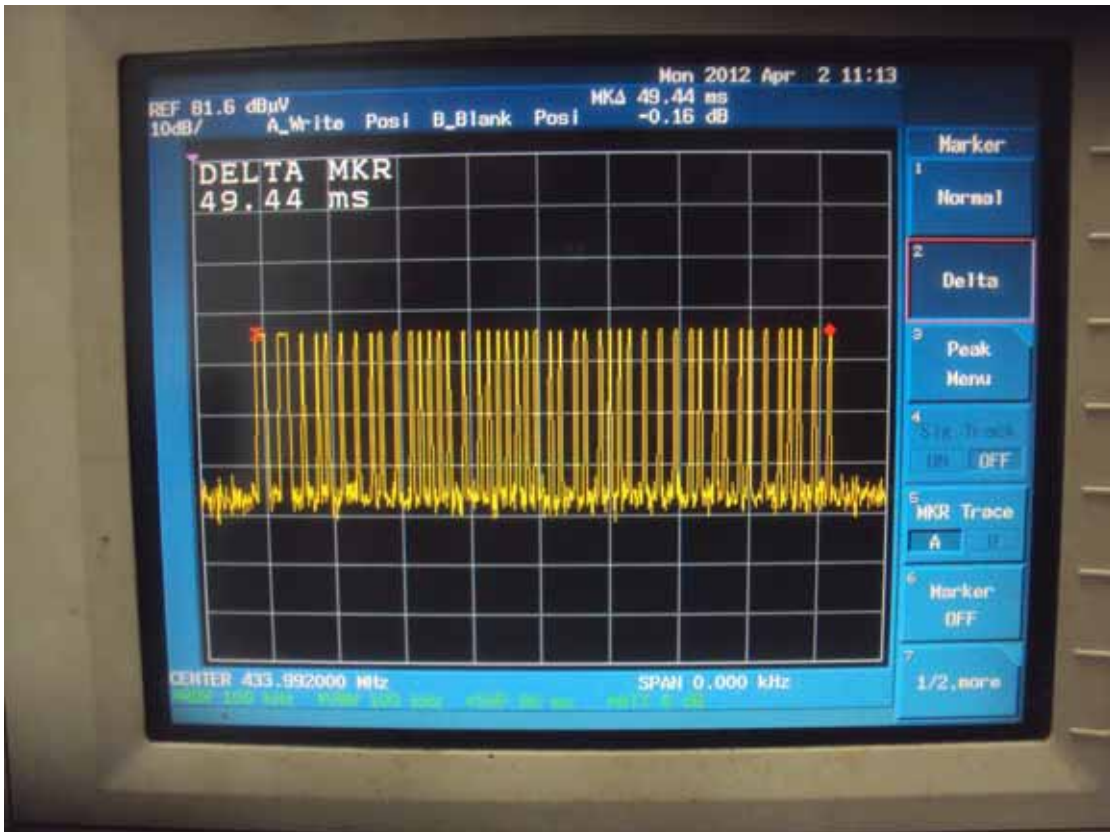



Ton 1

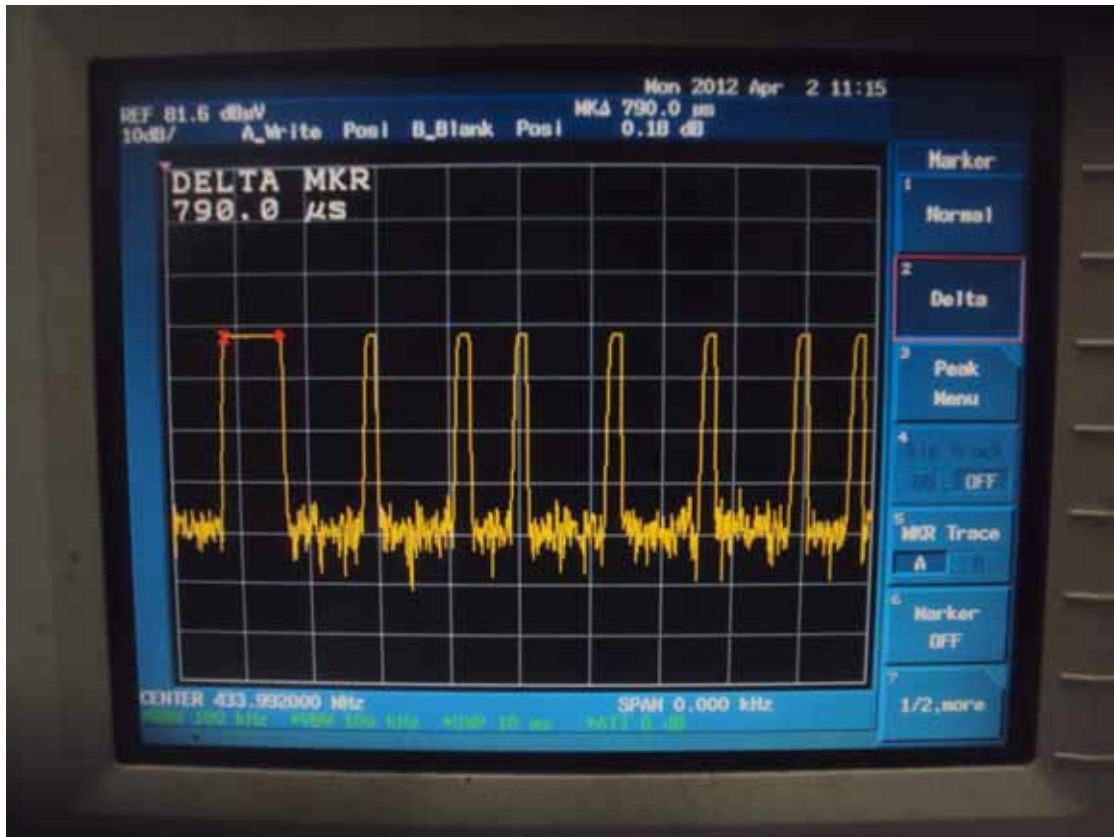

Ton 2

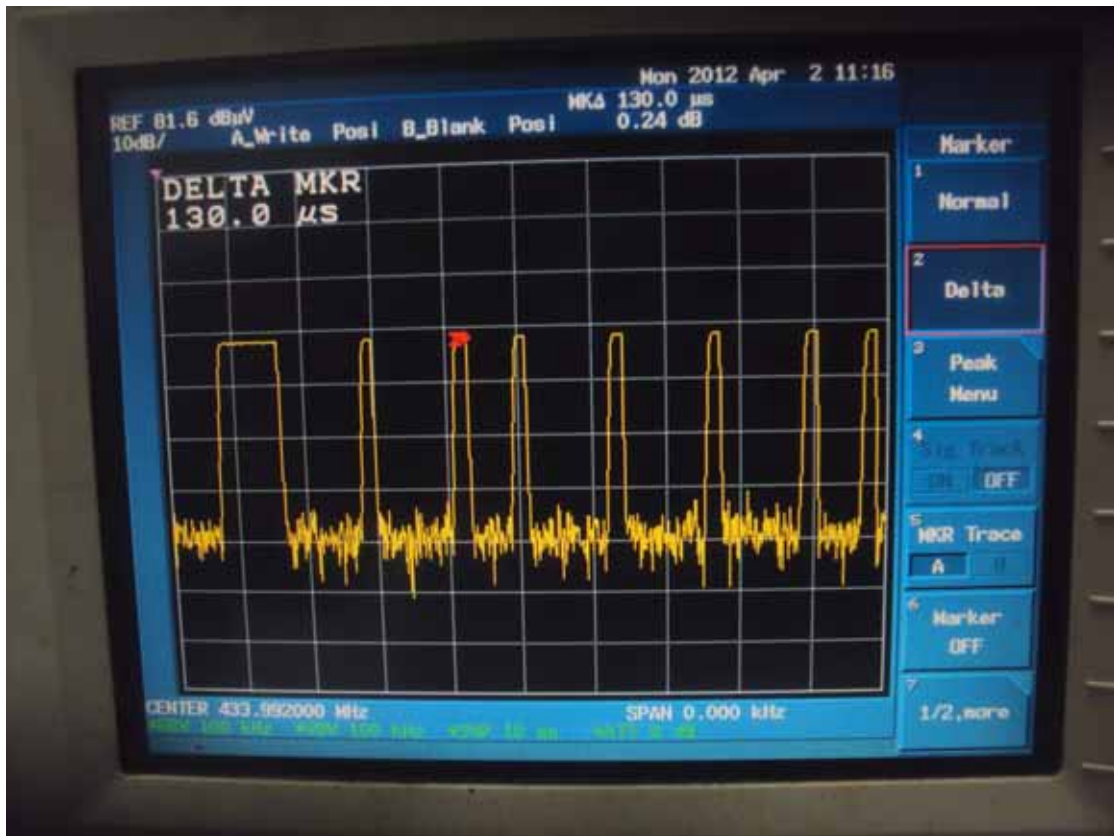



7.4 RADIATED EMISSIONS

LIMIT

1. According to §15.231(b), in addition to the provisions of Section 15.205, the field strength of emissions from intentional radiators operated under this Section shall not exceed the following:

Fundamental Frequency (MHz)	Field Strength of Fundamental (microvolts/meter)	Field Strength of Spurious Emissions (microvolts/meter)
40.66 – 40.70	2250	225
70 – 130	1250	125
130 – 174	1250 to 3750 **	125 to 375 **
174 – 260	3750	375
260 – 470	3750 to 12500 **	375 to 1250 **
Above 470	12500	1250

Remark: ** linear interpolations

[Where F is the frequency in MHz, the formulas for calculating the maximum permitted fundamental field strengths are as follows: for the band 130-174 MHz, $\mu\text{V/m}$ at 3 meters = $56.81818(F) - 6136.3636$; for the band 260-470 MHz, $\mu\text{V/m}$ at 3 meters = $41.6667(F) - 7083.3333$. The maximum permitted unwanted emission level is 20 dB below the maximum permitted fundamental level.]

2. Except as provided elsewhere in this Subpart, the emissions from an intentional radiator shall not exceed the field strength levels specified in the following table:

Frequency (MHz)	Field Strength (mV/m)	Measurement Distance (m)
30-88	100*	3
88-216	150*	3
216-960	200*	3
Above 960	500	3

Remark: Except as provided in paragraph (g), fundamental emissions from intentional radiators operating under this Section shall not be located in the frequency bands 54-72 MHz, 76-88 MHz, 174-216 MHz or 470-806 MHz. However, operation within these frequency bands is permitted under other sections of this Part, e.g., Sections 15.231 and 15.241.

3. In the above emission table, the tighter limit applies at the band edges.

Frequency (MHz)	Field Strength ($\mu\text{V/m}$ at 3-meter)	Field Strength (dB $\mu\text{V/m}$ at 3-meter)
30-88	100	40
88-216	150	43.5
216-960	200	46
Above 960	500	54



Test Configuration

9kHz ~ 30MHz

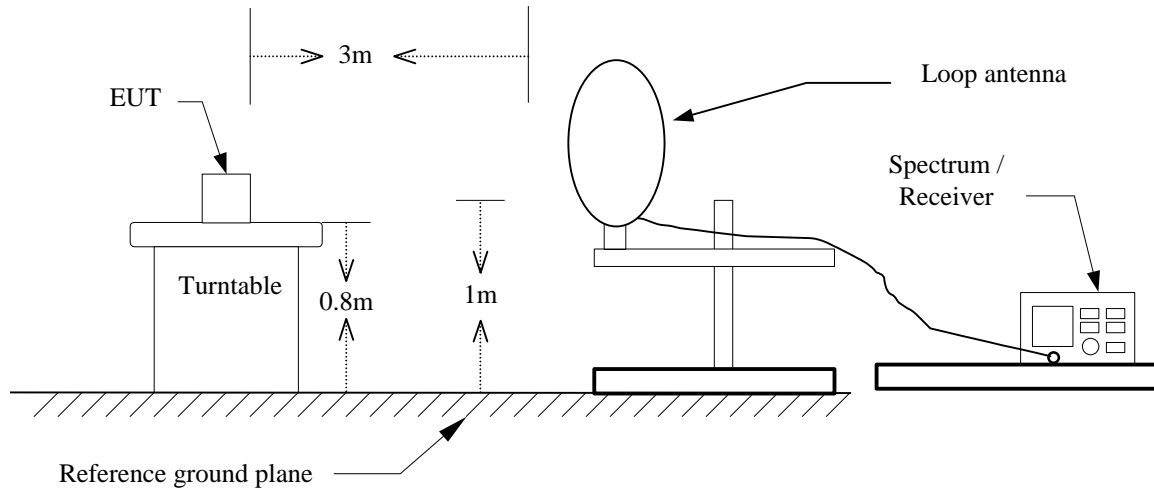

Below 1 GHz

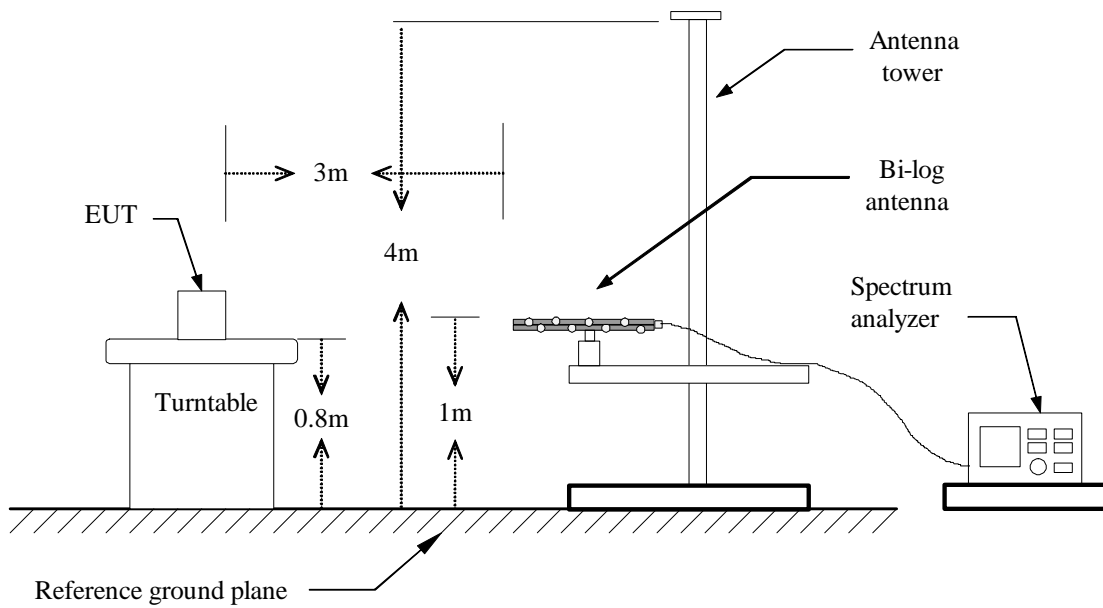



Above 1 GHz

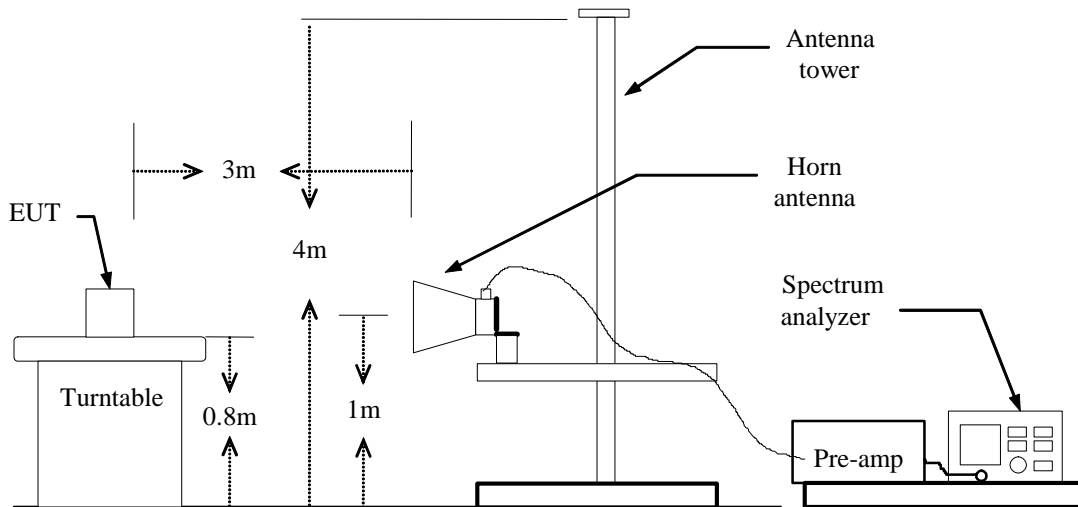

TEST PROCEDURE

1. The EUT is placed on a turntable, which is 0.8m above ground plane.
2. The turntable shall be rotated for 360 degrees to determine the position of maximum emission level.
3. EUT is set 3m away from the receiving antenna, which is varied from 1m to 4m to find out the highest emissions.
4. Maximum procedure was performed on the six highest emissions to ensure EUT compliance.
5. And also, each emission was to be maximized by changing the polarization of receiving antenna both horizontal and vertical.
6. Set the spectrum analyzer in the following setting as:

Below 1GHz:

RBW=100kHz / VBW=300kHz / Sweep=AUTO

Above 1GHz:

(a) PEAK: RBW=VBW=1MHz / Sweep=AUTO

(b) AVERAGE: RBW=1MHz / VBW=10Hz / Sweep=AUTO

7. Repeat above procedures until the measurements for all frequencies are complete.

**TEST RESULTS***No non-compliance noted***Below 1 GHz****Operation Mode:** TX Mode / Button#1**Test Date:** April 2, 2012**Temperature:** 26°C**Humidity:** 60% RH**Tested by:** Howard Pang**Polarity:** Ver. / Hor.

Freq. (MHz)	Pk Rdg (dBuV)	Av Rdg (dBuV)	Factor (dB)	Level (dBuV/m)	Limit (dBuV/m)	Margin (dB)	Pol (H/V)
434.49	54.17	36.88	-7.85	29.03	80.84	-51.81	V_X
868.08	31.15	13.86	-1.27	12.59	60.83	-48.24	V_X
434.49	61.37	44.08	-7.85	36.23	80.84	-44.61	V_Y
869.05	29.93	12.64	-1.27	11.37	60.83	-49.46	V_Y
434.49	57.81	40.52	-7.85	32.67	80.84	-48.17	V_Z
869.05	29.76	12.47	-1.27	11.20	60.83	-49.63	V_Z
434.49	64.05	46.76	-7.85	38.91	80.84	-41.93	H_X
868.08	38.34	21.05	-1.27	19.78	60.83	-41.05	H_X
434.49	68.47	51.18	-7.85	43.33	80.84	-37.51	H_Y
868.08	35.15	17.86	-1.27	16.59	60.83	-44.24	H_Y
434.49	55.02	37.73	-7.85	29.88	80.84	-50.96	H_Z
868.08	29.54	12.25	-1.27	10.98	60.83	-49.85	H_Z

*Factor = Antenna Factor + Cable Loss - Pre Amplifier**Av Rdg = Pk Rdg - 17.291dB***Remark:**

- 1. No emission found between lowest internal used/generated frequency to 30MHz (9kHz~30MHz)*
- 2. Radiated emissions measured in frequency range from 30 MHz to 1000MHz were made with an instrument using peak/quasi-peak/average detector mode.*
- 3. Average/quasi-peak test would be performed if the peak result were greater than the average/quasi-peak limit or as required by the applicant.*
- 4. Data of measurement within this frequency range shown " --- " in the table above means the reading of emissions are attenuated more than 20dB below the permissible limits or the field strength is too small to be measured.*
- 5. Measurements above show only up to 6 maximum emissions noted, or would be lesser, with " N/A " remark, if no specific emissions from the EUT are recorded (ie: margin > 20dB from the applicable limit) and considered that's already beyond the background noise floor.*
- 6. Margin (dB) = Level (dBuV/m) - Limit (dBuV/m).*



Operation Mode: TX Mode / Button# 2 / WORST Test Date: April 2, 2012

Temperature: 26°C

Humidity: 60% RH

Tested by: Howard Pang

Polarity: Ver. / Hor.

Freq. (MHz)	Pk Rdg (dBuV)	Av Rdg (dBuV)	Factor (dB)	Level (dBuV/m)	Limit (dBuV/m)	Margin (dB)	Pol (H/V)
434.49	55.97	38.68	-7.85	30.83	80.84	-50.01	V_X
868.08	35.66	18.37	-1.27	17.10	60.83	-43.73	V_X
434.49	59.00	41.71	-7.85	33.86	80.84	-46.98	V_Y
869.05	35.16	17.87	-1.27	16.60	60.83	-44.23	V_Y
434.49	58.18	40.89	-7.85	33.04	80.84	-47.80	V_Z
869.05	30.80	13.51	-1.27	12.24	60.83	-48.59	V_Z
434.49	64.52	47.23	-7.85	39.38	80.84	-41.46	H_X
868.08	37.63	20.34	-1.27	19.07	60.83	-41.76	H_X
434.49	68.98	51.69	-7.85	43.84	80.84	-37.00	H_Y
868.08	35.57	18.28	-1.27	17.01	60.83	-43.82	H_Y
434.49	54.67	37.38	-7.85	29.53	80.84	-51.31	H_Z
868.08	30.52	13.23	-1.27	11.96	60.83	-48.87	H_Z

Factor = Antenna Factor + Cable Loss - Pre Amplifier

Av Rdg = Pk Rdg-17.291dB

Remark:

- No emission found between lowest internal used/generated frequency to 30MHz (9kHz~30MHz)
- Radiated emissions measured in frequency range from 30 MHz to 1000MHz were made with an instrument using peak/quasi-peak/average detector mode.
- Average/quasi-peak test would be performed if the peak result were greater than the average/quasi-peak limit or as required by the applicant.
- Data of measurement within this frequency range shown " --- " in the table above means the reading of emissions are attenuated more than 20dB below the permissible limits or the field strength is too small to be measured.
- Measurements above show only up to 6 maximum emissions noted, or would be lesser, with " N/A " remark, if no specific emissions from the EUT are recorded (ie: margin>20dB from the applicable limit) and considered that's already beyond the background noise floor.
- Margin (dB) = Level (dBuV/m) – Limit (dBuV/m).



Operation Mode: TX Mode / Button# 3

Test Date: April 2, 2012

Temperature: 26°C

Humidity: 60% RH

Tested by: Howard Pang

Polarity: Ver. / Hor.

Freq. (MHz)	Pk Rdg (dBuV)	Av Rdg (dBuV)	Factor (dB)	Level (dBuV/m)	Limit (dBuV/m)	Margin (dB)	Pol (H/V)
434.49	50.38	33.09	-7.85	25.24	80.84	-55.60	V_X
868.08	28.14	10.85	-1.27	9.58	60.83	-51.25	V_X
434.49	55.38	38.09	-7.85	30.24	80.84	-50.60	V_Y
869.05	29.22	11.93	-1.27	10.66	60.83	-50.17	V_Y
434.49	65.69	48.40	-7.85	40.55	80.84	-40.29	V_Z
869.05	31.27	13.98	-1.27	12.71	60.83	-48.12	V_Z
434.49	60.32	43.03	-7.85	35.18	80.84	-45.66	H_X
868.08	36.87	19.58	-1.27	18.31	60.83	-42.52	H_X
434.49	67.34	50.05	-7.85	42.20	80.84	-38.64	H_Y
868.08	30.92	13.63	-1.27	12.36	60.83	-48.47	H_Y
434.49	53.10	35.81	-7.85	27.96	80.84	-52.88	H_Z
868.08	30.61	13.32	-1.27	12.05	60.83	-48.78	H_Z

Factor = Antenna Factor + Cable Loss - Pre Amplifier

Av Rdg = Pk Rdg - 17.291dB

Remark:

- 1. No emission found between lowest internal used/generated frequency to 30MHz (9kHz~30MHz)*
- 2. Radiated emissions measured in frequency range from 30 MHz to 1000MHz were made with an instrument using peak/quasi-peak/average detector mode.*
- 3. Average/quasi-peak test would be performed if the peak result were greater than the average/quasi-peak limit or as required by the applicant.*
- 4. Data of measurement within this frequency range shown " --- " in the table above means the reading of emissions are attenuated more than 20dB below the permissible limits or the field strength is too small to be measured.*
- 5. Measurements above show only up to 6 maximum emissions noted, or would be lesser, with " N/A " remark, if no specific emissions from the EUT are recorded (ie: margin > 20dB from the applicable limit) and considered that's already beyond the background noise floor.*
- 6. Margin (dB) = Level (dBuV/m) - Limit (dBuV/m).*



Operation Mode: TX Mode / Button# 4

Test Date: April 2, 2012

Temperature: 26°C

Humidity: 60% RH

Tested by: Howard Pang

Polarity: Ver. / Hor.

Freq. (MHz)	Pk Rdg (dBuV)	Av Rdg (dBuV)	Factor (dB)	Level (dBuV/m)	Limit (dBuV/m)	Margin (dB)	Pol (H/V)
434.49	54.42	37.13	-7.85	29.28	80.84	-51.56	V_X
868.08	30.70	13.41	-1.27	12.14	60.83	-48.69	V_X
434.49	54.42	37.13	-7.85	29.28	80.84	-51.56	V_Y
869.05	30.70	13.41	-1.27	12.14	60.83	-48.69	V_Y
434.49	66.09	48.80	-7.85	40.95	80.84	-39.89	V_Z
869.05	31.44	14.15	-1.27	12.88	60.83	-47.95	V_Z
434.49	62.25	44.96	-7.85	37.11	80.84	-43.73	H_X
868.08	38.59	21.30	-1.27	20.03	60.83	-40.80	H_X
434.49	67.48	50.19	-7.85	42.34	80.84	-38.50	H_Y
868.08	33.24	15.95	-1.27	14.68	60.83	-46.15	H_Y
434.49	52.44	35.15	-7.85	27.30	80.84	-53.54	H_Z
868.08	30.43	13.14	-1.27	11.87	60.83	-48.96	H_Z

Factor = Antenna Factor + Cable Loss - Pre Amplifier

Av Rdg = Pk Rdg - 17.291dB

Remark:

7. No emission found between lowest internal used/generated frequency to 30MHz (9kHz~30MHz)
8. Radiated emissions measured in frequency range from 30 MHz to 1000MHz were made with an instrument using peak/quasi-peak/average detector mode.
9. Average/quasi-peak test would be performed if the peak result were greater than the average/quasi-peak limit or as required by the applicant.
10. Data of measurement within this frequency range shown " --- " in the table above means the reading of emissions are attenuated more than 20dB below the permissible limits or the field strength is too small to be measured.
11. Measurements above show only up to 6 maximum emissions noted, or would be lesser, with " N/A " remark, if no specific emissions from the EUT are recorded (ie: margin > 20dB from the applicable limit) and considered that's already beyond the background noise floor.
12. Margin (dB) = Level (dBuV/m) - Limit (dBuV/m).



Above 1 GHz

Operation Mode: TX / Button#2 **Test Date:** February 13, 2012
Temperature: 26°C **Tested by:** 60% RH
Humidity: Howard Pang **Polarity:** Ver. / Hor.

Freq. (MHz)	Pk Rdg (dBuV)	Av Rdg (dBuV)	Factor (dB)	Level (dBuV/m)	Limit (dBuV/m)	Margin (dB)	Pol (H/V)
1302.00	47.63	-	-6.10	41.52	74.00	-32.48	V
1302.00	-	30.34	-	24.24	54.00	-29.76	V
1302.00	48.37	-	-6.10	42.27	74.00	-31.73	H
1302.00	-	31.08	-	24.97	54.00	-29.02	H

Factor = Antenna Factor + Cable Loss - Pre Amplifier

Av Rdg = Pk Rdg - 17.291dB

Remark:

1. *Measuring frequencies from 1 GHz to the 10th harmonic of highest fundamental frequency.*
2. *Radiated emissions measured in frequency above 1000MHz were made with an instrument using peak/average detector mode.*
3. *Average test would be performed if the peak result were greater than the average limit or as required by the applicant.*
4. *Data of measurement within this frequency range shown " --- " in the table above means the reading of emissions are attenuated more than 20dB below the permissible limits or the field strength is too small to be measured.*
5. *Measurements above show only up to 6 maximum emissions noted, or would be lesser, with " N/A " remark, if no specific emissions from the EUT are recorded (ie: margin > 20dB from the applicable limit) and considered that's already beyond the background noise floor.*
6. *Margin (dB) = Level (dBuV/m) – Limit (dBuV/m).*



7.5 POWERLINE CONDUCTED EMISSIONS

LIMIT

According to §15.207(a), except as shown in paragraphs (b) and (c) of this section, for an intentional radiator that is designed to be connected to the public utility (AC) power line, the radio frequency voltage that is conducted back onto the AC power line on any frequency or frequencies within the band 150 kHz to 30 MHz shall not exceed the limits in the following table, as measured using a 50 μ H/50 ohms line impedance stabilization network (LISN). Compliance with the provisions of this paragraph shall be based on the measurement of the radio frequency voltage between each power line and ground at the power terminal. The lower limit applies at the boundary between the frequency ranges.

Frequency Range (MHz)	Limits (dB μ V)	
	Quasi-peak	Average
0.15 to 0.50	66 to 56*	56 to 46*
0.50 to 5	56	46
5 to 30	60	50

* Decreases with the logarithm of the frequency.

Test Configuration

See test photographs attached in Appendix 1 for the actual connections between EUT and support equipment.

Test Procedure

Not applicable (Since the EUT is powered by battery)

TEST RESULTS

Not applicable (Since the EUT is powered by battery)



APPENDIX I-PHOTOGRAPHS OF TEST SETUP RADIATED EMISSION SET UP PHOTOS

TX Mode

X axis

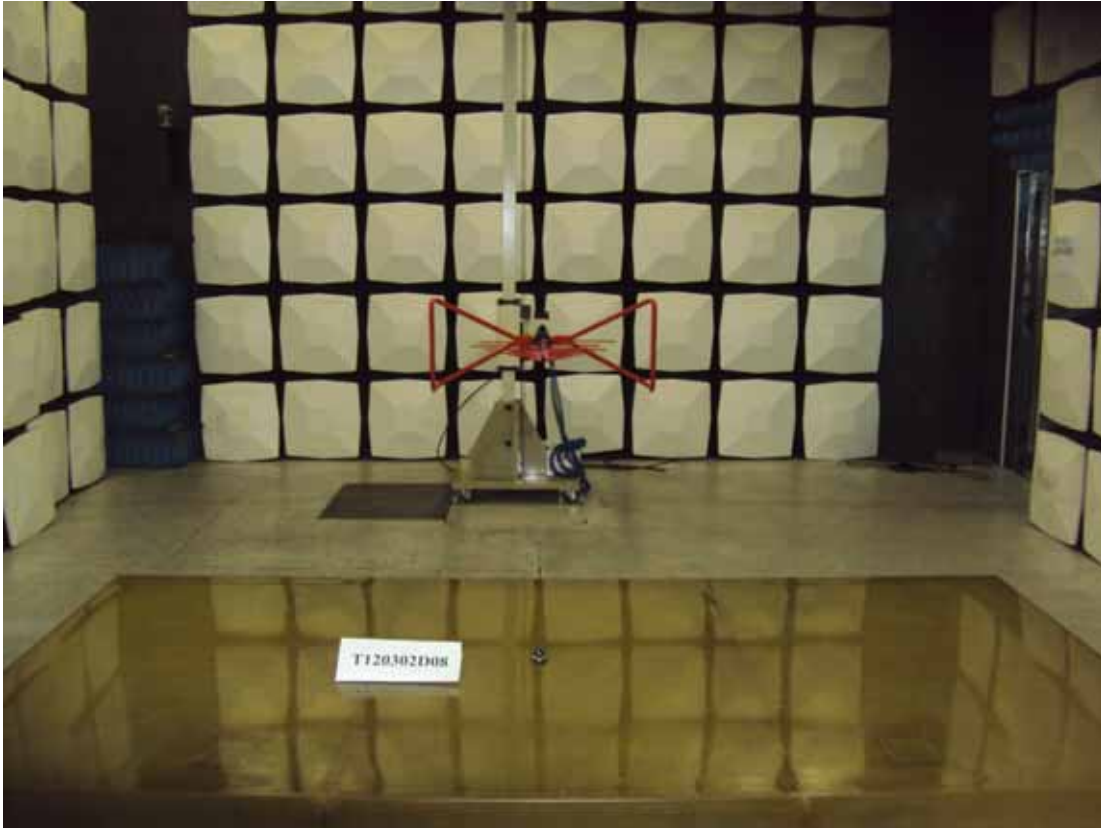

Y axis





Z axis

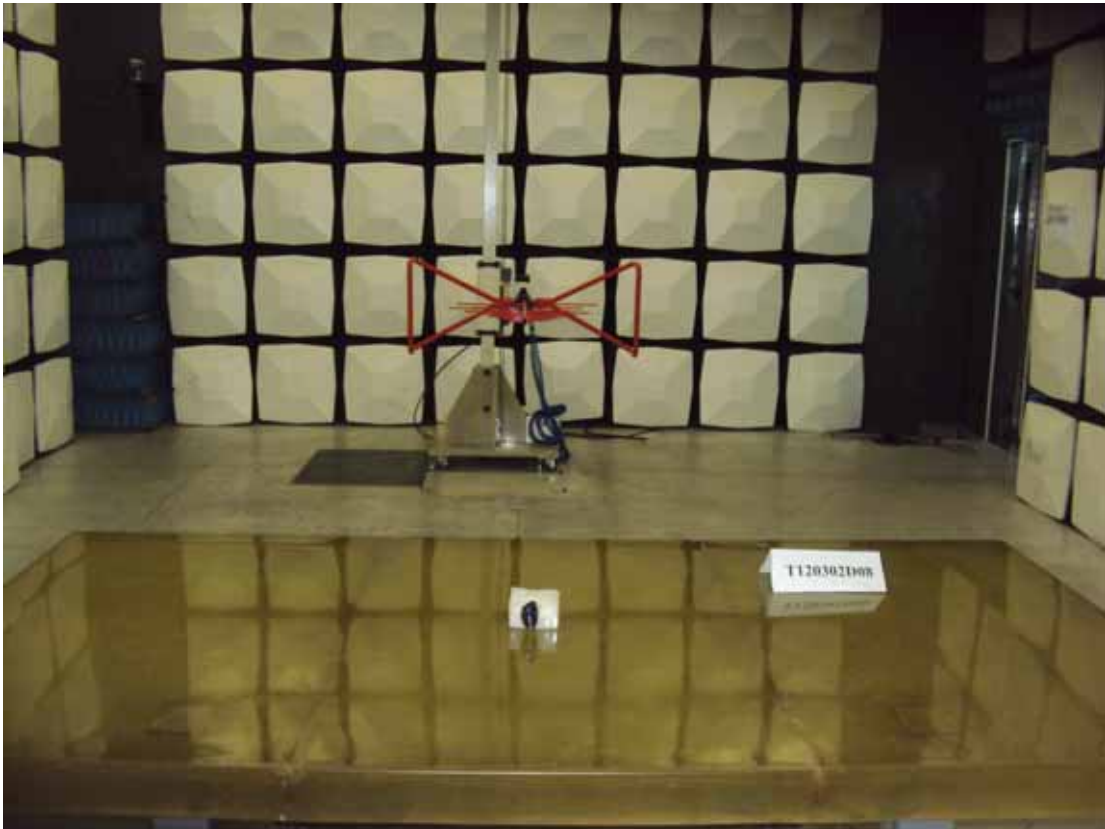



RADIATED EMISSION SET UP PHOTOS

