



Installation Manual

This device complies with part 15 of the FCC rules. Operation is subject to the following two conditions:

- (1) This device may not cause harmful interference; and
- (2) This device must accept any interference received, including interference that may cause undesired operation.

Note: The manufacturer is not responsible for any radio or TV interference caused by unauthorized modifications to this equipment. Such modifications could void the user's authority to operate the equipment.

For Technical Assistance: (800) 638-5000

For Fax or E-mail Technical Assistance: (800) 994-9927

(E-mail: fax@marksman.com) (Web: www.magnadyne.com)

© Copyright 2000 Magnadyne Corporation

Index

Step 1: Component Installation	2
Step 2: 10-Pin Main Harness Installation	2-3
Step 3: 5-Pin Power Harness Installation	4
Step 4: Optional Accessory Connections	4-11
Step 5: Transmitter Coding	11
Step 6: Remote Feature Programming	12-15
Step 7: Multiple Car Programming	15
Step 8: General Testing	16
Step 9: Speciality Feature and Optional Equipment Testing	16-19
Wiring Diagram	20

Warning! Do not plug the 10-pin or 5-pin wire harness into the alarm control module before you begin installing the alarm. The wire harnesses must be plugged into the alarm control module after all connections are made. Failure to follow this procedure could cause some confusion with transmitter operation and or alarm function operation.

Step 1: Component Installation

Mounting the Control Module: Secure the alarm control module within the passenger's compartment of the vehicle. Never mount the alarm control module in the engine compartment or in the direct path of the heater. Secure the alarm control module by using wire ties or with the screws provided.

Mounting the Siren: Find a suitable location in the engine compartment to secure the siren that provides a direct sound path to the ground. Use the self tapping screws provided. Connect the black wire coming from the siren to the frame of the vehicle. Route the brown wire through the firewall to the location of the alarm control module.

Installing Hood/Trunk Pin Switches: To install the switch either in the trunk or under the hood, find a suitable location where the switch will make contact with the hood or trunk lid and will not get wet. Use the bracket provided or drill a 1/4" hole in the desired location.

Mounting the LED Status Indicator: Find a suitable location for the LED and drill a 5/16" hole in the desired location. Feed the 2-pin plug through the hole and press the body of the LED into place. Run the LED wires to the location of the alarm control module.

Step 2: 10-Pin Main Harness Installation

The main wire harness contains 8 wires which all have a specific purpose. Follow the wiring recommendations enclosed for each wire. Wires not used should be released from the harness connector or taped off to prevent accidental shorting. Included with the 10-pin wire harness are two loose wires, an orange wire and a white wire with black stripe. See main harness and power harness wiring instructions for these two loose wires.

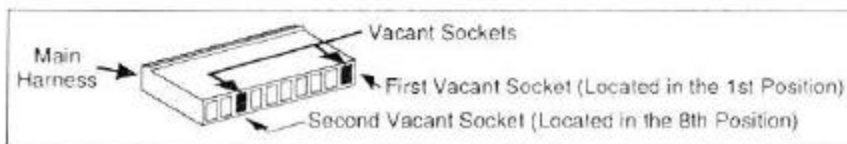

Step 2: 10-Pin Main Harness Installation

First Vacant Socket: (For Use with ALA-RPT Relay Pack Only) See Optional Accessory Connection for proper wiring.

Gray Wire: (Pulsed Ground for Car Horn. Applies to M5 Only) Connect the gray wire to the negative trigger wire on the vehicle's horn relay. DO NOT connect the gray wire directly to the vehicle's horn. Damage to the control module will result.

Warning! Maximum output of this wire is 300mA. Horn systems requiring positive voltage or more than 300mA to trigger the horn relay will require an additional relay to increase current capabilities.

Blue Wire with White Stripe: (Channel #3 Output. Applies to M5 Only) Connect the blue/white wire to the device that will be operated from channel #3 of the alarm system. The blue/white wire has a current capacity of 300mA "maximum".

Brown Wire: (Siren + Output) Connect the brown wire to the positive wire from the siren. Ground the remaining wire from the siren for proper operation.

Blue Wire: (Optional Grounding Sensor Input) The blue wire is an instant grounding trigger input for optional hood/trunk grounded pin switches or any electronic sensor.

Green Wire: (Grounded Door Pin Switch Input) The green wire connects to the common wire of the vehicle that switches on the dome light. Normally this wire is located at one of the door jamb switches. For some vehicles it may be necessary to connect the green wire directly to the switched turn on wire at the dome light. The green wire connects to negative switched circuits only.

Violet Wire: (Positive Door Pin Switch Input) The violet wire connects to the common wire of the vehicle that switches on the dome light. For some vehicles it may be necessary to connect the violet wire directly to the switched turn on wire at the dome light. The violet wire connects to positive switched circuits only.

Second Vacant Socket: The second vacant wire socket provides a 1 second pulsed ground (300mA) output when channel #2 is activated. (See Optional Accessory Connections)

Red/White: (Pulsed Parking Light Relay Output)

Connect the red/white wire to the parking light wire coming from the headlight switch. Do not connect the red/white wire to the dashboard lighting dimmer switch. Damage to the dimmer will result. The limitation of the red/white wire is 10 Amp max. Do not exceed this limit or damage to the alarm and parking light relay will result.

Second Vacant Socket: The second vacant wire socket provides a 1 second pulsed ground (300mA) output when channel #2 is activated. (See Optional Accessory Connections)

Red/White: (Pulsed Parking Light Relay Output) Connect the red/white wire to the parking light wire coming from the headlight switch. Do not connect the red/white wire to the dashboard lighting dimmer switch. Damage to the dimmer will result. The limitation of the red/white wire is 10 Amp max. Do not exceed this limit or damage to the alarm and parking light relay will result.

Pink: (Parking Light Relay Input) The pink wire is the input to the flashing parking light relay. The connection of the pink wire will determine the output polarity of the flashing parking light relay. Connect the pink wire to (+) battery to have (+) output from the relay or connect the pink wire to frame ground to have ground output from the relay.

Step 3: 5-Pin Power Harness Installation

The power harness contains 3 wires and two vacant sockets. Follow the wiring recommendations enclosed for each wire.

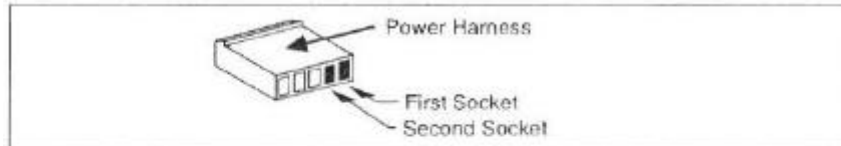

First Vacant Socket: (Applies to M5 Only) The first vacant wire socket is a low current (300mA) grounded output wire that can be used to activate the vehicle's interior lighting system when the security system is disarmed. An additional relay is required for proper installation. See Optional Accessory Connection for proper wiring.

Second Vacant Socket: See Optional Accessory Connection for proper wiring.

Red Wire: (Main Power Input) Connect the red wire directly to the (+) battery post. For best current sensing capability from the alarm's current sensing circuit, connect the red wire to the constant power wire coming from the interior dome light.

Black Wire: (Main Ground Input) Connect the black wire directly to the frame of the vehicle. Use a bolt and nut to secure the wire. Scrape away any grease or paint that might prevent a good connection.

Yellow Wire: (Switched +12 Volts From the Ignition Switch) Connect the yellow wire to a +12 volt wire that is switched on and off by the ignition key. The correct wire will indicate +12 volts when the ignition key is in the "ON" and "START" positions. Do not connect the yellow wire to the "acc" wire coming from the ignition switch.

Step 4: Optional Accessory Connections

Power Door Lock/Unlock Activation

Note: Prewired door lock interconnect T-harness are available for most vehicles.

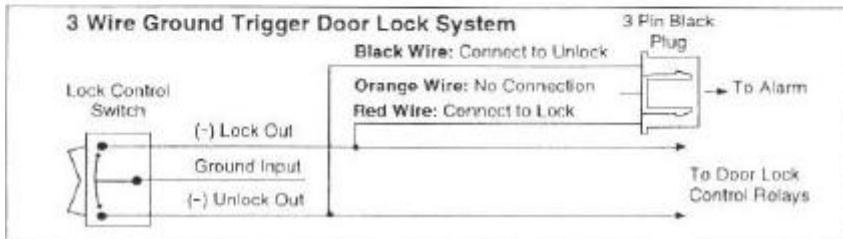
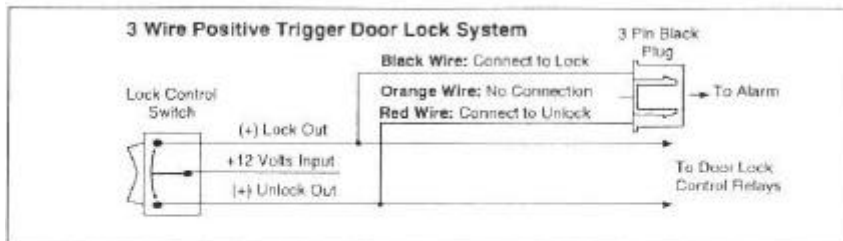

Step 4: Optional Accessory Connections (Continued)

5 Wire Ground at Rest Door Locking Systems

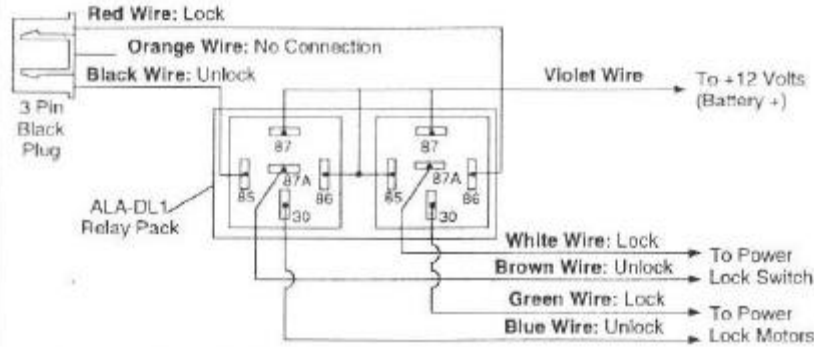

Mercedes Door Lock Activation

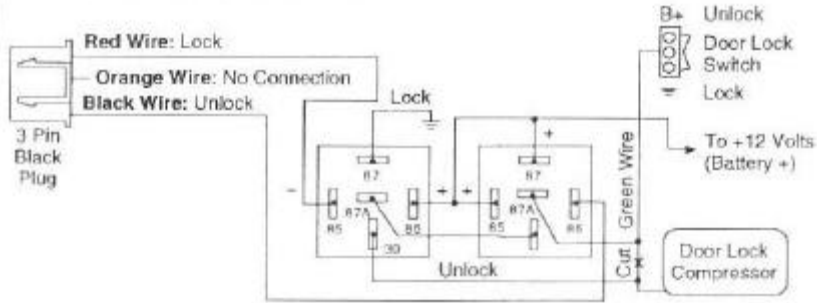

Newly Installed Power Door Lock Motors

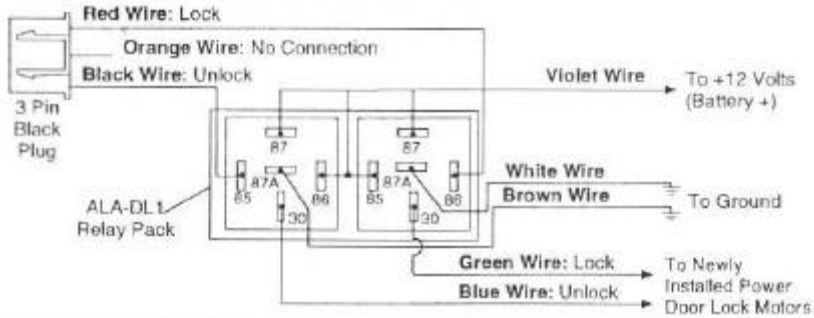

Step 4: Optional Accessory Connections (Continued)

#2 Button Power Trunk Activation Using Optional 30 Amp Relay

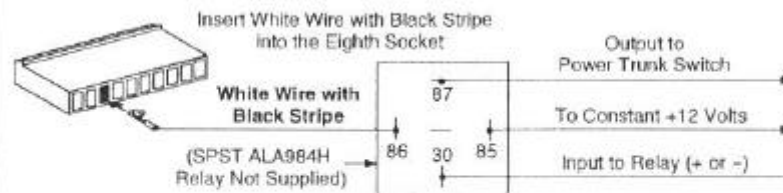

Step 5: Transmitter Coding

Remote Transmitter Coding and Operation:

The supplied transmitters are pre-programmed to the security system alarm module using dedicated buttons mode. Follow the procedures below to add replacement transmitters or to change from dedicated buttons mode to separate channel mode.

Step 1	Step 2	Step 3	Step 4
Turn On the Ignition Key	Flip Valet Switch On/Off 3 Times The horn/siren will chirp 1 time and the LED indicator will be on solid. This indicates the Module is ready for programming dedicated button mode.	Depress Lock Button The horn/siren will chirp 1 time and the LED will flash 1 time. The transmitter is now fully programmed to the module. To program additional transmitters at this time, depress the lock button on each additional transmitter. You will get 1 chirp and 1 flash from the LED when the transmitter is learned.	Turn Off Ignition Key The horn/siren will sound 1 short + 1 long beep. Transmitter programming is now completed.



Separate Channel Mode:



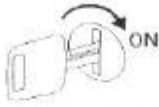

When programmed for separate channel mode the transmitters buttons operates as follows:

Lock Button:	Lock/Unlock	Unlock Button:	Channel 2
Panic Button:	Panic,	Aux:	Channel 3

To program the module for separate channel mode, follow these instructions continued on the next page.

Step 5: Transmitter Coding (Continued)

Step 1	Step 2
	
<p>Turn On the Ignition Key</p>	<p>Flip Valet Switch On/Off 4 Times The horn/siren will Chirp 2 time and the LED indicator will be on solid. This indicates the module is ready for separate channel button mode.</p>

Step 3	Step 4	Step 5
		
<p>Press the LOCK Button</p> <ol style="list-style-type: none"> 1. The horn/siren chirp 1 time. 2. The LED will flash 1 time. 3. The LOCK button is now programmed. To program additional transmitters at this time, press each transmitters LOCK button. 5. Flip the Valet Switch On/Off 1 time. 	<p>Press the UNLOCK Button</p> <ol style="list-style-type: none"> 1. The horn/siren chirp 2 times. 2. The LED will flash 2 twice. 3. The UNLOCK button is now programmed. 4. To program additional transmitters at this time, press each transmitters UNLOCK button. 5. Flip the Valet Switch On/Off 1 time. 	<p>Press the AUX Button</p> <ol style="list-style-type: none"> 1. The horn/siren chirp 3 times. 2. The LED will flash 3 times. 3. The AUX button is now programmed. 4. To program additional transmitters at this time, press each transmitters AUX button. 5. Turn OFF ignition key. The siren/horn will sound 1 short and 1 long chirp to indicate programming is complete.
		

Step 6: Remote Feature Programming

The security system control module is pre-programmed for specific factory default settings. The default settings can be changed by following the enclosed procedures. Remote feature programming is divided into 3 parts. To enter feature programming you must turn on the ignition key and activate the valet switch 6 times for part 1 programming, 8 times for part 2 programming and 10 times for part 3 feature programming.

#	Programmable Feature	Default Setting
1	Chirp Status Indicator with Single Unlock Pulse	On
2	Last Door Closed Automatic Arming	Off
3	Ignition Key Controlled Door Lock/ Unlock	On
4	Door Lock/Unlock Pulse Timing	.8 sec
5	Parking Lights On/Off upon Disarm	Off
6	Current Sensing On/Off	Off
7	Car Jacking Feature	Off

Step 6: Remote Feature Programming (Continued)

Step 1

Make Sure the Security System is Disarmed

"Dedicated Button Mode"



"Separate Channel Mode"

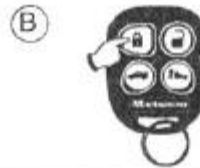

Step 2

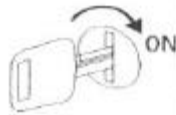

Turn On the Ignition Key

Step 3

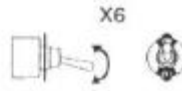

Flip the Valet Switch On/Off 6 Times

The LED will be on solid. The horn/siren will emit 1 long then 1 short beep. You are now in the "Remote Feature Programming" mode.

Step 4



Step 5



Turn Off the Ignition
The LED will be off and the horn/siren will emit 1 short beep and 1 long beep. You are now out of the feature programming mode.

Remote Feature Programming (Step 4)

#	Button	Changed Function	Confirmation
1	LOCK	Chirps "ON" with Single Unlock Pulse ON (Default)	1-Chirp, LED Parking Lights Flash
		Chirps "OFF" with Single Unlock Pulse ON	2-Chirps, LED Parking Lights Flash
		Chirps "ON" with Dual Unlock Pulse ON	3-Chirps, LED Parking Lights Flash
		Chirps "OFF" with Dual Unlock Pulse ON	4-Chirps, LED Parking Lights Flash

Last Door Closed Auto Arming/Auto Arming Door Locking (Step 4)

#	Button	Changed Function	Confirmation
2	UNLOCK	Last Door Closed Auto Arm "ON"	1-Chirp, LED Parking Lights Flash
		Last Door Closed Auto Arm "OFF" (Default)	2-Chirps, LED Parking Lights Flash
		Last Door Closed Auto Arm "ON" with Auto Door Locking Upon Auto Arming "ON"	3-Chirps, LED Parking Lights Flash

Ignition Controlled Door Locking (Step 4)

#	Button	Changed Function	Confirmation
3	AUX	Ignition ON, Door Locking "ON" (Default)	1-Chirp, LED Parking Lights Flash
		Ignition ON, Unlocking "ON"	2-Chirps, LED Parking Lights Flash
		Ignition ON, Door Locking "OFF"	3-Chirps, LED Parking Lights Flash
		Ignition ON, Unlocking "OFF"	3-Chirps, LED Parking Lights Flash

Step 6: Remote Feature Programming (Part 2)

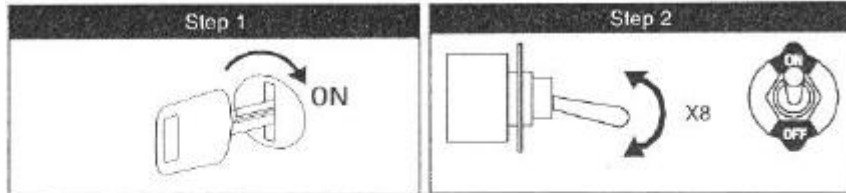

Turn On the Ignition Key

Flip the Valet Switch On/Off 8 Times
 The LED will be on solid. The horn/siren will emit 8 short Chirps to indicate You are now in Part 2 "Remote Feature Programming" mode.

Door Lock Timing

#	Button	Changed Function	Confirmation
1	LOCK	3.5 Sec. Door Lock timing	1-Chirp, LED Parking Lights Flash
		.8 Sec Door lock Timing (Default)	2-Chirps, LED Parking Lights Flash

Parking Lights ON/OFF Upon Disarming

#	Button	Changed Function	Confirmation
2	UNLOCK	Parking Lights Stay "ON" for 30 sec. Upon Disarm of Security System	1-Chirp, LED Parking Lights Flash
		Parking Lights Features Stay "OFF" (Default)	2-Chirp, LED Parking Lights Flash

Current Sensing ON/OFF

#	Button	Changed Function	Confirmation
3	AUX	Current Sensing "ON"	1-Chirp, LED Parking Lights Flash
		Current Sensing "OFF" (Default)	2-Chirp, LED Parking Lights Flash

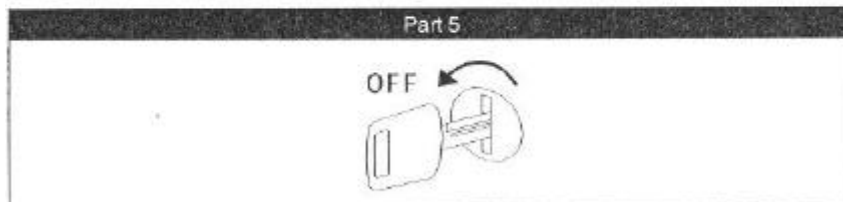

Turn Off the Ignition

The LED will be off and the horn/siren will emit 1 short beep and 1 long beep. You are now out of the feature programming mode.

Step 6: Remote Feature Programming (Part 3)

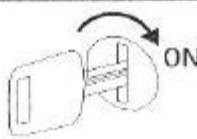
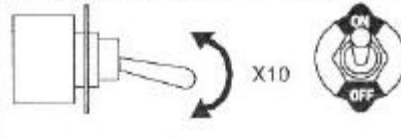
Step 1	Step 2
	
Turn On the Ignition Key	Flip the Valet Switch On/Off 10 Times The LED will be on solid. The horn/siren will emit 10 short chirps to indicate you are now in Part 3 "Remote Feature Programming" mode.

Car Jacking Feature

#	Button	Changed Function	Confirmation
1	AUX	Car Jacking Feature is "ON"	1-Chirp, LED Parking Lights Flash
		Car Jacking Feature is "OFF" (Default)	2-Chirps, LED Parking Lights Flash

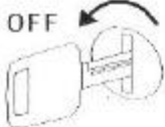
Part 5

Turn Off the Ignition
The LED will be off and the horn/siren will emit 1 short beep and 1 long beep. You are now out of the feature programming mode.

Step 7: Multiple Car Programming

About Multiple Car Programming:

Multiple car (Alarm) operation can only operate correctly when all transmitters on all systems are programmed in "B" mode (Separate Channel Mode). You can not mix "A" mode programming and "B" mode programming. Follow the transmitter coding information in this manual step 3, 4 and 5B part 1. To code a 2nd car, get into code learning (Steps 3 and 4) on the 2nd system and complete step 5B, part 1 and press the transmitters "UNLOCK" button. To code a 3rd car, get into code learning (Steps 3 and 4) on the 3rd system and complete step 5B, part 1 and press the transmitters "AUX" button. Alternatively, We Have an optional 5-button transmitter for 2 car operation that allows complete independent control of each function using the dedicated buttons mode.

Step 8: General Testing (Alarm Function)

To test the basic functions of the alarm system (all models) repeat the following procedures.

1. Turn off the ignition key and exit the vehicle closing all protected entrances.
2. Press the lock button on the transmitter. You will hear a siren/horn chirp, the parking lights will flash one time and the LED status indicator will flash at normal speed.
3. Wait 5 seconds, then open a protected entrance. The siren/horn will begin to sound. Press the unlock button once and the siren/horn will stop sounding. (No Disarm Chirp Indicator)

Note: If you disarm the alarm when the horn/siren is sounding, there are no disarming chirps. When you disarm the alarm when the siren is off, there will be disarming chirps.

4. Follow procedures 2 and 3 for all other protected entrances.

Step 9: Speciality Feature and Optional Equipment Testing

Each speciality feature listed operates in the same manner regardless of the alarm model. Test each feature by following the procedures enclosed to insure proper operation.

Remote Panic:

1. Press and hold the Panic button down for approximately 3 seconds.
2. The horn/siren will begin to sound and the parking lights will begin to flash.
3. Press the UNLOCK button and the horn/siren will stop sounding and the lights will stop flashing.

Note 1: The remote panic feature also has an automatic shut off circuit. When the horn/siren has sounded for 60 seconds, the panic circuit will turn itself off automatically.

Starter Disable: (Also Applies if ALA-RPS2 was Installed to Interrupt Other Circuits)

1. Enter the vehicle and close all the entrances.
2. Arm the alarm using the transmitter.
3. Turn the ignition key to the start position. The engine will not crank over.
4. Turn the ignition key to the off position and disarm the alarm.
5. Turn the ignition key back to the start position and the engine will crank over and start.

Step 9: Speciality Feature and Optional Equipment Testing

Override Operation: (Security System is Armed)

1. Enter the vehicle and the security system will begin sounding at this point.
2. Place the ignition key into the ignition switch and turn the ignition switch to the "on" position.
3. Within 5 seconds of turning the ignition key "on", place the valet switch to the "on" position.
4. The horn/siren will stop sounding and the parking lights will stop flashing.
5. The LED indicator will be solid red.
6. Place the valet switch back into the "off" position (LED will be off) and turn off the ignition key.

Step 9: Speciality Feature and Optional Equipment Testing

Note 1: If the valet switch is already in the "on" position when you turn "on" the ignition key, the override function will be bypassed. Turn "off" the ignition key, place the valet switch in the "off" position and try again.

Note 2: If you fail to place the valet switch to the "on" position within 5 seconds of turning "on" the ignition key, the override function will be locked out. Place the valet switch in the "off" position, turn "off" the ignition key and try again.

Valet Operation: (The security system is already disarmed)

1. Turn the ignition key to the "on" position.
2. Place the valet switch to the "on" position.
- 3a. The LED will be on solid indicating that the security system is in the valet mode. (Ignition is on).
- 3b. The LED will flash one every 5 seconds to indicate valet mode when the ignition is off.

How to Get Back to Security System Activation Mode:

1. Place the ignition key switch to the "on" position.
2. Place the valet switch to the "off" position.
3. Place the ignition key switch back to the "off" position. (LED indicator will be off)
This indicates that you have exited the valet mode and your security system will operate normally.

Last Door Automatic Arming: (If Programmed On)

Note: The automatic arming feature will not operate unless the alarm input triggers have been connected directly to existing or newly installed door jamb pins. Current sensing alone will not activate the automatic arming circuit.

1. Set the ignition key to the on position, then turn it off.
2. Exit the vehicle and close the door. The horn/siren will chirp 1 time when the door is closed.
3. The LED will begin to flash fast.
4. After 30 seconds have passed, you will hear another chirp. The alarm is now armed.
5. The LED will flash at a regular rate indicating an armed condition.

Step 9: Speciality Feature and Optional Equipment Testing

LED Status Indicator Operation:

LED is off = Alarm is disarmed.

LED is flashing = Alarm is armed.

LED is flashing in a 1 flash hold sequence = Tamper warning, alarm was triggered by the current sensing sensor.

LED flashing in a 2 flash hold sequence = Tamper warning, alarm was triggered by the hood or trunk.

LED flashing in a 3 flash hold sequence = Tamper warning, alarm was triggered by an opened door.

LED flashing in a 4 flash hold sequence = Tamper warning, alarm was triggered by an electronic sensor.

LED is on steady = Alarm is in the valet mode. (Ignition key is "on")

LED flashes once every 5 seconds = Alarm is in the valet mode. (Ignition key is "off")

LED is flashing fast = Automatic arming timer is counting down or RF tamper rearming timer is counting down.

Horn/Siren Chirp Alarm Status Indication:

Note: This feature can be programmed off, see "Remote Feature Programming" for details.

One chirp = Alarm is armed and all input trigger wires are clear.

Two chirps = Alarm is disarmed and has not been tampered with.

Four chirps = Tamper indicator, alarm is disarmed.

Power Door Lock/Unlock: (If Installed)

1. Press the "LOCK" button on the transmitter, the locks will become locked.

2. Press the "UNLOCK" button on the transmitter, the locks will become unlocked.

RF Tamper Re-Arm:

Note: This feature is activated automatically when the alarm is programmed for automatic arming. See "Remote Feature Programming" for details. (Page 14, 15)

1. Alarm must be programmed for automatic arming.

2. Close all protected entrances and arm the alarm with the remote transmitter. The LED will be flashing at a normal rate.

3. Wait 5 seconds and disarm the alarm using the remote transmitter. The LED will begin to flash fast. (Automatic arming indicator)

4. Wait 60 seconds and the alarm will become rearmed. (Re-arm will be silent)

5. Repeat steps 1 through 4. When the LED starts flashing fast, open one of the protected entrances (door) the LED will turn off. Close the entrance and the LED will begin to flash fast and the timer will begin counting again.

Note: After the door has been closed, the timer duration is reduced to 30 seconds.

Ignition Controlled Door Locking: (Door lock activation must be installed)

When programmed on, the ignition controlled locking feature will lock the door locks 3 seconds after the ignition key is turned on. When the ignition key is turned off, the door locks will unlock. (Depending on the mode the ignition locking is programmed to)

Note: If a protected entrance (door) is open when the ignition key is set to the on position, the door locks will not lock. This is a non-deletable protective measure.

Step 9: Speciality Feature and Optional Equipment Testing

60 Second Re-Arm Timer and Re-Lock Function:

Once the alarm is triggered, the siren will sound for 60 seconds and then stop. The alarm will remain in an armed condition. If the door locks have been installed into the system, they will re-lock when the alarm resets after 60 seconds.

Channel #2 Output: (If Installed)

1. Depress the Aux. button for 3 sec. when using dedicated buttons mode.
2. Depress the Unlock button for 3 sec. if programmed for separate Channel Mode

Channel #3 Output: (If Installed, Available on M5 Only)

1. Depress the Lock & Aux button at the same time when using dedicated button Mode.
2. Depress the Aux buttons if programmed for separate channels mode. The alarm will emit a ground signal on the Blue/White channel #3 wire for as long as channel #3 is activated.

Dual Zone Sensor Pre-Warning Indicator:

(Dual zone sensor must be installed)

1. Close all protected entrances and place the alarm in an armed condition.
2. Rap the vehicles body panels to activate the pre-warning zone of any dual zone type sensor.
3. When the pre-warning indicator is triggered, the horn/siren will emit 1 long beep/chirp.

Carjacking Feature: (If installed, this feature must be programmed on)

1. Enter the vehicle and close all the entrances. (If the vehicle has domelight delay, wait for the domelight to go out before beginning the test)
2. Set the ignition key to the on position. Wait 5 seconds and open the driver's door then close it.
3. Within 50 seconds the horn/siren will begin to beep (Short Pulses). This is pre-warning that the carjacking alarm will become fully triggered within 10 seconds.

Note: At this point, the carjacking alarm can be disabled by setting the valet switch to the on position.

4. Within 10 seconds, the carjacking alarm will be fully triggered. The horn/siren will sound normally, the parking lights will begin flashing and the starter disable will be engaged.
5. Turn the ignition key off, then back on.
6. Set the valet switch to the on position and the horn/siren will stop sounding and the parking lights will stop flashing.

WARNING! When the carjacking alarm is programmed on, every time the ignition key is on and a door gets opened, the 50 second timer will begin counting. If a door is open (domelight is on) before the ignition key is turned on, the 50 second timer will not start counting until the door is closed and re-opened.

Wiring Diagram for M4 & M5

