



Nemko

Test Report: 3W07209, Issue 2

Applicant: Daniels Electronics Ltd.
43 Eire Street
Victoria, BC
V8V-1P8

**Equipment Under Test:
(EUT)** VT-4D150 VHF Transmitter Family

FCC ID:

In Accordance With: **FCC Part 22**
FCC Part 90

Tested By: Nemko Canada Inc.
303 River Road, R.R. 5
Ottawa, Ontario K1V 1H2

Authorized By: 
Glen Westwell, Wireless Technologist

Date: 26 August 2003

Total Number of Pages: 48

Table of Contents

Section 1.	Summary of Test Results	3
Section 2.	General Equipment Specification.....	5
Section 3.	RF Power Output.....	6
Section 4.	Audio Frequency Response.....	7
Section 5.	Occupied Bandwidth	9
Section 6.	Spurious Emissions at Antenna Terminals	24
Section 7.	Field Strength of Spurious Emissions	33
Section 8.	Frequency Stability.....	37
Section 9.	Transient Frequency Behaviour.....	39
Section 10.	Block Diagrams	44
Section 11.	Test Equipment List	48

Section 1. Summary of Test Results

General

All measurements are traceable to national standards.

These tests were conducted on a sample of the equipment for the purpose of demonstrating compliance with FCC Part 22 and FCC Part 90.

THIS TEST REPORT RELATES ONLY TO THE ITEM(S) TESTED.

THE FOLLOWING DEVIATIONS FROM, ADDITIONS TO, OR EXCLUSIONS FROM THE TEST SPECIFICATIONS HAVE BEEN MADE. NONE
See " Summary of Test Data".



TESTED BY: _____
Kevin Carr, EMC Specialist

DATE: 26 August 2003

Nemko Canada Inc. authorizes the above named company to reproduce this report provided it is reproduced in its entirety and for use by the company's employees only.

Any use which a third party makes of this report, or any reliance on or decisions to be made based on it, are the responsibility of such third parties. Nemko Canada Inc. accepts no responsibility for damages, if any, suffered by any third party as a result of decisions made or actions based on this report.

This report applies only to the items tested.

Summary Of Test Data

Name Of Test	Para. No.	Result
RF Power Output	2.1046	Complies
Audio Frequency Response	2.1047	Complies
Audio Low-Pass Filter Response	2.1047	Complies
Modulation Limiting	2.1047	Complies
Occupied Bandwidth	2.1049	Complies
Spurious Emissions at Antenna Terminals	2.1051	Complies
Field Strength of Spurious Emissions	2.1053	Complies
Frequency Stability	2.1055	Complies
Transient Frequency Behavior	—	Complies

Footnotes For N/A's:

Test Conditions:

Indoor Temperature: 21°C
 Humidity: 47%

Outdoor Temperature: 21°C
 Humidity: 95%

Section 2. General Equipment Specification

Manufacturer:	Daniels Electronics Ltd.
Family No.:	VT-4D150
Date Received In Laboratory:	28 July 2003
Nemko Identification No.:	1 & 2
Primary Power	13.8 VDC
Emission Designator (Analog) 12.5kHz Ch. Spacing	11K0F3E
25kHz Ch. Spacing	16K0F3E
Emission Designator (Digital) Voice: 12.5kHz Ch. Spacing	8K10F1E
Data: 12.5 kHz Ch. Spacing	8K10F1D
Power Output	Variable: 0.5 - 8 Watts
Channel Spacing	12.5/25 kHz
Frequency Range	
VT-4D140	136 – 150 MHz
VT-4D160	150 – 174 MHz

Section 3. RF Power Output

Para. No.: 2.1046

Test Performed By: Kevin Carr	Date of Test: 29 July 2003
--------------------------------------	-----------------------------------

Minimum Standard: ± 1 dB

Test Results: Complies

Measurement Data: 39.4 dBm, 8.7 Watts

Note: The EUT is variable from 0.5 – 8 Watts

Section 4. Audio Frequency Response

Para. No.: 2.1047

Test Performed By: Kevin Carr	Date of Test: 30 July 2003
--------------------------------------	-----------------------------------

Minimum Standard: Not applicable.

Test Results: Complies

Measurement Data: See attached graph.

Worst Case, 12.5 kHz Ch. Spacing

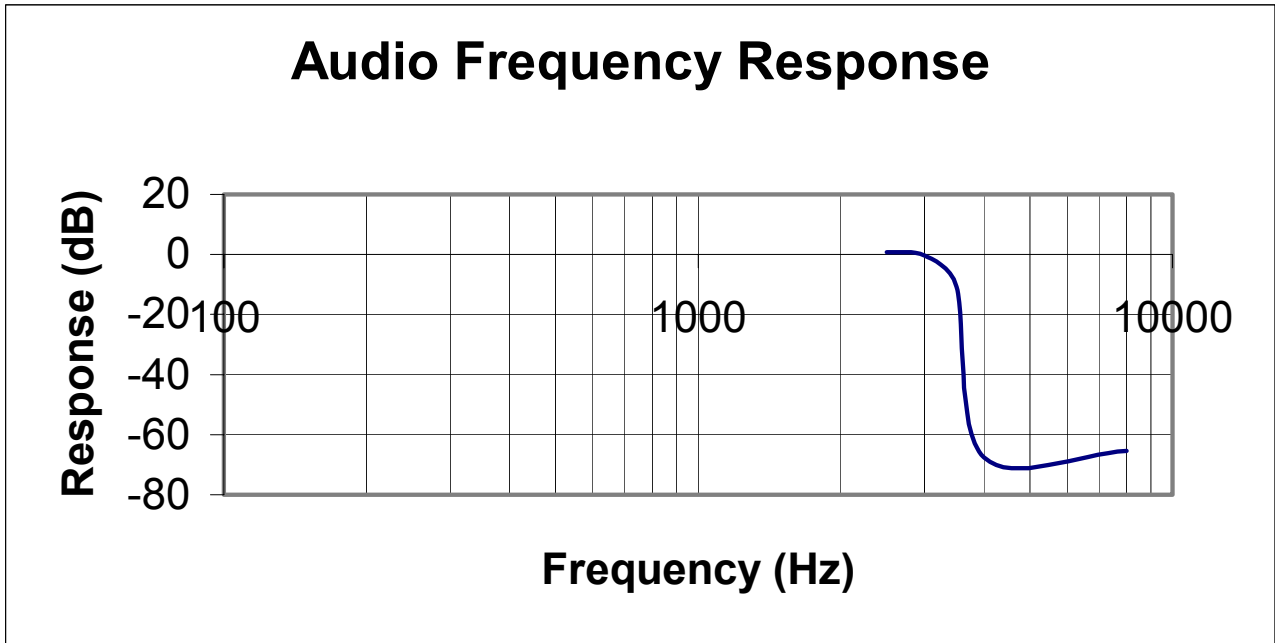

Worst Case, 25kHz Ch. Spacing

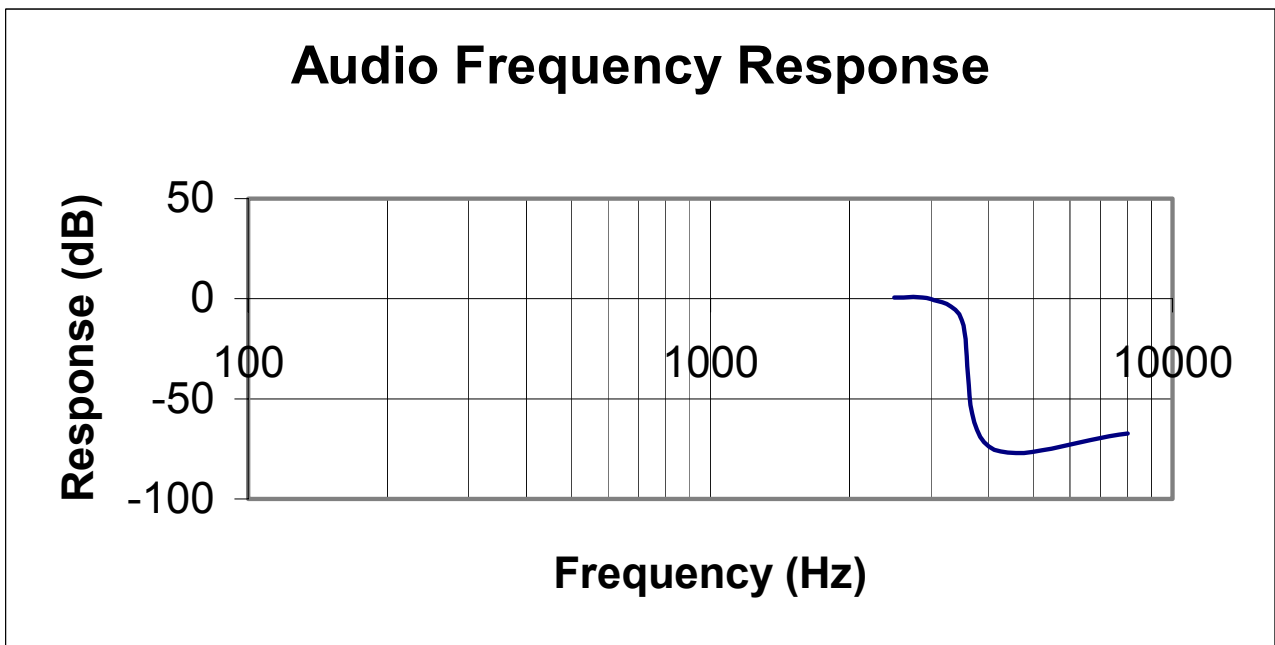

Section 5. Occupied Bandwidth

Para. No.: 2.1049

Test Performed By: Kevin Carr	Date of Test: 29 July 2003
--------------------------------------	-----------------------------------

Minimum Standard: Para. No.'s 90.210(b)
90.210(d)
22.359(a), (b)(1) & (b)(2)

Test Results: Complies

Measurement Data: See attached graphs.

EQUIPMENT:VT-4D150 VHF Transmitter Family

VT-4D140

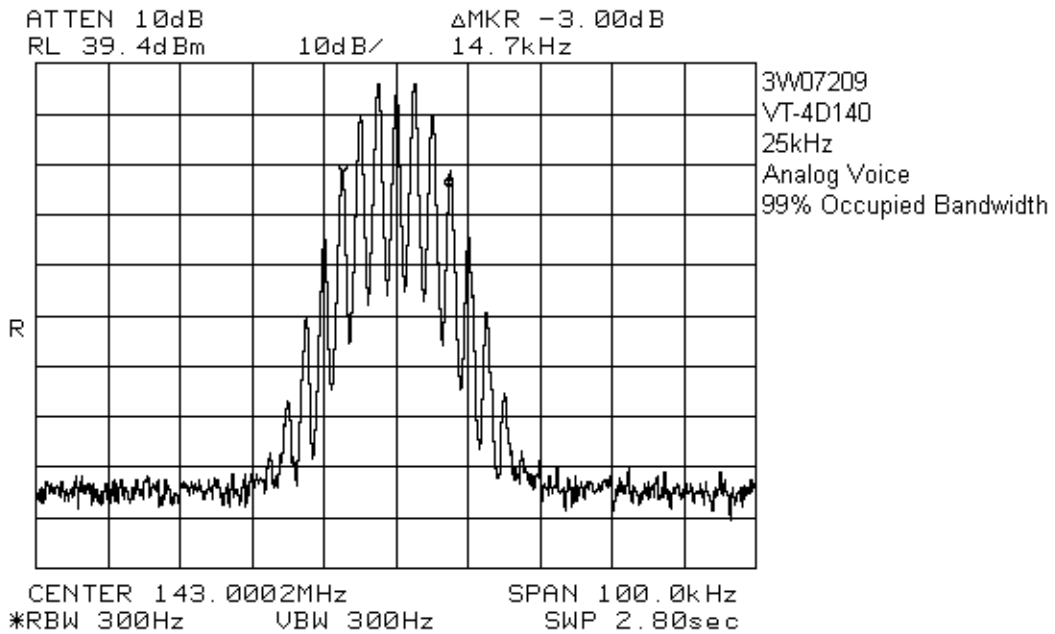
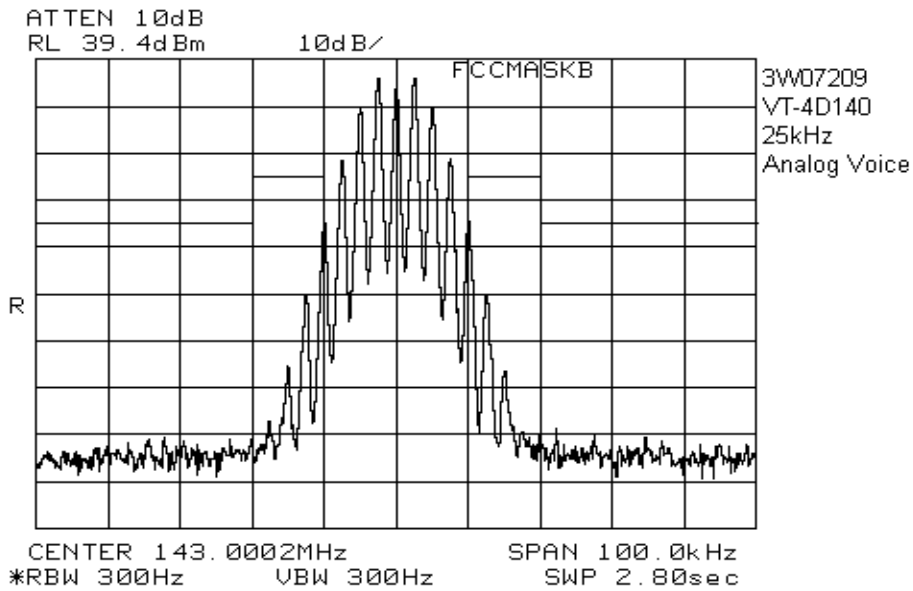

EQUIPMENT:VT-4D150 VHF Transmitter Family

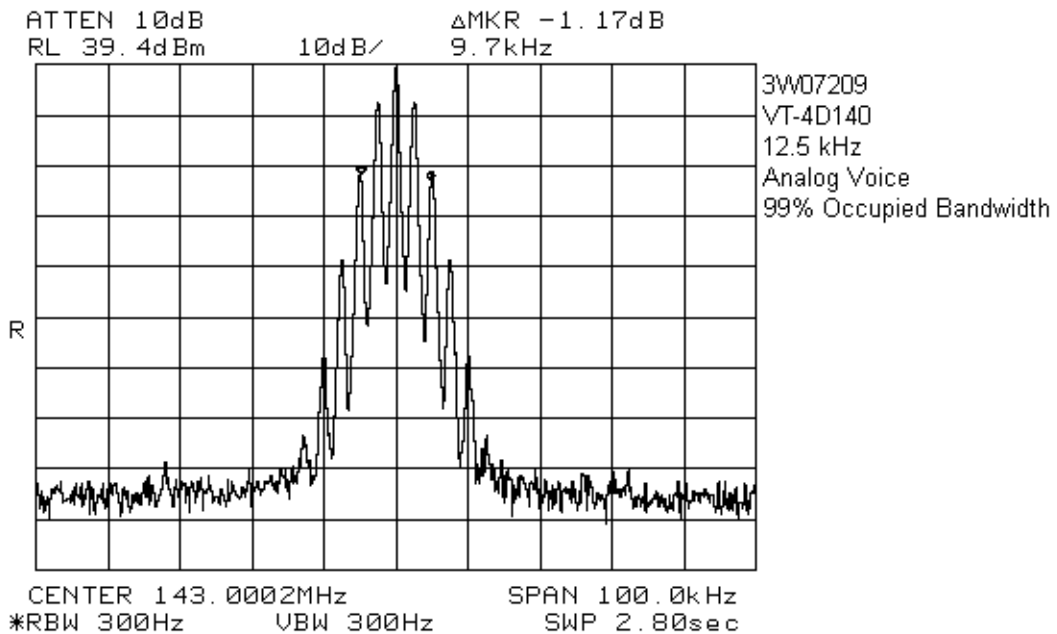
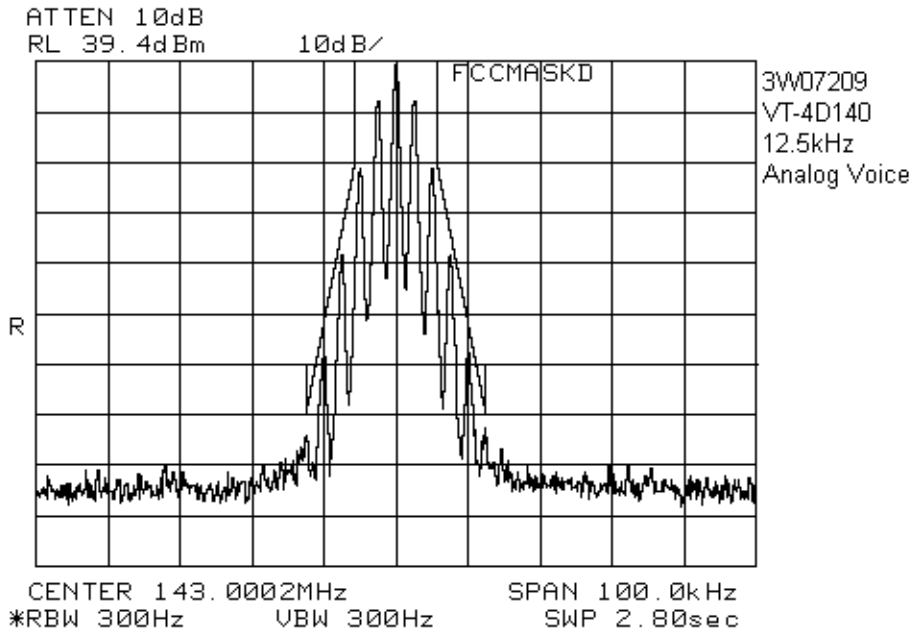

EQUIPMENT:VT-4D150 VHF Transmitter Family

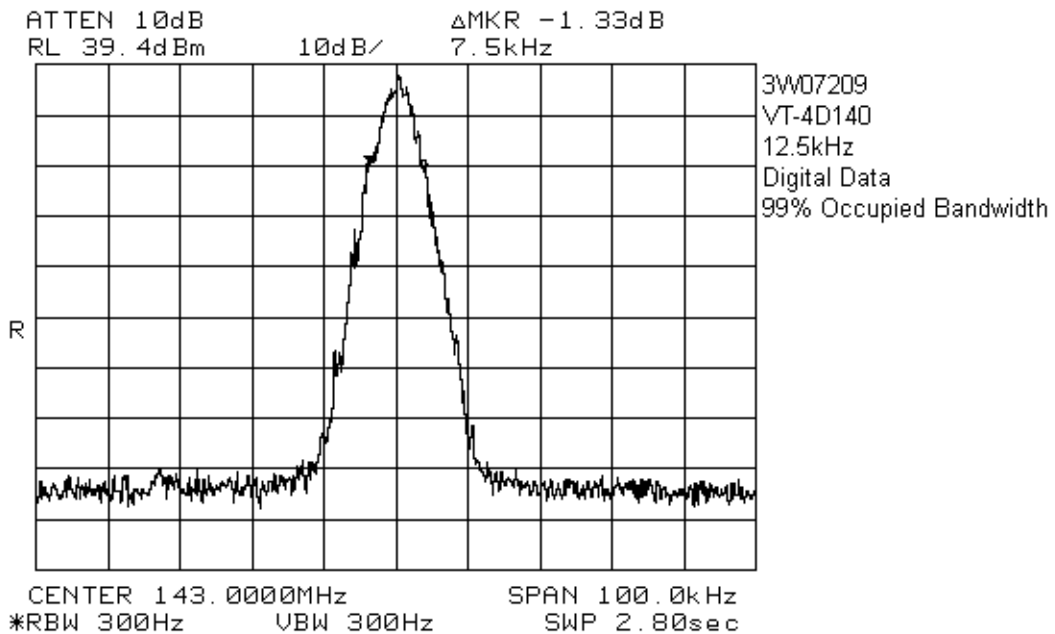
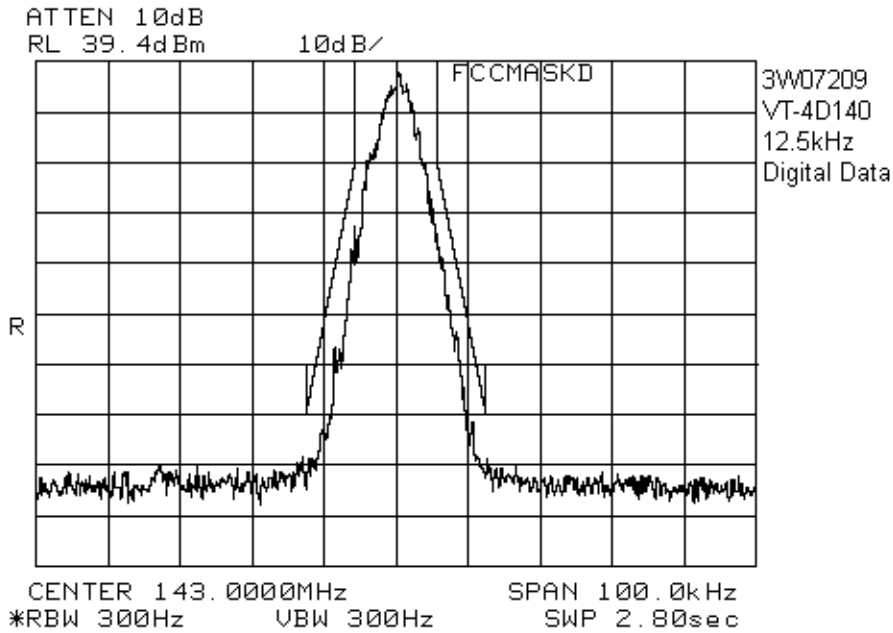

EQUIPMENT:VT-4D150 VHF Transmitter Family

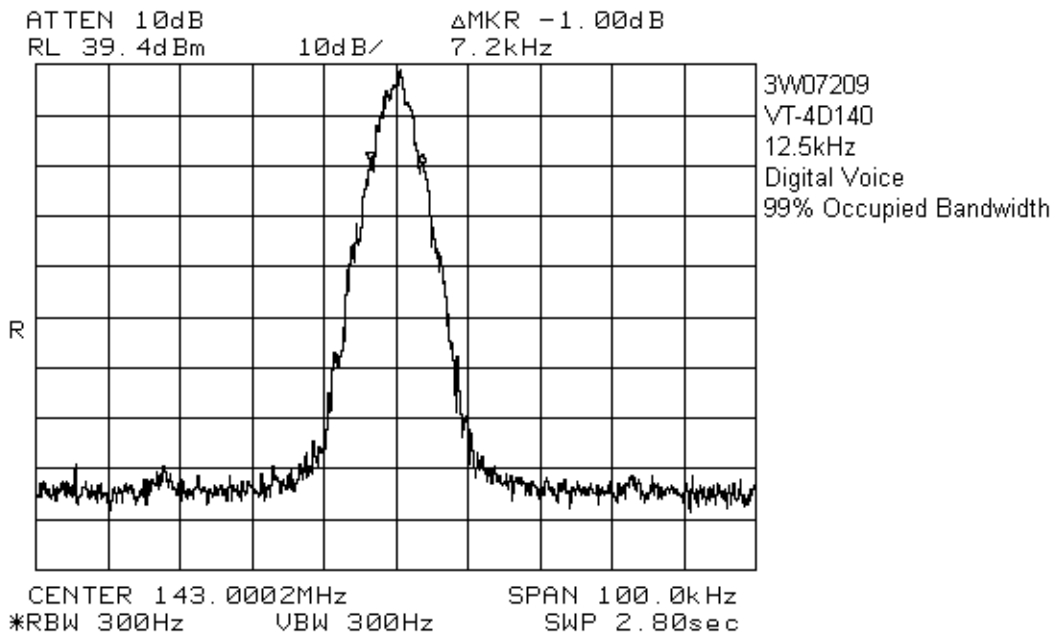
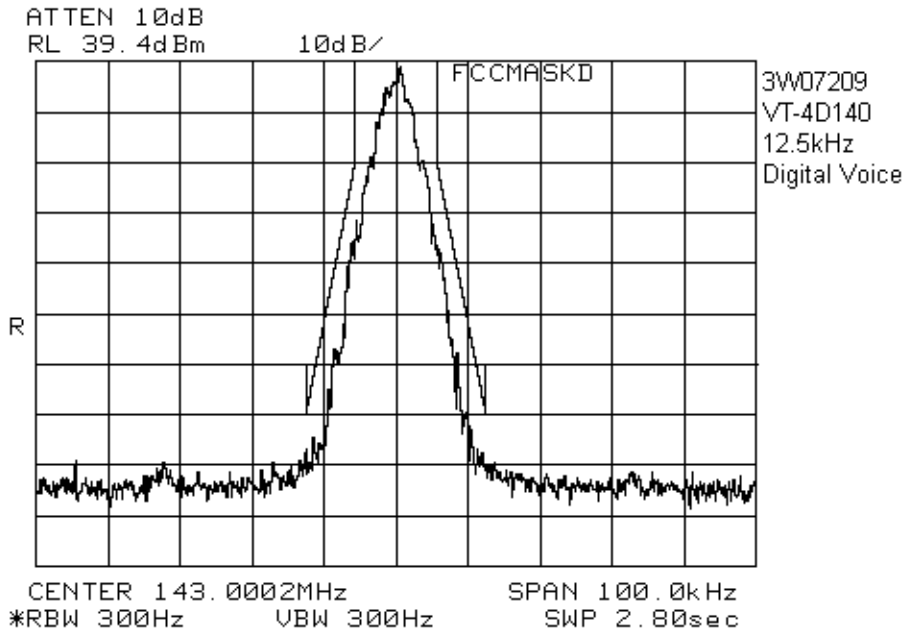

EQUIPMENT:VT-4D150 VHF Transmitter Family

Upper and Lower Frequencies

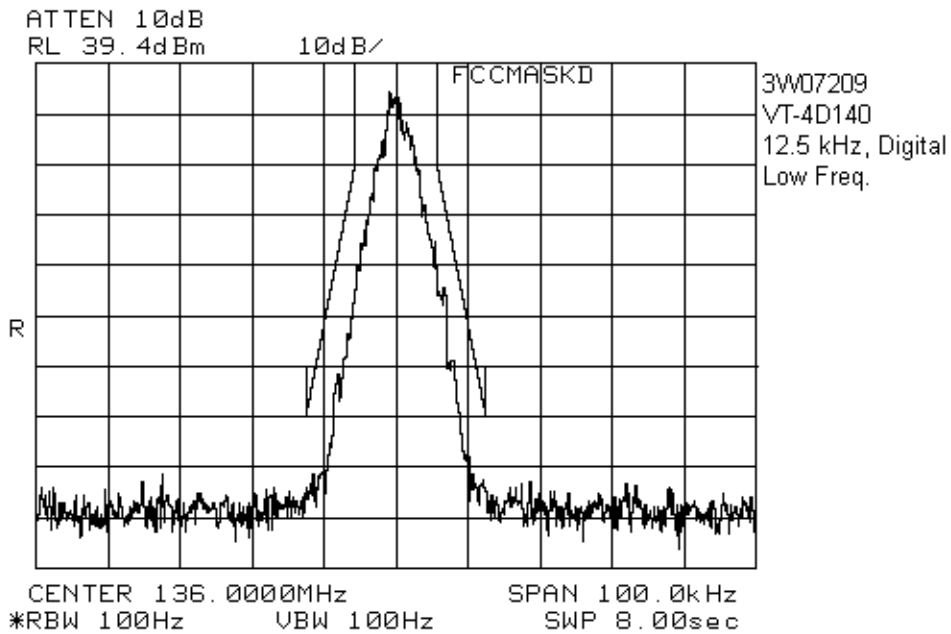
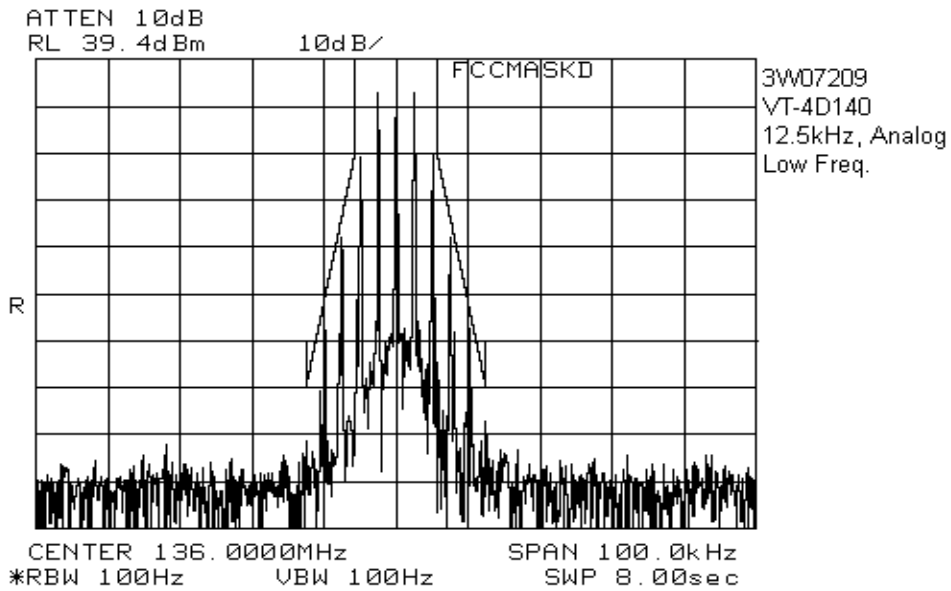

EQUIPMENT:VT-4D150 VHF Transmitter Family

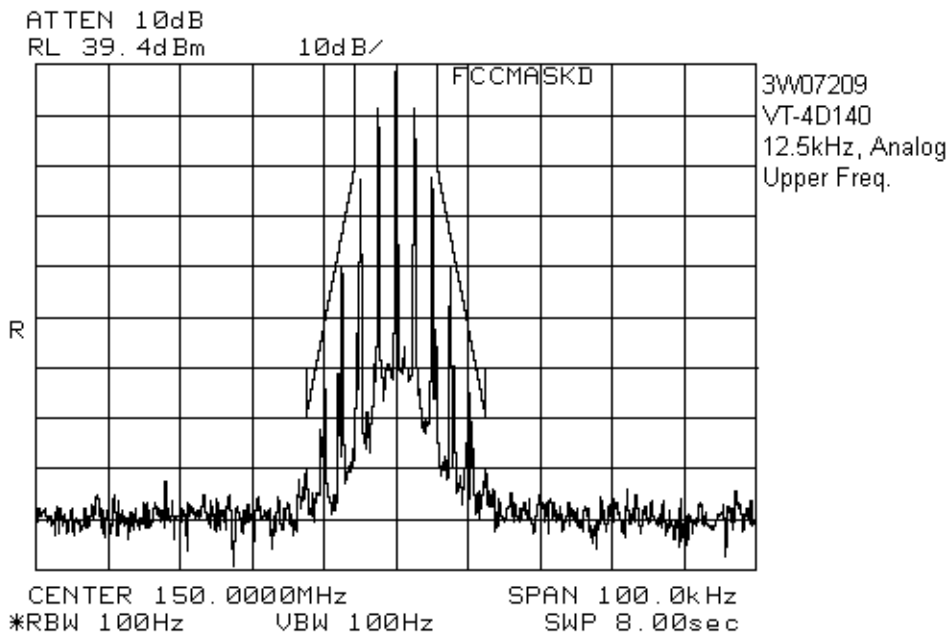
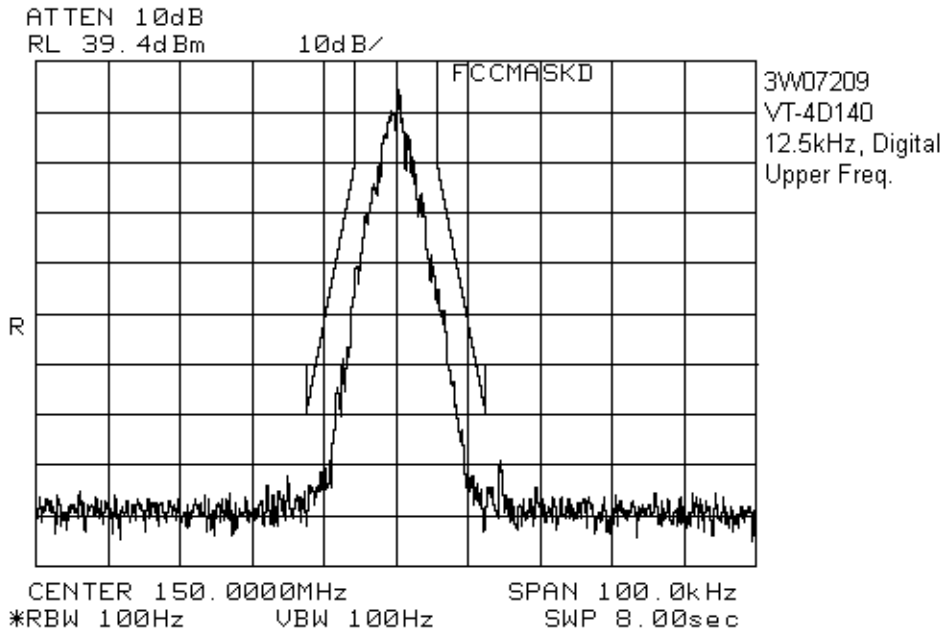

EQUIPMENT:VT-4D150 VHF Transmitter Family

VT-4D160

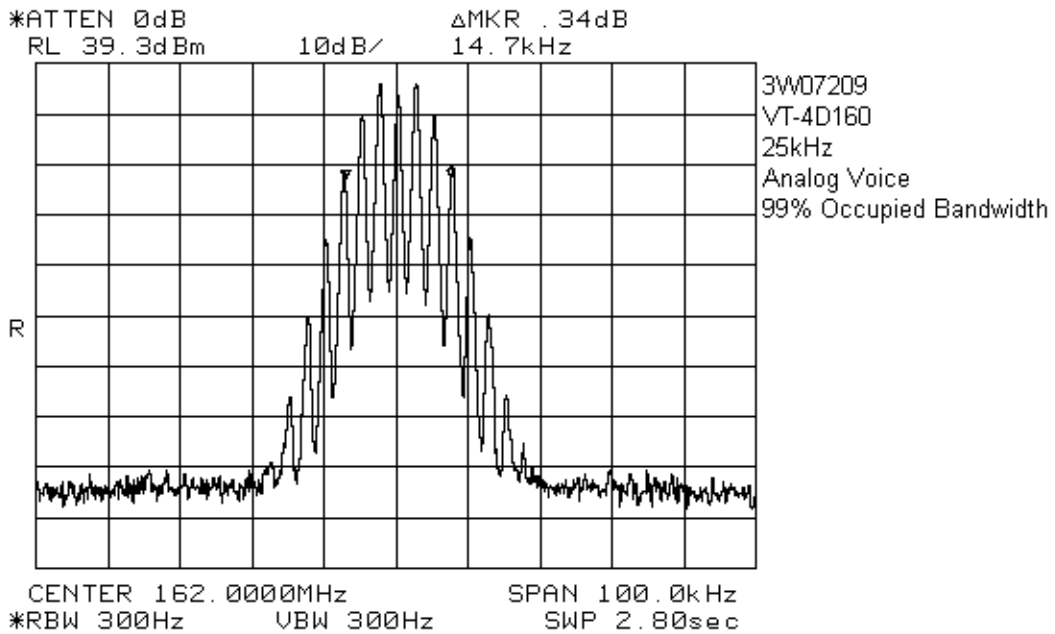
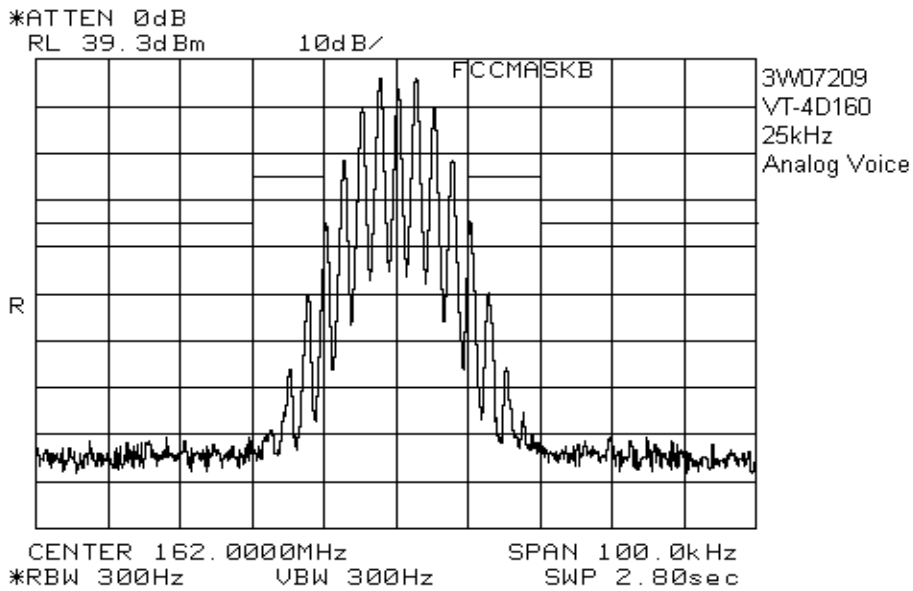

EQUIPMENT:VT-4D150 VHF Transmitter Family

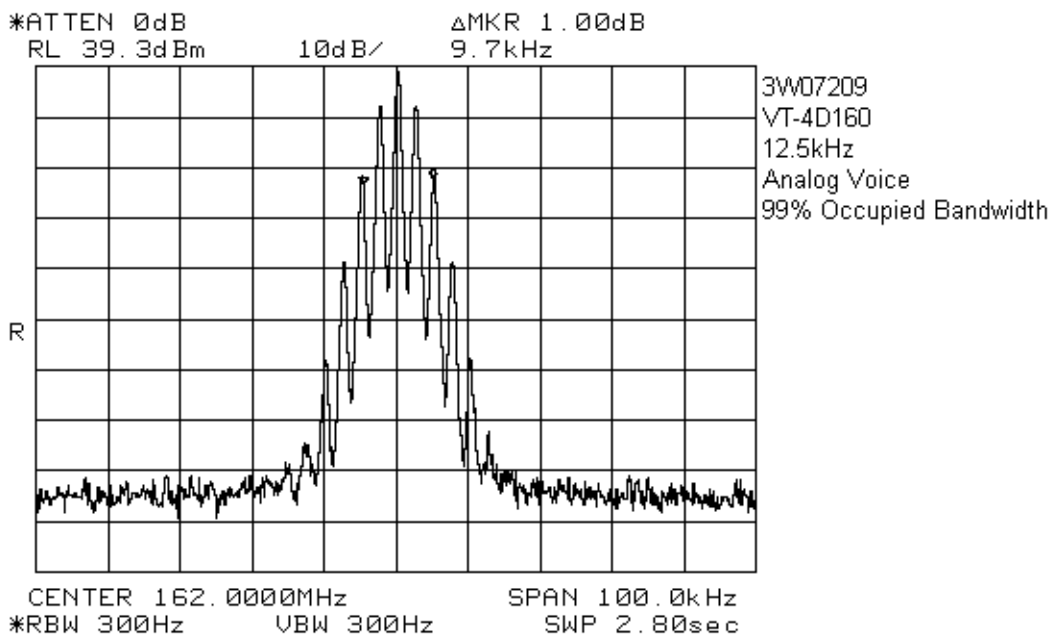
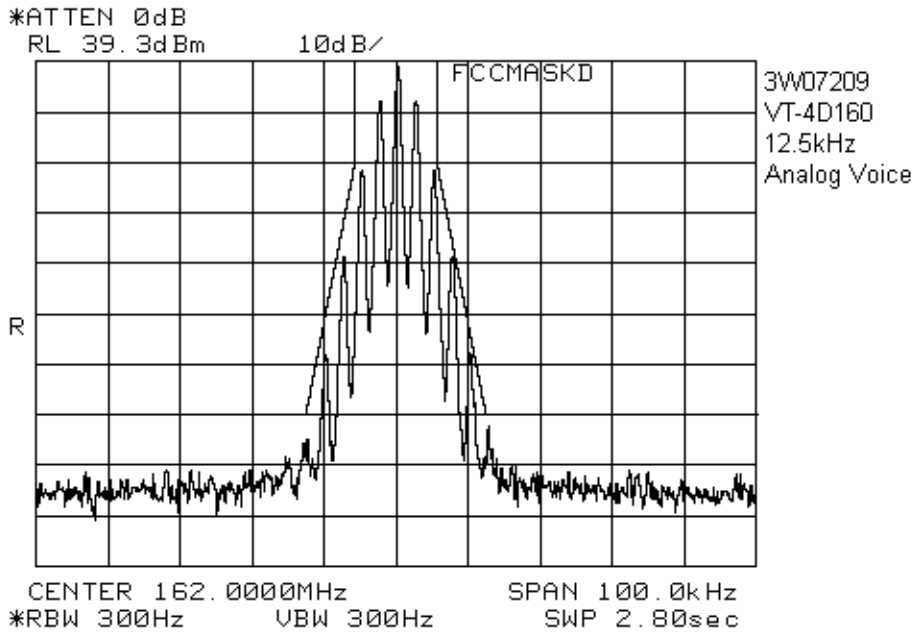

EQUIPMENT:VT-4D150 VHF Transmitter Family

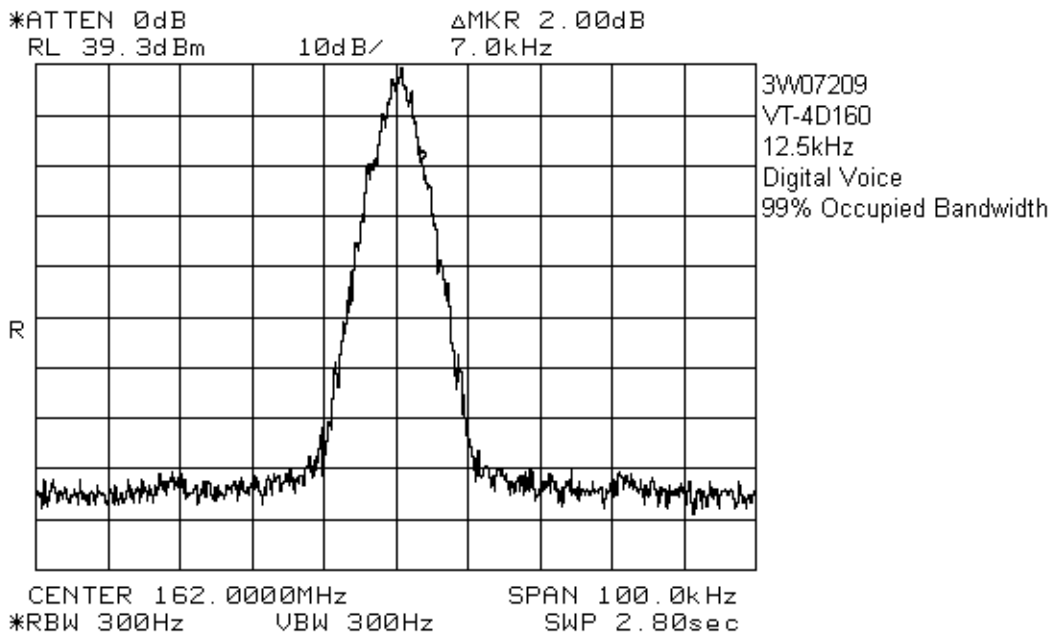
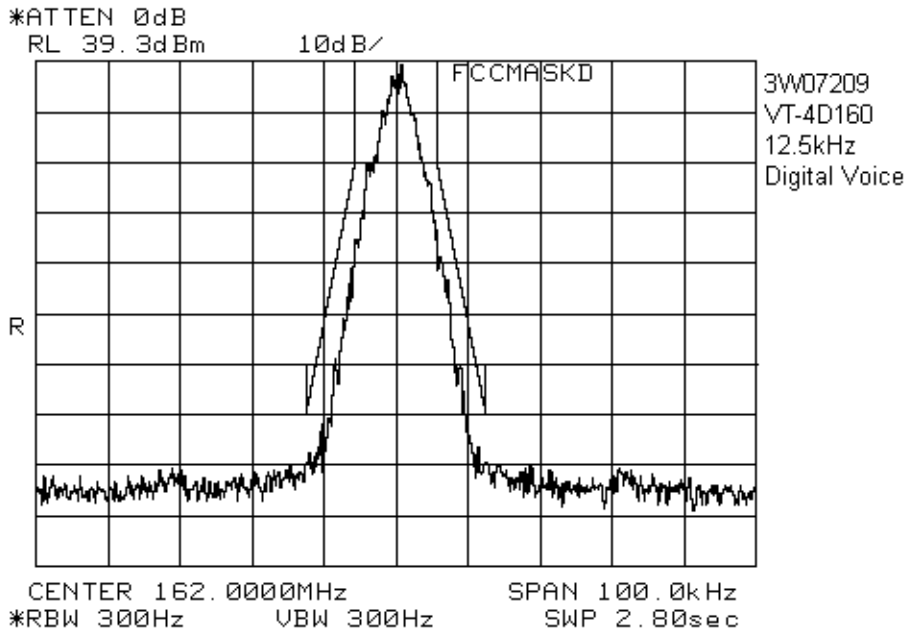

EQUIPMENT:VT-4D150 VHF Transmitter Family

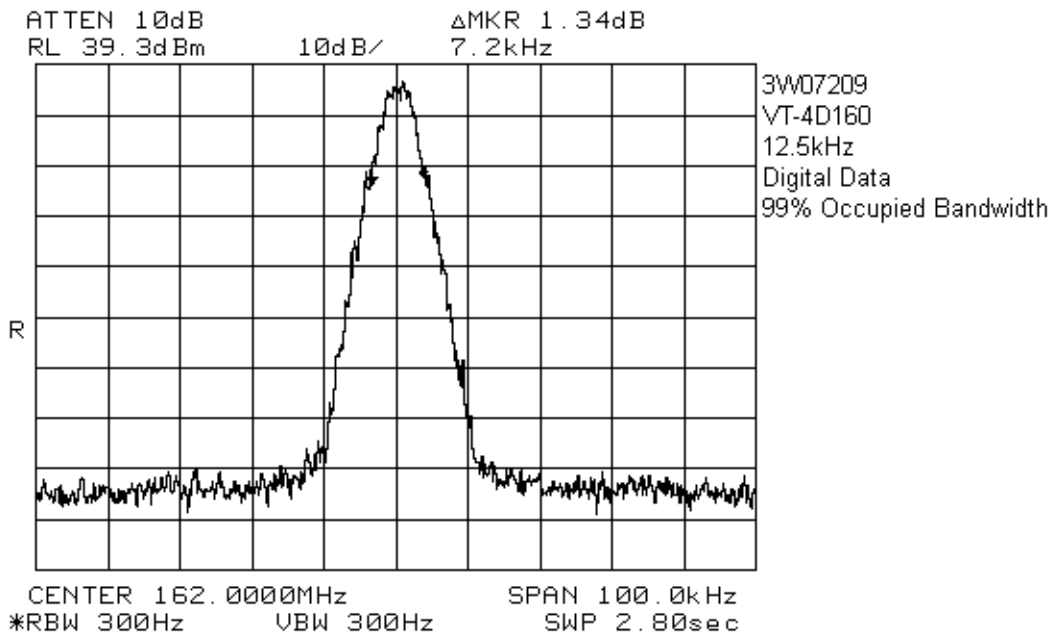
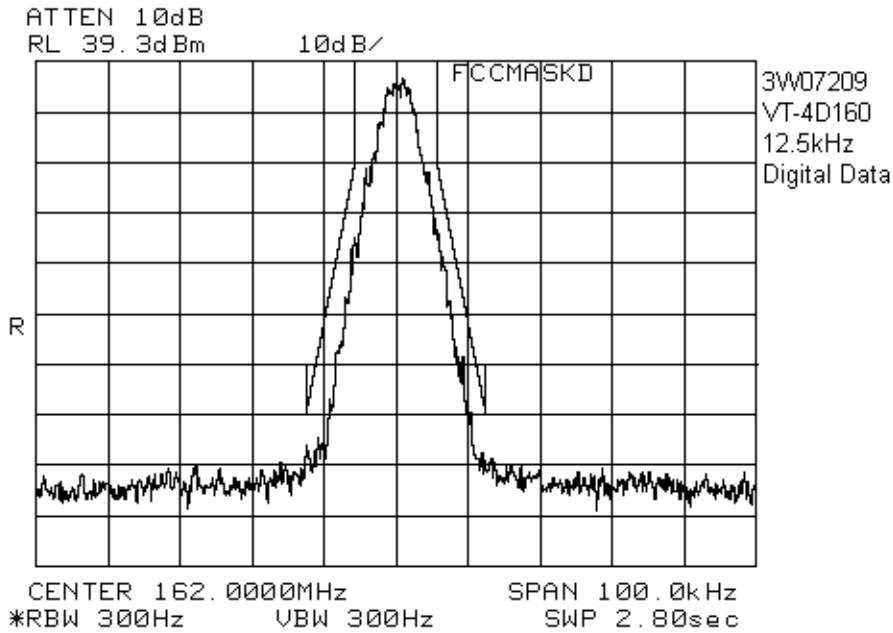

EQUIPMENT:VT-4D150 VHF Transmitter Family

Upper and Lower Frequencies

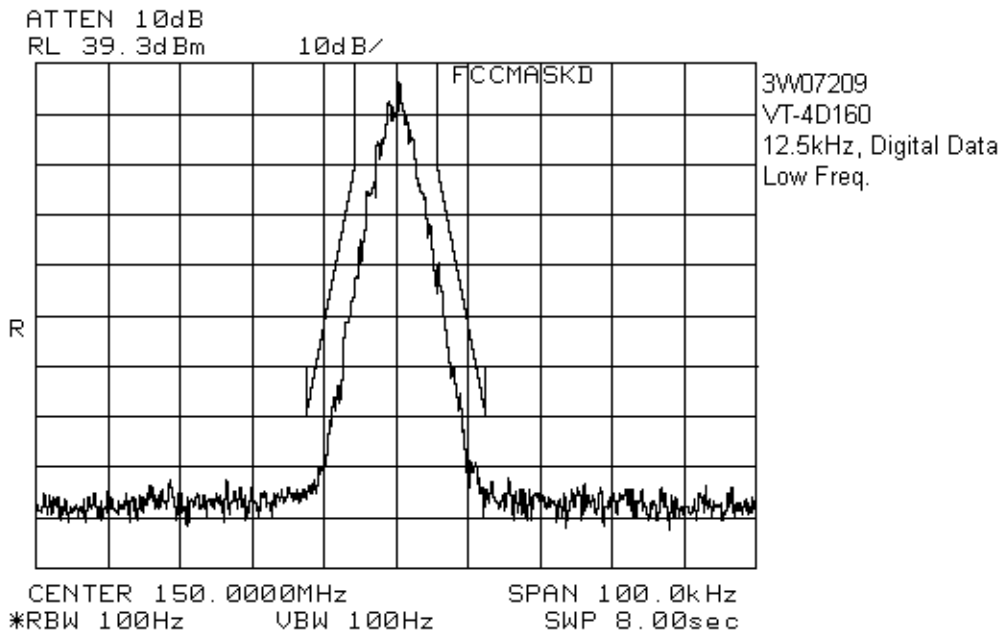
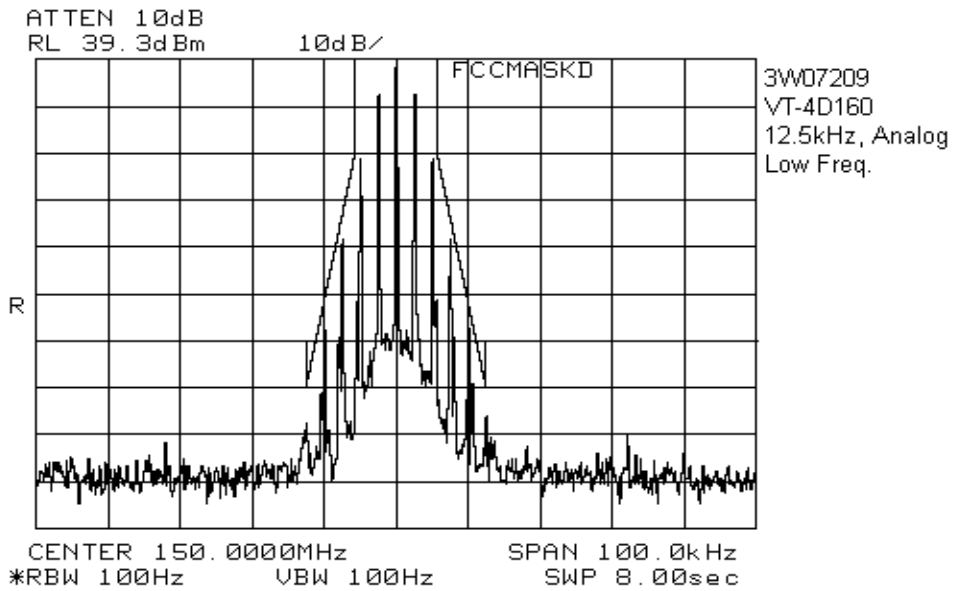

EQUIPMENT:VT-4D150 VHF Transmitter Family

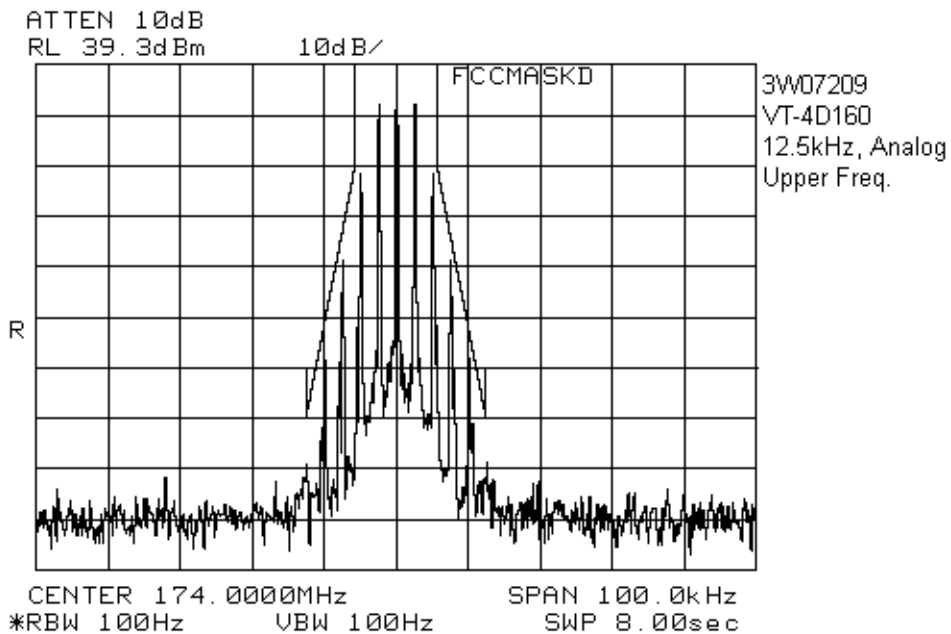
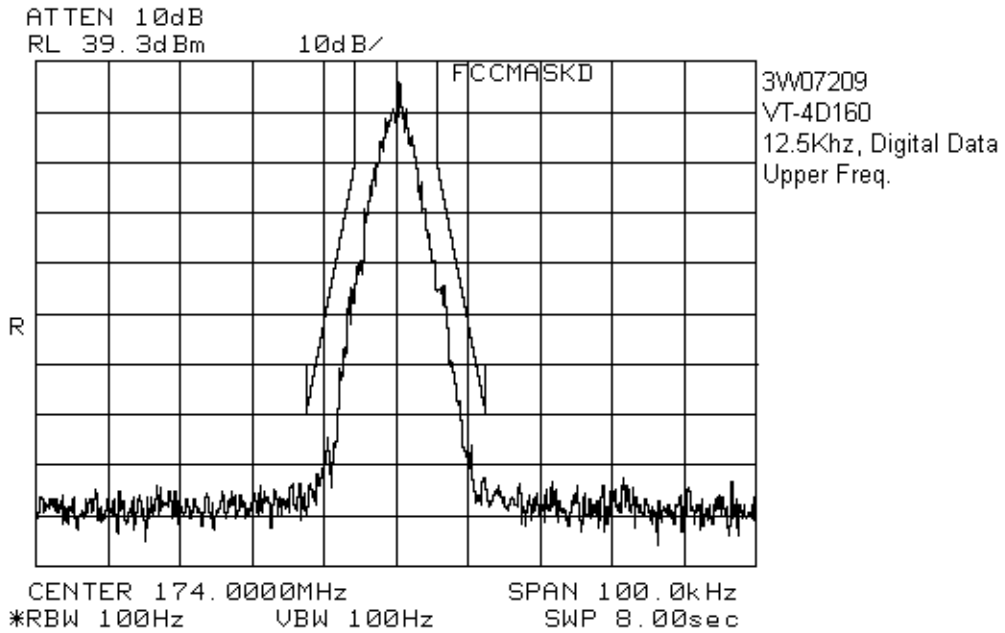

EQUIPMENT:VT-4D150 VHF Transmitter Family

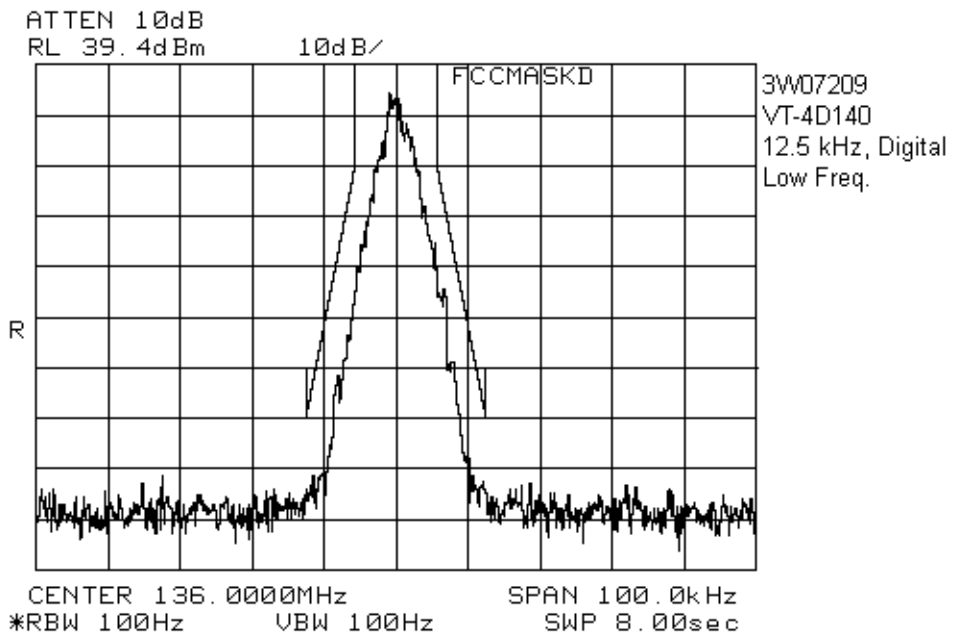
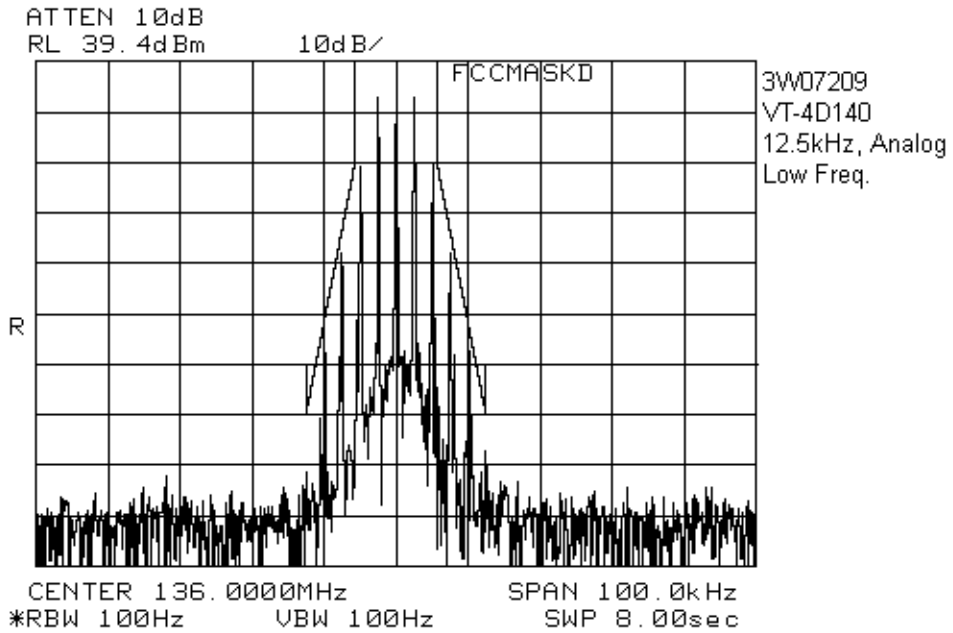

EQUIPMENT:VT-4D150 VHF Transmitter Family

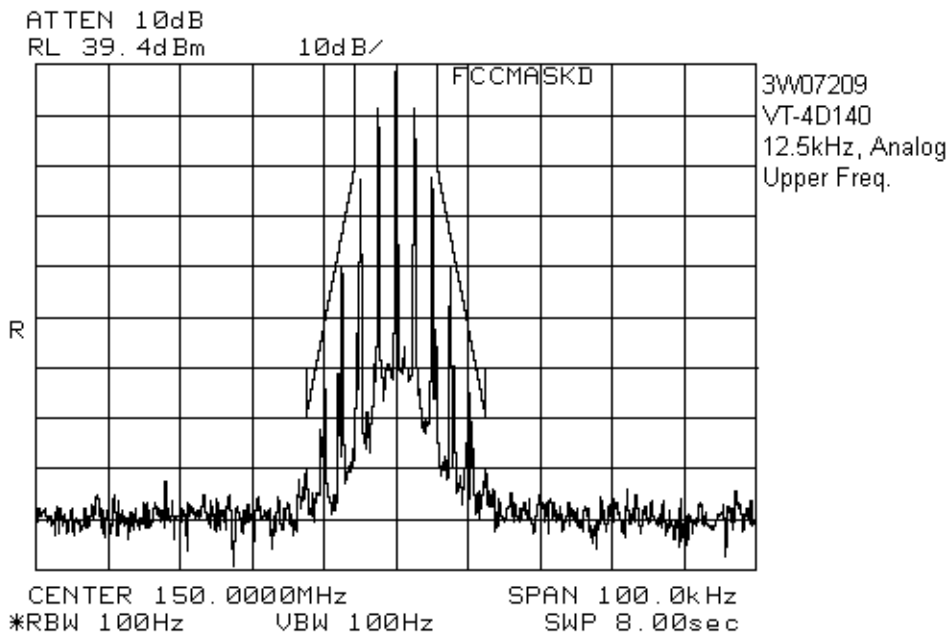
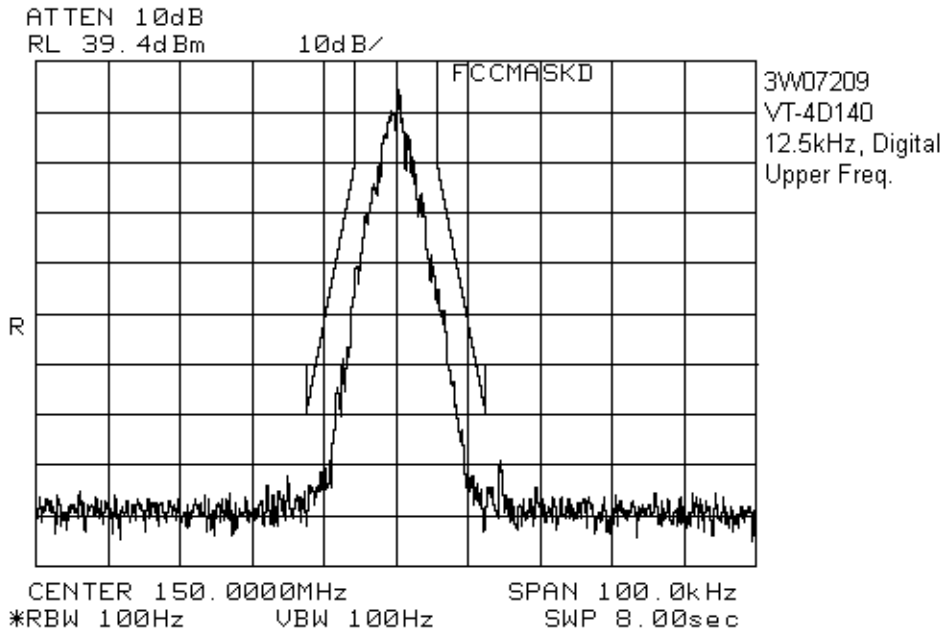

Section 6. Spurious Emissions at Antenna Terminals

Para. No.: 2.1051

Test Performed By: Kevin Carr	Date of Test: 29 July 2003
--------------------------------------	-----------------------------------

Minimum Standard: Para. No.'s 90.210 (b)(d)
22.359(a), (b)(1) & (b)(2)

Test Results: Complies

The worst case emission is -23.99 dBm at 1598 MHz. This is 10.9 dB below the specification limit.

Measurement Data: See attached graphs.

EQUIPMENT:VT-4D150 VHF Transmitter Family

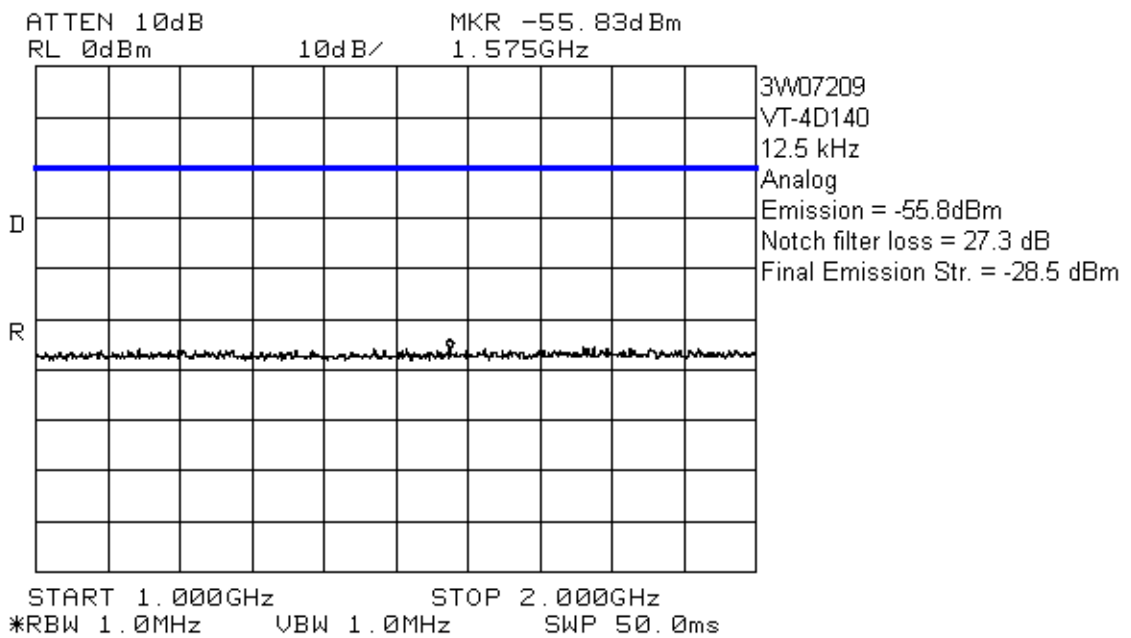
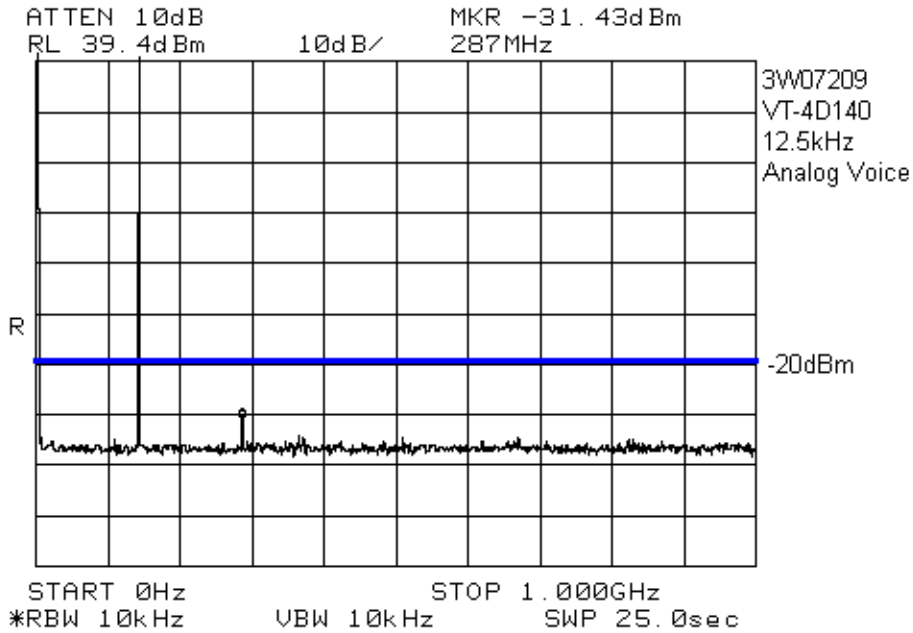

EQUIPMENT:VT-4D150 VHF Transmitter Family

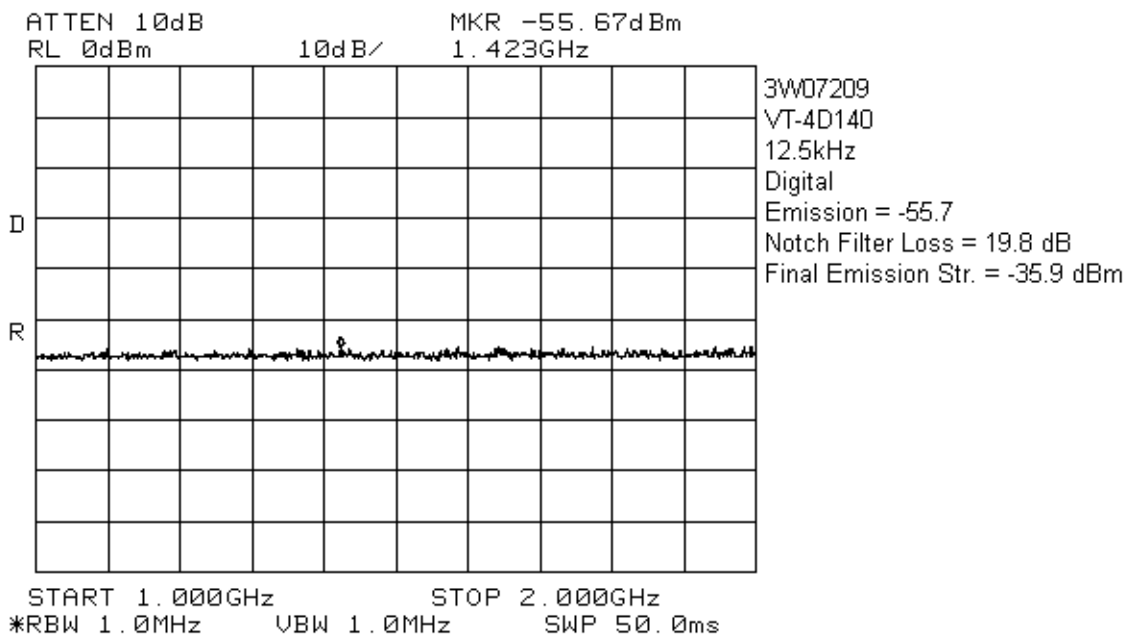
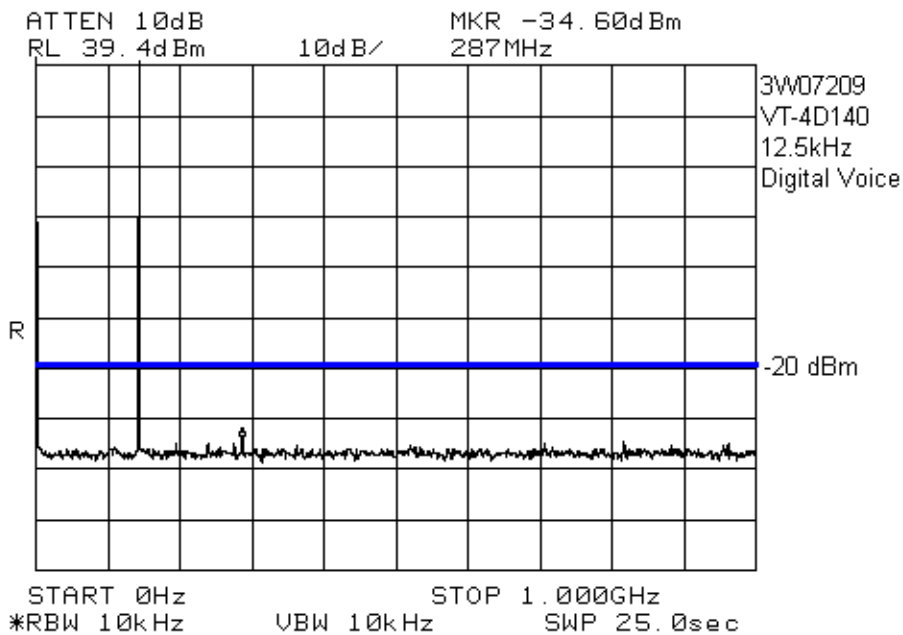

EQUIPMENT:VT-4D150 VHF Transmitter Family

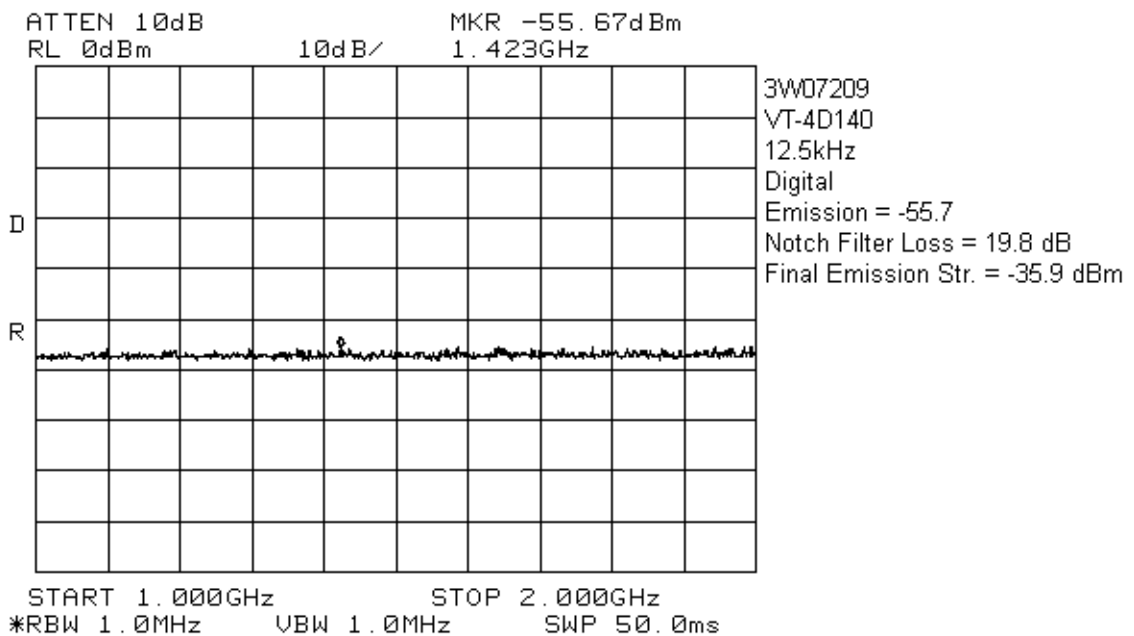
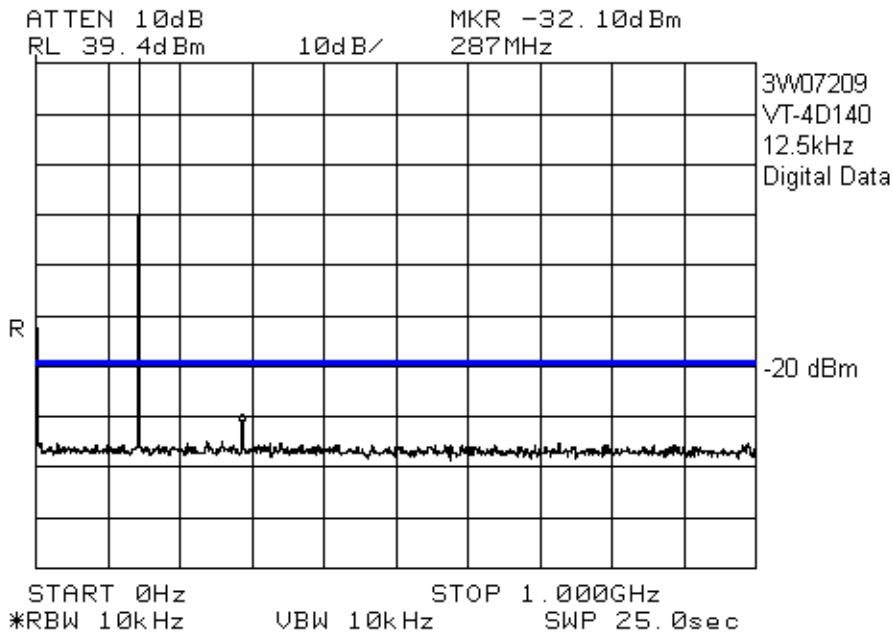

EQUIPMENT:VT-4D150 VHF Transmitter Family

VT-4D160

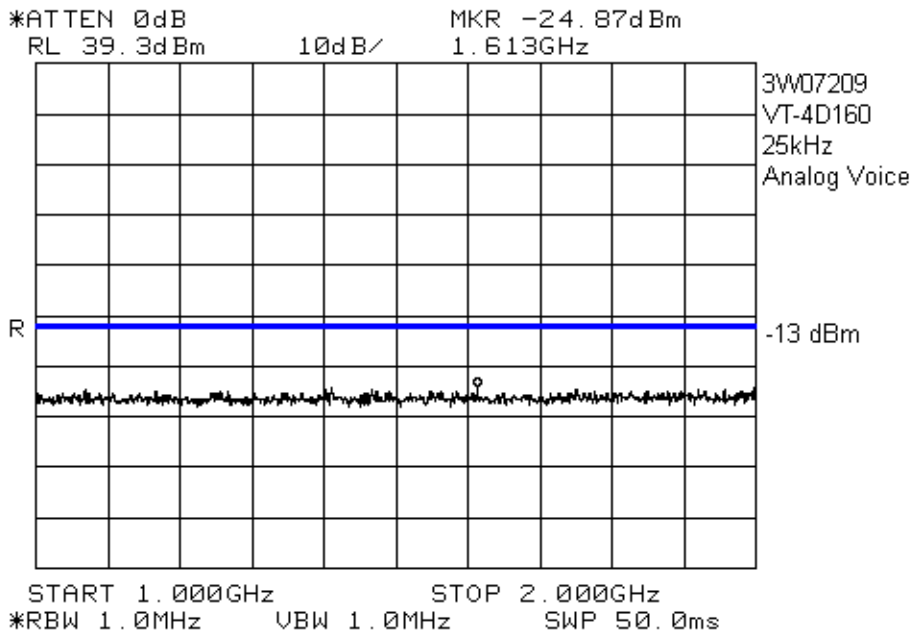
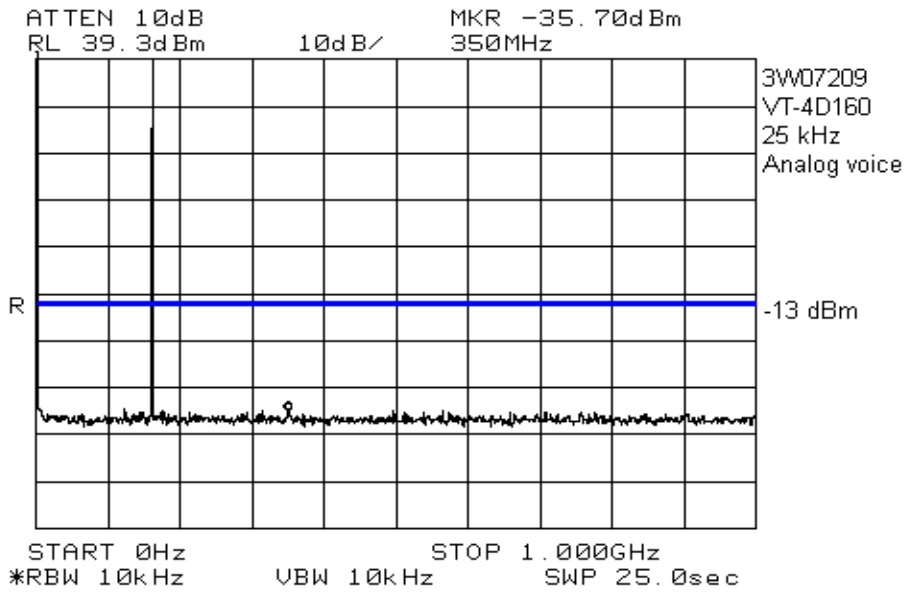

EQUIPMENT:VT-4D150 VHF Transmitter Family

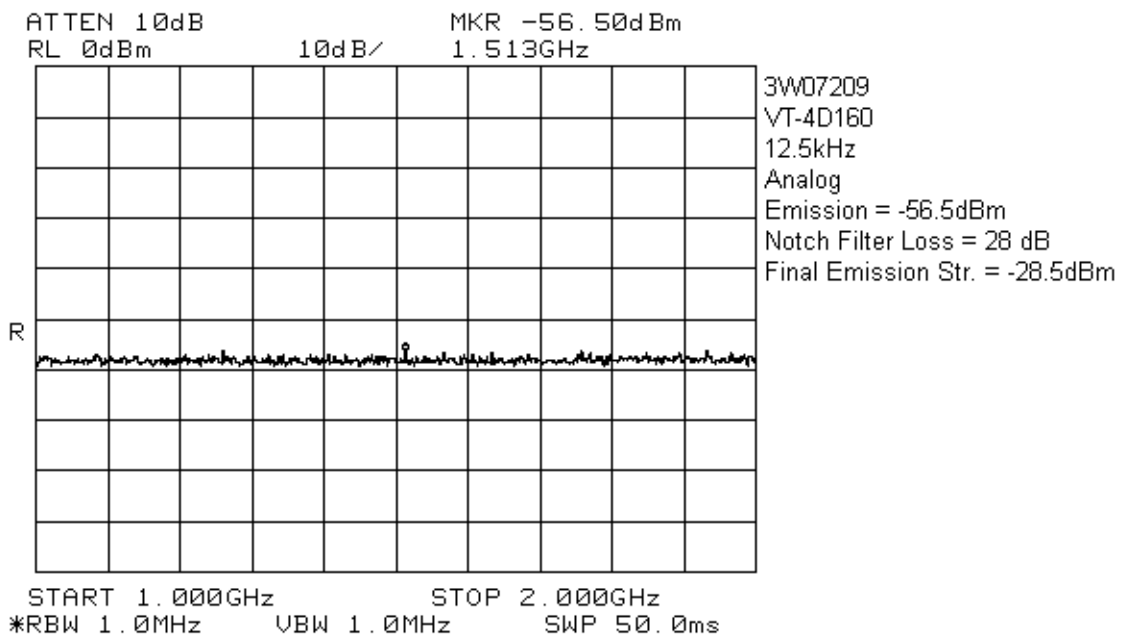
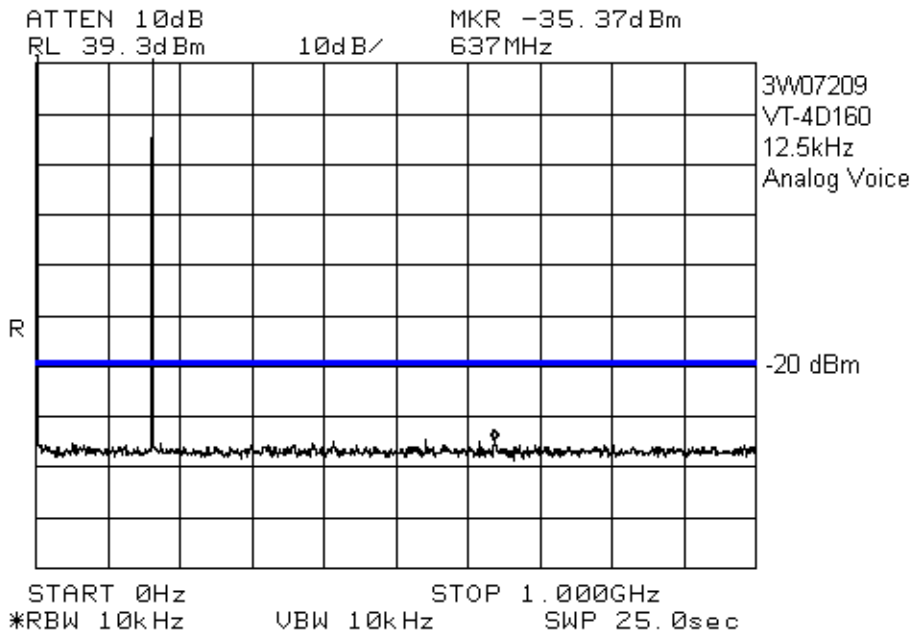

EQUIPMENT:VT-4D150 VHF Transmitter Family

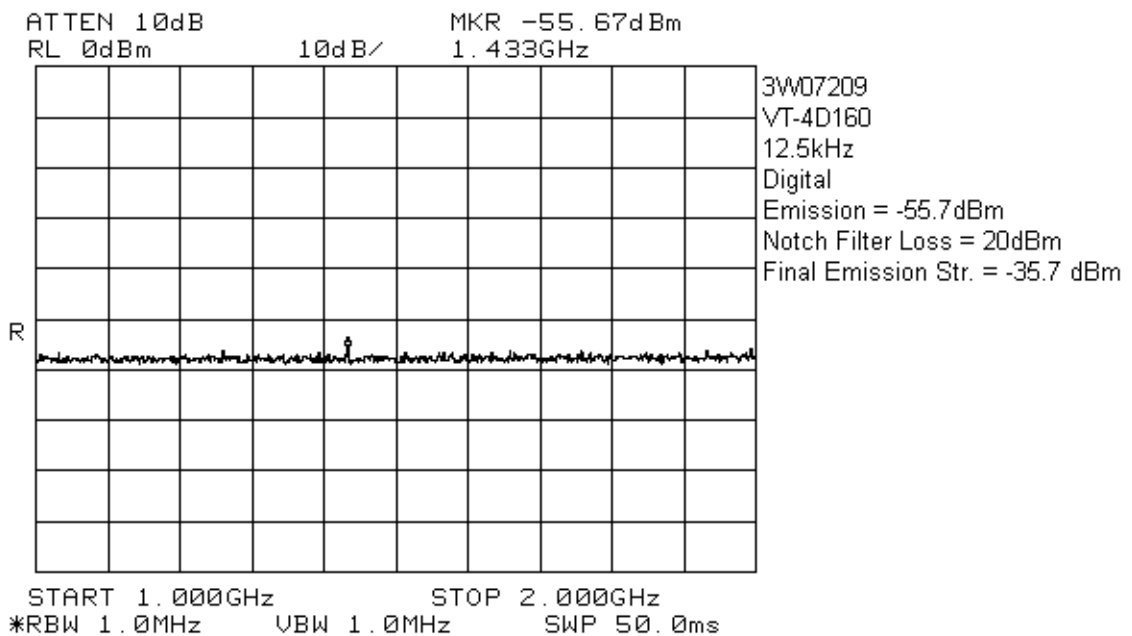
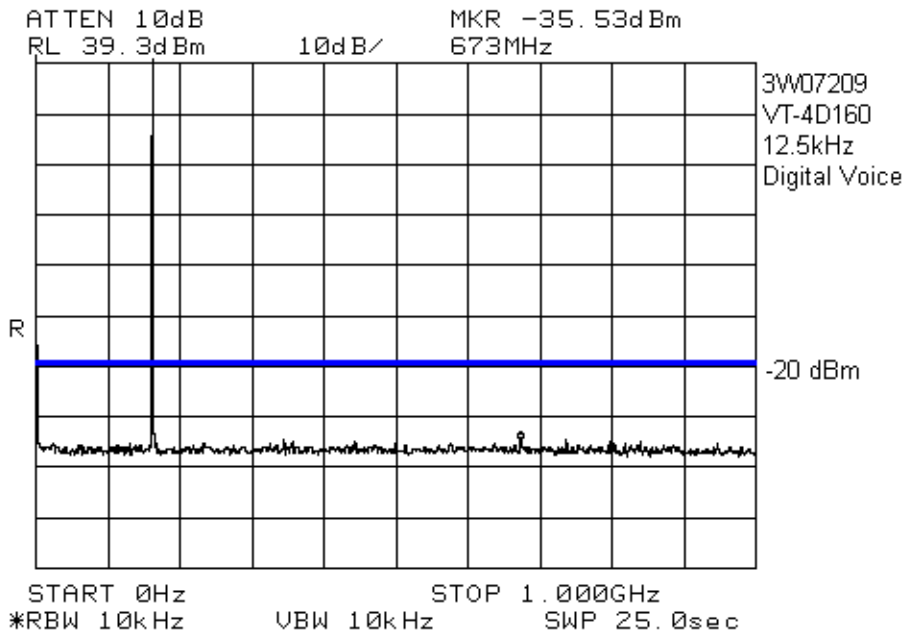

Section 7. Field Strength of Spurious Emissions

Para. No.: 2.1053

Test Performed By: Kevin Carr	Date of Test: 6 Aug. 2003
--------------------------------------	----------------------------------

Minimum Standard: Para. No.'s 90.210 (b), (d)
22.359 (a), (b)(1) & (b)(2)

Test Results: Complies.

The worst case emission is -42 dBm @3m at 572 MHz. This is 22.0 dB below the specification limit.

Measurement Data: See attached tables.

EQUIPMENT:VT-4D150 VHF Transmitter Family

VT4D160 Radiated Emissions

Standard:		Signal Substitution				Date:	6-Aug-03	Tester:	Dome #	1
Tower:		A		Distance:	3 m	Location:	Ottawa	Kevin Carr		
Receiver:		8565E		Comment:		Temp:	21	Humidity:	95	
Frequency (MHz)	Antenna	Polarity	RCVD Signal (dBuV)	Sig. Sub. Factor	Emission Level (dBm)	Limit (dBm)	Margin (dB)	Detector	Amp.	
1	324.0000	LP2	V	21.8	-82.1	-60.3	-20.0	40.3	Peak	None
2	324.0000	LP2	H	22.0	-83.1	-61.1	-20.0	41.1	Peak	None
3	486.0000	LP2	V	22.8	-79.0	-56.2	-20.0	36.2	Peak	None
4	486.0000	LP2	H	21.0	-80.2	-59.2	-20.0	39.2	Peak	None
5	648.0000	LP2	V	21.8	-75.2	-53.4	-20.0	33.4	Peak	None
6	648.0000	LP2	H	21.0	-76.7	-55.7	-20.0	35.7	Peak	None
7	810.0000	LP2	V	22.8	-71.7	-48.9	-20.0	28.9	Peak	None
8	810.0000	LP2	H	22.3	-72.6	-50.3	-20.0	30.3	Peak	None
9	972.0000	LP2	V	22.3	-69.4	-47.1	-20.0	27.1	Peak	None
10	972.0000	LP2	H	23.5	-70.2	-46.7	-20.0	26.7	Peak	None
11	1134.0000	Horn2	V	48.5	-120.5	-72.0	-20.0	52.0	Peak	1-2 GHz
12	1134.0000	Horn2	H	51.7	-121.2	-69.5	-20.0	49.5	Peak	1-2 GHz
13	1296.0000	Horn2	V	49.0	-120.0	-71.0	-20.0	51.0	Peak	1-2 GHz
14	1296.0000	Horn2	H	49.2	-120.1	-70.9	-20.0	50.9	Peak	1-2 GHz
15	1458.0000	Horn2	V	53.5	-119.5	-66.0	-20.0	46.0	Peak	1-2 GHz
16	1458.0000	Horn2	H	50.8	-119.1	-68.3	-20.0	48.3	Peak	1-2 GHz
17	1620.0000	Horn2	V	47.6	-118.2	-70.6	-20.0	50.6	Peak	1-2 GHz
18	1620.0000	Horn2	H	50.3	-119.1	-68.8	-20.0	48.8	Peak	1-2 GHz

EQUIPMENT:VT-4D150 VHF Transmitter Family

VT4D140 Radiated Emissions

Standard:		Signal Substitution				Date:	6-Aug-03	Tester:	Dome #	1	
Tower:		A		Distance:	3 m	Location:	Ottawa	Kevin Carr			
Receiver:		8565E		Comment:		Temp:	21	Humidity:	95		
Frequency (MHz)	Antenna	Polarity	RCVD Signal (dBuV)	Sig. Sub. Factor	Emission Level (dBm)	Limit (dBm)	Margin (dB)	Detector	Amp.		
1	286.0000	BC1	V	20.6	-73.0	-52.4	-20.0	32.4	Peak	None	
2	286.0000	BC1	H	20.5	-75.3	-54.8	-20.0	34.8	Peak	None	
3	429.0000	LP2	V	22.2	-80.7	-58.5	-20.0	38.5	Peak	None	
4	429.0000	LP2	H	23.2	-82.4	-59.2	-20.0	39.2	Peak	None	
5	572.0000	LP2	V	27.7	-77.2	-49.5	-20.0	29.5	Peak	None	
6	572.0000	LP2	H	36.2	-78.2	-42.0	-20.0	22.0	Peak	None	
7	715.0000	LP2	V	22.7	-73.4	-50.7	-20.0	30.7	Peak	None	
8	715.0000	LP2	H	22.7	-75.3	-52.6	-20.0	32.6	Peak	None	
9	858.0000	LP2	V	28.2	-71.2	-43.0	-20.0	23.0	Peak	None	
10	858.0000	LP2	H	25.0	-71.6	-46.6	-20.0	26.6	Peak	None	
11	1001.0000	Horn2	V	50.3	-120.8	-70.5	-20.0	50.5	Peak	1-2 GHz	
12	1001.0000	Horn2	H	53.0	-119.8	-66.8	-20.0	46.8	Peak	1-2 GHz	
13	1144.0000	Horn2	V	50.5	-120.5	-70.0	-20.0	50.0	Peak	1-2 GHz	
14	1144.0000	Horn2	H	50.2	-121.3	-71.1	-20.0	51.1	Peak	1-2 GHz	
15	1287.0000	Horn2	V	49.2	-120.0	-70.8	-20.0	50.8	Peak	1-2 GHz	
16	1287.0000	Horn2	H	48.4	-120.3	-71.9	-20.0	51.9	Peak	1-2 GHz	
17	1430.0000	Horn2	V	47.8	-119.6	-71.8	-20.0	51.8	Peak	1-2 GHz	
18	1430.0000	Horn2	H	48.2	-118.9	-70.7	-20.0	50.7	Peak	1-2 GHz	

EQUIPMENT:VT-4D150 VHF Transmitter Family

OATS Set-Up Photo

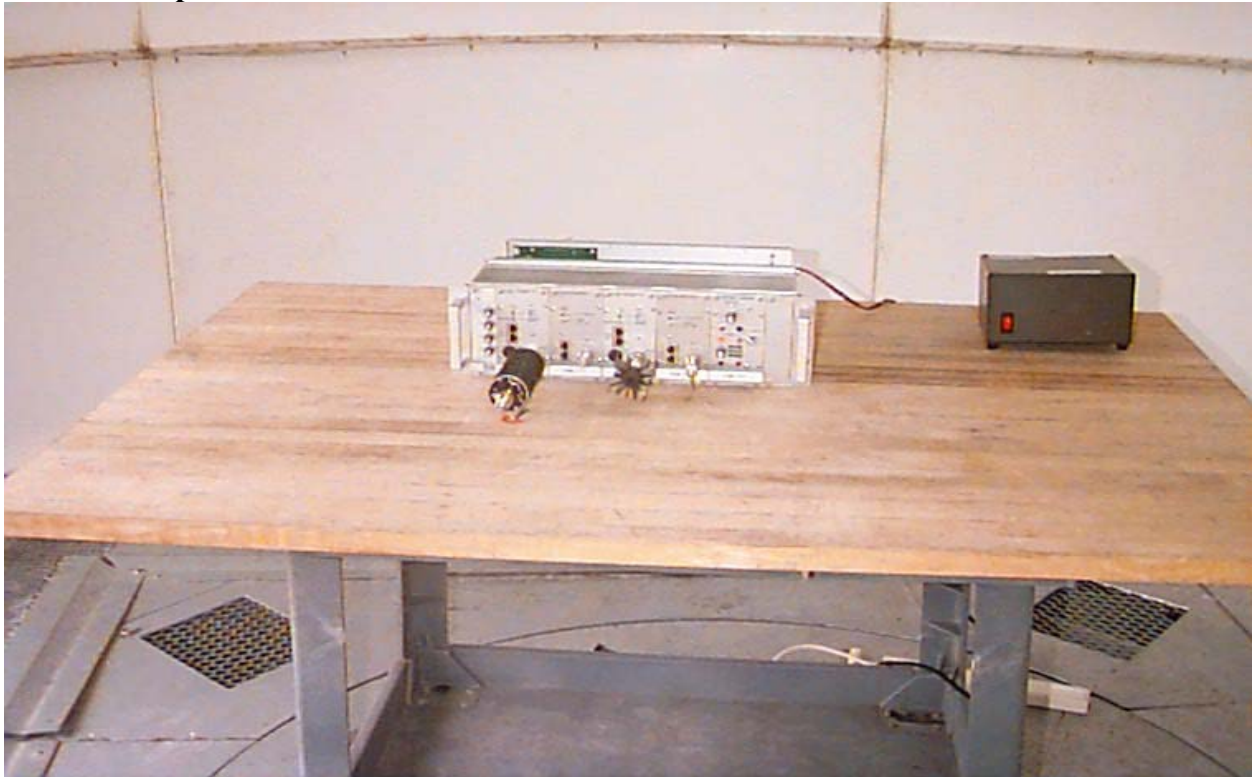

Section 8. Frequency Stability

Para. No.: 2.1055

Test Performed By: Kevin Carr	Date of Test: 30 July 2003
--------------------------------------	-----------------------------------

Minimum Standard: Para. No.'s 22.355
90.213

Test Results: Complies.

The maximum frequency drift is 106 Hz.
This is 1.0 ppm.

Measurement Data: See attached charts.

Standard Test Voltage (STV):	13.8 VDC
Test Frequency:	
VT-4D140	142.999998 MHz
VT-4D160	162.000008 MHz

EQUIPMENT:VT-4D150 VHF Transmitter Family

VT-4D140

Voltage Stability

	Ref. Freq. (MHz)	Measured (MHz)	Variance (Hz)	ppm
85%, 11.7VDC	142.999998	142.999998	0	0
100%, 13.8 VDC	142.999998	142.999998	0	0
115%, 15.9VDC	142.999998	142.999981	17	0

Temperature Stability

	Ref. Freq. (MHz)	Measured (MHz)	Variance (Hz)	ppm
-30	142.999998	143.000104	-106	-1
50	142.999998	142.999934	64	0

VT-4D160

Voltage Stability

	Ref. Freq. (MHz)	Measured (MHz)	Variance (Hz)	ppm
85%, 11.7VDC	162.000008	162.000008	0	0
100%, 13.8 VDC	162.000008	162.000008	0	0
115%, 15.9VDC	162.000008	162.000010	-2	0

Temperature Stability

	Ref. Freq. (MHz)	Measured (MHz)	Variance (Hz)	ppm
-30	162.000008	162.000061	-53	0
50	162.000008	162.000006	2	0

Section 9. Transient Frequency Behaviour

Test Performed By: Kevin Carr	Date of Test: 1 Aug. 2003
--------------------------------------	----------------------------------

Minimum Standard: Para. No. 90.214

Test Results: Complies.

Measurement Data: See attached graphs.

EQUIPMENT:VT-4D150 VHF Transmitter Family

VT-4D140, 12,5kHz Ch. Spacing
Tek **Stop**: Single Seq 5.00kS/s

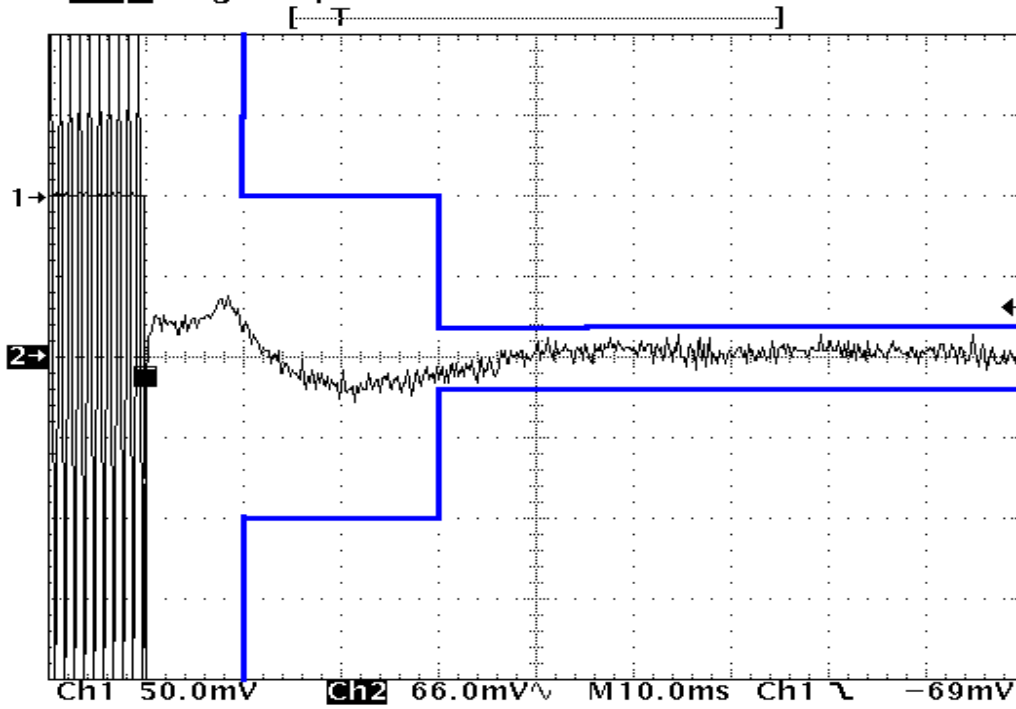

Tek **Stop**: Single Seq 5.00kS/s

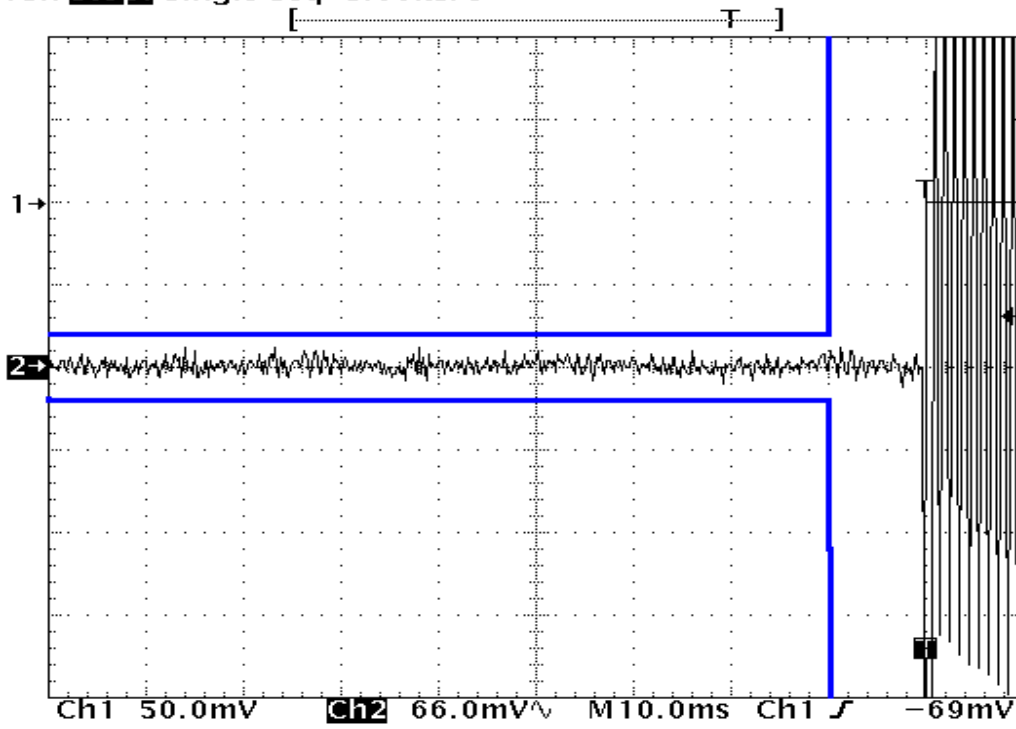

EQUIPMENT:VT-4D150 VHF Transmitter Family

VT-4D140, 25kHz Ch. Spacing
Tek **Stop**: Single Seq 5.00kS/s

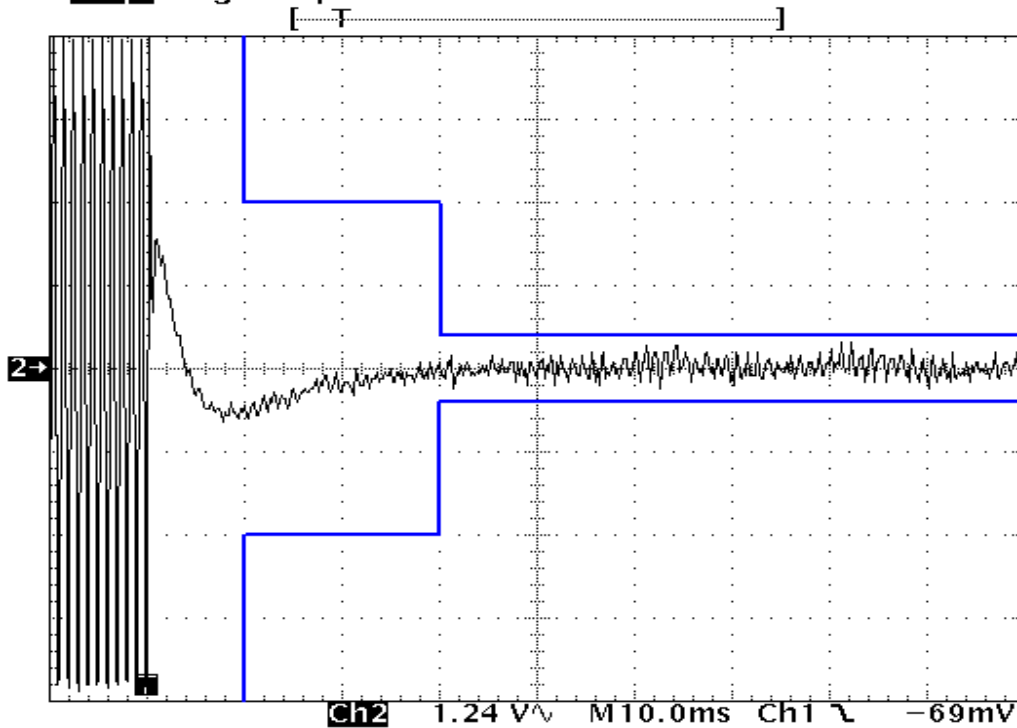

1 Aug 2003
07:19:00

Tek **Stop**: Single Seq 5.00kS/s

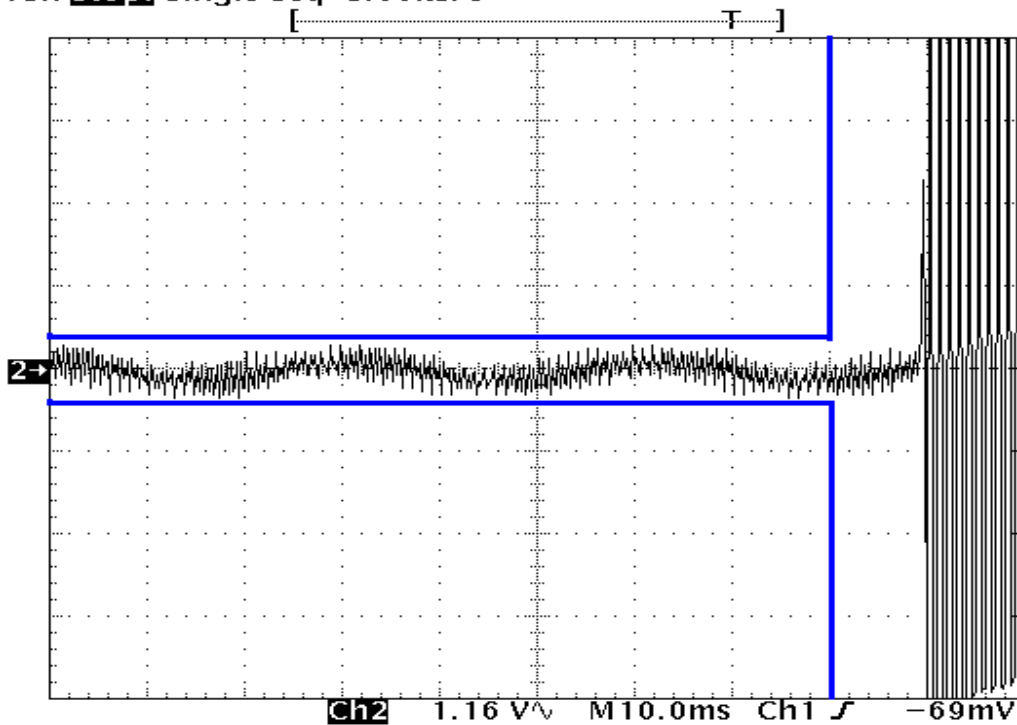

1 Aug 2003
08:06:27

EQUIPMENT:VT-4D150 VHF Transmitter Family

VT-4D160, 12.5kHz Ch. Spacing
Tek **Stop**: Single Seq 5.00kS/s

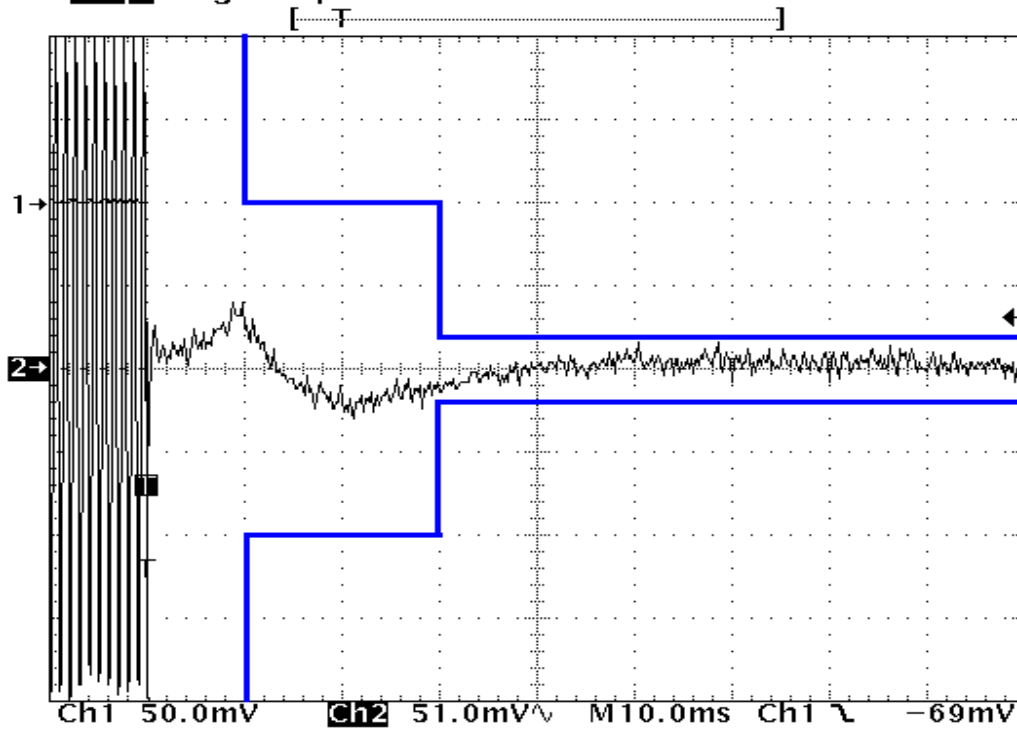

1 Aug 2003
09:48:31

Tek **Stop**: Single Seq 5.00kS/s

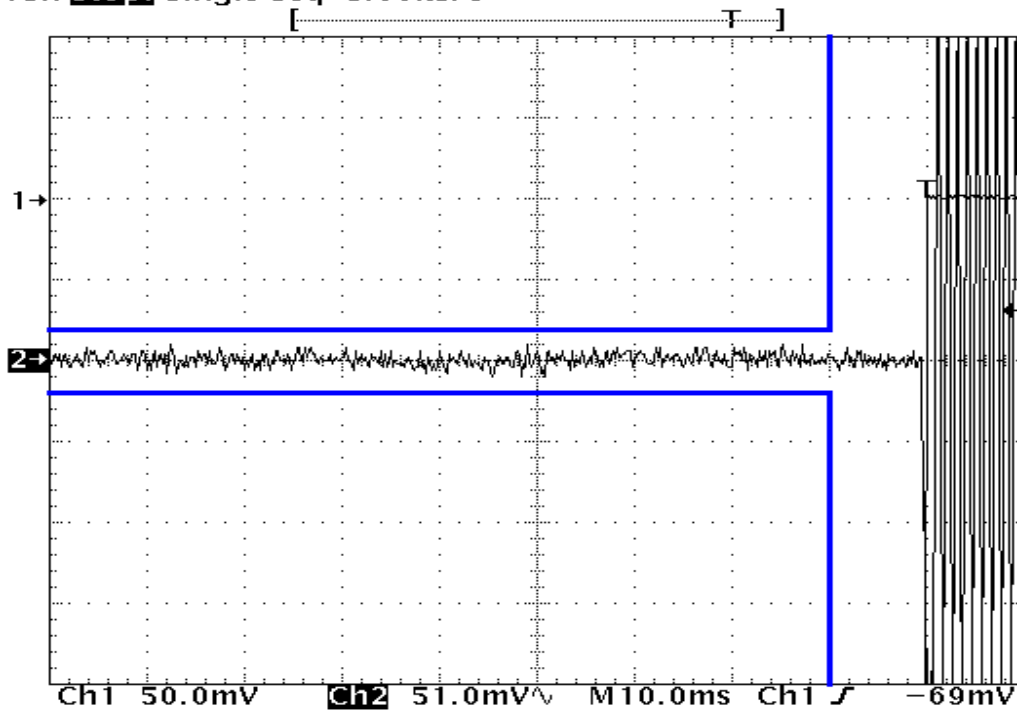

1 Aug 2003
09:46:54

EQUIPMENT:VT-4D150 VHF Transmitter Family

VT-4D140, 25kHz Ch. Spacing
Tek **Stop**: Single Seq 5.00kS/s

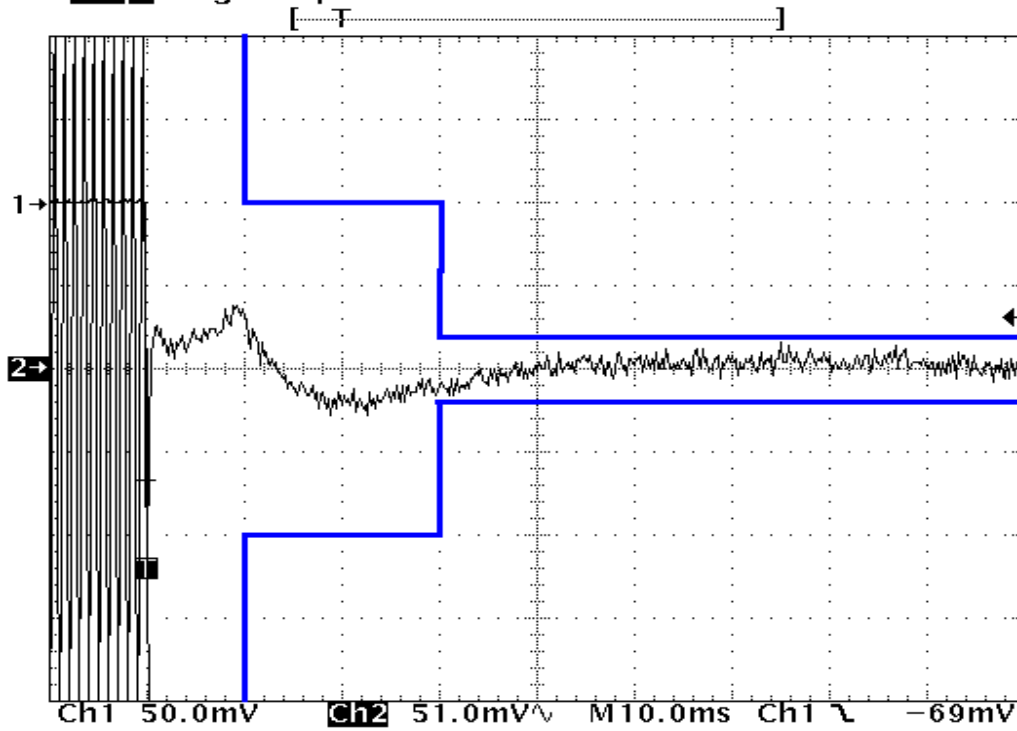

1 Aug 2003
09:28:19

Tek **Stop**: Single Seq 5.00kS/s

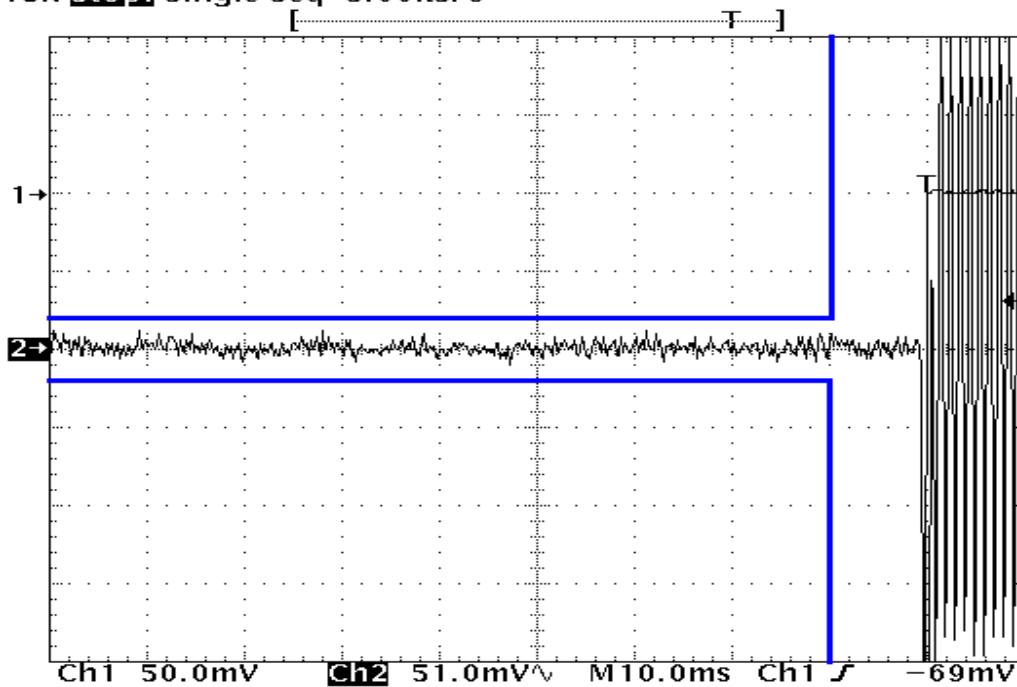

1 Aug 2003
09:28:57

Section 10. Block Diagrams

Para. No. 2.1046 - R.F. Power Output

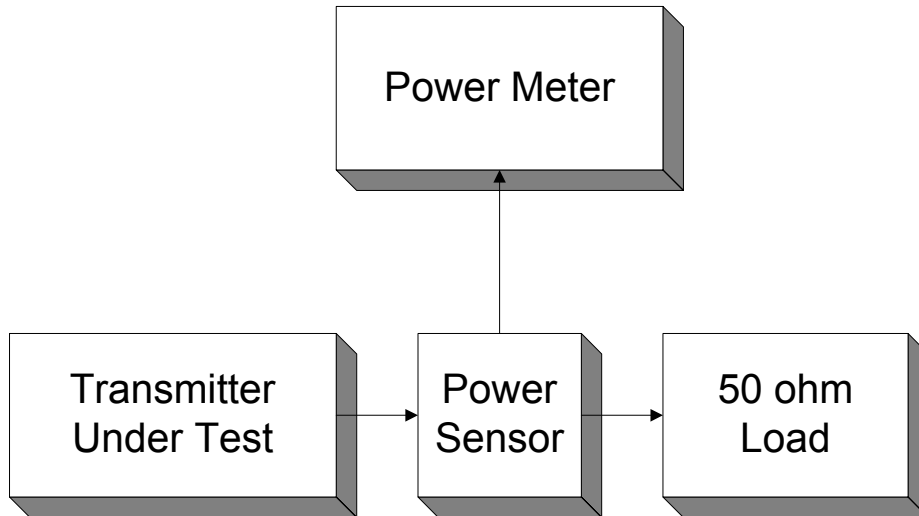

Para. No. 2.1047 - Audio Frequency Response

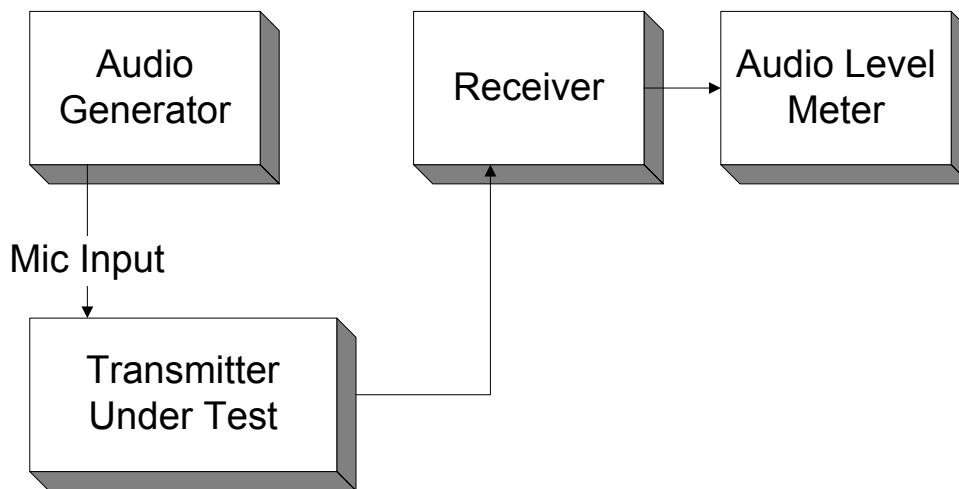

Para. No. 2.1047 - Modulation Limiting

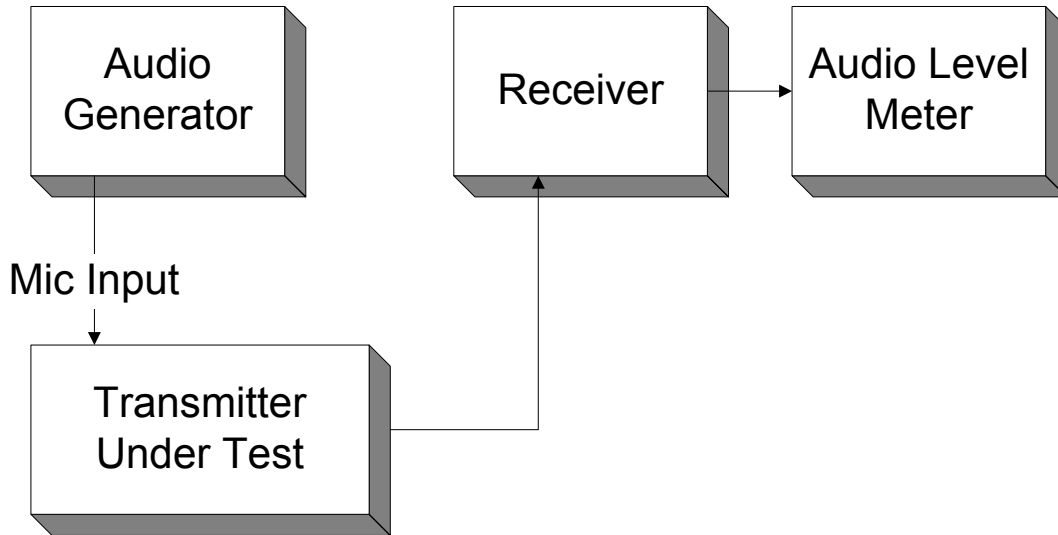

Para. No. 2.1049 - Occupied Bandwidth

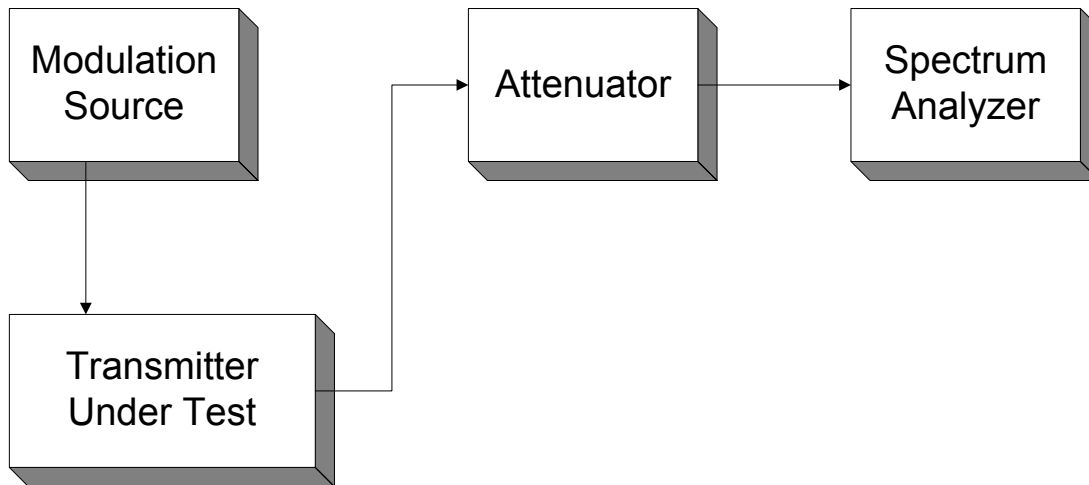

Para. No. 2.1051 - Spurious Emissions at Antenna Terminals

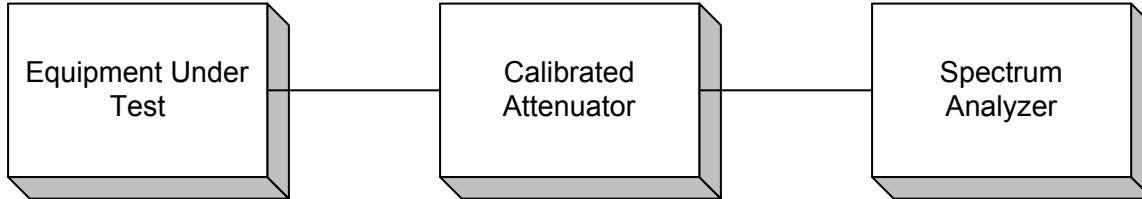

Para. No. 2.1053 - Field Strength of Spurious Radiation

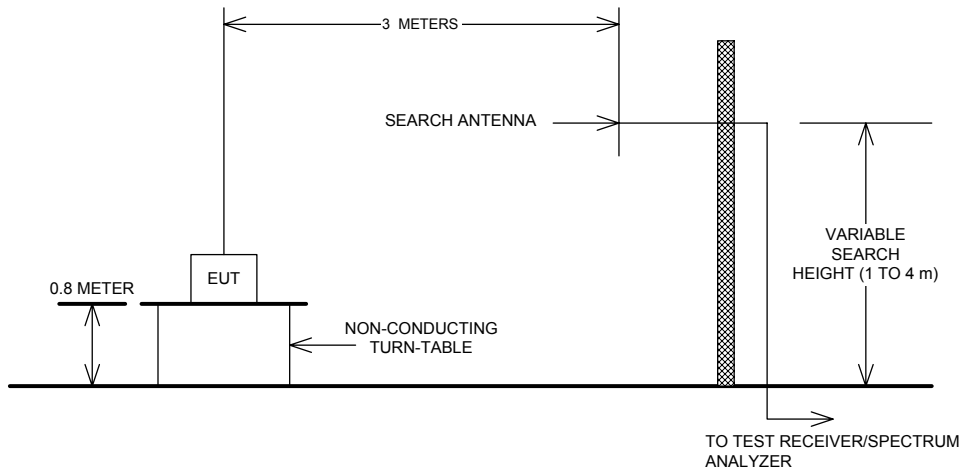

Para. No. 2.1055 - Frequency Stability

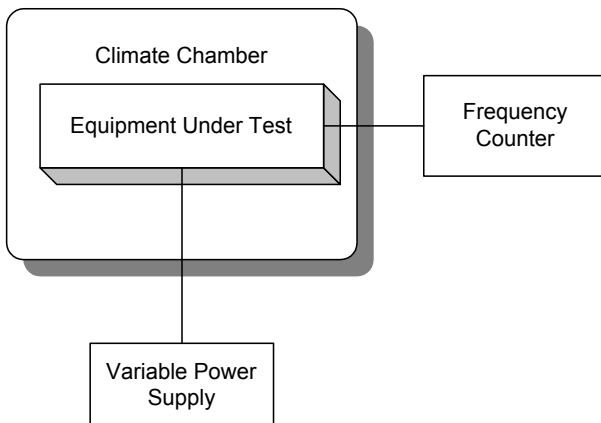

Para. No. 90.214 - Transient Frequency Behaviour

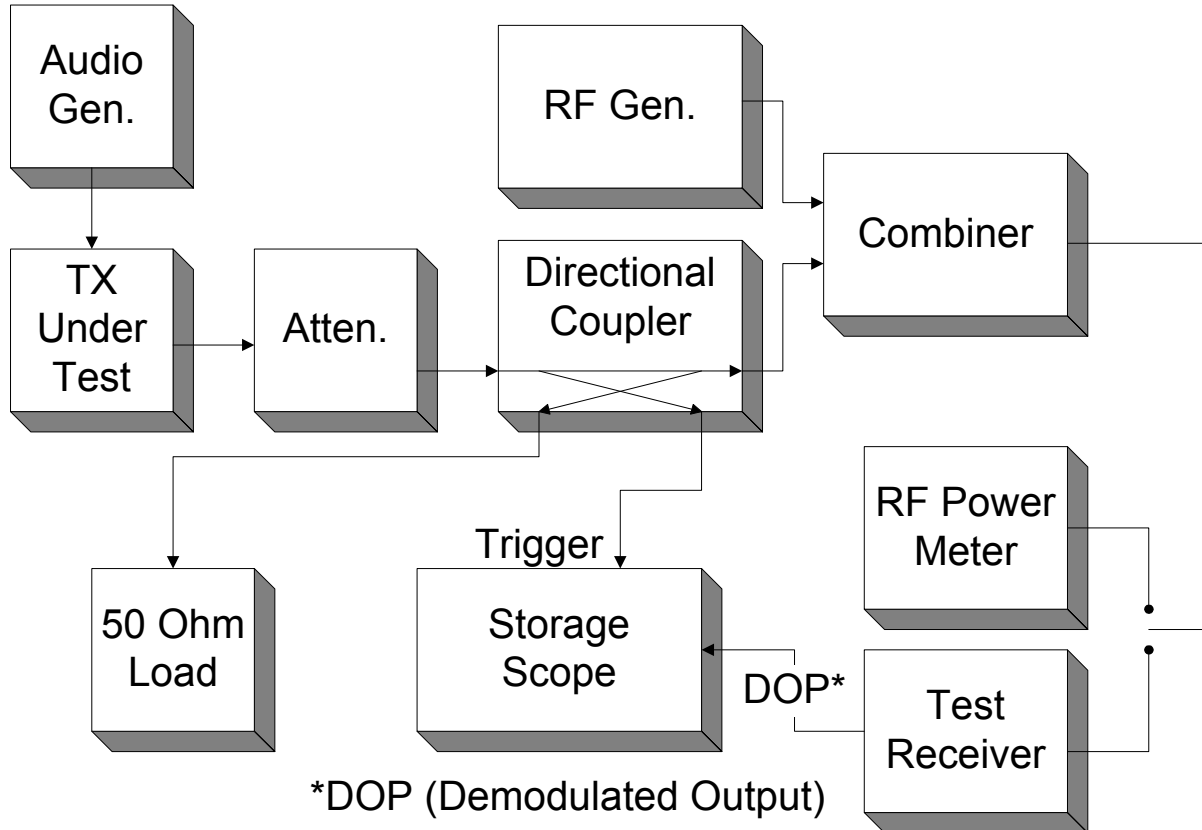

Voice

This measurement was made using measurement procedure TIA/EIA Land Mobile FM or PM Communications Equipment Measurement and Performance Standards TIA/EIA-603 February 1993 Telecommunications Industry Association (American National Standard ANSI/TIA/EIA-603-1992 Approved: October 27, 1992) Para. no. 2.2 Methods of Measurement for Transmitters Para. no. 2.2.19 Transient Frequency Behaviour (page no. 83).

Data

This measurement was made using measurement procedure TIA/EIA Digital C4FM/CQPSK Transceiver Measurement Methods TSB102.CAAA Para. no. 2.2.17 Transient Frequency Behaviour (page no. 74).

EQUIPMENT:VT-4D150 VHF Transmitter Family

Section 11. Test Equipment List

Equipment List - Radiated Emissions

CAL Cycle	Equipment	Manufacturer	Model No.	Asset/Serial No.	Last Cal.	Next Cal.
1 Year	Spectrum Analyzer	Hewlett-Packard	8565E	FA000981	July. 3/03	July. 3/04
1 Year	Biconical (1) Antenna	EMCO	3109	FA000805	April. 15/03	April. 15/04
1 Year	Horn Antenna #2	EMCO	3115	FA000825	Dec. 09/02	Dec. 09/03
1 Year	Log Periodic Antenna #2	EMCO	3148	FA001355	May. 09/03	May. 09/04
1 Year	1.0 – 2.0 GHz Amplifier	JCA	12-400	FA001498	June. 18/03	June. 18/04
1 Year	2.0 – 4.0 GHz Amplifier	JCA	24-600	FA001496	June. 18/03	June. 18/04
1 Year	4.0 – 8.0 GHz Amplifier	JCA	48-600	FA001497	June. 18/03	June. 18/04
COU	Notch Filter	K&L	3TNF	FA001666	COU	COU
1 Year	Pwr meter	HP	E4418B	FA001413	May 8/03	May 8/04
1 Year	Pwr Head	HP	8487A	FA001419	May 15/03	May 15/04
1 year	CMTA	R&S	54	FA001317	Oct. 23/03	Oct. 23/04

Note: N/A = Not Applicable, NCR = No Cal Required, COU = CAL On Use, OUT = Out For CAL/Repair