

FCC&IC Radio Test Report

FCC ID:H4IMS2063

IC:4491A-MS2063

This report concerns (check one): Original Grant Class II Change

Project No. : 1412040
Equipment : Wireless Mouse
Model Name : SM-2063
Applicant : LITE-ON TECHNOLOGY CORP.
Address For FCC : 16F, 392 , RueyKuang Road, Neihu, Taipei 11492,
Taiwan, R.O.C
Address For IC : 4F, 90, Chien 1 Rd. Chung-Ho, New Taipei City, ROC
23585, Taiwan

Date of Receipt : Dec. 04, 2014
Date of Test : Dec. 04, 2014 ~ Dec. 23, 2014
Issued Date : Dec. 26, 2014
Tested by : BTL Inc.

Testing Engineer : Rush Kao
(Rush Kao)

Technical Manager : Jeff Yang
(Jeff Yang)

Authorized Signatory : Andy Chiu
(Andy Chiu)

B T L I N C .

B1, No.37, Lane 365, Yang Guang St.,
Nei-Hu District, Taipei City 114, Taiwan.
TEL:+886-2-2657-3299 FAX: +886-2- 2657-3331

Declaration

BTL represents to the client that testing is done in accordance with standard procedures as applicable and that test instruments used has been calibrated with the standards traceable to National Measurement Laboratory (**NML**) of **R.O.C.**, or National Institute of Standards and Technology (**NIST**) of **U.S.A.**

BTL's reports apply only to the specific samples tested under conditions. It is manufacture's responsibility to ensure that additional production units of this model are manufactured with the identical electrical and mechanical components. **BTL** shall have no liability for any declarations, inferences or generalizations drawn by the client or others from **BTL** issued reports.

BTL's reports must not be used by the client to claim product endorsement by the authorities or any agency of the Government.

This report is the confidential property of the client. As a mutual protection to the clients, the public and **BTL-self**, extracts from the test report shall not be reproduced except in full with **BTL's** authorized written approval.

BTL's laboratory quality assurance procedures are in compliance with the **ISO Guide17025** requirements, and accredited by the conformity assessment authorities listed in this test report.

Limitation

For the use of the authority's logo is limited unless the Test Standard(s)/Scope(s)/Item(s) mentioned in this test report is (are) included in the conformity assessment authorities acceptance respective.

Table of Contents	Page
1 . CERTIFICATION	6
2 . SUMMARY OF TEST RESULTS	7
2.1 TEST FACILITY	8
2.2 MEASUREMENT UNCERTAINTY	8
3 .GENERAL INFORMATION	9
3.1 GENERAL DESCRIPTION OF EUT	9
3.2 DESCRIPTION OF TEST MODES	11
3.3 BLOCKDIAGRAMSHOWINGTHECONFIGURATIONOFSYSTEMTESTED	12
3.4 DESCRIPTION OF SUPPORT UNITS	12
4 .EMC EMISSION TEST	13
4.1 CONDUCTED EMISSION MEASUREMENT	13
4.1.1 POWER LINE CONDUCTED EMISSION	13
4.1.2 TESTPROCEDURE	13
4.1.3 DEVIATIONFROMTESTSTANDARD	13
4.1.4 TESTSETUP	14
4.1.5 EUT OPERATING CONDITIONS	14
4.1.6 EUT TEST CONDITIONS	14
4.1.7 TEST RESULTS	14
4.2 RADIATED EMISSION MEASUREMENT	15
4.2.1 RADIATED EMISSION LIMITS	15
4.2.2 TESTPROCEDURE	16
4.2.3 DEVIATIONFROMTESTSTANDARD	16
4.2.4 TESTSETUP	17
4.2.5 EUT OPERATING CONDITIONS	18
4.2.6 EUT TEST CONDITIONS	18
4.2.7 TEST RESULTS (9KHZ TO 30MHZ)	18
4.2.8 TEST RESULTS (30MHZ TO 1000MHZ)	18
4.2.9 TEST RESULTS(ABOVE1000 MHZ)	19
5 .BANDWIDTH TEST	20
5.1 TEST PROCEDURE	20
5.2 DEVIATION FROM STANDARD	20
5.3 TEST SETUP	20
5.4 EUT OPERATION CONDITIONS	20
5.5 EUT TEST CONDITIONS	20
5.6 TEST RESULTS	20
6 .ANTENNA CONDUCTED SPURIOUS EMISSION	21
6.1 APPLIED PROCEDURES / LIMIT	21

Table of Contents	Page
6.2 TEST PROCEDURE	21
6.3 DEVIATION FROM STANDARD	21
6.4 TEST SETUP	21
6.5EUT OPERATION CONDITIONS	22
6.6 EUT TEST CONDITIONS	22
6.7 TEST RESULTS	22
7 .MEASUREMENT INSTRUMENTS LIST AND SETTING	23
8 .EUT TEST PHOTO	24
ATTACHMENT A - CONDUCTED EMISSION	27
ATTACHMENTB -RADIATED EMISSION (9KHZ TO 30MHZ)	28
ATTACHMENT C -RADIATED EMISSION (30MHZ TO 1000MHZ)	30
ATTACHMENTD -RADIATED EMISSION (ABOVE 1000MHZ)	33
ATTACHMENT E - BANDWIDTH	46
ATTACHMENT F - ANTENNA CONDUCTED SPURIOUS EMISSION	49

REPORT ISSUED HISTORY

Issued No.	Description	Issued Date
BTL-FICP-1-1412040	Original Issue.	Dec. 26, 2014

1. CERTIFICATION

Equipment : Wireless Mouse
Brand Name : HP
Model Name : SM-2063
Applicant : LITE-ON TECHNOLOGY CORP.
Date of Test : Dec. 04, 2014 ~ Dec. 23, 2014
Test Sample : Engineering Sample
Standard(s) : FCC Part15, Subpart C: 2013(15.249)/ ANSI C63.4-2009
Canada RSS-210:2010
RSS-GEN Issue 4, November 2014

The above equipment has been tested and found compliance with the requirement of the relative standards by BTL Inc.

The test data, data evaluation, and equipment configuration contained in our test report (Ref No. BTL-FICP-1-1412040) were obtained utilizing the test procedures, test instruments, test sites that has been accredited by the Authority of TAF according to the ISO-17025 quality assessment standard and technical standard(s).

2. SUMMARY OF TEST RESULTS

Test procedures according to the technical standard(s):

FCC Part15, Subpart C: 2013 (15.249)/ Canada RSS-210:2010 RSS-GEN Issue 4, November 2014				
StandardSection		Test Item	Judgment	Remark
FCC	IC			
15.207	RSS-GEN Issue 4, November 20148.8	Conducted Emission	N/A	
15.209 15.249	RSS-210, Issue 8, Annex 8, Section 8.5	Radiated Spurious Emission	PASS	

NOTE:

(1) "N/A" denotes test is not applicable in this test report.

2.1 TEST FACILITY

Conducted emission Test:

C02: (VCCI RN: C-3477; FCC RN: 614388; FCC DN: TW1054)
1F., No. 61, Ln. 77, Sing-ai Rd., Neihu Dist., Taipei City 114, Taiwan (R.O.C.)

Radiated emission Test (Below 1 GHz):

CB08: (FCC RN: 614388; FCC DN: TW1054; IC Assigned Code: 4428C-1)
1F., No. 61, Ln. 77, Sing-ai Rd., Neihu Dist., Taipei City 114, Taiwan (R.O.C.)

Radiated emission Test (Above 1 GHz):

CB08: (VCCI RN: G-91; FCC RN: 614388; FCC DN: TW1054; IC Assigned Code: 4428C-1)
1F., No. 61, Ln. 77, Sing-ai Rd., Neihu Dist., Taipei City 114, Taiwan (R.O.C.)

BTL's test firm number for FCC: 319330

2.2 MEASUREMENT UNCERTAINTY

The measurement uncertainty is not specified by FCC rules and for reference only.

The reported uncertainty of measurement $y \pm U$, where expanded uncertainty U is based on a standard uncertainty multiplied by a coverage factor of $k=2$, providing a level of confidence of approximately **95%**.

The measurement instrumentation uncertainty considerations contained in CISPR 16-4-2.

A. Conducted emission test:

Test Site	Measurement Frequency Range	U, (dB)	NOTE
C02	150 kHz ~ 30 MHz	1.94	

B. Radiated emission test:

Test Site	Item	Measurement Frequency Range	Uncertainty	NOTE	
CB08	Radiated emission at 3m	Horizontal Polarization	30 - 200MHz	3.35 dB	
			200 - 1000MHz	3.11 dB	
			1 - 18GHz	3.97 dB	
			18 - 40GHz	4.01 dB	
		Vertical Polarization	30 - 200MHz	3.22 dB	
			200 - 1000MHz	3.24 dB	
			1 - 18GHz	4.05 dB	
			18 - 40GHz	4.04 dB	

Our calculated Measurement Instrumentation Uncertainty is shown in the tables above. These are our U_{lab} values in CISPR 16-4-2 terminology.

Since Table 1 of CISPR 16-4-2 has values of measurement instrumentation uncertainty, called U_{CISPR} , as follows:

Conducted Disturbance (mains port) – 150 kHz – 30 MHz : 3.6 dB

Radiated Disturbance (electric field strength on an open area test site or alternative test site) – 30 MHz – 1000 MHz : 5.2 dB

It can be seen that our U_{lab} values are smaller than U_{CISPR} .

3.GENERAL INFORMATION

3.1 GENERAL DESCRIPTION OF EUT

Equipment	Wireless Mouse	
Brand Name	HP	
Model Name	SM-2063	
Model Difference	N/A	
Product Description	Operation Frequency	2403~2480 MHz
	Modulation Technology	GFSK(2Mbps)
	Data rate	
	Field Strength	100.05dBuV/m(peak Max)
PowerSource	Supplied from 2*AA Battery.	
Power Rating	DC 3V	

Note:

1. For a more detailed features description, please refer to the manufacturer's specifications or the User's Manual.

2.

Channel List:

Channel	Frequency (MHz)	Channel	Frequency (MHz)	Channel	Frequency (MHz)
01	2403	27	2429	53	2455
02	2404	28	2430	54	2456
03	2405	29	2431	55	2457
04	2406	30	2432	56	2458
05	2407	31	2433	57	2459
06	2408	32	2434	58	2460
07	2409	33	2435	59	2461
08	2410	34	2436	60	2462
09	2411	35	2437	61	2463
10	2412	36	2438	62	2464
11	2413	37	2439	63	2465
12	2414	38	2440	64	2466
13	2415	39	2441	65	2467
14	2416	40	2442	66	2468
15	2417	41	2443	67	2469
16	2418	42	2444	68	2470
17	2419	43	2445	69	2471
18	2420	44	2446	70	2472
19	2421	45	2447	71	2473
20	2422	46	2448	72	2474
21	2423	47	2449	73	2475
22	2424	48	2450	74	2476
23	2425	49	2451	75	2477
24	2426	50	2452	76	2478
25	2427	51	2453	77	2479
26	2428	52	2454	78	2480

3. Table for Filed Antenna

Ant.	Brand	Model Name	Antenna Type	Connector	Gain (dBi)	Note
1	N/A	N/A	Printed	N/A	-2.42	

3.2 DESCRIPTION OF TEST MODES

To investigate the maximum EMI emission characteristics generated from EUT, the test system was pre-scanning tested based on the consideration of following EUT operation mode or test configuration mode which possible have effect on EMI emission level. Each of these EUT operation mode(s) or test configuration mode(s) mentioned above was evaluated respectively.

Pretest Mode	Description
Mode 1	TX Low Channel
Mode 2	TX Middle Channel
Mode 3	TX High Channel

For Radiated Test	
Final Test Mode	Description
Mode 1	TX Low Channel
Mode 2	TX Middle Channel
Mode 3	TX High Channel

Note:

(1) The measurements are performed at the high, middle, low available channels.

3.3 BLOCK DIAGRAM SHOWING THE CONFIGURATION OF SYSTEM TESTED

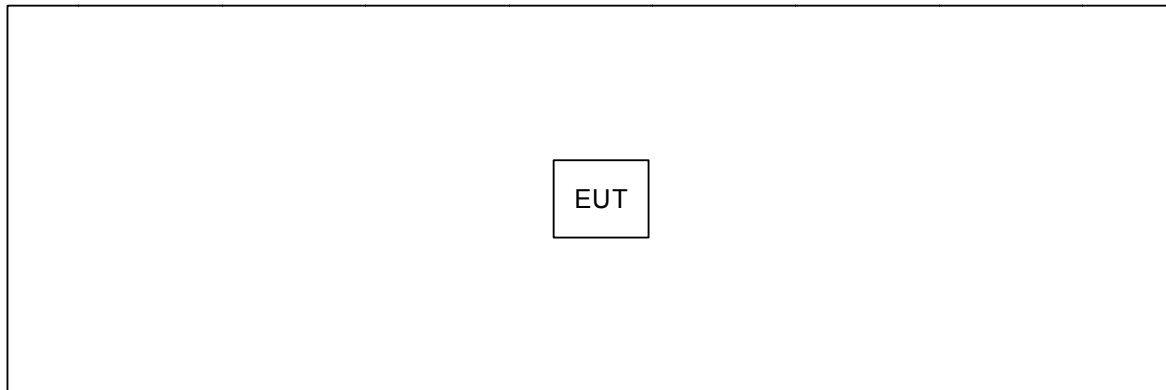

3.4 DESCRIPTION OF SUPPORT UNITS

The EUT has been tested as an independent unit together with other necessary accessories or support units. The following support units or accessories were used to form a representative test configuration during the tests.

Item	Equipment	Mfr/Brand	Model/Type No.	FCC ID	Series No.	Note
-	-	-	-	-	-	

Item	Shielded Type	Ferrite Core	Length	Note
-	-	-	-	

4. EMC EMISSION TEST

4.1 CONDUCTED EMISSION MEASUREMENT

4.1.1 POWER LINE CONDUCTED EMISSION (FREQUENCY RANGE 150KHZ-30MHZ)

Frequency of Emission (MHz)	Conducted Limit (dB μ V)	
	Quasi-peak	Average
0.15 -0.5	66 to 56*	56 to 46*
0.50 -5.0	56	46
5.0 -30.0	60	50

Note:

- (1) The limit of " * " decreases with the logarithm of the frequency

The following table is the setting of the receiver

Receiver Parameters	Setting
Attenuation	10 dB
Start Frequency	0.15 MHz
Stop Frequency	30 MHz
IF Bandwidth	9 kHz

4.1.2 TESTPROCEDURE

- The EUT was placed 0.8 meters from the horizontal ground plane with EUT being connected to the power mains through a line impedance stabilization network (LISN). All other support equipments powered from additional LISN(s). The LISN provide 50 Ohm/ 50uH of coupling impedance for the measuring instrument.
- Interconnecting cables that hang closer than 40 cm to the groundplane shall be folded back and forth in the center forming a bundle 30 to 40 cm long.
- I/O cables that are not connected to a peripheral shall be bundled in the center. The end of the cable may be terminated, if required, using the correct terminating impedance. The overall length shall not exceed 1 m.
- LISN at least 80 cm from nearest part of EUT chassis.
- For the actual test configuration, please refer to the related Item –EUT Test Photos.

4.1.3 DEVIATION FROM TEST STANDARD

No deviation

4.1.4 TESTSETUP

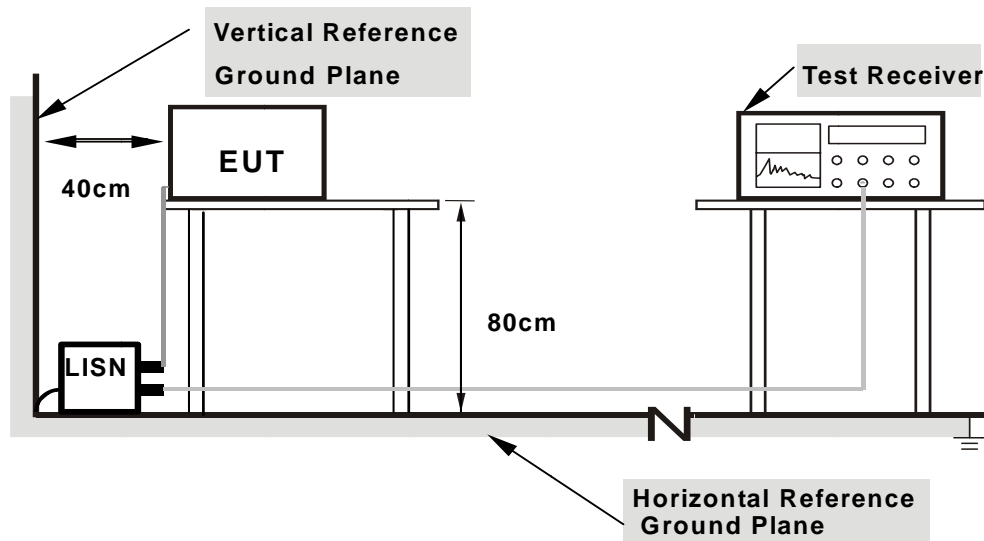

Note: 1.Support units were connected to second LISN.

2.Both of LISNs (AMN) are 80 cm from EUT and at least 80 from other units and other metal planes

4.1.5EUT OPERATING CONDITIONS

The EUT was configured for testing in a typical fashion (as a customer would normally use it).The EUT has been programmed to continuously transmit during test. This operating condition was tested and used to collect the included data.

The EUT was programmed to be in continuously transmitting mode.

4.1.6EUT TEST CONDITIONS

Temperature: 25°C

Relative Humidity: 55%

Test Voltage: DC 3V

4.1.7 TEST RESULTS

Please refer to the Attachment A.

Remark:

- (1) All readings are QP Mode value unless otherwise stated AVG in column of Note. If the QP Mode Measured value compliance with the QP Limits and lower than AVG Limits,the EUT shall be deemed to meet both QP & AVG Limits and then only QP Mode was measured, but AVG Mode didn't perform in this case, a "*" marked in AVG Mode column of Interference Voltage Measured.
- (2) Measuring frequency range from 150KHz to 30MHz.

4.2 RADIATED EMISSION MEASUREMENT

4.2.1 RADIATED EMISSION LIMITS (FCC 15.209)

Frequencies (MHz)	Field Strength (micorvolts/meter)	Measurement Distance (meters)
0.009~0.490	2400/F(KHz)	300
0.490~1.705	24000/F(KHz)	30
1.705~30.0	30	30
30~88	100	3
88~216	150	3
216~960	200	3
960~1000	500	3

Harmonic emissions limits comply with below 54dBuV/m at 3m. Other emissions radiated outside of the specified frequency bands, except for harmonics, shall be attenuated by at least 50 dB below the level of the fundamental or comply with the radiated emissions limits specified in section 15.209(a) limit in the table below has to be followed.

Note:

- (1) The tighter limit applies at the band edges.
- (2) Emission level (dBuV/m)=20log Emission level (uV/m).

LIMITS OF RADIATED EMISSION MEASUREMENT (FCC 15.209)

FREQUENCY (MHz)	(dBuV/m) (at 3m)	
	PEAK	AVERAGE
Above 1000	74	54

Notes:

- (1) The limit for radiated test was performed according to FCC PART 15C.
- (2) The tighter limit applies at the band edges.
- (3) Emission level (dBuV/m)=20log Emission level (uV/m).

LIMITS OF RADIATED EMISSION MEASUREMENT (FCC Part 15.249)

FCC Part 15 (15.249), Subpart C	
Limit	Frequency Range(MHz)
Field strength of fundamental 50000 μ V/m (94 dB μ V/m) @ 3 m	2400-2483.5
Field strength of harmonics 500 μ V/m (54 dB μ V/m) @ 3 m	Above 2483.5

Spectrum Parameter	Setting
Attenuation	Auto
Start Frequency	1000 MHz
Stop Frequency	10th carrier harmonic

Receiver Parameter	Setting
Attenuation	Auto
Start ~ Stop Frequency	9kHz~90kHz for PK/AVG detector
Start ~ Stop Frequency	90kHz~110kHz for QP detector
Start ~ Stop Frequency	110kHz~490kHz for PK/AVG detector
Start ~ Stop Frequency	490kHz~30MHz for QP detector
Start ~ Stop Frequency	30MHz~1000MHz for QP detector

4.2.2 TESTPROCEDURE

- a. The EUT was placed on the top of a rotating table 0.8 meters above the ground at a 3 meter semi-anechoic chamber. The table was rotated 360 degrees to determine the position of the highest radiation.(below 1GHz)
- b. The EUT was placed on the top of a rotating table 0.8 meters above the ground at a 3 meter semi-anechoic chamber. The table was rotated 360 degrees to determine the position of the highest radiation.(above 1GHz)
- c. The height of the equipment or of the substitution antenna shall be 0.8 m; the height of the test antenna shall vary between 1 m to 4 m. Both horizontal and vertical polarizations of the antenna are set to make the measurement.
- d. The initial step in collecting conducted emission data is a spectrum analyzer peak detector mode pre-scanning the measurement frequency range. Significant peaks are then marked and then AV detector mode re-measured.
- e. If the Peak Mode measured value compliance with and lower than Quasi Peak Mode Limit, the EUT shall be deemed to meet QP Limits and then no additional QP Mode measurement performed.
- f. For the actual test configuration, please refer to the related Item –EUT Test Photos.

4.2.3 DEVIATION FROM TEST STANDARD

No deviation

4.2.4 TESTSETUP

(A) Radiated Emission Test Set-Up Frequency Below 1 GHz

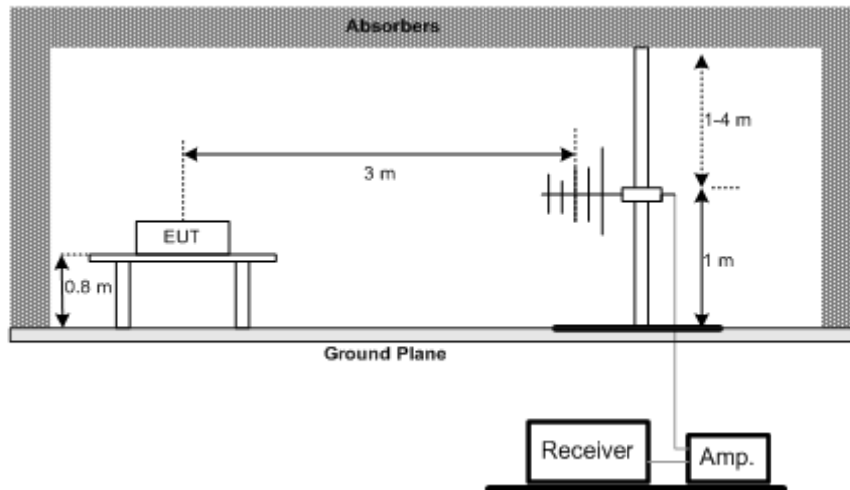

(B) Radiated Emission Test Set-Up Frequency Above 1 GHz

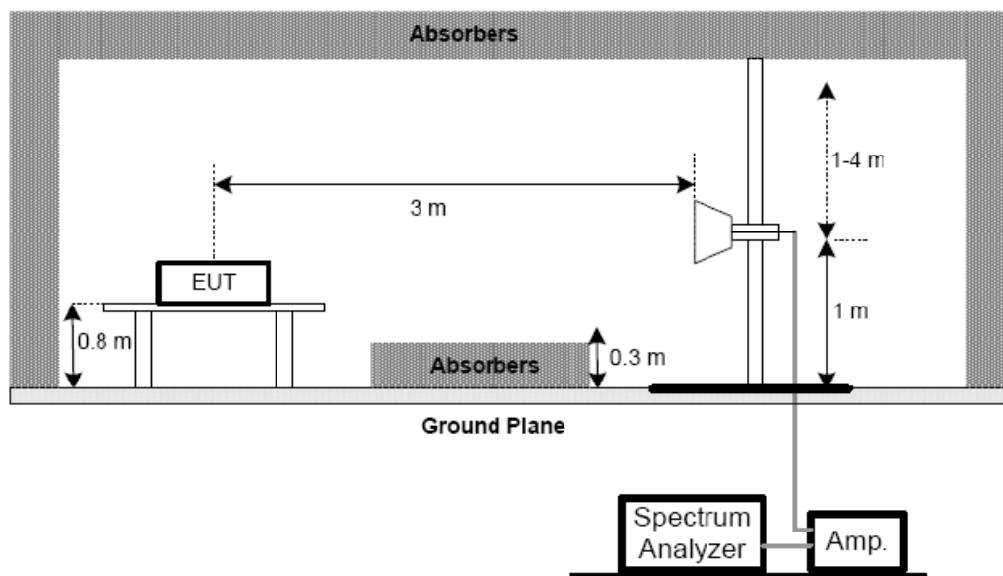

(C) For radiated emissions below 30MHz

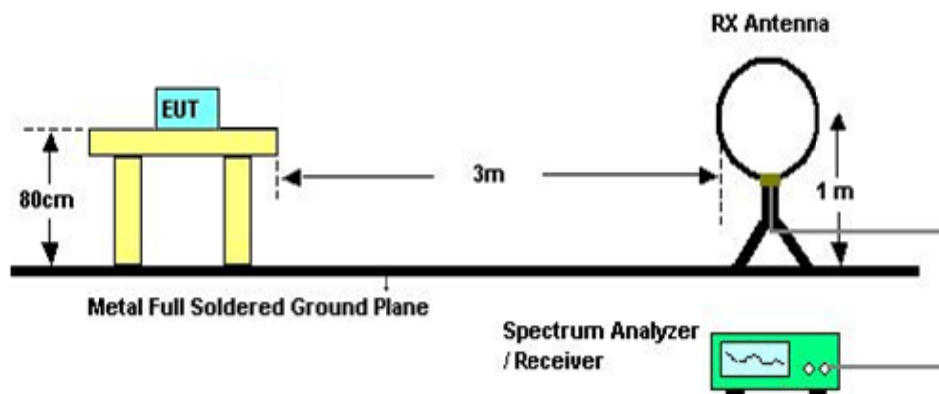

4.2.5 EUT OPERATING CONDITIONS

The EUT tested system was configured as the statements of 4.1.6 Unless otherwise a special operating condition is specified in the follows during the testing.

4.2.6 EUT TEST CONDITIONS

Temperature: 25°C

Relative Humidity: 55%

Test Voltage: DC 3V

4.2.7 TEST RESULTS (9KHZ TO 30MHZ)

Please refer to the Attachment B

Remark:

- (1) The amplitude of spurious emissions which are attenuated by more than 20 dB below the permissible value has no need to be reported.
- (2) Distance extrapolation factor = $40 \log(\text{specific distance} / \text{test distance})$ (dB).
- (3) Limit line = specific limits (dBuV) + distance extrapolation factor.

4.2.8 TEST RESULTS (30MHZ TO 1000MHZ)

Please refer to the Attachment C

Remark :

- (1) All readings are Peak unless otherwise stated QP in column of 『Note』 . Peak denotes that the Peak reading compliance with the QP Limits and then QP Mode measurement didn't perform.
- (2) Measuring frequency range from 30MHz to 1000MHz or the 10th harmonic of highest fundamental frequency. "F" denotes fundamental frequency; "H" denotes spurious frequency. "E" denotes band edge frequency.
- (3) Radiated emissions measured in frequency range from 30 MHz to 1000 MHz were made with an instrument using Peak detector mode or QP detector mode of the emission .

4.2.9 TEST RESULTS(ABOVE1000 MHZ)

Please refer to the Attachment D

Remark :

- (1) All readings are Peak unless otherwise stated QP in column of 『Note』 . Peak denotes that the Peak reading compliance with the QP Limits and then QP Mode measurement didn't perform.
- (2) Radiated emissions measured in frequency range above 1000MHz were made with an instrument using Peak detector mode and AV detector mode of the emission .
- (3) Data of measurement within this frequency range shown “ * ” in the table above means the reading of emissions are attenuated more than 20dB below the permissible limits or the field strength is too small to be measured.
- (4) A preamp and high pass filter were used for this test in order to provide sufficient measurement sensitivity.
- (5) EUT Orthogonal Axis :
“X” - denotes Laid on Table ; “Y” - denotes Vertical Stand ; “Z” - denotes Side Stand
- (6) During the measurements above 1 GHz it is taken care of that the EUT is always within the 3 dB cone of radiation BW of the used antenna
- (7) No limit: This is fundamental signal, the judgment is not applicable.
For fundamental signal judgment was referred to Peak output test.

5. BANDWIDTH TEST

5.1 TEST PROCEDURE

- a. The EUT was directly connected to the spectrum analyzer and antenna output port as show in the block diagram below,
- b. Spectrum Setting: RBW= 100KHz, VBW=100KHz, Sweep time = Auto.

5.2 DEVIATION FROM STANDARD

No deviation.

5.3 TEST SETUP



5.4 EUT OPERATION CONDITIONS

The EUT tested system was configured as the statements of 4.1.6 Unless otherwise a special operating condition is specified in the follows during the testing.

5.5 EUT TEST CONDITIONS

Temperature: 25°C
Relative Humidity: 55%
Test Voltage: DC 3V

5.6 TEST RESULTS

Please refer to the Attachment E

6. ANTENNA CONDUCTED SPURIOUS EMISSION

6.1 APPLIED PROCEDURES / LIMIT

In any 100 kHz bandwidth outside the frequency band in which the spread spectrum originally modulated intentional radiator is operating, the radio frequency power that is produced by the intentional radiator shall be at least 20 dB below that in the 100 kHz bandwidth within the band that contains the highest level of the desired power, based on either an RF conducted measurement, provided the transmitter demonstrates compliance with the peak conducted power limits.

6.2 TEST PROCEDURE

- a. The EUT was directly connected to the spectrum analyzer and antenna output port as show in the block diagram below,
- b. Spectrum Setting: RBW= 100KHz, VBW=100KHz, Sweep time = 10 ms.

6.3 DEVIATION FROM STANDARD

No deviation.

6.4 TEST SETUP



6.5 EUT OPERATION CONDITIONS

The EUT tested system was configured as the statements of 4.1.6 Unless otherwise a special operating condition is specified in the follows during the testing.

6.6 EUT TEST CONDITIONS

Temperature: 25°C

Relative Humidity: 55%

Test Voltage: DC 3V

6.7 TEST RESULTS

Please refer to the Attachment F

7.MEASUREMENT INSTRUMENTS LIST AND SETTING

Radiated Emission Measurement					
Item	Kind of Equipment	Manufacturer	Type No.	Serial No.	Calibrated until
1	Spectrum Analyzer	R&S	FSP-30	100854	Oct. 26, 2015
2	Horn Antenna	Schwarzbeck	BBHA 9120	D-325	Jun. 14, 2015
3	Microwave Pre amplifier	Agilent	8449B	3008A01714	Apr. 15, 2015
4	Microflex Cable	Harbour industries	27478LL142	1m	May. 12, 2015
5	Microflex Cable	EMC	S104-SMA	8m	May. 14, 2015
6	Microflex Cable	Harbour industries	27478LL142	3m	May. 12, 2015
7	Test Cable	LMR	LMR-400	12m	May. 13, 2015
8	Test Cable	LMR	LMR-400	3m	May. 13, 2015
9	Pre-Amplifier	Anritsu	MH648A	M92649	Jun. 17, 2015
10	Log-Bicon Antenna	Schwarzbeck	VULB9168-352	9168-352	July. 10, 2015

Bandwidth					
Item	Kind of Equipment	Manufacturer	Type No.	Serial No.	Calibrated until
1	Spectrum Analyzer	R&S	FSP-30	100854	Oct. 26, 2015

Antenna Conducted Spurious Emission					
Item	Kind of Equipment	Manufacturer	Type No.	Serial No.	Calibrated until
1	Spectrum Analyzer	R&S	FSP-30	100854	Oct. 26, 2015

Remark: "N/A" denotes no model name, serial no. or calibration specified.
All calibration period of equipment list is one year.

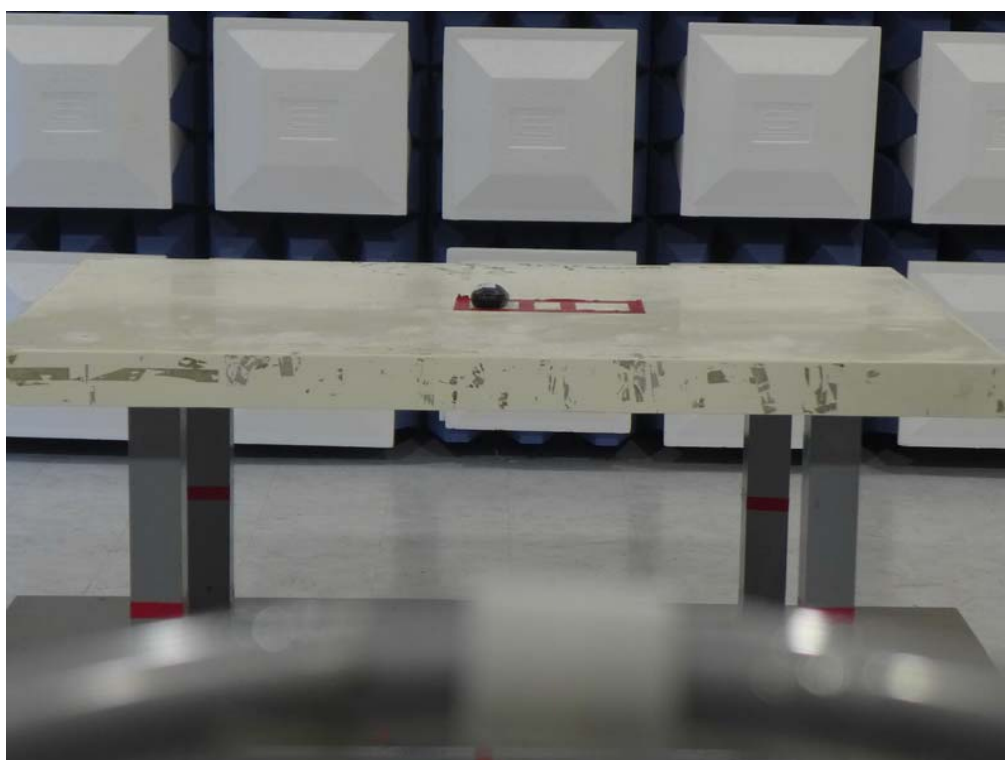
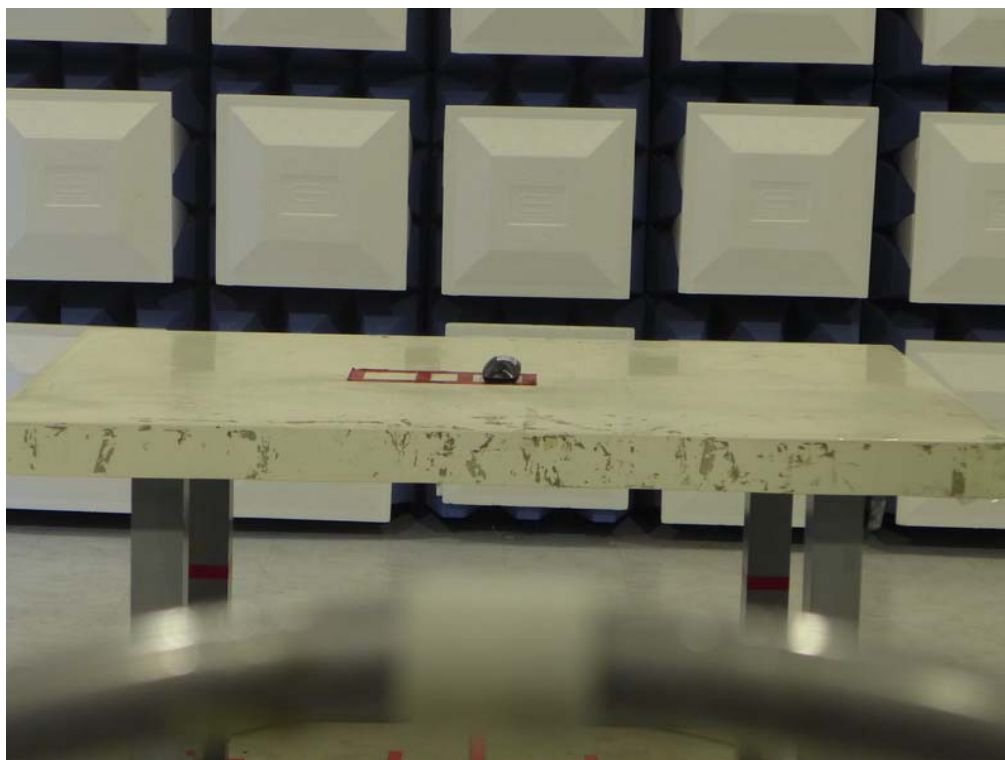
8.EUT TEST PHOTO**Radiated Measurement Photos
9KHz to 30MHz**

Radiated Measurement Photos

30MHz to 1000MHz

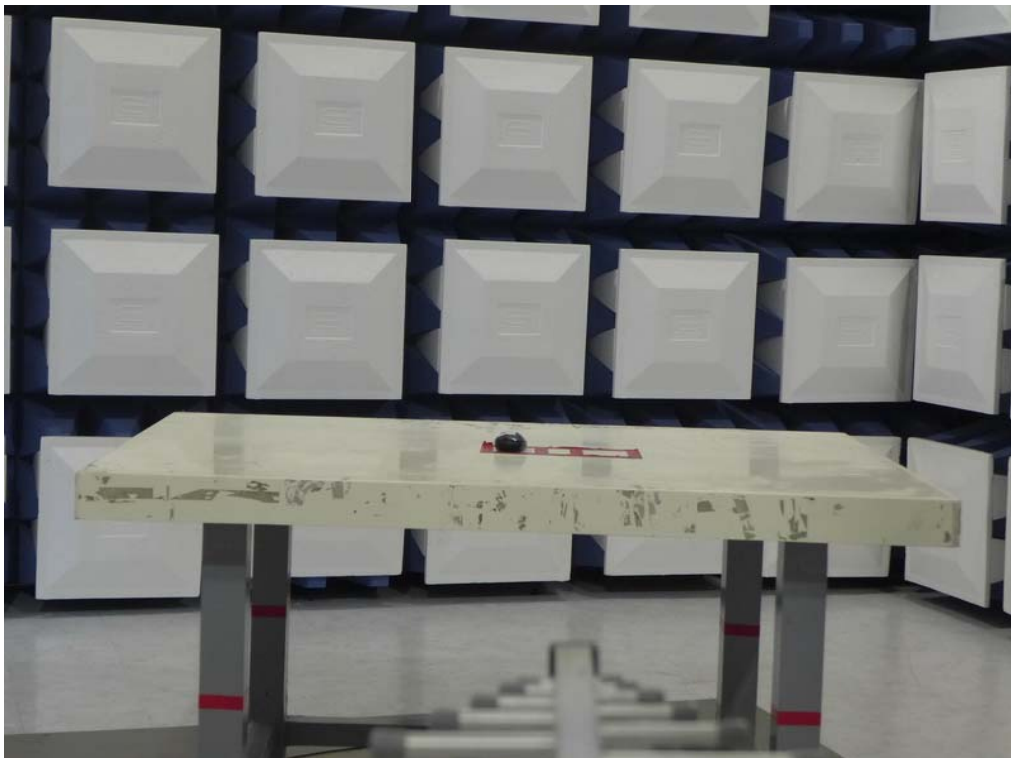

Radiated Measurement Photos

Above 1000MHz



ATTACHMENT A - CONDUCTED EMISSION

Test Mode: N/A

Note: "N/A" denotes test is not applicable to this device.

ATTACHMENTB -RADIATED EMISSION (9KHZ TO 30MHZ)

Test Mode:	TX Middle Channel
------------	-------------------

Freq. (MHz)	Ant. 0°/90°	Reading(RA) (dBuV)	Corr.Factor(CF) (dB)	Measured(FS) (dBuV/m)	Limits(QP) (dBuV/m)	Margin (dB)	Note
0.0130	0°	44.64	22.33	66.97	125.33	-58.36	PEAK
0.0130	0°	31.43	22.33	53.76	125.33	-71.57	AV
0.0257	0°	42.14	22.01	64.15	119.41	-55.26	PEAK
0.0257	0°	28.37	22.01	50.38	119.41	-69.03	AV
0.0395	0°	34.97	21.66	56.63	115.67	-59.04	PEAK
0.0395	0°	24.59	21.66	46.25	115.67	-69.42	AV
0.0626	0°	35.37	21.20	56.57	111.67	-55.10	PEAK
0.0626	0°	24.19	21.20	45.39	111.67	-66.28	AV
0.2561	0°	34.59	20.44	55.03	99.44	-44.40	PEAK
0.2561	0°	22.87	20.44	43.31	99.44	-56.12	AV
1.3200	0°	37.51	20.28	57.79	65.19	-7.40	QP

Freq. (MHz)	Ant. 0°/90°	Reading(RA) (dBuV)	Corr.Factor(CF) (dB)	Measured(FS) (dBuV/m)	Limits(QP) (dBuV/m)	Margin (dB)	Note
0.0141	90°	45.54	22.30	67.84	124.62	-56.78	PEAK
0.0141	90°	32.28	22.30	54.58	124.62	-70.04	AV
0.0251	90°	43.41	22.02	65.43	119.61	-54.18	PEAK
0.0251	90°	31.61	22.02	53.63	119.61	-65.98	AV
0.0392	90°	33.84	21.67	55.51	115.74	-60.23	PEAK
0.0392	90°	22.75	21.67	44.42	115.74	-71.32	AV
0.0623	90°	36.66	21.20	57.86	111.71	-53.85	PEAK
0.0623	90°	22.54	21.20	43.74	111.71	-67.97	AV
0.2684	90°	32.51	20.43	52.94	99.03	-46.09	PEAK
0.2684	90°	22.38	20.43	42.81	99.03	-56.22	AV
1.2450	90°	38.42	20.36	58.78	65.70	-6.93	QP

ATTACHMENT C -RADIATED EMISSION (30MHZ TO 1000MHZ)

Test Mode: TX Middle Channel

Vertical

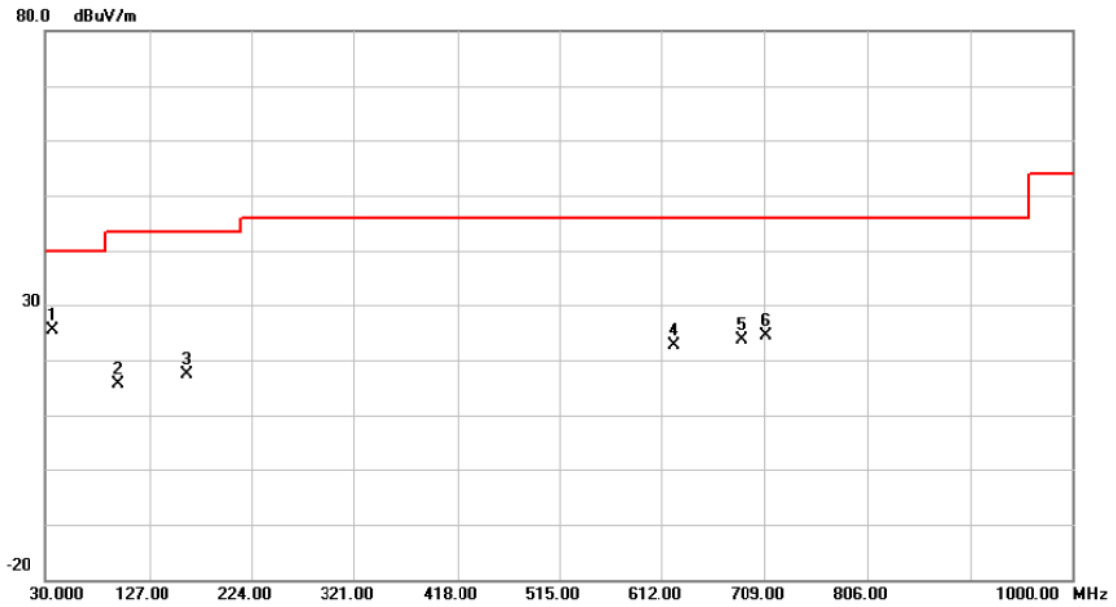

No.	Mk.	Freq. MHz	Reading Level dBuV	Correct Factor dB	Measure- ment dBuV/m	Limit dBuV/m	Over dB	Detector	Comment
1	*	37.2750	40.06	-14.71	25.35	40.00	-14.65	peak	
2		97.9000	34.73	-19.14	15.59	43.50	-27.91	peak	
3		163.3750	31.41	-14.09	17.32	43.50	-26.18	peak	
4		624.1250	29.72	-7.19	22.53	46.00	-23.47	peak	
5		687.1750	29.34	-5.80	23.54	46.00	-22.46	peak	
6		711.4250	29.68	-5.32	24.36	46.00	-21.64	peak	

Test Mode: TX Middle Channel

Horizontal

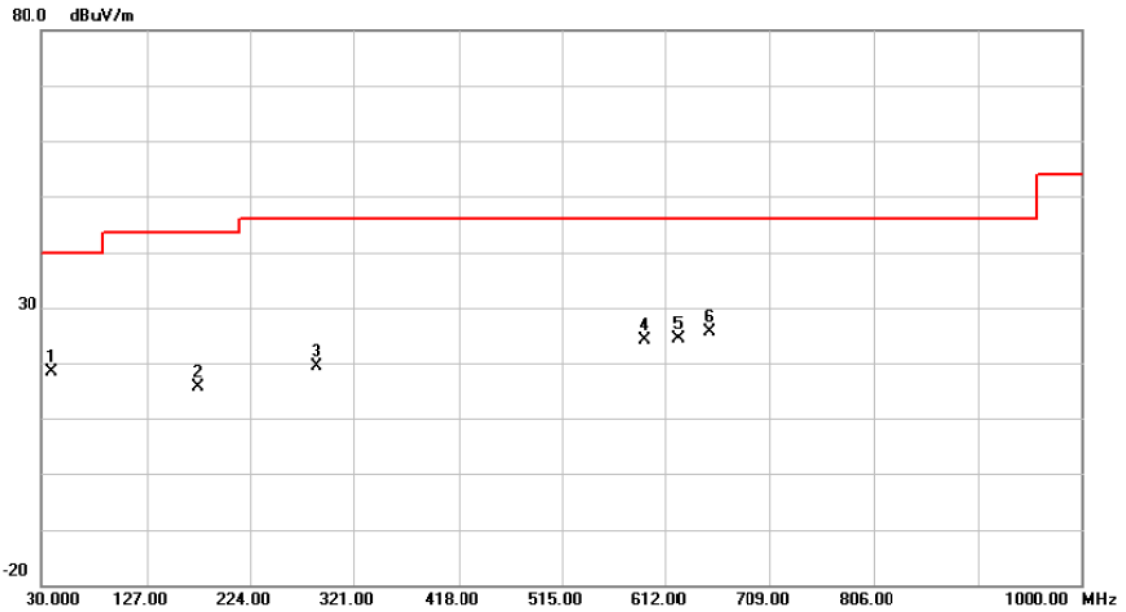

No.	Mk.	Freq.	Reading Level	Correct Factor	Measurement	Limit	Over	Detector	Comment
		MHz	dBuV	dB	dBuV/m	dBuV/m	dB		
1	X	39.7000	32.62	-14.25	18.37	40.00	-21.63	peak	
2	X	175.5000	30.71	-14.97	15.74	43.50	-27.76	peak	
3	X	287.0500	33.03	-13.77	19.26	46.00	-26.74	peak	
4	X	592.6000	31.61	-7.54	24.07	46.00	-21.93	peak	
5	X	624.1250	31.62	-7.19	24.43	46.00	-21.57	peak	
6	X	653.2250	32.54	-6.81	25.73	46.00	-20.27	peak	

ATTACHMENTD -RADIATED EMISSION (ABOVE 1000MHZ)

Orthogonal Axis :	X
Test Mode :	TX Low Channel

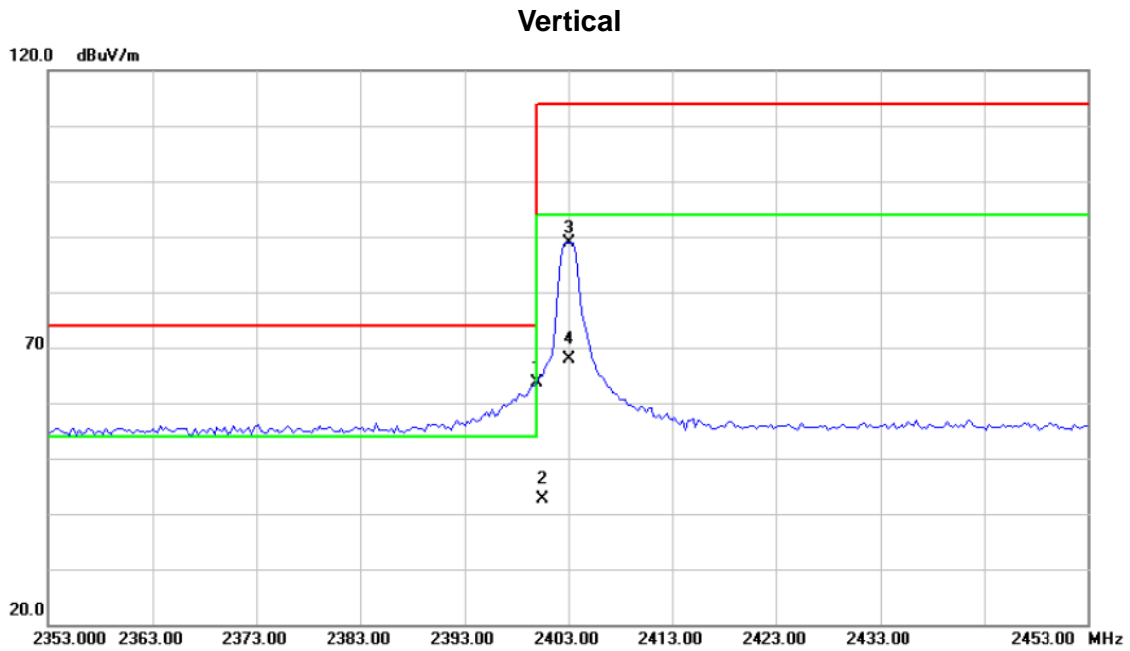

No.	Mk.	Freq.	Reading Level	Correct Factor	Measurement	Limit	Over	Detector	Comment
		MHz	dBuV	dB	dBuV/m	dBuV/m	dB		
1	*	2400.000	32.63	31.07	63.70	74.00	-10.30	peak	
2		2400.000	11.63	31.07	42.70	54.00	-11.30	AVG	
3		2403.000	57.86	31.08	88.94	114.0	-25.06	peak	NO LIMIT
4		2403.000	36.86	31.08	67.94	94.00	-26.06	AVG	NO LIMIT

Orthogonal Axis :	X
Test Mode :	TX Low Channel

Vertical

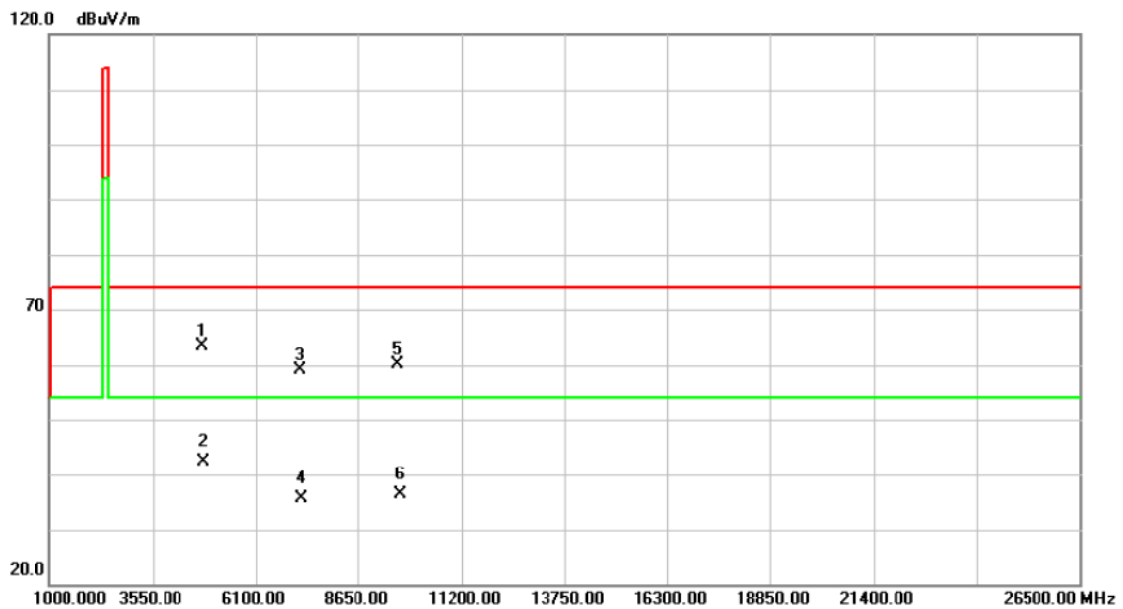

No.	Mk.	Freq. MHz	Reading Level dBuV	Correct Factor dB	Measure- ment dBuV/m	Limit dBuV/m	Over dB	Detector	Comment
1	*	4805.988	56.72	6.78	63.50	74.00	-10.50	peak	
2		4805.988	35.72	6.78	42.50	54.00	-11.50	AVG	
3		7208.325	44.00	15.03	59.03	74.00	-14.97	peak	
4		7208.325	20.70	15.03	35.73	54.00	-18.27	AVG	
5		9611.763	44.44	15.60	60.04	74.00	-13.96	peak	
6		9611.763	20.87	15.60	36.47	54.00	-17.53	AVG	

Orthogonal Axis :	X
Test Mode :	TX Low Channel

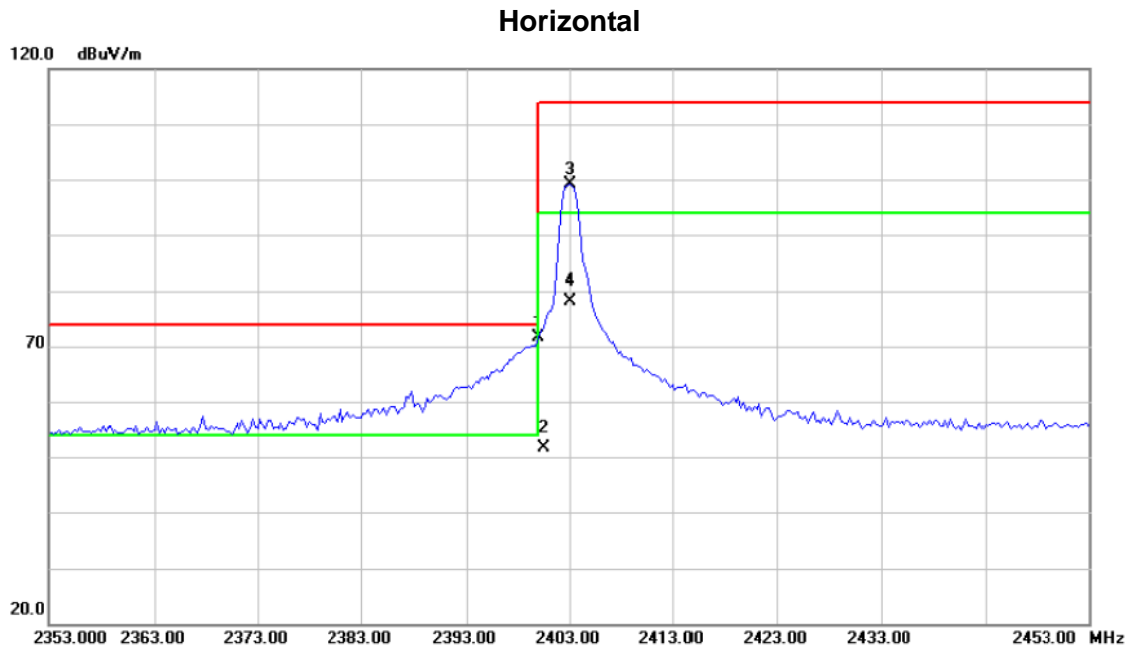

No.	Mk.	Freq. MHz	Reading Level dBuV	Correct Factor dB	Measure- ment dBuV/m	Limit dBuV/m	Over dB	Detector	Comment
1	*	2400.000	40.51	31.07	71.58	74.00	-2.42	peak	
2		2400.000	20.51	31.07	51.58	54.00	-2.42	AVG	
3		2403.000	68.05	31.08	99.13	114.0	-14.87	peak	NO LIMIT
4		2403.000	47.05	31.08	78.13	94.00	-15.87	AVG	NO LIMIT

Orthogonal Axis :	X
Test Mode :	TX Low Channel

Horizontal

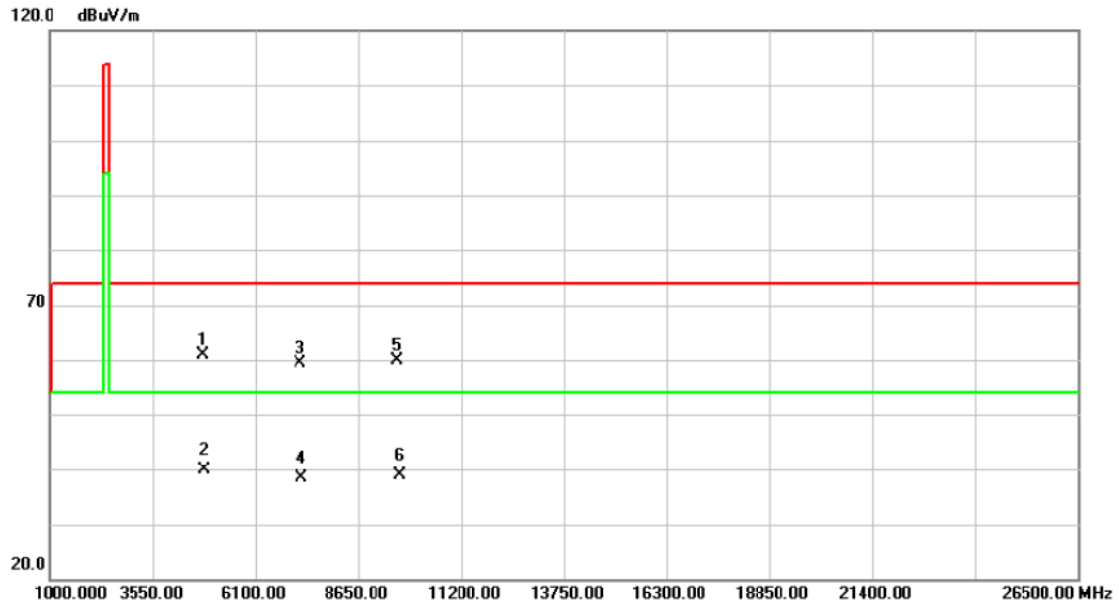

No.	Mk.	Freq.	Reading Level	Correct Factor	Measurement	Limit	Over	Detector	Comment
		MHz	dBuV	dB	dBuV/m	dBuV/m	dB		
1	*	4806.025	54.07	6.78	60.85	74.00	-13.15	peak	
2		4806.025	33.01	6.78	39.79	54.00	-14.21	AVG	
3		7209.738	44.43	15.03	59.46	74.00	-14.54	peak	
4		7209.738	23.43	15.03	38.46	54.00	-15.54	AVG	
5		9611.025	44.35	15.60	59.95	74.00	-14.05	peak	
6		9611.025	23.35	15.60	38.95	54.00	-15.05	AVG	

Orthogonal Axis :	X
Test Mode :	TX Middle Channel

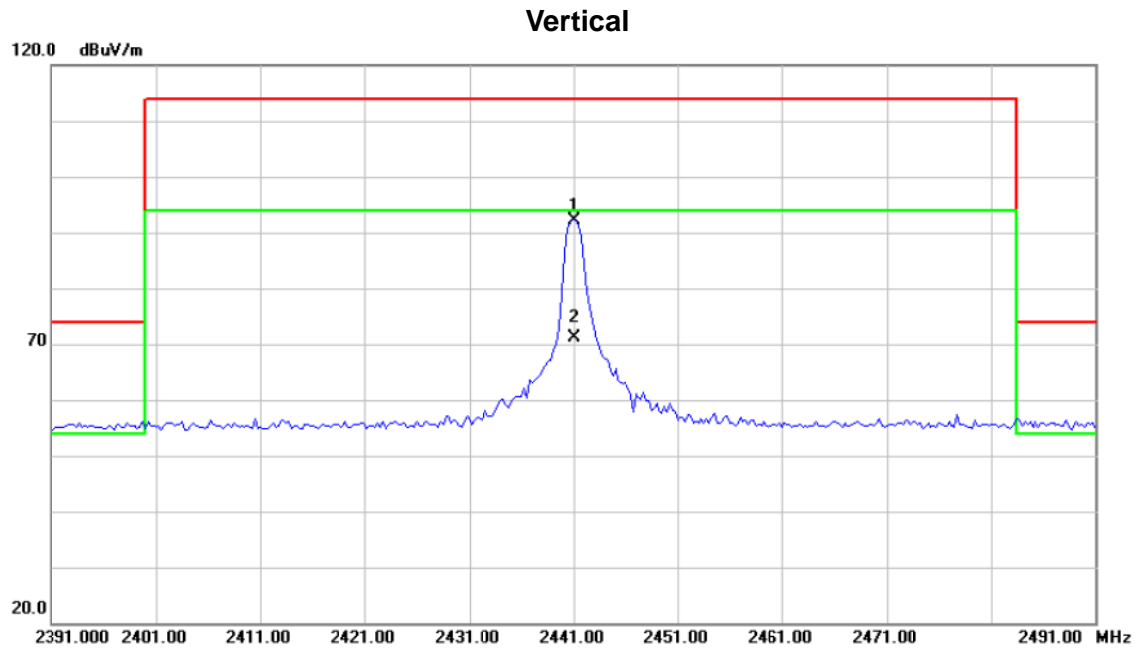

No.	Mk.	Freq. MHz	Reading Level dBuV	Correct Factor dB	Measure- ment dBuV/m	Limit dBuV/m	Over dB	Detector	Comment
1	*	2441.000	60.99	31.26	92.25	114.0	-21.75	peak	NO LIMIT
2		2441.000	39.99	31.26	71.25	94.00	-22.75	AVG	NO LIMIT

Orthogonal Axis :	X
Test Mode :	TX Middle Channel

Vertical

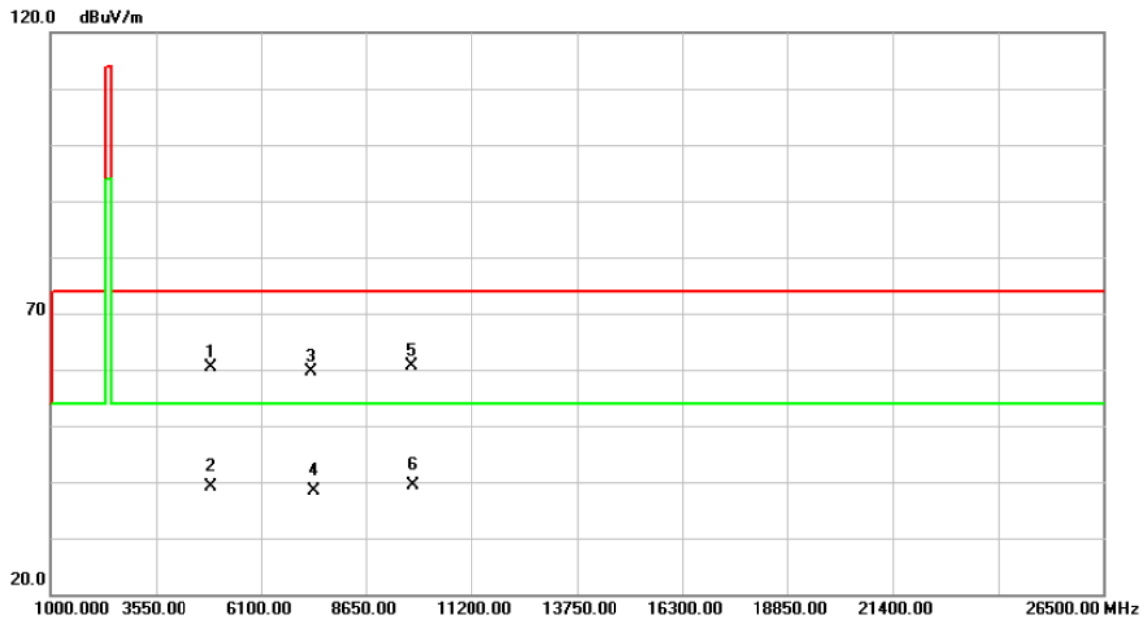

No.	Mk.	Freq. MHz	Reading Level dBuV	Correct Factor dB	Measure- ment dBuV/m	Limit dBuV/m	Over dB	Detector	Comment
1		4882.025	53.72	6.77	60.49	74.00	-13.51	peak	
2		4882.025	32.45	6.77	39.22	54.00	-14.78	AVG	
3		7320.975	44.01	15.63	59.64	74.00	-14.36	peak	
4		7320.975	22.74	15.63	38.37	54.00	-15.63	AVG	
5	*	9763.913	44.89	15.78	60.67	74.00	-13.33	peak	
6		9763.913	23.62	15.78	39.40	54.00	-14.60	AVG	

Orthogonal Axis :	X
Test Mode :	TX Middle Channel

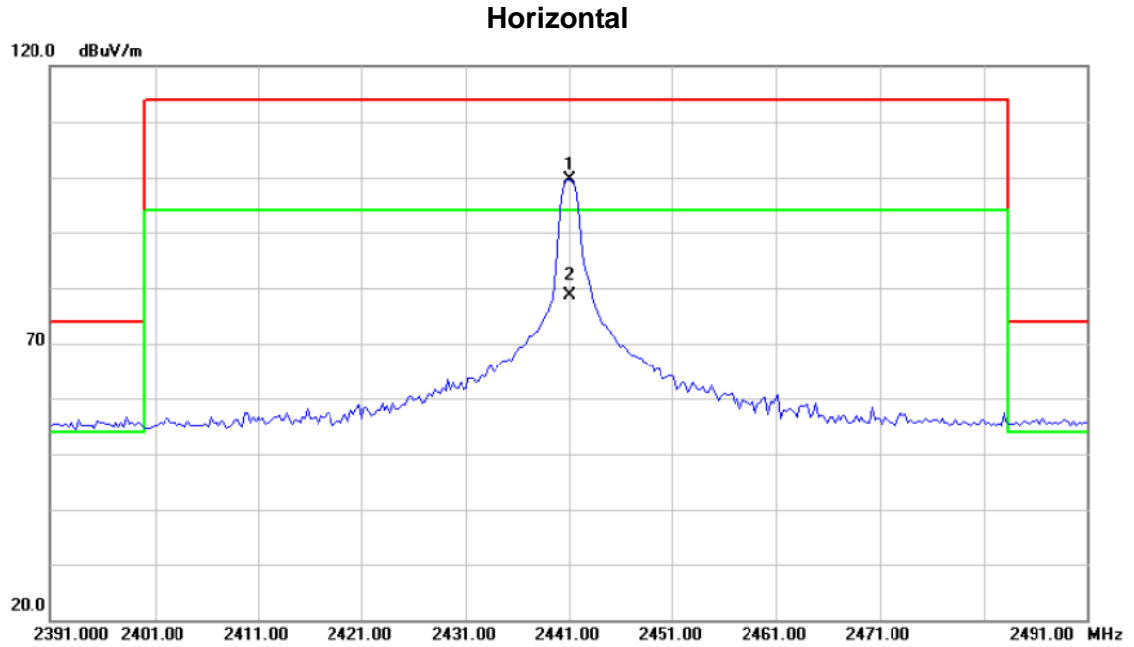

No.	Mk.	Freq. MHz	Reading Level dBuV	Correct Factor dB	Measure- ment dBuV/m	Limit dBuV/m	Over dB	Detector	Comment
1	*	2441.000	68.32	31.26	99.58	114.0	-14.42	peak	NO LIMIT
2		2441.000	47.32	31.26	78.58	94.00	-15.42	AVG	NO LIMIT

Orthogonal Axis :	X
Test Mode :	TX Middle Channel

Horizontal

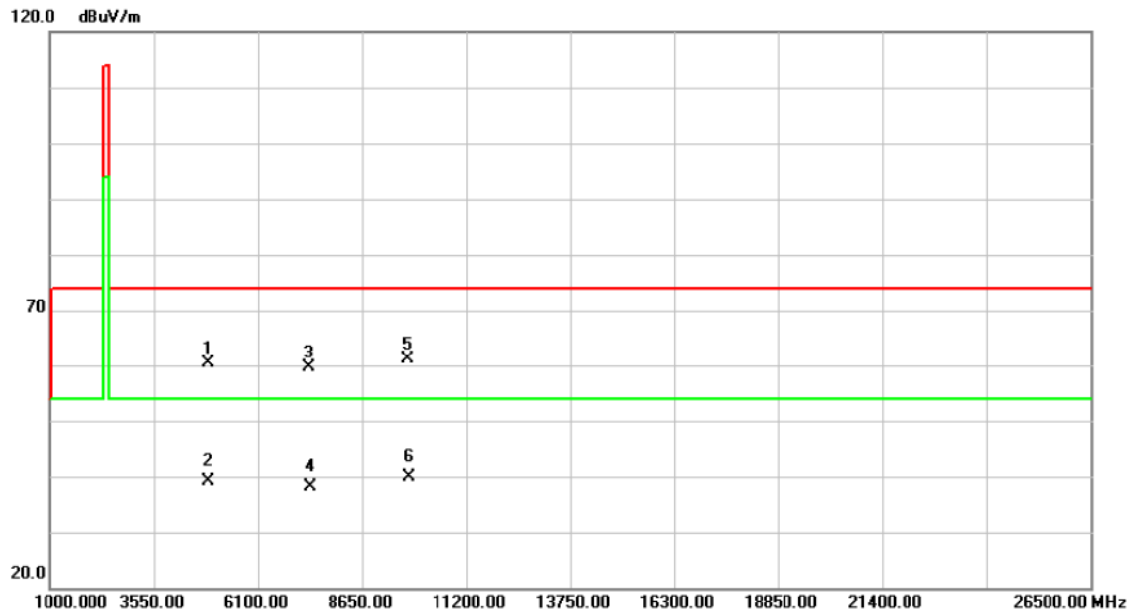

No.	Mk.	Freq.	Reading Level	Correct Factor	Measurement	Limit	Over	Detector	Comment
		MHz	dBuV	dB	dBuV/m	dBuV/m	dB		
1		4882.038	53.60	6.77	60.37	74.00	-13.63	peak	
2		4882.038	32.33	6.77	39.10	54.00	-14.90	AVG	
3		7324.438	43.87	15.65	59.52	74.00	-14.48	peak	
4		7324.438	22.60	15.65	38.25	54.00	-15.75	AVG	
5	*	9764.837	45.26	15.78	61.04	74.00	-12.96	peak	
6		9764.837	23.99	15.78	39.77	54.00	-14.23	AVG	

Orthogonal Axis :	X
Test Mode :	TX High Channel

Vertical

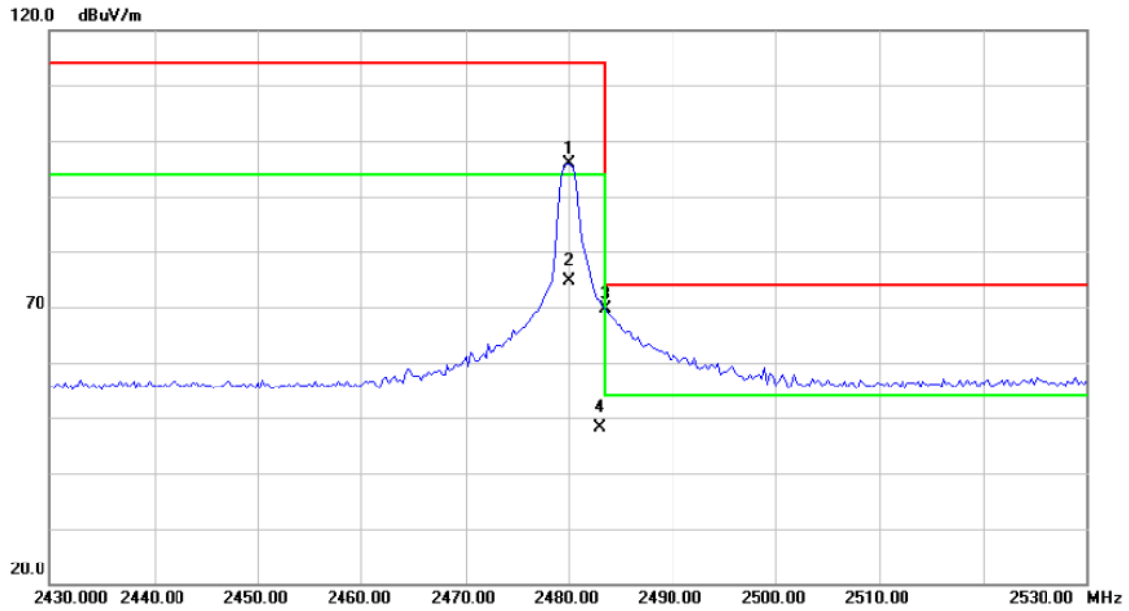

No.	Mk.	Freq. MHz	Reading Level dBuV	Correct Factor dB	Measure- ment dBuV/m	Limit dBuV/m	Over dB	Detector	Comment
1		2480.000	64.39	31.44	95.83	114.0	-18.17	peak	NO LIMIT
2		2480.000	43.12	31.44	74.56	94.00	-19.44	AVG	NO LIMIT
3	*	2483.500	38.06	31.46	69.52	74.00	-4.48	peak	
4		2483.500	16.79	31.46	48.25	54.00	-5.75	AVG	

Orthogonal Axis :	X
Test Mode :	TX High Channel

Vertical

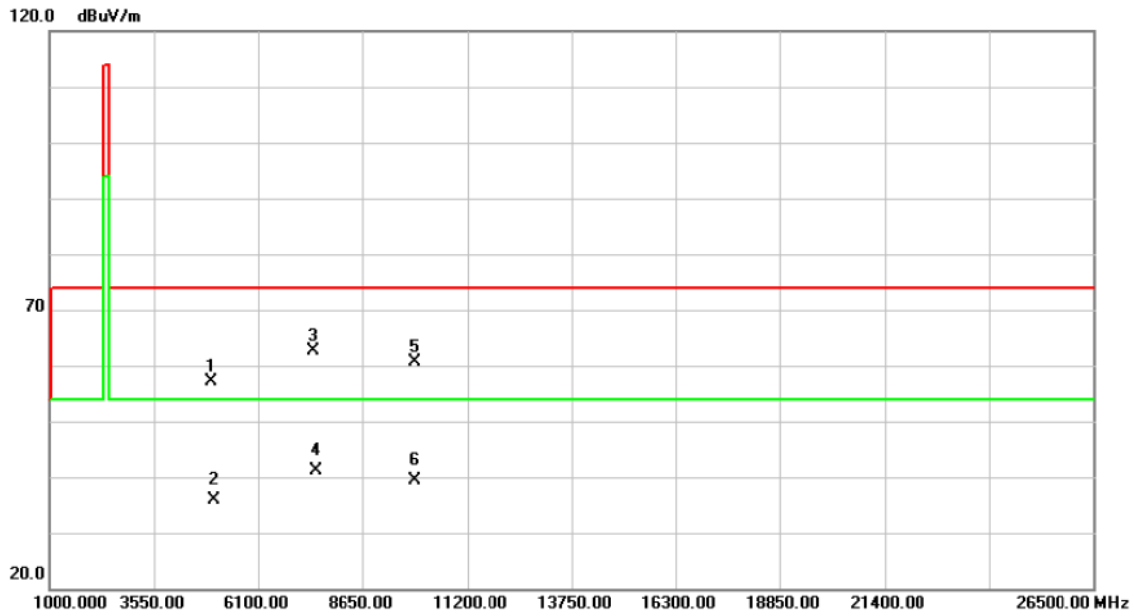

No.	Mk.	Freq. MHz	Reading Level dBuV	Correct Factor dB	Measure- ment dBuV/m	Limit dBuV/m	Over dB	Detector	Comment
1		4959.350	50.34	6.76	57.10	74.00	-16.90	peak	
2		4959.350	29.07	6.76	35.83	54.00	-18.17	AVG	
3	*	7439.988	46.23	16.28	62.51	74.00	-11.49	peak	
4		7439.988	24.96	16.28	41.24	54.00	-12.76	AVG	
5		9921.200	44.73	15.96	60.69	74.00	-13.31	peak	
6		9921.200	23.46	15.96	39.42	54.00	-14.58	AVG	

Orthogonal Axis :	X
Test Mode :	TX High Channel

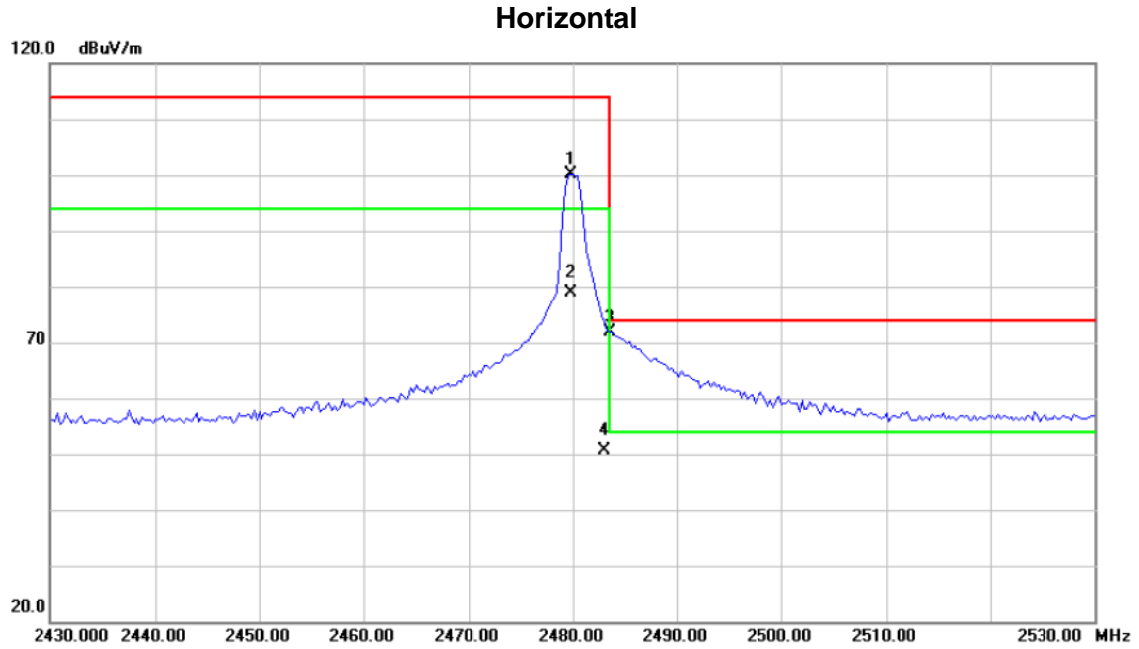

No.	Mk.	Freq. MHz	Reading Level dBuV	Correct Factor dB	Measure- ment dBuV/m	Limit dBuV/m	Over dB	Detector	Comment
1		2479.750	68.61	31.44	100.05	114.0	-13.95	peak	NO LIMIT
2		2479.750	47.34	31.44	78.78	94.00	-15.22	AVG	NO LIMIT
3	*	2483.500	40.35	31.46	71.81	74.00	-2.19	peak	
4		2483.500	19.08	31.46	50.54	54.00	-3.46	AVG	

Orthogonal Axis :	X
Test Mode :	TX High Channel

Horizontal

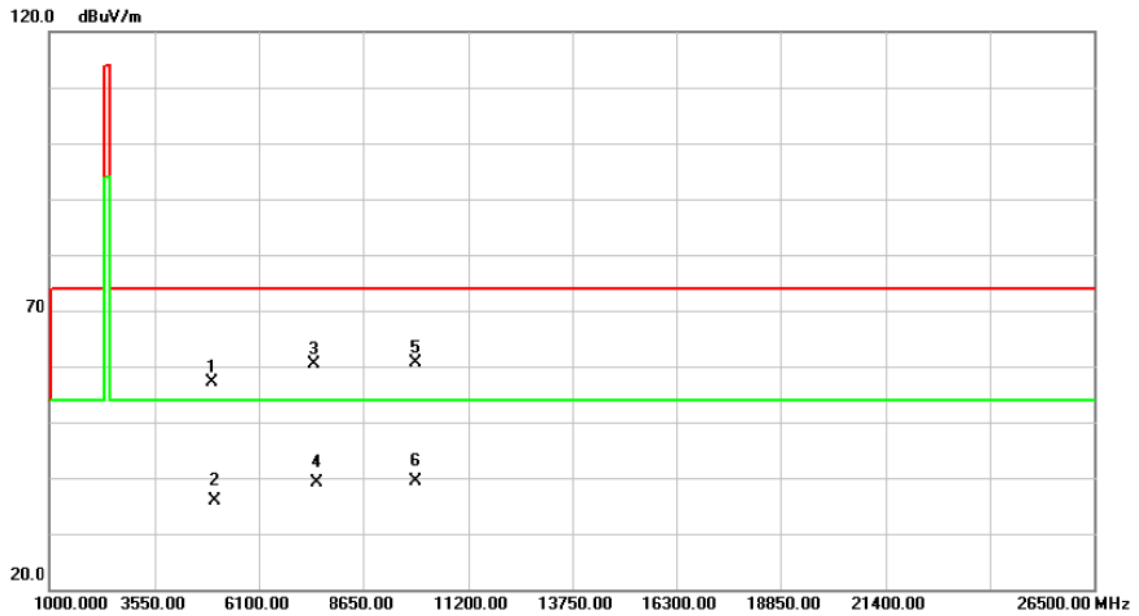

No.	Mk.	Freq. MHz	Reading Level dBuV	Correct Factor dB	Measure- ment dBuV/m	Limit dBuV/m	Over dB	Detector	Comment
1		4959.850	50.38	6.76	57.14	74.00	-16.86	peak	
2		4959.850	29.18	6.76	35.94	54.00	-18.06	AVG	
3		7438.913	44.03	16.27	60.30	74.00	-13.70	peak	
4		7438.913	22.76	16.27	39.03	54.00	-14.97	AVG	
5	*	9919.938	44.78	15.96	60.74	74.00	-13.26	peak	
6		9919.938	23.51	15.96	39.47	54.00	-14.53	AVG	

ATTACHMENT E - BANDWIDTH

Frequency (MHz)	20dB Bandwidth (MHz)	99% Occupied BW (MHz)
2402	1.56	1.78
2441	1.59	1.72
2480	1.54	1.76

TX Low Channel

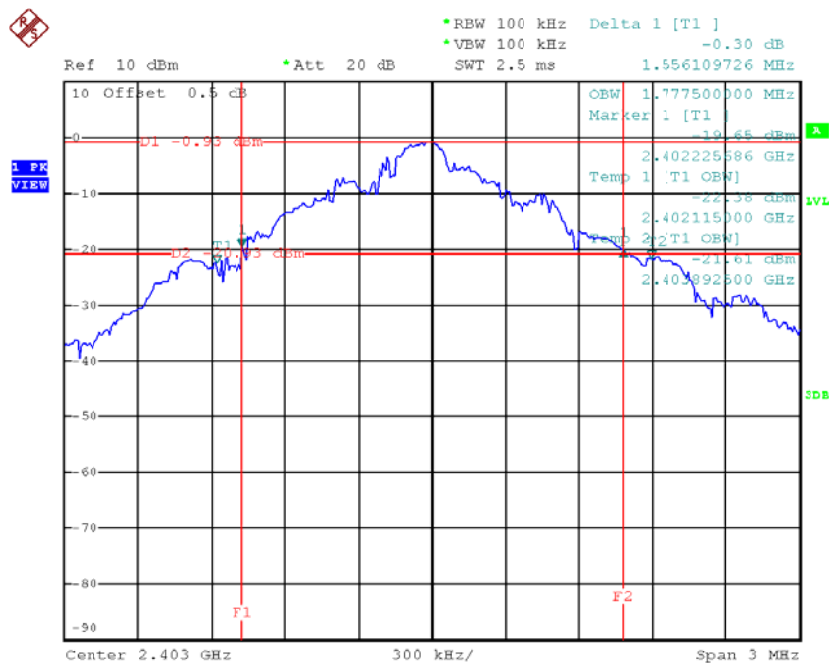

Date: 11.DEC.2014 11:53:41

TX Middle Channel

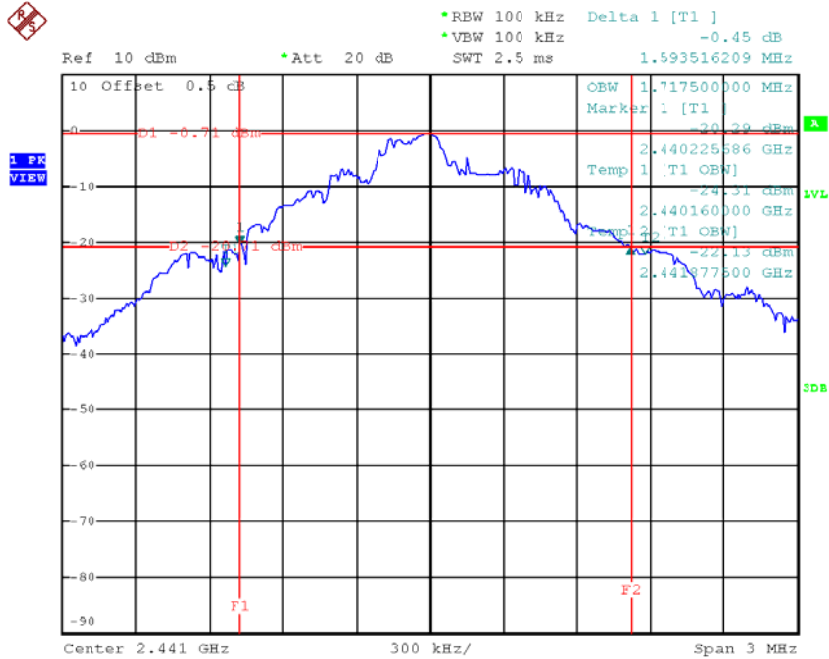

Date: 11.DEC.2014 11:58:58

TX High Channel

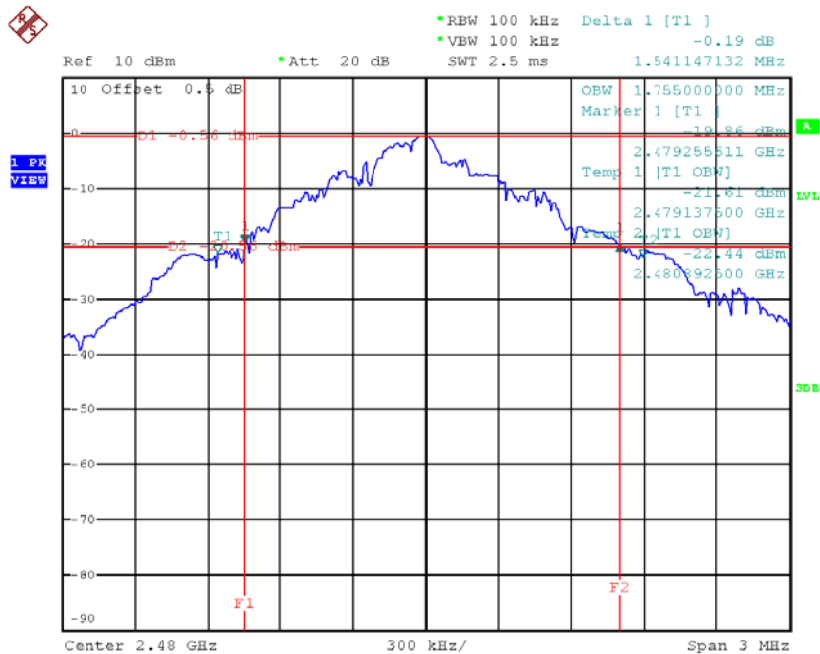

Date: 11.DEC.2014 12:01:54

**ATTACHMENT F - ANTENNA CONDUCTED SPURIOUS
EMISSION**

TX Low Channel(Lower)

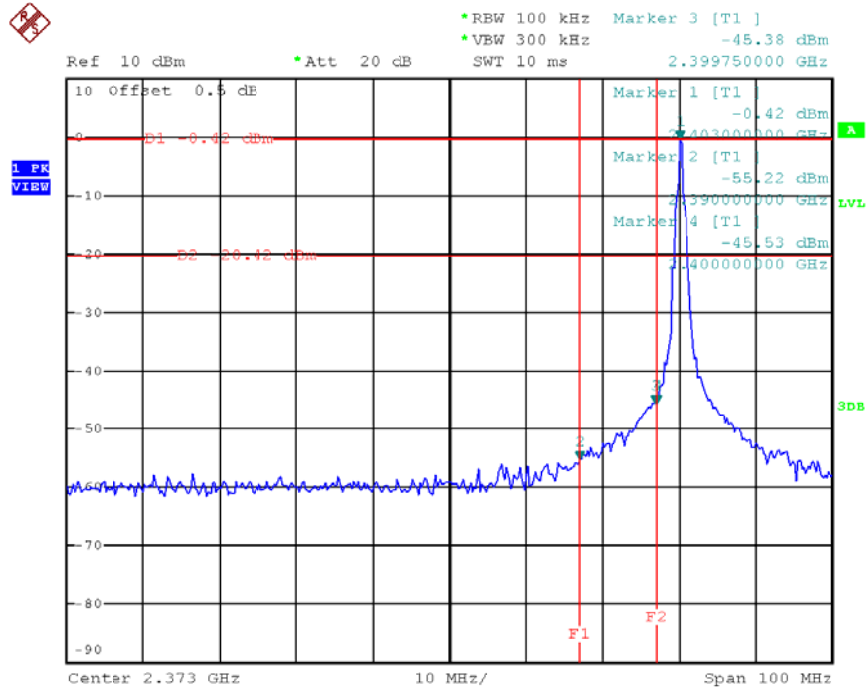

Date: 11.DEC.2014 11:54:04

TX HighChannel (Upper)

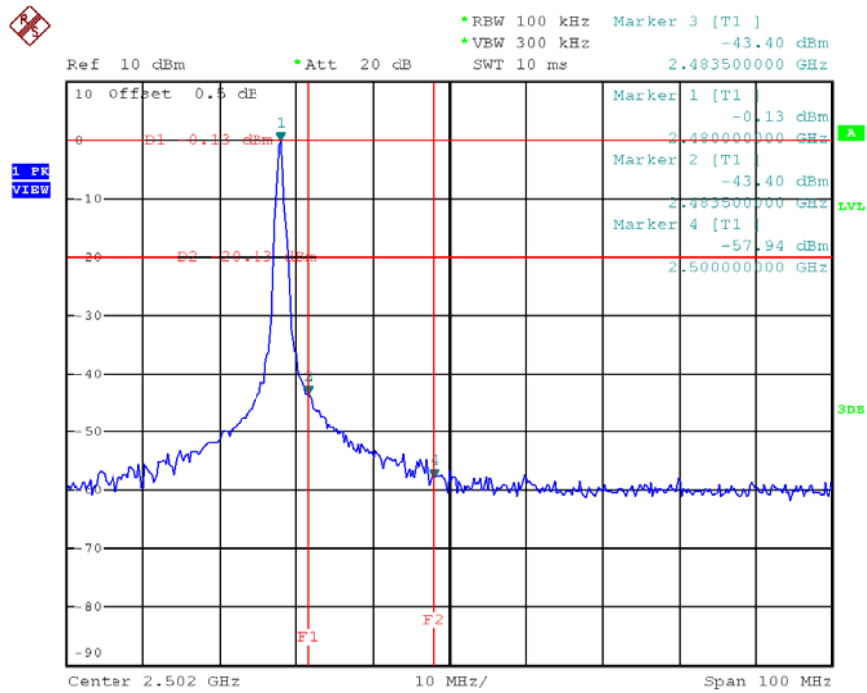

Date: 11.DEC.2014 12:02:18

TX High Channel (10 Harmonic of the frequency)

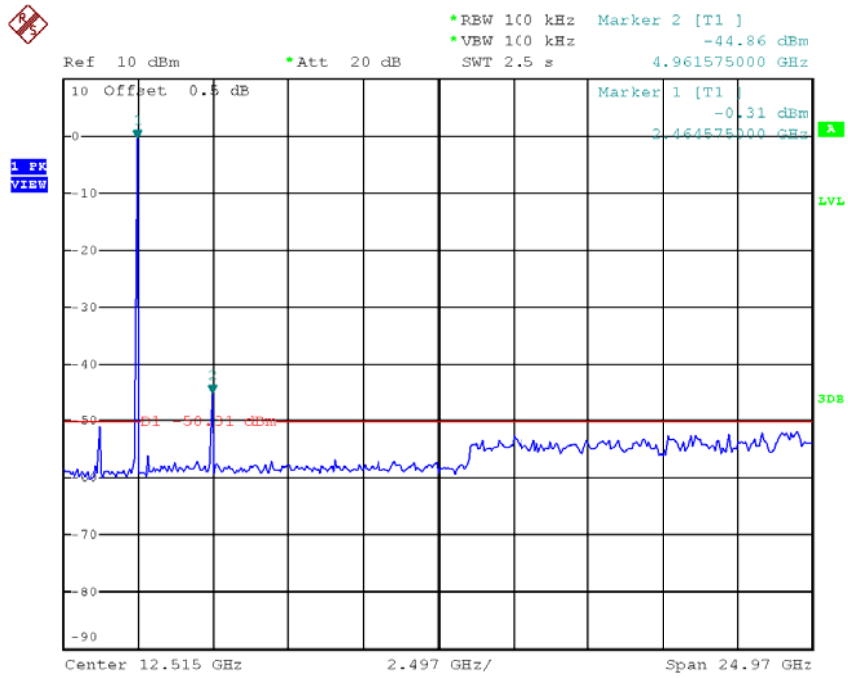

Date: 11.DEC.2014 12:01:29