



Radio Test Report

FCC ID: H4IKB2770

This report concerns (check one) : Original Grant Class II Change

Issued Date : Jul. 31, 2013
Project No. : 1307131
Equipment : Bluetooth Keyboard
Model Name : SK-2770

Applicant : LITE-ON TECHNOLOGY CORP.
Address : 18F, 392 , Ruey Kuang Road, Neihu,
Taipei 11492, Taiwan, R.O.C

Tested by: Neutron Engineering Inc. EMC Laboratory
Date of Receipt: Jul. 15, 2013
Date of Test: Jul. 15, 2013 ~ Jul. 24, 2013

Testing Engineer: Josh Lin
(Josh Lin)

Technical Manager: Jeff Yang
(Jeff Yang)

Authorized Signatory: Andy Chiu
(Andy Chiu)

Neutron Engineering Inc.
B1, No. 37, Lane 365, YangGuang St.,
NeiHu District 114, Taipei, Taiwan.
TEL: +886-2-2657-3299
FAX: +886-2-2657-3331





Declaration

Neutron represents to the client that testing is done in accordance with standard procedures as applicable and that test instruments used has been calibrated with the standards traceable to National Measurement Laboratory (**NML**) of **R.O.C.**, or National Institute of Standards and Technology (**NIST**) of **U.S.A.**

Neutron's reports apply only to the specific samples tested under conditions. It is manufacture's responsibility to ensure that additional production units of this model are manufactured with the identical electrical and mechanical components. **Neutron** shall have no liability for any declarations, inferences or generalizations drawn by the client or others from **Neutron** issued reports.

Neutron's reports must not be used by the client to claim product endorsement by the authorities or any agency of the Government.

This report is the confidential property of the client. As a mutual protection to the clients, the public and **Neutron-self**, extracts from the test report shall not be reproduced except in full with **Neutron's** authorized written approval.

Neutron's laboratory quality assurance procedures are in compliance with the **ISO Guide 17025** requirements, and accredited by the conformity assessment authorities listed in this test report.

Limitation

For the use of the authority's logo is limited unless the Test Standard(s)/Scope(s)/Item(s) mentioned in this test report is (are) included in the conformity assessment authorities acceptance respective.



Table of Contents

REPORT ISSUED HISTORY	6
1 CERTIFICATION	7
2 . SUMMARY OF TEST RESULTS	8
2.1 TEST FACILITY	9
2.2 MEASUREMENT UNCERTAINTY	9
3 GENERAL INFORMATION	10
3.1 GENERAL DESCRIPTION OF EUT	10
3.2 DESCRIPTION OF TEST MODES	12
3.3 TABLE OF PARAMETERS OF TEXT SOFTWARE SETTING	13
3.4 BLOCK DIAGRAM SHOWING THE CONFIGURATION OF SYSTEM TESTED	14
3.5 DESCRIPTION OF SUPPORT UNITS	15
4 CONDUCTED EMISSION	16
4.1 LIMIT	16
4.2 MEASUREMENT INSTRUMENTS LIST	16
4.3 TEST PROCEDURES	17
4.4 TEST SETUP LAYOUT	17
4.5 DEVIATION FROM TEST STANDARD	17
4.6 EUT OPERATING CONDITIONS	18
4.7 TEST RESULTS	19
5 ANTENNA CONDUCTED SPURIOUS EMISSION	21
5.1 LIMIT	21
5.2 MEASUREMENT INSTRUMENTS LIST	21
5.3 TEST PROCEDURES	21
5.4 TEST SETUP LAYOUT	21
5.5 DEVIATION FROM TEST STANDARD	21
5.6 EUT OPERATING CONDITIONS	21
5.7 TEST RESULTS	22
6 HOPPING CHANNEL SEPARATION	26
6.1 LIMIT	26
6.2 MEASUREMENT INSTRUMENTS LIST	26
6.3 MEASURING INSTRUMENTS SETTING	26
6.4 TEST PROCEDURES	26
6.5 TEST SETUP LAYOUT	26
6.6 DEVIATION FROM TEST STANDARD	26
6.7 EUT OPERATING CONDITIONS	26
6.8 TEST RESULTS	27
7 MAXIMUM PEAK CONDUCTED OUTPUT POWER	31
7.1 LIMIT	31



Table of Contents

7.2	MEASUREMENT INSTRUMENTS LIST	31
7.3	TEST PROCEDURES	31
7.4	TEST SETUP LAYOUT	31
7.5	DEVIATION FROM TEST STANDARD	31
7.6	EUT OPERATING CONDITIONS	31
7.7	TEST RESULTS	32
8	RADIATED SPURIOUS EMISSION (9 KHZ TO 1 GHZ)	34
8.1	LIMIT	34
8.2	MEASUREMENT INSTRUMENTS LIST	35
8.3	MEASURING INSTRUMENTS SETTING	35
8.4	TEST PROCEDURES	36
8.5	DEVIATION FROM TEST STANDARD	36
8.6	TEST SETUP LAYOUT	36
8.7	EUT OPERATING CONDITIONS	37
8.8	TEST RESULTS	38
9	RADIATED SPURIOUS EMISSION (ABOVE 1 GHZ)	40
9.1	LIMIT	40
9.2	MEASUREMENT INSTRUMENTS LIST	41
9.3	MEASURING INSTRUMENTS SETTING	41
9.4	TEST PROCEDURES	42
9.5	DEVIATION FROM TEST STANDARD	42
9.6	TEST SETUP LAYOUT	42
9.7	EUT OPERATING CONDITIONS	43
9.8	TEST RESULTS	44
9.9	TEST RESULTS (RESTRICTED BANDS)	56
10	NUMBER OF HOPPING FREQUENCY	60
10.1	LIMIT	60
10.2	MEASUREMENT INSTRUMENTS LIST	60
10.3	MEASURING INSTRUMENTS SETTING	60
10.4	TEST PROCEDURES	60
10.5	TEST SETUP LAYOUT	60
10.6	DEVIATION FROM TEST STANDARD	60
10.7	EUT OPERATING CONDITIONS	60
10.8	TEST RESULTS	61
11	AVERAGE TIME OF OCCUPANCY	62
11.1	LIMIT	62
11.2	MEASUREMENT INSTRUMENTS LIST	62
11.3	TEST PROCEDURES	62



Table of Contents

11.4	TEST SETUP LAYOUT	62
11.5	DEVIATION FROM TEST STANDARD	62
11.6	EUT OPERATING CONDITIONS	63
11.7	TEST RESULTS	64
12	RF EXPOSURE COMPLIANCE	67
12.1	LIMIT	67
12.2	MEASUREMENT INSTRUMENTS LIST	67
12.3	MPE CALCULATION METHOD	67
12.4	TEST SETUP LAYOUT	68
12.5	DEVIATION FROM TEST STANDARD	68
12.6	EUT OPERATING CONDITIONS	68
12.7	TEST RESULTS	68
13	EUT TEST PHOTO	69



REPORT ISSUED HISTORY

Revised Version No.	Description	Issued Date
-	Initial Issue.	Jul. 31, 2013



1 CERTIFICATION

Equipment : Bluetooth Keyboard
Brand Name : Goldtouch
Model Name : SK-2770
Applicant : LITE-ON TECHNOLOGY CORP.
Date of Test : Jul. 15, 2013 ~ Jul. 24, 2013
Standards : FCC Part 15, Subpart C: 2012
ANSI C63.4: 2009

The above equipment has been tested and found compliance with the requirement of the relative standards by Neutron Engineering Inc. EMC Laboratory.
The test data, data evaluation, and equipment configuration contained in our test report (Ref No. NEI-FCCP-1-1307131) were obtained utilizing the test procedures, test instruments, test sites that has been accredited by the Authority of TAF according to the ISO-17025 quality assessment standard and technical standard(s).



2. SUMMARY OF TEST RESULTS

Standard Clause	Test Item	Result
15.207	Conducted Emission	PASS
15.247 (c)	Antenna conducted Spurious Emission	PASS
15.247 (a)(1)	Hopping Channel Separation	PASS
15.247 (b)	Maximum Peak Conducted Output Power	PASS
15.247 (c)	Radiated Spurious Emission	PASS
15.247 (b)(1)	Number of Hopping Frequency	PASS
15.247 (a)(1)	Average time of occupancy	PASS
15.205	Restricted Bands	PASS
15.203	Antenna Requirement	PASS
1.1307 1.1310 2.1091 2.1093	RF Exposure Compliance	PASS

NOTE:

1. **N/A**: denotes test is not applicable in this Test Report
2. Portable device; SAR report is required.



2.1 TEST FACILITY

The test facilities used to collect the test data in this report:

Conducted emission Test:

C01: (VCCI RN: C-2918; FCC RN: 95335; FCC DN: TW1010)
 No.132-1, Ln. 329, Sec. 2, Balian Rd., Xizhi Dist., New Taipei City 221, Taiwan (R.O.C.)

Radiated emission Test (Below 1 GHz):

CB08: (FCC RN: 614388; FCC DN: TW1054; IC Assigned Code: 4428C-1)
 1F., No. 61, Ln. 77, Sing-ai Rd., Neihu Dist., Taipei City 114, Taiwan (R.O.C.)

Radiated emission Test (Above 1 GHz):

CB08: (VCCI RN: G-91; FCC RN: 614388; FCC DN: TW1054; IC Assigned Code: 4428C-1)
 1F., No. 61, Ln. 77, Sing-ai Rd., Neihu Dist., Taipei City 114, Taiwan (R.O.C.)

2.2 MEASUREMENT UNCERTAINTY

The measurement uncertainty is not specified by FCC/Industry Canada rules and for reference only.

The reported uncertainty of measurement $y \pm U$, where expanded uncertainty U is based on a standard uncertainty multiplied by a coverage factor of $k=2$, providing a level of confidence of approximately **95%**.

The measurement instrumentation uncertainty considerations contained in CISPR 16-4-2.

A. Conducted emission test:

Test Site	Measurement Frequency Range	U , (dB)	NOTE
C01	150 kHz ~ 30 MHz	1.94	

B. Radiated emission test:

Test Site	Item	Measurement Frequency Range	Uncertainty	NOTE	
CB08	Radiated emission at 3m	Horizontal Polarization	30 - 200MHz	3.35 dB	
			200 - 1000MHz	3.11 dB	
			1 - 18GHz	3.97 dB	
			18 - 40GHz	4.01 dB	
		Vertical Polarization	30 - 200MHz	3.22 dB	
			200 - 1000MHz	3.24 dB	
			1 - 18GHz	4.05 dB	
			18 - 40GHz	4.04 dB	

Our calculated Measurement Instrumentation Uncertainty is shown in the tables above. These are our U_{lab} values in CISPR 16-4-2 terminology.

Since Table 1 of CISPR 16-4-2 has values of measurement instrumentation uncertainty, called U_{CISPR} , as follows:

Conducted Disturbance (mains port) – 150 kHz – 30 MHz : 3.6 dB

Radiated Disturbance (electric field strength on an open area test site or alternative test site) – 30 MHz – 1000 MHz : 5.2 dB

It can be seen that our U_{lab} values are smaller than U_{CISPR} .



3 GENERAL INFORMATION

3.1 GENERAL DESCRIPTION OF EUT

Equipment	Bluetooth Keyboard	
Brand Name	Goldtouch	
Model Name	SK-2770	
OEM Brand/Model Name	N/A	
Model Difference	N/A	
Product Description	The EUT is a Bluetooth Keyboard.	
	Operation Frequency	2402 MHz ~ 2480 MHz
	Modulation Type	FHSS(GFSK)
	Bit Rate of Transmitter	1 Mbps
	Number Of Channel	Please refer to the Note 2.
	Antenna Designation	Please refer to the Note 3.
	Antenna Gain(Peak)	Please refer to the Note 3.
	Maximum Conducted Output Power	-2.00dBm
	More details of EUT technical specification, please refer to the User's Manual.	
Power Source	Battery supplied.	
Power Rating	I/P: DC 3.7V	
Connecting I/O Port(s)	Please refer to the User's Manual	
Products Covered	N/A	
EUT Modification(s)	N/A	

NOTE:

1. For a more detailed features description, please refer to the manufacturer's specifications or the User's Manual.



2. Channel List:

Channel	Frequency (MHz)	Channel	Frequency (MHz)	Channel	Frequency (MHz)
00	2402	27	2429	54	2456
01	2403	28	2430	55	2457
02	2404	29	2431	56	2458
03	2405	30	2432	57	2459
04	2406	31	2433	58	2460
05	2407	32	2434	59	2461
06	2408	33	2435	60	2462
07	2409	34	2436	61	2463
08	2410	35	2437	62	2464
09	2411	36	2438	63	2465
10	2412	37	2439	64	2466
11	2413	38	2440	65	2467
12	2414	39	2441	66	2468
13	2415	40	2442	67	2469
14	2416	41	2443	68	2470
15	2417	42	2444	69	2471
16	2418	43	2445	70	2472
17	2419	44	2446	71	2473
18	2420	45	2447	72	2474
19	2421	46	2448	73	2475
20	2422	47	2449	74	2476
21	2423	48	2450	75	2477
22	2424	49	2451	76	2478
23	2425	50	2452	77	2479
24	2426	51	2453	78	2480
25	2427	52	2454		
26	2428	53	2455		

3. Table for Filed Antenna

Ant.	Brand	Model Name	Antenna Type	Connector	Gain (dBi)
1	N/A	N/A	Ant. on PCB	N/A	0.66



3.2 DESCRIPTION OF TEST MODES

To investigate the maximum EMI emission characteristics generates from EUT, the test system was pre-scanning tested base on the consideration of following EUT operation mode or test configuration mode which possible have effect on EMI emission level. Each of these EUT operation mode(s) or test configuration mode(s) mentioned above was evaluated respectively.

Test Items	Mode	Data Rate	Tested Channel/Mode
Conducted Emission	GFSK	1 Mbps	2441 MHz
Antenna conducted Spurious Emission	GFSK	1 Mbps	2402 MHz, 2441 MHz, 2480 MHz
Hopping Channel Separation	GFSK	1 Mbps	2402 MHz, 2441 MHz, 2480 MHz
Maximum Peak Conducted Output Power	GFSK	1 Mbps	2402 MHz, 2441 MHz, 2480 MHz
Radiated Spurious Emission (30 MHz to 1 GHz)	GFSK	1 Mbps	2441 MHz
Radiated Spurious Emission (above 1 GHz)	GFSK	1 Mbps	2402 MHz, 2441 MHz, 2480 MHz
Number of Hopping Frequency	GFSK	1 Mbps	2402 MHz, 2441 MHz, 2480 MHz
Average time of occupancy	GFSK	1 Mbps	2402 MHz, 2441 MHz, 2480 MHz
Restricted Bands	GFSK	1 Mbps	2402 MHz, 2441 MHz, 2480 MHz
Antenna Requirement	GFSK	---	---
RF Exposure Compliance	GFSK	---	---

NOTE: The measurements are performed at the highest, middle, lowest available channels.



3.3 TABLE OF PARAMETERS OF TEXT SOFTWARE SETTING

During testing channel & power controlling software provided by the customer was used to control the operating channel as well as the output power level. The RF output power selection is for the setting of RF output power expected by the customer and is going to be fixed on the firmware of the final end product.

Data Rate	1 Mbps		
Test software Version	Broadcom blue tool		
Frequency	2402 MHz	2441 MHz	2480 MHz
Parameter	def	def	def



3.4 BLOCK DIAGRAM SHOWING THE CONFIGURATION OF SYSTEM TESTED

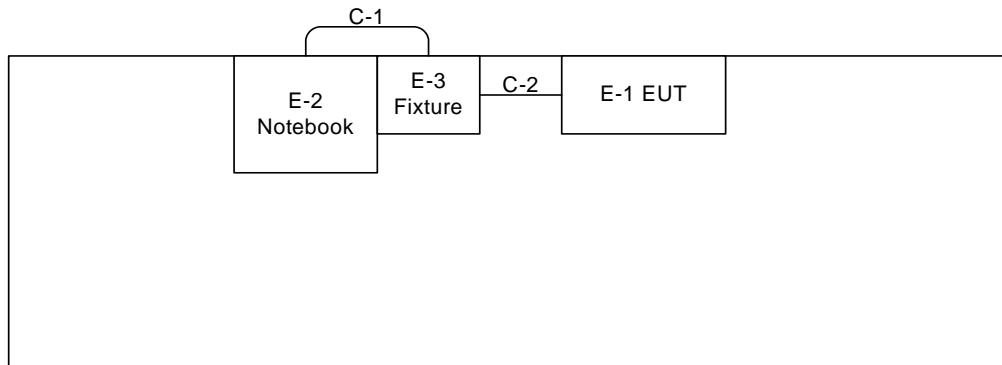

C-1 RS232 Cable
C-2 DATA Cable



3.5 DESCRIPTION OF SUPPORT UNITS

The EUT has been tested as an independent unit together with other necessary accessories or support units. The following support units or accessories were used to form a representative test configuration during the tests.

Item	Equipment	Mfr/Brand	Model/Type No.	FCC ID/IC ID	Series No.	Note
E-1	Bluetooth Keyboard	Goldtouch	SK-2770	H4IKB2770/ 4491A-KB2770	N/A	EUT
E-2	Notebook PC	DELL	D620	DOC	7T390 A03	
E-3	Fixture	N/A	N/A	N/A	N/A	

Item	Shielded Type	Ferrite Core	Length	Note
C-1	YES	NO	1.5M	
C-2	NO	NO	0.1M	
C-3	YES	NO	1.5M	

NOTE: The support equipment was authorized by Declaration of Conformity (DOC).



4 CONDUCTED EMISSION

4.1 LIMIT

FREQUENCY (MHz)	Class A (dBuV)		Class B (dBuV)	
	Quasi-peak	Average	Quasi-peak	Average
0.15 - 0.5	79.00	66.00	66 - 56 *	56 - 46 *
0.50 - 5.0	73.00	60.00	56.00	46.00
5.0 - 30.0	73.00	60.00	60.00	50.00

NOTE:

1. The tighter limit applies at the band edges.
2. The limit of " * " marked band means the limitation decreases linearly with the logarithm of the frequency in the range.
3. The test result calculated as following:
 Measurement Value = Reading Level + Correct Factor
 Correct Factor = Insertion Loss + Cable Loss + Attenuator Factor(if use)
 Margin Level = Measurement Value – Limit Value

4.2 MEASUREMENT INSTRUMENTS LIST

Item	Kind of Equipment	Manufacturer	Type No.	Serial No.	Calibrated until
1	TWO-LINE V-NETWORK	R&S	ENV216	101050	Apr. 22, 2014
2	Test Cable	TIMES	CFD300-NL	C01	Jun. 16, 2014
3	EMI Test Receiver	R&S	ESCI	100082	Mar. 21, 2014
4	Measurement Software	EZ	EZ_EMG (Version NB-02A)	N/A	N/A

NOTE: **N/A**: denotes No Model Name, No Serial No. or No Calibration specified.

4.3 TEST PROCEDURES

- a. The EUT was placed 0.8 meters from the horizontal ground plane with EUT being connected to the power mains through a line impedance stabilization network (LISN). All other support equipments powered from additional LISN(s). The LISN provide 50 Ohm/ 50uH of coupling impedance for the measuring instrument.
- b. Interconnecting cables that hang closer than 40 cm to the ground plane shall be folded back and forth in the center forming a bundle 30 to 40 cm long.
- c. I/O cables that are not connected to a peripheral shall be bundled in the center. The end of the cable may be terminated, if required, using the correct terminating impedance. The overall length shall not exceed 1 m.
- d. LISN at least 80 cm from nearest part of EUT chassis.
- e. For the actual test configuration, please refer to the related Item –EUT Test Photos.

NOTE:

- a. Reading in which marked as Peak, QP or AVG means measurements by using are Quasi-Peak or Average Mode with Detector BW=9 kHz (6 dB Bandwidth).
- b. All readings are Peak Mode value unless otherwise stated QP or AVG in column of Note. If the Peak or QP Mode Measured value compliance with the QP Limits and lower than AVG Limits, the EUT shall be deemed to meet both QP & AVG Limits and then only Peak or QP Mode was measured, but AVG Mode didn't perform.

4.4 TEST SETUP LAYOUT

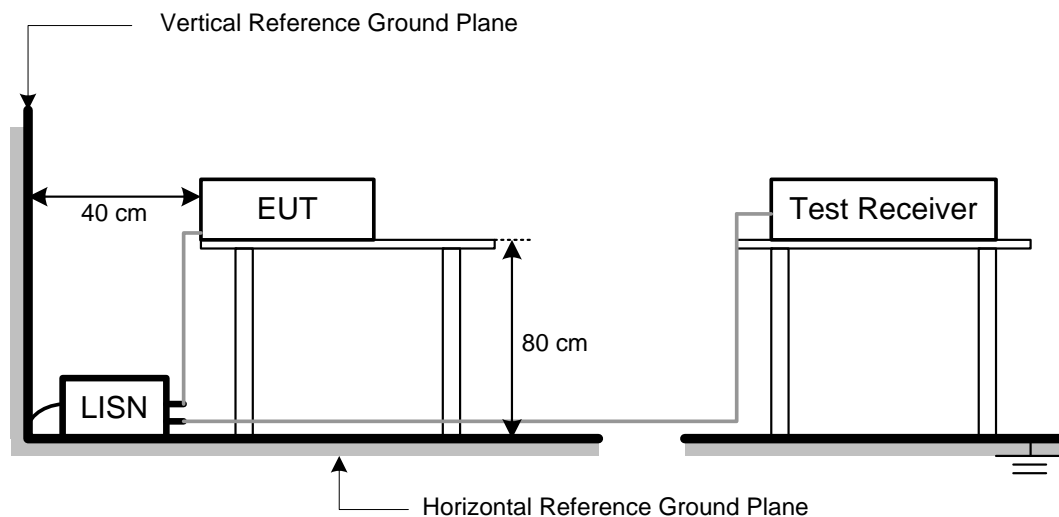

4.5 DEVIATION FROM TEST STANDARD

No deviation



4.6 EUT OPERATING CONDITIONS

The EUT was configured for testing in a typical fashion (as a customer would normally use it). The EUT has been programmed to continuously transmit during test. This operating condition was tested and used to collect the included data..



4.7 TEST RESULTS

E.U.T	Bluetooth Keyboard	Model Name	SK-2770
Temperature	24°C	Relative Humidity	48%
Test Voltage	AC 120V/60Hz		
Test Mode	Bluetooth/2441 MHz		

Phase: Line

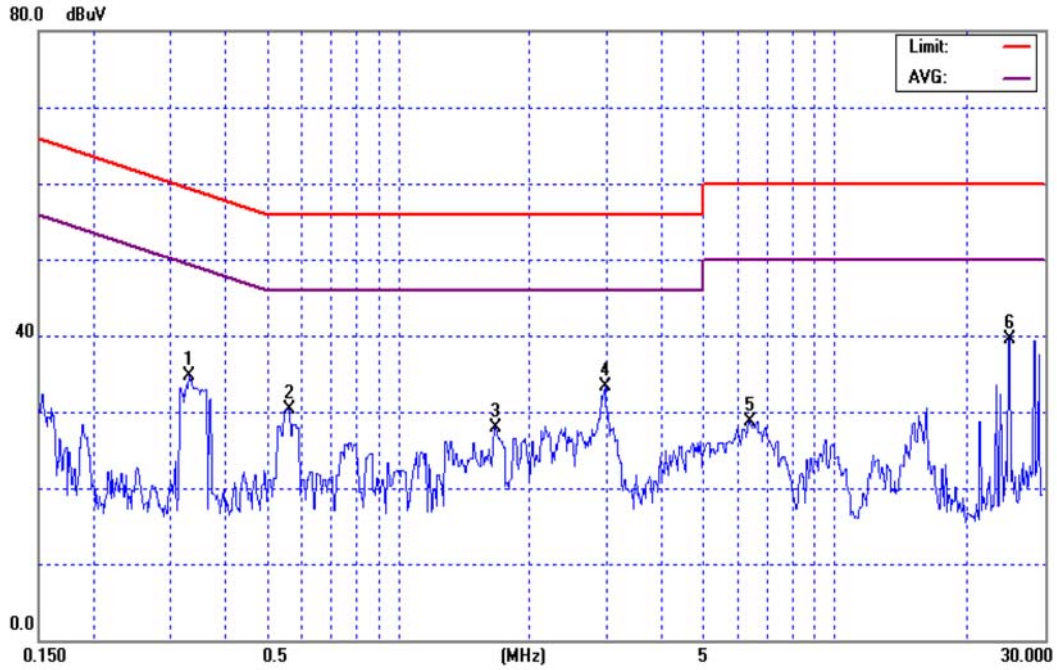

No.	Mk.	Freq. MHz	Reading Level dBuV	Correct Factor dB	Measure- ment dBuV	Limit dBuV	Over dB	Detector	Comment
1		0.3320	24.95	9.66	34.61	59.40	-24.79	peak	
2		0.5630	20.71	9.61	30.32	56.00	-25.68	peak	
3		1.6700	18.30	9.68	27.98	56.00	-28.02	peak	
4		2.9750	23.63	9.71	33.34	56.00	-22.66	peak	
5		6.4000	18.88	9.76	28.64	60.00	-31.36	peak	
6	*	25.1000	29.56	9.87	39.43	60.00	-20.57	peak	



E.U.T	Bluetooth Keyboard	Model Name	SK-2770
Temperature	24°C	Relative Humidity	48%
Test Voltage	AC 120V/60Hz		
Test Mode	Bluetooth/2441 MHz		

Phase: Neutral

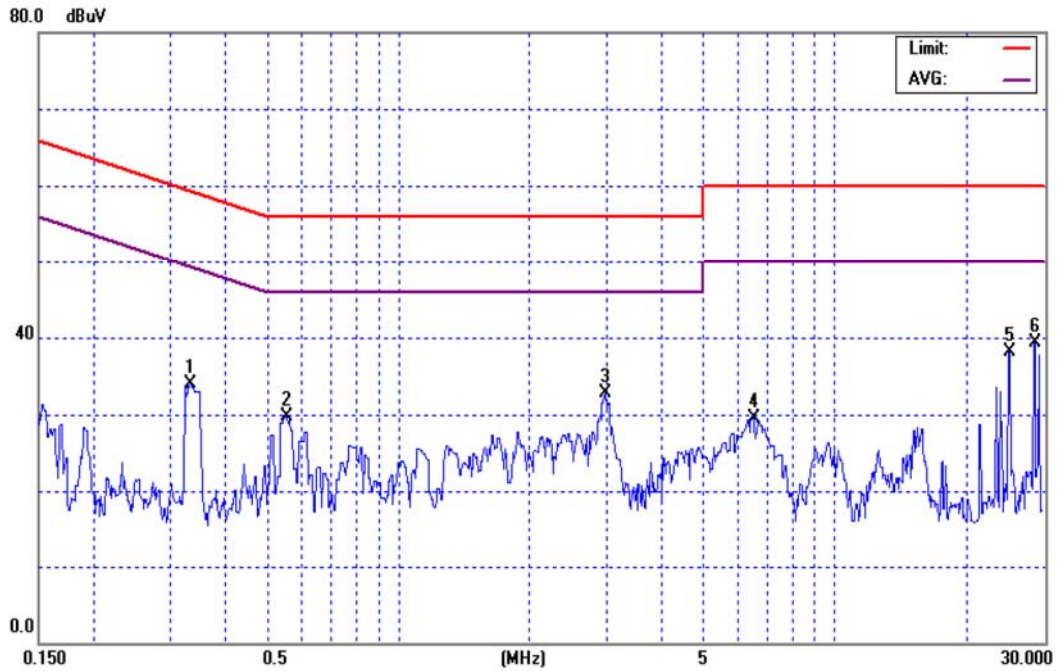

No.	Mk.	Freq. MHz	Reading Level dBuV	Correct Factor dB	Measure- ment dBuV	Limit dBuV	Over dB	Detector	Comment
1		0.3334	24.36	9.64	34.00	59.37	-25.37	peak	
2		0.5540	20.10	9.59	29.69	56.00	-26.31	peak	
3		2.9840	23.04	9.69	32.73	56.00	-23.27	peak	
4		6.5000	19.84	9.74	29.58	60.00	-30.42	peak	
5		25.1000	28.31	9.84	38.15	60.00	-21.85	peak	
6	*	28.6500	29.40	9.93	39.33	60.00	-20.67	peak	



5 ANTENNA CONDUCTED SPURIOUS EMISSION

5.1 LIMIT

Test Item	Frequency Range (MHz)	Limit
Antenna conducted Spurious Emission	30-25000	20 dB less than the peak value of fundamental frequency

5.2 MEASUREMENT INSTRUMENTS LIST

Item	Kind of Equipment	Manufacturer	Type No.	Serial No.	Calibrated until
1	Spectrum Analyzer	R&S	FSP-40	100129	Oct. 01, 2013

NOTE: **N/A**: denotes No Model Name, No Serial No. or No Calibration specified.

5.3 TEST PROCEDURES

- a. The EUT was directly connected to the spectrum analyzer and antenna output port as show in the block diagram below,
- b. Spectrum Setting : RBW= 100KHz, VBW=100KHz, Sweep time = Auto.

5.4 TEST SETUP LAYOUT



5.5 DEVIATION FROM TEST STANDARD

No deviation

5.6 EUT OPERATING CONDITIONS

The EUT was configured for testing in a typical fashion (as a customer would normally use it). The EUT has been programmed to continuously transmit during test. This operating condition was tested and used to collect the included data.



5.7 TEST RESULTS

E.U.T	Bluetooth Keyboard	Model Name	SK-2770
Temperature	26°C	Relative Humidity	46%
Test Voltage	DC 3.7V		
Test Mode	Bluetooth/1 Mbps		

Channel of Worst Data			
The max. radio frequency power in any 100kHz bandwidth outside the frequency band		The max. radio frequency power in any 100 kHz bandwidth within the frequency band.	
FREQUENCY(MHz)	POWER(dBm)	FREQUENCY(MHz)	POWER(dBm)
2397.00	-59.86	2496.00	-59.68
Result			
In any 100kHz bandwidth outside the frequency band, the radio frequency power is at least 20dB below that in the 100kHz bandwidth within the band that contains the highest level of the desired power.			



Bluetooth/The max. radio frequency power in any 100kHz bandwidth outside the frequency band



*RBW 100 kHz Marker 3 [T1] -59.86 dBm
*VBW 100 kHz
SWT 10 ms 2.397000000 GHz

Ref 10 dBm *Att 20 dB

1 PK VIEW

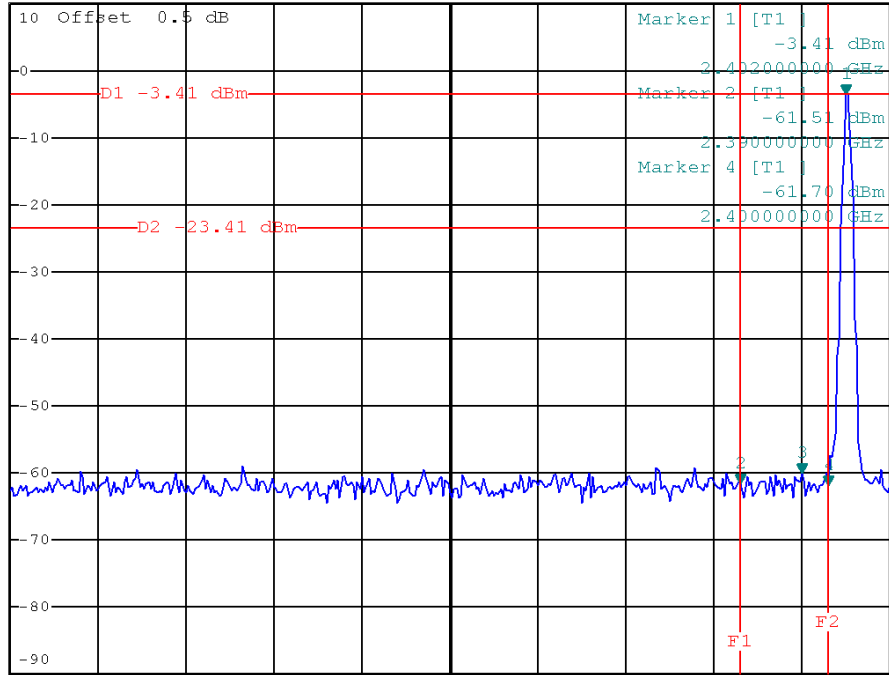

Center 2.357 GHz 10 MHz/ Span 100 MHz

Bluetooth/The max. radio frequency power in any 100 kHz bandwidth within the frequency band



*RBW 100 kHz Marker 3 [T1] -59.68 dBm
*VBW 100 kHz
SWT 10 ms 2.496000000 GHz

Ref 10 dBm *Att 20 dB

1 PK VIEW

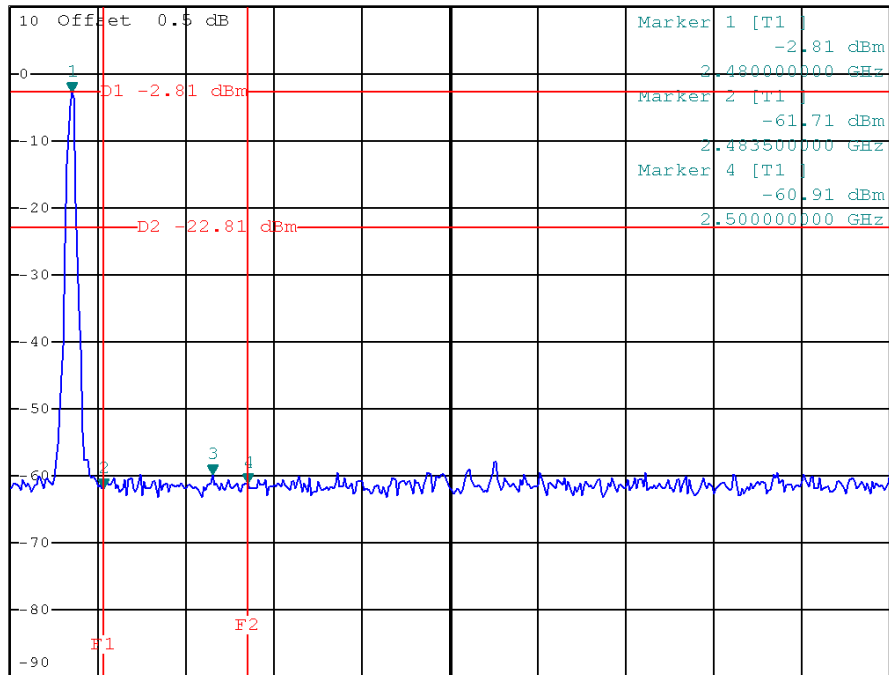

Center 2.523 GHz 10 MHz/ Span 100 MHz



Bluetooth/2402 MHz/10 Harmonic of the frequency

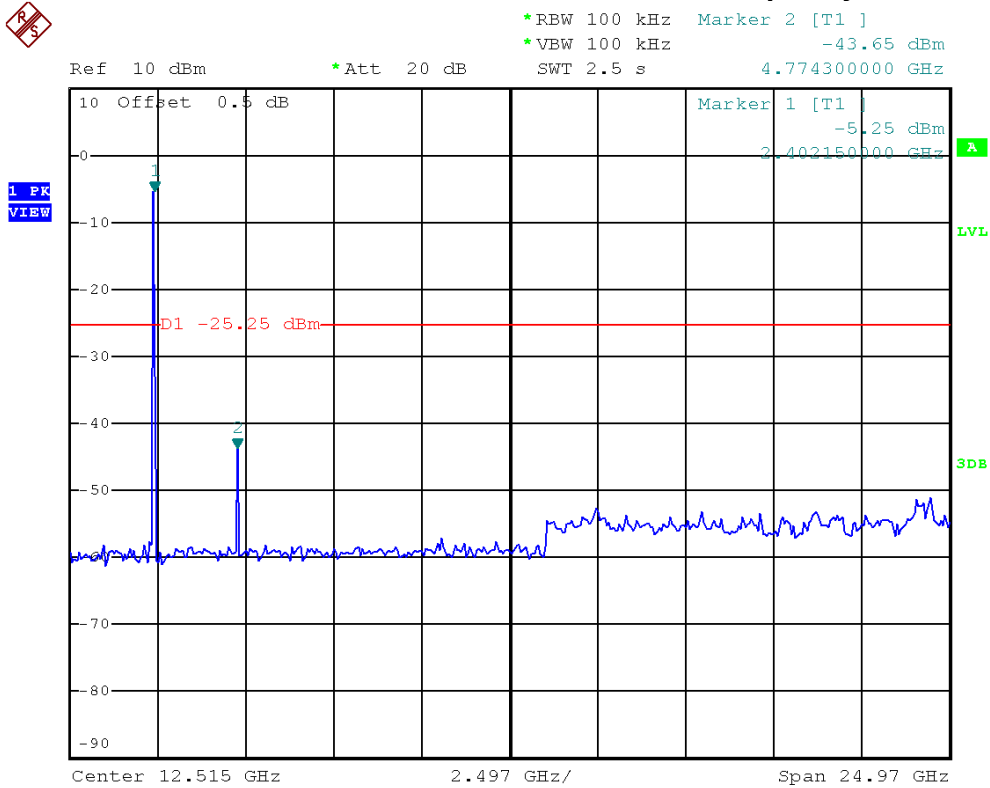

Bluetooth/2441 MHz/10 Harmonic of the frequency

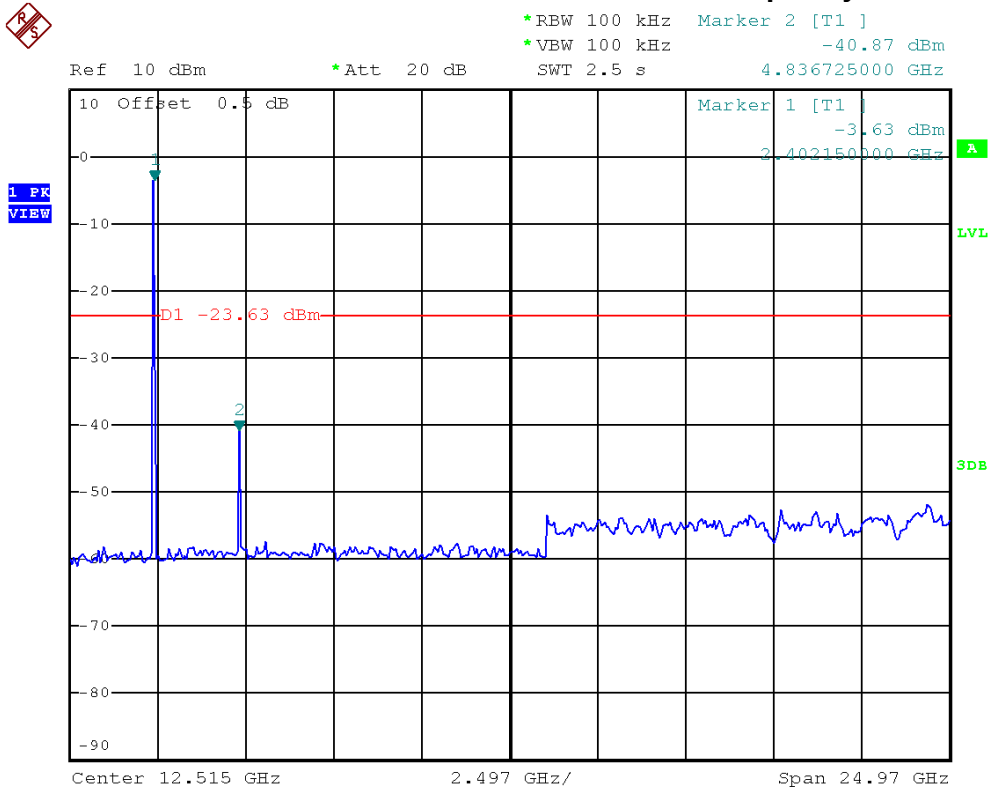



Bluetooth/2480 MHz/10 Harmonic of the frequency



*RBW 100 kHz Marker 2 [T1]
*VBW 100 kHz -44.24 dBm
SWT 2.5 s 4.961575000 GHz

Ref 10 dBm

*Att 20 dB

1 PK
VIEW

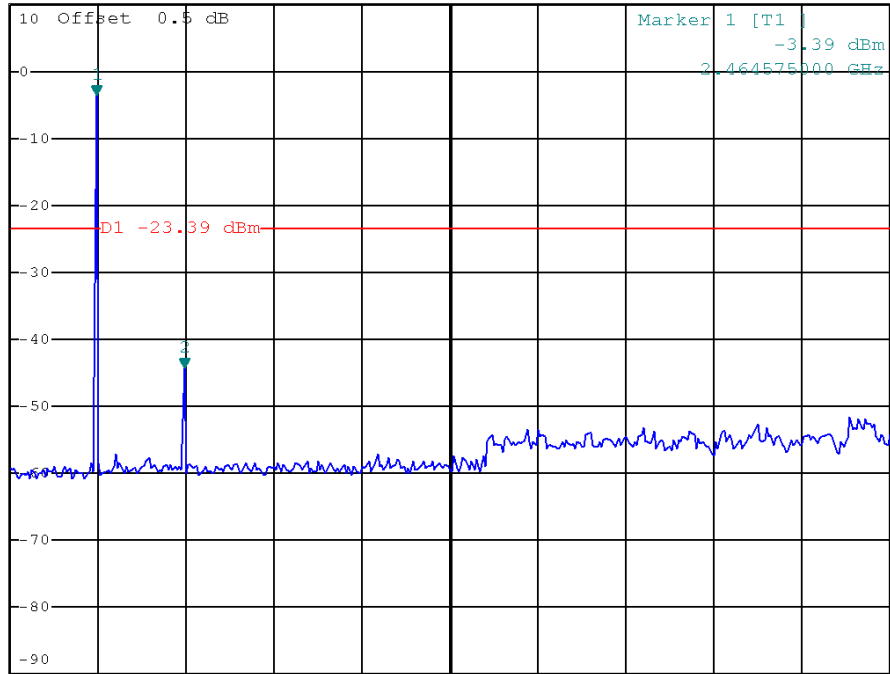

Center 12.515 GHz

2.497 GHz/

Span 24.97 GHz



6 HOPPING CHANNEL SEPARATION

6.1 LIMIT

Frequency hopping systems operating in the 2400-2483.5 MHz band may have hopping channel carrier frequencies that are separated by 25 kHz or two-thirds of the 20 dB bandwidth of the hopping channel, whichever is greater.

6.2 MEASUREMENT INSTRUMENTS LIST

Item	Kind of Equipment	Manufacturer	Type No.	Serial No.	Calibrated until
1	Spectrum Analyzer	R&S	FSP-40	100129	Oct. 01, 2013

NOTE: **N/A**: denotes No Model Name, No Serial No. or No Calibration specified.

6.3 MEASURING INSTRUMENTS SETTING

EMI Test Receiver	Parameter Setting
Attenuation	Auto
Span Frequency	> Measurement Bandwidth or Channel Separation
RB	30 kHz (20dB Bandwidth) / 100 kHz (Channel Separation)
VB	100 kHz (20dB Bandwidth) / 300 kHz (Channel Separation)
Detector	Peak
Trace	Max Hold
Sweep Time	Auto

6.4 TEST PROCEDURES

- a. The transmitter output (antenna port) was connected to the spectrum analyser in peak hold mode.
- b. The resolution bandwidth of 30 kHz and the video bandwidth of 100 kHz were utilised for 20 dB bandwidth measurement.
- c. The resolution bandwidth of 100 kHz and the video bandwidth of 300 kHz were utilised for channel separation measurement.

6.5 TEST SETUP LAYOUT



6.6 DEVIATION FROM TEST STANDARD

No deviation

6.7 EUT OPERATING CONDITIONS

The EUT tested system was configured as the statements of 5.6 Unless otherwise a special operating condition is specified in the follows during the testing.



6.8 TEST RESULTS

E.U.T	Bluetooth Keyboard	Model Name	SK-2770
Temperature	26°C	Relative Humidity	46%
Test Voltage	DC 3.7V		
Test Mode	Bluetooth/2402 MHz, 2441 MHz, 2480 MHz		

Frequency	Channel Separation (MHz)	20 dB Bandwidth (MHz)	99% Occupied Bandwidth (MHz)	Two-thirds of the 20 dB Bandwidth	Result
2402 MHz	1.07	1.042	0.930	0.695	PASS
2441 MHz	1.01	1.035	0.930	0.690	PASS
2480 MHz	0.93	1.022	0.920	0.682	PASS

NOTE: Ch. Separation Limits: >25 KHz or >2/3 of 20dB bandwidth



Bluetooth/2402 MHz/Channel Separation



*RBW 30 kHz Delta 1 [T2]
 *VBW 100 kHz 0.10 dB
 *SWT 20 ms 1.065000000 MHz

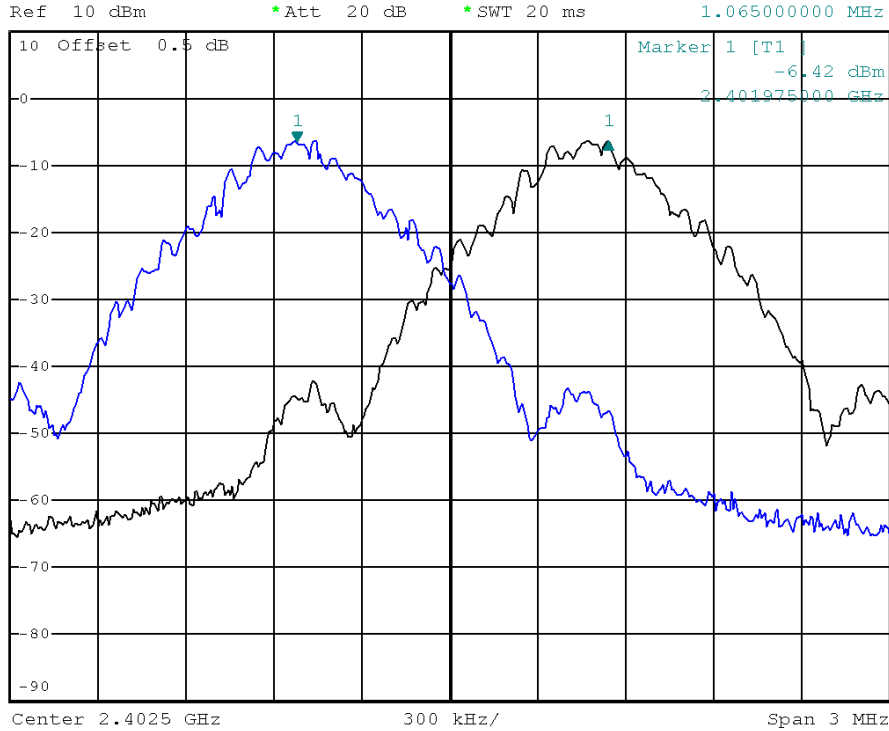

Bluetooth/2402 MHz/20dB Bandwidth



*RBW 30 kHz Delta 1 [T1]
 *VBW 300 kHz -0.32 dB
 SWT 2.5 ms 1.042394015 MHz

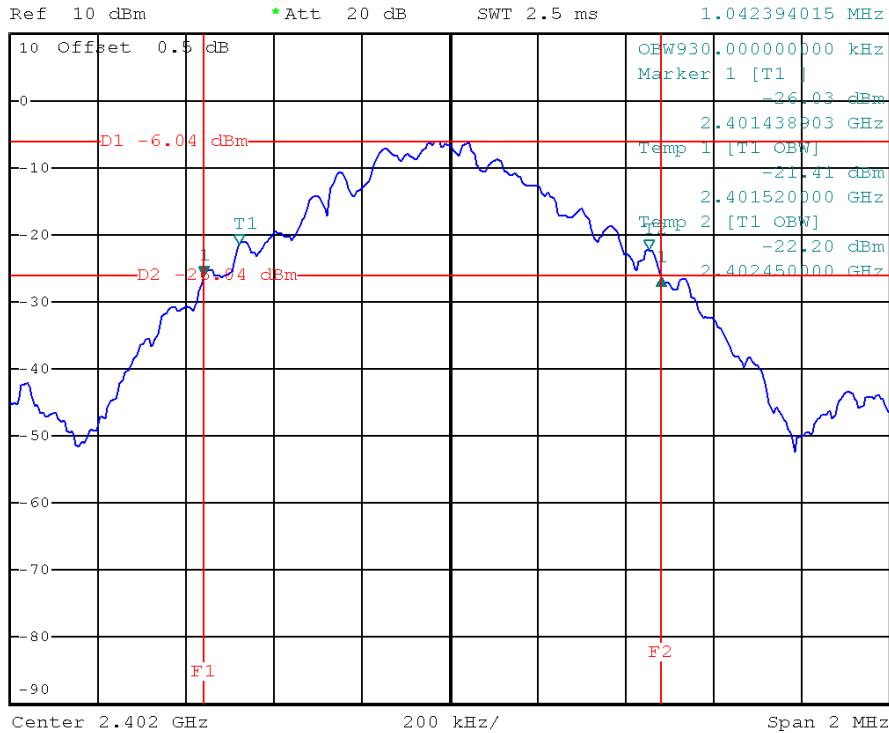



Bluetooth/2441 MHz/Channel Separation

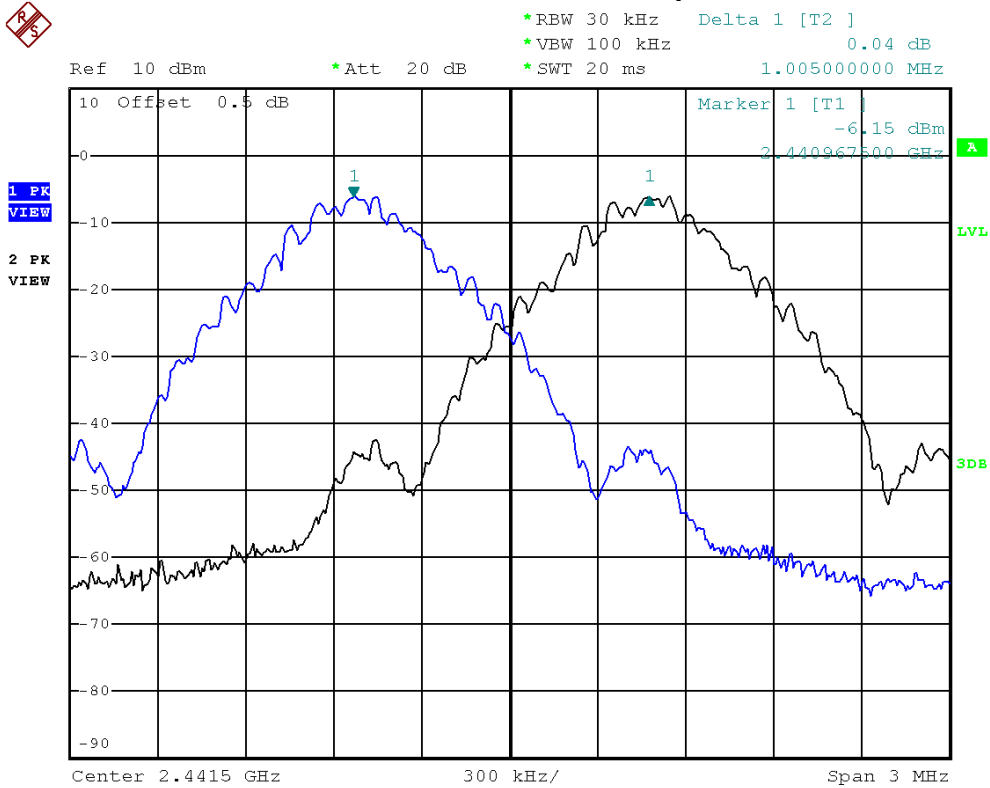

Bluetooth/2441 MHz/20dB Bandwidth

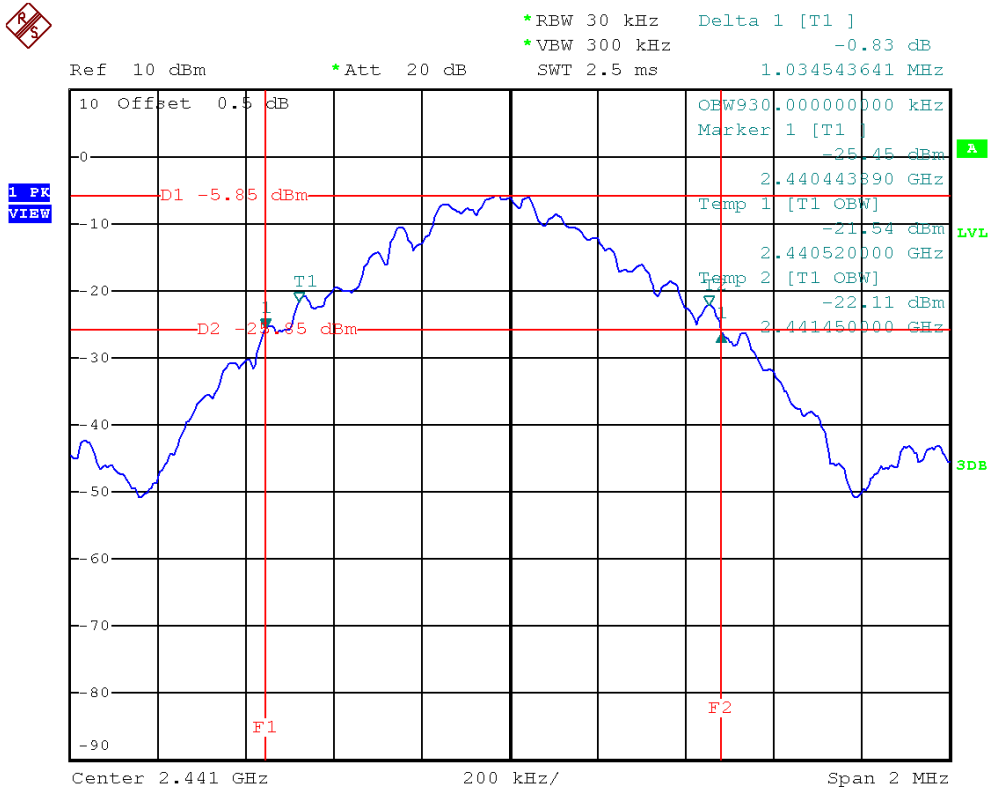



Bluetooth/2480 MHz/Channel Separation



*RBW 30 kHz Delta 1 [T2]
 *VBW 100 kHz 0.02 dB
 *Att 20 dB
 *SWT 20 ms 930.000000000 kHz

Ref 10 dBm

1 PK VIEW
2 PK VIEW

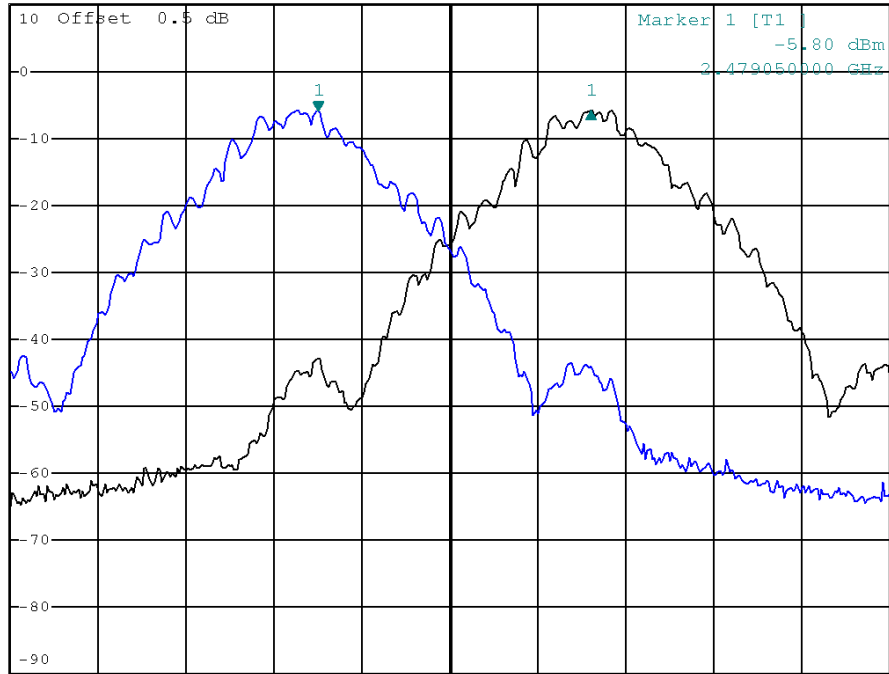

Center 2.4795 GHz 300 kHz/ Span 3 MHz

Bluetooth/2480 MHz/20dB Bandwidth



*RBW 30 kHz Delta 1 [T1]
 *VBW 300 kHz 0.16 dB
 *Att 20 dB
 SWT 2.5 ms 1.022443890 MHz

Ref 10 dBm

1 PK VIEW

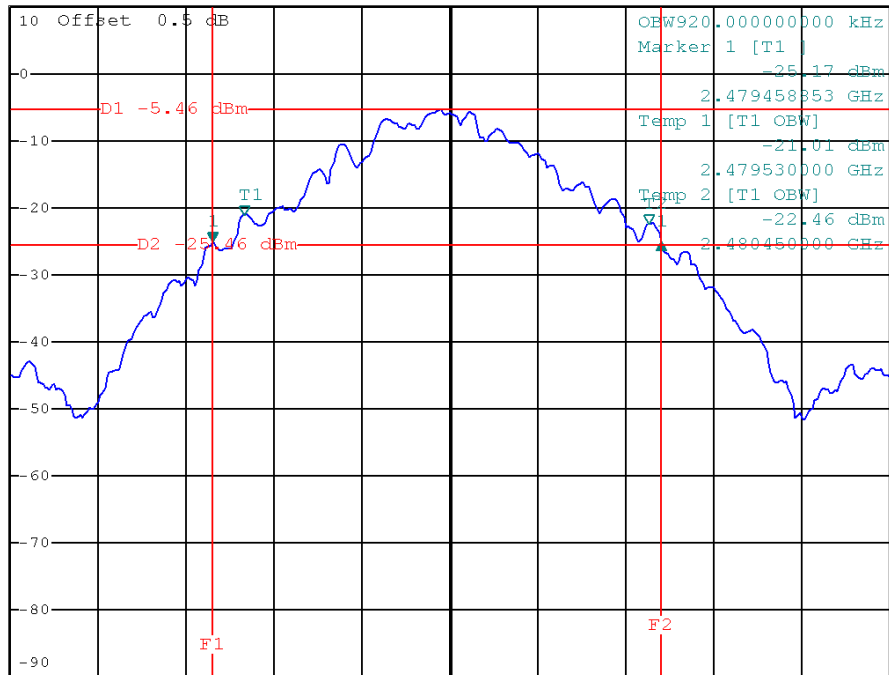

Center 2.48 GHz 200 kHz/ Span 2 MHz



7 MAXIMUM PEAK CONDUCTED OUTPUT POWER

7.1 LIMIT

Test Item	Frequency Range (MHz)	Limit
Maximum Peak Conducted Output Power	2400-2483.5	1 watt or 30 dBm

7.2 MEASUREMENT INSTRUMENTS LIST

Item	Kind of Equipment	Manufacturer	Type No.	Serial No.	Calibrated until
1	Spectrum Analyzer	R&S	FSP-40	100129	Oct. 01, 2013

NOTE: **N/A**: denotes No Model Name, No Serial No. or No Calibration specified.

7.3 TEST PROCEDURES

- a. The EUT was directly connected to the spectrum analyzer and antenna output port as show in the block diagram below,
- b. Spectrum Setting: RBW= 3 MHz, VBW= 3 MHz, Sweep time = Auto.

7.4 TEST SETUP LAYOUT



7.5 DEVIATION FROM TEST STANDARD

No deviation

7.6 EUT OPERATING CONDITIONS

The EUT tested system was configured as the statements of 5.6 Unless otherwise a special operating condition is specified in the follows during the testing.



7.7 TEST RESULTS

E.U.T	Bluetooth Keyboard	Model Name	SK-2770
Temperature	26°C	Relative Humidity	46%
Test Voltage	DC 3.7V		
Test Mode	Bluetooth/2402 MHz, 2441 MHz, 2480 MHz		

Frequency	Peak Output Power (dBm)	LIMIT (dBm)	Result
2402 MHz	-2.22	30	PASS
2441 MHz	-2.21	30	PASS
2480 MHz	-2.00	30	PASS

Bluetooth/2402 MHz/Peak Output Power

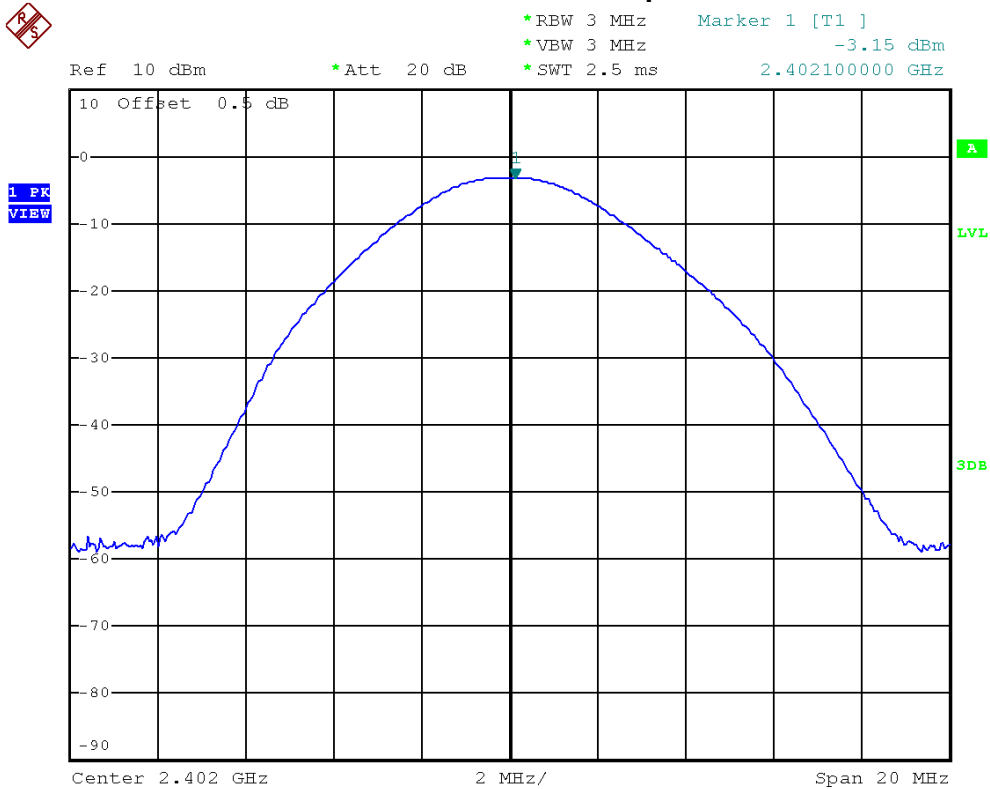



Bluetooth/2441 MHz/Peak Output Power

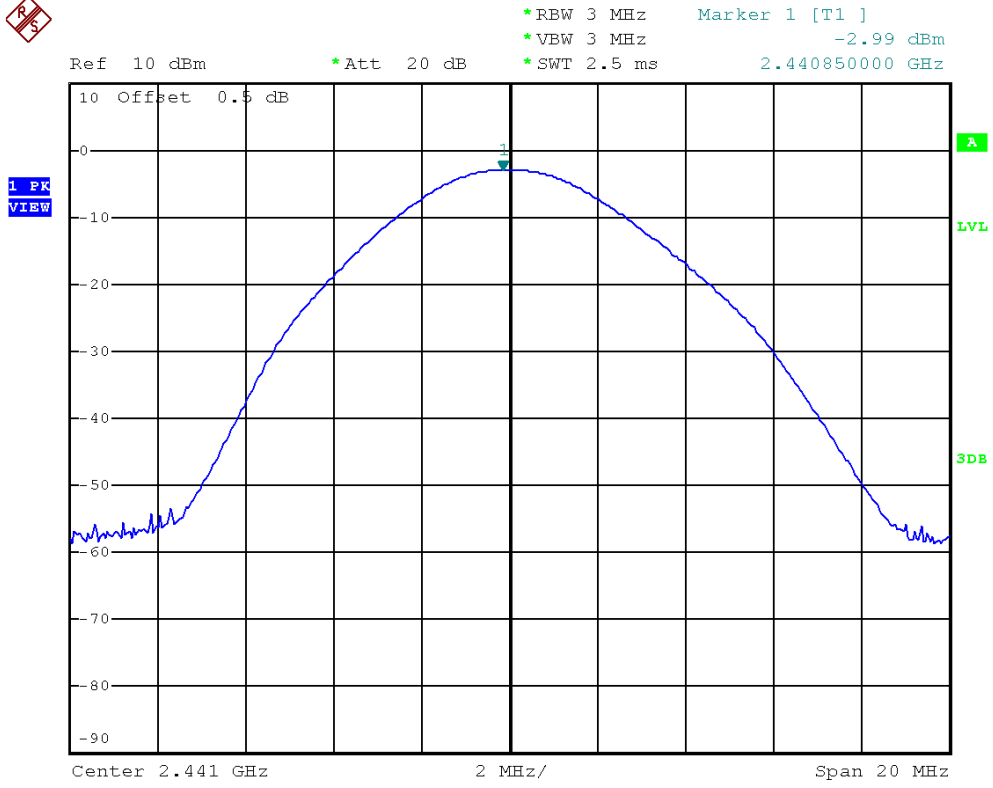

Bluetooth/2480 MHz/Peak Output Power

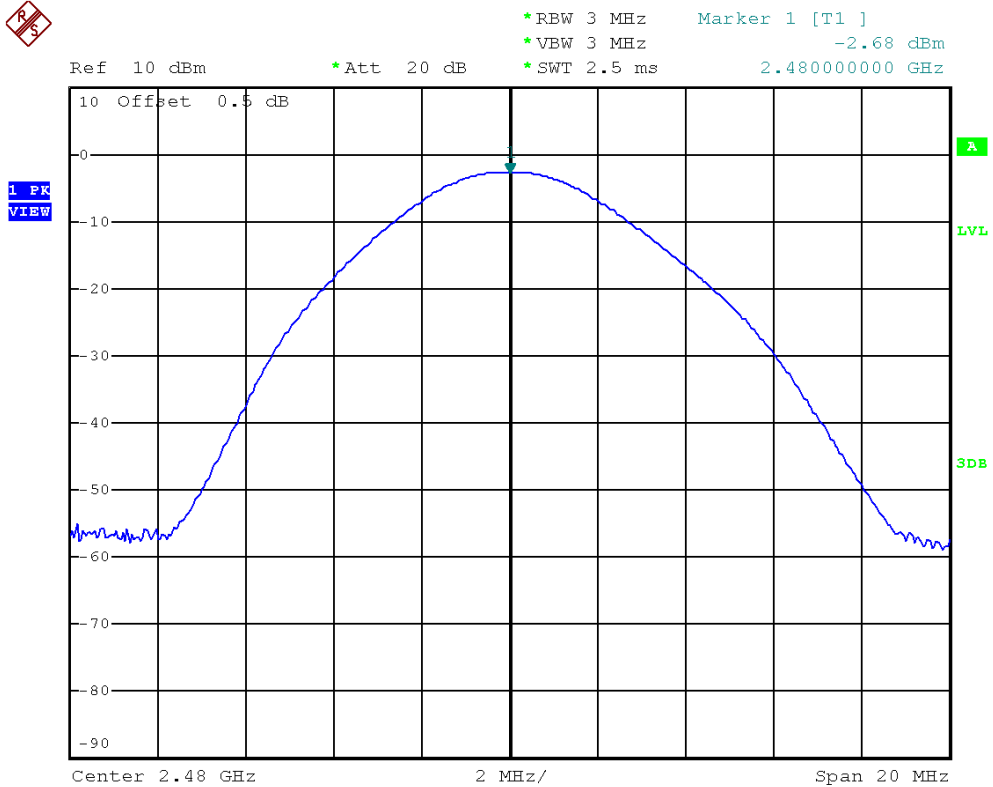



8 RADIATED SPURIOUS EMISSION (9 KHZ TO 1 GHZ)

8.1 LIMIT

20 dB in any 100 kHz bandwidth outside the operating frequency band. In case the emission fall within the restricted band specified on 15.205(a), then the 15.209(a) limit in the table below has to be followed.

Frequency Range: 9 kHz to 1 GHz		
FREQUENCY (MHz)	Field Strength (micровolts/meter)	Measurement Distance (meters)
0.009~0.490	2400/F(kHz)	300
0.490~1.705	24000/F(kHz)	30
1.705~30.0	30	30
30~88	100	3
88~216	150	3
216~960	200	3
Above 960	500	3

Frequency Range: above 1 GHz				
FREQUENCY (MHz)	Class A (dBuV/m) (at 3m)		Class B (dBuV/m) (at 3m)	
	PEAK	AVERAGE	PEAK	AVERAGE
above 1 GHz	80	60	74	54

NOTE:

- (1) The limit for radiated test was performed according to FCC PART 15B.
- (2) The tighter limit applies at the band edges.
- (3) Emission level (dBuV/m)=20log Emission level (uV/m).
- (4) The test result calculated as following:
 Measurement Value = Reading Level + Correct Factor
 Correct Factor = Antenna Factor + Cable Loss – Amplifier Gain(if use)
 Margin Level = Measurement Value – Limit Value



8.2 MEASUREMENT INSTRUMENTS LIST

Item	Kind of Equipment	Manufacturer	Type No.	Serial No.	Calibrated until
1	Spectrum Analyzer	R&S	FSP-40	100129	Oct. 01, 2013
2	Horn Antenna	Schwarzbeck	BBHA 9120	D-325	Apr. 15, 2014
3	Microwave Pre_amplifier	Agilent	8449B	3008A01714	Apr. 16, 2014
4	Microflex Cable	Harbour industries	27478LL142	1m	May. 13, 2014
5	Microflex Cable	EMC	S104-SMA	8m	May. 13, 2014
6	Microflex Cable	Harbour industries	27478LL142	3m	May. 13, 2014
7	Test Cable	LMR	LMR-400	12m	May. 14, 2014
8	Test Cable	LMR	LMR-400	3m	May. 14, 2014
9	Pre-Amplifier	Anritsu	MH648A	M92649	Jun. 18, 2014
10	Log-Bicon Antenna	Schwarzbeck	VULB9168-352	9168-352	Jun. 11, 2014
11	Preamplifier With Adaptor	EMC	EMC2654045	980030	Feb. 18, 2014
12	Horn Antenna	Schwarzbeck	BBHA 9170	187	Dec. 24, 2013

Remark: "N/A" denotes No Model Name, No Serial No. or No Calibration specified.

8.3 MEASURING INSTRUMENTS SETTING

EMI Test Receiver	Parameter Setting
Attenuation	Auto
Start ~ Stop Frequency	9kHz~150kHz / RB 200Hz for QP
Start ~ Stop Frequency	150kHz~30MHz / RB 9kHz for QP
Start ~ Stop Frequency	30MHz~1000MHz / RB 120kHz for QP



8.4 TEST PROCEDURES

- a. The measuring distance of at 3 m shall be used for measurements at frequency up to 1 GHz. For frequencies above 1 GHz, any suitable measuring distance may be used.
- b. The EUT was placed on the top of a rotating table 0.8 meters above the ground at a 3m Semi-anechoic chamber. The table was rotated 360 degrees to determine the position of the highest radiation.
- c. The height of the equipment or of the substitution antenna shall be 0.8 m; the height of the test antenna shall vary between 1 m to 4 m. Both horizontal and vertical polarizations of the antenna are set to make the measurement.
- d. The initial step in collecting conducted emission data is a spectrum analyzer peak detector mode pre-scanning the measurement frequency range. Significant peaks are then marked and then Quasi Peak detector mode re-measured.
- e. If the Peak Mode measured value compliance with and lower than Quasi Peak Mode Limit, the EUT shall be deemed to meet QP Limits and then no additional QP Mode measurement performed.
- f. For the actual test configuration, please refer to the related Item –EUT Test Photos.
- g. The testing follows the guidelines in ANSI C63.4 and FCC Public Notice DA 00-705 Measurement Guidelines. In case the emission is fail due to the used RBW/VBW is too wide, marker-delta method of FCC Public Notice DA 00-705 will be followed.

NOTE:

- a. Reading in which marked as QP or Peak means measurements by using are Quasi-Peak Mode with Detector BW=120 kHz; SPA setting in RBW=100 kHz, VBW =100 kHz, Swp. Time = 0.3 sec./ MHz.
- b. All readings are Peak unless otherwise stated QP in column of Note. Peak denotes that the Peak reading compliance with the QP Limits and then QP Mode measurement didn't perform.

8.5 DEVIATION FROM TEST STANDARD

No deviation

8.6 TEST SETUP LAYOUT

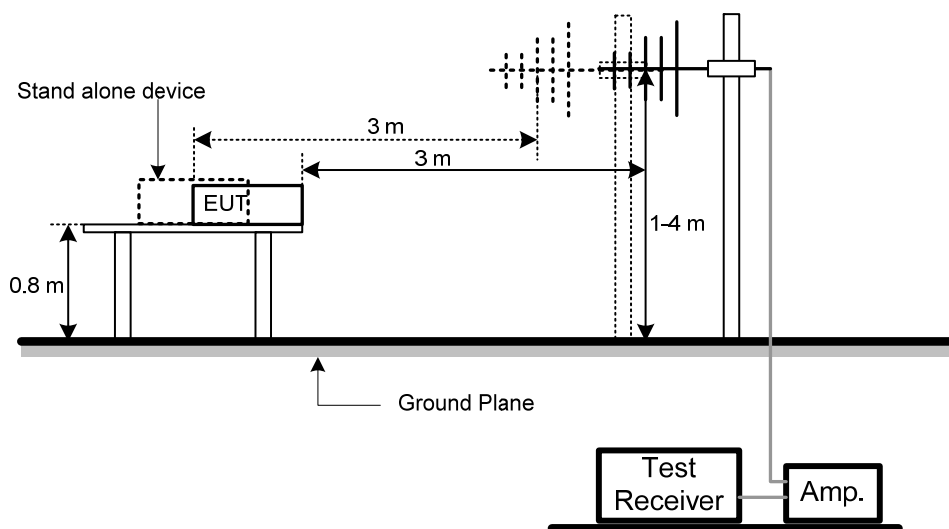



8.7 EUT OPERATING CONDITIONS

The EUT tested system was configured as the statements of 5.6 Unless otherwise a special operating condition is specified in the follows during the testing.



8.8 TEST RESULTS

E.U.T	Bluetooth Keyboard	Model Name	SK-2770
Temperature	26°C	Relative Humidity	60%
Test Voltage	DC 3.7V		
Test Mode	Bluetooth/2441 MHz		

Polarization: Vertical

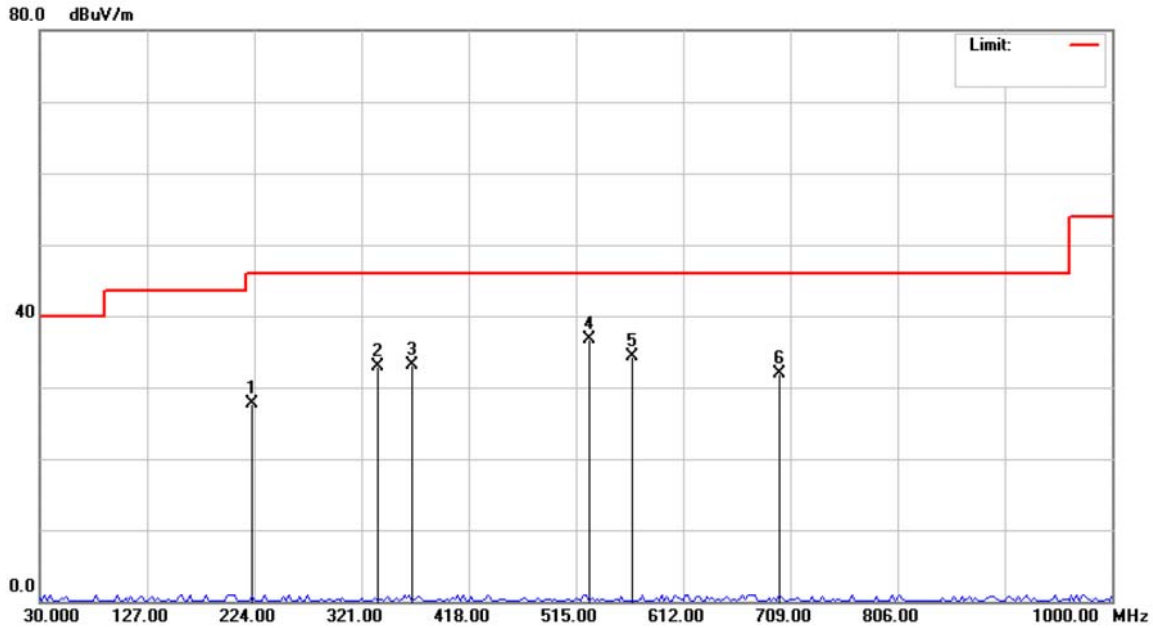

No. Mk.	Freq. MHz	Reading Level dBuV	Correct Factor dB	Measurement dBuV/m	Limit dBuV/m	Over dB	Detector	Comment
1	221.5749	45.98	-18.20	27.78	46.00	-18.22	peak	
2	335.5499	46.45	-13.47	32.98	46.00	-13.02	peak	
3	367.0750	46.12	-13.00	33.12	46.00	-12.88	peak	
4 *	527.1250	45.84	-9.21	36.63	46.00	-9.37	peak	
5	565.9249	42.56	-8.22	34.34	46.00	-11.66	peak	
6	699.2999	38.74	-6.87	31.87	46.00	-14.13	peak	



E.U.T	Bluetooth Keyboard	Model Name	SK-2770
Temperature	26°C	Relative Humidity	60%
Test Voltage	DC 3.7V		
Test Mode	Bluetooth/2441 MHz		

Polarization: Horizontal

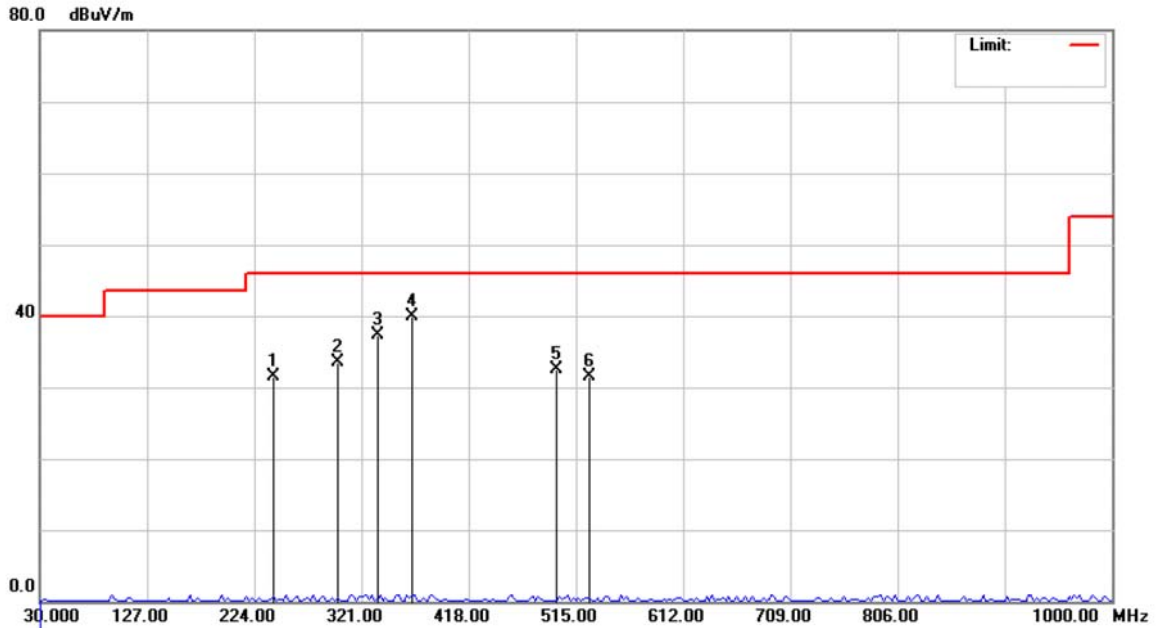

No. Mk.	Freq. MHz	Reading Level dBuV	Correct Factor dB	Measurement dBuV/m	Limit dBuV/m	Over dB	Detector	Comment
1	240.9750	48.00	-16.40	31.60	46.00	-14.40	peak	
2	299.1749	48.11	-14.57	33.54	46.00	-12.46	peak	
3	335.5499	50.68	-13.47	37.21	46.00	-8.79	peak	
4 *	367.0750	52.91	-13.00	39.91	46.00	-6.09	peak	
5	498.0249	42.26	-9.81	32.45	46.00	-13.55	peak	
6	527.1250	40.63	-9.21	31.42	46.00	-14.58	peak	



9 RADIATED SPURIOUS EMISSION (ABOVE 1 GHz)

9.1 LIMIT

20dBc in any 100 kHz bandwidth outside the operating frequency band. In case the emission fall within the restricted band specified on 15.205(a), then the 15.209(a) limit in the table below has to be followed.

Frequency Range: 9 kHz to 1 GHz		
FREQUENCY (MHz)	Field Strength (micровolts/meter)	Measurement Distance (meters)
0.009~0.490	2400/F(kHz)	300
0.490~1.705	24000/F(kHz)	30
1.705~30.0	30	30
30~88	100	3
88~216	150	3
216~960	200	3
Above 960	500	3

Frequency Range: above 1 GHz				
FREQUENCY (MHz)	Class A (dBuV/m) (at 3m)		Class B (dBuV/m) (at 3m)	
	PEAK	AVERAGE	PEAK	AVERAGE
above 1 GHz	80	60	74	54

NOTE:

- (1) The limit for radiated test was performed according to FCC PART 15B.
- (2) The tighter limit applies at the band edges.
- (3) Emission level (dBuV/m)=20log Emission level (uV/m).
- (4) The test result calculated as following:
 Measurement Value = Reading Level + Correct Factor
 Correct Factor = Antenna Factor + Cable Loss – Amplifier Gain(if use)
 Margin Level = Measurement Value – Limit Value



9.2 MEASUREMENT INSTRUMENTS LIST

Item	Kind of Equipment	Manufacturer	Type No.	Serial No.	Calibrated until
1	Spectrum Analyzer	R&S	FSP-40	100129	Oct. 01, 2013
2	Horn Antenna	Schwarzbeck	BBHA 9120	D-325	Apr. 15, 2014
3	Microwave Pre_amplifier	Agilent	8449B	3008A01714	Apr. 16, 2014
4	Microflex Cable	Harbour industries	27478LL142	1m	May. 13, 2014
5	Microflex Cable	EMC	S104-SMA	8m	May. 13, 2014
6	Microflex Cable	Harbour industries	27478LL142	3m	May. 13, 2014
7	Test Cable	LMR	LMR-400	12m	May. 14, 2014
8	Test Cable	LMR	LMR-400	3m	May. 14, 2014
9	Pre-Amplifier	Anritsu	MH648A	M92649	Jun. 18, 2014
10	Log-Bicon Antenna	Schwarzbeck	VULB9168-352	9168-352	Jun. 11, 2014
11	Preamplifier With Adaptor	EMC	EMC2654045	980030	Feb. 18, 2014
12	Horn Antenna	Schwarzbeck	BBHA 9170	187	Dec. 24, 2013

Remark: "N/A" denotes No Model Name, No Serial No. or No Calibration specified.

9.3 MEASURING INSTRUMENTS SETTING

Spectrum Analyzer	Parameter Setting
Attenuation	Auto
Start Frequency	1000 MHz
Stop Frequency	10th carrier harmonic
RB / VB (emission in restricted band)	1MHz / 1MHz for Peak, 1 MHz / 10Hz for Average
RB / VB (other emission)	1MHz / 1MHz for Peak, 1 MHz / 10Hz for Average



9.4 TEST PROCEDURES

- a. The measuring distance of at 3 m shall be used for measurements at frequency up to 1 GHz. For frequencies above 1 GHz, any suitable measuring distance may be used.
- b. The EUT was placed on the top of a rotating table 0.8 meters above the ground at a 3m Semi-anechoic chamber. The table was rotated 360 degrees to determine the position of the highest radiation.
- c. The height of the equipment or of the substitution antenna shall be 0.8 m; the height of the test antenna shall vary between 1 m to 4 m. Both horizontal and vertical polarizations of the antenna are set to make the measurement.
- d. The initial step in collecting conducted emission data is a spectrum analyzer peak detector mode pre-scanning the measurement frequency range. Significant peaks are then marked and then Quasi Peak detector mode re-measured.
- e. If the Peak Mode measured value compliance with and lower than Quasi Peak Mode Limit, the EUT shall be deemed to meet QP Limits and then no additional QP Mode measurement performed.
- f. For the actual test configuration, please refer to the related Item –EUT Test Photos.
- g. The testing follows the guidelines in ANSI C63.4 and FCC Public Notice DA 00-705 Measurement Guidelines. In case the emission is fail due to the used RBW/VBW is too wide, marker-delta method of FCC Public Notice DA 00-705 will be followed.

NOTE:

- a. Reading in which marked as Peak means measurements by using are Peak Mode with instrument setting in RBW= 1 MHz, VBW= 1 MHz, Swp. Time = Auto.
Reading in which marked as AV means measurements by using are Average Mode with instrument setting in RBW= 1 MHz, VBW= 10 Hz, Swp. Time = Auto.
- b. All readings are Peak Mode value unless otherwise stated AVG in column of Note. If the Peak Mode Measured value compliance with the Peak Limits and lower than AVG Limits, the EUT shall be deemed to meet both Peak & AVG Limits and then only Peak Mode was measured, but AVG Mode didn't perform.

9.5 DEVIATION FROM TEST STANDARD

No deviation

9.6 TEST SETUP LAYOUT

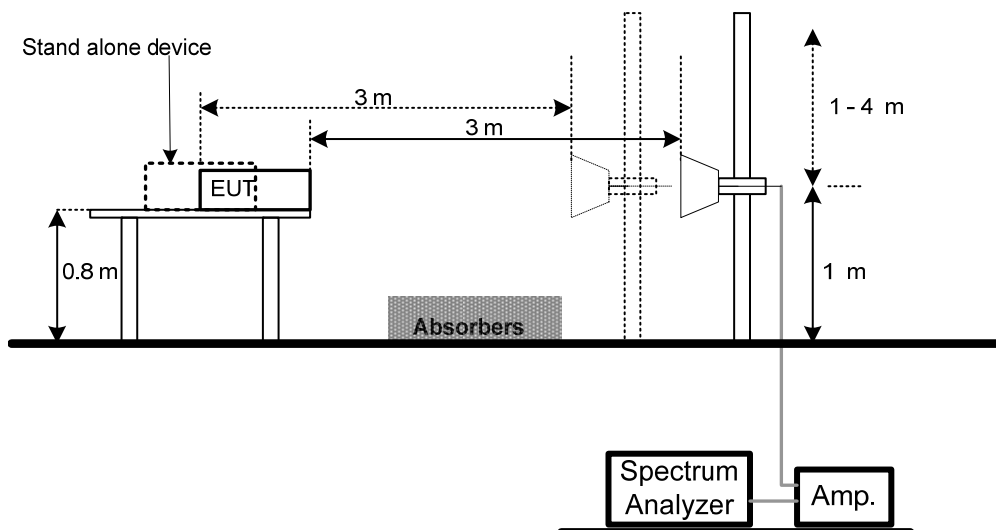



9.7 EUT OPERATING CONDITIONS

The EUT tested system was configured as the statements of 5.6 Unless otherwise a special operating condition is specified in the follows during the testing.



9.8 TEST RESULTS

E.U.T	Bluetooth Keyboard	Model Name	SK-2770
Temperature	26°C	Relative Humidity	60%
Test Voltage	DC 3.7V		
Test Mode	Bluetooth/2402 MHz		

Polarization: Vertical

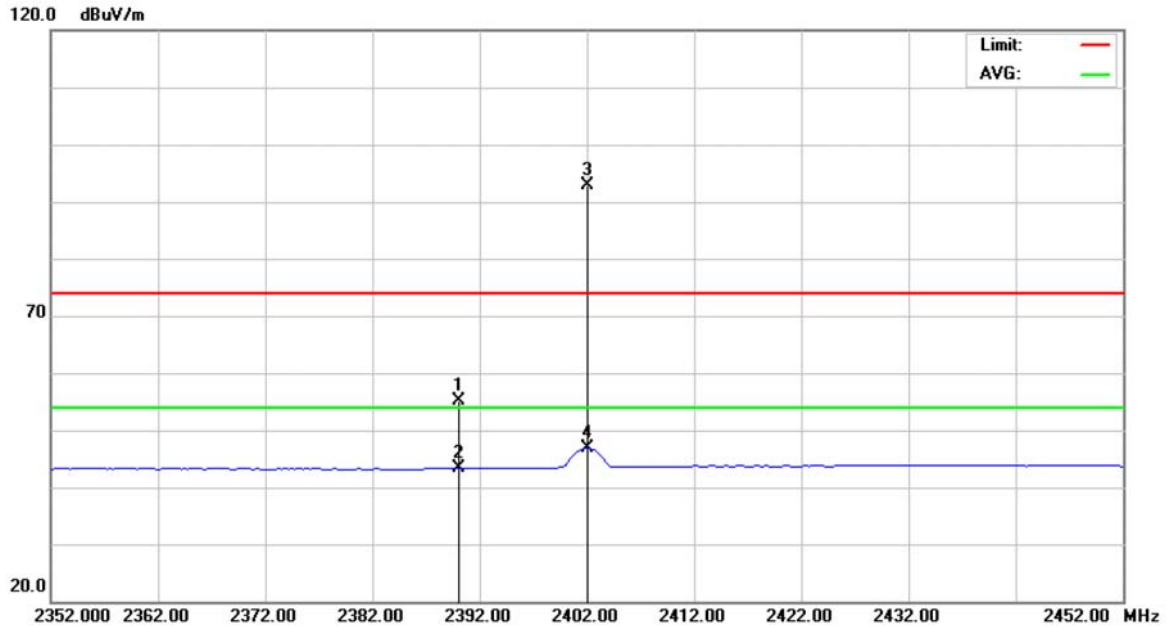

No. Mk.	Freq. MHz	Reading Level dBuV	Correct Factor dB	Measurement dBuV/m	Limit dBuV/m	Over dB	Detector	Comment
1	2390.000	23.54	31.67	55.21	74.00	-18.79	peak	
2	2390.000	11.69	31.67	43.36	54.00	-10.64	AVG	
3 *	2402.000	61.05	31.72	92.77	74.00	18.77	peak	
4	2402.000	15.13	31.72	46.85	54.00	-7.15	AVG	



E.U.T	Bluetooth Keyboard	Model Name	SK-2770
Temperature	26°C	Relative Humidity	60%
Test Voltage	DC 3.7V		
Test Mode	Bluetooth/2402 MHz		

Polarization: Vertical

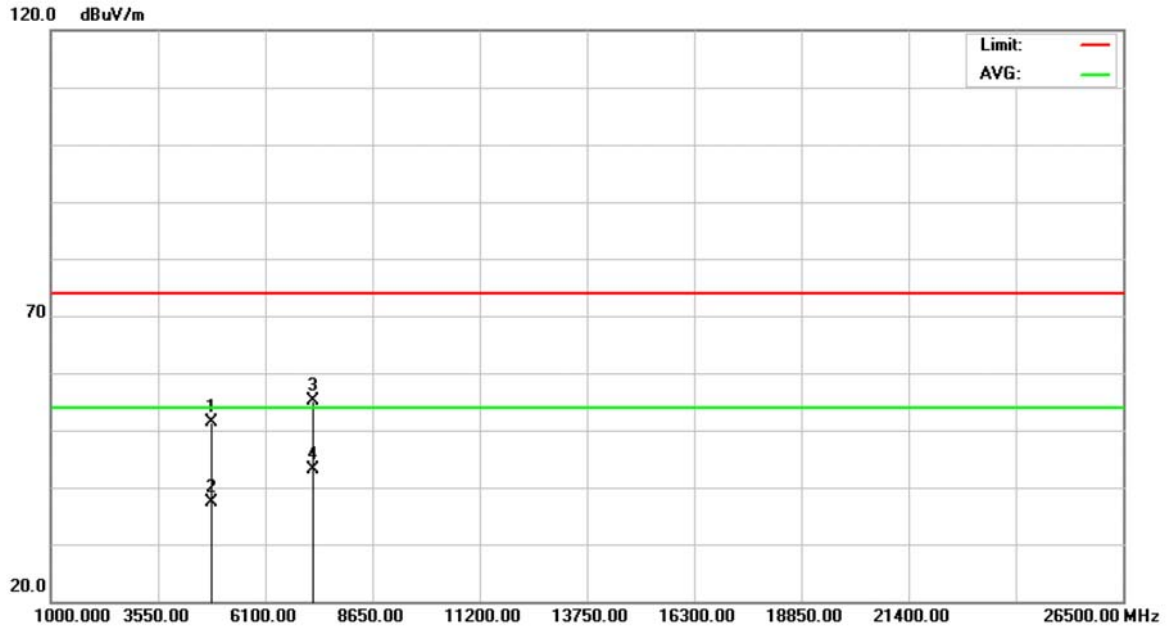

No. Mk.	Freq. MHz	Reading Level dBuV	Correct Factor dB	Measurement dBuV/m	Limit dBuV/m	Over dB	Detector	Comment
1	4804.000	45.67	5.69	51.36	74.00	-22.64	peak	
2	4804.000	31.68	5.69	37.37	54.00	-16.63	AVG	
3	7206.350	42.92	12.18	55.10	74.00	-18.90	peak	
4 *	7206.350	30.92	12.18	43.10	54.00	-10.90	AVG	



E.U.T	Bluetooth Keyboard	Model Name	SK-2770
Temperature	26°C	Relative Humidity	60%
Test Voltage	DC 3.7V		
Test Mode	Bluetooth/2402 MHz		

Polarization: Horizontal

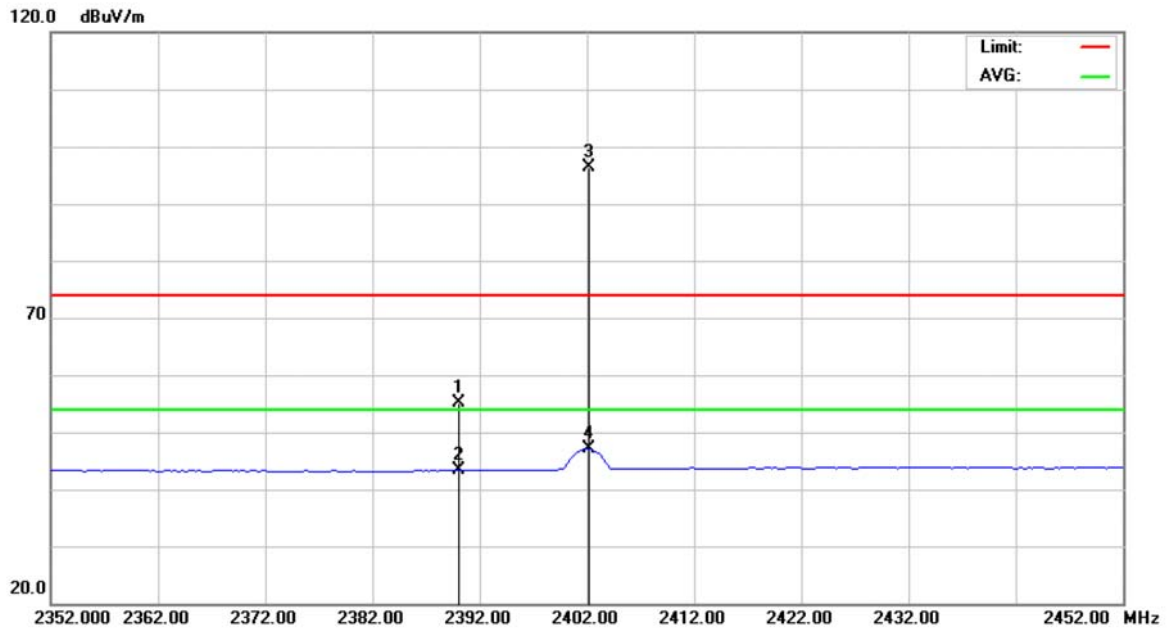

No.	Mk.	Freq. MHz	Reading Level dBuV	Correct Factor dB	Measure- ment dBuV/m	Limit dBuV/m	Over dB	Detector	Comment
1		2390.000	23.47	31.67	55.14	74.00	-18.86	peak	
2		2390.000	11.67	31.67	43.34	54.00	-10.66	AVG	
3	*	2402.250	64.66	31.72	96.38	74.00	22.38	peak	
4		2402.250	15.38	31.72	47.10	54.00	-6.90	AVG	



E.U.T	Bluetooth Keyboard	Model Name	SK-2770
Temperature	26°C	Relative Humidity	60%
Test Voltage	DC 3.7V		
Test Mode	Bluetooth/2402 MHz		

Polarization: Horizontal

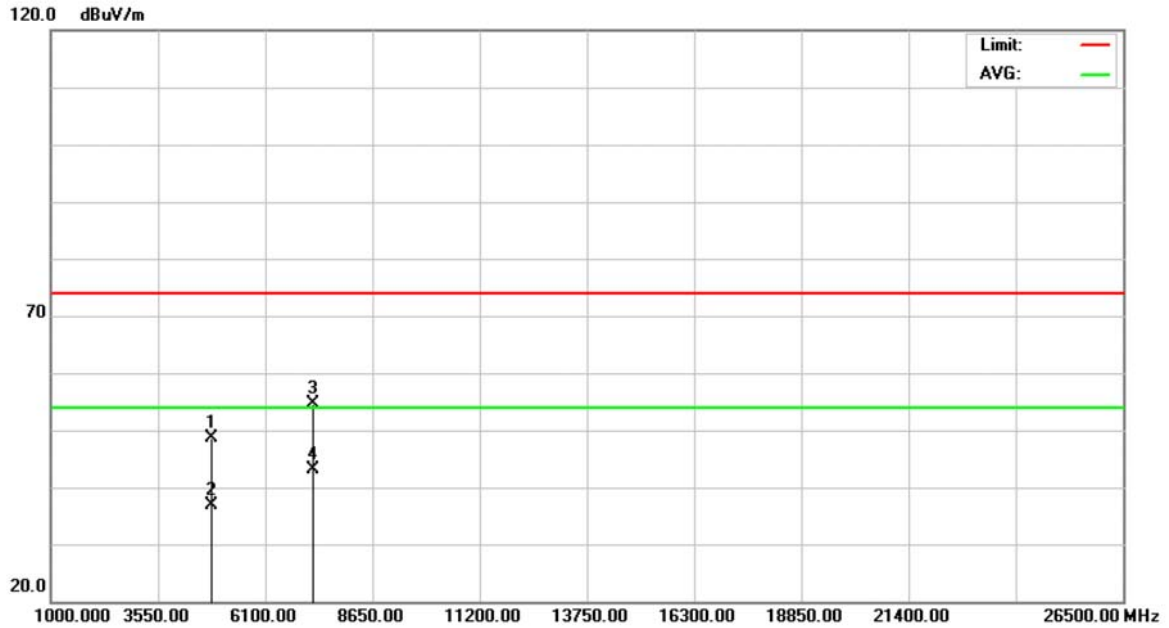

No.	Mk.	Freq. MHz	Reading Level dBuV	Correct Factor dB	Measure- ment dBuV/m	Limit dBuV/m	Over dB	Detector	Comment
1		4803.900	42.92	5.69	48.61	74.00	-25.39	peak	
2		4803.900	31.28	5.69	36.97	54.00	-17.03	AVG	
3		7205.800	42.45	12.18	54.63	74.00	-19.37	peak	
4	*	7205.800	30.93	12.18	43.11	54.00	-10.89	AVG	



E.U.T	Bluetooth Keyboard	Model Name	SK-2770
Temperature	26°C	Relative Humidity	60%
Test Voltage	DC 3.7V		
Test Mode	Bluetooth/2441 MHz		

Polarization: Vertical

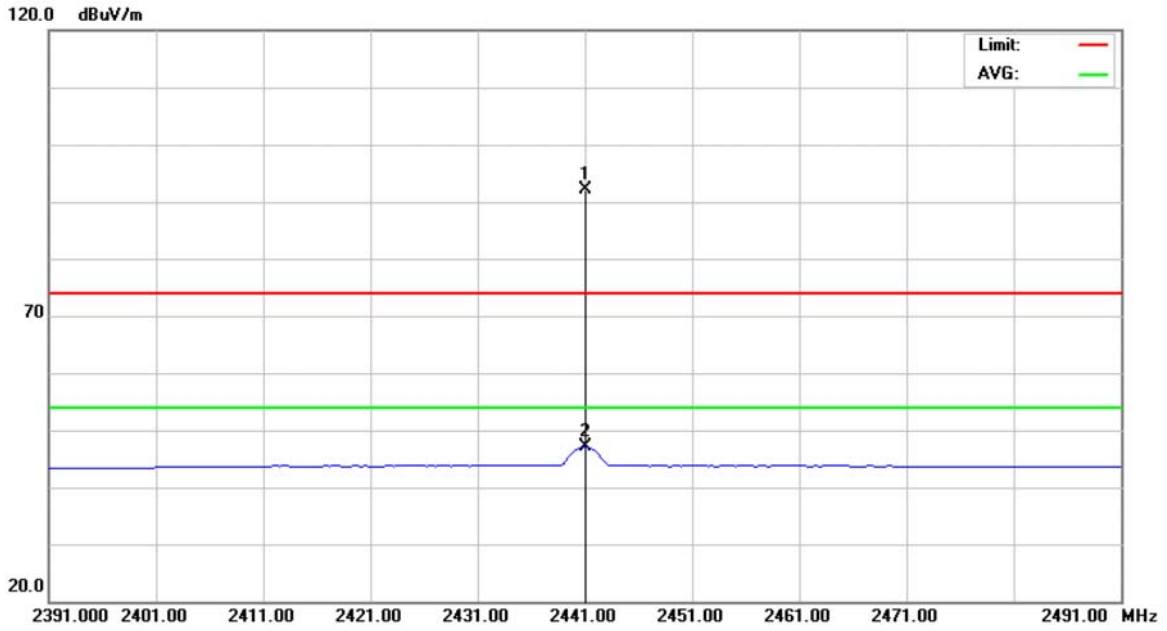

No.	Mk.	Freq. MHz	Reading Level dBuV	Correct Factor dB	Measure- ment dBuV/m	Limit dBuV/m	Over dB	Detector	Comment
1	*	2441.000	60.34	31.90	92.24	74.00	18.24	peak	
2		2441.000	15.15	31.90	47.05	54.00	-6.95	AVG	



E.U.T	Bluetooth Keyboard	Model Name	SK-2770
Temperature	26°C	Relative Humidity	60%
Test Voltage	DC 3.7V		
Test Mode	Bluetooth/2441 MHz		

Polarization: Vertical

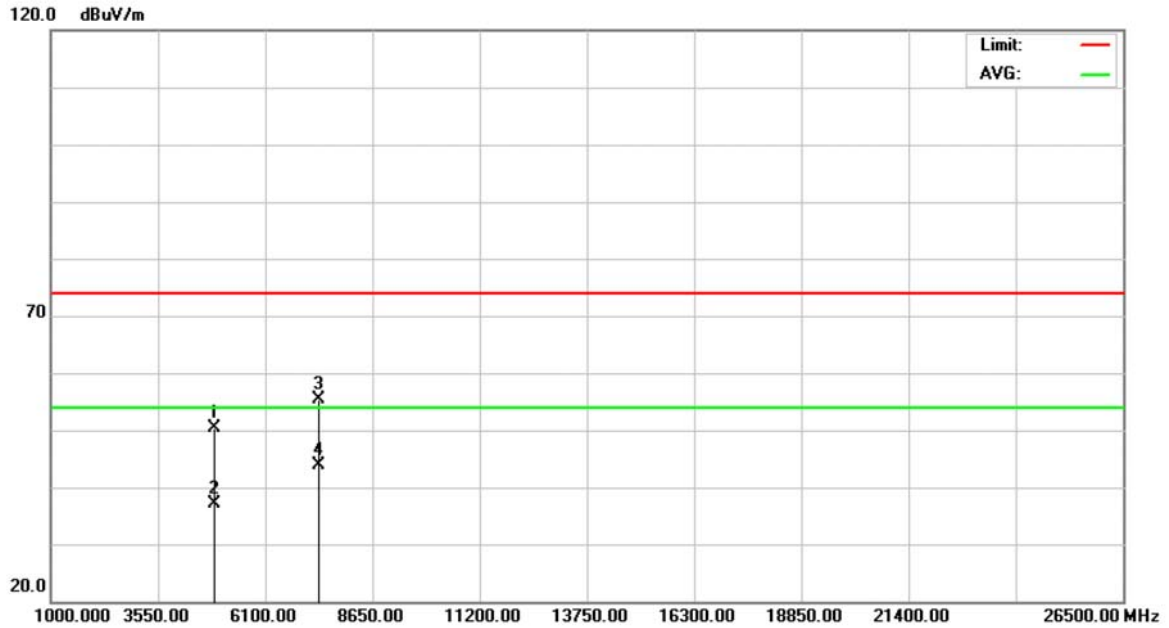

No.	Mk.	Freq. MHz	Reading Level dBuV	Correct Factor dB	Measure- ment dBuV/m	Limit dBuV/m	Over dB	Detector	Comment
1		4882.000	44.49	5.79	50.28	74.00	-23.72	peak	
2		4882.000	31.31	5.79	37.10	54.00	-16.90	AVG	
3		7323.225	42.73	12.61	55.34	74.00	-18.66	peak	
4	*	7323.225	31.38	12.61	43.99	54.00	-10.01	AVG	



E.U.T	Bluetooth Keyboard	Model Name	SK-2770
Temperature	26°C	Relative Humidity	60%
Test Voltage	DC 3.7V		
Test Mode	Bluetooth/2441 MHz		

Polarization: Horizontal

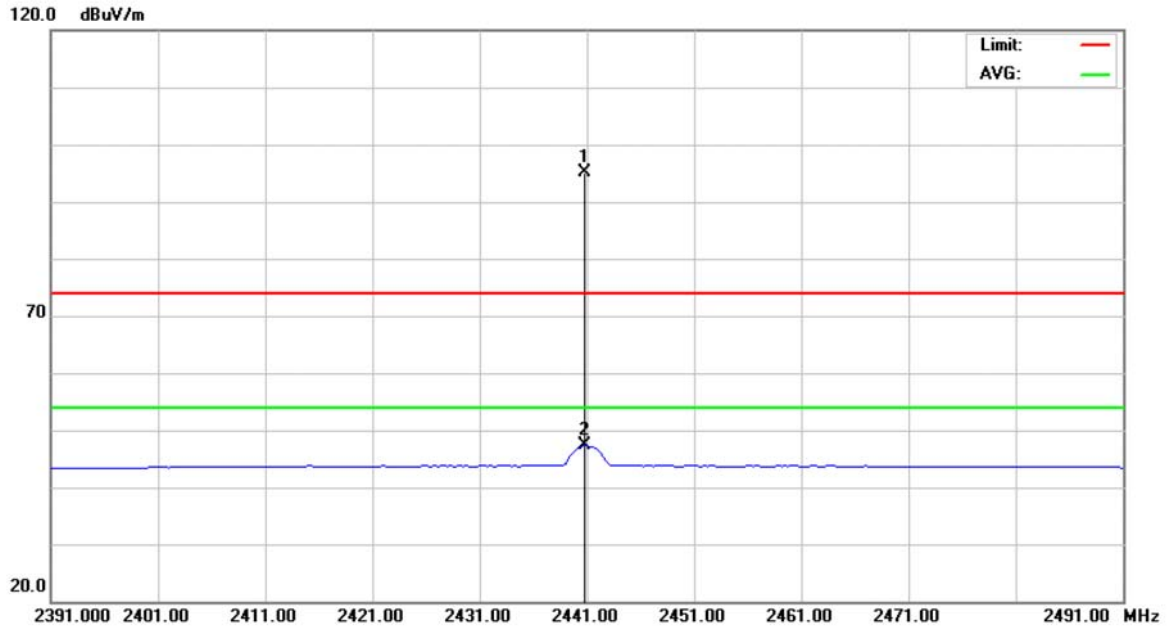

No.	Mk.	Freq. MHz	Reading Level dBuV	Correct Factor dB	Measure- ment dBuV/m	Limit dBuV/m	Over dB	Detector	Comment
1	*	2440.750	63.30	31.89	95.19	74.00	21.19	peak	
2		2440.750	15.40	31.89	47.29	54.00	-6.71	AVG	



E.U.T	Bluetooth Keyboard	Model Name	SK-2770
Temperature	26°C	Relative Humidity	60%
Test Voltage	DC 3.7V		
Test Mode	Bluetooth/2441 MHz		

Polarization: Horizontal

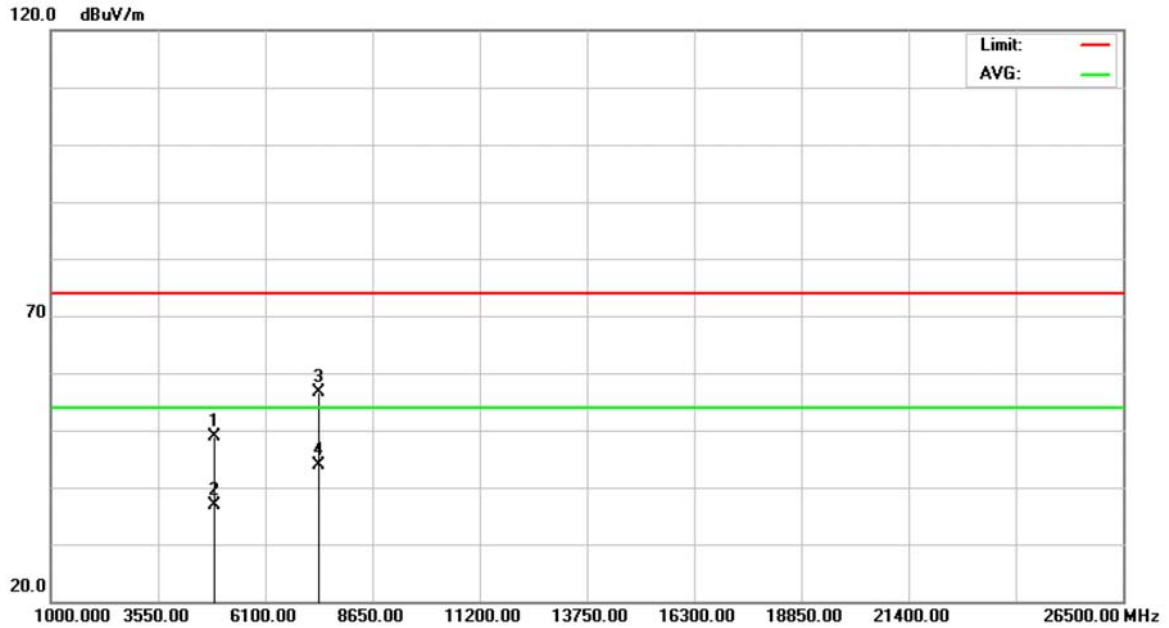

No.	Mk.	Freq. MHz	Reading Level dBuV	Correct Factor dB	Measure- ment dBuV/m	Limit dBuV/m	Over dB	Detector	Comment
1		4882.125	43.04	5.79	48.83	74.00	-25.17	peak	
2		4882.125	31.16	5.79	36.95	54.00	-17.05	AVG	
3		7322.875	44.06	12.61	56.67	74.00	-17.33	peak	
4	*	7322.875	31.24	12.61	43.85	54.00	-10.15	AVG	



E.U.T	Bluetooth Keyboard	Model Name	SK-2770
Temperature	26°C	Relative Humidity	60%
Test Voltage	DC 3.7V		
Test Mode	Bluetooth/2480 MHz		

Polarization: Vertical

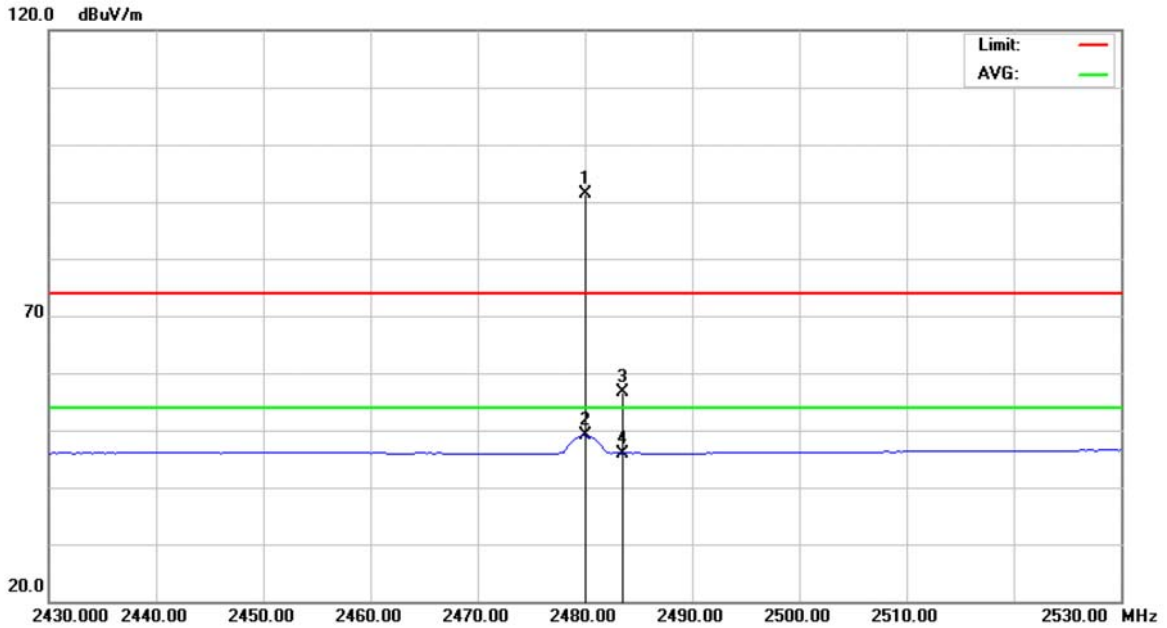

No.	Mk.	Freq. MHz	Reading Level dBuV	Correct Factor dB	Measure- ment dBuV/m	Limit dBuV/m	Over dB	Detector	Comment
1	*	2480.000	58.79	32.68	91.47	74.00	17.47	peak	
2		2480.000	16.35	32.68	49.03	54.00	-4.97	AVG	
3		2483.500	23.85	32.69	56.54	74.00	-17.46	peak	
4		2483.500	13.31	32.69	46.00	54.00	-8.00	AVG	



E.U.T	Bluetooth Keyboard	Model Name	SK-2770
Temperature	26°C	Relative Humidity	60%
Test Voltage	DC 3.7V		
Test Mode	Bluetooth/2480 MHz		

Polarization: Vertical

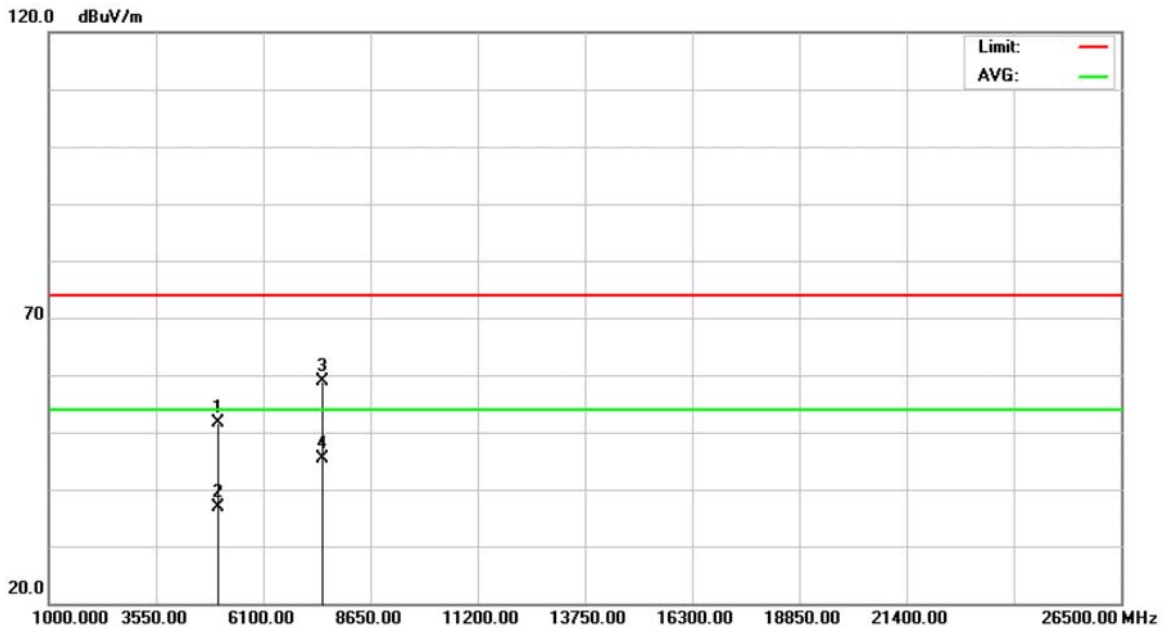

No.	Mk.	Freq. MHz	Reading Level dBuV	Correct Factor dB	Measure- ment dBuV/m	Limit dBuV/m	Over dB	Detector	Comment
1		4959.925	45.80	5.89	51.69	74.00	-22.31	peak	
2		4959.925	31.01	5.89	36.90	54.00	-17.10	AVG	
3		7439.850	45.83	13.05	58.88	74.00	-15.12	peak	
4	*	7439.850	32.26	13.05	45.31	54.00	-8.69	AVG	



E.U.T	Bluetooth Keyboard	Model Name	SK-2770
Temperature	26°C	Relative Humidity	60%
Test Voltage	DC 3.7V		
Test Mode	Bluetooth/2480 MHz		

Polarization: Horizontal

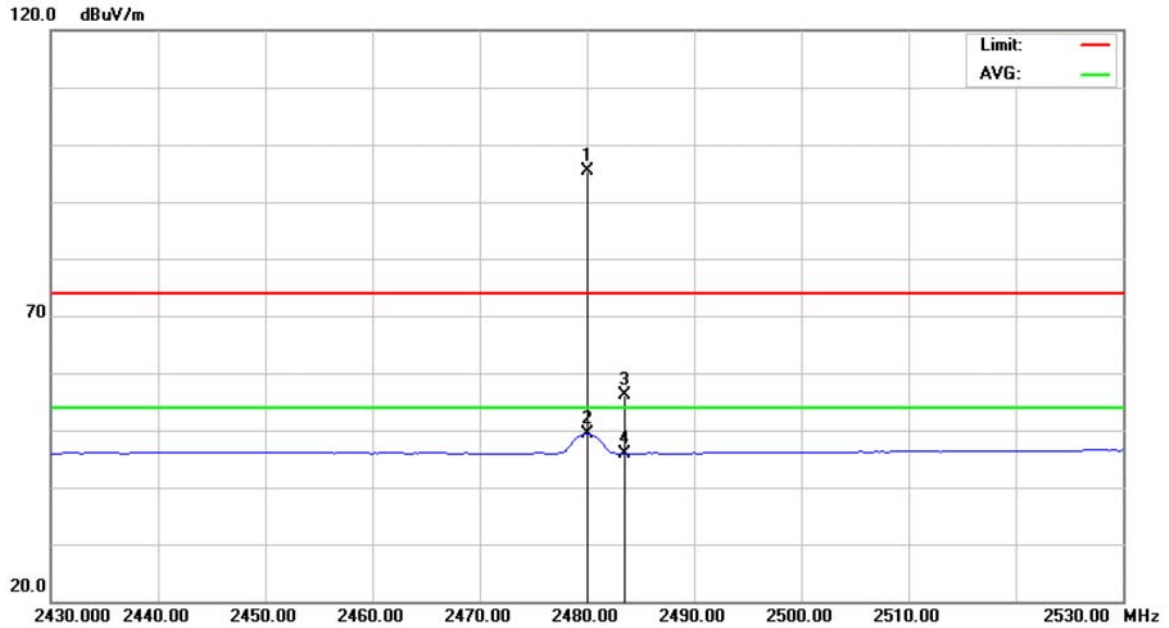

No.	Mk.	Freq. MHz	Reading Level dBuV	Correct Factor dB	Measure- ment dBuV/m	Limit dBuV/m	Over dB	Detector	Comment
1	*	2480.000	62.66	32.68	95.34	74.00	21.34	peak	
2		2480.000	16.64	32.68	49.32	54.00	-4.68	AVG	
3		2483.500	23.44	32.69	56.13	74.00	-17.87	peak	
4		2483.500	13.29	32.69	45.98	54.00	-8.02	AVG	



E.U.T	Bluetooth Keyboard	Model Name	SK-2770
Temperature	26°C	Relative Humidity	60%
Test Voltage	DC 3.7V		
Test Mode	Bluetooth/2480 MHz		

Polarization: Horizontal

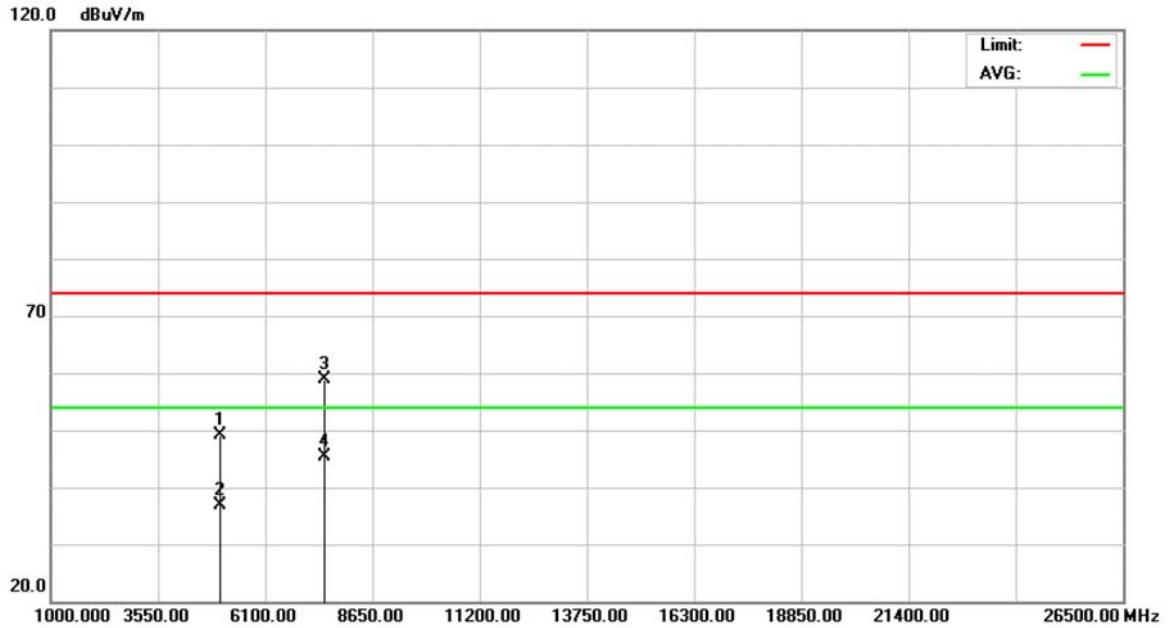

No.	Mk.	Freq. MHz	Reading Level dBuV	Correct Factor dB	Measure- ment dBuV/m	Limit dBuV/m	Over dB	Detector	Comment
1		4960.237	43.30	5.89	49.19	74.00	-24.81	peak	
2		4960.237	31.03	5.89	36.92	54.00	-17.08	AVG	
3		7439.212	45.93	13.04	58.97	74.00	-15.03	peak	
4	*	7439.212	32.25	13.04	45.29	54.00	-8.71	AVG	



9.9 TEST RESULTS (RESTRICTED BANDS)

E.U.T	Bluetooth Keyboard	Model Name	SK-2770
Temperature	24°C	Relative Humidity	46%
Test Voltage	DC 3.7V		
Test Mode	Bluetooth/2402 MHz		
NOTE	The transmitter was setup to transmit at the lowest channel and the field strength was measured at 2310-2390 MHz.		

Polarization: Vertical

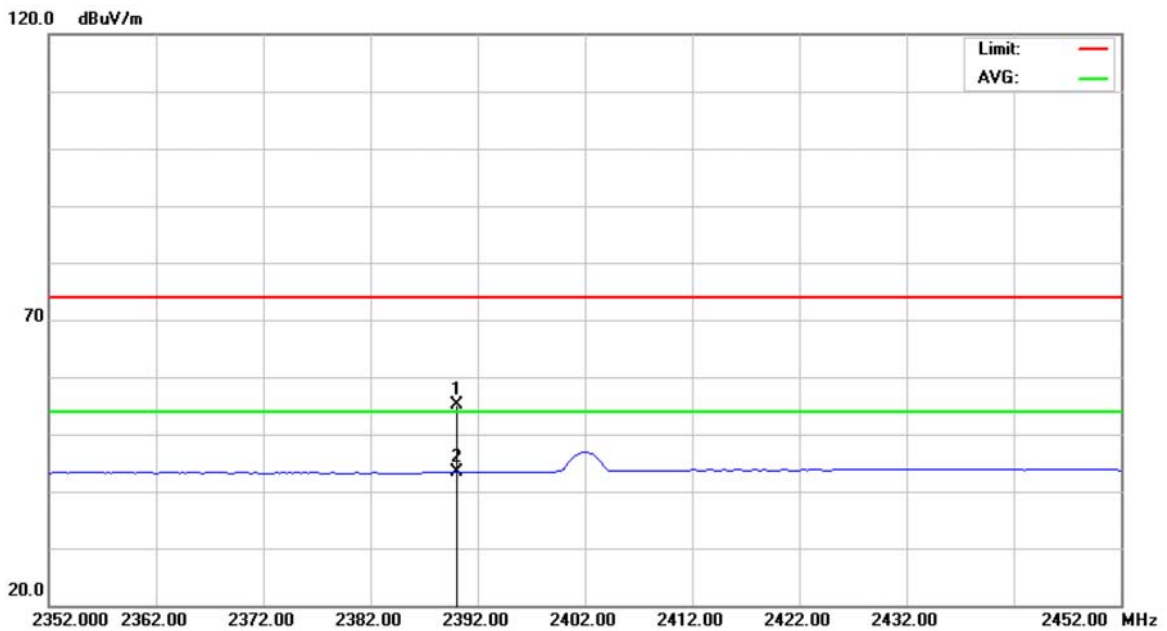

No.	Mk.	Freq. MHz	Reading Level dBuV	Correct Factor dB	Measure- ment dBuV/m	Limit dBuV/m	Over dB	Detector	Comment
1		2390.000	23.54	31.67	55.21	74.00	-18.79	peak	
2	*	2390.000	11.69	31.67	43.36	54.00	-10.64	AVG	



E.U.T	Bluetooth Keyboard	Model Name	SK-2770
Temperature	24°C	Relative Humidity	46%
Test Voltage	DC 3.7V		
Test Mode	Bluetooth/2480 MHz		
NOTE	The transmitter was setup to transmit at the highest channel and the field strength was measured at 2483.5-2500 MHz.		

Polarization: Vertical

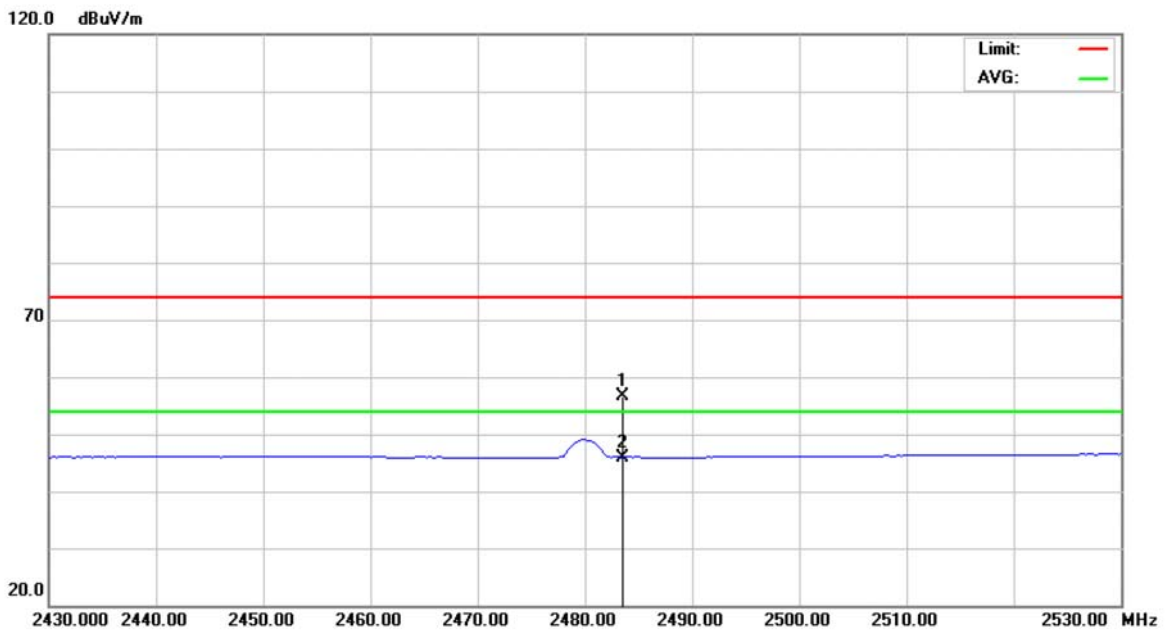

No. Mk.	Freq. MHz	Reading Level dBuV	Correct Factor dB	Measurement dBuV/m	Limit dBuV/m	Over dB	Detector	Comment
1	2483.500	23.85	32.69	56.54	74.00	-17.46	peak	
2 *	2483.500	13.31	32.69	46.00	54.00	-8.00	AVG	



E.U.T	Bluetooth Keyboard	Model Name	SK-2770
Temperature	24°C	Relative Humidity	46%
Test Voltage	DC 3.7V		
Test Mode	Bluetooth/2402 MHz		
NOTE	The transmitter was setup to transmit at the lowest channel and the field strength was measured at 2310-2390 MHz.		

Polarization: Horizontal

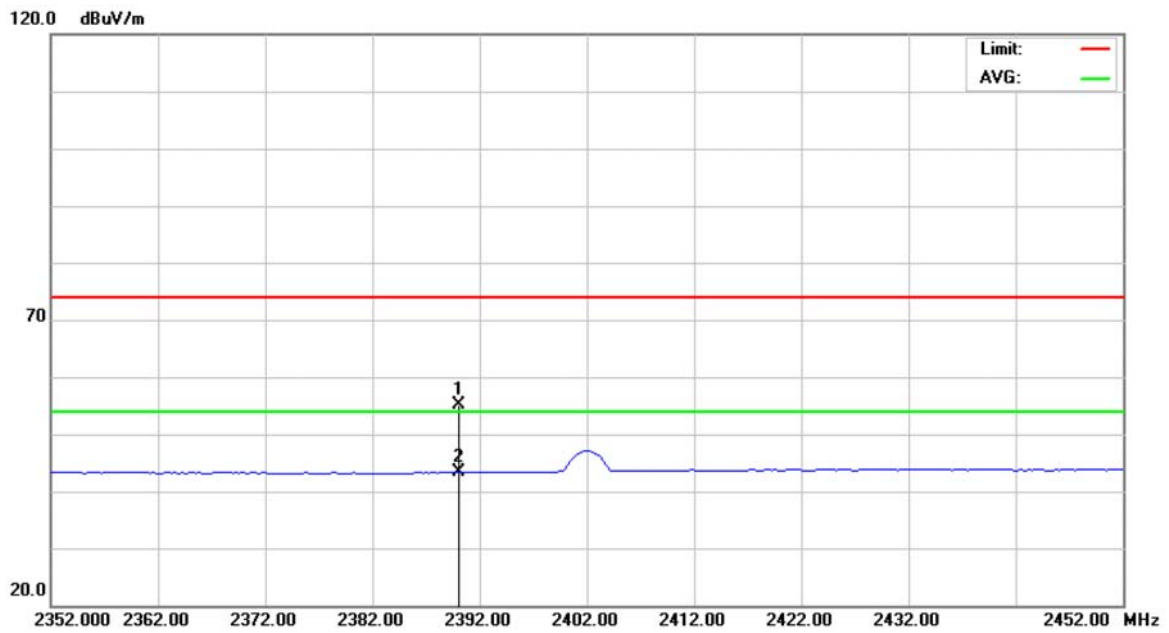

No.	Mk.	Freq. MHz	Reading Level dBuV	Correct Factor dB	Measure- ment dBuV/m	Limit dBuV/m	Over dB	Detector	Comment
1		2390.000	23.47	31.67	55.14	74.00	-18.86	peak	
2	*	2390.000	11.67	31.67	43.34	54.00	-10.66	AVG	



E.U.T	Bluetooth Keyboard	Model Name	SK-2770
Temperature	24°C	Relative Humidity	46%
Test Voltage	DC 3.7V		
Test Mode	Bluetooth/2480 MHz		
NOTE	The transmitter was setup to transmit at the highest channel and the field strength was measured at 2483.5-2500 MHz.		

Polarization: Horizontal

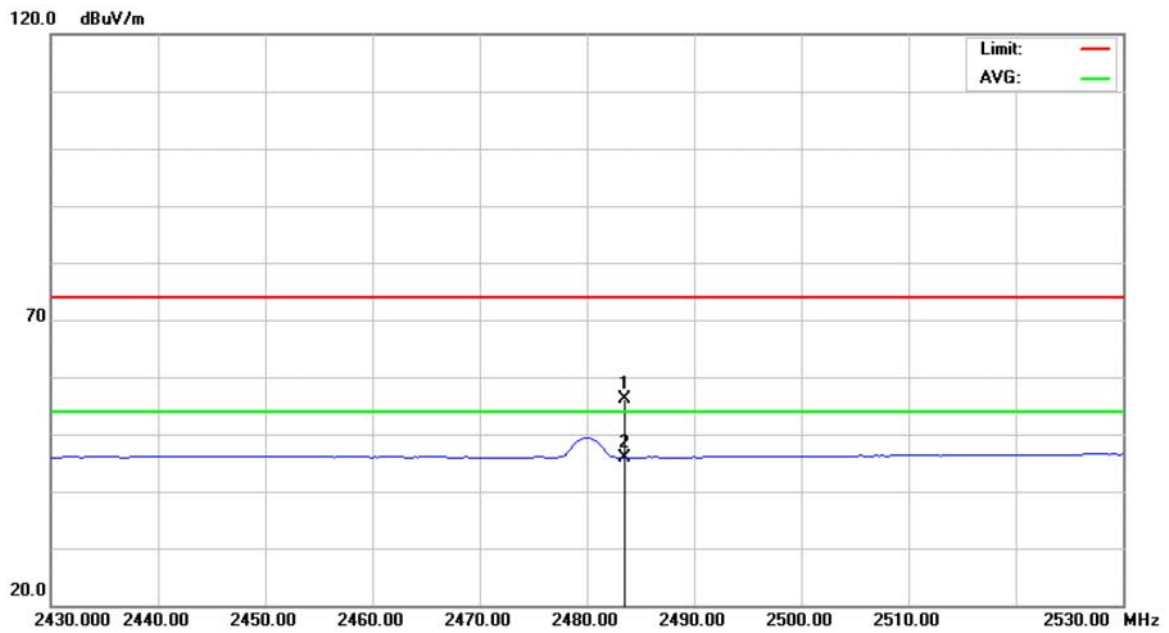

No. Mk.	Freq. MHz	Reading Level dBuV	Correct Factor dB	Measurement dBuV/m	Limit dBuV/m	Over dB	Detector	Comment
1	2483.500	23.44	32.69	56.13	74.00	-17.87	peak	
2 *	2483.500	13.29	32.69	45.98	54.00	-8.02	AVG	



10 NUMBER OF HOPPING FREQUENCY

10.1 LIMIT

Test Item	Frequency Range (MHz)	Limit
Number of Hopping Channel	2400-2483.5	shall use at least 15 channels

10.2 MEASUREMENT INSTRUMENTS LIST

Item	Kind of Equipment	Manufacturer	Type No.	Serial No.	Calibrated until
1	Spectrum Analyzer	R&S	FSP-40	100129	Oct. 01, 2013

NOTE: **N/A**: denotes No Model Name, No Serial No. or No Calibration specified.

10.3 MEASURING INSTRUMENTS SETTING

Spectrum Analyzer	Parameter Setting
Attenuation	Auto
Span Frequency	> Operating Frequency Range
RB	100 kHz
VB	100 kHz
Detector	Peak
Trace	Max Hold
Sweep Time	Auto

10.4 TEST PROCEDURES

- a. The EUT was directly connected to the spectrum analyzer and antenna output port as show in the block diagram below.
- b. Spectrum Setting: RBW= 100 kHz, VBW=100 kHz, Sweep time = Auto.

10.5 TEST SETUP LAYOUT



10.6 DEVIATION FROM TEST STANDARD

No deviation

10.7 EUT OPERATING CONDITIONS

The EUT tested system was configured as the statements of 5.6 Unless otherwise a special operating condition is specified in the follows during the testing.



11 AVERAGE TIME OF OCCUPANCY

11.1 LIMIT

Test Item	Frequency Range (MHz)	Limit
Average time of occupancy	2400-2483.5	shall not be greater than 0.4 seconds within a period of 0.4 seconds multiplied by the number of hopping channels employed.

11.2 MEASUREMENT INSTRUMENTS LIST

Item	Kind of Equipment	Manufacturer	Type No.	Serial No.	Calibrated until
1	Spectrum Analyzer	R&S	FSP-40	100129	Oct. 01, 2013

NOTE: **N/A**: denotes No Model Name, No Serial No. or No Calibration specified.

11.3 TEST PROCEDURES

- a. The transmitter output (antenna port) was connected to the spectrum analyzer
- b. Set RBW of spectrum analyzer to 100 kHz and VBW to 100 kHz.
- c. Use a video trigger with the trigger level set to enable triggering only on full pulses.
- d. Sweep Time is more than once pulse time.
- e. Set the center frequency on any frequency would be measure and set the frequency span to zero span.
- f. Measure the maximum time duration of one single pulse.
- g. Set the EUT for DH5, DH3 and DH1 packet transmitting.
- h. Measure the maximum time duration of one single pulse.
- i. DH5 Packet permit maximum $1600 / 79 / 6 = 3.37$ hops per second in each channel (5 time slots RX, 1 time slot TX). So, the dwell time is the time duration of the pulse times $3.37 \times 31.6 = 106.6$ within 31.6 seconds.
- j. DH3 Packet permit maximum $1600 / 79 / 4 = 5.06$ hops per second in each channel (3 time slots RX, 1 time slot TX). So, the dwell time is the time duration of the pulse times $5.06 \times 31.6 = 160$ within 31.6 seconds.
- k. DH1 Packet permit maximum $1600 / 79 / 2 = 10.12$ hops per second in each channel (1 time slot RX, 1 time slot TX). So, the dwell time is the time duration of the pulse times $10.12 \times 31.6 = 320$ within 31.6 seconds.

11.4 TEST SETUP LAYOUT

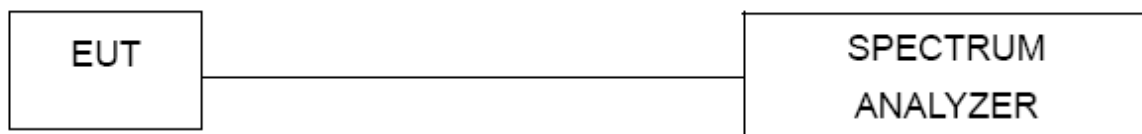

11.5 DEVIATION FROM TEST STANDARD

No deviation



11.6 EUT OPERATING CONDITIONS

The EUT tested system was configured as the statements of 5.6 Unless otherwise a special operating condition is specified in the follows during the testing.



11.7 TEST RESULTS

E.U.T	Bluetooth Keyboard	Model Name	SK-2770
Temperature	26°C	Relative Humidity	46%
Test Voltage	DC 3.7V		
Test Mode	Bluetooth/2402 MHz		

Data Packet	Frequency	Pulse Duration (ms)	Dwell Time (s)	Limit (s)	Result
DH1	2402 MHz	1.0000	0.3200	0.4	PASS

Bluetooth/2402 MHz/DH1

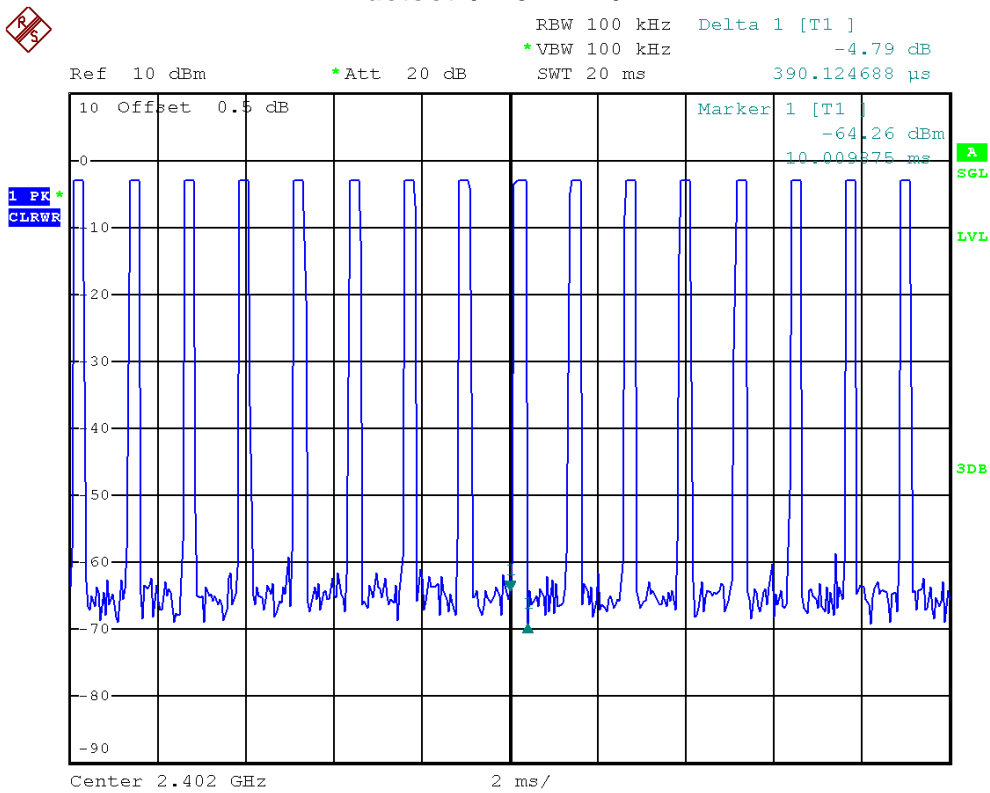



E.U.T	Bluetooth Keyboard	Model Name	SK-2770
Temperature	26°C	Relative Humidity	46%
Test Voltage	DC 3.7V		
Test Mode	Bluetooth/2441 MHz		

Data Packet	Frequency	Pulse Duration (ms)	Dwell Time (s)	Limit (s)	Result
DH1	2441 MHz	1.0000	0.3200	0.4	PASS

Bluetooth/2441 MHz/DH1

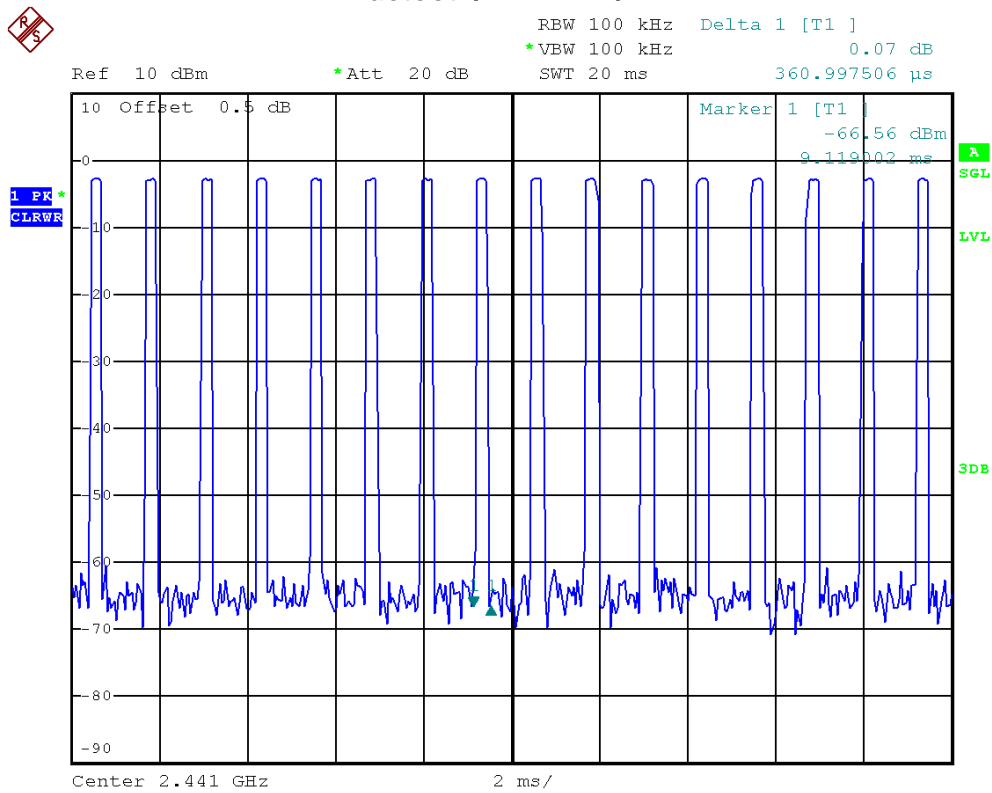



E.U.T	Bluetooth Keyboard	Model Name	SK-2770
Temperature	26°C	Relative Humidity	46%
Test Voltage	DC 3.7V		
Test Mode	Bluetooth/2480 MHz		

Data Packet	Frequency	Pulse Duration (ms)	Dwell Time (s)	Limit (s)	Result
DH1	2480 MHz	1.0000	0.3200	0.4	PASS

Bluetooth/2480 MHz/DH1



RBW 100 kHz Delta 1 [T1]
 *VBW 100 kHz 0.91 dB
 SWT 20 ms 312.119701 µs

Ref 10 dBm *Att 20 dB

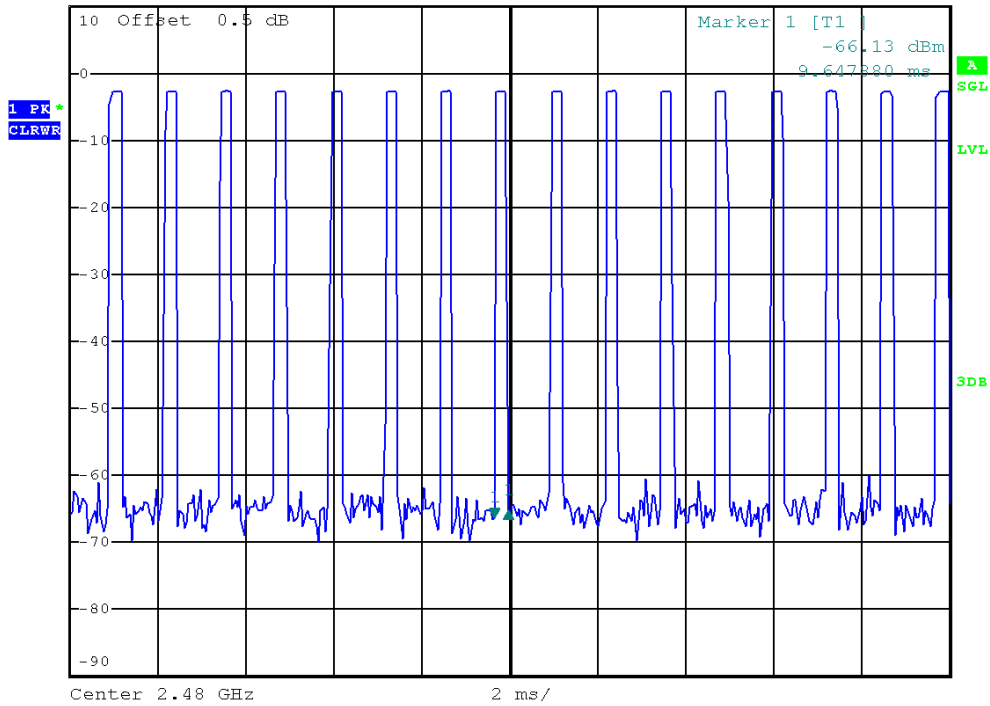



12 RF EXPOSURE COMPLIANCE

12.1 LIMIT

Systems operating under the provisions of this section shall be operated in a manner that ensures that the public is not exposed to radio frequency energy levels in excess limit for maximum permissible exposure. In accordance with 47 CFR FCC Part 2 Subpart J, section 2.1091 this device has been defined as a mobile device whereby a distance of 0.2 m normally can be maintained between the user and the device.

(A) Limits for Occupational / Controlled Exposure

Frequency Range (MHz)	Electric Field Strength (E) (V/m)	Magnetic Field Strength (H) (A/m)	Power Density (S) (mW/ cm ²)	Averaging Time E ² , H ² or S (minutes)
0.3-3.0	614	1.63	(100)*	6
3.0-30	1842 / f	4.89 / f	(900 / f)*	6
30-300	61.4	0.163	1.0	6
300-1500			F/300	6
1500-100,000			5	6

(B) Limits for General Population / Uncontrolled Exposure

Frequency Range (MHz)	Electric Field Strength (E) (V/m)	Magnetic Field Strength (H) (A/m)	Power Density (S) (mW/ cm ²)	Averaging Time E ² , H ² or S (minutes)
0.3-1.34	614	1.63	(100)*	30
1.34-30	824/f	2.19/f	(180/f)*	30
30-300	27.5	0.073	0.2	30
300-1500			F/1500	30
1500-100,000			1.0	30

NOTE: f = frequency in MHz ; *Plane-wave equivalent power density.

12.2 MEASUREMENT INSTRUMENTS LIST

Item	Kind of Equipment	Manufacturer	Type No.	Serial No.	Calibrated until
1	Power Meter	Anritsu	ML2495A	1128008	Feb, 26, 2014
2	Power Meter Sensor	Anritsu	MA2411B	1126001	Feb, 26, 2014

NOTE: **N/A**: denotes No Model Name, No Serial No. or No Calibration specified.

12.3 MPE CALCULATION METHOD

$$E \text{ (V/m)} = \frac{\sqrt{30 \times P \times G}}{d} \qquad \text{Power Density: } Pd \text{ (W/m}^2\text{)} = \frac{E^2}{377}$$

- E** = Electric field (V/m)
- P** = Peak RF output power (W)
- G** = EUT Antenna numeric gain (numeric)
- d** = Separation distance between radiator and human body (m)

The formula can be changed to

$$Pd = \frac{30 \times P \times G}{377 \times d^2}$$

From the peak EUT RF output power, the minimum mobile separation distance, d=0.2m, as well as the gain of the used antenna, the RF power density can be obtained



12.4 TEST SETUP LAYOUT

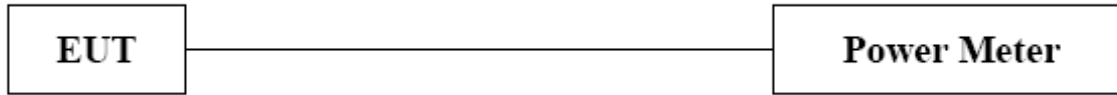

12.5 DEVIATION FROM TEST STANDARD

No deviation

12.6 EUT OPERATING CONDITIONS

The EUT tested system was configured as the statements of 4.6 Unless otherwise a special operating condition is specified in the follows during the testing.

12.7 TEST RESULTS

The power is so low so there is no need for RF calculations.