

MARK	ISSUE	DATE	REVER

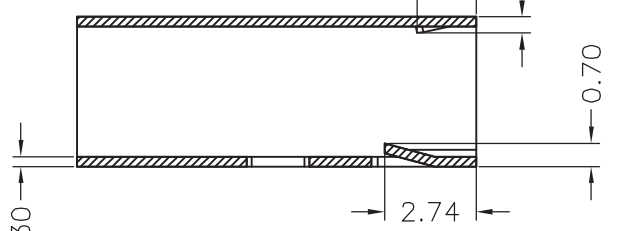
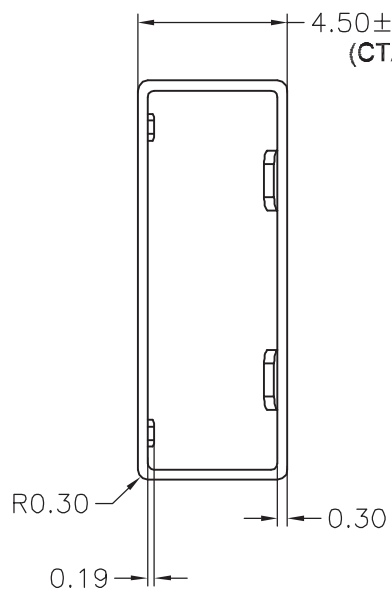
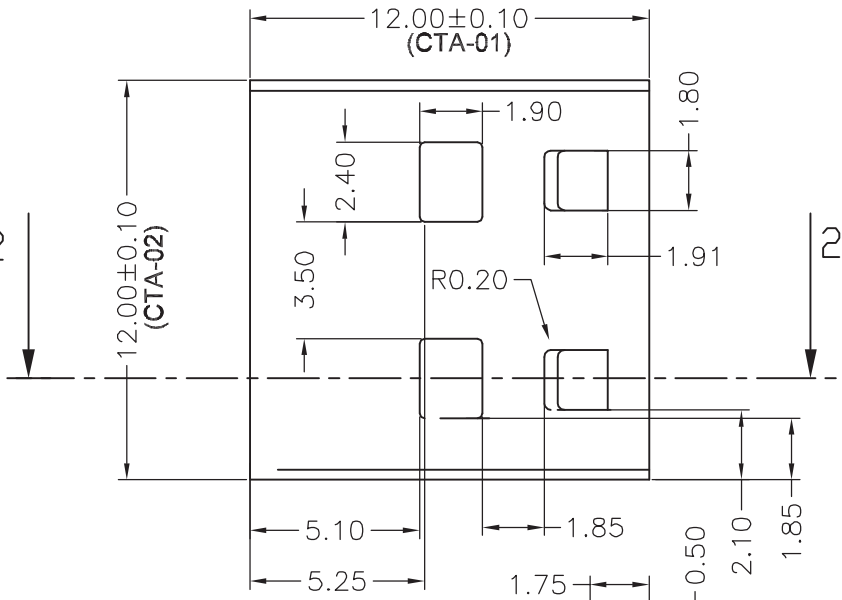

- Note:
- 1 Material: SUS304+SWIC(plated with nickel)
 2. 3D surface and curve refer to Pro/E file.
 3. CTA=Critical to assemble(01~03)
 4. Unspecified tolerance:

SELECT V	V			
DIM. LEVEL	A	B	C	D
~ 5	±0.03	±0.05	±0.08	±0.10
5 ~ 10	±0.05	±0.08	±0.10	±0.15
10 ~ 50	±0.08	±0.10	±0.15	±0.20
50 ~ 100	±0.10	±0.15	±0.20	±0.25
100 ~	±0.10	±0.15	±0.20	±0.25

5. The part is according to the latest version "HS-301" of LITEON.

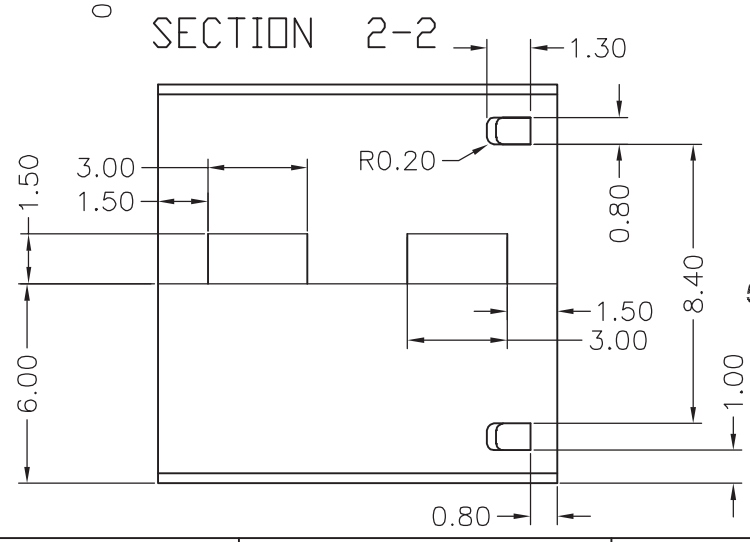



 FCC ID:H4IDG9086







 IC:4491A-DG9086

 CMIIT ID:2013XXXXX

Model: SD-9086

 RATING: 5V==100mA



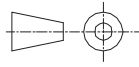

 MADE IN CHINA

PART NO	DESCRIPTION	QTY	MAT'L	TRETING	REMARK
SCALE: FREE	TOLERANCE : UNSPECIFIED	 SILITEK ELECTRONICS(DONGGUAN)CO.,LTD DONGGUAN LITE ON COMPUTER CO., LTD.			
UNIT: mm	.XXX ± 0.05 .XX ± 0.1 .X ± 0.15 ANGLE ± 0.25°				
DRAWN:	 TITLE: SD9086_iron shell		SHEET 1 OF 1		
DESIGER:	DRAWING NO: 821-XXXXX-XXA		REV 0.1		
CHECKED:					
APPROVED:					