



# Radio Test Report

**FCC ID: H4IDG9085**

**Issued Date** : Nov. 24, 2011  
**Project No.** : R1111004  
**Equipment** : Dongle  
**Model Name** : SD-9085

**Applicant** : LITE-ON TECHNOLOGY CORP.  
**Address** : 90, Chien 1 Road, Chung Ho City, Taipei  
Hsien 235, Taiwan, R.O.C.

**Tested by:** Neutron Engineering Inc. EMC Laboratory  
**Date of Receipt:** Nov. 10, 2011  
**Date of Test:** Nov. 10, 2011 ~ Nov. 16, 2011

**Testing Engineer:** Rush Kao  
(Rush Kao)

**Technical Manager:** Jeff Yang  
(Jeff Yang)

**Authorized Signatory:** Andy Chiu  
(Andy Chiu)

## Neutron Engineering Inc.

B1, No. 37, Lane 365, YangGuang St.,  
NeiHu District 114, Taipei, Taiwan.

TEL: +886-2-2657-3299

FAX: +886-2-2657-3331





### **Declaration**

**Neutron** represents to the client that testing is done in accordance with standard procedures as applicable and that test instruments used has been calibrated with the standards traceable to National Measurement Laboratory (**NML**) of **R.O.C.**, or National Institute of Standards and Technology (**NIST**) of **U.S.A.**

**Neutron's** reports apply only to the specific samples tested under conditions. It is manufacture's responsibility to ensure that additional production units of this model are manufactured with the identical electrical and mechanical components. **Neutron** shall have no liability for any declarations, inferences or generalizations drawn by the client or others from **Neutron** issued reports.

**Neutron's** reports must not be used by the client to claim product endorsement by the authorities or any agency of the Government.

This report is the confidential property of the client. As a mutual protection to the clients, the public and **Neutron-self**, extracts from the test report shall not be reproduced except in full with **Neutron's** authorized written approval.

**Neutron's** laboratory quality assurance procedures are in compliance with the **ISO Guide 17025** requirements, and accredited by the conformity assessment authorities listed in this test report.

### **Limitation**

For the use of the authority's logo is limited unless the Test Standard(s)/Scope(s)/Item(s) mentioned in this test report is (are) included in the conformity assessment authorities acceptance respective.



<b>Table of Contents</b>	<b>Page</b>
<b>1 . CERTIFICATION</b>	<b>4</b>
<b>2 . SUMMARY OF TEST RESULTS</b>	<b>5</b>
2.1 TEST FACILITY	6
2.2 MEASUREMENT UNCERTAINTY	6
<b>3 . GENERAL INFORMATION</b>	<b>7</b>
3.1 GENERAL DESCRIPTION OF EUT	7
3.2 DESCRIPTION OF TEST MODES	9
3.3 BLOCK DIAGRAM SHOWING THE CONFIGURATION OF SYSTEM TESTED	10
3.4 DESCRIPTION OF SUPPORT UNITS	11
<b>4 . EMC EMISSION TEST</b>	<b>12</b>
4.1 RADIATED EMISSION MEASUREMENT	17
4.1.1 RADIATED EMISSION LIMITS	17
4.1.2 MEASUREMENT INSTRUMENTS LIST	18
4.1.3 TEST PROCEDURE	19
4.1.4 DEVIATION FROM TEST STANDARD	20
4.1.5 TEST SETUP	20
4.1.6 EUT OPERATING CONDITIONS	21
4.1.7 TEST RESULTS-BETWEEN 30MHZ AND 1000MHZ	22
4.1.8 TEST RESULTS- FUNDAMENTAL FREQUENCY & ABOVE 1000MHZ	24
<b>5 . ANTENNA CONDUCTED SPURIOUS EMISSION</b>	<b>36</b>
5.1 APPLIED PROCEDURES / LIMIT	36
5.1.1 MEASUREMENT INSTRUMENTS LIST	36
5.1.2 TEST PROCEDURE	36
5.1.3 DEVIATION FROM STANDARD	36
5.1.4 TEST SETUP	36
5.1.5 EUT OPERATION CONDITIONS	36
5.1.6 TEST RESULTS	37
<b>6 . EUT TEST PHOTO</b>	<b>39</b>



1. CERTIFICATION

Equipment : Dongle  
Brand Name : Liteon  
Model Name : SD-9085  
Applicant : LITE-ON TECHNOLOGY CORP.  
Date of Test : Nov. 10, 2011 ~ Nov. 16, 2011  
Standards : FCC Part15, Subpart C(15.249) / ANCI C63.4: 2009

The above equipment has been tested and found compliance with the requirement of the relative standards by Neutron Engineering Inc. EMC Laboratory.

The test data, data evaluation, and equipment configuration contained in our test report (Ref No. NEI-FCCP-1-R1111004) were obtained utilizing the test procedures, test instruments, test sites that has been accredited by the Authority of NVLAP and TAF according to the ISO-17025 quality assessment standard and technical standard(s).



**2. SUMMARY OF TEST RESULTS**

Test procedures according to the technical standards:

<b>FCC Part15, Subpart C</b>			
Standard Section	Test Item	Judgment	Remark
FCC Part15, Subpart C			
15.207	Conducted Emission	PASS	
15.209	Radiated Emission	PASS	
15.249	Radiated Spurious Emission	PASS	

**NOTE:**

(1) " N/A" denotes test is not applicable in this Test Report.



**2.1 TEST FACILITY**

The test facilities used to collect the test data in this report:

- C02:** (VCCI RN: C-3477; FCC RN: 614388; FCC DN: TW1054)  
1F., No. 61, Ln. 77, Sing-ai Rd., Neihu Dist., Taipei City 114, Taiwan (R.O.C.)
- CB08:** (VCCI RN: G-91; FCC RN: 614388; FCC DN: TW1010;  
IC Assigned Code: 4428C-1)  
1F., No. 61, Ln. 77, Sing-ai Rd., Neihu Dist., Taipei City 114, Taiwan (R.O.C.)

**2.2 MEASUREMENT UNCERTAINTY**

The reported uncertainty of measurement  $y \pm U$ , where expanded uncertainty  $U$  is based on a standard uncertainty multiplied by a coverage factor of  $k=2$ , providing a level of confidence of approximately **95%**.

The measurement instrumentation uncertainty considerations contained in CISPR 16-4-2.

A. Conducted Measurement :

Test Site	Method	Measurement Frequency Range	U , (dB)	NOTE
C01	ANSI	150 kHz ~ 30 MHz	1.94	
C02	ANSI	150 kHz ~ 30 MHz	2.59	

B. Radiated Measurement :

Test Site	Item	Measurement Frequency Range	Uncertainty	NOTE	
CB08	Radiated Emission at 3m	Horizontal Polarization	30 - 200MHz	3.35 dB	
			200 - 1000MHz	3.11 dB	
			1 - 18GHz	3.97 dB	
			18 - 40GHz	4.01 dB	
		Vertical Polarization	30 - 200MHz	3.22 dB	
			200 - 1000MHz	3.24 dB	
			1 - 18GHz	4.05 dB	
			18 - 40GHz	4.04 dB	

Our calculated Measurement Instrumentation Uncertainty is shown in the tables above. These are our  $U_{lab}$  values in CISPR 16-4-2 terminology.

Since Table 1 of CISPR 16-4-2 has values of measurement instrumentation uncertainty, called  $U_{CISPR}$ , as follows:

- Conducted Disturbance (mains port) – 150 kHz – 30 MHz : 3.6 dB
- Radiated Disturbance (electric field strength on an open area test site or alternative test site) – 30 MHz – 1000 MHz : 5.2 dB

It can be seen that our  $U_{lab}$  values are smaller than  $U_{CISPR}$ .



**3. GENERAL INFORMATION**

**3.1 GENERAL DESCRIPTION OF EUT**

Equipment	Dongle
Brand Name	Liteon
Model Name	SD-9085
OEM Brand/Model Name	N/A
Model Difference	N/A
Product Description	The EUT is a Dongle.
	Operation Frequency: 2404~2478 MHz
	Modulation Type: GFSK
	Bit Rate of Transmitter: 1 Mbps
	Number Of Channel Please see Note 2.
	Antenna Designation: Please see Note 3.
	Antenna Gain(Peak) Please see Note 3.
	Max Output Power 94.99 dBuV/m
Based on the application, features, or specification exhibited in User's Manual, the EUT is considered as an ITE/Computing Device. More details of EUT technical specification, please refer to the User's Manual.	
Power Source	Supplied from PC USB port.
Power Rating	I/P: DC 5V
Connecting I/O Port(s)	Please refer to the User's Manual
Products Covered	N/A
EUT Modification(s)	N/A

**Note:**

1. For a more detailed features description, please refer to the manufacturer's specifications or the User's Manual.



2.

Channel List					
Channel	Frequency (MHz)	Channel	Frequency (MHz)	Channel	Frequency (MHz)
01	2404	27	2430	53	2456
02	2405	28	2431	54	2457
03	2406	29	2432	55	2458
04	2407	30	2433	56	2459
05	2408	31	2434	57	2460
06	2409	32	2435	58	2461
07	2410	33	2436	59	2462
08	2411	34	2437	60	2463
09	2412	35	2438	61	2464
10	2413	36	2439	62	2465
11	2414	37	2440	63	2466
12	2415	38	2441	64	2467
13	2416	39	2442	65	2468
14	2417	40	2443	66	2469
15	2418	41	2444	67	2470
16	2419	42	2445	68	2471
17	2420	43	2446	69	2472
18	2421	44	2447	70	2473
19	2422	45	2448	71	2474
20	2423	46	2449	72	2475
21	2424	47	2450	73	2476
22	2425	48	2451	74	2477
23	2426	49	2452	75	2478
24	2427	50	2453		
25	2428	51	2454		
26	2429	52	2455		

3. Table for Filed Antenna

Ant.	Brand	Model Name	Antenna Type	Connector	Gain (dBi)
1	N/A	N/A	Ant. On PCB	N/A	2.42





**3.2 DESCRIPTION OF TEST MODES**

To investigate the maximum EMI emission characteristics generates from EUT, the test system was pre-scanning tested base on the consideration of following EUT operation mode or test configuration mode which possible have effect on EMI emission level. Each of these EUT operation mode(s) or test configuration mode(s) mentioned above was evaluated respectively.

Pretest Test Mode	Description
Mode 1	2404 MHz
Mode 2	2442 MHz
Mode 3	2478 MHz

For Conducted Test	
Final Test Mode	Description
Mode 2	2442 MHz

For Radiated Test	
Final Test Mode	Description
Mode 1	2404 MHz
Mode 2	2442 MHz
Mode 3	2478 MHz



**3.3 BLOCK DIAGRAM SHOWING THE CONFIGURATION OF SYSTEM TESTED**

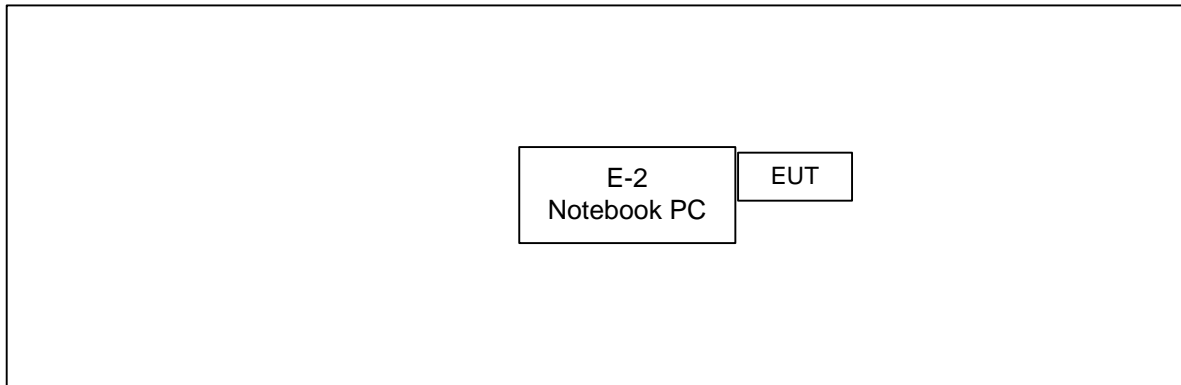



### 3.4 DESCRIPTION OF SUPPORT UNITS

The EUT has been tested as an independent unit together with other necessary accessories or support units. The following support units or accessories were used to form a representative test configuration during the tests.

Item	Equipment	Mfr/Brand	Model/Type No.	FCC ID	Series No.	Note
E-1	Dongle	Liteon	SD-9085	H4IDG9080	N/A	EUT
E-2	Notebook PC	Acer	ZH2	DOC	LXTCY050356360BDB52500	

Item	Shielded Type	Ferrite Core	Length	Note
N/A	-	-	-	-

Note:

- (1) The support equipment was authorized by Declaration of Conformity.
- (2) For detachable type I/O cable should be specified the length in cm in 『Length』 column.



**4. EMC EMISSION TEST**

**4.1 CONDUCTED EMISSION MEASUREMENT**

**4.1.1 POWER LINE CONDUCTED EMISSION (FREQUENCY RANGE 150 KHZ-30MHZ)**

FREQUENCY ( MHz)	Class A (dBuV)		Class B (dBuV)	
	Quasi-peak	Average	Quasi-peak	Average
0.15 -0.5	79.00	66.00	66 - 56 *	56 - 46 *
0.50 -5.0	73.00	60.00	56.00	46.00
5.0 -30.0	73.00	60.00	60.00	50.00

Note:

- (1) The tighter limit applies at the band edges.
- (2) The limit of " \* " marked band means the limitation decreases linearly with the logarithm of the frequency in the range.
- (3) The test result calculated as following:  
 Measurement Value = Reading Level + Correct Factor  
 Correct Factor = Insertion Loss + Cable Loss + Attenuator Factor(if use)  
 Margin Level = Measurement Value – Limit Value

**4.1.2 MEASUREMENT INSTRUMENTS LIST**

Item	Kind of Equipment	Manufacturer	Type No.	Serial No.	Calibrated until
1	EMI Test Receiver	R&S	ESCS 30	8333641017	Jul. 26 , 2012
2	TWO-LINE V-NETWORK	R&S	ENV216	101050	Jun. 06, 2012
3	Test Cable	TIMES	CFD300-NL	130	Jun. 16, 2012

Remark: " N/A" denotes No Model Name , Serial No. or No Calibration specified.

**4.1.3 TEST PROCEDURE**

- a. The EUT was placed 0.8 meters from the horizontal ground plane with EUT being connected to the power mains through a line impedance stabilization network (LISN). All other support equipments powered from additional LISN(s). The LISN provide 50 Ohm/ 50uH of coupling impedance for the measuring instrument.
- b. Interconnecting cables that hang closer than 40 cm to the ground plane shall be folded back and forth in the center forming a bundle 30 to 40 cm long.
- c. I/O cables that are not connected to a peripheral shall be bundled in the center. The end of the cable may be terminated, if required, using the correct terminating impedance. The overall length shall not exceed 1 m.
- d. LISN at least 80 cm from nearest part of EUT chassis.
- e. For the actual test configuration, please refer to the related Item –EUT Test Photos.

**NOTE:**

- a. Reading in which marked as Peak, QP or AVG means measurements by using are Quasi-Peak or Average Mode with Detector BW=9 kHz; SPA setting in RBW=10 kHz, VBW =10 kHz, Swp. Time = 0.2 sec./ MHz.
- b. All readings are Peak Mode value unless otherwise stated QP or AVG in column of Note. If the Peak or QP Mode Measured value compliance with the QP Limits and lower than AVG Limits, the EUT shall be deemed to meet both QP & AVG Limits and then only Peak or QP Mode was measured, but AVG Mode didn't perform.

**4.1.4 DEVIATION FROM TEST STANDARD**

No deviation

**4.1.5 TEST SETUP**

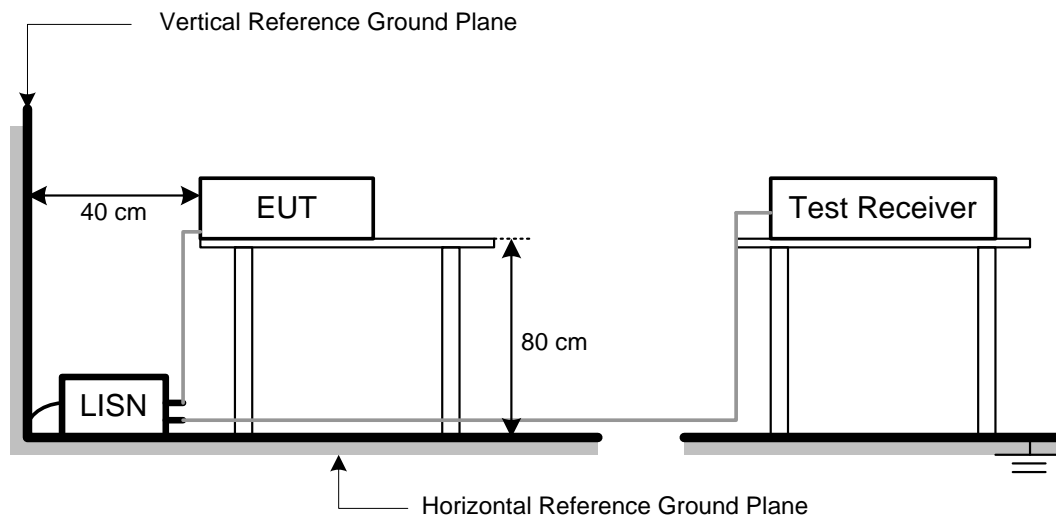



#### **4.1.6 EUT OPERATING CONDITIONS**

The EUT was configured for testing in a typical fashion (as a customer would normally use it). The EUT has been programmed to continuously transmit and receive during test. This operating condition was tested and used to collect the included data.



**4.1.7 TEST RESULTS**

E.U.T :	Dongle	Model Name :	SD-9085
Temperature :	24°C	Relative Humidity :	48%
Test Voltage :	AC 120V/60Hz (System)		
Test Mode :	2442 MHz		

**Phase: Line**

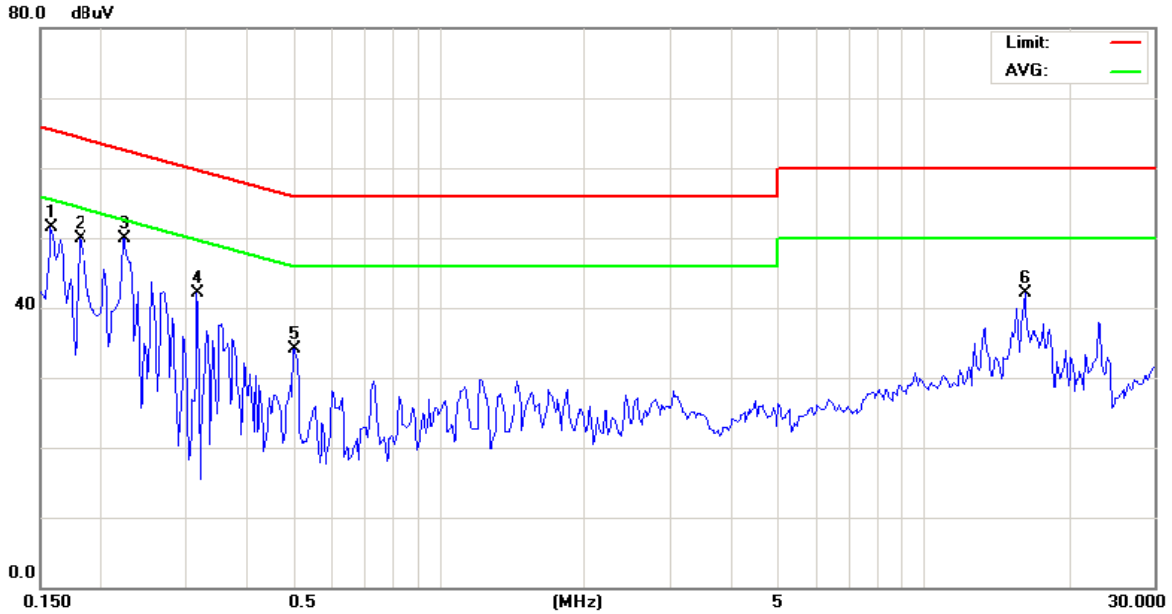

No.	Mk.	Freq. MHz	Reading Level dBuV	Correct Factor dB	Measure- ment dBuV	Limit dBuV	Over dB	Detector	Comment
1		0.1578	41.89	9.60	51.49	65.58	-14.09	peak	
2		0.1813	40.25	9.60	49.85	64.43	-14.58	peak	
3	*	0.2242	40.39	9.60	49.99	62.66	-12.67	peak	
4		0.3180	32.51	9.61	42.12	59.76	-17.64	peak	
5		0.5016	24.44	9.63	34.07	56.00	-21.93	peak	
6		16.2281	32.12	9.89	42.01	60.00	-17.99	peak	



E.U.T :	Dongle	Model Name :	SD-9085
Temperature :	24°C	Relative Humidity :	48%
Test Voltage :	AC 120V/60Hz (System)		
Test Mode :	2442 MHz		

**Phase: Neutral**

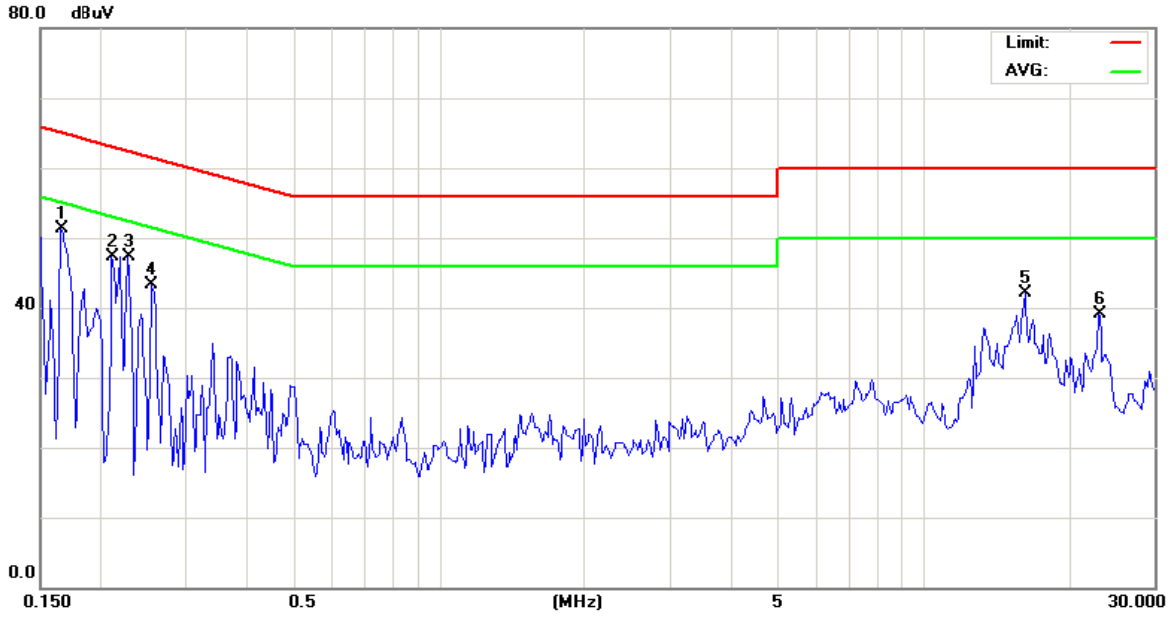

No.	Mk.	Freq. MHz	Reading Level dBuV	Correct Factor dB	Measure- ment dBuV	Limit dBuV	Over dB	Detector	Comment
1	*	0.1655	41.75	9.60	51.35	65.18	-13.83	peak	
2		0.2125	37.76	9.60	47.36	63.11	-15.75	peak	
3		0.2281	37.66	9.60	47.26	62.52	-15.26	peak	
4		0.2555	33.64	9.60	43.24	61.58	-18.34	peak	
5		16.2281	32.28	9.91	42.19	60.00	-17.81	peak	
6		23.1305	29.08	9.96	39.04	60.00	-20.96	peak	





**4.2 RADIATED EMISSION MEASUREMENT**

**4.2.1 RADIATED EMISSION LIMITS ( FCC 15.209 )**

Frequencies (MHz)	Field Strength (microrvolts/meter)	Measurement Distance (meters)
0.009~0.490	2400/F(KHz)	300
0.490~1.705	24000/F(KHz)	30
1.705~30.0	30	30
30~88	100	3
88~216	150	3
216~960	200	3
Above 960	500	3

Harmonic emissions limits comply with below 54 dBuV/m at 3m. Other emissions radiated outside of the specified frequency bands, except for harmonics, shall be attenuated by at least 50 dB below the level of the fundamental or comply with the radiated emissions limits specified in section 15.209(a) limit in the table below has to be followed.

Note:

- (1) The tighter limit applies at the band edges.
- (2) Emission level (dBuV/m)=20log Emission level (uV/m).

**LIMITS OF RADIATED EMISSION MEASUREMENT ( FCC 15.209 )**

FREQUENCY (MHz)	(dBuV/m) (at 3m)	
	PEAK	AVERAGE
Above 1000	74	54

Notes:

- (1) The limit for radiated test was performed according to FCC PART 15C.
- (2) The tighter limit applies at the band edges.
- (3) Emission level (dBuV/m)=20log Emission level (uV/m).

**LIMITS OF RADIATED EMISSION MEASUREMENT (FCC Part 15.249)**

FCC Part15 (15.249) , Subpart C	
Limit	Frequency Range (MHz)
Field strength of fundamental 50000 μV/m (94 dBμV/m) @ 3 m	2400-2483.5
Field strength of harmonics 500 μV/m (54 dBμV/m) @ 3 m	Above 2483.5



**4.2.2 MEASUREMENT INSTRUMENTS LIST**

Item	Kind of Equipment	Manufacturer	Type No.	Serial No.	Calibrated until
1	Spectrum Analyzer	R&S	FSP-40	100129	Oct. 06, 2012
2	Horn Antenna	Schwarzbeck	BBHA 9120	D-325	Dec. 08, 2011
3	Microwave Pre_amplifier	Agilent	8449B	3008A01714	Apr. 18, 2012
4	Microflex Cable	N/A	N/A	1m	May. 18, 2012
5	Microflex Cable	AISI	S104-SMAP-1	10m	Aug. 22, 2012
6	Microflex Cable	N/A	N/A	3m	Aug. 22, 2012
7	Test Cable	N/A	LMR-400	966_12m	Jun. 16, 2012
8	Test Cable	N/A	LMR-400	966_3m	Jun. 16, 2012
9	Pre-Amplifier	EMC	EMC-330	980001	Jun. 02, 2012
10	Log-Bicon Antenna	Schwarzbeck	VULB9168-352	9168-352	Jun. 16, 2012

Remark: " N/A" denotes No Model Name / Serial No. and No Calibration specified.



#### **4.2.3 TEST PROCEDURE**

- a. The measuring distance of at 3 m shall be used for measurements at frequency up to 1GHz. For frequencies above 1GHz, any suitable measuring distance may be used.
- b. The EUT was placed on the top of a rotating table 0.8 meters above the ground at a 3m or 10 meter open area test site. The table was rotated 360 degrees to determine the position of the highest radiation.
- c. The height of the equipment or of the substitution antenna shall be 0.8 m; the height of the test antenna shall vary between 1 m to 4 m. Both horizontal and vertical polarizations of the antenna are set to make the measurement.
- d. The initial step in collecting radiated emission data is a spectrum analyzer peak detector mode pre-scanning the measurement frequency range. Significant peaks are then marked and then Quasi Peak detector mode re-measured.
- e. If the Peak Mode measured value compliance with and lower than Quasi Peak Mode Limit, the EUT shall be deemed to meet QP Limits and then no additional QP Mode measurement performed.
- f. For the actual test configuration, please refer to the related Item –EUT Test Photos.
- g. A preamp and high pass filter were used for this test in order to provide sufficient measurement sensitivity.
- h. EUT Orthogonal Axis :  
"X" - denotes Laid on Table ; "Y" - denotes Vertical Stand ; "Z" - denotes Side Stand
- i. During the measurements above 1 GHz it is taken care of that the EUT is always within the 3 dB cone of radiation BW of the used antenna

#### **NOTE: (30-1000MHz)**

- a. Reading in which marked as QP or Peak means measurements by using are Quasi-Peak Mode with Detector BW=120 kHz; SPA setting in RBW=120 kHz, VBW =120 kHz, Swp. Time = 0.3 sec./ MHz.
- b. All readings are Peak unless otherwise stated QP in column of Note. Peak denotes that the Peak reading compliance with the QP Limits and then QP Mode measurement didn't perform.

#### **NOTE: (Above 1000MHz)**

- a. Reading in which marked as Peak means measurements by using are Peak Mode with instrument setting in RBW= 1 MHz, VBW= 1 MHz, Swp. Time = Auto.  
Reading in which marked as AV means measurements by using are Average Mode with instrument setting in RBW= 1 MHz, VBW= 10 Hz, Swp. Time = Auto.
- b. All readings are Peak Mode value unless otherwise stated AVG in column of Note. If the Peak Mode Measured value compliance with the Peak Limits and lower than AVG Limits, the EUT shall be deemed to meet both Peak & AVG Limits and then only Peak Mode was measured, but AVG Mode didn't perform.

**4.2.4 DEVIATION FROM TEST STANDARD**

No deviation

**4.2.5 TEST SETUP**

(A) Radiated Emission Test Set-Up, Frequency Below 1000MHz

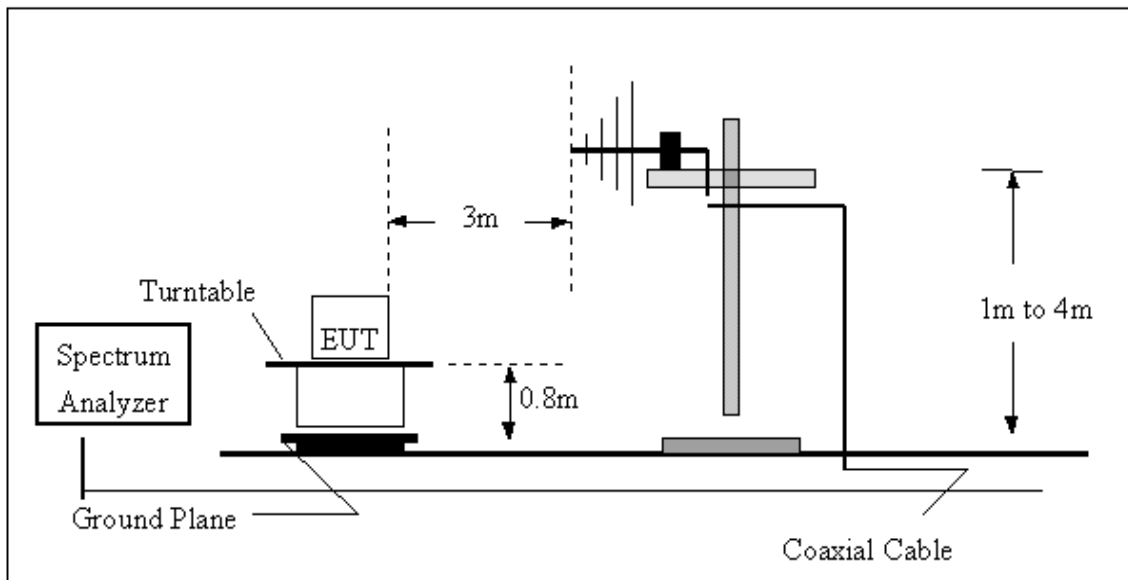

(B) Radiated Emission Test Set-Up Frequency Above 1 GHz

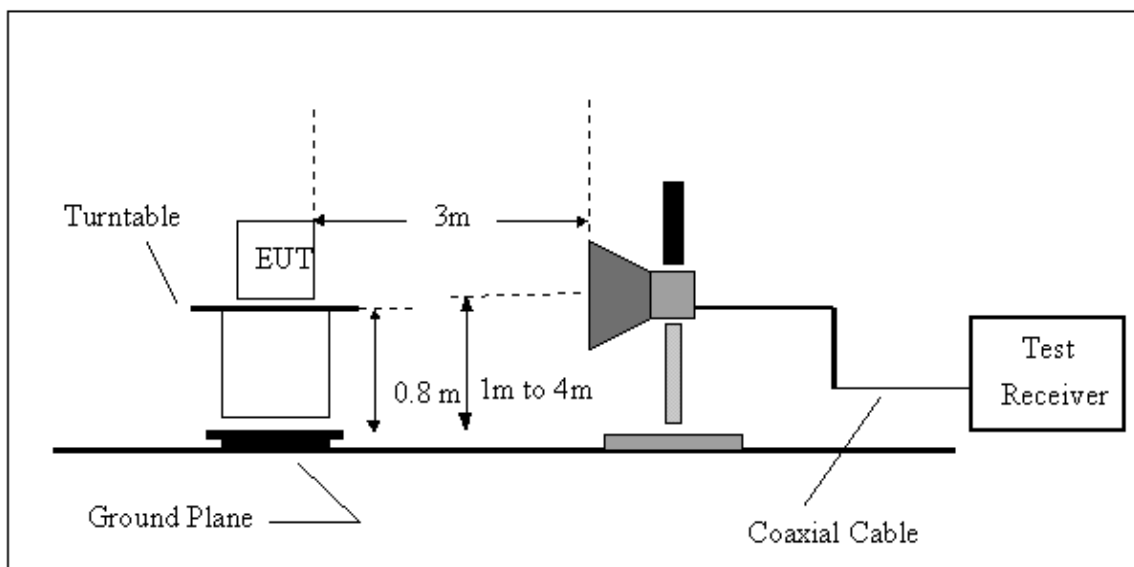



#### **4.2.6 EUT OPERATING CONDITIONS**

The EUT tested system was configured as the statements of **4.1.6** Unless otherwise a special operating condition is specified in the follows during the testing.



**4.2.7 TEST RESULTS-BETWEEN 30MHZ AND 1000MHZ**

E.U.T :	Dongle	Model Name :	SD-9085
Temperature :	26 °C	Relative Humidity :	60%
Test Voltage :	AC 120V/60Hz (System)		
Test Mode :	2442 MHz		

**Polarization: Vertical**

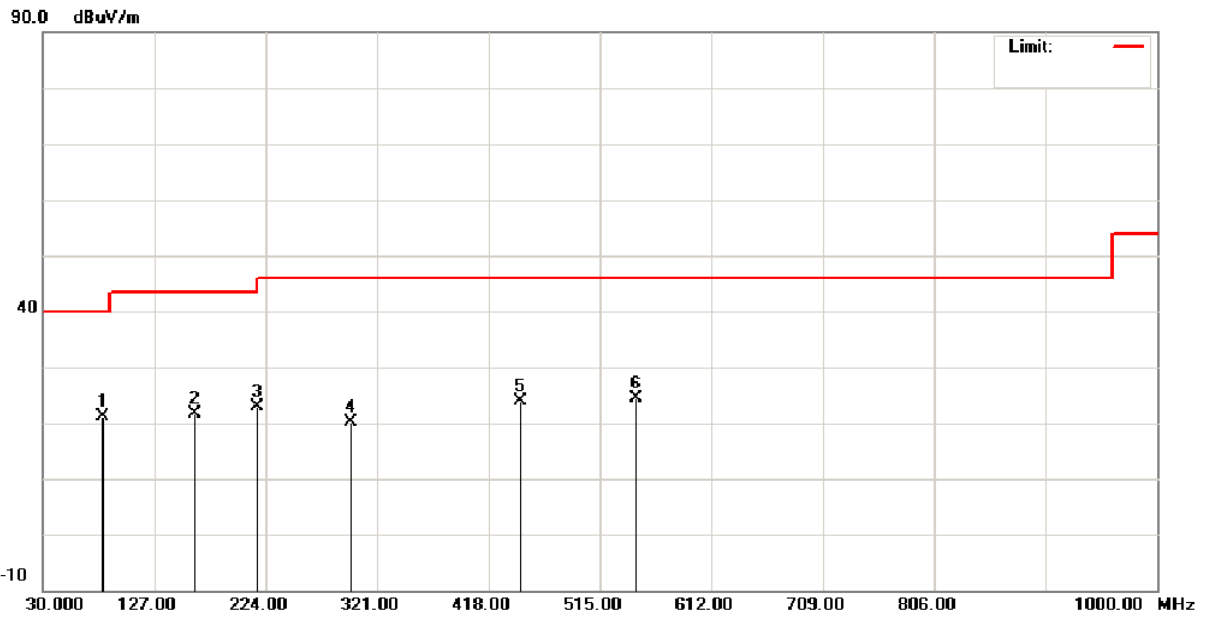

No.	Mk.	Freq. MHz	Reading Level dBuV	Correct Factor dB	Measure- ment dBuV/m	Limit dBuV/m	Over dB	Detector	Comment
1	*	82.3797	38.35	-17.30	21.05	40.00	-18.95	peak	
2		161.9199	34.97	-13.27	21.70	43.50	-21.80	peak	
3		216.2400	38.51	-15.57	22.94	46.00	-23.06	peak	
4		297.7200	32.71	-12.62	20.09	46.00	-25.91	peak	
5		445.1600	32.71	-8.88	23.83	46.00	-22.17	peak	
6		546.0399	31.65	-7.35	24.30	46.00	-21.70	peak	



E.U.T :	Dongle	Model Name :	SD-9085
Temperature :	26 °C	Relative Humidity :	60%
Test Voltage :	AC 120V/60Hz (System)		
Test Mode :	2442 MHz		

**Polarization: Horizontal**

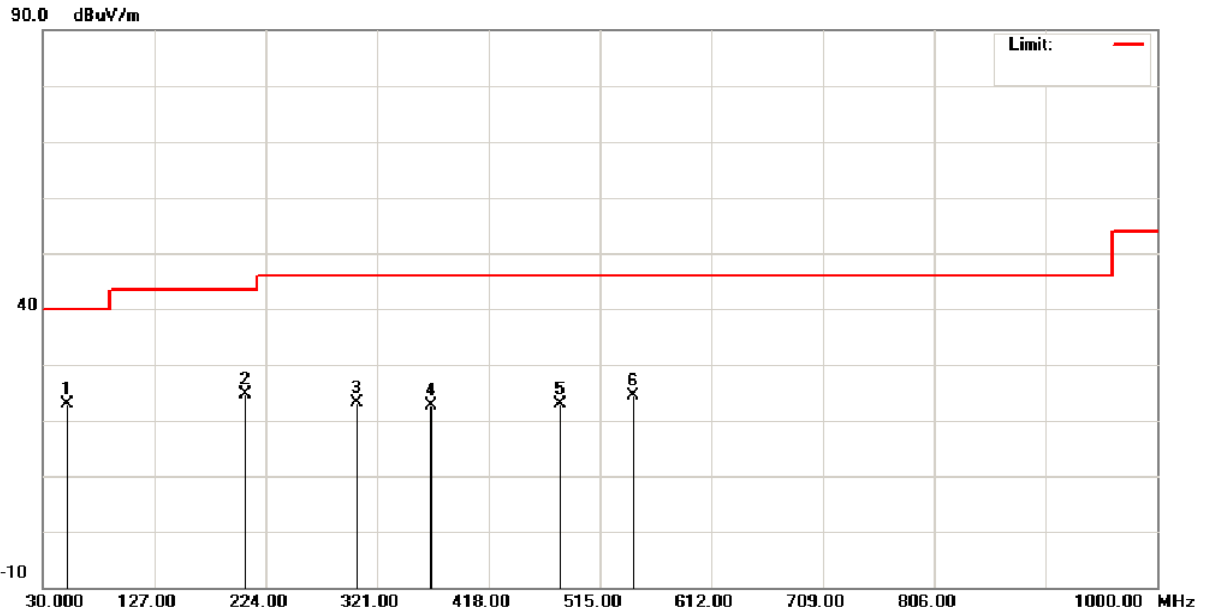

No.	Mk.	Freq. MHz	Reading Level dBuV	Correct Factor dB	Measure- ment dBuV/m	Limit dBuV/m	Over dB	Detector	Comment
1	*	51.3400	35.22	-12.41	22.81	40.00	-17.19	peak	
2		206.5399	40.69	-15.99	24.70	43.50	-18.80	peak	
3		303.5400	35.60	-12.50	23.10	46.00	-22.90	peak	
4		367.5599	33.47	-10.90	22.57	46.00	-23.43	peak	
5		480.0798	31.15	-8.28	22.87	46.00	-23.13	peak	
6		544.0999	31.76	-7.38	24.38	46.00	-21.62	peak	



**4.2.8 TEST RESULTS- FUNDAMENTAL FREQUENCY & ABOVE 1000MHZ**

E.U.T :	Dongle	Model Name :	SD-9085
Temperature :	26 °C	Relative Humidity :	60%
Test Voltage :	AC 120V/60Hz (System)	EUT Orthogonal Axis:	X
Test Mode :	2404 MHz		

**Polarization: Vertical**

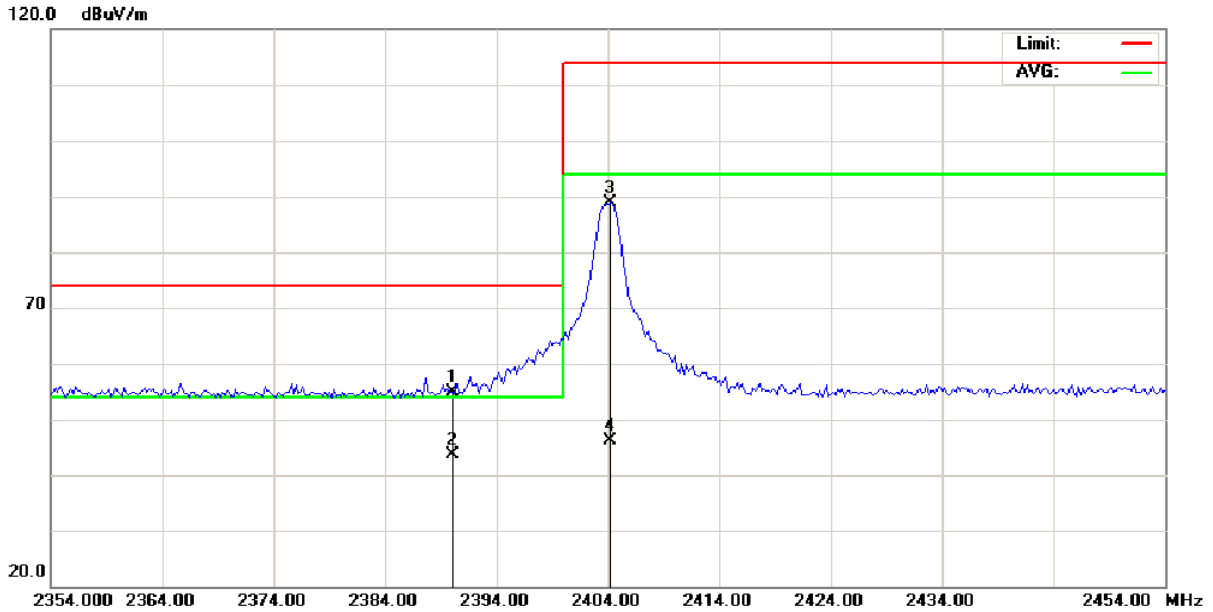

No.	Mk.	Freq. MHz	Reading Level dBuV	Correct Factor dB	Measure- ment dBuV/m	Limit dBuV/m	Over dB	Detector	Comment
1		2390.000	22.64	32.15	54.79	74.00	-19.21	peak	
2	*	2390.000	11.38	32.15	43.53	54.00	-10.47	AVG	
3		2404.200	56.57	32.21	88.78	114.0	-25.22	peak	
4		2404.200	13.88	32.21	46.09	94.00	-47.91	AVG	





E.U.T :	Dongle	Model Name :	SD-9085
Temperature :	26 °C	Relative Humidity :	60%
Test Voltage :	AC 120V/60Hz (System)	EUT Orthogonal Axis:	X
Test Mode :	2404 MHz		

**Polarization: Vertical**

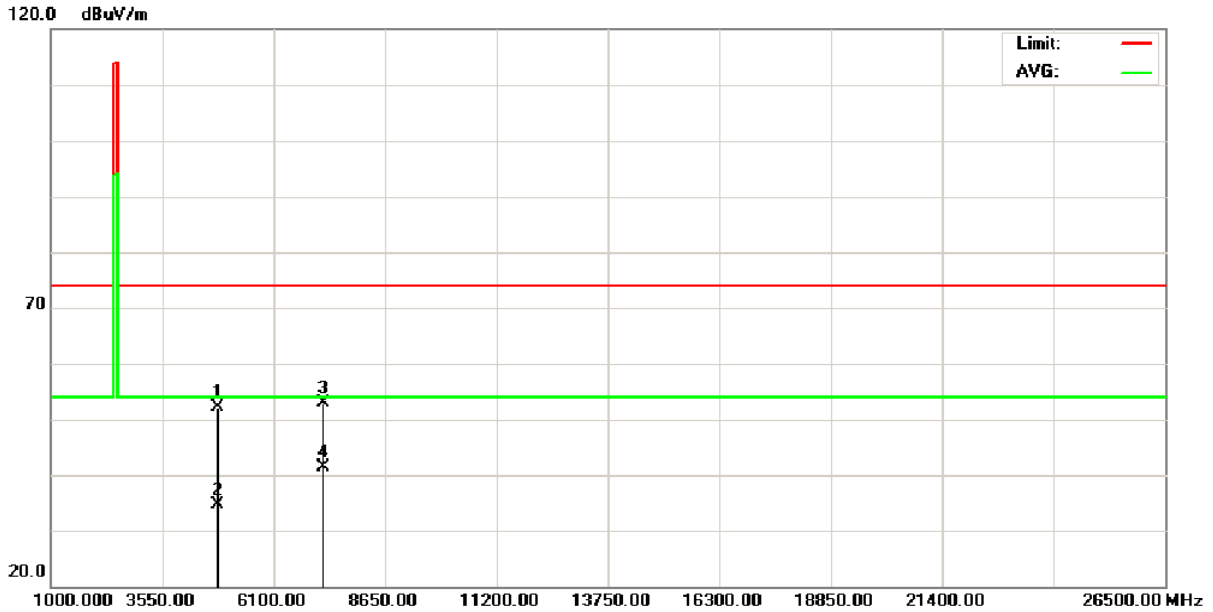

No.	Mk.	Freq. MHz	Reading Level dBuV	Correct Factor dB	Measure- ment dBuV/m	Limit dBuV/m	Over dB	Detector	Comment
1		4807.890	49.29	2.91	52.20	74.00	-21.80	peak	
2		4807.890	31.80	2.91	34.71	54.00	-19.29	AVG	
3		7212.070	42.91	9.86	52.77	74.00	-21.23	peak	
4	*	7212.070	31.58	9.86	41.44	54.00	-12.56	AVG	



E.U.T :	Dongle	Model Name :	SD-9085
Temperature :	26 °C	Relative Humidity :	60%
Test Voltage :	AC 120V/60Hz (System)	EUT Orthogonal Axis:	X
Test Mode :	2404 MHz		

**Polarization: Horizontal**

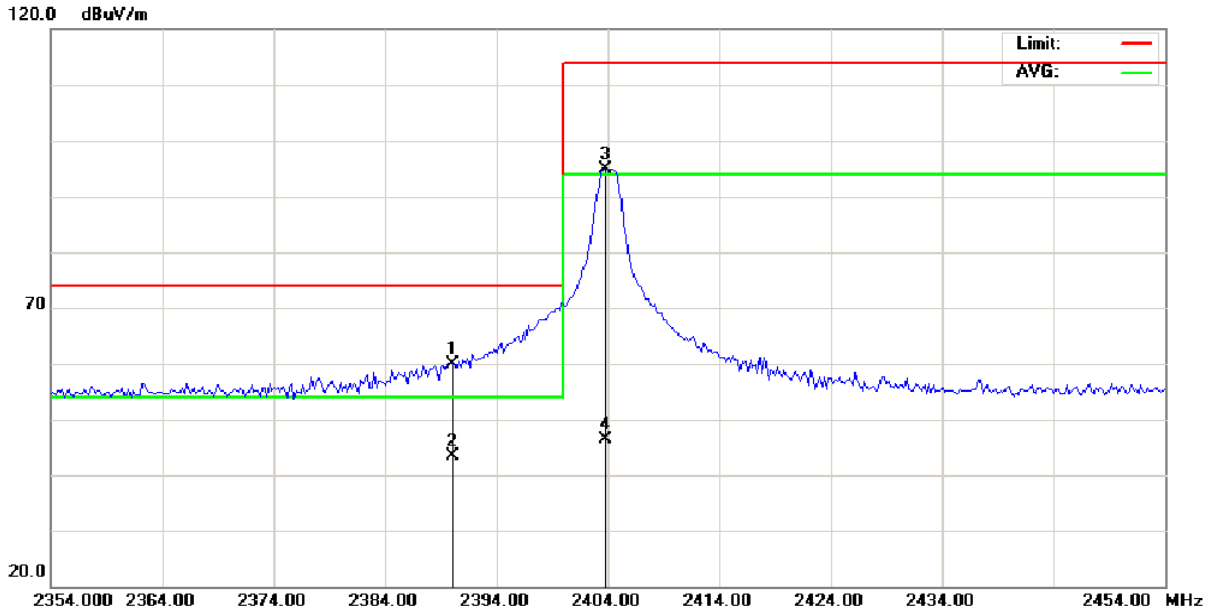

No.	Mk.	Freq. MHz	Reading Level dBuV	Correct Factor dB	Measure- ment dBuV/m	Limit dBuV/m	Over dB	Detector	Comment
1		2390.000	27.74	32.15	59.89	74.00	-14.11	peak	
2	*	2390.000	11.25	32.15	43.40	54.00	-10.60	AVG	
3		2403.800	62.78	32.21	94.99	114.0	-19.01	peak	
4		2403.800	14.24	32.21	46.45	94.00	-47.55	AVG	



E.U.T :	Dongle	Model Name :	SD-9085
Temperature :	26 °C	Relative Humidity :	60%
Test Voltage :	AC 120V/60Hz (System)	EUT Orthogonal Axis:	X
Test Mode :	2404 MHz		

**Polarization: Horizontal**

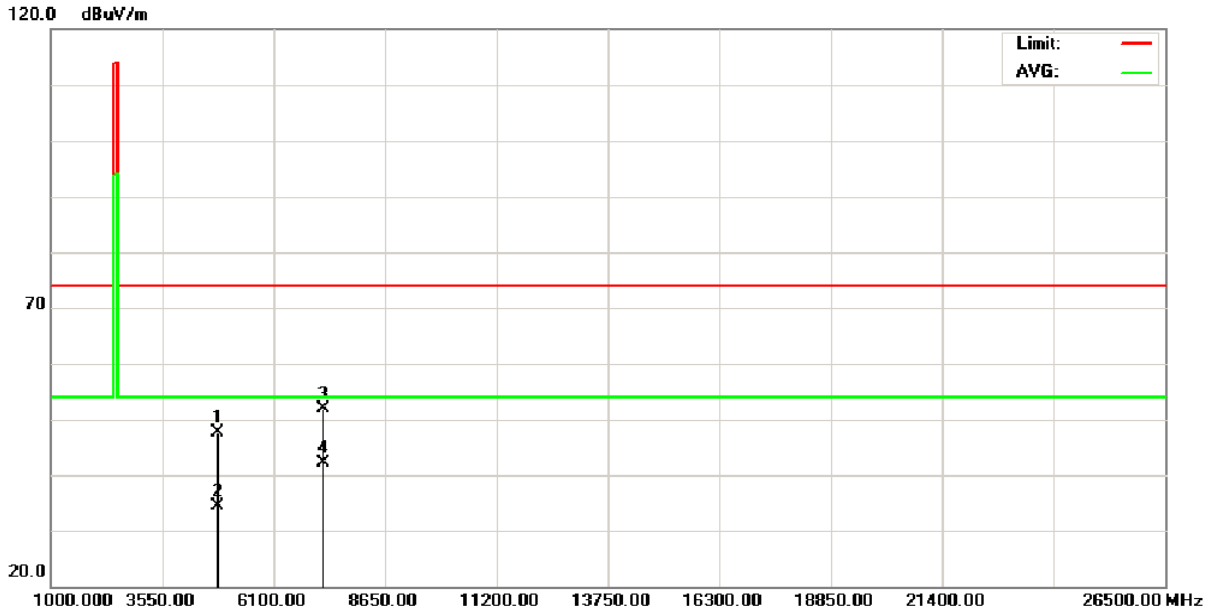

No.	Mk.	Freq. MHz	Reading Level dBuV	Correct Factor dB	Measure- ment dBuV/m	Limit dBuV/m	Over dB	Detector	Comment
1		4807.490	44.76	2.91	47.67	74.00	-26.33	peak	
2		4807.490	31.38	2.91	34.29	54.00	-19.71	AVG	
3		7212.070	42.12	9.86	51.98	74.00	-22.02	peak	
4	*	7212.070	32.33	9.86	42.19	54.00	-11.81	AVG	



E.U.T :	Dongle	Model Name :	SD-9085
Temperature :	26 °C	Relative Humidity :	60%
Test Voltage :	AC 120V/60Hz (System)	EUT Orthogonal Axis:	X
Test Mode :	2442 MHz		

**Polarization: Vertical**

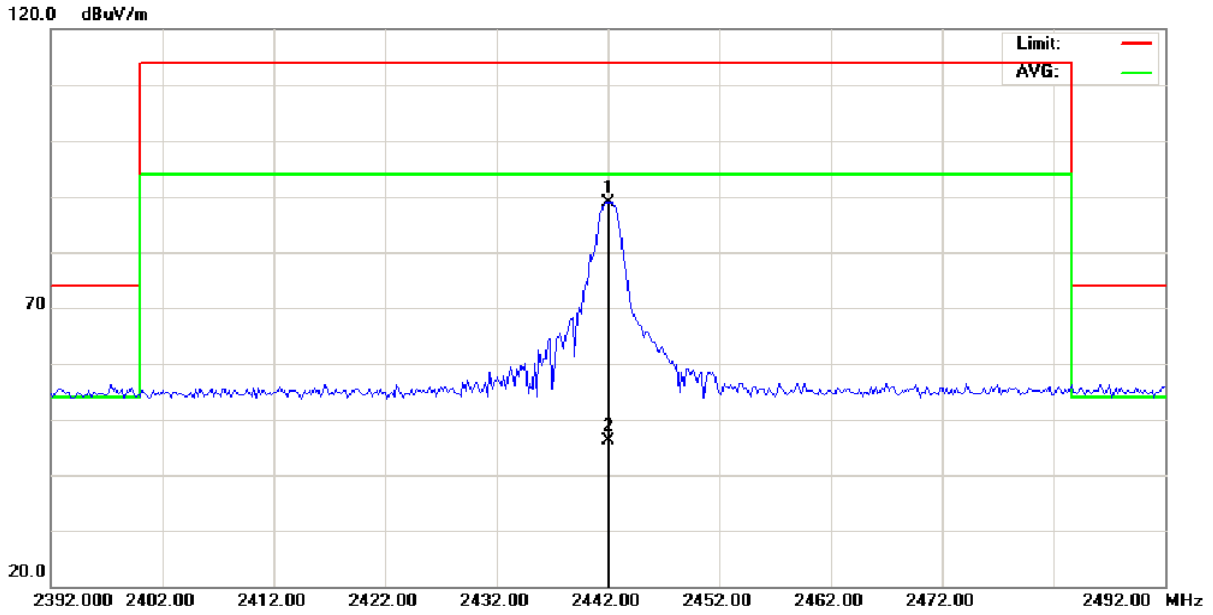

No.	Mk.	Freq. MHz	Reading Level dBuV	Correct Factor dB	Measure- ment dBuV/m	Limit dBuV/m	Over dB	Detector	Comment
1	*	2442.000	56.48	32.39	88.87	114.0	-25.13	peak	
2		2442.000	13.84	32.39	46.23	94.00	-47.77	AVG	



E.U.T :	Dongle	Model Name :	SD-9085
Temperature :	26 °C	Relative Humidity :	60%
Test Voltage :	AC 120V/60Hz (System)	EUT Orthogonal Axis:	X
Test Mode :	2442 MHz		

**Polarization: Vertical**

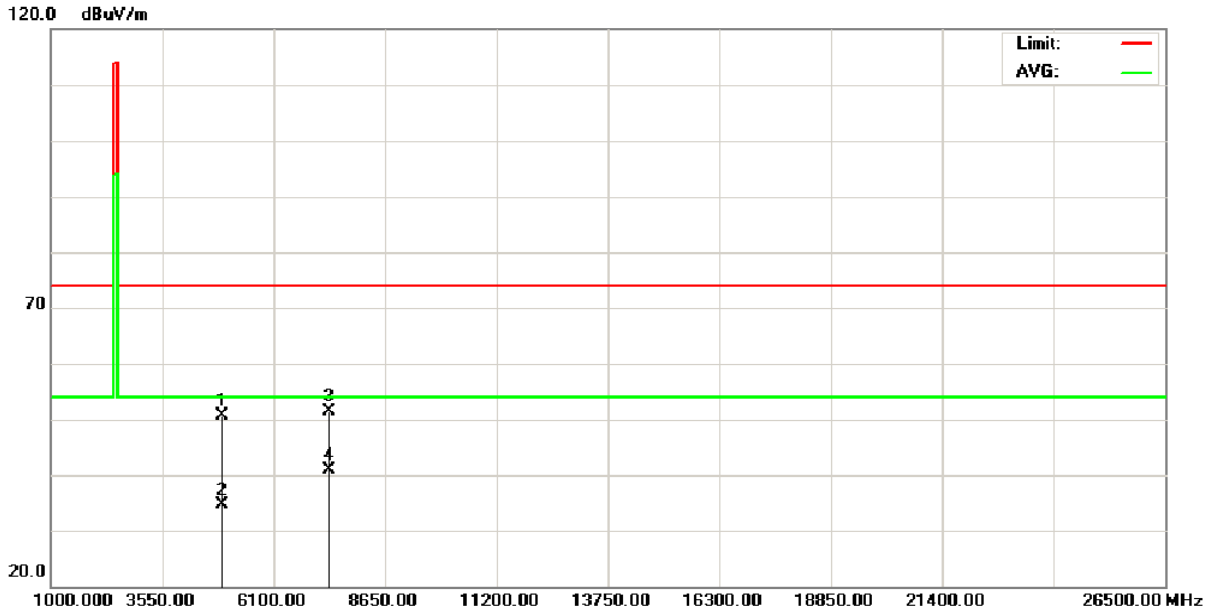

No.	Mk.	Freq. MHz	Reading Level dBuV	Correct Factor dB	Measure- ment dBuV/m	Limit dBuV/m	Over dB	Detector	Comment
1		4883.910	47.43	3.08	50.51	74.00	-23.49	peak	
2		4883.910	31.54	3.08	34.62	54.00	-19.38	AVG	
3		7325.960	41.31	10.01	51.32	74.00	-22.68	peak	
4	*	7325.960	30.97	10.01	40.98	54.00	-13.02	AVG	



E.U.T :	Dongle	Model Name :	SD-9085
Temperature :	26 °C	Relative Humidity :	60%
Test Voltage :	AC 120V/60Hz (System)	EUT Orthogonal Axis:	X
Test Mode :	2442 MHz		

**Polarization: Horizontal**

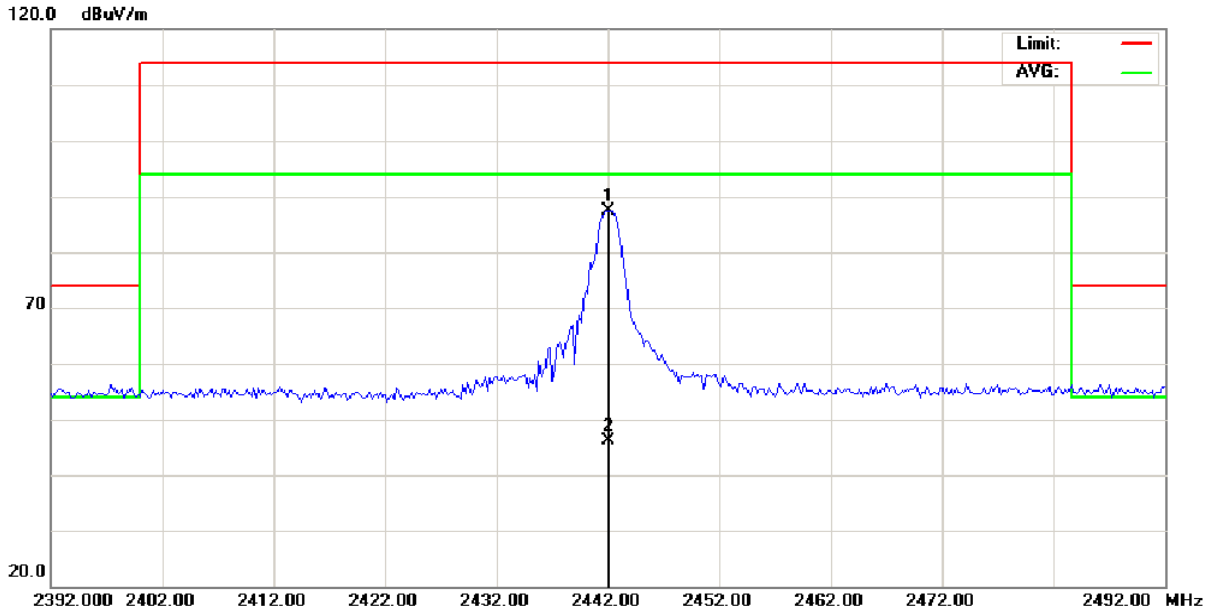

No.	Mk.	Freq. MHz	Reading Level dBuV	Correct Factor dB	Measure- ment dBuV/m	Limit dBuV/m	Over dB	Detector	Comment
1	*	2442.000	54.98	32.39	87.37	114.0	-26.63	peak	
2		2442.000	13.84	32.39	46.23	94.00	-47.77	AVG	



E.U.T :	Dongle	Model Name :	SD-9085
Temperature :	26 °C	Relative Humidity :	60%
Test Voltage :	AC 120V/60Hz (System)	EUT Orthogonal Axis:	X
Test Mode :	2442 MHz		

**Polarization: Horizontal**

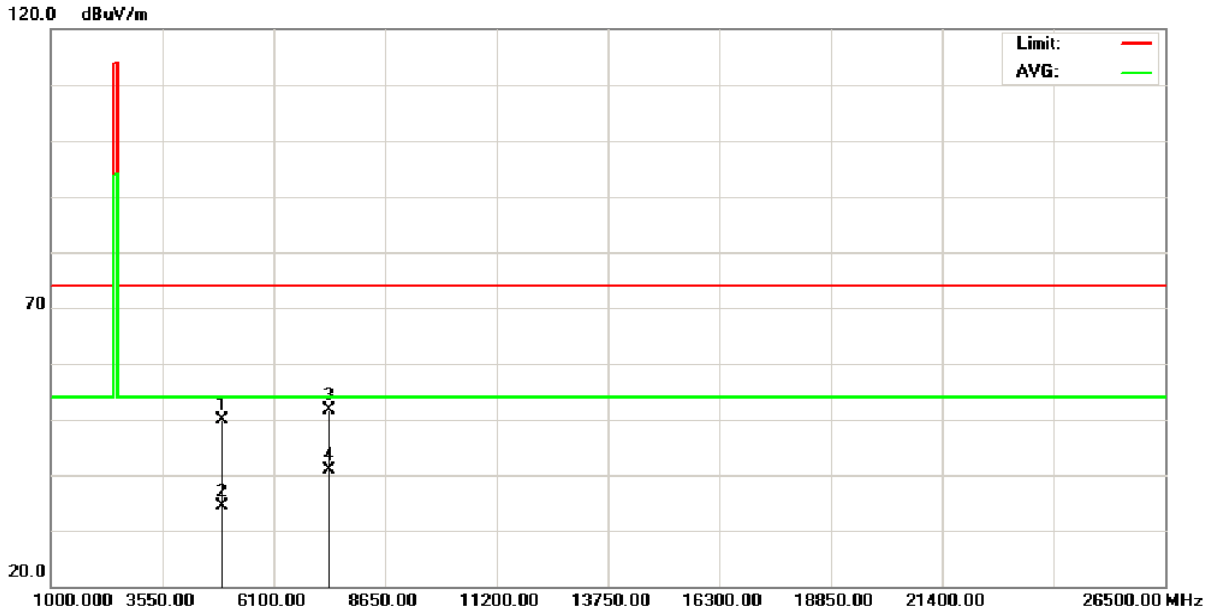

No.	Mk.	Freq. MHz	Reading Level dBuV	Correct Factor dB	Measure- ment dBuV/m	Limit dBuV/m	Over dB	Detector	Comment
1		4884.110	46.73	3.08	49.81	74.00	-24.19	peak	
2		4884.110	31.36	3.08	34.44	54.00	-19.56	AVG	
3		7326.040	41.52	10.01	51.53	74.00	-22.47	peak	
4	*	7326.040	30.94	10.01	40.95	54.00	-13.05	AVG	



E.U.T :	Dongle	Model Name :	SD-9085
Temperature :	26 °C	Relative Humidity :	60%
Test Voltage :	AC 120V/60Hz (System)	EUT Orthogonal Axis:	X
Test Mode :	2478 MHz		

**Polarization: Vertical**

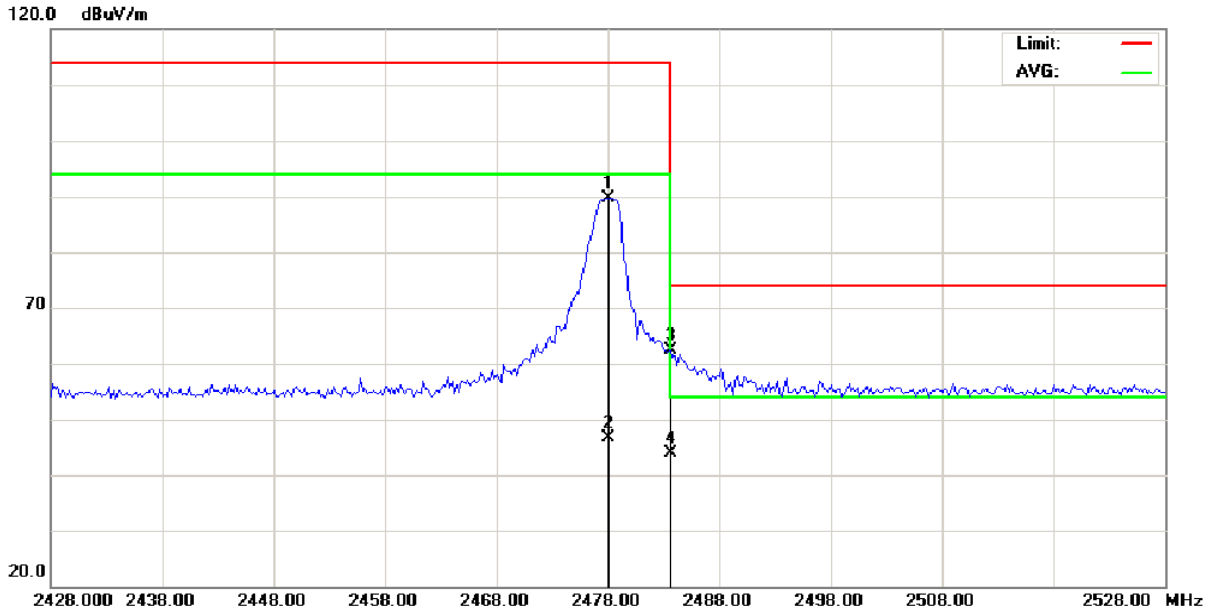

No.	Mk.	Freq. MHz	Reading Level dBuV	Correct Factor dB	Measure- ment dBuV/m	Limit dBuV/m	Over dB	Detector	Comment
1		2478.000	57.16	32.57	89.73	114.0	-24.27	peak	
2		2478.000	13.95	32.57	46.52	94.00	-47.48	AVG	
3		2483.500	29.73	32.59	62.32	74.00	-11.68	peak	
4	*	2483.500	11.32	32.59	43.91	54.00	-10.09	AVG	





E.U.T :	Dongle	Model Name :	SD-9085
Temperature :	26 °C	Relative Humidity :	60%
Test Voltage :	AC 120V/60Hz (System)	EUT Orthogonal Axis:	X
Test Mode :	2478 MHz		

**Polarization: Vertical**

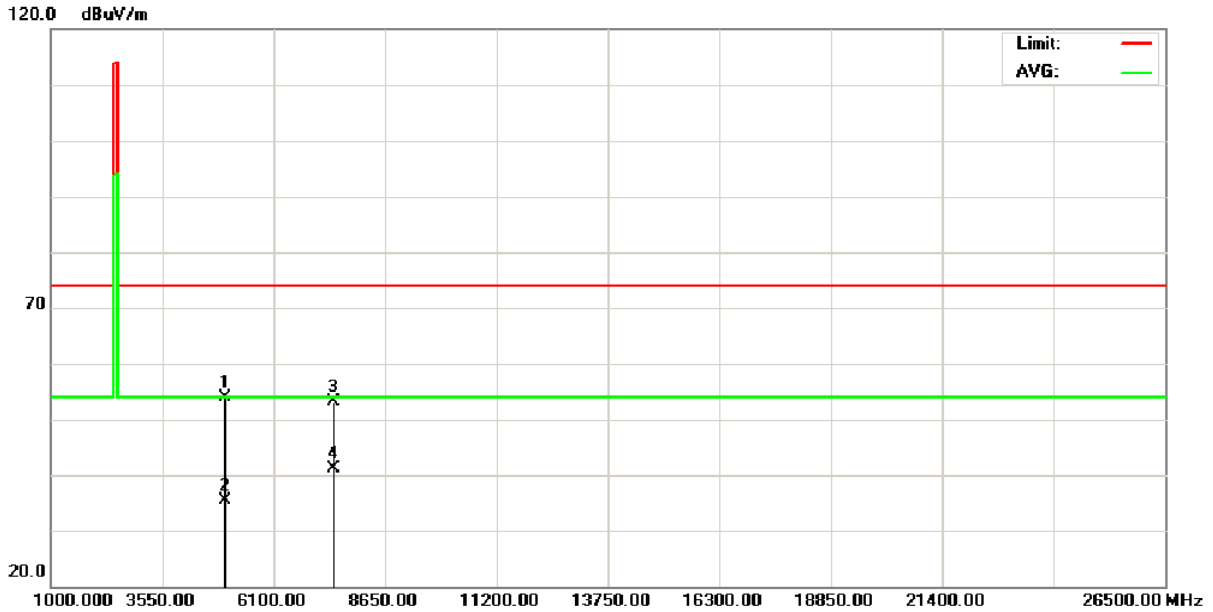

No.	Mk.	Freq. MHz	Reading Level dBuV	Correct Factor dB	Measure- ment dBuV/m	Limit dBuV/m	Over dB	Detector	Comment
1		4955.770	50.52	3.25	53.77	74.00	-20.23	peak	
2		4955.770	32.03	3.25	35.28	54.00	-18.72	AVG	
3		7433.930	42.88	10.16	53.04	74.00	-20.96	peak	
4	*	7433.930	30.95	10.16	41.11	54.00	-12.89	AVG	



E.U.T :	Dongle	Model Name :	SD-9085
Temperature :	26 °C	Relative Humidity :	60%
Test Voltage :	AC 120V/60Hz (System)	EUT Orthogonal Axis:	X
Test Mode :	2478 MHz		

**Polarization: Horizontal**

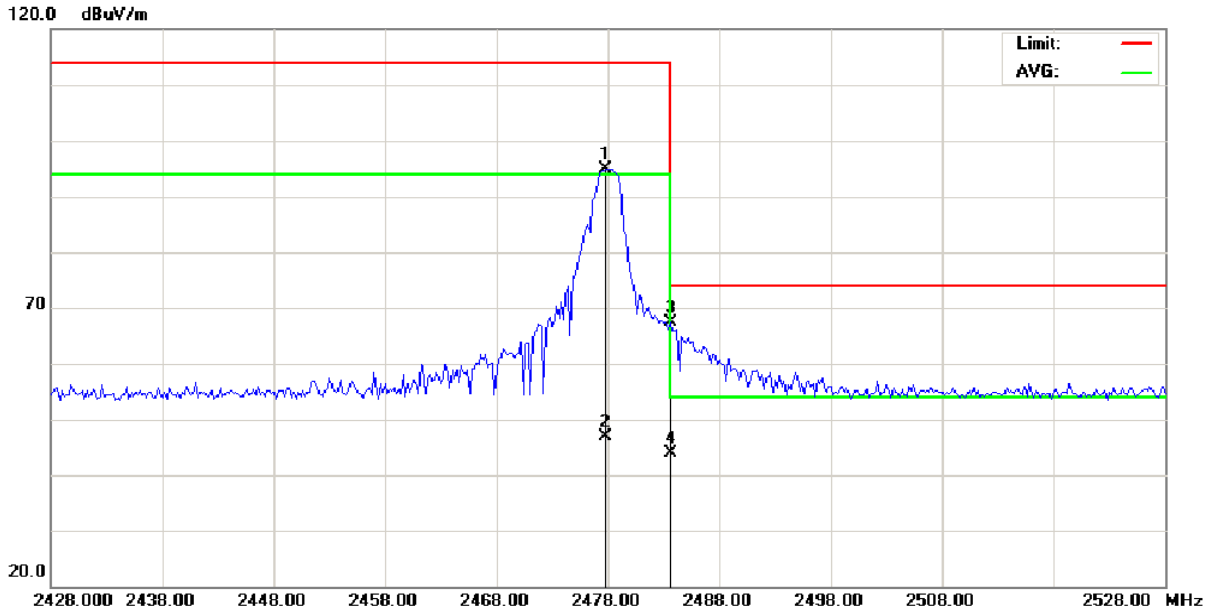

No.	Mk.	Freq. MHz	Reading Level dBuV	Correct Factor dB	Measure- ment dBuV/m	Limit dBuV/m	Over dB	Detector	Comment
1		2477.800	62.24	32.56	94.80	114.0	-19.20	peak	
2		2477.800	14.29	32.56	46.85	94.00	-47.15	AVG	
3	*	2483.500	34.69	32.59	67.28	74.00	-6.72	peak	
4		2483.500	11.36	32.59	43.95	54.00	-10.05	AVG	



E.U.T :	Dongle	Model Name :	SD-9085
Temperature :	26 °C	Relative Humidity :	60%
Test Voltage :	AC 120V/60Hz (System)	EUT Orthogonal Axis:	X
Test Mode :	2478 MHz		

**Polarization: Horizontal**

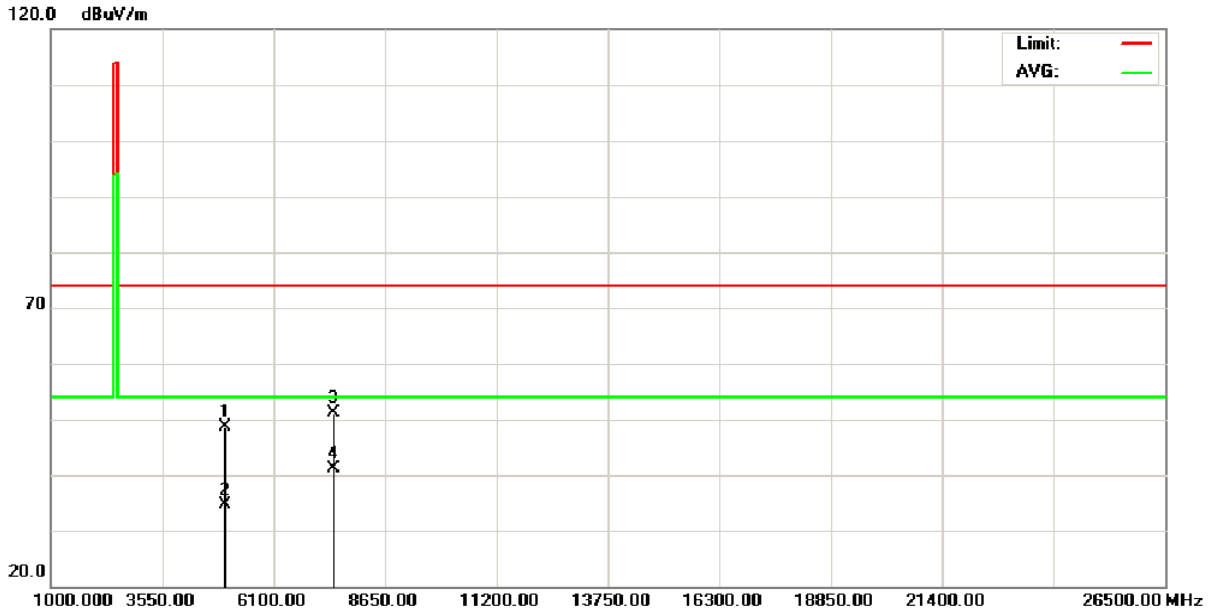

No.	Mk.	Freq. MHz	Reading Level dBuV	Correct Factor dB	Measure- ment dBuV/m	Limit dBuV/m	Over dB	Detector	Comment
1		4955.770	45.37	3.25	48.62	74.00	-25.38	peak	
2		4955.770	31.46	3.25	34.71	54.00	-19.29	AVG	
3		7434.150	40.98	10.16	51.14	74.00	-22.86	peak	
4	*	7434.150	30.95	10.16	41.11	54.00	-12.89	AVG	



**5. ANTENNA CONDUCTED SPURIOUS EMISSION**

**5.1 APPLIED PROCEDURES / LIMIT**

20dBc in any 100 kHz bandwidth outside the operating frequency band. In case the emission fall within the restricted band specified on 15.205(a), then the 15.209(a) limit in the table below has to be followed.

Frequencies (MHz)	Field Strength (micorvolts/meter)	Measurement Distance (meters)
0.009~0.490	2400/F(KHz)	300
0.490~1.705	24000/F(KHz)	30
1.705~30.0	30	30
30~88	100	3
88~216	150	3
216~960	200	3
Above 960	500	3

**5.1.1 MEASUREMENT INSTRUMENTS LIST**

Item	Kind of Equipment	Manufacturer	Type No.	Serial No.	Calibrated until
1	Spectrum Analyzer	R&S	FSP-40	100129	Oct. 06, 2012

Remark: " N/A" denotes No Model Name. , Serial No. or No Calibration specified.

**5.1.2 TEST PROCEDURE**

- a. The EUT was directly connected to the spectrum analyzer and antenna output port as show in the block diagram below,
- b. Spectrum Setting : RBW= 100KHz, VBW=100KHz, Sweep time = 200 ms.

**5.1.3 DEVIATION FROM STANDARD**

No deviation.

**5.1.4 TEST SETUP**



**5.1.5 EUT OPERATION CONDITIONS**

The EUT tested system was configured as the statements of 4.1.6 Unless otherwise a special operating condition is specified in the follows during the testing.



**5.1.6 TEST RESULTS**

E.U.T :	Dongle	Model Name :	SD-9085
Temperature :	26 ° C	Relative Humidity :	60%
Test Voltage :	AC 120V/60Hz (System)	EUT Orthogonal Axis:	X
Test Mode :	2404 MHz / 2478 MHz		

Channel of Worst Data			
The max. radio frequency power in any 100kHz bandwidth outside the frequency band		The max. radio frequency power in any 100 kHz bandwidth within the frequency band.	
FREQUENCY(MHz)	POWER(dBm)	FREQUENCY(MHz)	POWER(dBm)
2388.80	-52.39	2484.90	-45.41
Result			
In any 100kHz bandwidth outside the frequency band, the radio frequency power is at least 50dB below that in the 100kHz bandwidth within the band that contains the highest level of the desired power.			



2404 MHz/The max. radio frequency power in any 100kHz bandwidth outside the frequency band

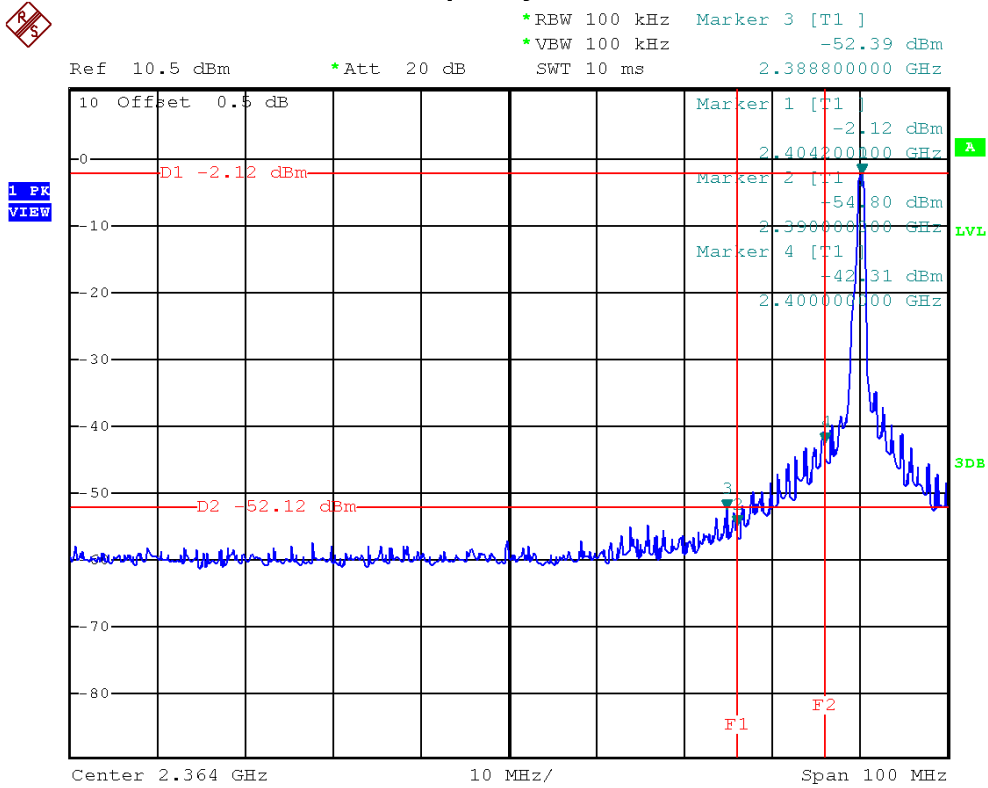

2478 MHz/The max. radio frequency power in any 100 kHz bandwidth within the frequency band

