

FCC Test Report

Report No.: RFBEKC-WTW-P22080971

FCC ID: H4IAW620M

Test Model: AW620M

Received Date: 2022/8/30

Test Date: 2022/9/5 ~ 2022/9/27

Issued Date: 2022/10/13

Applicant: LITE-ON Technology Corp.

Address: 16F, 392, Ruey Kuang Road, Neihu, Taipei 11492, Taiwan, R.O.C

Issued By: Bureau Veritas Consumer Products Services (H.K.) Ltd., Taoyuan Branch
Lin Kou Laboratories

Lab Address: No. 47-2, 14th Ling, Chia Pau Vil., Lin Kou Dist., New Taipei City, Taiwan

**FCC Registration /
Designation Number:** 198487 / TW2021



This report is governed by, and incorporates by reference, the Conditions of Testing as posted at the date of issuance of this report at <http://www.bureauveritas.com/home/about-us/our-business/cps/about-us/terms-conditions/> and is intended for your exclusive use. Any copying or replication of this report to or for any other person or entity, or use of our name or trademark, is permitted only with our prior written permission. This report sets forth our findings solely with respect to the test samples identified herein. The results set forth in this report are not indicative or representative of the quality or characteristics of the lot from which a test sample was taken or any similar or identical product unless specifically and expressly noted. Our report includes all of the tests requested by you and the results thereof based upon the information that you provided to us. Measurement uncertainty is only provided upon request for accredited tests. Statements of conformity are based on simple acceptance criteria without taking measurement uncertainty into account, unless otherwise requested in writing. You have 60 days from date of issuance of this report to notify us of any material error or omission caused by our negligence or if you require measurement uncertainty; provided, however, that such notice shall be in writing and shall specifically address the issue you wish to raise. A failure to raise such issue within the prescribed time shall constitute your unqualified acceptance of the completeness of this report, the tests conducted and the correctness of the report contents.

Table of Contents

Release Control Record	3
1 Certificate of Conformity	4
2 Summary of Test Results	5
2.1 Measurement Uncertainty.....	5
2.2 Modification Record.....	5
3 General Information	6
3.1 General Description of EUT.....	6
3.2 Description of Test Modes.....	7
3.2.1 Test Mode Applicability and Tested Channel Detail.....	8
3.3 Duty Cycle of Test Signal.....	9
3.4 Description of Support Units.....	10
3.4.1 Configuration of System under Test.....	10
3.5 General Description of Applied Standards.....	12
4 Test Types and Results	13
4.1 Radiated Emission and Bandedge Measurement.....	13
4.1.1 Limits of Radiated Emission and Bandedge Measurement.....	13
4.1.2 Test Instruments.....	14
4.1.3 Test Procedures.....	16
4.1.4 Deviation from Test Standard.....	16
4.1.5 Test Setup.....	17
4.1.6 EUT Operating Conditions.....	18
4.1.7 Test Results.....	19
4.2 Conducted Emission Measurement.....	26
4.2.1 Limits of Conducted Emission Measurement.....	26
4.2.2 Test Instruments.....	26
4.2.3 Test Procedures.....	27
4.2.4 Deviation From Test Standard.....	27
4.2.5 Test Setup.....	27
4.2.6 EUT Operating Condition.....	27
4.2.7 Test Results.....	28
4.3 Channel Bandwidth.....	32
4.3.1 Test Setup.....	32
4.3.2 Test Instruments.....	32
4.3.3 Test Procedure.....	32
4.3.4 Deviation from Test Standard.....	32
4.3.5 EUT Operating Condition.....	32
4.3.6 Test Results.....	33
5 Pictures of Test Arrangements	34
Appendix – Information of the Testing Laboratories	35

Release Control Record

Issue No.	Description	Date Issued
RFBEKC-WTW-P22080971	Original release.	2022/10/13

1 Certificate of Conformity

Product: Gaming Mouse

Brand: ALIENWARE, DELL

Test Model: AW620M

Sample Status: Engineering sample

Applicant: LITE-ON Technology Corp.

Test Date: 2022/9/5 ~ 2022/9/27

Standards: 47 CFR FCC Part 15, Subpart C (Section 15.249)
ANSI C63.10: 2013

The above equipment has been tested by **Bureau Veritas Consumer Products Services (H.K.) Ltd., Taoyuan Branch**, and found compliance with the requirement of the above standards. The test record, data evaluation & Equipment Under Test (EUT) configurations represented herein are true and accurate accounts of the measurements of the sample's RF characteristics under the conditions specified in this report.

Prepared by :

Jessica Cheng

Date:

2022/10/13

Jessica Cheng / Senior Specialist

Approved by :

Jeremy Lin

Date:

2022/10/13

Jeremy Lin / Project Engineer

2 Summary of Test Results

47 CFR FCC Part 15, Subpart C (SECTION 15.249)			
FCC Clause	Test Item	Result	Remarks
15.207	AC Power Conducted Emission	PASS	Meet the requirement of limit. Minimum passing margin is -14.15dB at 0.41972MHz.
15.215	Channel Bandwidth Measurement	PASS	Meet the requirement of limit.
15.209 15.249 (a) 15.249 (d)	Radiated Emission and Bandedge Measurement	PASS	Meet the requirement of limit. Minimum passing margin is -9.6dB at 263.24MHz.
15.203	Antenna Requirement	PASS	No antenna connector is used.

Note: Determining compliance based on the results of the compliance measurement, not taking into account measurement instrumentation uncertainty.

2.1 Measurement Uncertainty

Where relevant, the following measurement uncertainty levels have been estimated for tests performed on the EUT as specified in CISPR 16-4-2:

Measurement	Specification	Expanded Uncertainty (k=2) (±)
Conducted Out of Band Emissions	9 kHz ~ 40 GHz	2.63 dB
AC Power Conducted Emissions	150kHz ~ 30MHz	3.00 dB
Unwanted Emissions below 1 GHz	9 kHz ~ 30 MHz	2.38 dB
	30 MHz ~ 1 GHz	5.62 dB
Unwanted Emissions above 1 GHz	1 GHz ~ 6 GHz	4.61 dB
	6 GHz ~ 18 GHz	5.41 dB
	18 GHz ~ 40 GHz	5.14 dB

2.2 Modification Record

There were no modifications required for compliance.

3 General Information

3.1 General Description of EUT

Product	Gaming Mouse
Brand	ALIENWARE, DELL
Test Model	AW620M
Status of EUT	Engineering sample
Power Supply Rating	3.7Vdc from battery or 5V, 500mA
Modulation Type	GFSK
Operating Frequency	2403MHz ~ 2480MHz
Number of Channel	78
Field Strength	79.8 dBuV/m (3m)
Antenna Type	Chip antenna with 0.6dBi gain
Antenna Connector	N/A
Accessory Device	N/A
Data Cable Supplied	Shielded USB cable (1.8m)

Note:

1. Due to radiated measurements are made and the antenna gain is already accounted for this device, so provide an antenna datasheet and/or antenna measurement report is not required. The antenna dimensions and pictures (include antenna wire length if have) are stated in EUT photo exhibit.
2. For Radiated Emissions test of charging mode, following modes were pre-tested:
 - ✧ Charging Mode (Powered from Adapter)
 - ✧ Charging Mode (Powered from Notebook)
 The worst emission level was found when the EUT tested under **Charging Mode (Powered from Notebook)**, therefore, only its test data was recorded in this report.
3. The above EUT information is declared by manufacturer and for more detailed features description, please refers to the manufacturer's specifications or user's manual.

3.2 Description of Test Modes

78 channels are provided to this EUT:

Channel	Freq. (MHz)	Channel	Freq. (MHz)	Channel	Freq. (MHz)	Channel	Freq. (MHz)
0	2403	20	2423	40	2443	60	2463
1	2404	21	2424	41	2444	61	2464
2	2405	22	2425	42	2445	62	2465
3	2406	23	2426	43	2446	63	2466
4	2407	24	2427	44	2447	64	2467
5	2408	25	2428	45	2448	65	2468
6	2409	26	2429	46	2449	66	2469
7	2410	27	2430	47	2450	67	2470
8	2411	28	2431	48	2451	68	2471
9	2412	29	2432	49	2452	69	2472
10	2413	30	2433	50	2453	70	2473
11	2414	31	2434	51	2454	71	2474
12	2415	32	2435	52	2455	72	2475
13	2416	33	2436	53	2456	73	2476
14	2417	34	2437	54	2457	74	2477
15	2418	35	2438	55	2458	75	2478
16	2419	36	2439	56	2459	76	2479
17	2420	37	2440	57	2460	77	2480
18	2421	38	2441	58	2461		
19	2422	39	2442	59	2462		

3.2.1 Test Mode Applicability and Tested Channel Detail

EUT Configure Mode	Applicable To				Description
	RE \geq 1G	RE<1G	PLC	APCM	
A	√	√	-	√	Operating Mode (EUT only)
B	-	√	√	-	Charging Mode (Powered from Notebook)
C	-	-	√	-	Charging Mode (Powered from Adapter)

Where **RE \geq 1G**: Radiated Emission above 1GHz & Bandedge Measurement
RE<1G: Radiated Emission below 1GHz
PLC: Power Line Conducted Emission
APCM: Antenna Port Conducted Measurement

Radiated Emission Test (Above 1GHz):

- Pre-Scan has been conducted to determine the worst-case mode from all possible combinations between available modulations, data rates and antenna ports (if EUT with antenna diversity architecture).
- Following channel(s) was (were) selected for the final test as listed below.

EUT Configure Mode	Available Channel	Tested Channel	Modulation Type
A	0 to 77	0, 38, 77	GFSK

Radiated Emission Test (Below 1GHz):

- Pre-Scan has been conducted to determine the worst-case mode from all possible combinations between available modulations, data rates and antenna ports (if EUT with antenna diversity architecture).
- Following channel(s) was (were) selected for the final test as listed below.

EUT Configure Mode	Available Channel	Tested Channel	Modulation Type
A	0 to 77	0	GFSK
B	-	--	

Power Line Conducted Emission Test:

- Pre-Scan has been conducted to determine the worst-case mode from all possible combinations between available modulations, data rates and antenna ports (if EUT with antenna diversity architecture).
- Following channel(s) was (were) selected for the final test as listed below.

EUT Configure Mode	Available Channel	Tested Channel	Modulation Type
B & C	-	--	

Antenna Port Conducted Measurement:

- This item includes all test value of each mode, but only includes spectrum plot of worst value of each mode.
- Pre-Scan has been conducted to determine the worst-case mode from all possible combinations between available modulations, data rates and antenna ports (if EUT with antenna diversity architecture).
- Following channel(s) was (were) selected for the final test as listed below.

EUT Configure Mode	Available Channel	Tested Channel	Modulation Type
A	0 to 77	0, 38, 77	GFSK

Test Condition:

Applicable To	EUT Configure Mode	Environmental Conditions	Input Power	Tested By
RE \geq 1G	A	18.4deg. C, 64.2%RH	3.7Vdc	Jed Wu
RE<1G	A	19deg. C, 63%RH	3.7Vdc	Jed Wu
	B	19deg. C, 63%RH	120Vac, 60Hz (System)	Jed Wu
PLC	B	25deg. C, 75%RH	120Vac, 60Hz (System)	Jed Wu
	C	25deg. C, 75%RH	120Vac, 60Hz (Adapter)	Jed Wu
APCM	A	25deg. C, 76%RH	3.7Vdc	Dalen Dai

3.3 Duty Cycle of Test Signal

Duty cycle correction factor = $20 \log(\text{Duty cycle}) = 20 \log(0.115) = -18.8\text{dB}$

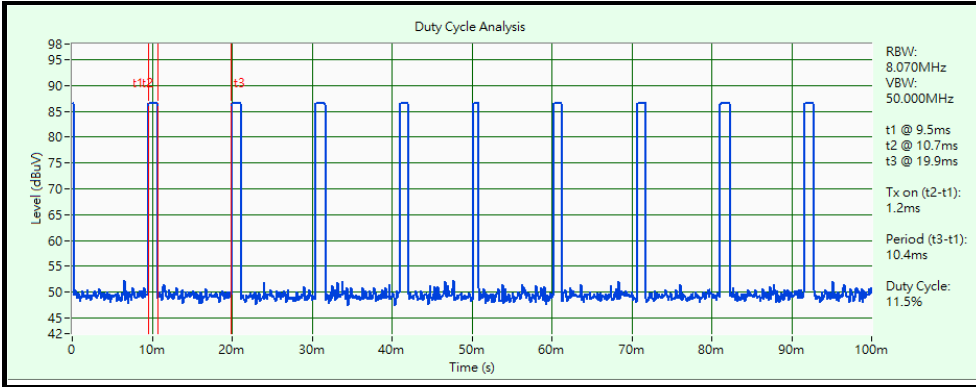

3.4 Description of Support Units

The EUT has been tested as an independent unit together with other necessary accessories or support units. The following support units or accessories were used to form a representative test configuration during the tests.

ID	Product	Brand	Model No.	Serial No.	FCC ID	Remarks
A	Notebook	Lenovo	80WG	YD01YRC9	N/A	Provided by Lab
B	Notebook Adapter	Lenovo	PA-1450-55LL	N/A	N/A	Provided by Lab
C	Adapter	Apple	A1385	N/A	N/A	Provided by Lab

ID	Cable Descriptions	Qty.	Length (m)	Shielding (Yes/No)	Cores (Qty.)	Remarks
1	USB Type C Cable	1	2.0	Y	0	Supplied by applicant
2	Adapter Cable	1	1.5	N	0	Provided by Lab

3.4.1 Configuration of System under Test

Mode A- Operating Mode

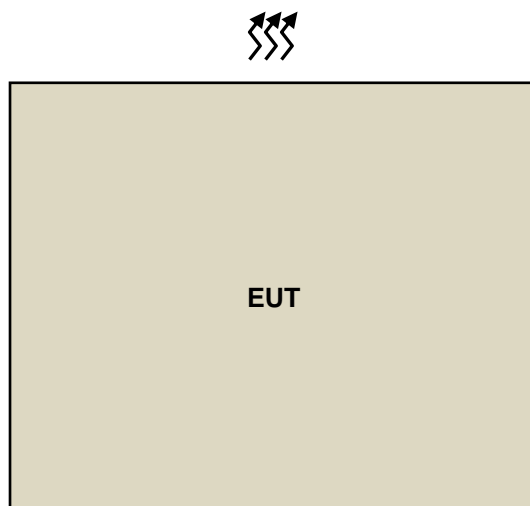

Mode B- Charging Mode (Powered from Notebook)

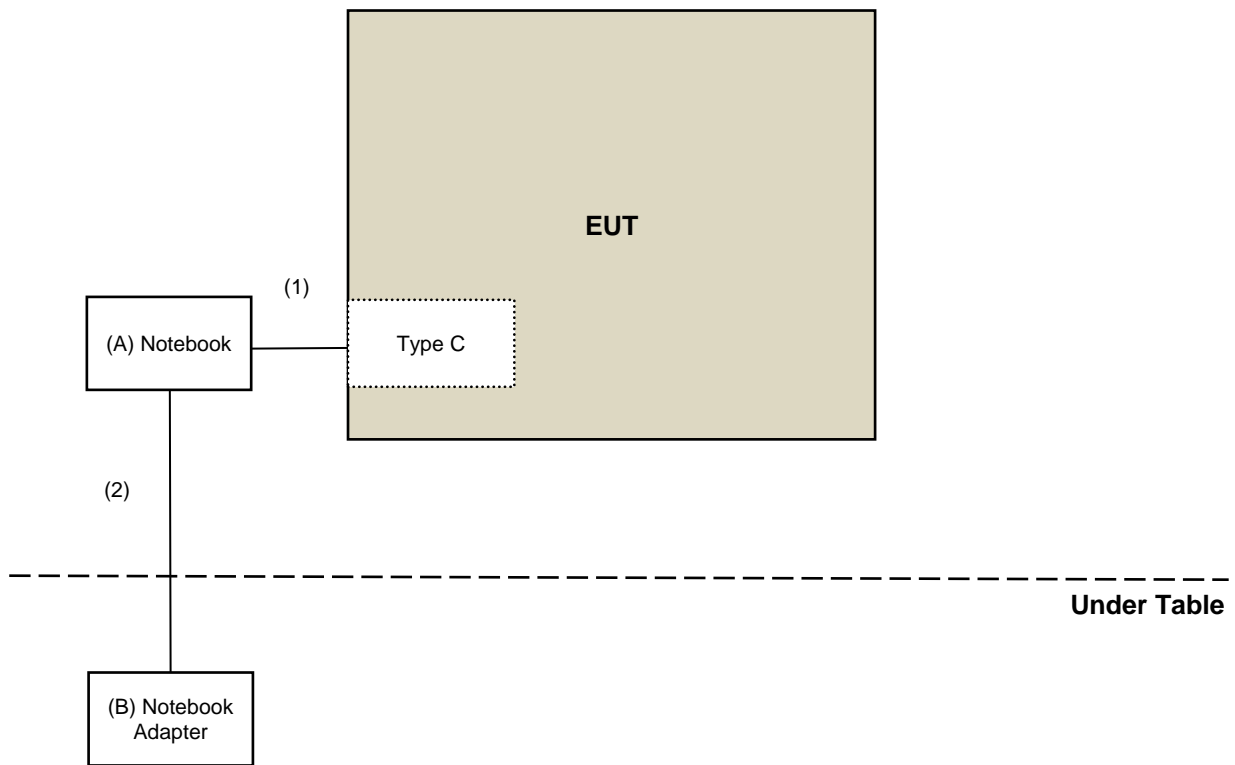

Mode C- Charging Mode (Powered from Adapter)

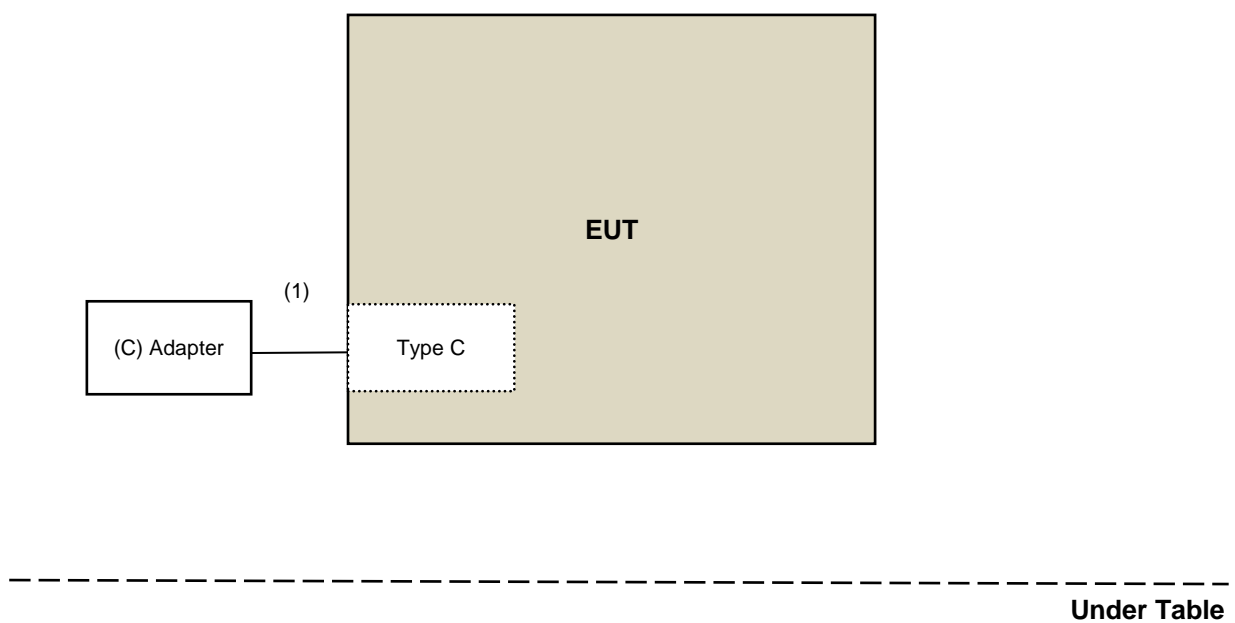

3.5 General Description of Applied Standards

The EUT is a RF Product. According to the specifications of the manufacturer, it must comply with the requirements of the following standards:

FCC Part 15, Subpart C (15.249)

ANSI C63.10-2013

All test items have been performed and recorded as per the above standards.

4 Test Types and Results

4.1 Radiated Emission and Bandedge Measurement

4.1.1 Limits of Radiated Emission and Bandedge Measurement

The field strength of emissions from intentional radiators operated within these frequency bands shall comply with the following

Fundamental Frequency	Field Strength of Fundamental (millivolts/meter)	Field Strength of Harmonics (microvolts/meter)
902 ~ 928 MHz	50	500
2400 ~ 2483.5 MHz	50	500
5725 ~ 5875 MHz	50	500
24 ~ 24.25 GHz	250	2500

Emissions radiated outside of the specified frequency bands, except for harmonics, shall be attenuated by at least 50 dB below the level of the fundamental or to the general radiated emission limits as below table, whichever is the lesser attenuation

Frequencies (MHz)	Field Strength (microvolts/meter)	Measurement Distance (meters)
0.009 ~ 0.490	2400/F(kHz)	300
0.490 ~ 1.705	24000/F(kHz)	30
1.705 ~ 30.0	30	30
30 ~ 88	100	3
88 ~ 216	150	3
216 ~ 960	200	3
Above 960	500	3

NOTE:

1. The lower limit shall apply at the transition frequencies.
2. Emission level (dBuV/m) = 20 log Emission level (uV/m).
3. For frequencies above 1000MHz, the field strength limits are based on average detector, however, the peak field strength of any emission shall not exceed the maximum permitted average limits, specified above by more than 20dB under any condition of modulation.

4.1.2 Test Instruments

Unwanted Emissions below 1 GHz

Description Manufacturer	Model No.	Serial No.	Calibrated Date	Calibrated Until
LOOP ANTENNA EMCI	LPA600	270	2021/9/2	2023/9/1
Bi_Log Antenna Schwarzbeck	VULB 9168	137	2021/10/27	2022/10/26
Coupling/Dcoupling Network Schwarzbeck	CDNE-M2	00097	2022/6/1	2023/5/31
	CDNE-M3	00091	2022/6/1	2023/5/31
Pre_Amplifier EMCI	EMC001340	980269	2022/6/28	2023/6/27
Pre_Amplifier HP	8447D	2432A03504	2022/2/17	2023/2/16
RF Coaxial Cable Pacific	8D-FB	Cable-CH6-02	2022/6/30	2023/6/29
Software BVADT	Radiated_V8.7.08	N/A	N/A	N/A
Spectrum Analyzer R&S	FSV40	101544	2022/5/9	2023/5/8
Test Receiver Agilent	N9038A	MY51210129	2022/4/8	2023/4/7
		MY51210137	2022/6/9	2023/6/8
Tower ADT	AT100	0306	N/A	N/A
Turn Table ADT	TT100	0306	N/A	N/A

Notes:

1. The calibration interval of the above test instruments is 12/24 months. And the calibrations are traceable to NML/ROC and NIST/USA.
2. The test was performed in Linkou 966 Chamber 6 (CH 6).
3. Tested Date: 2022/9/6

Unwanted Emissions above 1 GHz

Description Manufacturer	Model No.	Serial No.	Calibrated Date	Calibrated Until
Band Pass Filter MICRO-TRONICS	BRM17690	005	2022/5/26	2023/5/25
Boresight antenna tower fixture BV	BAF-02	6	N/A	N/A
High Pass Filter Wainwright Instruments	WHK 3.1/18G-10SS	SN 8	2022/5/26	2023/5/25
Horn Antenna EMCO	3115	00027024	2021/11/14	2022/11/13
		00028257	2021/11/14	2022/11/13
Horn Antenna ETS-Lindgren	3117-PA	00215857	2021/11/14	2022/11/13
Horn Antenna Schwarzbeck	BBHA 9170	212	2021/10/13	2022/10/12
Notch Filter MICRO-TRONICS	BRC50703-01	010	2022/5/26	2023/5/25
Pre-amplifier HP	8449B	3008A01201	2022/2/17	2023/2/16
Pre-amplifier (18GHz-40GHz) EMCI	EMC184045B	980175	2022/9/3	2023/9/2
Pre_Amplifier EMCI	EMC0126545	980076	2022/2/17	2023/2/16
	EMC184045B	980235	2022/2/17	2023/2/16
RF Coaxial Cable EM	EM102-KMKM-3.5+1M	EM102-KMKM-3.5+1M-01	2022/7/7	2023/7/6
RF Coaxial Cable HUBER SUHNER	SF-104	Cable-CH6-01	2022/7/7	2023/7/6
Software BVADT	Radiated_V8.7.08	N/A	N/A	N/A
Spectrum Analyzer Agilent	E4446A	MY51100009	2022/6/27	2023/6/26
Spectrum Analyzer KEYSIGHT	N9030A	MY54490260	2022/7/14	2023/7/13
Spectrum Analyzer R&S	FSV40	101042	2022/9/5	2023/9/4
		101544	2022/5/9	2023/5/8
Test Receiver Agilent	N9038A	MY51210129	2022/4/8	2023/4/7
		MY51210137	2022/6/9	2023/6/8
Tower ADT	AT100	0306	N/A	N/A
Turn Table ADT	TT100	0306	N/A	N/A

Notes:

1. The calibration interval of the above test instruments is 12/24 months. And the calibrations are traceable to NML/ROC and NIST/USA.
2. The test was performed in Linkou 966 Chamber 6 (CH 6).
3. Tested Date: 2022/9/5

4.1.3 Test Procedures

For Radiated emission below 30MHz

- a. The EUT was placed on the top of a rotating table 0.8 meters above the ground at a 3 meter chamber room. The table was rotated 360 degrees to determine the position of the highest radiation.
- b. The EUT was set 3 meters away from the interference-receiving antenna, which was mounted on the top of a variable-height antenna tower.
- c. Parallel, perpendicular, and ground-parallel orientations of the antenna are set to make the measurement.
- d. For each suspected emission, the EUT was arranged to its worst case and the rotatable table was turned from 0 degrees to 360 degrees to find the maximum reading.
- e. The test-receiver system was set to Quasi-Peak Detect Function and Specified Bandwidth with Maximum Hold Mode.

NOTE:

1. The resolution bandwidth and video bandwidth of test receiver/spectrum analyzer is 9kHz at frequency below 30MHz.

For Radiated emission above 30MHz

- a. The EUT was placed on the top of a rotating table 0.8 meters (for 30MHz ~ 1GHz) / 1.5 meters (for above 1GHz) above the ground at 3 meter chamber room for test. The table was rotated 360 degrees to determine the position of the highest radiation.
- b. The EUT was set 3 meters away from the interference-receiving antenna, which was mounted on the top of a variable-height antenna tower.
- c. The height of antenna is varied from one meter to four meters above the ground to determine the maximum value of the field strength. Both horizontal and vertical polarizations of the antenna are set to make the measurement.
- d. For each suspected emission, the EUT was arranged to its worst case and then the antenna was tuned to heights from 1 meter to 4 meters and the rotatable table was turned from 0 degrees to 360 degrees to find the maximum reading.
- e. The test-receiver system was set to quasi-peak detect function and specified bandwidth with maximum hold mode when the test frequency is below 1 GHz.
- f. The test-receiver system was set to peak and average detect function and specified bandwidth with maximum hold mode when the test frequency is above 1 GHz. If the peak reading value also meets average limit, measurement with the average detector is unnecessary.

Note:

1. The resolution bandwidth and video bandwidth of test receiver/spectrum analyzer is 120kHz for Quasi-peak detection (QP) at frequency below 1GHz.
2. The resolution bandwidth of test receiver/spectrum analyzer is 1 MHz and the video bandwidth is 3 MHz for Peak detection (PK) and Average detection at frequency above 1GHz. For fundamental and harmonic signal measurement, according to ANSI C63.10 section 7.5, the average value = peak value + duty factor. The duty factor refer to Chapter 3.3 of this report.
3. All modes of operation were investigated and the worst-case emissions are reported.

4.1.4 Deviation from Test Standard

No deviation.

4.1.5 Test Setup

For Radiated emission below 30MHz

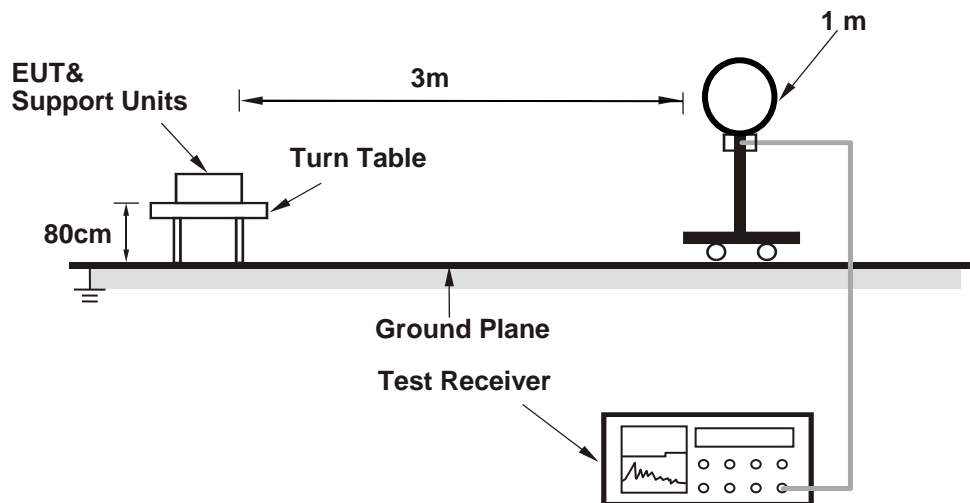

For Radiated emission 30MHz to 1GHz

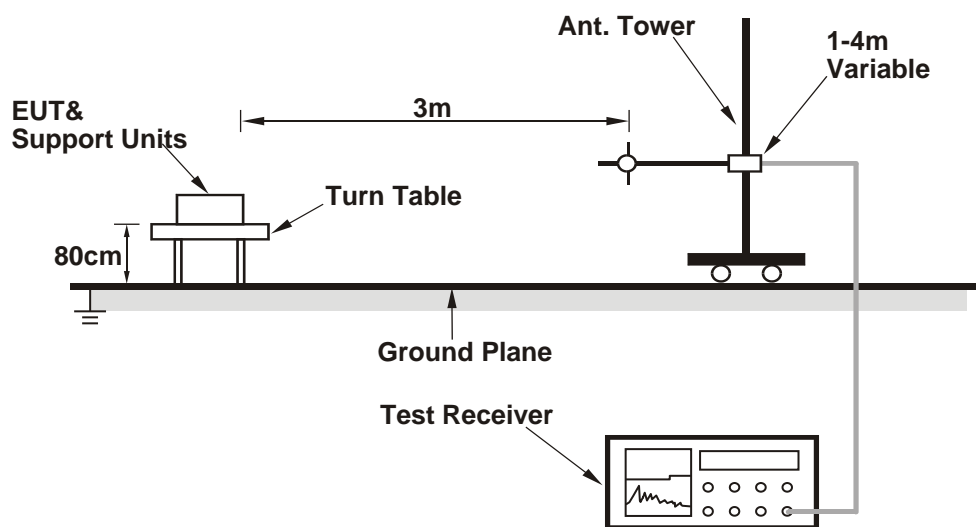

For Radiated emission above 1GHz

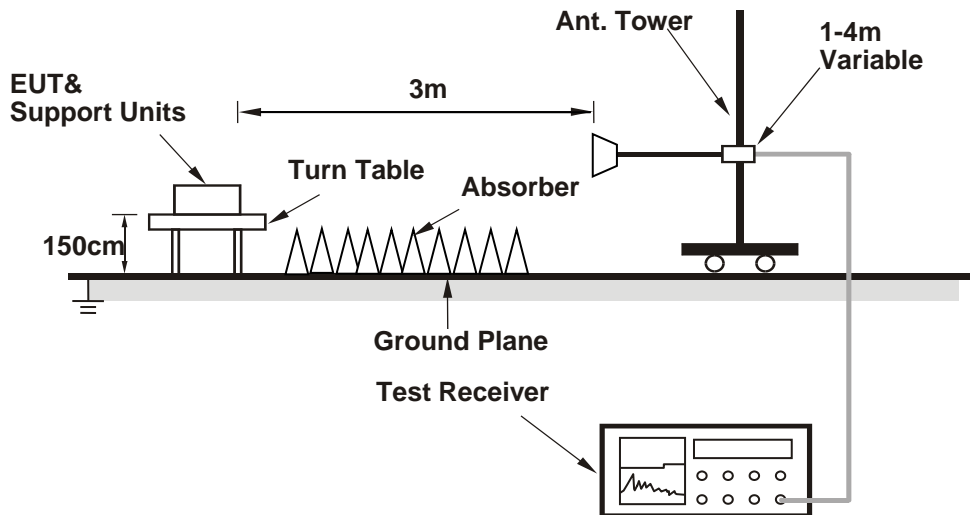

For the actual test configuration, please refer to the attached file (Test Setup Photo).

4.1.6 EUT Operating Conditions

Mode A

Set the EUT under transmission condition continuously at specific channel frequency continuously.

Mode B - Charging Mode (Powered from Notebook)

- a. Connected the EUT to Notebook PC.
- b. Set the EUT under charging condition.

4.1.7 Test Results

ABOVE 1GHz DATA

RF Mode	TX GFSK	Channel	CH 0 : 2403 MHz
Frequency Range	1 GHz ~ 25 GHz	Detector Function & Bandwidth	(PK) RB = 1 MHz, VB = 3 MHz (AV) RB = 1 MHz, VB = 3 MHz (RMS)

Antenna Polarity & Test Distance : Horizontal at 3 m								
No	Frequency (MHz)	Emission Level (dBuV/m)	Limit (dBuV/m)	Margin (dB)	Antenna Height (m)	Table Angle (Degree)	Raw Value (dBuV)	Correction Factor (dB/m)
1	2390.00	53.8 PK	74.0	-20.2	1.43 H	240	43.1	10.7
2	2390.00	44.2 AV	54.0	-9.8	1.43 H	240	33.5	10.7
3	2400.00	61.0 PK	74.0	-13.0	1.43 H	240	50.2	10.8
4	2400.00	42.2 AV	54.0	-11.8	1.43 H	240	31.4	10.8
5	*2403.00	98.6 PK	114.0	-15.4	1.43 H	240	87.7	10.9
6	*2403.00	79.8 AV	94.0	-14.2	1.43 H	240	68.9	10.9
7	4806.00	46.2 PK	74.0	-27.8	1.68 H	259	37.2	9.0
8	4806.00	27.4 AV	54.0	-26.6	1.68 H	259	18.4	9.0

Antenna Polarity & Test Distance : Vertical at 3 m								
No	Frequency (MHz)	Emission Level (dBuV/m)	Limit (dBuV/m)	Margin (dB)	Antenna Height (m)	Table Angle (Degree)	Raw Value (dBuV)	Correction Factor (dB/m)
1	2390.00	53.4 PK	74.0	-20.6	3.81 V	218	42.7	10.7
2	2390.00	43.1 AV	54.0	-10.9	3.81 V	218	32.4	10.7
3	2400.00	58.3 PK	74.0	-15.7	3.81 V	218	47.5	10.8
4	2400.00	39.5 AV	54.0	-14.5	3.81 V	218	28.7	10.8
5	*2403.00	96.1 PK	114.0	-17.9	3.81 V	218	85.2	10.9
6	*2403.00	77.3 AV	94.0	-16.7	3.81 V	218	66.4	10.9
7	4806.00	45.2 PK	74.0	-28.8	3.15 V	186	36.2	9.0
8	4806.00	26.4 AV	54.0	-27.6	3.15 V	186	17.4	9.0

Remarks:

1. Emission Level(dBuV/m) = Raw Value(dBuV) + Correction Factor(dB/m)
2. Correction Factor(dB/m) = Antenna Factor(dB/m) + Cable Factor(dB) – Pre-Amplifier Factor(dB)
3. Margin value = Emission Level – Limit value
4. The other emission levels were very low against the limit.
5. " * ": Fundamental frequency.
6. The average value of fundamental and harmonic frequency is: Average = Peak value + 20 log(Duty cycle) Where the duty cycle correction factor is calculated from following formula: 20 log(Duty cycle) = 20 log(0.115) = -18.8dB

RF Mode	TX GFSK	Channel	CH 38 : 2441 MHz
Frequency Range	1 GHz ~ 25 GHz	Detector Function & Bandwidth	(PK) RB = 1 MHz, VB = 3 MHz (AV) RB = 1 MHz, VB = 3 MHz (RMS)

Antenna Polarity & Test Distance : Horizontal at 3 m

No	Frequency (MHz)	Emission Level (dBuV/m)	Limit (dBuV/m)	Margin (dB)	Antenna Height (m)	Table Angle (Degree)	Raw Value (dBuV)	Correction Factor (dB/m)
1	*2441.00	97.3 PK	114.0	-16.7	1.41 H	248	86.5	10.8
2	*2441.00	78.5 AV	94.0	-15.5	1.41 H	248	67.7	10.8
3	4882.00	47.0 PK	74.0	-27.0	1.66 H	267	37.6	9.4
4	4882.00	28.2 AV	54.0	-25.8	1.66 H	267	18.8	9.4

Antenna Polarity & Test Distance : Vertical at 3 m

No	Frequency (MHz)	Emission Level (dBuV/m)	Limit (dBuV/m)	Margin (dB)	Antenna Height (m)	Table Angle (Degree)	Raw Value (dBuV)	Correction Factor (dB/m)
1	*2441.00	94.8 PK	114.0	-19.2	3.83 V	226	84.0	10.8
2	*2441.00	76.0 AV	94.0	-18.0	3.83 V	226	65.2	10.8
3	4882.00	45.9 PK	74.0	-28.1	3.17 V	195	36.5	9.4
4	4882.00	27.1 AV	54.0	-26.9	3.17 V	195	17.7	9.4

Remarks:

1. Emission Level(dBuV/m) = Raw Value(dBuV) + Correction Factor(dB/m)
2. Correction Factor(dB/m) = Antenna Factor(dB/m) + Cable Factor(dB) – Pre-Amplifier Factor(dB)
3. Margin value = Emission Level – Limit value
4. The other emission levels were very low against the limit.
5. " * " : Fundamental frequency.
6. The average value of fundamental and harmonic frequency is: Average = Peak value + 20 log(Duty cycle) Where the duty cycle correction factor is calculated from following formula: $20 \log(\text{Duty cycle}) = 20 \log(0.115) = -18.8\text{dB}$

RF Mode	TX GFSK	Channel	CH 77 : 2480 MHz
Frequency Range	1 GHz ~ 25 GHz	Detector Function & Bandwidth	(PK) RB = 1 MHz, VB = 3 MHz (AV) RB = 1 MHz, VB = 3 MHz (RMS)

Antenna Polarity & Test Distance : Horizontal at 3 m

No	Frequency (MHz)	Emission Level (dBuV/m)	Limit (dBuV/m)	Margin (dB)	Antenna Height (m)	Table Angle (Degree)	Raw Value (dBuV)	Correction Factor (dB/m)
1	*2480.00	95.7 PK	114.0	-18.3	1.13 H	242	84.8	10.9
2	*2480.00	76.9 AV	94.0	-17.1	1.13 H	242	66.0	10.9
3	2483.50	55.2 PK	74.0	-18.8	1.13 H	242	44.2	11.0
4	2483.50	36.4 AV	54.0	-17.6	1.13 H	242	25.4	11.0
5	4960.00	46.6 PK	74.0	-27.4	1.39 H	261	36.8	9.8
6	4960.00	27.8 AV	54.0	-26.2	1.39 H	261	18.0	9.8

Antenna Polarity & Test Distance : Vertical at 3 m

No	Frequency (MHz)	Emission Level (dBuV/m)	Limit (dBuV/m)	Margin (dB)	Antenna Height (m)	Table Angle (Degree)	Raw Value (dBuV)	Correction Factor (dB/m)
1	*2480.00	93.3 PK	114.0	-20.7	3.53 V	216	82.4	10.9
2	*2480.00	74.5 AV	94.0	-19.5	3.53 V	216	63.6	10.9
3	2483.50	53.4 PK	74.0	-20.6	3.53 V	216	42.4	11.0
4	2483.50	34.6 AV	54.0	-19.4	3.53 V	216	23.6	11.0
5	4960.00	48.0 PK	74.0	-26.0	2.87 V	184	38.2	9.8
6	4960.00	29.2 AV	54.0	-24.8	2.87 V	184	19.4	9.8

Remarks:

1. Emission Level(dBuV/m) = Raw Value(dBuV) + Correction Factor(dB/m)
2. Correction Factor(dB/m) = Antenna Factor(dB/m) + Cable Factor(dB) – Pre-Amplifier Factor(dB)
3. Margin value = Emission Level – Limit value
4. The other emission levels were very low against the limit.
5. " * ": Fundamental frequency.
6. The average value of fundamental and harmonic frequency is: Average = Peak value + 20 log(Duty cycle) Where the duty cycle correction factor is calculated from following formula: 20 log(Duty cycle) = 20 log(0.115) = -18.8dB

BELOW 1GHz WORST-CASE DATA

Mode A

RF Mode	TX GFSK	Channel	CH 0 : 2403 MHz
Frequency Range	9 kHz ~ 1 GHz	Detector Function & Bandwidth	(QP) RB = 120kHz

Antenna Polarity & Test Distance : Horizontal at 3 m

No	Frequency (MHz)	Emission Level (dBuV/m)	Limit (dBuV/m)	Margin (dB)	Antenna Height (m)	Table Angle (Degree)	Raw Value (dBuV)	Correction Factor (dB/m)
1	55.90	18.8 QP	40.0	-21.2	1.96 H	216	27.6	-8.8
2	162.11	19.6 QP	43.5	-23.9	1.64 H	69	27.7	-8.1
3	280.89	21.5 QP	46.0	-24.5	1.38 H	267	27.9	-6.4
4	335.65	22.8 QP	46.0	-23.2	1.43 H	57	27.8	-5.0
5	412.71	24.1 QP	46.0	-21.9	1.76 H	149	27.5	-3.4
6	483.09	26.5 QP	46.0	-19.5	1.24 H	116	28.2	-1.7

Remarks:

1. Emission Level(dBuV/m) = Raw Value(dBuV) + Correction Factor(dB/m)
2. Correction Factor(dB/m) = Antenna Factor(dB/m) + Cable Factor(dB) – Pre-Amplifier Factor(dB)
3. Margin value = Emission Level – Limit value
4. The other emission levels were very low against the limit of frequency range 30 MHz ~ 1 GHz.
5. The emission levels were very low against the limit of frequency range 9 kHz ~ 30 MHz: the amplitude of spurious emissions attenuated more than 20 dB below the permissible value to be report.

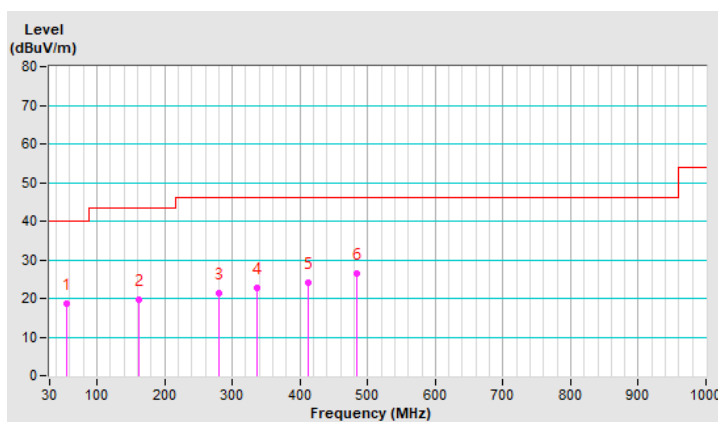

RF Mode	TX GFSK	Channel	CH 0 : 2403 MHz
Frequency Range	9 kHz ~ 1 GHz	Detector Function & Bandwidth	(QP) RB = 120kHz

Antenna Polarity & Test Distance : Vertical at 3 m								
No	Frequency (MHz)	Emission Level (dBuV/m)	Limit (dBuV/m)	Margin (dB)	Antenna Height (m)	Table Angle (Degree)	Raw Value (dBuV)	Correction Factor (dB/m)
1	49.45	19.2 QP	40.0	-20.8	1.45 V	210	27.9	-8.7
2	152.32	19.9 QP	43.5	-23.6	1.58 V	290	28.1	-8.2
3	279.19	21.0 QP	46.0	-25.0	1.63 V	258	27.5	-6.5
4	359.56	23.9 QP	46.0	-22.1	1.23 V	238	28.6	-4.7
5	405.15	25.1 QP	46.0	-20.9	1.19 V	328	28.7	-3.6
6	472.90	26.2 QP	46.0	-19.8	1.70 V	53	28.0	-1.8

Remarks:

1. Emission Level(dBuV/m) = Raw Value(dBuV) + Correction Factor(dB/m)
2. Correction Factor(dB/m) = Antenna Factor(dB/m) + Cable Factor(dB) – Pre-Amplifier Factor(dB)
3. Margin value = Emission Level – Limit value
4. The other emission levels were very low against the limit of frequency range 30 MHz ~ 1 GHz.
5. The emission levels were very low against the limit of frequency range 9 kHz ~ 30 MHz: the amplitude of spurious emissions attenuated more than 20 dB below the permissible value to be report.

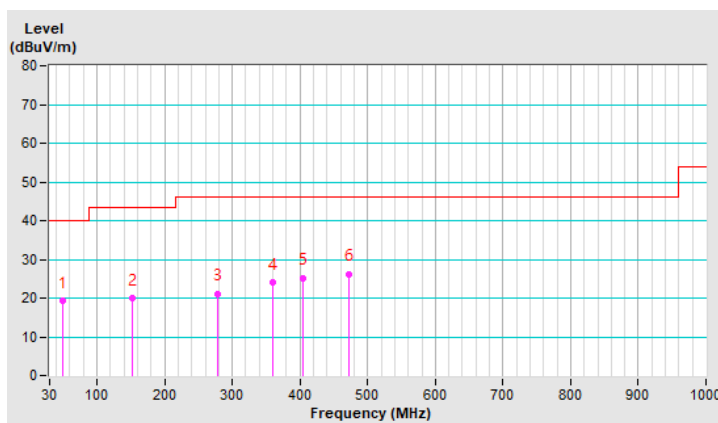

Mode B

Frequency Range	9 kHz ~ 1 GHz	Detector Function & Bandwidth	(QP) RB = 120kHz
------------------------	---------------	--	------------------

Antenna Polarity & Test Distance : Horizontal at 3 m								
No	Frequency (MHz)	Emission Level (dBuV/m)	Limit (dBuV/m)	Margin (dB)	Antenna Height (m)	Table Angle (Degree)	Raw Value (dBuV)	Correction Factor (dB/m)
1	68.85	29.3 QP	40.0	-10.7	1.88 H	239	39.8	-10.5
2	191.99	32.1 QP	43.5	-11.4	1.56 H	166	42.6	-10.5
3	263.24	36.4 QP	46.0	-9.6	1.49 H	246	43.8	-7.4
4	300.73	34.2 QP	46.0	-11.8	1.27 H	249	40.1	-5.9
5	406.65	29.2 QP	46.0	-16.8	1.63 H	42	32.8	-3.6
6	471.54	29.3 QP	46.0	-16.7	1.30 H	0	31.1	-1.8

Remarks:

1. Emission Level(dBuV/m) = Raw Value(dBuV) + Correction Factor(dB/m)
2. Correction Factor(dB/m) = Antenna Factor(dB/m) + Cable Factor(dB) – Pre-Amplifier Factor(dB)
3. Margin value = Emission Level – Limit value
4. The other emission levels were very low against the limit of frequency range 30 MHz ~ 1 GHz.
5. The emission levels were very low against the limit of frequency range 9 kHz ~ 30 MHz: the amplitude of spurious emissions attenuated more than 20 dB below the permissible value to be report.

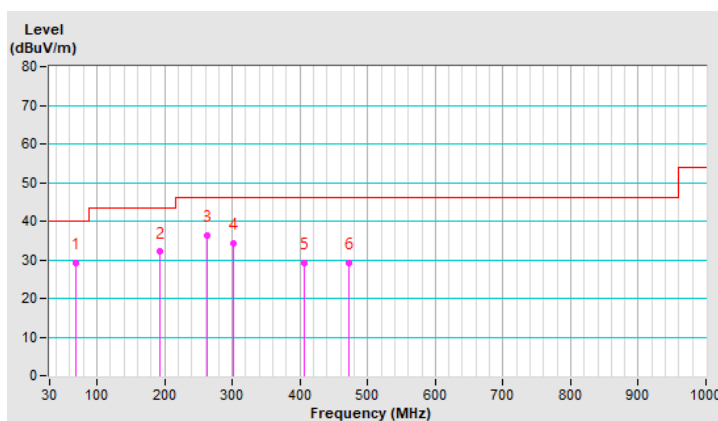

Frequency Range	9 kHz ~ 1 GHz	Detector Function & Bandwidth	(QP) RB = 120kHz
------------------------	---------------	--	------------------

Antenna Polarity & Test Distance : Vertical at 3 m								
No	Frequency (MHz)	Emission Level (dBuV/m)	Limit (dBuV/m)	Margin (dB)	Antenna Height (m)	Table Angle (Degree)	Raw Value (dBuV)	Correction Factor (dB/m)
1	68.85	23.9 QP	40.0	-16.1	1.28 V	154	34.4	-10.5
2	174.77	23.0 QP	43.5	-20.5	1.43 V	243	31.7	-8.7
3	258.77	26.4 QP	46.0	-19.6	1.37 V	112	34.2	-7.8
4	328.03	26.7 QP	46.0	-19.3	1.65 V	94	31.8	-5.1
5	390.60	27.3 QP	46.0	-18.7	1.97 V	257	31.2	-3.9
6	439.87	28.5 QP	46.0	-17.5	1.84 V	22	30.9	-2.4

Remarks:

1. Emission Level(dBuV/m) = Raw Value(dBuV) + Correction Factor(dB/m)
2. Correction Factor(dB/m) = Antenna Factor(dB/m) + Cable Factor(dB) – Pre-Amplifier Factor(dB)
3. Margin value = Emission Level – Limit value
4. The other emission levels were very low against the limit of frequency range 30 MHz ~ 1 GHz.
5. The emission levels were very low against the limit of frequency range 9 kHz ~ 30 MHz: the amplitude of spurious emissions attenuated more than 20 dB below the permissible value to be report.

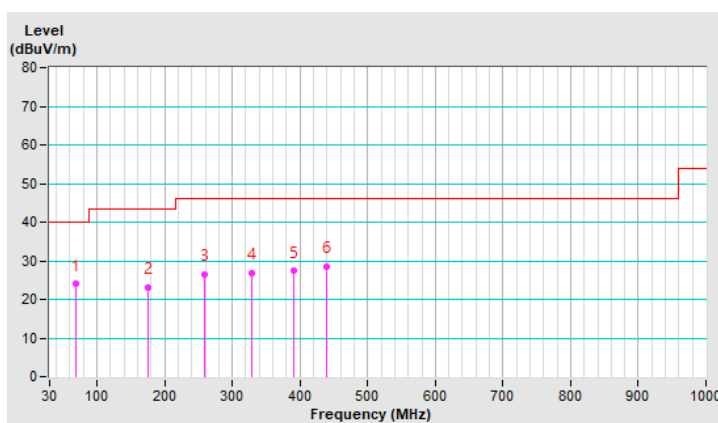

4.2 Conducted Emission Measurement

4.2.1 Limits of Conducted Emission Measurement

Frequency (MHz)	Conducted Limit (dBuV)	
	Quasi-peak	Average
0.15 - 0.5	66 - 56	56 - 46
0.50 - 5.0	56	46
5.0 - 30.0	60	50

Note: 1. The lower limit shall apply at the transition frequencies.

2. The limit decreases in line with the logarithm of the frequency in the range of 0.15 to 0.50MHz.

4.2.2 Test Instruments

Description Manufacturer	Model No.	Serial No.	Calibrated Date	Calibrated Until
50 ohm terminal LYNICS	0900510	E1-011285	2021/10/1	2022/9/30
		E1-011286	2021/10/1	2022/9/30
50 Ohms Terminator LYNICS	0900510	E1-01-305	2022/2/9	2023/2/8
Attenuator STI	STI02-2200-10	NO.4	2022/9/2	2023/9/1
DC LISN R&S	ESH3-Z6	100219	2022/8/2	2023/8/1
		844950/018	2022/8/2	2023/8/1
DC LISN Schwarzbeck	NNLK 8121	8121-808	2022/4/29	2023/4/28
High Voltage Probe Schwarzbeck	TK9420	00982	2021/12/24	2022/12/23
Isolation Transformer Erika Fiedler	D-65396	017	2022/9/8	2023/9/7
LISN R&S	ENV216	101196	2022/5/24	2023/5/23
	ESH3-Z5	100220	2021/11/25	2022/11/24
LISN Schwarzbeck	NNLK 8121	8121-731	2022/5/26	2023/5/25
		8121-00759	2022/8/18	2023/8/17
	NNLK8129	8129229	2022/6/8	2023/6/7
	NSLK 8128	8128-244	2021/11/11	2022/11/10
RF Coaxial Cable Commate	5D-FB	Cable-CO5-01	2022/1/28	2023/1/27
Software BVADT	Cond_V7.3.7.4	N/A	N/A	N/A
Test Receiver R&S	ESR3	102412	2022/1/22	2023/1/21

Notes:

1. The test was performed in Linkou Conduction 5.
2. The calibration interval of the above test instruments is 12 months and the calibrations are traceable to NML/ROC and NIST/USA.
3. Tested Date: 2022/9/27

4.2.3 Test Procedures

- The EUT was placed 0.4 meters from the conducting wall of the shielded room with EUT being connected to the power mains through a line impedance stabilization network (LISN). Other support units were connected to the power mains through another LISN. The two LISNs provide 50 ohm/ 50uH of coupling impedance for the measuring instrument.
- Both lines of the power mains connected to the EUT were checked for maximum conducted interference.
- The frequency range from 150kHz to 30MHz was searched. Emission levels under (Limit - 20dB) was not recorded.

NOTE: The resolution bandwidth and video bandwidth of test receiver is 9kHz for quasi-peak detection (QP) and average detection (AV) at frequency 0.15MHz-30MHz.

4.2.4 Deviation From Test Standard

No deviation.

4.2.5 Test Setup

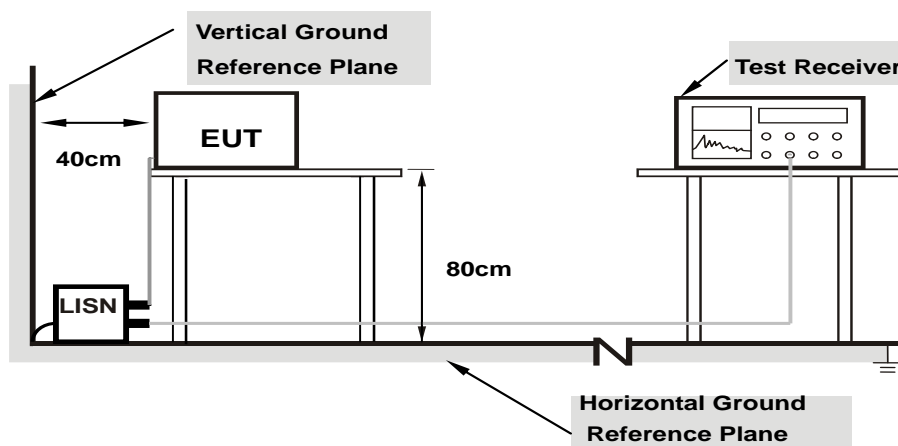

Note: 1.Support units were connected to second LISN.

For the actual test configuration, please refer to the attached file (Test Setup Photo).

4.2.6 EUT Operating Condition

Mode B & C

- Connected the EUT to Notebook PC or Adapter.
- Set the EUT under charging condition.

4.2.7 Test Results

Mode B

Frequency Range	150 kHz ~ 30 MHz	Detector Function & Resolution Bandwidth	Quasi-Peak (QP) / Average (AV), 9 kHz
------------------------	------------------	---	---------------------------------------

Phase Of Power : Line (L)										
No	Frequency (MHz)	Correction Factor (dB)	Reading Value (dBuV)		Emission Level (dBuV)		Limit (dBuV)		Margin (dB)	
			Q.P.	AV.	Q.P.	AV.	Q.P.	AV.	Q.P.	AV.
1	0.15760	9.93	37.21	17.15	47.14	27.08	65.59	55.59	-18.45	-28.51
2	0.22427	9.94	28.56	12.87	38.50	22.81	62.66	52.66	-24.16	-29.85
3	0.41972	9.94	29.77	23.36	39.71	33.30	57.45	47.45	-17.74	-14.15
4	0.76972	9.96	24.38	18.74	34.34	28.70	56.00	46.00	-21.66	-17.30
5	2.03909	10.03	25.44	20.18	35.47	30.21	56.00	46.00	-20.53	-15.79
6	4.81448	10.16	23.15	15.31	33.31	25.47	56.00	46.00	-22.69	-20.53

Remarks:

1. Q.P. and AV. are abbreviations of quasi-peak and average individually.
2. The emission levels of other frequencies were very low against the limit.
3. Margin value = Emission level – Limit value
4. Correction factor = Insertion loss + Cable loss
5. Emission Level = Correction Factor + Reading Value

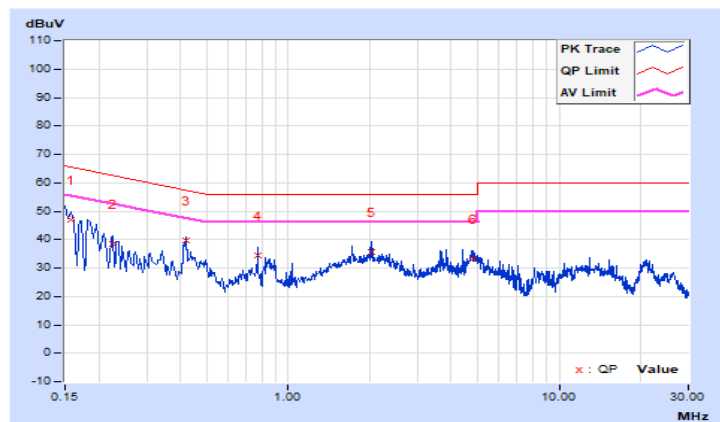

Frequency Range	150 kHz ~ 30 MHz	Detector Function & Resolution Bandwidth	Quasi-Peak (QP) / Average (AV), 9 kHz
------------------------	------------------	---	---------------------------------------

Phase Of Power : Neutral (N)										
No	Frequency (MHz)	Correction Factor (dB)	Reading Value (dBuV)		Emission Level (dBuV)		Limit (dBuV)		Margin (dB)	
			Q.P.	AV.	Q.P.	AV.	Q.P.	AV.	Q.P.	AV.
1	0.16955	9.94	34.80	15.48	44.74	25.42	64.98	54.98	-20.24	-29.56
2	0.25554	9.95	26.16	14.94	36.11	24.89	61.58	51.58	-25.47	-26.69
3	0.45456	9.96	24.81	19.56	34.77	29.52	56.79	46.79	-22.02	-17.27
4	1.76652	10.03	23.26	16.84	33.29	26.87	56.00	46.00	-22.71	-19.13
5	4.93957	10.17	21.74	13.55	31.91	23.72	56.00	46.00	-24.09	-22.28
6	7.04441	10.25	22.05	10.44	32.30	20.69	60.00	50.00	-27.70	-29.31

Remarks:

1. Q.P. and AV. are abbreviations of quasi-peak and average individually.
2. The emission levels of other frequencies were very low against the limit.
3. Margin value = Emission level – Limit value
4. Correction factor = Insertion loss + Cable loss
5. Emission Level = Correction Factor + Reading Value

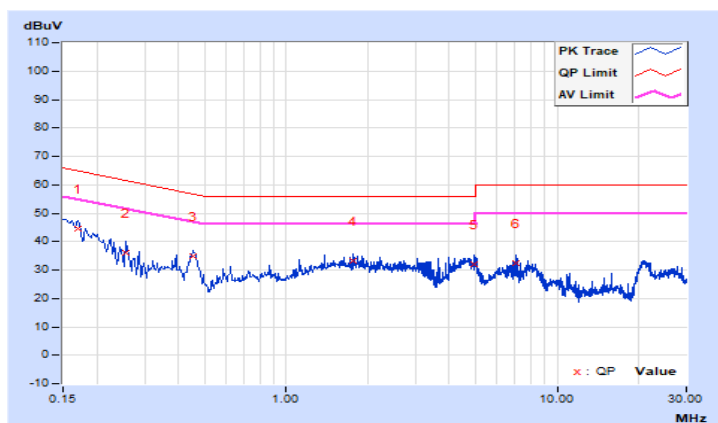

Mode C

Frequency Range	150 kHz ~ 30 MHz	Detector Function & Resolution Bandwidth	Quasi-Peak (QP) / Average (AV), 9 kHz
------------------------	------------------	---	---------------------------------------

Phase Of Power : Line (L)										
No	Frequency (MHz)	Correction Factor (dB)	Reading Value (dBuV)		Emission Level (dBuV)		Limit (dBuV)		Margin (dB)	
			Q.P.	AV.	Q.P.	AV.	Q.P.	AV.	Q.P.	AV.
1	0.16173	9.93	33.72	9.14	43.65	19.07	65.37	55.37	-21.72	-36.30
2	0.34545	9.94	15.90	0.98	25.84	10.92	59.07	49.07	-33.23	-38.15
3	0.75018	9.96	26.39	13.83	36.35	23.79	56.00	46.00	-19.65	-22.21
4	2.12509	10.04	16.79	5.89	26.83	15.93	56.00	46.00	-29.17	-30.07
5	5.00391	10.16	21.80	9.92	31.96	20.08	60.00	50.00	-28.04	-29.92
6	7.58385	10.28	22.20	10.44	32.48	20.72	60.00	50.00	-27.52	-29.28

Remarks:

1. Q.P. and AV. are abbreviations of quasi-peak and average individually.
2. The emission levels of other frequencies were very low against the limit.
3. Margin value = Emission level – Limit value
4. Correction factor = Insertion loss + Cable loss
5. Emission Level = Correction Factor + Reading Value

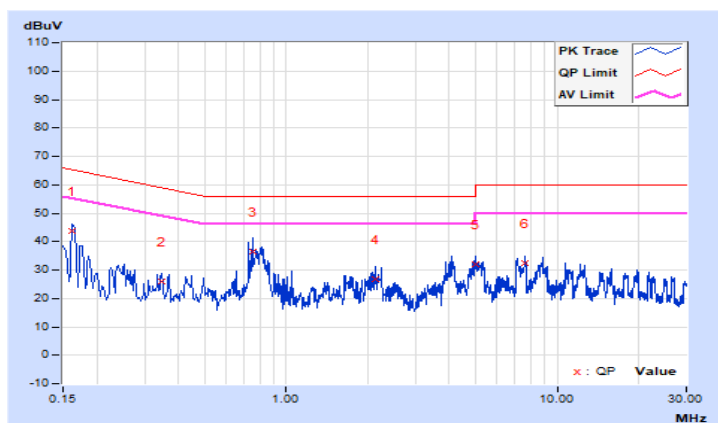

Frequency Range	150 kHz ~ 30 MHz	Detector Function & Resolution Bandwidth	Quasi-Peak (QP) / Average (AV), 9 kHz
------------------------	------------------	---	---------------------------------------

Phase Of Power : Neutral (N)										
No	Frequency (MHz)	Correction Factor (dB)	Reading Value (dBuV)		Emission Level (dBuV)		Limit (dBuV)		Margin (dB)	
			Q.P.	AV.	Q.P.	AV.	Q.P.	AV.	Q.P.	AV.
1	0.15760	9.94	23.16	2.45	33.10	12.39	65.59	55.59	-32.49	-43.20
2	0.32981	9.96	26.35	7.14	36.31	17.10	59.46	49.46	-23.15	-32.36
3	0.78536	9.98	17.97	9.41	27.95	19.39	56.00	46.00	-28.05	-26.61
4	1.46161	10.01	18.24	8.55	28.25	18.56	56.00	46.00	-27.75	-27.44
5	6.16879	10.22	24.19	14.31	34.41	24.53	60.00	50.00	-25.59	-25.47
6	11.73130	10.42	23.20	14.70	33.62	25.12	60.00	50.00	-26.38	-24.88

Remarks:

1. Q.P. and AV. are abbreviations of quasi-peak and average individually.
2. The emission levels of other frequencies were very low against the limit.
3. Margin value = Emission level – Limit value
4. Correction factor = Insertion loss + Cable loss
5. Emission Level = Correction Factor + Reading Value

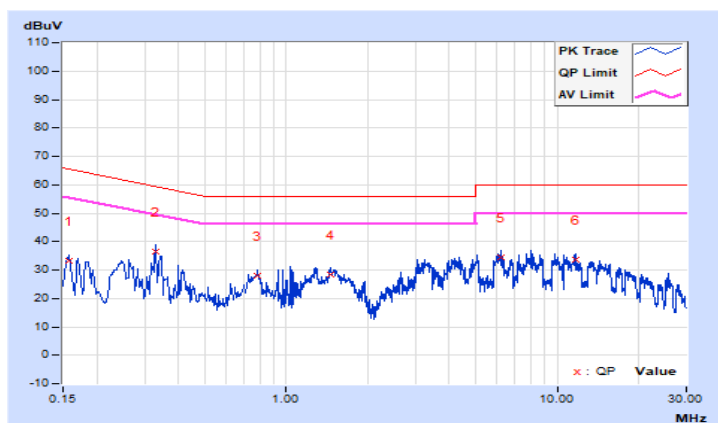

4.3 Channel Bandwidth

4.3.1 Test Setup

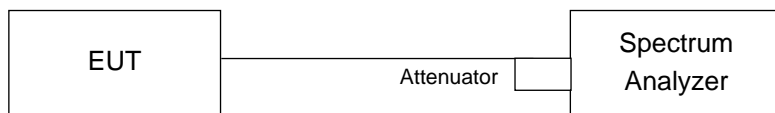

4.3.2 Test Instruments

Description & Manufacturer	Model No.	Serial No.	Calibrated Date	Calibrated Until
Spectrum Analyzer R&S	FSV40	101544	2022/5/9	2023/5/8

- NOTE:**
1. The calibration interval of the above test instruments is 12 months. And the calibrations are traceable to NML/ROC and NIST/USA.
 2. The test was performed in LK - Oven
 3. Tested Date: 2022/9/20

4.3.3 Test Procedure

- a. Check the calibration of the measuring instrument using either an internal calibrator or a known signal from an external generator.
- b. Turn on the EUT and connect it to measurement instrument. Then set it to any one convenient frequency within its operating range. Set a reference level on the measuring instrument equal to the highest peak value.
- c. Measure the frequency difference of two frequencies that were attenuated 20dB from the reference level. Record the frequency difference as the emission bandwidth.
- d. Repeat above procedures until all frequencies measured were complete.

4.3.4 Deviation from Test Standard

No deviation.

4.3.5 EUT Operating Condition

The software provided by client enabled the EUT to transmit and receive data at lowest, middle and highest channel frequencies individually.

4.3.6 Test Results

Channel	Frequency (MHz)	20dB Bandwidth (MHz)
0	2403	1.92
38	2441	1.81
77	2480	1.86

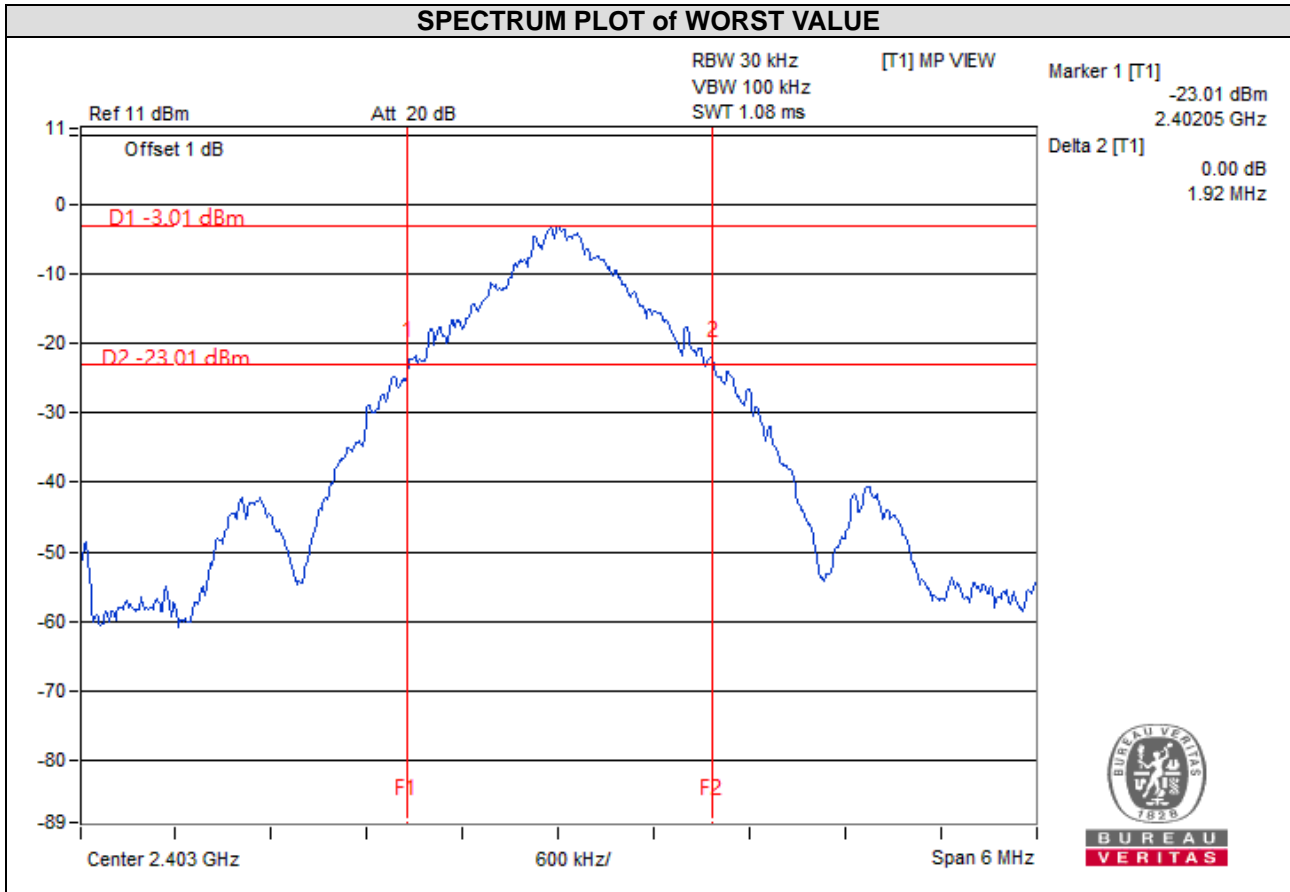

5 Pictures of Test Arrangements

Please refer to the attached file (Test Setup Photo).

Appendix – Information of the Testing Laboratories

We, Bureau Veritas Consumer Products Services (H.K.) Ltd., Taoyuan Branch, were founded in 1988 to provide our best service in EMC, Radio, Telecom and Safety consultation. Our laboratories are FCC recognized accredited test firms and accredited according to ISO/IEC 17025.

If you have any comments, please feel free to contact us at the following:

Lin Kou EMC/RF Lab

Tel: 886-2-26052180

Fax: 886-2-26051924

Hsin Chu EMC/RF/Telecom Lab

Tel: 886-3-6668565

Fax: 886-3-6668323

Hwa Ya EMC/RF/Safety Lab

Tel: 886-3-3183232

Fax: 886-3-3270892

Email: service.adt@tw.bureauveritas.com

Web Site: www.bureauveritas-adt.com

The address and road map of all our labs can be found in our web site also.

--- END ---