

SEIKAKU TECHNICAL GROUP LIMITED

客	戶						
料	號	NF04117					
品	名	說明書-RS 英文					
規	格	U-299/899 兩無_V1.1					
公司機種(客戶機種)成品料號		U-299R / U-899H / U-899P/299H					
重 量 / 基 數		0.06KG/1					
材 質		A4紙5張NH00149(1:1)					
紙張展開性質		<input type="checkbox"/> A3 <input checked="" type="checkbox"/> A4 <input type="checkbox"/> A5 <input type="checkbox"/> 其它:			紙張展開數量	5 PCS	
核 准		審 核		校 稿		製 稿	
產品文件編號:							
附陽片數量: 9 張							
變更單號: QHFBE004-20140600016							
NO:		修改記錄		版本	更改者	日期	
1		依電子要求修改印刷內容		1.1	王俊	140617	

WIRELESS MICROPHONE SYSTEM

User's Manual



WIRELESS MIC SYSTEM Channel Plans

CHB:470-566 MHz CHANNEL TABLE(USA)

Group H 470–518 MHz				Group I 518 –566 MHz			
CH A	Freq	CH B	Freq	CH A	Freq	CH B	Freq
0	470.125	0	494.125	0	518.125	0	542.125
1	471.625	1	495.625	1	519.625	1	543.625
2	473.050	2	497.050	2	521.050	2	545.050
3	474.425	3	498.425	3	522.425	3	546.425
4	474.900	4	498.900	4	522.900	4	546.900
5	477.525	5	501.525	5	525.525	5	549.525
6	479.100	6	503.100	6	527.100	6	551.100
7	480.475	7	504.475	7	528.475	7	552.475
8	482.000	8	506.000	8	530.000	8	554.000
9	484.075	9	508.075	9	532.075	9	556.075
A	486.975	A	510.975	A	534.975	A	558.975
B	487.975	B	511.975	B	535.975	B	559.975
C	489.050	C	513.050	C	537.050	C	561.050
D	490.975	D	514.975	D	538.975	D	562.975
E	492.425	E	516.425	E	540.425	E	564.425
F	493.975	F	517.975	F	541.975	F	565.975

INDEX

Table of Contents

01 SAFETY RELATED SYMBOLS	1
02 WARNING	1
03 IMPORTANT SAFETY INSTRUCTIONS	2
04 INTRODUCTION	3
05 CONTROL ELEMENTS	4~8
06 OPERATING INSTRUCTION	9~12
07 TECHNICAL SPECIFICATIONS	12~15

IMPORTANT!

Please read this manual carefully before operating this unit for the first time.

SAFETY RELATED SYMBOLS



The symbol is used to indicate that some hazardous live terminals are involved within this apparatus, even under the normal operating conditions.



The symbol is used in the service documentation to indicate that specific component shall be only replaced by the component specified in that Documentation for safety reasons.



Protective grounding terminal.



Alternating current /voltage.



Hazardous live terminal .

ON: Denotes the apparatus turns on.

OFF: Denotes the apparatus turns off, because of using the single pole switch, be sure to unplug the AC power to prevent any electric shock before you proceed your service.

WARNING: Describes precautions that should be observed to prevent the danger of injury or death to the user.



Disposing of this product should not be placed in municipal waste and should be separate collection.

CAUTION: Describes precautions that should be observed to prevent danger of the apparatus.

WARNING

• Power Supply

Ensure the source voltage matches the voltage of the power supply before turning ON the apparatus.

Unplug this apparatus during lightning storms or when unused for long periods of time.

• External Connection

The external wiring connected to the output hazardous live terminals requires installation by an instructed person, or the use of ready-made leads or cords.

• Do not Remove any Cover

There are maybe some areas with high voltages inside, to reduce the risk of electric shock, do not remove any cover if the power supply is connected.

The cover should be removed by the qualified personnel only.

No user serviceable parts inside.

• Fuse

To prevent a fire, make sure to use fuses with specified standard (current, voltage, type). Do not use a different fuse or short circuit the fuse holder.

Before replacing the fuse, turn OFF the apparatus and disconnected the power source.

• Protective Grounding

Make sure to connect the protective grounding to prevent any electric shock before turning ON the apparatus.

Never cut off the internal or external protective grounding wire or disconnect the wiring of protective grounding terminal.

• Operating Conditions

This apparatus shall not be exposed to dripping or splashing and that no objects filled with liquids, such as vases, shall be placed on this apparatus.

WIRELESS MIC SYSTEM Channel Plans

CHA:470-566 MHz CHANNEL TABLE(EU&USA)

Group H 470–518 MHz				Group I 518 –566 MHz			
CH A	Freq	CH B	Freq	CH A	Freq	CH B	Freq
0	470.125	0	494.125	0	518.125	0	542.125
1	471.625	1	495.625	1	519.625	1	543.625
2	473.050	2	497.050	2	521.050	2	545.050
3	474.425	3	498.425	3	522.425	3	546.425
4	474.900	4	498.900	4	522.900	4	546.900
5	477.525	5	501.525	5	525.525	5	549.525
6	479.100	6	503.100	6	527.100	6	551.100
7	480.475	7	504.475	7	528.475	7	552.475
8	482.000	8	506.000	8	530.000	8	554.000
9	484.075	9	508.075	9	532.075	9	556.075
A	486.975	A	510.975	A	534.975	A	558.975
B	487.975	B	511.975	B	535.975	B	559.975
C	489.050	C	513.050	C	537.050	C	561.050
D	490.975	D	514.975	D	538.975	D	562.975
E	492.425	E	516.425	E	540.425	E	564.425
F	493.975	F	517.975	F	541.975	F	565.975

TECHNICAL SPECIFICATIONS

TRANSMITTER

Specification	MODEL	Metal/Plastic hand mic	Beltpack mic
Carrier frequency band		UHF	UHF
Oscillation mode		PLL UHF SYNTHESIZED	PLL UHF SYNTHESIZED
Modulation mode		FM(F3E)	FM(F3E)
Frequency stability		±0.005%	±0.005%
RF Radiation Fcc		10mW	10mW
RF Radiation CE			
Spurious Emission		50dBm↓	50dBm↓
T.H.D		<1.0%	<1.0%
Frequency response		50Hz-15KHz(±3dB)	50Hz-15KHz(±3dB)
Current drain		<150mA	<150mA
Battery		"AA" typex2pcs (used for more than 6 hours)	"AA" typex2pcs (used for more than 6 hours)
Operating Temperature		-10°C to 50°C	-10°C to 50°C
Tone frequency		35KHz	35KHz
Dimensions		260* φ 36mm/240* φ 50mm	65x85x25mm
Weight		0.3kg/0.27Kg(Approx.)	0.082Kg
Dynamic		>100dB	>100dB
Mic / Instrument Input		10dBu	10dBu
Microphone Capsule		Dynamic Capsule	Condenser Dynamic Capsule
4 band choice			1. Ground
			2. Power supply
			3. Electric instrument
			4. Dynamic or condenser Mic

To reduce the risk of fire or electric shock, do not expose this apparatus to rain or moisture.

Do not use this apparatus near water. Install in accordance with the manufacture-r's instructions. Do not install near any heat sources such as radiators, heat registers, stoves, or other apparatus (including amplifiers) that produce heat. Do not block any ventilation openings.

No naked flame sources, such as lighted candles, should be placed on the apparatus.

IMPORTANT SAFETY INSTRUCTIONS

- Read these instructions.
- Follow all instructions.
- Keep these instructions.
- Heed all warnings.
- Only use attachments/accessories specified by the manufacturer.

• Power Cord and Plug

Do not defeat the safety purpose of the polarized or grounding type plug.

A polarized plug has two blades with one wider than the other. A grounding type plug has two blades and a third grounding prong. The wide blade or the third prong are provided for your safety. If the provided plug does not fit into your outlet, consult an electrician for replacement of the obsolete outlet.

Protect the power cord from being walked on or pinched particularly at plugs, convenience receptacles, and the point where they exit from the apparatus.

• Cleaning

When the apparatus needs a cleaning, you can blow off dust from the apparatus with

a blower or clean with rag etc.

Don't use solvents such as benzol, alcohol, or other fluids with very strong volatility and flammability for cleaning the apparatus body. Clean only with dry cloth.

• Servicing

Refer all servicing to qualified personnel. To reduce the risk of electric shock, do not perform any servicing other than that contained in the operating instructions unless you are qualified to do so .

Servicing is required when the apparatus has been damaged in any way , such as power supply cord or plug is damaged , liquid has been spilled or objects have fallen into the apparatus, the apparatus has been exposed to rain or moisture , does not operate normally, or has been dropped.

The mains plug is used as the disconnect device, the disconnect device shall remain readily operable.

Changes or modifications to this unit not expressly approved by the party responsible for compliance could void the user's authority to operate the equipment.

FCC Rules and Regulations

MARKUS wireless receivers are certified under FCC Rules part 15 and transmitters are certified under FCC Rules part 74. Licensing of MARKUS equipment is the user's responsibility and licensability depends on the user's classification, application and frequency selected.

NOTE: This equipment has been tested and found to comply with the limits for a class B digital device, pursuant to Part 15 of the FCC Rules .These limits are designed to provide reasonable protection against harmful interference in a residential installation . This equipment generates, uses and can radiate radio frequency energy and , if not installed

and used in accordance with the instructions, may cause harmful interference to radio communications. However, there is no guarantee that interference will not occur in a particular installation. If this equipment does cause harmful interference to radio or television reception, which can be determined by turning the equipment off and on, the user is encouraged to try to correct the interference by one or more of the following measures:

- Reorient or relocate the receiving antenna.
- Increase the separation between the equipment and receiver.
- Connect the equipment into an outlet on a circuit different from that to which the receiver is connected.
- Consult the dealer or an experienced radio/TV technician for help.

This device complies with Part 15 of the FCC Rules. Operation is subject to the following two conditions:(1) this device may not cause harmful interference and (2) this device must accept any interference received, including interference that may cause undesired operation.

Hereby, Seikaku Technical Group Limited, declares that this wireless microphone system is in compliance with the essential requirements and other relevant provisions of Directive 1999/5/EC.

INTRODUCTION

Thanks for purchasing the wireless microphone system. This system is the delicately designed UHF, PLL synthesized system with dual channel wireless receiver and applications with two microphones open simultaneously. Adapted to various condition, specially KTV.

FEATURES

- ① Wisdom ID recognition technology, 200 pcs Mic using separately. Digital mode mix transmit, audio un-digital transfer disadvantage for delay. Different ID identification number for each frequency point, to prevent mutual interference between each frequency point.
- ② Infrared (IR) synchronization technique.
- ③ 200 sets of intelligent recognition ID for interference prevention
- ④ Transmitter battery: Two 1.5V, convenience Operation.
- ⑤ The balance and the non-balanced audio frequency transmitter output connect each kind of acoustic equipment easily.
- ⑥ Transmitter red candle twinkle instruction, adapt the humanity visual characteristic.
- ⑦ LCD screen display transmitter battery and RF/AF signal peak display
- ⑧ Balanced and unbalanced audio frequency transmitter output

OPERATING INSTRUCTION

Turn on your connected amplifier or mixer, but keep the volume all the way down. Set the Volume knob on the receiver fully clockwise. This is unity gain.

Speak or sing into the microphone, or if you are using the transmitter with a connected instrument, play the instrument at normal performance level. Slowly raise the volume of your amplifier or mixer until the desired level is reached.

If you find the system has noticeable dropouts, reduced overall working range, or unexpected noise bursts, change the operating channel of the system using the steps above.

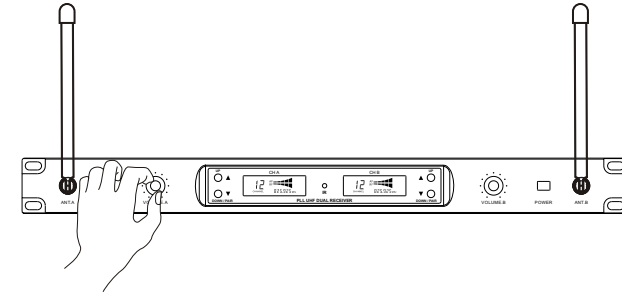

TECHNICAL SPECIFICATIONS

RECEIVER

Channel	Channel Dual-channels, up to 100 frequency presets for each frequency bands
Receiver type	Dual Receiver and PLL UHF SYNTHESIZED
Frequency band	UHF
Frequency response	50Hz-15KHz(±3dB)
Frequency stability	±0.005%
T.H.D	< 1%
Dynamic	> 100dB
Modulation mode	FM(F3E)
Max Unbalanced Output	10dBu
Max Balanced Output	10dBu
S/N Ratio	>100 dB
RF sensitivity	-100dbm/30db
Power supply	100-240V/50~60Hz_DC12V/500mA
Display mode	LCD display
Dimensions	45(W)×200(H)×480(L) mm
Weight	3.5Kg(Approx.)

OPERATING INSTRUCTION

Position the transmitter about 15~30cm from the front of the receiver with the transmitter's IR window facing the IR transmitter on the front panel of the receiver.

Press and hold the receiver UP/DOWN button to set the transmitter to the same channel as the receiver via infrared transmission.

When the transmission is complete, the receiver will receive RF signal and tone key from the transmitter. The RF indicator of the screen will light on the front panel of the receiver.

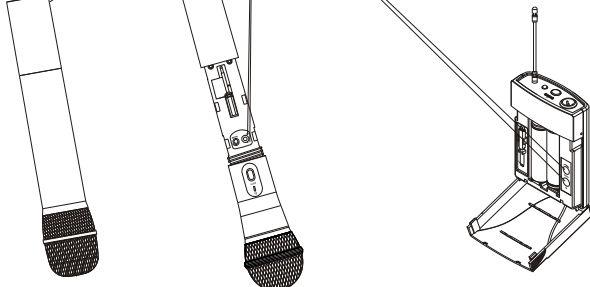
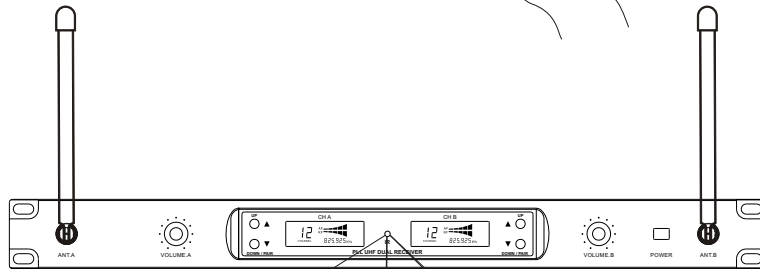
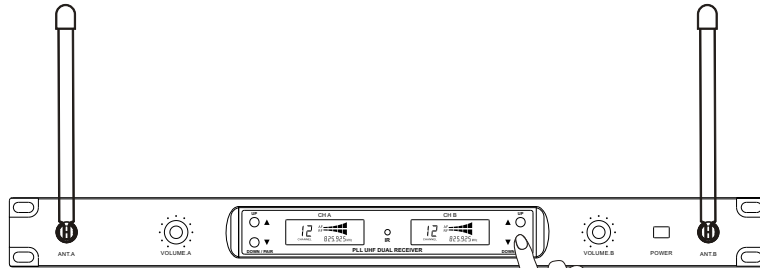

CONTROL ELEMENTS

Receiver FRONT PANEL

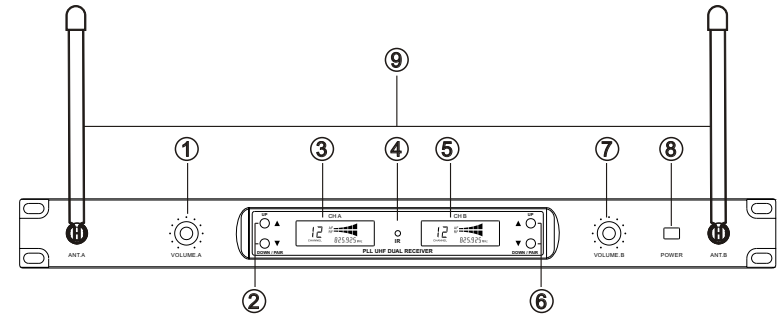

- ① CHA adjust the volume knob
- ② CHA Operation button
- ③ CHA LCD Screen
- ④ Infrarde(IR)
- ⑤ CHB LCD Screen
- ⑥ CHB Operation button
- ⑦ CHB adjust the volume knob
- ⑧ Power button/Lock
- ⑨ Antenna port

Back Panel

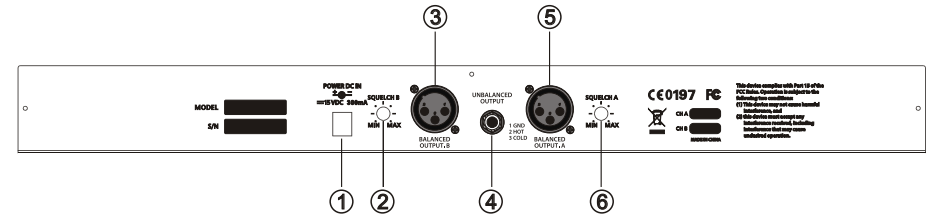

- ① Adapter jack
- ② Squel CHB
- ③ CHB audio XLR balanced output
- ④ Mix audio frequency
- ⑤ CHA audio XLR balanced output
- ⑥ Squel CHA

CONTROL ELEMENTS

Receiver screen

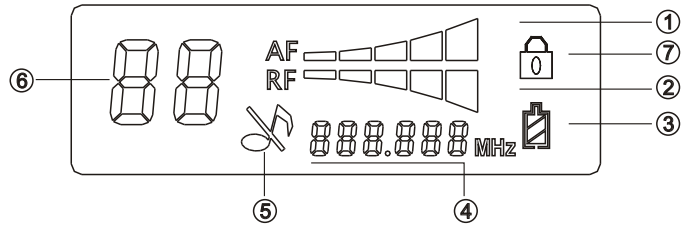

- | | |
|---|--------------------------|
| ① AF power indication | ⑤ Mic Mute indication |
| ② RF power indication | ⑥ Frequency code |
| ③ Mic power display, power flashing the power Failure | ⑦ Button lock indication |
| ④ Frequency display | |

Receiver power on

- ① Press the receiver power button continually. Receiver power on, after 2 seconds display frequency and ready.
- ② Receiver power on, press and release the power button to lock/unlock the UP/DOWN button.
- ③ Press the receiver power button again continually, after 2 seconds have no frequency code display, then loosen your hand, receiver power off.
- ④ If long time does not use the receiver, pls pull out the power adapter from the power jack.

OPERATING INSTRUCTION

With the transmitter powered off, install two fresh AA batteries into the MIC .
Leave the battery compartment open.

Turn on the power to the transmitter by pressing and holding Power switch; the indicator LED will light green.

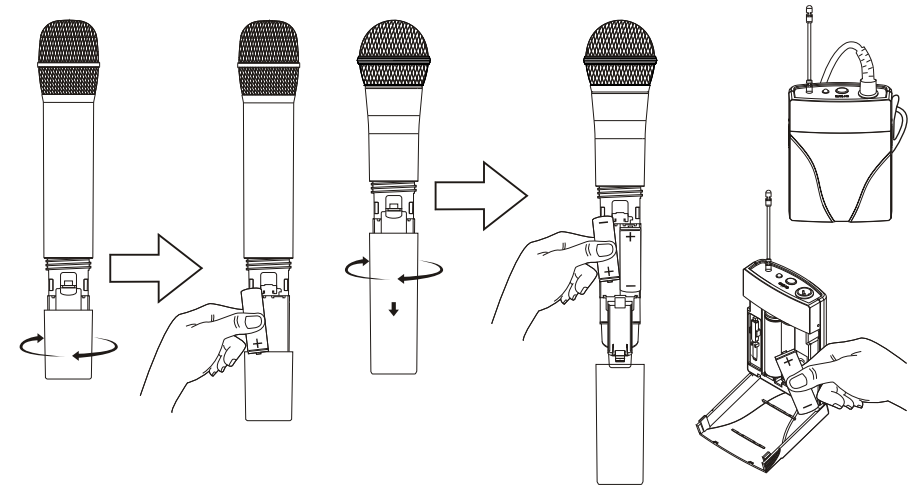

Press the UP/DOWN button on the front of the receiver to choose an available channel.

The channel number will increase by two digit, from 00-99. Once the last channel has been reached, the count will cycle back to 00.

Press and hold the UP/DOWN button for 2 seconds to send the channel information to the transmitter via infrared transmission.

Press and hold the UP button the display channel will be fast forward.

Press and hold the DOWN button the display channel will be fast backward.

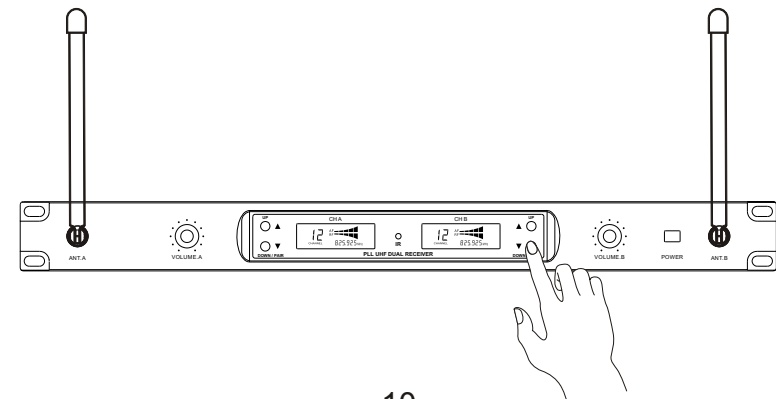

OPERATING INSTRUCTION

In order for your wireless system to work correctly, both the receiver and transmitter must be set to the same channel.

Follow the basic procedure for setting up and using your receiver wireless system:

Physically place the receiver where it will be used, and extend the antennas vertically. With the Power switch on and receiver power off, connect the included power adapter. Turn the receiver on momentarily to confirm that the unit is receiving power. You will see the LCD display light up. Then turn receiver power off.

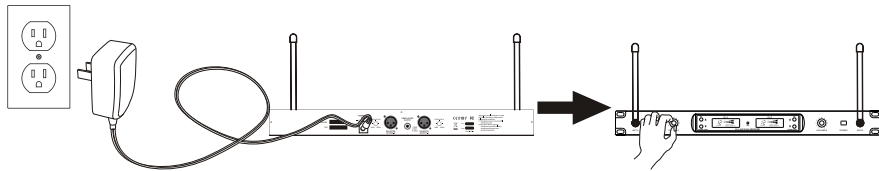

With your amplifier or mixer off and volume control all the way down, connect the receiver output jack to the mic or line level input of a mixer or amplifier using the balanced XLR output or unbalanced 1/4" line level output. Turn the Level knob on the receiver completely counterclockwise, then turn its power on.

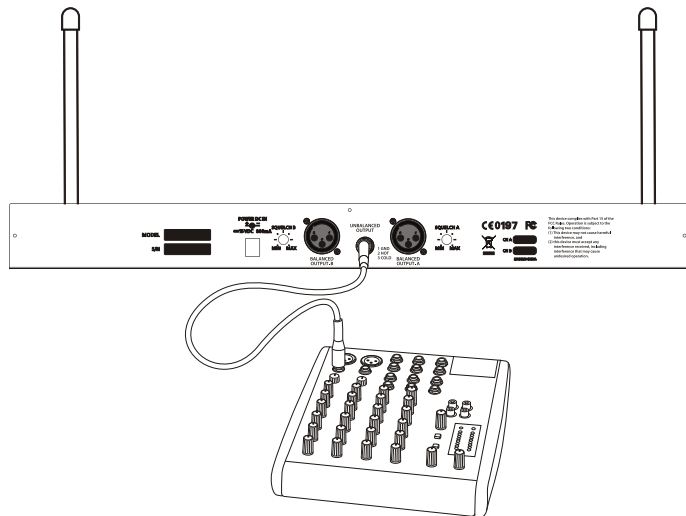

CONTROL ELEMENTS

PLASTIC HAND MIC

- ① Grille Holder
- ② Tube
- ③ Tail tube
- ④ Status Indicator

This LED displays the operation mode:

GREEN	Normal Operation
RED	Mute
Flashing RED	Low Battery

- ⑤ Power/Mute Switch

Press and hold to turn the unit on or off. Press and release to mute or unmute the transmitter.

- ⑥ IR Receiving Section

This window is used to capture the infrared signal sent from the receiver during the IRUP/DOWN to channelize the transmitter.

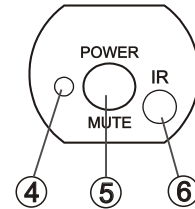
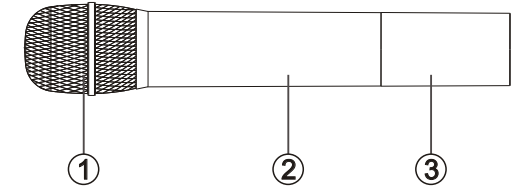

METAL HANG MIC

- ① Status indicator

This LED displays the operation mode:

GREEN	Normal Operation
RED	Mute
Flashing RED	Low Battery

- ② Power/Mute Switch

Press and hold to turn the unit on or off. Press and release to mute or unmute the transmitter.

- ③ Battery Cover

Unscrew the battery cover and slide down to open the MIC battery compartment

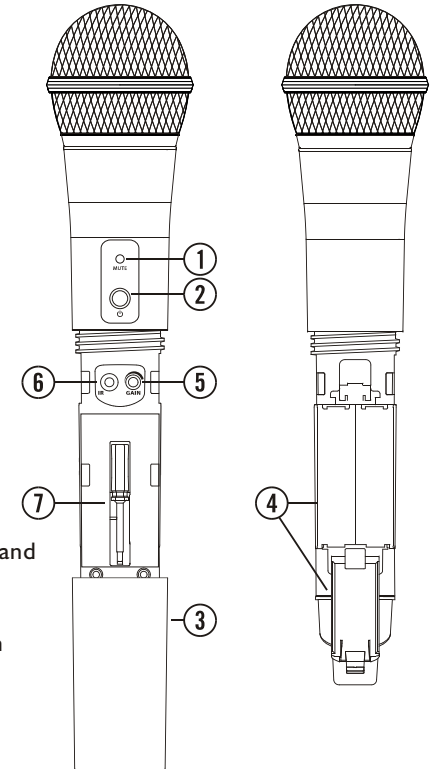

CONTROL ELEMENTS

④ Battery Holder

Open the battery holder by pressing the tab and lifting the cover. Insert two standard AA(LR6) batteries here, being sure to observe the plus and minus polarity markings shown. Although rechargeable Ni-Cad batteries can be used, they do not supply adequate current for more than four hours. **WARNING:** Do not insert the batteries backwards; doing so can cause severe damage to the MIC and will void your warranty.

⑤ Input GAIN Control

This control adjusts the transmitter input sensitivity. For optimal performance, using the included screwdriver, set the input GAIN control to where you can see the RF display of receiver screen become to full light, then turn down until the RF display not full light (less than five).

⑥ IR Lens

This window is used to capture the infrared signal sent from the receiver during the IR UP/DOWN to channelize the transmitter. The battery cover must be open and the IR Lens facing towards the receiver to load the selected channel.

⑦ Plastic Screwdriver

Designed for use in adjusting the MIC input GAIN control (See #5 Input GAIN Control HH).

BELTPACK MIC

① Antenna

This permanently attached transmitter antenna should be fully extended during normal operation.

② Status Indicator

This LED displays the operation mode:

GREEN	Normal Operation
RED	Mute
Flashing RED	Low Battery

③ Power/Mute Switch

Press and hold to turn the unit on or off. Press and release to mute or unmute the transmitter.

CONTROL ELEMENTS

④ MINI 4P CONNECTOR

- Ⓐ Pin 1, GND
- Ⓑ Pin 2, Phantom power supply for Condenser microphone
- Ⓒ Pin 3, for Guitar, bass and keyboards
- Ⓓ Pin 4, for Dynamic or condenser microphone

⑤ IR Receiving Section

This window is used to capture the infrared signal sent from the receiver during the IR UP/DOWN to channelize the transmitter.

⑥ Input GAIN Control

This control adjusts the transmitter input sensitivity to work with microphone and instruments inputs. For optimal performance, using the included screwdriver set the input GAIN control to where you can see the RF display of receiver screen become to full light, then turn down until the T he refore display not full light (less than five).

⑦ Driver

Designed for use in adjusting the MIC input GAIN control.

