

PCTEST Engineering Laboratory, Inc.

6660-B Dobbin Road • Columbia, MD 21045 • U.S.A.

TEL (410) 290-6652 • FAX (410) 290-6654

<http://www.pctestlab.com>



CERTIFICATE OF COMPLIANCE (SAR EVALUATION)

DTC COMMUNICATIONS, INC.

75 Northeastern Blvd.

Nashua, NH 03062 U.S.A.

Attn: Mr. Michael Murphy

Video/RF Applications Engineer

Dates of Tests: June 22, 1999

Test Report S/N: SAR.990622392.H25

Test Site: PCTEST Lab, Columbia, MD USA

FCC ID

H25DSS950TX

APPLICANT

DTC COMMUNICATIONS, INC.

EUT Type:	Spread Spectrum Audio Transmitter
Tx Frequency:	905.5 – 924.5 MHz
Max Output Power:	0.5 W ERP
Trade Name/Model(s):	<i>DTC DSS950TX</i>
FCC Classification:	Spread Spectrum Transmitter (DSS)
FCC Rule Part(s):	Part 15 Subpart C
Application Type:	Certification
Serial Number:	ENG-02

This wireless portable device has been shown to be capable of compliance for localized specific absorption rate (SAR) for uncontrolled environment/general population exposure limits specified in ANSI/IEEE Std. C95.1-1992 and had been tested in accordance with the measurement procedures specified in ANSI/IEEE Std. C95.3-1992. (See Test Report).

I attest to the accuracy of data. All measurements reported herein were performed by me or were made under my supervision and are correct to the best of my knowledge and belief. I assume full responsibility for the completeness of these measurements and vouch for the qualifications of all persons taking them.

NVLAP accreditation does not constitute any product endorsement by NVLAP or any agency of the United States Government.

PCTEST certifies that no party to this application has been denied the FCC benefits pursuant to Section 5301 of the Anti-Drug Abuse Act of 1988, 21 U.S.C. 853(a)

Randy Ortanez
President & Chief Engineer



990622392. DTC

© 1999 PCTEST Engineering Lab., Inc.

NVLAP[®]
LAB CODE 100431-0

Table of Contents

SCOPE	1
INTRODUCTION / SAR DEFINITION	2
SAR MEASUREMENT SET-UP	3
E-FIELD PROBE SYSTEM	4
E-FIELD PROBE CALIBRATION PROCESS	5
DATA EXTRAPOLATION	6
PHANTOM, HOLDER & MUSCLE EQUIVALENT TISSUE	7
SYSTEM SPECIFICATIONS	8
MEASUREMENT PROCESS	9
TEST POSITION OF THE EUT	10
ANSI/IEEE C95.1 RF EXPOSURE LIMITS	11
MEASUREMENT UNCERTAINTIES	12
TEST DATA SUMMARY	13
SAR TEST EQUIPMENT LIST	14
CONCLUSION	15
REFERENCES	16
APPENDIX A – PROBE CALIBRATION DATA	17
APPENDIX B – DIPOLE VALIDATION DATA	18
APPENDIX C – TEST SETUP PHOTOGRAPHS	19

SAR MEASUREMENT REPORT

Scope - Environmental evaluation measurements of specific absorption rate¹ (SAR) distributions in simulated human muscle tissues exposed to radiofrequency (RF) radiation from wireless portable devices for compliance with the rules and regulations of the U.S. Federal Communications Commission (FCC).²

Company Name:	DTC COMMUNICATIONS, INC.
Address:	75 Northeastern Blvd. Nashua, NH 03062 U.S.A.
Attention:	Michael Murphy, Video/RF Applications Engineer

- EUT Type: Spread Spectrum Audio Transmitter
- Trade Name: **DTC**
- Model(s): **DSS950TX**
- FCC IDENTIFIER: **H25DSS950TX**
- S/N: ENG-02
- Tx Frequency: 905.5 – 924.5 MHz
- Application Type: Certification
- FCC Classification: Spread Spectrum Transmitter (DSS)
- FCC Rule Part(s): § 15(C)
- Modulation(s): Direct Sequence System (DSS)
- Max. Output Power: 0.5 WERP
- Supply Voltage: 6-9 VDC
- Antenna Type: Internal Patch Type
- Date(s) of Tests: June 22, 1999
- Place of Tests: PCTEST Engineering Lab.
Columbia, MD, U.S.A.
- Report Serial No.: SAR.990622392.H25



Fig. 1 SAR Test Setup



¹ Specific Absorption Rate (SAR) is a measure of the rate of energy absorption due to exposure to an RF transmitting source (wireless portable device).

² IEEE/ANSI Std. C95.1-1992 limits are used to determine compliance with FCC ET Docket 93-62.

INTRODUCTION

The FCC has adopted the guidelines for evaluating the environmental effects of radiofrequency radiation in ET Docket 93-62 on Aug. 6, 1996 to protect the public and workers from the potential hazards of RF emissions due to FCC-regulated portable devices.[1]

The safety limits used for the environmental evaluation measurements are based on the criteria published by the American National Standards Institute (ANSI) for localized specific absorption rate (SAR) in *IEEE/ANSI C95.1-1992 Standard for Safety Levels with Respect to Human Exposure to Radio Frequency Electromagnetic Fields, 3 kHz to 300 GHz*. (c) 1992 by the Institute of Electrical and Electronics Engineers, Inc., New York, New York 10017.[2] The measurement procedure described in *IEEE/ANSI C95.3-1992 Recommended Practice for the Measurement of Potentially Hazardous Electromagnetic Fields - RF and Microwave*[3] is used for guidance in measuring SAR due to the RF radiation exposure from the Equipment Under Test (EUT). These criteria for SAR evaluation are similar to those recommended by the National Council on Radiation Protection and Measurements (NCRP) in *Biological Effects and Exposure Criteria for Radiofrequency Electromagnetic Fields*, NCRP Report No. 86 (c) NCRP, 1986, Bethesda, MD 20814.[4] SAR is a measure of the rate of energy absorption due to exposure to an RF transmitting source. SAR values have been related to threshold levels for potential biological hazards.

SAR Definition

Specific Absorption Rate (SAR) is defined as the time derivative (rate) of the incremental energy (dU) absorbed by (dissipated in) an incremental mass (dm) contained in a volume element (dV) of a given density (ρ). It is also defined as the rate of RF energy absorption per unit mass at a point in an absorbing body (see Fig. 2).

$$SAR = \frac{d}{dt} \left(\frac{dU}{dm} \right) = \frac{d}{dt} \left(\frac{dU}{\rho dV} \right)$$

Figure 1. SAR Mathematical Equation

SAR is expressed in units of Watts per Kilogram (W/kg).

$$SAR = \mathbf{s} E^2 / \mathbf{r}$$

where:

\mathbf{s}	=	conductivity of the tissue-simulant material (S/m)
\mathbf{r}	=	mass density of the tissue-simulant material (kg/m^3)
\mathbf{E}	=	Total RMS electric field strength (V/m)

NOTE: The primary factors that control rate of energy absorption were found to be the wavelength of the incident field in relations to the dimensions and geometry of the irradiated organism, the orientation of the organism in relation to the polarity of field vectors, the presence of reflecting surfaces, and whether conductive contact is made by the organism with a ground plane.[4]

SAR MEASUREMENT SET-UP

These measurements are performed using the DASY3 automated dosimetric assessment system. It is made by Schmid & Partner Engineering AG (SPEAG) in Zurich, Switzerland. It consists of high precision robotics system (Staubli), robot controller, Pentium III computer, near-field probe, probe alignment sensor, and the generic twin phantom containing the brain equivalent material. The robot is a six-axis industrial robot performing precise movements to position the probe to the location (points) of maximum electromagnetic field (EMF) (see Fig. 2).

A cell controller system contains the power supply, robot controller, teach pendant (Joystick), and remote control, is used to drive the robot motors. The PC consists of the Micron Pentium III 500 MHz computer with Windows NT system and SAR Measurement Software DASY3, A/D interface card, monitor, mouse, and keyboard. The Staubli Robot is connected to the cell controller to allow software manipulation of the robot. A data acquisition electronic (DAE) circuit performs the signal amplification, signal multiplexing, AD-conversion, offset measurements, mechanical surface detection, collision detection, etc. is connected to the Electro-optical coupler (EOC). The EOC performs the conversion from the optical into digital electric signal of the DAE and transfers data to the PC plug-in card. The DAE3 consists of a

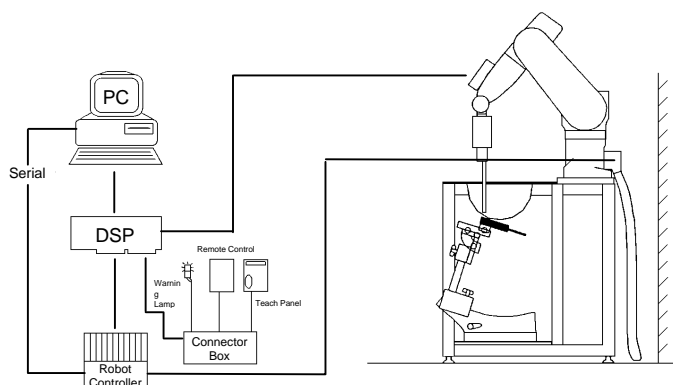

Figure 2. PCTEST SAR Lab II Test Measurement Set-up

highly sensitive electrometer-grade preamplifier with auto-zeroing, a channel and gain-switching multiplexer, a fast 16 bit AD-converter and a command decoder and control logic unit. Transmission to the PC-card is accomplished through an optical downlink for data and status information and an optical uplink for commands and clock lines. The mechanical probe mounting device includes two different sensor systems for frontal and sidewise probe contacts. They are also used for mechanical surface detection and probe collision detection. The robot uses its own controller with a built in VME-bus computer. The system is described in detail in [5].

DASY3 E-FIELD PROBE SYSTEM

ET3DV5 Probe Specification

Construction	Symmetrical design with triangular core Built-in optical fiber for surface detection System Built-in shielding against static charges
Calibration	In air from 10 MHz to 2.5 GHz In brain and muscle simulating tissue at Frequencies of 450 MHz, 900 MHz and 1.8 GHz (accuracy $\pm 8\%$)
Frequency	10 MHz to > 6 GHz; Linearity: ± 0.2 dB (30 MHz to 3 GHz)
Directivity	± 0.2 dB in muscle tissue (rotation around probe axis) ± 0.4 dB in muscle tissue (rotation normal probe axis)
Dynamic Range	5 μ W/g to > 100 mW/g; Linearity: ± 0.2 dB
Surface Detection	± 0.2 mm repeatability in air and clear liquids over diffuse reflecting surfaces.
Dimensions	Overall length: 330 mm Tip length: 16 mm Body diameter: 12 mm Tip diameter: 6.8 mm Distance from probe tip to dipole centers: 2.7 mm
Application	General dosimetry up to 3 GHz Compliance tests of mobile phones Fast automatic scanning in arbitrary phantoms

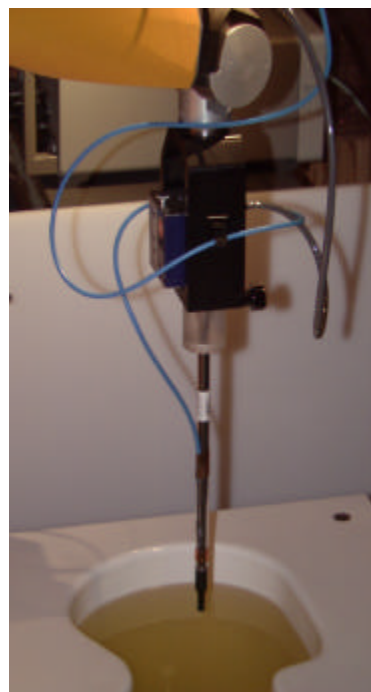

Figure 4. Photograph of the Probe and the Phantom



Fig. 5. ET3DV5 E-field Probe

The SAR measurements were conducted with the dosimetric probe ET3DV5, designed in the classical triangular configuration [5] and optimized for dosimetric evaluation. The probe is constructed using the thick film technique; with printed resistive lines on ceramic substrates. The probe is equipped with an optical multifiber line ending at the front of the probe tip. It is connected to the EOC box on the robot arm and provides an automatic detection of the phantom surface. Half of the fibers are connected to a pulsed infrared transmitter, the other half to a synchronized receiver. As the probe approaches the surface, the reflection from the surface produces a coupling from the transmitting to the receiving fibers. This reflection increases first during the approach, reaches a maximum and then decreases. If the probe is flatly touching the surface, the coupling is zero. The distance of the coupling maximum to the surface is independent of the surface reflectivity and largely independent of the surface to probe angle. The DASY3 software reads the reflection during a software approach and looks for the maximum using a 2nd order fitting. The approach is stopped at reaching the maximum.

E-FIELD PROBE CALIBRATION PROCESS

E-Probe Calibration

Each probe is calibrated according to a dosimetric assessment procedure described in [6] with an accuracy better than +/- 10%. The spherical isotropy was evaluated with the procedure described in [7] and found to be better than +/-0.25dB. The sensitivity parameters (NormX, NormY, NormZ), the diode compression parameter (DCP) and the conversion factor (ConvF) of the probe is tested.

The free space E-field from amplified probe outputs is determined in a test chamber. This is performed in a TEM cell for frequencies below 1 GHz, and in a waveguide above 1 GHz for free space. For the free space calibration, the probe is placed in the volumetric center of the cavity and at the proper orientation with the field. The probe is then rotated 360 degrees.

E-field temperature correlation calibration is performed in a flat phantom filled with the appropriate simulated brain tissue. The measured free space E-field in the medium correlates to temperature rise in a dielectric medium. For temperature correlation calibration a RF transparent thermistor-based temperature probe is used in conjunction with the E-field probe.

$$SAR = C \frac{\Delta T}{\Delta t}$$

where:

Δt = exposure time (30 seconds),

C = heat capacity of tissue (brain or muscle),

ΔT = temperature increase due to RF exposure.

SAR is proportional to $\Delta T / \Delta t$, the initial rate of tissue heating, before thermal diffusion takes place. Now it's possible to quantify the electric field in the simulated tissue by equating the thermally derived SAR to the E- field;

$$SAR = \frac{|E|^2 \cdot s}{r}$$

where:

σ = simulated tissue conductivity,

ρ = Tissue density (1.25 g/cm³ for brain tissue)

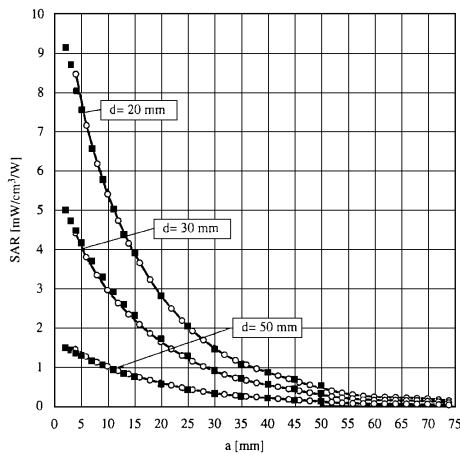

Figure 6. E-Field and Temperature measurements at 900MHz [5]

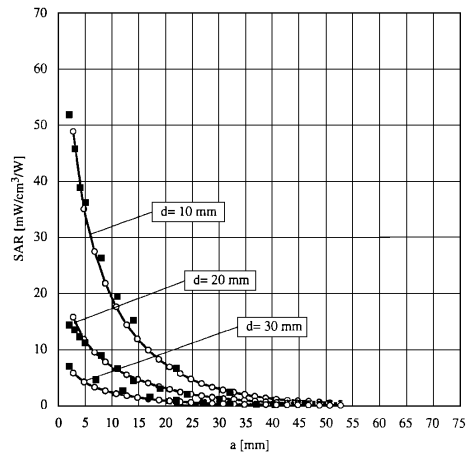

Figure 7. E-Field and temperature measurements at 1.8GHz [5]

Data Extrapolation

The DASY3 software automatically executes the following procedures to calculate the field units from the microvolt readings at the probe connector. The first step of the evaluation is a linearization of the filtered input signal to account for the compression characteristics of the detector diode. The compensation depends on the input signal, the diode type and the DC-transmission factor from the diode to the evaluation electronics. If the exciting field is pulsed, the crest factor of the signal must be known to correctly compensate for peak power. The formula for each channel can be given as [8]:

$$V_i = U_i + U_i^2 \cdot \frac{cf}{dcp_i}$$

with V_i = compensated signal of channel i (i=x,y,z)
 U_i = input signal of channel i (i=x,y,z)
 cf = crest factor of exciting field (DASY parameter)
 dcp_i = diode compression point (DASY parameter)

From the compensated input signals the primary field data for each channel can be evaluated:

E-field probes:

$$E_i = \sqrt{\frac{V_i}{Norm_i \cdot ConvF}}$$

with V_i = compensated signal of channel i (i = x,y,z)
 $Norm_i$ = sensor sensitivity of channel i (i = x,y,z)
 $\mu V/(V/m)^2$ for E-field probes
 $ConvF$ = sensitivity of enhancement in solution
 E_i = electric field strength of channel i in V/m

The RSS value of the field components gives the total field strength (Hermetian magnitude):

$$E_{tot} = \sqrt{E_x^2 + E_y^2 + E_z^2}$$

The primary field data are used to calculate the derived field units.

$$SAR = \frac{E_{tot}^2 \cdot \sigma}{\rho \cdot 1000}$$

with SAR = local specific absorption rate in W/g
 E_{tot} = total field strength in V/m
 σ = conductivity in [mho/m] or [Siemens/m]
 ρ = equivalent tissue density in g/cm³

The power flow density is calculated assuming the excitation field to be a free space field.

$$P_{pwe} = \frac{E_{tot}^2}{3770}$$

with P_{pwe} = equivalent power density of a plane wave in W/cm²
 E_{tot} = total electric field strength in V/m

PHANTOM & MUSCLE EQUIVALENT TISSUES

Generic Twin Phantom

The Generic Twin Phantom is constructed of a fiberglass shell integrated in a wooden table. The shape of the shell is based on data from an anatomical study designed to determine the maximum exposure in at least 90% of all users [9][10]. It enables the dosimetric evaluation of left and right hand phone usage as well as body mounted usage at the flat phantom region. A cover prevents the evaporation of the liquid. Reference markings on the Phantom allow the complete setup of all predefined phantom positions and measurement grids by manually teaching three points in the robot. See Figure 8.



Fig. 8 Generic Twin Phantom

Shell Thickness	2 ± 0.1 mm
Filling Volume	Volume Approx. 20 liters
Dimensions	810 x 1000 x 500 mm (H x L x W)

Muscle Simulating Mixture Characterization

The muscle mixture consists of a viscous gel using hydroxyethylcellulose (HEC) gelling agent and saline solution (see Table 1). Preservation with a bacteriacide is added and visual inspection is made to make sure air bubbles are not trapped during the mixing process. The mixtures are calibrated to obtain proper dielectric constant (permittivity) and conductivity of muscle tissue. The mixture characterizations used for the muscle tissue simulating liquid are according to the data by C. Gabriel and G. Hartsgrove [11].

MUSCLE MIXTURE %	FREQUENCY 900 - 950 MHz
WATER	52.4
SUGAR	45.0
SALT	1.4
BACTERIACIDE	0.2
HEC	1.0

Table 1. Composition of the Muscle Tissue Equivalent Matter

Device Holder for Transmitters

In combination with the Generic Twin Phantom V3.0, the Mounting Device (POM) enables the rotation of the mounted transmitter in spherical coordinates. The devices can be easily, accurately, and repeatably positioned according to the FCC and CENELEC specifications. The device holder can be locked at different phantom locations (left head, right head, flat phantom).



Fig. 9. Device Holder

SYSTEM SPECIFICATIONS

Robotic System Specifications

Specifications

POSITIONER: Stäubli Unimation Corp. Robot Model: RX60L
Repeatability: 0.02 mm
No. of axis: 6

Data Acquisition Electronic (DAE) System

Cell Controller

Processor: Pentium III
Clock Speed: 450 MHz
Operating System: Windows NT
Data Card: DASY3 PC-Board

Data Converter

Features: Signal Amplifier, multiplexer, A/D converter, and control logic
Software: DASY3 software
Connecting Lines: Optical downlink for data and status info.
Optical uplink for commands and clock

PC Interface Card

Function: 24 bit (64 MHz) DSP for real time processing
Link to DAE3
16 bit A/D converter for surface detection system
serial link to robot
direct emergency stop output for robot

E-Field Probes

Model: ET3DV5 S/N: 1368 S/N: 1370
Construction: Triangular core fiber optic detection system
Frequency: 10 MHz to 6 GHz
Linearity: ± 0.2 dB (30 MHz to 3 GHz)

Phantom

Phantom: Generic Twin
Shell Material: Fiberglass
Thickness: 2.0 ± 0.1 mm

Tissue Equivalent

Muscle

900-950MHz

Dielectric Constant: ϵ 56.2
Conductivity: σ 0.95

MEASUREMENT PROCESS

System Verification

Prior to assessment, the system is verified to the $\pm 5\%$ of the specifications by using the system validation kit. System verification is performed with 800 MHz brain equivalent material. Once system verification is complete, the fluid is replaced with 800 MHz muscle equivalent material.

Validation Kit	Targeted SAR _{1g} (mW/g)	Measured SAR _{1g} (mW/g)
D835V2, S/N # 406	2.11	2.11

Dosimetric Assessment Setup

The evaluation was performed with the following procedure:

1. The SAR value at a fixed location above the ear point was measured and was used as a reference value for assessing the power drop.
2. The SAR distribution at the exposed side of the head was measured at a distance of 3.9mm from the inner surface of the shell. The area covered the entire dimension of the head and the horizontal grid spacing was 20mm x 20mm. Based on this data, the area of the maximum absorption was determined by spline interpolation.
3. Around this point, a volume of 32mm x 32mm x 34mm was assessed by measuring 5 x 5 x 7 points. On this basis of this data set, the spatial peak SAR value was evaluated with the following procedure:
 - a. The data at the surface were extrapolated, since the center of the dipoles is 2.7mm away from the tip of the probe and the distance between the surface and the lowest measuring point is 1.2mm. The extrapolation was based on a least square algorithm [13]. A polynomial of the fourth order was calculated through the points in z-axis. This polynomial was then used to evaluate the points between the surface and the probe tip.
 - b. The maximum interpolated value was searched with a straight-forward algorithm. Around this maximum the SAR values averaged over the spatial volumes (1g or 10g) were computed using the 3D-Spline interpolation algorithm. The 3D-spline is composed of three one-dimensional splines with the "Not a knot" condition (in x,y, and z directions) [13][14]. The volume was integrated with the trapezoidal algorithm. One thousand points (10 x 10 x 10) were interpolated to calculate the average.
 - c. All neighboring volumes were evaluated until no neighboring volume with a higher average value was found.
4. The SAR value, at the same location as procedure #1, was re-measured. If the value changed by more than 5%, the evaluation is repeated.

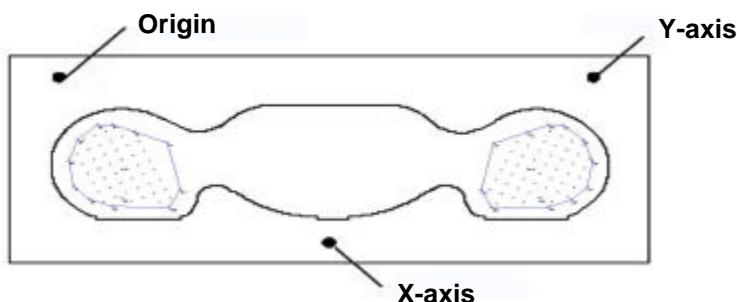

Fig 10. SAR Measurement Points in Area Scan

TEST POSITION OF THE EUT

EUT Test Placement

The EUT was positioned against the phantom in the normal operating position. This test set-up position places the significant source of RF emissions (antenna) closest to the body. The measurement achieved from this placement provided for the worst-case situation to be obtained. For actual EUT set-up see figure 8 below.



Figure 8. Actual placement of EUT positioned against the surface of the phantom.

ANSI/IEEE C95.1 - 1992 RF EXPOSURE LIMITS

HUMAN EXPOSURE	UNCONTROLLED ENVIRONMENT General Population (W/kg) or (mW/g)	CONTROLLED ENVIRONMENT Occupational (W/kg) or (mW/g)
SPATIAL PEAK SAR * (Brain)	1.60	8.00
SPATIAL AVERAGE SAR ** (Whole Body)	0.08	0.40
SPATIAL PEAK SAR *** (Hands / Feet / Ankle / Wrist)	4.00	20.00

Table 2. Safety Limits for Partial Body Exposure [2]

NOTES:

- * The Spatial Peak value of the SAR averaged over any 1 gram of tissue (defined as a tissue volume in the shape of a cube) and over the appropriate averaging time.
- ** The Spatial Average value of the SAR averaged over the whole-body.
- *** The Spatial Peak value of the SAR averaged over any 10 grams of tissue (defined as a tissue volume in the shape of a cube) and over the appropriate averaging time.

Uncontrolled Environments are defined as locations where there is the exposure of individuals who have no knowledge or control of their exposure.

Controlled Environments are defined as locations where there is exposure that may be incurred by persons who are aware of the potential for exposure, (i.e. as a result of employment or occupation).

MEASUREMENT UNCERTAINTIES

Measurement uncertainties in SAR measurements are difficult to quantify due to several variables including biological, physiological, and environmental. However, we estimate the measurement uncertainties in SAR to be less than 15-25 % [16].

According to ANSI/IEEE C95.3, the overall uncertainties are difficult to assess and will vary with the type of meter and usage situation. However, accuracy's of ± 1 to 3 dB can be expected in practice, with greater uncertainties in near-field situations and at higher frequencies (shorter wavelengths), or areas where large reflecting objects are present. Under optimum measurement conditions, SAR measurement uncertainties of at least ± 2 dB can be expected.[3]

According to CENELEC [17], typical worst-case uncertainty of field measurements is ± 5 dB. For well defined modulation characteristics the uncertainty can be reduced to ± 3 dB.

Uncertainty Description	Error	Distribution	Weight	Std. Deviation	Offset
Probe Uncertainty					
Axial isotropy	± 0.2 dB	U-Shaped	0.5	± 2.4 %	
Spherical isotropy	± 0.4 dB	U-Shaped	0.5	± 4.8 %	
Isotropy from gradient	± 0.5 dB	U-Shaped	0	\pm	
Spatial resolution	± 0.5 %	Normal	1	± 0.5 %	
Linearity error	± 0.2 dB	Rectangle	1	± 2.7 %	
Calibration error	± 3.3 %	Normal	1	± 3.3 %	
SAR Evaluation Uncertainty					
Data acquisition error	± 1 %	Rectangle	1	± 0.6 %	
ELF and RF disturbances	± 0.25 %	Normal	1	± 0.25 %	
Conductivity assessment	± 10 %	Rectangle	1	± 5.8 %	
Spatial Peak SAR Evaluation Uncertainty					
Extrapol boundary effect	± 3 %	Normal	1	± 3 %	± 5 %
Probe positioning error	± 0.1 mm	Normal	1	± 1 %	
Integrat. And cube orient	± 3 %	Normal	1	± 3 %	
Cube Shape inaccuracies	± 2 %	Rectangle	1	± 1.2 %	
Device positioning	± 6 %	Normal	1	± 6 %	
Combined Uncertainties				± 11.7 %	± 5 %

Table 3. Breakdown of Errors [18]

TEST DATA SUMMARY

Ambient TEMPERATURE (°C) _____ 23.0 _____
 Relative HUMIDITY (%) _____ 72.0 _____
 Atmospheric PRESSURE (kPa) _____ 101.0 _____

Mixture Type: _____ Muscle _____

Dielectric Constant: _____ 56.2 _____

Conductivity: _____ 0.95 S/m _____

Closest Distance (between Phantom Surface & Phone Antenna): _____ 0.5 cm _____

Measurement Results

FREQUENCY MHz	Modulation	POWER (W)	Antenna Position	SAR (W/kg)
915.0	DSS	0.5	OUT	0.0887
ANSI / IEEE C95.1 1992 - SAFETY LIMIT Spatial Peak (Muscle) Uncontrolled Exposure/General Population			1.6 W/kg (mW/g)	

NOTES:

- The test data reported are the worst-case SAR value with the antenna-phantom position set in a typical configuration. All modes of operation were investigated and the worst-case are reported.
- Battery condition is fully charged for all readings.
- Power Measured: Conducted ERP EIRP



 Randy Ortanez
 President & Chief Engineer

PCTEST SEAL

SAR TEST EQUIPMENT

Type / Model	Calib. Date	S/N:
Stäubli Robot RX60L	Feb. 99	599131-01
Stäubli Robot Controller	Feb. 99	PCT592
Stäubli Teach Pendant (Joystick)	Feb. 99	3323-00161
Micron Computer 450 MHz Pentium III, Windows NT	Feb. 99	PCT577
SPEAG EDC3	Feb. 99	321
SPEAG DAE3	Feb. 99	330
SPEAG E-Field Probe ET3DV5	Feb. 99	1368
SPEAG E-Field Probe ET3DV5	Feb. 99	1370
SPEAG Dummy Probe	Feb. 99	PCT583
SPEAG Generic Twin Phantom	Feb. 99	PCT587
SPEAG Light Alignment Sensor	Feb. 99	205
SPEAG Validation Dipole D1900V2	Feb. 99	PCT593
Muscle Equivalent Matter (900MHz)	Jun. 99	PCTMEM01
Robot Table		PCT586
Phone Holder		PCT588
A/B Power Indicator		PCT589
Remote Power Switch		PCT590
Phantom Cover		PCT591
HP Spectrum Analyzer	Dec. 98	PCT200
IFI TEM Cell Model: CC110EXX (DC - 2000 MHz)	Jan. 99	A427-0697
Microwave Amp. Model: 5S1G4 (800MHz - 4.2GHz, 5 Watts)	Jan. 99	22332

NOTE:

The E-field probe was calibrated by SPEAG. The SAR calibration of the E-field probe is performed by temperature measurement procedure. A TEM cell is used for the free space calibration of the probe. The brain simulating material is calibrated by PCTEST using the dielectric probe system and network analyzer to determine the conductivity and permittivity (dielectric constant) of the brain-equivalent material.

The following list of equipment was used to calibrate the brain equivalent material:

Power Meter	Gigatronics 85422
Signal Generator	HP-8648D (9kHz ~ 4GHz)
Power Amp	Amplifier Research 5S1G4 (5 Watts, 800MHz ~ 4.2GHz)
Network Analyzer	HP-8753E (30kHz ~ 3GHz)
Dielectric Probe Kit	HP85070B

CONCLUSION

The SAR measurement indicates that the EUT complies with the RF radiation exposure limits of the FCC. These measurements are taken to simulate the RF effects exposure under worst-case conditions. Precise laboratory measures were taken to assure repeatability of the tests.

Please note that the absorption and distribution of electromagnetic energy in the body are very complex phenomena that depend on the mass, shape, and size of the body, the orientation of the body with respect to the field vectors, and the electrical properties of both the body and the environment. Other variables that may play a substantial role in possible biological effects are those that characterize the environment (e.g. ambient temperature, air velocity, relative humidity, and body insulation) and those that characterize the individual (e.g. age, gender, activity level, debilitation, or disease). Because innumerable factors may interact to determine the specific biological outcome of an exposure to electromagnetic fields, any protection guide shall consider maximal amplification of biological effects as a result of field-body interactions, environmental conditions, and physiological variables.[3]

REFERENCES:

- [1] Federal Communications Commission, ET Docket 93-62, Guidelines for Evaluating the Environmental Effects of Radiofrequency Radiation, Aug. 1996.
- [2] ANSI/IEEE C95.1 - 1991, *American National Standard safety levels with respect to human exposure to radio frequency electromagnetic fields, 300kHz to 100GHz*, New York: IEEE, Aug. 1992
- [3] ANSI/IEEE C95.3 - 1991, *IEEE Recommended Practice for the Measurement of Potentially Hazardous Electromagnetic Fields - RF and Microwave*, New York: IEEE, 1992.
- [4] NCRP, National Council on Radiation Protection and Measurements, *Biological Effects and Exposure Criteria for RadioFrequency Electromagnetic Fields*, NCRP Report No. 86, 1986. Reprinted Feb. 1995.
- [5] T. Schmid, O. Egger, N. Kuster, *Automated E-field scanning system for dosimetric assessments*, IEEE Transaction on Microwave Theory and Techniques, vol. 44, Jan. 1996, pp. 105-113.
- [6] K. Pokovic, T. Schmid, N. Kuster, *Robust setup for precise calibration of E-field probes in tissue simulating liquids at mobile communications frequencies*, ICECOM97, Oct. 1997, pp. 120-124.
- [7] K. Poković, T. Schmid, and N. Kuster, *E-field Probe with improved isotropy in brain simulating liquids*, Proceedings of the ELMAR, Zadar, Croatia, June 23-25, 1996, pp. 172-175.
- [8] Schmid & Partner Engineering AG, Application Note: Data Storage and Evaluation, June 1998, p2.
- [9] V. Hombach, K. Meier, M. Burkhardt, E. Kuhn, N. Kuster, *The Dependence of EM Energy Absorption upon Human Head Modeling at 900 MHz*, IEEE Transaction on Microwave Theory and Techniques, vol. 44 no. 10, Oct. 1996, pp. 1865-1873.
- [10] N. Kuster and Q. Balzano, *Energy absorption mechanism by biological bodies in the near field of dipole antennas above 300MHz*, IEEE Transaction on Vehicular Technology, vol. 41, no. 1, Feb. 1992, pp. 17-23.
- [11] G. Hartsgrrove, A. Kraszewski, A. Surowiec, *Simulated Biological Materials for Electromagnetic Radiation Absorption Studies*, University of Ottawa, Bioelectromagnetics, Canada: 1987, pp. 29-36.
- [12] Q. Balzano, O. Garay, T. Manning Jr., *Electromagnetic Energy Exposure of Simulated Users of Portable Cellular Telephones*, IEEE Transactions on Vehicular Technology, vol. 44, no.3, Aug. 1995.
- [13] W. Gander, *Computermathematick*, Birkhaeuser, Basel, 1992.
- [14] W.H. Press, S.A. Teukolsky, W.T. Vetterling, and B.P. Flannery, *Numerical Recipes in C, The Art of Scientific Computing*, Second edition, Cambridge University Press, 1992.
- [15] Federal Communications Commission, OET Bulletin 65, *Evaluating Compliance with FCC Guidelines for Human Exposure to Radiofrequency Electromagnetic Fields*. Supplement C, Dec. 1997.
- [16] N. Kuster, R. Kastle, T. Schmid, *Dosimetric evaluation of mobile communications equipment with known precision*, IEEE Transaction on Communications, vol. E80-B, no. 5, May 1997, pp. 645-652.
- [17] CENELEC CLC/SC111B, European Prestandard (prENV 50166-2), *Human Exposure to Electromagnetic Fields High-frequency: 10kHz-300GHz*, Jan. 1995.
- [18] Prof. Dr. Niels Kuster, ETH, Eidgenössische Technische Hochschule Zürich, *Dosimetric Evaluation of the Cellular Phone*.

APPENDIX A – SAR TEST PLOTS

EUT DSS950TX

Generic Twin Phantom; Flat Section; Probe: ET3DV5 - SN1368

835MHz: $\sigma = 0.95$ mho/m $\epsilon_r = 56.2$ $\rho = 1.00$ g/cm³

File #371

Antenna Position Out

Crest Factor 1.0

SAR (1g): 0.0887 mW/g \pm 0.13 dB

Body worn RF transmitter

Serial # ENG-02

Antenna facing away from body

Without external microphone

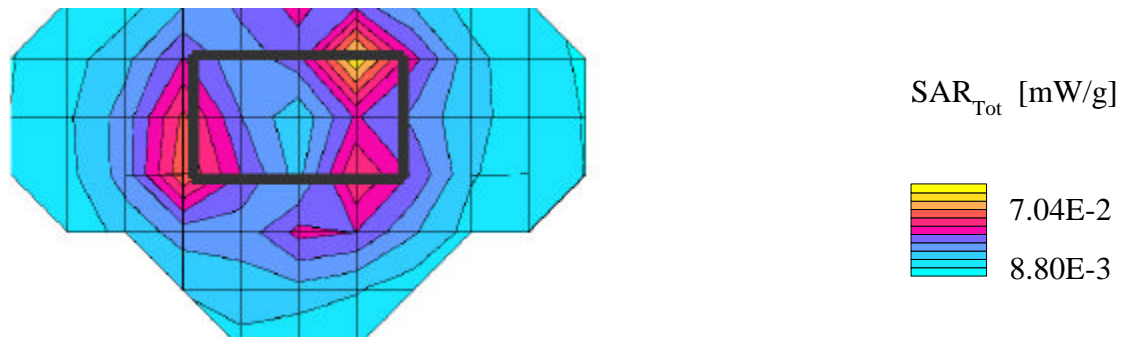

APPENDIX B – SAR TEST SETUP PHOTOGRAPHS





APPENDIX C – DIPOLE VALIDATION DATA

EUT 835 MHz Dipole

Generic Twin Phantom; Flat Section; Probe: ET3DV5 - SN1368

835MHz: $\sigma = 0.80$ mho/m $\epsilon_r = 43.4$ $\rho = 1.00$ g/cm³

File #758

Antenna Position Out

Crest Factor 1.0

SAR (1g): 2.11 mW/g

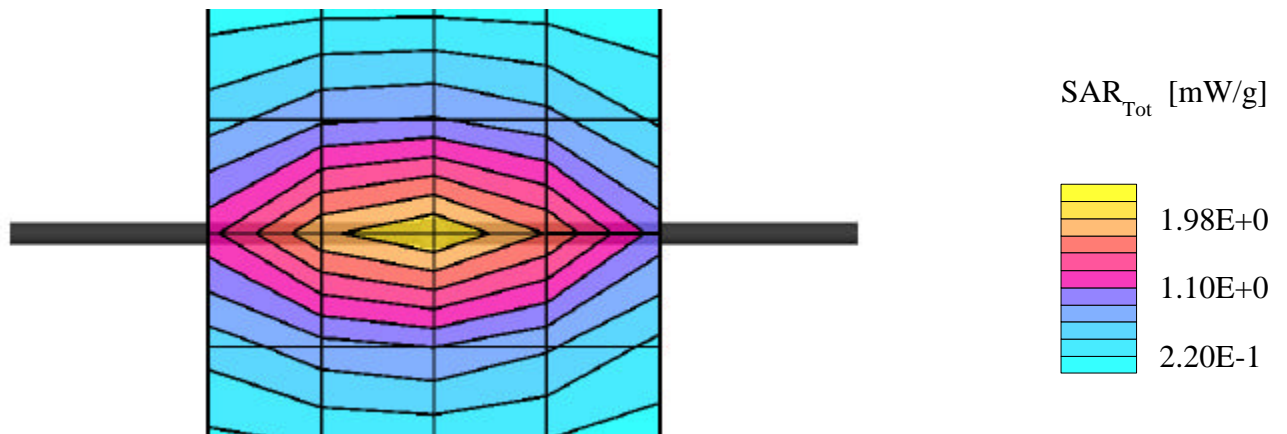

Validation Dipole D835V2 SN:406, $d = 15\text{mm}$

Frequency: 835 MHz; Antenna Input Power: 250 [mW]

Generic Twin Phantom; Flat Section; Grid Spacing: $D_x = 20.0$, $D_y = 20.0$, $D_z = 10.0$

Probe: ET3DV5 - SN1342/DAE3; ConvF(5.75,5.75,5.75); Brain 835 MHz: $\sigma = 0.79$ mho/m $\epsilon_r = 41.9$ $\rho = 1.00$ g/cm³

Cubes (2): Peak: 3.17 mW/g ± 0.03 dB, SAR (1g): 2.11 mW/g ± 0.03 dB, SAR (10g): 1.41 mW/g ± 0.04 dB, (Worst-case extrapolation)

Penetration depth: 13.4 (12.3, 14.9) [mm]

Powerdrift: -0.01 dB

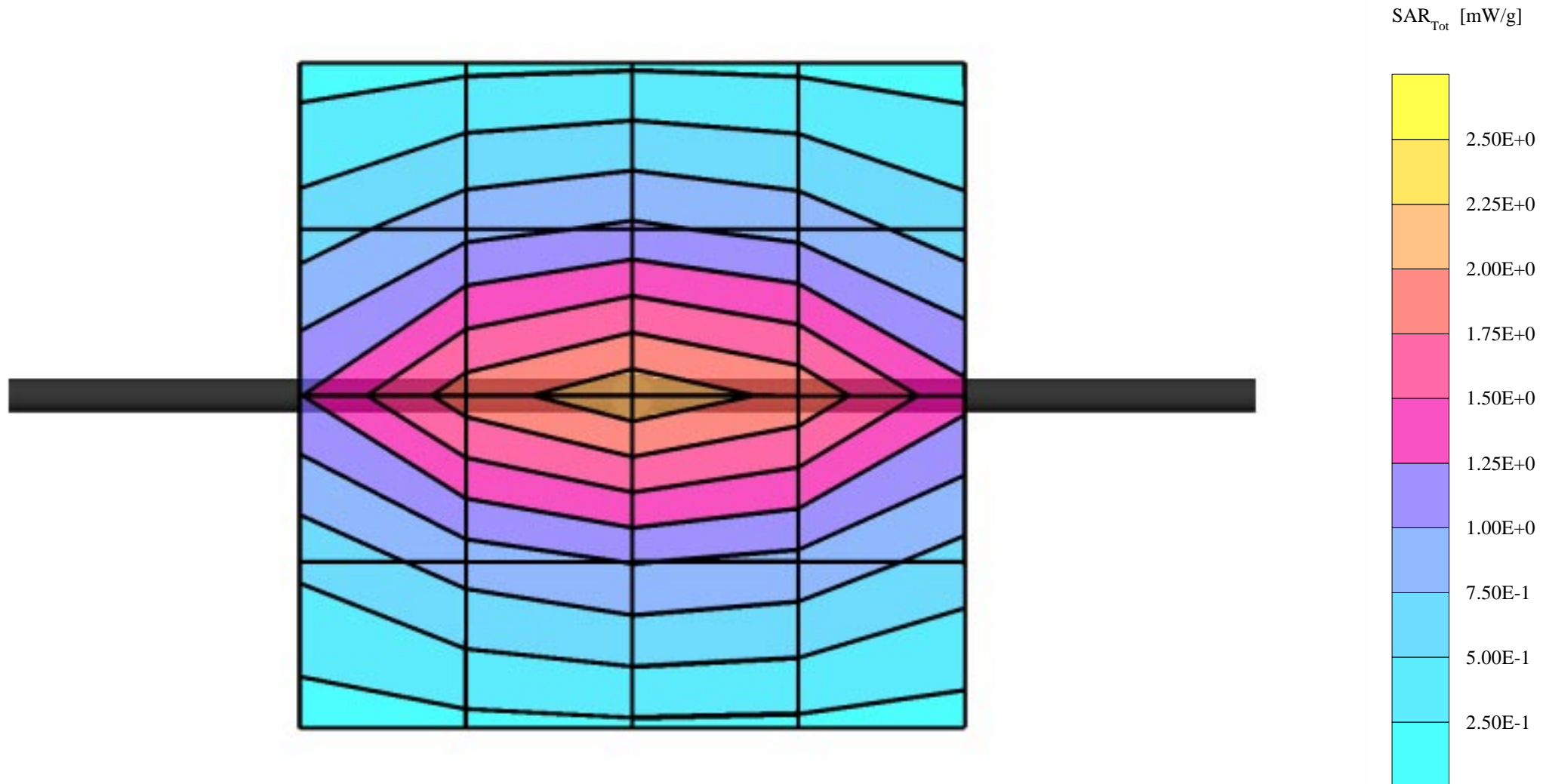

APPENDIX D – PROBE CALIBRATION DATA

Probe ET3DV5

SN:1368

Manufactured:	December 1998
Calibrated:	February 1999

Calibrated for System DASY3

Introduction

The performance of all probes is measured before delivery. This includes an assessment of the characteristic parameters, receiving patterns as a function of frequency, frequency response and relative accuracy. Furthermore, each probe is tested in use according to a dosimetric assessment protocol. The sensitivity parameters (NormX, NormY, NormZ), the diode compression parameter (DCP) and the conversion factor (ConvF) of the probe and some of the measurement diagrams are given in the following.

The performance of the individual probes varies slightly due to tolerances arising from the manufacturing process. Since the lines are highly resistive (several MOhms), the offset and noise problem is greatly increased if signals in the low μV range are measured. Accurate measurement below 10 $\mu\text{W/g}$ are possible if the following precautions are taken. 1) check the current grounding with the *multimeter*¹, i.e., low noise levels, 2) compensate the current *offset*¹, 3) use long integration time (approx. 10 seconds), 4) *calibrate*¹ before each measurement, 5) persons should avoid moving around the lab while measuring.

Since the field distortion caused by the supporting material and the sheath is quite high in the θ direction, the receiving pattern is poor in air. However, the distortion in tissue equivalent material is much less because of its high dielectricity. In addition, the fields induced in the phantoms by dipole structures close to the body are dominantly parallel to the surface. Thus, the error due to non-isotropy is much better than 1 dB for dosimetric assessments.

The probes are calibrated in the TEM cell if 110 although the field distribution in the cell is not very uniform and the frequency response is not very flat. To ensure consistency, a strict protocol is followed. The conversion factor (ConF) between this calibration and the measurement in the tissue simulation solution is performed by comparison with temperature measurements and computer simulations. This conversion factor is only valid for the specified tissue simulating liquids at the specified frequencies. If measurements have to be performed in solutions with other electrical properties or at other frequencies, the conversion factor has to be assessed by the same procedure.

As the probes have been constructed with printed resistive lines on ceramic substrates (thick film technique), the probe is very delicate with respect to mechanical shocks.

Attention:

Do not drop the probe or let the probe collide with any solid object. Never let the robot move without first activating the emergency stop feature (i.e., without first turning the data acquisition electronics on).

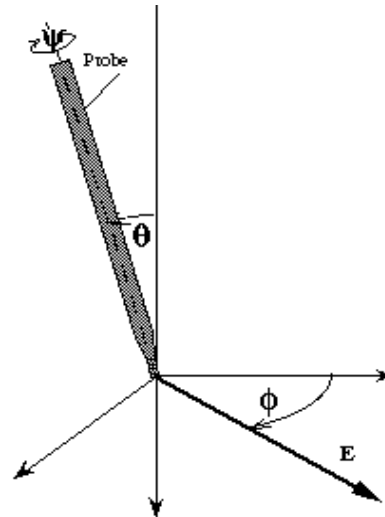

Fig 1: Due to the field distortion caused by the supporting material, the probe has two characteristic directions, referred to as angle ψ and θ .

¹ Feature of the DASY Software Tool.

¹ Feature of the DASY Software Tool.

ET3DV5 SN:1368

DASY3 - Parameters of Probe: ET3DV5 SN:1368

Sensitivity in Free Space

NormX	1.35	$\mu\text{V}/(\text{V}/\text{m})^2$
NormY	1.29	$\mu\text{V}/(\text{V}/\text{m})^2$
NormZ	1.46	$\mu\text{V}/(\text{V}/\text{m})^2$

Diode Compression

DCP X	78	mV
DCP Y	78	mV
DCP Z	78	mV

Sensitivity in Tissue Simulating Liquid

450 MHz	ConvF X	6.2	extrapolated	$\epsilon_r = 48 \pm 5\%$ $\sigma = 0.50 \pm 10\% \text{ mho/m}$ (brain tissue simulating liquid)
	ConvF Y	6.2	extrapolated	
	ConvF Z	6.2	extrapolated	
900 MHz	ConvF X	5.8	$\pm 10\%$	$\epsilon_r = 42.5 \pm 5\%$ $\sigma = 0.86 \pm 10\% \text{ mho/m}$ (brain tissue simulating liquid)
	ConvF Y	5.8	$\pm 10\%$	
	ConvF Z	5.8	$\pm 10\%$	
1500 MHz	ConvF X	5.2	interpolated	$\epsilon_r = 41 \pm 5\%$ $\sigma = 1.32 \pm 10\% \text{ mho/m}$ (brain tissue simulating liquid)
	ConvF Y	5.2	interpolated	
	ConvF Z	5.2	interpolated	
1800 MHz	ConvF X	4.9	$\pm 10\%$	$\epsilon_r = 41 \pm 5\%$ $\sigma = 1.69 \pm 10\% \text{ mho/m}$ (brain tissue simulating liquid)
	ConvF Y	4.9	$\pm 10\%$	
	ConvF Z	4.9	$\pm 10\%$	

Sensor Offset

Probe Tip to Sensor Center	2.7	mm
Surface to Probe Tip	1.7 ± 0.2	mm

Receiving Pattern (ϕ), $\theta = 0^\circ$

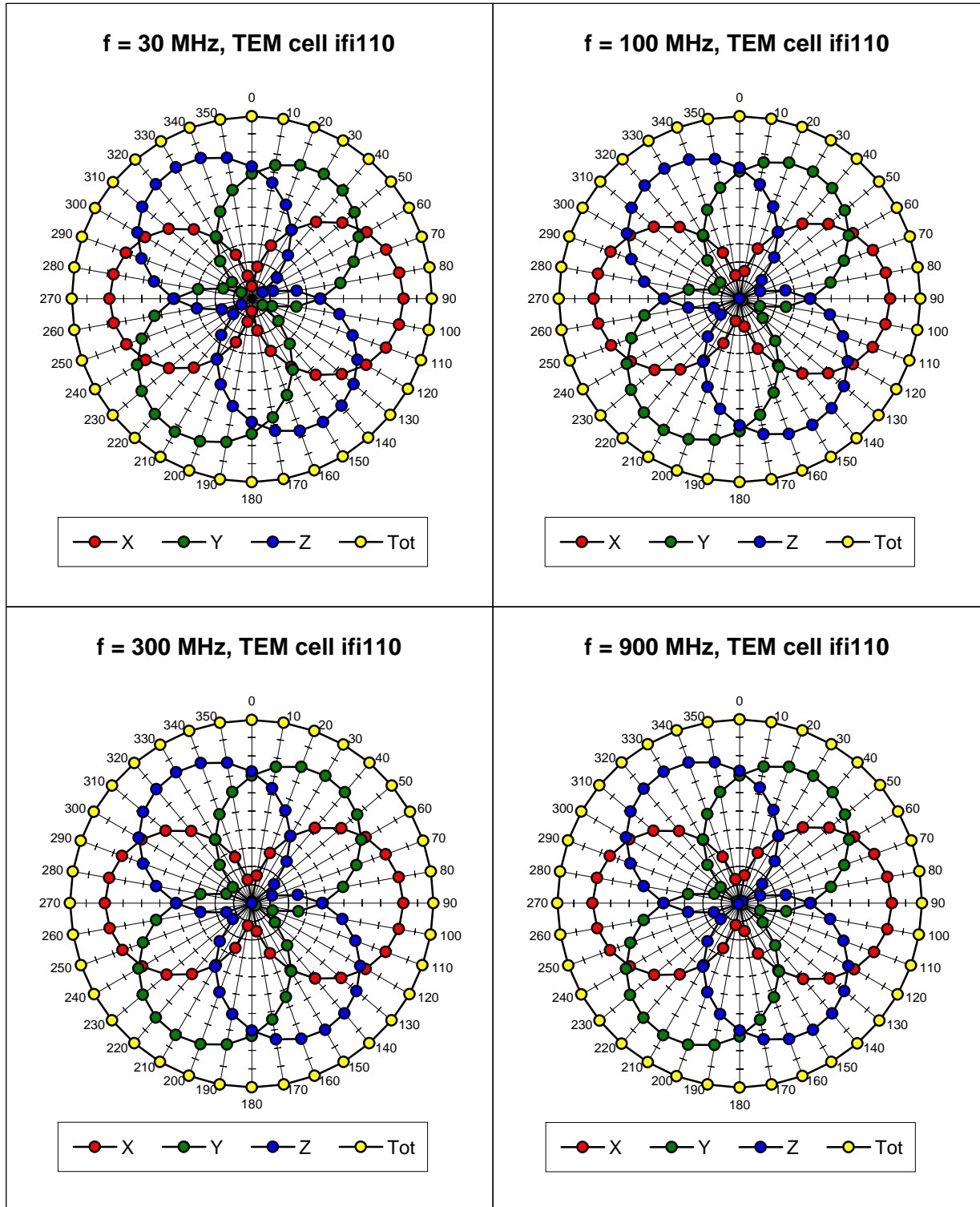

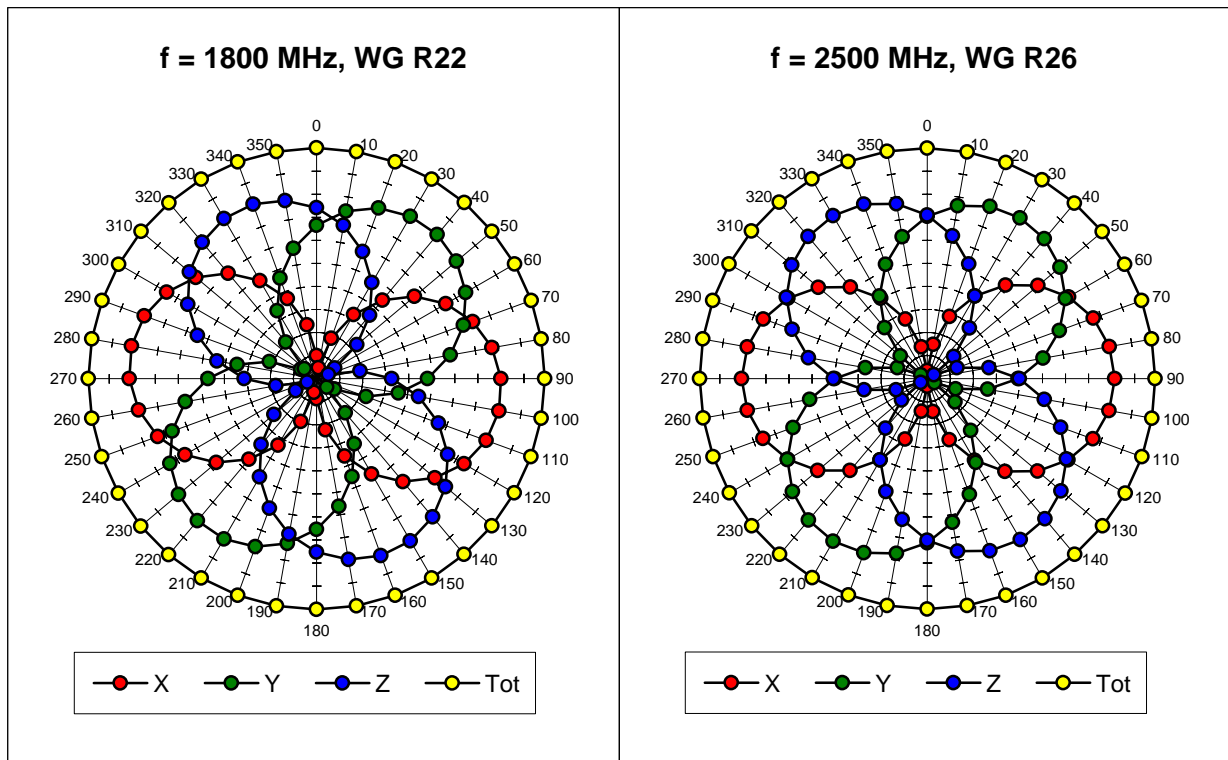

Isotropy Error (ϕ), $\theta = 0^\circ$

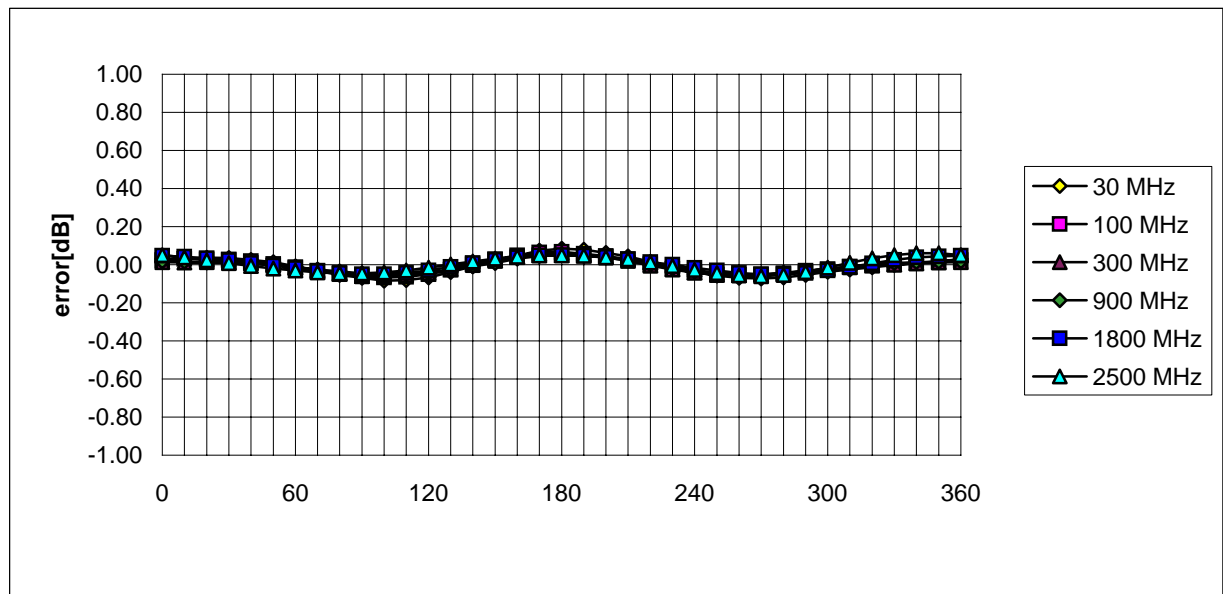

Frequency Response of E-Field

(TEM-Cell:ifi110, Waveguide R22, R26)

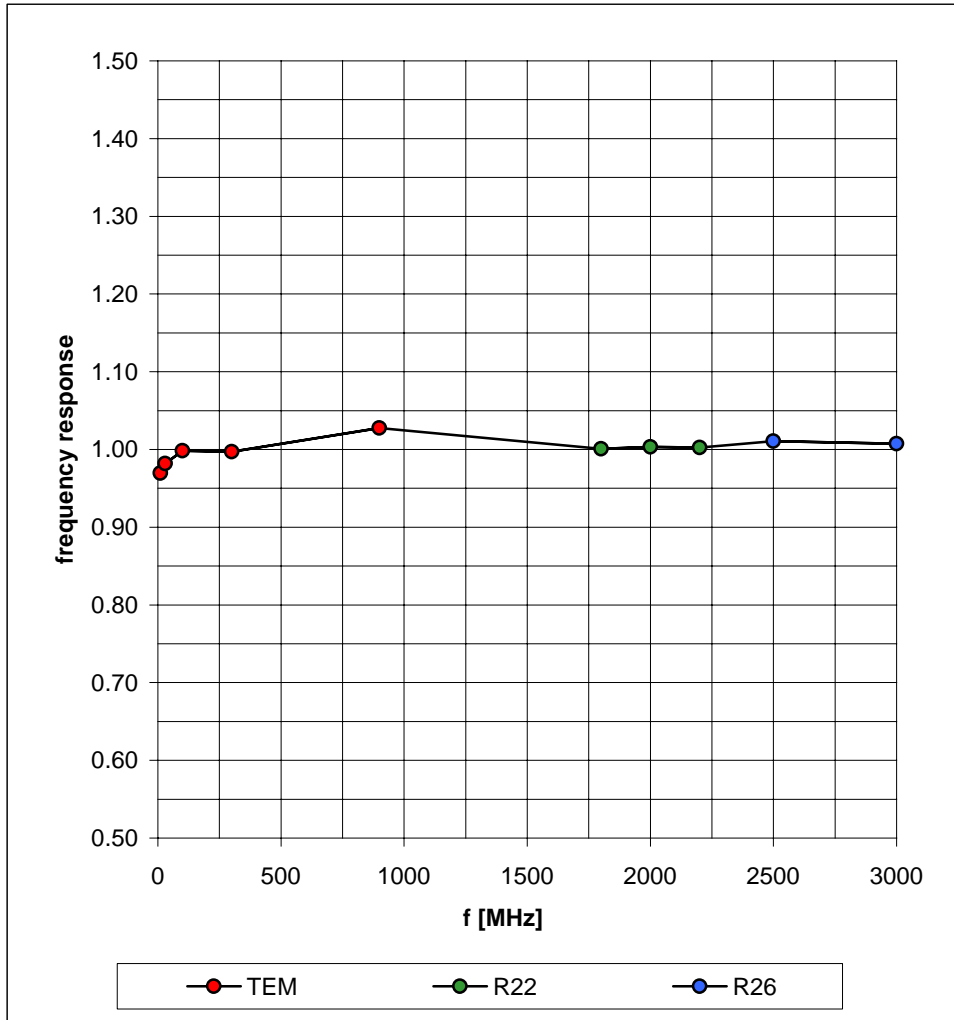

Dynamic Range f(SAR_{brain}) (TEM-Cell:ifi1110)

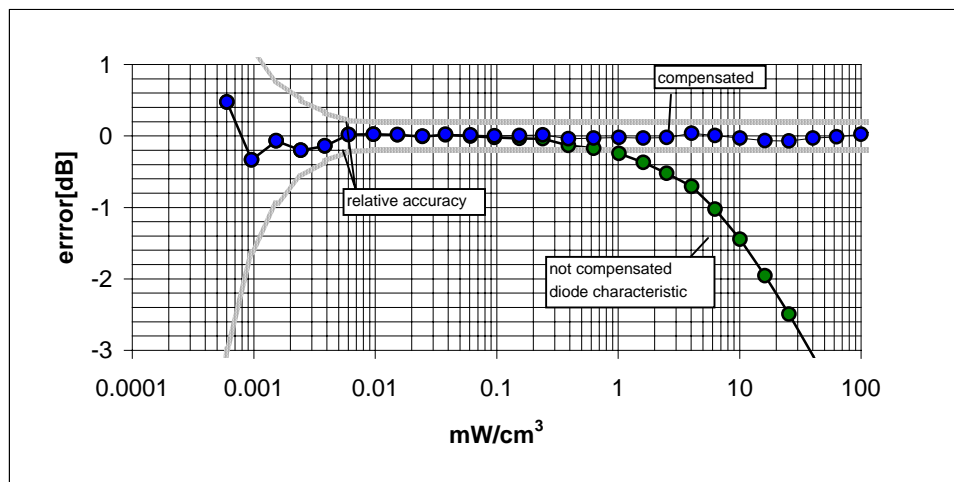
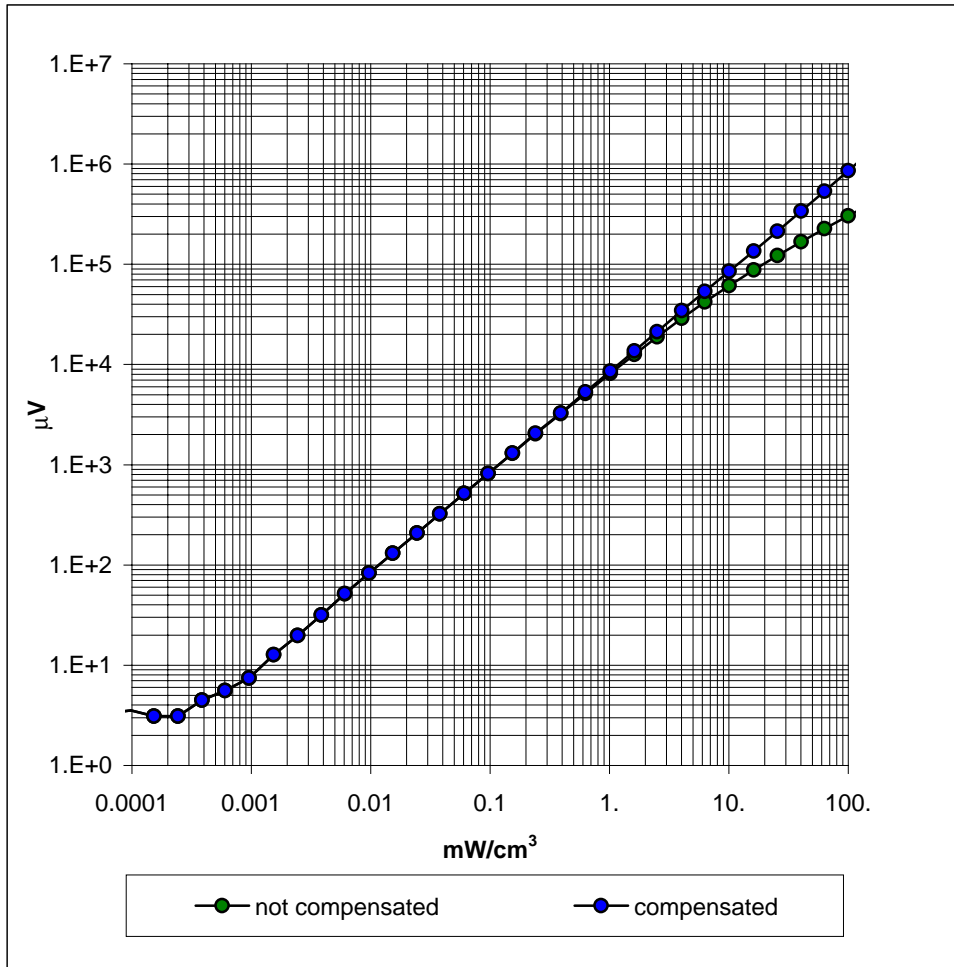

Conversion Factor Assessment

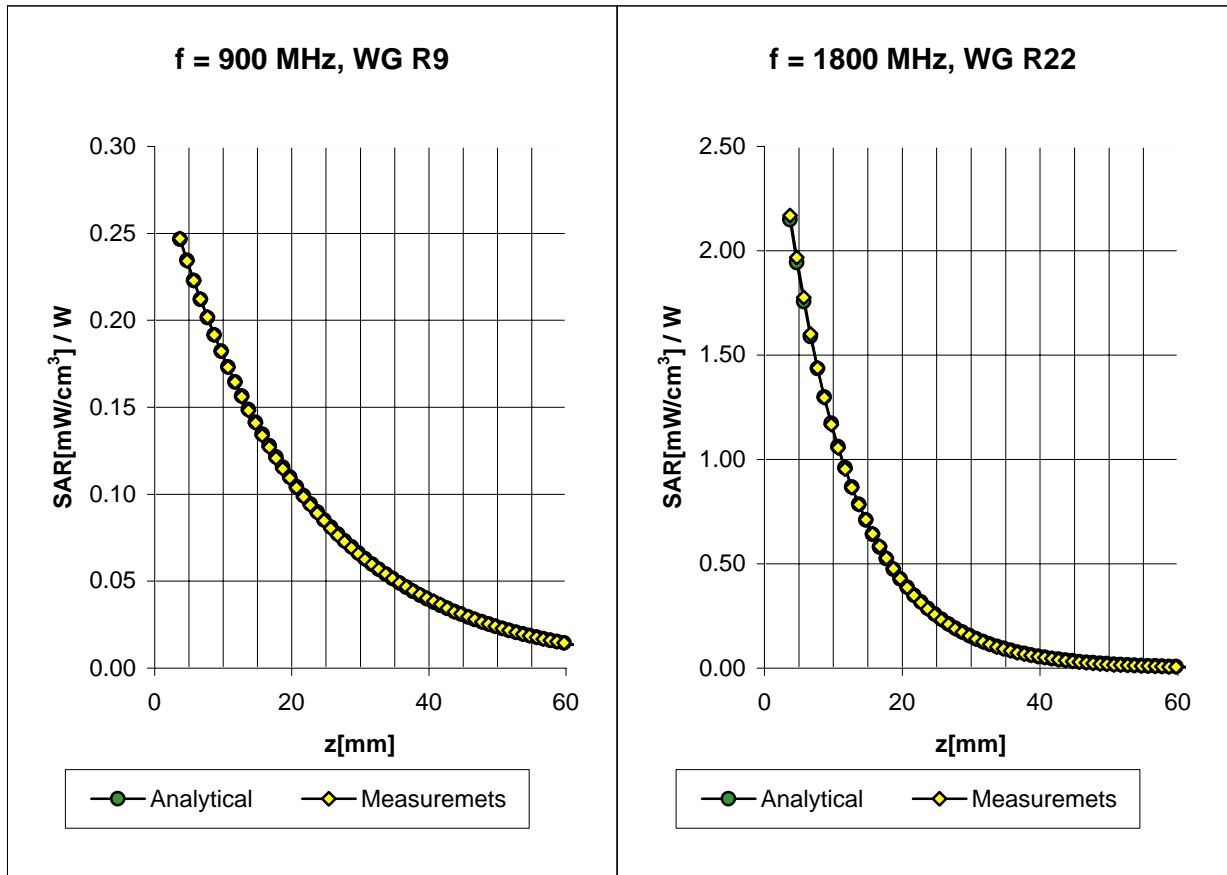

Receiving Pattern (ϕ) (in brain tissue, z = 5 mm)

