

**47 CFR PART 22/24/27 TEST REPORT**

**for**

**Telecare Alarm System**

**Model No.: CTC-1052xxx-xxxxx Series**

**(x=0~9, A~Z or blank)**

**FCC ID: GX9CTC1052QT**

**of**

**Applicant: CLIMAX TECHNOLOGY CO., LTD.**

**Address: No. 258, Sinhu 2nd Rd., Neihu District, Taipei City 114,  
Taiwan (R.O.C.)**

**Tested and Prepared**

**by**

**Worldwide Testing Services (Taiwan) Co., Ltd.**

**FCC Registration No.: TW1477, TW0020, TW1072**

**Industry Canada filed test laboratory Reg. No.: 20037**

**A2LA Accredited No.: 2732.01**



**Report No.: W6M22006-20020-P-247**

6F, NO. 58, LANE 188, RUEY-KUANG RD., NEIHU TAIPEI 114, TAIWAN, R.O.C.  
TEL: 886-2-66068877 FAX: 886-2-66068879 E-mail: [wts@wts-lab.com](mailto:wts@wts-lab.com)



# Worldwide Testing Services(Taiwan) Co., Ltd.

Report Number: W6M22006-20020-P-247

FCC ID: GX9CTC1052QT

## Certification of Test Report

Applicant : CLIMAX TECHNOLOGY CO., LTD.  
No. 258, Sinhu 2nd Rd., Neihu District, Taipei City 114  
Taiwan (R.O.C.)

Manufacturer : CLIMAX TECHNOLOGY CO., LTD.  
No. 258, Sinhu 2nd Rd., Neihu District, Taipei City 114  
Taiwan (R.O.C.)

Tested Equipment :

Type Description	: Telecare Alarm System
Model Number	: CTC-1052xxx-xxxxx Series (x=0~9, A~Z or blank)
Brand Name	: ./.
Operation Frequency	: Please see chapter 2.3.
RF Output Power:	: WCDMA Band II: 25.78 dBm (EIRP)
	Band IV: 25.41 dBm (EIRP)
	Band V: 23.51 dBm (ERP)
	LTE Band II: 26.56 dBm (EIRP)
	Band IV 25.82 dBm (EIRP)
	Band V: 23.68 dBm (ERP)
	Band XII: 25.04 dBm (ERP)
	Band XIII: 24.51 dBm (ERP)
Power Supply	: Adapter (I/P: 100-240Vac~50/60Hz, 0.4A
	O/P: 12V, 1A)
	Battery NI-MH 600mAh*6 AAA

Regulation Applied : 47CFR Part 22 (2019-10), Part 24 (2019-10),  
Part 27 (2019-10)

Test Method : 47CFR Part 2 (2019), TIA/EIA-603E (2016) and  
ANSI C63.26 (2015)

I HEREBY CERTIFY THAT: The test results written in this report were derived conscientiously in accordance with the requirements and procedures of 47CFR Part 2(2019), TIA/EIA-603E(2016), and it was found that the device described above is in compliance with the applicable limits specified in 47CFR Part 22/24/27.

Note:

1. The result of this test report is valid only in connection to the sample has been tested at the laboratory of Worldwide Testing Services (Taiwan) Co. Ltd.
2. This test report shall always be duplicated in full pages unless the written approval of the testing laboratory is obtained.

Test Engineer:

August 24, 2020	Kent Lin	
Date	WTS-Lab.	Signature

Technical responsibility for area of testing:

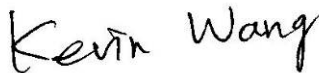
August 24, 2020	Kevin Wang	
Date	WTS	Signature



**TABLE OF CONTENTS**

**1. SUMMARY .....3**

1.1 DESCRIPTION OF TESTED EQUIPMENT .....3

1.2 DATE OF TESTING PROCESSING .....3

1.3 MODIFICATION INFORMATION .....3

1.4 TEST STANDARDS .....3

1.5 SUMMARY OF TEST RESULT .....4

**2. GENERAL INFORMATION .....6**

2.1 TESTING LABORATORY .....6

    2.1.1 Location .....6

    2.1.2 Details of accreditation status .....6

    2.1.3 Test location, where different from Worldwide Testing Services (Taiwan) Co., Ltd. ....6

2.2 DETAILS OF APPROVAL HOLDER.....6

2.3 DESCRIPTION OF TESTED SYSTEM.....6

2.4 TEST ENVIRONMENT .....9

2.5 GENERAL TEST REQUIREMENT .....9

2.6 TEST EQUIPMENT LIST .....10

**3. RF POWER OUTPUT .....13**

3.1 TEST PROCEDURE.....13

    3.1.1 Conducted Method.....13

3.2 TEST RESULTS .....14

**4. MODULATION CHARACTERISTICS .....22**

4.1 TEST PROCEDURE.....22

4.2 TEST RESULTS .....22

**5. PEAK-TO-AVERAGE RATIO .....23**

5.1 TEST PROCEDURE.....23

5.2 TEST SET UP.....23

5.3 TEST RESULTS .....24

**6. OCCUPIED BANDWIDTH.....46**

6.1 TEST PROCEDURE.....46

6.2 TEST RESULTS .....47

**7. SPURIOUS EMISSIONS AT ANTENNA TERMINALS .....78**

7.1 TEST PROCEDURE.....78

7.2 TEST RESULTS .....78

7.3 EXPLANATION OF TEST RESULT.....214

7.4 CALCULATION OF LIMIT FOR SPURIOUS AT ANTENNA TERMINALS.....214

**8. FIELD STRENGTH OF SPURIOUS RADIATION .....215**

8.1 TEST PROCEDURE.....215

8.2 TEST RESULTS .....215

8.3 EXPLANATION OF TEST RESULT.....215

8.4 CALCULATION OF LIMIT FOR FIELD STRENGTH OF SPURIOUS .....215



# **Worldwide Testing Services(Taiwan) Co., Ltd.**

Report Number: W6M22006-20020-P-247

FCC ID: GX9CTC1052QT

8.5	TEST RESULT OF BAND EDGE EMISSIONS .....	216
<b>9.</b>	<b>FREQUENCY STABILITY .....</b>	<b>354</b>
9.1	TEST PROCEDURE .....	354
9.2	TEST RESULTS .....	355
9.2.1	FREQUENCY STABILITY VS. TEMPERATURE .....	355
<b>10</b>	<b>MAXIMUM PERMISSIBLE EXPOSURE .....</b>	<b>358</b>
10.1	RF EXPOSURE COMPLIANCE REQUIREMENTS .....	358
<b>APPENDIX</b>	<b>.....</b>	<b>360</b>



Report Number: W6M22006-20020-P-247

FCC ID: GX9CTC1052QT

## **1. Summary**

### **1.1 Description of tested equipment**

This equipment under tested, CTC-1052xxx-xxxxx Series (x=0~9, A~Z or blank), is a Telecare Alarm System.

This test report only contains test requirements specified in 47CFR Part 22, Part 24 and Part27 for WCDMA and LTE function. For other functions; please refer to separate test report with respect to the relevant test standard and specification.

### **1.2 Date of testing processing**

Date of receipt of test item: June 29, 2020

Date of test: from June 30, 2020 to August 21, 2020

Other Information: None

### **1.3 Modification Information**

No modification was made during the all test items been performed.

### **1.4 Test standards**

Technical standard: **47 CFR Part 2 (2019), TIA/EIA-603E (2016),  
ANSI C63.26 (2015)  
47CFR Part 22 (2019), Part 24 (2019) and Part 27 (2019)**

Deviation from test standard: None

### **Special Statement**

1. This test report is valid in connection to the model has been tested, any modification to the product which is different from the test model will avoid the certification of the test report.
2. This test report shall always be duplicated in full pages unless the written approval of the testing laboratory is obtained.
3. The x in model number is representing different case shape, case colors, led mask color, and control ID.
4. The model number of CTC-1052-QT. This model does not contain logo.

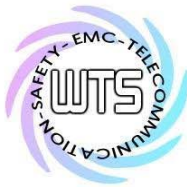

Report Number: W6M22006-20020-P-247

FCC ID: GX9CTC1052QT

**1.5 Summary of test result**

WCDMA

Section in this Report	Test Item	FCC relevant Section	Verdict
3.2	RF Power Output (Effective radiated power)	2.1046(a), 22.913(a)	Pass
4.2	Modulation characteristics	2.1047	Not Required
5.2	Occupied bandwidth	2.1049(h)	Pass
6.2	Spurious emissions at antenna terminals	22.917(a), 2.1051	Pass
7.2	Field strength of spurious radiation	22.917(a), 2.1053	Pass
7.5	Band Edge emissions	22.917(a)	Pass
8.2	Frequency stability	2.1055 22.355	Pass

Section in this Report	Test Item	FCC Relevant Section	Verdict
3.2	RF Power Output (Equivalent isotropically radiated power)	2.1046(a), 24.232	Pass
4.2	Modulation characteristics	2.1047	Not Required
5.2	Occupied bandwidth	2.1049(h) 24.238(b)	Pass
6.2	Spurious emissions at antenna terminals	24.238(a), 2.1051	Pass
7.2	Field strength of spurious radiation	24.238(a), 2.1053	Pass
7.5	Band Edge emissions	24.238(b)	Pass
8.2	Frequency stability	2.1055 24.235	Pass

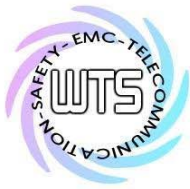

# Worldwide Testing Services(Taiwan) Co., Ltd.

Report Number: W6M22006-20020-P-247

FCC ID: GX9CTC1052QT

LTE

Harmonized Standard Requirements and Conformance Test Specifications				
Item	Clause	Test Content	Limit	Test Result
3.2	§22.913 §24.232 §27.50	Effective Radiated Power and Equivalent Isotropic Radiated Power Measurement	ERP < 7 Watts (Band 5) EIRP < 2 Watts (Band 2) ERP < 3 Watts (Band 12, Band 13) EIRP < 1 Watts (Band 4)	Pass
5.3	§24.232 §27.50	Peak-to-Average Ratio	< 13 dB	Pass
6.2	§2.1049	Occupied Bandwidth	OBW : No Limit	Pass
7.2	§22.917 §24.238 §27.53	Conducted Spurious Emission Measurement	< 43+10log10(P[Watts])	Pass
8.2	§22.917 §24.238 §27.53	Radiated Spurious Emission Measurement	< 43+10log10(P[Watts])	Pass
8.5	§22.917 §24.238 §27.53	Conducted Band Edge Measurement	< 43+10log10(P[Watts])	Pass
9.2	§2.1055 §22.355 §24.235 §27.54	Frequency stability / Temperature variation Measurement	< 2.5 ppm	Pass

Test item Name	Measurement Uncertainty
Estimation Result of Uncertainty of Radiated Emission(3M)	Expanded Uncertainty: 0.009-30 MHz:1.88 dB 30-1000 MHz:2.79 dB 1-18 GHz:2.36 dB 18-40 GHz:1.55 dB
Estimation Result of Uncertainty of Conducted Output Power Measurement	Expanded Uncertainty : 1.14 dB
Estimation Result of Uncertainty of Bandwidth Measurement	Expanded Uncertainty : 0.45 kHz
Estimation Result of Uncertainty of Frequency Drift Measurement	Expanded Uncertainty : 6.11 Hz
Estimation Result of Uncertainty of Band Edge Measurement	Expanded Uncertainty : 1.01 dBc

Measurement uncertainty is not included in the calculation of test results.



Report Number: W6M22006-20020-P-247

FCC ID: GX9CTC1052QT

**2. General Information**

**2.1 Testing laboratory**

**2.1.1 Location**

OATS  
No.5-1, Shuang Sing Village,  
LiShuei Rd., Wanli Township,  
Taipei County 207, Taiwan (R.O.C.)  
Company  
Worldwide Testing Services (Taiwan) Co., Ltd.  
6F, NO. 58, LANE 188, RUEY-KUANG RD.  
NEIHU, TAIPEI 114, TAIWAN R.O.C.  
Tel : 886-2-66068877  
Fax : 886-2-66068879

**2.1.2 Details of accreditation status**

Accredited testing laboratory  
A2LA-registration number: 2732.01  
FCC filed test laboratory Reg. No. TW1477, TW0020, TW1072  
Industry Canada filed test laboratory Reg. No. 20037

**2.1.3 Test location, where different from Worldwide Testing Services (Taiwan) Co., Ltd.**

Name: ./.  
Accredited number: ./.  
Street: ./.  
Town: ./.  
Country: ./.  
Telephone: ./.  
Fax: ./.

**2.2 Details of approval holder**

Name: CLIMAX TECHNOLOGY CO., LTD  
Street: No. 258, Sinhu 2nd Rd., Neihu District,  
Town: Taipei City 114  
Country: Taiwan (R.O.C.)  
Telephone: +886-2-2794-0001  
Fax: +886-2-2792-6618

**Manufacturer:** (if different from applicant)

Name: ./.  
Street: ./.  
Town: ./.  
Country: ./.

**2.3 Description of Tested System**

The EUT was tested alone without the Accessories or Peripherals.

Equipment	Model No.	Series No.	Software	Cable information	Note
No accessories were used with this EUT.					





# Worldwide Testing Services(Taiwan) Co., Ltd.

Report Number: W6M22006-20020-P-247

FCC ID: GX9CTC1052QT

Frequencies Selected to be investigated:

### WCDMA Band II

Low Frequency ( ch 9262): 1852.4 MHz

Mid Frequency ( ch 9400): 1880.0 MHz

High Frequency ( ch 9538): 1907.6 MHz

### WCDMA Band IV

Low Frequency ( ch 1312): 1712.4 MHz

Mid Frequency ( ch 1412): 1732.4 MHz

High Frequency ( ch 1513): 1752.6 MHz

### WCDMA Band V

Low Frequency ( ch 4132): 826.4 MHz

Mid Frequency ( ch 4183): 836.6 MHz

High Frequency ( ch 4233): 846.6 MHz

## LTE

### Band II

Test Frequency ID	Bandwidth [MHz]	N <sub>UL</sub>	Frequency of Uplink [MHz]	N <sub>DL</sub>	Frequency of Downlink [MHz]
Low Range	1.4	18607	1850.7	607	1930.7
	3	18615	1851.5	615	1931.5
	5	18625	1852.5	625	1932.5
	10	18650	1855	650	1935
	15 <sup>[1]</sup>	18675	1857.5	675	1937.5
	20 <sup>[1]</sup>	18700	1860	700	1940
Mid Range	1.4/3/5/10 15 <sup>[1]</sup> /20 <sup>[1]</sup>	18900	1880	900	1960
High Range	1.4	19193	1909.3	1193	1989.3
	3	19185	1908.5	1185	1988.5
	5	19175	1907.5	1175	1987.5
	10	19150	1905	1150	1985
	15 <sup>[1]</sup>	19125	1902.5	1125	1982.5
	20 <sup>[1]</sup>	19100	1900	1100	1980
NOTE 1: Bandwidth for which a relaxation of the specified UE receiver sensitivity requirement (TS 36.101 [27] Clause 7.3) is allowed.					

### Band IV

Test Frequency ID	Bandwidth [MHz]	N <sub>UL</sub>	Frequency of Uplink [MHz]	N <sub>DL</sub>	Frequency of Downlink [MHz]
Low Range	1.4	19957	1710.7	1957	2110.7
	3	19965	1711.5	1965	2111.5
	5	19975	1712.5	1975	2112.5
	10	20000	1715	2000	2115
	15	20025	1717.5	2025	2117.5
	20	20050	1720	2050	2120
Mid Range	1.4/3/5/10/15/20	20175	1732.5	2175	2132.5
High Range	1.4	20393	1754.3	2393	2154.3
	3	20385	1753.5	2385	2153.5
	5	20375	1752.5	2375	2152.5
	10	20350	1750	2350	2150
	15	20325	1747.5	2325	2147.5
	20	20300	1745	2300	2145



# Worldwide Testing Services(Taiwan) Co., Ltd.

Report Number: W6M22006-20020-P-247

FCC ID: GX9CTC1052QT

## Band V

Test Frequency ID	Bandwidth [MHz]	N <sub>UL</sub>	Frequency of Uplink [MHz]	N <sub>DL</sub>	Frequency of Downlink [MHz]
Low Range	1.4	20407	824.7	2407	869.7
	3	20415	825.5	2415	870.5
	5	20425	826.5	2425	871.5
	10 <sup>[1]</sup>	20450	829	2450	874
Mid Range	1.4/3/5 10 <sup>[1]</sup>	20525	836.5	2525	881.5
High Range	1.4	20643	848.3	2643	893.3
	3	20635	847.5	2635	892.5
	5	20625	846.5	2625	891.5
	10 <sup>[1]</sup>	20600	844	2600	889

NOTE 1: Bandwidth for which a relaxation of the specified UE receiver sensitivity requirement (TS 36.101 [27] Clause 7.3) is allowed.

## Band XII

Test Frequency ID	Bandwidth [MHz]	N <sub>UL</sub>	Frequency of Uplink [MHz]	N <sub>DL</sub>	Frequency of Downlink [MHz]
Low Range	1.4	23017	699.7	5017	729.7
	3	23025	700.5	5025	730.5
	5 <sup>[1]</sup>	23035	701.5	5035	731.5
	10 <sup>[1]</sup>	23060	704	5060	734
Mid Range	1.4/3 5 <sup>[1]</sup> /10 <sup>[1]</sup>	23095	707.5	5095	737.5
High Range	1.4	23173	715.3	5173	745.3
	3	23165	714.5	5165	744.5
	5 <sup>[1]</sup>	23155	713.5	5155	743.5
	10 <sup>[1]</sup>	23130	711	5130	741

NOTE 1: Bandwidth for which a relaxation of the specified UE receiver sensitivity requirement (TS 36.101 [27] Clause 7.3) is allowed.

## Band XIII

Test Frequency ID	Bandwidth [MHz]	N <sub>UL</sub>	Frequency of Uplink [MHz]	N <sub>DL</sub>	Frequency of Downlink [MHz]
Low Range	5 <sup>[1]</sup>	23205	779.5	5205	748.5
	10 <sup>[1]</sup>	23230	782	5230	751
Mid Range	5 <sup>[1]</sup> /10 <sup>[1]</sup>	23230	782	5230	751
High Range	5 <sup>[1]</sup>	23255	784.5	5255	753.5
	10 <sup>[1]</sup>	23230	782	5230	751

NOTE 1: Bandwidth for which a relaxation of the specified UE receiver sensitivity requirement (TS 36.101 [27] Clause 7.3) is allowed.

Antenna Type: PCB Antenna  
 Antenna Gain: WCDMA Band II: 3.21 dBi, Band IV: 2.67 dBi,  
 Band V: -0.13 dBi  
 LTE Band II: 3.21 dBi, Band IV: 2.67 dBi,  
 Band V: -0.13 dBi, Band XII: 1.58 dBi Band XIII: 0.85 dBi  
 Power supply: Adapter (I/P: 100-240Vac~50/60Hz, 0.4A  
 O/P: 12V, 1A)  
 Battery NI-MH 600mAh\*6 AAA



Report Number: W6M22006-20020-P-247

FCC ID: GX9CTC1052QT

## 2.4 Test environment

Temperature: 27 °C  
Relative humidity content: 54 %  
Air pressure: 86-103 Kpa

## 2.5 General Test Requirement

**Radiated Emission:** For investigated frequency is equal to or below 1GHz, the RBW and VBW of the spectrum analyzer was 100 kHz and 100 kHz respectively with an appropriate sweep speed.

For investigated frequency is above 1GHz, both of RBW and VBW of the spectrum analyzer were 1 MHz with an appropriate sweep speed. The analyzer was calibrated in dB above a microvolt at the output of the antenna.

The table used for radiated measurements is capable of continuous rotation. The spectrum was scanned from 30 MHz to the frequency specified as follows:

- (1) If the intentional radiator operates below 10 GHz: to the tenth harmonic of the highest fundamental frequency or to 40 GHz, whichever is lower.
- (2) If the intentional radiator operates at or above 10 GHz and below 30 GHz: to the fifth harmonic of the highest fundamental frequency or to 100 GHz, whichever is lower.
- (3) If the intentional radiator operates at or above 30 GHz: to the fifth harmonic of the highest fundamental frequency or to 200 GHz, whichever is lower, unless specified otherwise elsewhere in the rules.

For hand-held devices, a exploratory test was performed with three (3) orthogonal planes to determine the highest emissions.

When an emission was found, the table was rotated to produce the maximum signal strength. At this point, the antenna was raised and lowered from 1m to 4m. The antenna was placed in both the horizontal and vertical planes.

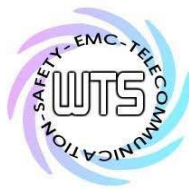

# Worldwide Testing Services(Taiwan) Co., Ltd.

Report Number: W6M22006-20020-P-247

FCC ID: GX9CTC1052QT

## 2.6 Test Equipment List

No.	Test equipment	Type	Serial No.	Manufacturer	Cal. Date	Next Cal. Date
ETSTW-CE 001	EMI TEST RECEIVER	ESHS10	842121/013	R&S	2020/6/11	2021/6/10
ETSTW-CE 003	AC POWER SOURCE	APS-9102	D161137	GW	Function Test	
ETSTW-CE 004	ZWEILEITER-V-NETZACHBILDUNG TWO-LINE V-NETWORK	ESH3-Z5	840731/011	R&S	2019/11/1	2020/10/31
ETSTW-CE 006	IMPULSBEGRENZER PULSE LIMITER	ESH3-Z2	100226	R&S	2019/9/24	2020/9/23
ETSTW-CE 008	HF-EICHLLEITUNG RF STEP ATTENUATOR 139dB DPSP	334.6010.02	844581/024	R&S	Function Test	
ETSTW-CE 009	TEMP.&HUMIDITY CHAMBER	GTH-225-40-1P-U	MAA0305-009	GIANT FORCE	2020/7/22	2021/7/21
ETSTW-CE 016	TWO-LINE V-NETWORK	ENV216	100050	R&S	2019/10/3	2020/10/2
ETSTW-CE 028	MXE EMI Receiver	N9038A	MY53220110	Agilent	2020/7/29	2021/7/28
ETSTW-RE 003	EMI TEST RECEIVER	ESI 26	831438/001	R&S	2020/6/12	2021/6/11
ETSTW-RE 004	EMI TEST RECEIVER	ESI 40	832427/004	R&S	2020/7/16	2021/7/15
ETSTW-RE 012	TUNABLE BANDREJECT FILTER	D.C 0309	146	K&L	Function Test	
ETSTW-RE 013	TUNABLE BANDREJECT FILTER	D.C 0336	397	K&L	Function Test	
ETSTW-RE 018	MICROWAVE HORN ANTENNA	AT4560	27212	AR	2020/7/30	2021/7/29
ETSTW-RE 027	Passive Loop Antenna	6512	00034563	ETS-Lindgren	2020/7/8	2021/7/7
ETSTW-RE 030	Double-Ridged Guide Horn Antenna	3117	00035224	ETS-Lindgren	2020/4/22	2021/4/21
ETSTW-RE 042	Biconical Antenna	HK116	100172	R&S	2020/2/18	2021/2/17
ETSTW-RE 043	Log-Periodic Dipole Antenna	HL223	100166	R&S	2020/5/8	2021/5/7
ETSTW-RE 044	Log-Periodic Antenna	HL050	100094	R&S	2020/8/3	2021/8/2
ETSTW-RE 045	ESA-E SERIES SPECTRUM ANALYZER	E4404B	MY45111242	Agilent	Pre-test Use	
ETSTW-RE 050	Attenuator 10dB	50HF-010-1	None	JFW	2020/2/20	2021/2/19
ETSTW-RE 051	Attenuator 6dB	50HF-006-1	None	JFW	2020/2/20	2021/2/19
ETSTW-RE 053	Attenuator 3dB	50HF-003-1	None	JFW	2020/2/20	2021/2/19
ETSTW-RE 055	SPECTRUM ANALYZER	FSU 26	200074	R&S	2020/3/6	2021/3/5
ETSTW-RE 060	Attenuator 30dB	5015-30	F651012z-01	ATM	2020/2/20	2021/2/19
ETSTW-RE 062	Amplifier Module	CHC 2	None	KMIC	2020/5/8	2021/5/7
ETSTW-RE 064	Bluetooth Test Set	MT8852B-042	6K00005709	Anritsu	Function Test	
ETSTW-RE 069	Double-Ridged Guide Horn Antenna	3117	00069377	ETS-Lindgren	Function Test	
ETSTW-RE 072	CELL SITE TEST SET	8921A	3339A00375	HP	2019/9/23	2020/9/22
ETSTW-RE 088	SOLID STATE AMPLIFIER	KMA180265A01	99057	KMIC	2019/9/18	2020/9/17
ETSTW-RE 091	Match Pad	MDCS1500	None	WOKEN	2020/5/22	2021/5/21
ETSTW-RE 099	DC Block	50DB-007-1	None	JFW	2020/2/20	2021/2/19
ETSTW-RE 112	AC POWER SOURCE	TFC-1005	T-0A023536	T-Power	Function test	
ETSTW-RE 115	2.4GHz Notch Filter	N0124411	473874	MICROWAVE CIRCUITS	2020/1/13	2021/1/12
ETSTW-RE 120	RF Player	MP9200	MP9210-111022	ADIVIC	Function test	

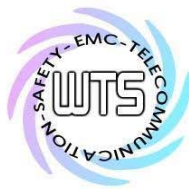

# Worldwide Testing Services(Taiwan) Co., Ltd.

Report Number: W6M22006-20020-P-247

FCC ID: GX9CTC1052QT

ETSTW-RE 122	SIGNAL GENERATOR	SMF100A	102149	R&S	2020/6/11	2021/6/10
ETSTW-RE 125	5GHz Notch filter	5NSL11-5200/E221.3-O/O	1	K&L Microwave	2020/8/7	2021/8/6
ETSTW-RE 126	5GHz Notch filter	5NSL12-5800/E221.3-O/O	1	K&L Microwave	2020/8/7	2021/8/6
ETSTW-RE 127	RF Switch Box	RFS-01	None	WTS	2020/2/20	2021/2/19
ETSTW-RE 128	5.3GHz Notch filter	N0153001	SN487233	Microwave Circuits	2020/8/7	2021/8/6
ETSTW-RE 129	5.5GHz Notch filter	N0555984	SN487234	Microwave Circuits	2020/8/7	2021/8/6
ETSTW-RE 130	Handheld RF Spectrum Analyzer	N9340A	CN0147000204	Agilent	Pre-test Use	
ETSTW-RE 142	Amplifier	8447D	2805A03378	Agilent	2020/5/8	2021/5/7
ETSTW-RE 146	Preamplifier	JPA-10M1G	15090004	JPT	2020/6/5	2021/6/4
ETSTW-RE 147	Bi-log Hybrid Antenna	MCTD 2786B	BLB16M04005	ETC	2020/4/9	2021/4/8
ETSTW-RE 148	Bi-log Hybrid Antenna	MCTD 2786B	BLB16M04006	ETC	2020/7/9	2021/7/8
ETSTW-RF 002	Electromagnetic field probe	LF-30	K-0007	STT	2020/6/9	2021/6/8
ETSTW-EMI 011	USB Compact Modulator	SFC-U	101689	R&S	2020/5/21	2021/5/20
ETSTW-GSM 002	Universal Radio Communication Tester	CMU 200	109439	R&S	2020/3/9	2021/3/8
ETSTW-GSM 003	Radio Communication Analyzer	MT8820C	6201342073	Anritsu	2020/4/20	2021/4/19
ETSTW-GSM 004	Wideband Radio Communication Tester	CMW500	128092	R&S	2019/10/25	2020/10/24
ETSTW-GSM 019	Band Reject Filter	WRCTF824/849-822/851-40 /12+9SS	3	WI	2020/1/13	2021/1/12
ETSTW-GSM 020	Band Reject Filter	WRCD1747/1748-1743/1752-32/5SS	1	WI	2020/1/13	2021/1/12
ETSTW-GSM 021	Band Reject Filter	WRCD1879.5/1880.5-1875.5/1884.5-32/5SS	3	WI	2020/1/13	2021/1/12
ETSTW-GSM 022	Band Reject Filter	WRCT901.9/903.1-904.25-50/8SS	1	WI	2020/1/13	2021/1/12
ETSTW-GSM 023	Power Divider	4901.19.A	None	SUHNER	2019/9/12	2020/9/11
ETSTW-GSM 024	Radio Communication Analyzer	MT8821C	None	Anritsu	2020/3/27	2021/3/26
ETSTW-GSM 025	Band Reject Filter	BRM19835	001	Micro-Tronics	2020/8/7	2021/8/6
ETSTW-Cable 011	SMA to N type Cable	RGU-400	None	THERMAX	Pre-test Use NCR	
ETSTW-Cable 016	BNC Cable	Switch Box	B Cable 1	Schwarz beck	2020/2/20	2021/2/19
ETSTW-Cable 017	BNC Cable	X Cable	B Cable 2	Schwarz beck	2020/2/20	2021/2/19
ETSTW-Cable 018	BNC Cable	Y Cable	B Cable 3	Schwarz beck	2020/2/20	2021/2/19
ETSTW-Cable 019	BNC Cable	Z Cable	B Cable 4	Schwarz beck	2020/2/20	2021/2/19
ETSTW-Cable 020	N TYPE Cable	OATS Cable 1	N30N30-L335-15M	JYE BAO CO.,LTD.	2020/7/1	2021/6/30
ETSTW-Cable 027	Microwave Cable	SUCOFLEX 104	279083	HUBER+SUHNER	2020/5/8	2021/5/7
ETSTW-Cable 028	Microwave Cable	FA147A0015M2020	30064-2	UTIFLEX	2019/9/18	2020/9/17
ETSTW-Cable 029	Microwave Cable	FA147A0015M2020	30064-3	UTIFLEX	2019/9/18	2020/9/17
ETSTW-Cable 030	Microwave Cable	SUCOFLEX 104 (S Cable 9)	279067	HUBER+SUHNER	2020/2/20	2021/2/19
ETSTW-Cable 043	Microwave Cable	SUCOFLEX 104	317576	HUBER+SUHNER	2020/5/8	2021/5/7
ETSTW-Cable 047	Microwave Cable	SUCOFLEX 104	325518	HUBER+SUHNER	2020/7/3	2021/7/2
ETSTW-Cable 058	Microwave Cable	SUCOFLEX 104	none	HUBER+SUHNER	2020/6/5	2021/6/4



# Worldwide Testing Services(Taiwan) Co., Ltd.

Report Number: W6M22006-20020-P-247

FCC ID: GX9CTC1052QT

ETSTW-Cable 064	Microwave Cable	SUCOFLEX 104	MY28891	HUBER+SUHNER	2020/5/8	2021/5/7
ETSTW-Cable 071	N TYPE CABLE	EMCCFD400-NM-NM-25000	170239	EMCI	2020/6/5	2021/6/4
ETSTW-Cable 072	SMA type cable (8m)	SUCOFLEX 104	805800/4	HUBER+SUHNER	2020/5/8	2021/5/7
ETSTW-Cable 074	SMA type cable (2m)	SUCOFLEX 104	802563/4	HUBER+SUHNER	2020/5/8	2021/5/7
WTSTW-SW 002	EMI TEST SOFTWARE	EZ EMC	None	Farad	Version ETS-03A1	
WTSTW-SW 006	EMI TEST SOFTWARE	e3	None	AUDIX	Version 9.161014	
WTSTW-SW 008	Signal studio	Agilent	None	AUDIX	Version 2.0.0.1	
ETSTW-TH 001	Thermohygrometer	608-H1	45204316	Testo	2019/9/9	2020/9/8
ETSTW-TH 002	Thermohygrometer	608-H1	45204317	Testo	2019/9/9	2020/9/8



Report Number: W6M22006-20020-P-247

FCC ID: GX9CTC1052QT

**3. RF Power Output**

**3.1 Test procedure**

**3.1.1 Conducted Method**

Per 47CFR Part 2.1046, the RF power output shall be measured at the RF output terminals and following procedure is employed:

The transmitter output was connected as the following figure:

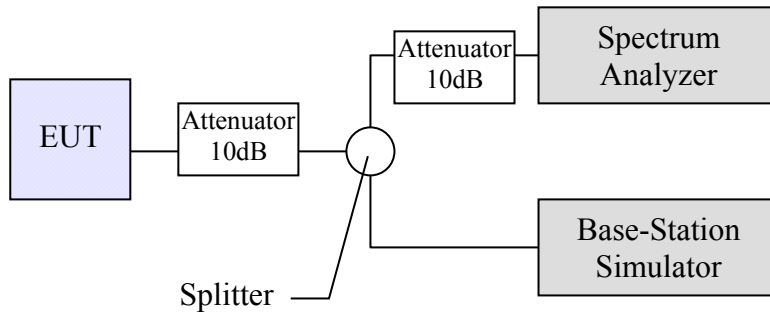

The whole connection system is calibrated with a standard signal generator. Power on and make a link form simulator to EUT and then set the EUT to maximum output power.

Measure the RF power with the spectrum analyzer in accordance the following settings:

RBW: 300 kHz for Frequency below 1GHz and 1MHz for Frequency equal to and above 1GHz.

VBW: 300 kHz for Frequency below 1GHz and 1MHz for Frequency equal to and above 1GHz.

Span: 2MHz

Sweep: 3s

The power output at the transmitter antenna terminal is then determined by assign the value of the corrected factor to the spectrum analyzer reading.

Tests were performed at three frequencies (low, middle and high channels) and operation mode selected.



# Worldwide Testing Services(Taiwan) Co., Ltd.

Report Number: W6M22006-20020-P-247

FCC ID: GX9CTC1052QT

## 3.2 Test Results

Test date: July 31, 2020

Temperature: 24.0 °C

Humidity: 53.5 %

Tester: Kent

### WCDMA

#### Band II & Band IV & Band V

WCDMA Band II	POWER(dBm) Low Ch9262/ 1852.4MHz	POWER(dBm) Mid Ch9400/ 1880MHz	POWER(dBm) High Ch9538/ 1907.6MHz	EIRP Low Ch9262/ 1852.4MHz	EIRP Mid Ch9400/ 1880MHz	EIRP High Ch9538/ 1907.6MHz
	22.31	22.32	22.57	25.52	25.53	25.78
WCDMA Band IV	POWER(dBm) Low Ch1312/ 1712.4MHz	POWER(dBm) Mid Ch1412 /1732.4MHz	POWER(dBm) High Ch1513/ 1752.6MHz	EIRP Low Ch1312/ 1712.4MHz	EIRP Mid Ch1412/ 1732.4MHz	EIRP High Ch1513/ 1752.6MHz
	22.74	22.46	22.63	25.41	25.13	25.3
WCDMA Band V	POWER(dBm) Low Ch4132/ 826.4MHz	POWER(dBm) Mid Ch4183/ 836.6MHz	POWER(dBm) High Ch4233/ 846.6MHz	ERP Low Ch4132/ 826.4MHz	ERP Mid Ch4183/ 836.6MHz	ERP High Ch4233/ 846.6MHz
	23.52	23.49	23.64	23.39	23.36	23.51



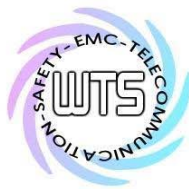

# Worldwide Testing Services(Taiwan) Co., Ltd.

Report Number: W6M22006-20020-P-247

FCC ID: GX9CTC1052QT

LTE

Band II

BW(MHz)	Modulation	RB Size	RB offset	POWER(dBm) Low Ch18607/ 1850.7MHz	POWER(dBm) Mid Ch18900/ 1880MHz	POWER(dBm) High Ch19193/ 1909.3MHz	EIRP Low Ch18607/ 1850.7MHz	EIRP Mid Ch18900/ 1880MHz	EIRP High Ch19193/ 1909.3MHz
1.4	QPSK	1	0	22.58	22.83	22.78	25.79	26.04	25.99
1.4	QPSK	1	3	22.88	22.95	23.13	26.09	26.16	26.34
1.4	QPSK	1	5	22.78	22.70	22.98	25.99	25.91	26.19
1.4	QPSK	3	0	22.85	22.92	23.06	26.06	26.13	26.27
1.4	QPSK	3	1	22.92	23.00	23.04	26.13	26.21	26.25
1.4	QPSK	3	3	22.85	22.98	22.93	26.06	26.19	26.14
1.4	QPSK	6	0	21.74	21.85	22.05	24.95	25.06	25.26
1.4	16QAM	1	0	21.06	21.27	21.43	24.27	24.48	24.64
1.4	16QAM	1	3	21.01	21.53	21.38	24.22	24.74	24.59
1.4	16QAM	1	5	21.51	21.40	20.88	24.72	24.61	24.09
BW(MHz)	Modulation	RB Size	RB offset	POWER(dBm) Low Ch18615/ 1851.5MHz	POWER(dBm) Mid Ch18900 /1880MHz	POWER(dBm) High Ch19185/ 1908.5MHz	EIRP Low Ch18615/ 1851.5MHz	EIRP Mid Ch18900/ 1880MHz	EIRP High Ch19185/ 1908.5MHz
3	QPSK	1	0	22.36	22.69	22.66	25.57	25.90	25.87
3	QPSK	1	7	22.88	22.80	23.18	26.09	26.01	26.39
3	QPSK	1	14	22.72	22.69	22.55	25.93	25.90	25.76
3	QPSK	8	0	21.71	21.88	21.97	24.92	25.09	25.18
3	QPSK	8	3	21.59	21.72	21.90	24.80	24.93	25.11
3	QPSK	8	7	21.68	21.95	21.97	24.89	25.16	25.18
3	QPSK	15	0	21.69	21.88	22.04	24.90	25.09	25.25
3	16QAM	1	0	21.25	21.25	21.44	24.46	24.46	24.65
3	16QAM	1	7	21.52	22.12	22.03	24.73	25.33	25.24
3	16QAM	1	14	21.35	21.29	21.37	24.56	24.50	24.58
BW(MHz)	Modulation	RB Size	RB offset	POWER(dBm) Low Ch18625/ 1852.5MHz	POWER(dBm) Mid Ch18900/ 1880MHz	POWER(dBm) High Ch19175/ 1907.5MHz	EIRP Low Ch18625/ 1852.5MHz	EIRP Mid Ch18900/ 1880MHz	EIRP High Ch19175/ 1907.5MHz
5	QPSK	1	0	22.46	22.66	22.65	25.67	25.87	25.86
5	QPSK	1	12	22.57	23.03	23.23	25.78	26.24	26.44
5	QPSK	1	24	22.73	22.65	22.69	25.94	25.86	25.90
5	QPSK	12	0	21.63	21.85	21.96	24.84	25.06	25.17
5	QPSK	12	6	21.65	21.87	21.92	24.86	25.08	25.13
5	QPSK	12	13	21.75	21.81	22.09	24.96	25.02	25.30
5	QPSK	25	0	21.68	21.83	21.86	24.89	25.04	25.07
5	16QAM	1	0	21.08	21.70	21.84	24.29	24.91	25.05
5	16QAM	1	12	22.03	22.13	21.92	25.24	25.34	25.13
5	16QAM	1	24	20.77	21.19	21.45	23.98	24.40	24.66

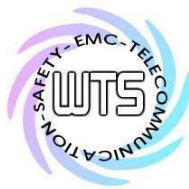

# Worldwide Testing Services(Taiwan) Co., Ltd.

Report Number: W6M22006-20020-P-247

FCC ID: GX9CTC1052QT

BW(MHz)	Modulation	RB Size	RB offset	POWER(dBm) Low Ch18650/ 1855MHz	POWER(dBm) Mid Ch18900/ 1880MHz	POWER(dBm) High Ch19150/ 1905MHz	EIRP Low Ch18650/ 1855MHz	EIRP Mid Ch18900/ 1880MHz	EIRP High Ch19150/ 1905MHz
10	QPSK	1	0	22.75	22.77	22.60	25.96	25.98	25.81
10	QPSK	1	24	22.90	22.67	22.68	26.11	25.88	25.89
10	QPSK	1	49	22.60	22.68	23.07	25.81	25.89	26.28
10	QPSK	25	0	21.75	21.88	22.01	24.96	25.09	25.22
10	QPSK	25	12	21.79	21.94	22.06	25.00	25.15	25.27
10	QPSK	25	25	21.78	21.87	22.20	24.99	25.08	25.41
10	QPSK	50	0	21.78	21.99	22.01	24.99	25.20	25.22
10	16QAM	1	0	21.32	21.23	21.24	24.53	24.44	24.45
10	16QAM	1	24	21.11	21.55	21.71	24.32	24.76	24.92
10	16QAM	1	49	21.79	21.39	21.44	25.00	24.60	24.65
BW(MHz)	Modulation	RB Size	RB offset	POWER(dBm) Low Ch18675/ 1857.5MHz	POWER(dBm) Mid Ch18900/ 1880MHz	POWER(dBm) High Ch19125/ 1902.5MHz	EIRP Low Ch18675/ 1857.5MHz	EIRP Mid Ch18900/ 1880MHz	EIRP High Ch19125/ 1902.5MHz
15	QPSK	1	0	22.97	22.81	22.86	26.18	26.02	26.07
15	QPSK	1	37	22.99	23.33	23.35	26.20	26.54	26.56
15	QPSK	1	74	22.91	23.18	23.22	26.12	26.39	26.43
15	QPSK	36	0	21.88	22.04	22.03	25.09	25.25	25.24
15	QPSK	36	19	22.10	21.98	22.01	25.31	25.19	25.22
15	QPSK	36	39	22.13	22.10	22.01	25.34	25.31	25.22
15	QPSK	75	0	22.02	22.05	22.07	25.23	25.26	25.28
15	16QAM	1	0	21.44	22.27	22.52	24.65	25.48	25.73
15	16QAM	1	37	22.57	22.71	22.81	25.78	25.92	26.02
15	16QAM	1	74	21.70	22.31	21.92	24.91	25.52	25.13
BW(MHz)	Modulation	RB Size	RB offset	POWER(dBm) Low Ch18700/ 1860MHz	POWER(dBm) Mid Ch18900/ 1880MHz	POWER(dBm) High Ch19100/ 1900MHz	EIRP Low Ch18675/ 1857.5MHz	EIRP Mid Ch18900/ 1880MHz	EIRP High Ch19125/ 1902.5MHz
20	QPSK	1	0	22.28	22.80	23.05	25.49	26.01	26.26
20	QPSK	1	49	22.83	23.22	22.87	26.04	26.43	26.08
20	QPSK	1	99	23.06	22.9	22.80	26.27	26.11	26.01
20	QPSK	50	0	21.90	22.00	22.03	25.11	25.21	25.24
20	QPSK	50	25	21.97	22.11	22.12	25.18	25.32	25.33
20	QPSK	50	50	21.90	22.19	22.12	25.11	25.40	25.33
20	QPSK	100	0	21.89	22.06	22.04	25.10	25.27	25.25
20	16QAM	1	0	21.52	22.23	21.98	24.73	25.44	25.19
20	16QAM	1	49	21.89	22.35	22.33	25.10	25.56	25.54
20	16QAM	1	99	21.57	21.69	21.81	24.78	24.90	25.02

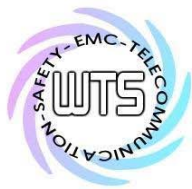

# Worldwide Testing Services(Taiwan) Co., Ltd.

Report Number: W6M22006-20020-P-247

FCC ID: GX9CTC1052QT

## Band IV

BW(MHz)	Modulation	RB Size	RB offset	POWER(dBm) Low Ch19957/ 1710.7MHz	POWER(dBm) Mid Ch20175/ 1732.5MHz	POWER(dBm) High Ch20393/ 1754.3MHz	EIRP Low Ch19957/ 1710.7MHz	EIRP Mid Ch20175/ 1732.5MHz	EIRP High Ch20393/ 1754.3MHz
1.4	QPSK	1	0	22.53	22.63	22.35	25.20	25.30	25.02
1.4	QPSK	1	3	22.67	22.82	22.56	25.34	25.49	25.23
1.4	QPSK	1	5	22.59	22.68	22.42	25.26	25.35	25.09
1.4	QPSK	3	0	22.77	23.10	23.05	25.44	25.77	25.72
1.4	QPSK	3	1	22.93	23.15	23.05	25.60	25.82	25.72
1.4	QPSK	3	3	22.85	23.02	22.95	25.52	25.69	25.62
1.4	QPSK	6	0	21.97	22.01	21.89	24.64	24.68	24.56
1.4	16QAM	1	0	21.45	21.80	21.75	24.12	24.47	24.42
1.4	16QAM	1	3	21.06	21.28	21.03	23.73	23.95	23.70
1.4	16QAM	1	5	21.28	21.24	21.03	23.95	23.91	23.70
BW(MHz)	Modulation	RB Size	RB offset	POWER(dBm) Low Ch19965/ 1711.5MHz	POWER(dBm) Mid Ch20175/ 1732.5MHz	POWER(dBm) High Ch20385/ 1753.5MHz	EIRP Low Ch19965/ 1711.5MHz	EIRP Mid Ch20175/ 1732.5MHz	EIRP High Ch20385/ 1753.5MHz
3	QPSK	1	0	22.94	22.72	22.81	25.61	25.39	25.48
3	QPSK	1	7	22.52	23.02	22.68	25.19	25.69	25.35
3	QPSK	1	14	22.89	22.52	22.63	25.56	25.19	25.30
3	QPSK	8	0	21.94	21.98	21.83	24.61	24.65	24.50
3	QPSK	8	3	21.81	22.05	21.79	24.48	24.72	24.46
3	QPSK	8	7	21.77	22.06	21.91	24.44	24.73	24.58
3	QPSK	15	0	21.88	22.04	21.76	24.55	24.71	24.43
3	16QAM	1	0	21.49	21.42	21.19	24.16	24.09	23.86
3	16QAM	1	7	21.26	21.48	21.53	23.93	24.15	24.20
3	16QAM	1	14	21.39	21.45	21.17	24.06	24.12	23.84
BW(MHz)	Modulation	RB Size	RB offset	POWER(dBm) Low Ch19975/ 1712.5MHz	POWER(dBm) Mid Ch20175/ 1732.5MHz	POWER(dBm) High Ch20375/ 1752.5MHz	EIRP Low Ch19975/ 1712.5MHz	EIRP Mid Ch20175/ 1732.5MHz	EIRP High Ch20375/ 1752.5MHz
5	QPSK	1	0	22.73	22.81	22.61	25.40	25.48	25.28
5	QPSK	1	12	22.61	22.88	22.67	25.28	25.55	25.34
5	QPSK	1	24	22.57	22.52	22.87	25.24	25.19	25.54
5	QPSK	12	0	21.71	21.88	21.76	24.38	24.55	24.43
5	QPSK	12	6	21.67	21.98	21.85	24.34	24.65	24.52
5	QPSK	12	13	21.82	21.97	21.74	24.49	24.64	24.41
5	QPSK	25	0	21.67	21.97	21.87	24.34	24.64	24.54
5	16QAM	1	0	21.71	21.39	21.40	24.38	24.06	24.07
5	16QAM	1	12	21.58	21.62	21.62	24.25	24.29	24.29
5	16QAM	1	24	21.41	21.31	21.31	24.08	23.98	23.98
BW(MHz)	Modulation	RB Size	RB offset	POWER(dBm) Low Ch20000/ 1715MHz	POWER(dBm) Mid Ch20175/ 1732.5MHz	POWER(dBm) High Ch20350/ 1750MHz	EIRP Low Ch20000/ 1715MHz	EIRP Mid Ch20175/ 1732.5MHz	EIRP High Ch20350/ 1750MHz
10	QPSK	1	0	22.58	22.40	22.46	25.25	25.07	25.13
10	QPSK	1	24	22.48	22.69	22.51	25.15	25.36	25.18
10	QPSK	1	49	22.36	22.69	22.80	25.03	25.36	25.47
10	QPSK	25	0	21.72	21.95	21.87	24.39	24.62	24.54
10	QPSK	25	12	21.82	21.99	21.70	24.49	24.66	24.37
10	QPSK	25	25	21.57	21.88	21.82	24.24	24.55	24.49
10	QPSK	50	0	21.79	21.99	21.75	24.46	24.66	24.42
10	16QAM	1	0	21.98	20.96	21.22	24.65	23.63	23.89
10	16QAM	1	24	21.53	21.25	20.92	24.20	23.92	23.59
10	16QAM	1	49	20.82	20.77	21.07	23.49	23.44	23.74

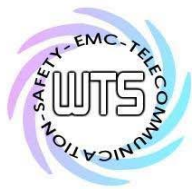

# Worldwide Testing Services(Taiwan) Co., Ltd.

Report Number: W6M22006-20020-P-247

FCC ID: GX9CTC1052QT

BW(MHz)	Modulation	RB Size	RB offset	POWER(dBm) Low Ch20025/ 1717.5MHz	POWER(dBm) Mid Ch20175/ 1732.5MHz	POWER(dBm) High Ch20325/ 1747.5MHz	EIRP Low Ch20025/ 1717.5MHz	EIRP Mid Ch20175/ 1732.5MHz	EIRP High Ch20325/ 1747.5MHz
20	QPSK	1	0	22.55	22.88	22.71	25.22	25.55	25.38
20	QPSK	1	49	22.39	22.66	23.01	25.06	25.33	25.68
20	QPSK	1	99	22.73	22.38	22.32	25.40	25.05	24.99
20	QPSK	50	0	21.99	21.98	21.99	24.66	24.65	24.66
20	QPSK	50	25	21.73	21.94	21.82	24.40	24.61	24.49
20	QPSK	50	50	21.82	21.77	21.67	24.49	24.44	24.34
20	QPSK	100	0	21.64	22.01	21.79	24.31	24.68	24.46
20	16QAM	1	0	21.00	21.20	21.78	23.67	23.87	24.45
20	16QAM	1	49	21.62	21.29	21.10	24.29	23.96	23.77
20	16QAM	1	99	21.18	21.81	21.19	23.85	24.48	23.86

## Band V

BW (MHz)	Modulation	RB Size	RB offset	POWER(dBm) Low Ch20407/ 824.7MHz	POWER(dBm) Mid Ch20525/ 836.5MHz	POWER(dBm) High Ch20643/ 848.3MHz	ERP Low Ch20407/ 824.7MHz	ERP Mid Ch20525/ 836.5MHz	ERP High Ch20643/ 848.3MHz
1.4	QPSK	1	0	23.58	23.31	23.27	23.45	23.18	23.14
1.4	QPSK	1	3	23.53	23.49	23.38	23.40	23.36	23.25
1.4	QPSK	1	5	23.32	23.65	23.37	23.19	23.52	23.24
1.4	QPSK	3	0	23.50	23.70	23.46	23.37	23.57	23.33
1.4	QPSK	3	1	23.61	23.67	23.73	23.48	23.54	23.60
1.4	QPSK	3	3	23.73	23.78	23.54	23.60	23.65	23.41
1.4	QPSK	6	0	22.52	22.61	22.46	22.39	22.48	22.33
1.4	16QAM	1	0	22.32	22.35	22.39	22.19	22.22	22.26
1.4	16QAM	1	3	21.86	22.24	22.06	21.73	22.11	21.93
1.4	16QAM	1	5	22.06	22.11	21.68	21.93	21.98	21.55
BW (MHz)	Modulation	RB Size	RB offset	POWER(dBm) Low Ch20415/ 825.5MHz	POWER(dBm) Mid Ch20525/ 836.5MHz	POWER(dBm) High Ch20635/ 847.5MHz	ERP Low Ch20415/ 825.5MHz	ERP Mid Ch20525/ 836.5MHz	ERP High Ch20635/ 847.5MHz
3	QPSK	1	0	23.57	23.63	23.07	23.44	23.50	22.94
3	QPSK	1	7	23.80	23.50	23.09	23.67	23.37	22.96
3	QPSK	1	14	23.55	23.55	23.51	23.42	23.42	23.38
3	QPSK	8	0	22.65	22.72	22.36	22.52	22.59	22.23
3	QPSK	8	3	22.74	22.58	22.45	22.61	22.45	22.32
3	QPSK	8	7	22.56	22.61	22.46	22.43	22.48	22.33
3	QPSK	15	0	22.67	22.57	22.38	22.54	22.44	22.25
3	16QAM	1	0	22.55	22.07	21.99	22.42	21.94	21.86
3	16QAM	1	7	22.64	22.49	21.96	22.51	22.36	21.83
3	16QAM	1	14	22.04	22.16	22.42	21.91	22.03	22.29

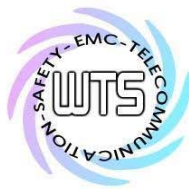

Report Number: W6M22006-20020-P-247

FCC ID: GX9CTC1052QT

BW(MHz)	Modulation	RB Size	RB offset	POWER(dBm) Low Ch20425/ 826.5MHz	POWER(dBm) Mid Ch20525/ 836.5MHz	POWER(dBm) High Ch20625/ 846.5MHz	ERP Low Ch20425/ 826.5MHz	ERP Mid Ch20525/ 836.5MHz	ERP High Ch20625/ 846.5MHz
5	QPSK	1	0	23.54	23.30	23.37	23.41	23.17	23.24
5	QPSK	1	12	23.56	23.72	23.18	23.43	23.59	23.05
5	QPSK	1	24	23.53	23.31	23.36	23.40	23.18	23.23
5	QPSK	12	0	22.75	22.59	22.39	22.62	22.46	22.26
5	QPSK	12	6	22.72	22.66	22.29	22.59	22.53	22.16
5	QPSK	12	13	22.81	22.57	22.55	22.68	22.44	22.42
5	QPSK	25	0	22.72	22.62	22.47	22.59	22.49	22.34
5	16QAM	1	0	22.09	22.45	22.13	21.96	22.32	22.00
5	16QAM	1	12	22.67	22.53	21.88	22.54	22.40	21.75
5	16QAM	1	24	21.98	22.30	22.01	21.85	22.17	21.88
BW (MHz)	Modulation	RB Size	RB offset	POWER(dBm) Low Ch20450/ 829MHz	POWER(dBm) Mid Ch20525/ 836.5MHz	POWER(dBm) High Ch20600/ 844MHz	ERP Low Ch20450/ 829MHz	ERP Mid Ch20525/ 836.5MHz	ERP High Ch20600/ 844MHz
10	QPSK	1	0	23.40	23.81	23.24	23.27	23.68	23.11
10	QPSK	1	24	23.64	23.61	23.25	23.51	23.48	23.12
10	QPSK	1	49	23.02	23.46	23.34	22.89	23.33	23.21
10	QPSK	25	0	22.63	22.47	22.55	22.50	22.34	22.42
10	QPSK	25	12	22.46	22.48	22.27	22.33	22.35	22.14
10	QPSK	25	25	22.32	22.45	22.32	22.19	22.32	22.19
10	QPSK	50	0	22.57	22.44	22.45	22.44	22.31	22.32
10	16QAM	1	0	22.19	21.92	22.01	22.06	21.79	21.88
10	16QAM	1	24	21.92	22.36	21.71	21.79	22.23	21.58
10	16QAM	1	49	22.05	22.27	22.30	21.92	22.14	22.17

## Band XII

BW(MHz)	Modulation	RB Size	RB offset	POWER(dBm) Low Ch23017/ 699.7MHz	POWER(dBm) Mid Ch23095/ 707.5MHz	POWER(dBm) High Ch23173/ 715.3MHz	ERP Low Ch23017/ 699.7MHz	ERP Mid Ch23095/ 707.5MHz	ERP High Ch23173/ 715.3MHz
1.4	QPSK	1	0	22.54	22.68	22.40	24.12	24.26	23.98
1.4	QPSK	1	3	22.79	22.83	22.98	24.37	24.41	24.56
1.4	QPSK	1	5	23.16	22.70	22.64	24.74	24.28	24.22
1.4	QPSK	3	0	22.93	22.98	22.97	24.51	24.56	24.55
1.4	QPSK	3	1	23.18	23.19	22.96	24.76	24.77	24.54
1.4	QPSK	3	3	23.09	22.96	22.89	24.67	24.54	24.47
1.4	QPSK	6	0	22.18	22.08	22.05	23.76	23.66	23.63
1.4	16QAM	1	0	21.15	21.74	21.27	22.73	23.32	22.85
1.4	16QAM	1	3	21.61	21.54	21.73	23.19	23.12	23.31
1.4	16QAM	1	5	21.64	21.38	21.29	23.22	22.96	22.87



# Worldwide Testing Services(Taiwan) Co., Ltd.

Report Number: W6M22006-20020-P-247

FCC ID: GX9CTC1052QT

BW(MHz)	Modulation	RB Size	RB offset	POWER(dBm) ) Low Ch23025/ 700.5MHz	POWER(dBm) ) Mid Ch23095/ 707.5MHz	POWER(dBm) ) High Ch23165/ 714.5MHz	ERP Low Ch23025/ 700.5MHz	ERP Mid Ch23095/ 707.5MHz	ERP High Ch23165/ 714.5MHz
5	QPSK	1	0	22.58	22.52	22.49	24.16	24.10	24.07
5	QPSK	1	12	22.92	23.01	23.06	24.50	24.59	24.64
5	QPSK	1	24	22.98	22.50	22.83	24.56	24.08	24.41
5	QPSK	12	0	22.04	21.99	22.04	23.62	23.57	23.62
5	QPSK	12	6	22.04	22.04	22.06	23.62	23.62	23.64
5	QPSK	12	13	22.09	22.12	22.04	23.67	23.70	23.62
5	QPSK	25	0	22.18	22.10	22.00	23.76	23.68	23.58
5	16QAM	1	0	20.86	21.42	21.57	22.44	23.00	23.15
5	16QAM	1	12	21.98	21.57	21.91	23.56	23.15	23.49
5	16QAM	1	24	20.95	20.98	21.20	22.53	22.56	22.78
BW(MHz)	Modulation	RB Size	RB offset	POWER(dBm) ) Low Ch23035/ 701.5MHz	POWER(dBm) ) Mid Ch23095/ 707.5MHz	POWER(dBm) ) High Ch23155/ 713.5MHz	ERP Low Ch23035/ 701.5MHz	ERP Mid Ch23095/ 707.5MHz	ERP High Ch23155/ 713.5MHz
10	QPSK	1	0	22.80	22.78	22.86	24.38	24.36	24.44
10	QPSK	1	24	22.84	22.74	23.46	24.42	24.32	25.04
10	QPSK	1	49	22.95	22.62	22.72	24.53	24.20	24.30
10	QPSK	25	0	22.01	22.03	22.16	23.59	23.61	23.74
10	QPSK	25	12	22.23	22.12	22.11	23.81	23.70	23.69
10	QPSK	25	25	22.11	21.93	22.09	23.69	23.51	23.67
10	QPSK	50	0	22.16	22.05	22.14	23.74	23.63	23.72
10	16QAM	1	0	21.44	21.61	22.07	23.02	23.19	23.65
10	16QAM	1	24	21.06	21.74	21.16	22.64	23.32	22.74
10	16QAM	1	49	21.70	21.10	20.84	23.28	22.68	22.42

## Band XIII

BW(MHz)	Modulation	RB Size	RB offset	POWER(dBm) ) Low Ch23205/ 779.5MHz	POWER(dBm) ) Mid Ch23230/ 782MHz	POWER(dBm) ) High Ch23255/ 784.5MHz	ERP Low Ch23205/ 779.5MHz	ERP Mid Ch23230/ 782MHz	ERP High Ch23255/ 784.5MHz
5	QPSK	1	0	22.67	22.79	22.92	23.52	23.64	23.77
5	QPSK	1	12	23.06	23.39	23.23	23.91	24.24	24.08
5	QPSK	1	24	23.35	23.18	22.85	24.20	24.03	23.70
5	QPSK	12	0	22.14	22.21	22.36	22.99	23.06	23.21
5	QPSK	12	6	22.24	22.32	22.45	23.09	23.17	23.30
5	QPSK	12	13	22.21	22.30	22.25	23.06	23.15	23.10
5	QPSK	25	0	22.29	22.34	22.33	23.14	23.19	23.18
5	16QAM	1	0	21.69	21.42	22.30	22.54	22.27	23.15
5	16QAM	1	12	22.04	22.40	22.46	22.89	23.25	23.31
5	16QAM	1	24	21.65	21.91	21.64	22.50	22.76	22.49



# Worldwide Testing Services(Taiwan) Co., Ltd.

Report Number: W6M22006-20020-P-247

FCC ID: GX9CTC1052QT

BW(MHz)	Modulation	RB Size	RB offset	POWER(dBm) Low&Mid&High Ch23230/782MHz	ERP Mid Ch23230/782MHz
10	QPSK	1	0	23.01	23.86
10	QPSK	1	24	23.66	24.51
10	QPSK	1	49	22.92	23.77
10	QPSK	25	0	22.32	23.17
10	QPSK	25	12	22.34	23.19
10	QPSK	25	25	22.34	23.19
10	QPSK	50	0	22.47	23.32
10	16QAM	1	0	21.80	22.65
10	16QAM	1	24	22.33	23.18
10	16QAM	1	49	21.54	22.39

Test equipment: ETSTW-GSM 002, ETSTW-GSM 004

Report Number: W6M22006-20020-P-247

FCC ID: GX9CTC1052QT

#### **4. Modulation Characteristics**

##### **4.1 Test procedure**

- A curve or equivalent data showing the frequency response of the audio modulating circuit over a range of 100 to 5000 Hz shall be submitted.  
The audio signal generator is connected to the audio input of the EUT with its full rating. The modulation response is measured at certain modulation frequencies, related to 1000Hz reference signal. Tests are performed for positive and negative modulation.
  
- Equipment which employs modulation Limiting: A curve or family of curves showing the percentage of modulation versus the modulation input voltage shall be supplied. The audio signal generator is connected to the audio input of the EUT with its full rating. The modulation limiting is measured at certain modulation frequencies from 100Hz to 15kHz.

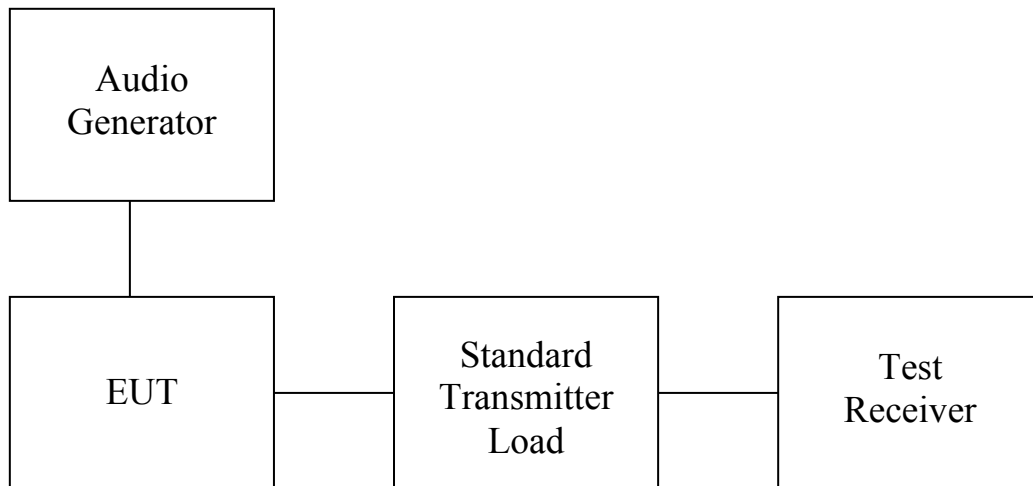

##### **4.2 Test Results**

For digital modulation employed, this test item is not applicable.



Report Number: W6M22006-20020-P-247

FCC ID: GX9CTC1052QT

## 5. Peak-to-Average Ratio

The peak-to-average power ratio (PAPR) of the transmitter output power must not exceed 13 dB. The PAPR measurements should be made using either an instrument with complementary cumulative distribution function (CCDF) capabilities to determine that PAPR will not exceed 13 dB for more than 0.1 percent of the time or other Commission approved procedure. The measurement must be performed using a signal corresponding to the highest PAPR expected during periods of continuous transmission.

### 5.1 Test procedure

1. The EUT main port was connected to the LTE emulator and spectrum analyzer via power divider
2. For Spectrum Analyzer setting :
3. Set the CCDF function in spectrum analyzer.
4. Set  $RBW \geq$  signal's occupied bandwidth.
5. Set the number of counts to a value that stabilizes the measured CCDF curve.
6. Set the measurement interval (sweep time) to 1ms.
7. The highest RF powers were measured and recorded the maximum PAPR level associated with a probability of 0.1%
8. Record the deviation as Peak to Average Ratio.

### 5.2 Test Set up

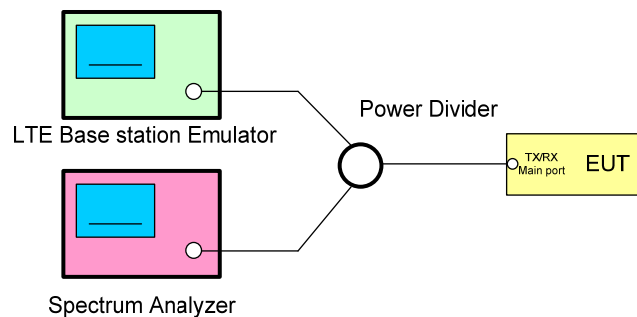



Report Number: W6M22006-20020-P-247

FCC ID: GX9CTC1052QT

### 5.3 Test Results

Test date: August 13, 2020

Temperature: 24.5 °C

Humidity: 48.6 %

Tester: Kent

WCDMA

Band II



1 SA  
CLRWR

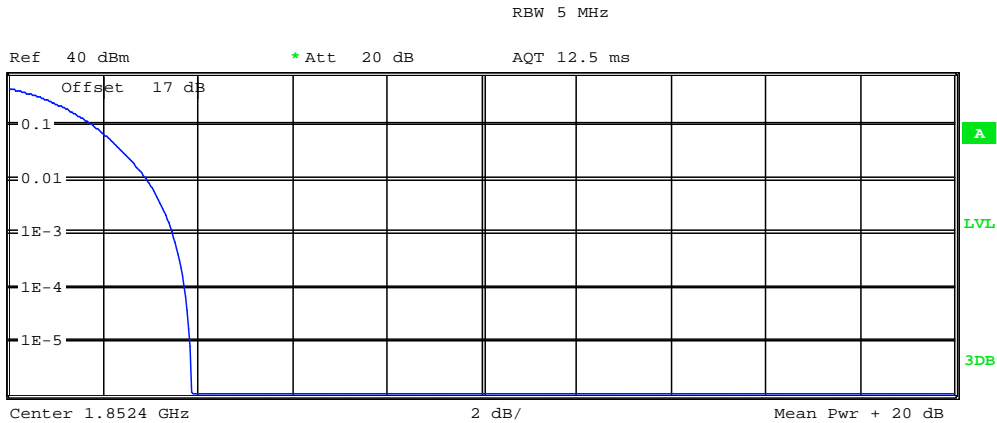

Complementary Cumulative Distribution Function (100000 samples)

Trace 1	
Mean	21.40 dBm
Peak	25.27 dBm
Crest	3.87 dB
10 %	1.79 dB
1 %	2.92 dB
.1 %	3.46 dB
.01 %	3.72 dB

Date: 13.AUG.2020 19:12:19



Report Number: W6M22006-20020-P-247  
 FCC ID: GX9CTC1052QT

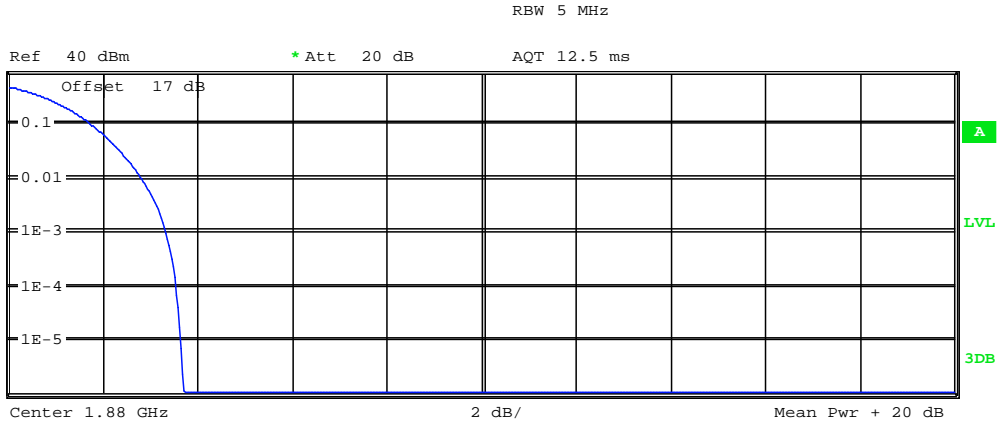

Complementary Cumulative Distribution Function (100000 samples)

Trace 1	
Mean	21.22 dBm
Peak	24.91 dBm
Crest	3.70 dB
10 %	1.76 dB
1 %	2.79 dB
.1 %	3.33 dB
.01 %	3.56 dB

Date: 13.AUG.2020 19:12:47



Report Number: W6M22006-20020-P-247  
FCC ID: GX9CTC1052QT

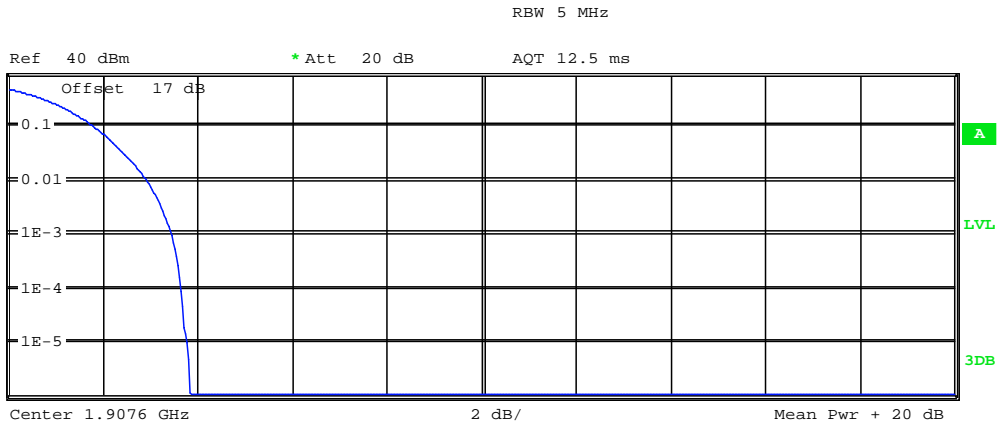

Complementary Cumulative Distribution Function (100000 samples)

Trace 1	
Mean	21.21 dBm
Peak	25.06 dBm
Crest	3.84 dB
10 %	1.79 dB
1 %	2.92 dB
.1 %	3.46 dB
.01 %	3.65 dB

Date: 13.AUG.2020 19:13:11



# Worldwide Testing Services(Taiwan) Co., Ltd.

Report Number: W6M22006-20020-P-247

FCC ID: GX9CTC1052QT

Band IV



RBW 5 MHz

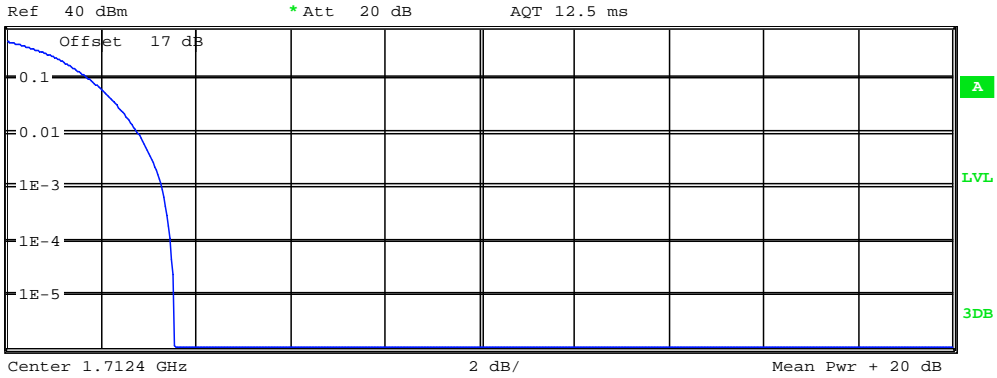

Complementary Cumulative Distribution Function (100000 samples)

Trace 1	
Mean	21.50 dBm
Peak	25.06 dBm
Crest	3.55 dB
10 %	1.76 dB
1 %	2.79 dB
.1 %	3.30 dB
.01 %	3.46 dB

Date: 13.AUG.2020 19:13:38



Report Number: W6M22006-20020-P-247  
FCC ID: GX9CTC1052QT



RBW 5 MHz

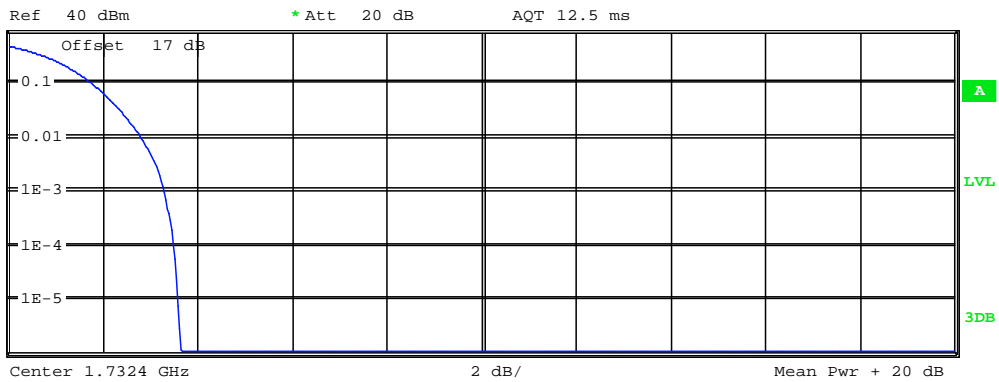

Complementary Cumulative Distribution Function (100000 samples)

Trace 1	
Mean	21.21 dBm
Peak	24.84 dBm
Crest	3.64 dB
10 %	1.76 dB
1 %	2.79 dB
.1 %	3.30 dB
.01 %	3.49 dB

Date: 13.AUG.2020 19:14:02



Report Number: W6M22006-20020-P-247

FCC ID: GX9CTC1052QT



RBW 5 MHz

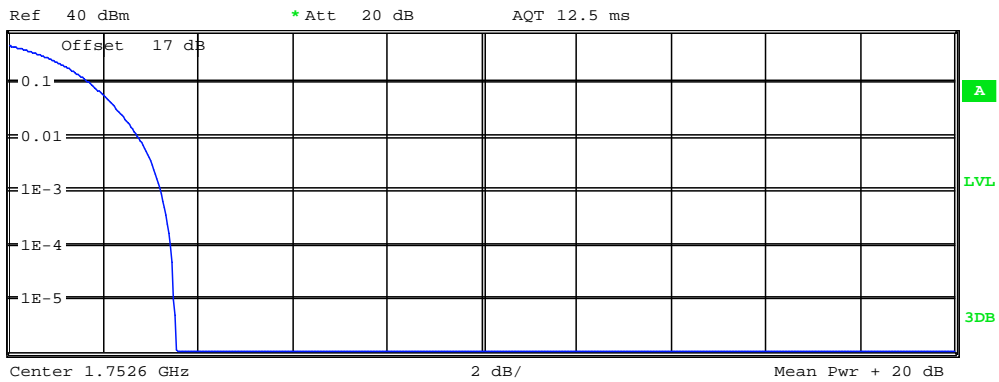

Complementary Cumulative Distribution Function (100000 samples)

Trace 1	
Mean	21.29 dBm
Peak	24.84 dBm
Crest	3.55 dB
10 %	1.73 dB
1 %	2.76 dB
.1 %	3.24 dB
.01 %	3.43 dB

Date: 13.AUG.2020 19:14:23



# Worldwide Testing Services(Taiwan) Co., Ltd.

Report Number: W6M22006-20020-P-247

FCC ID: GX9CTC1052QT

Band V



RBW 5 MHz

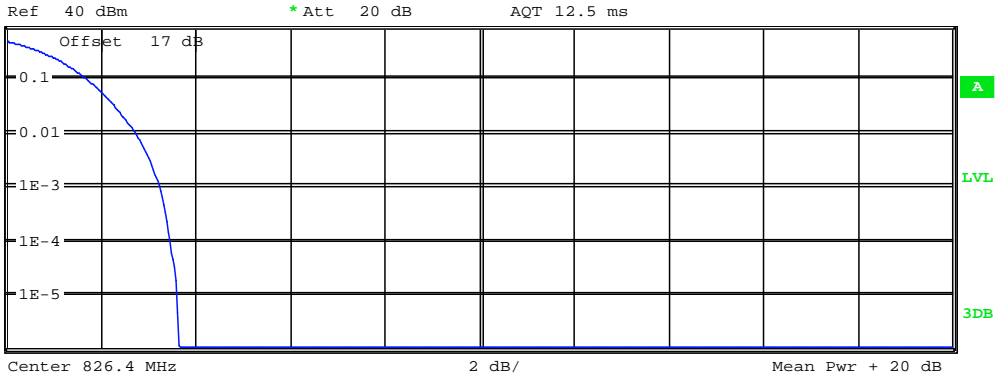

Complementary Cumulative Distribution Function (100000 samples)

Trace 1	
Mean	22.49 dBm
Peak	26.11 dBm
Crest	3.63 dB
10 %	1.70 dB
1 %	2.72 dB
.1 %	3.24 dB
.01 %	3.46 dB

Date: 13.AUG.2020 19:15:03





Report Number: W6M22006-20020-P-247  
FCC ID: GX9CTC1052QT



RBW 5 MHz

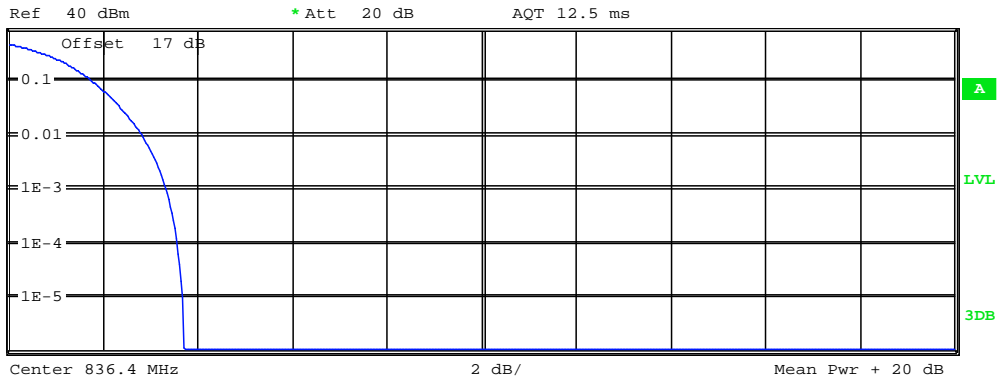

Complementary Cumulative Distribution Function (100000 samples)

Trace 1

Mean	22.61 dBm
Peak	26.33 dBm
Crest	3.71 dB
10 %	1.76 dB
1 %	2.82 dB
.1 %	3.33 dB
.01 %	3.56 dB

Date: 13.AUG.2020 19:15:28



Report Number: W6M22006-20020-P-247  
 FCC ID: GX9CTC1052QT

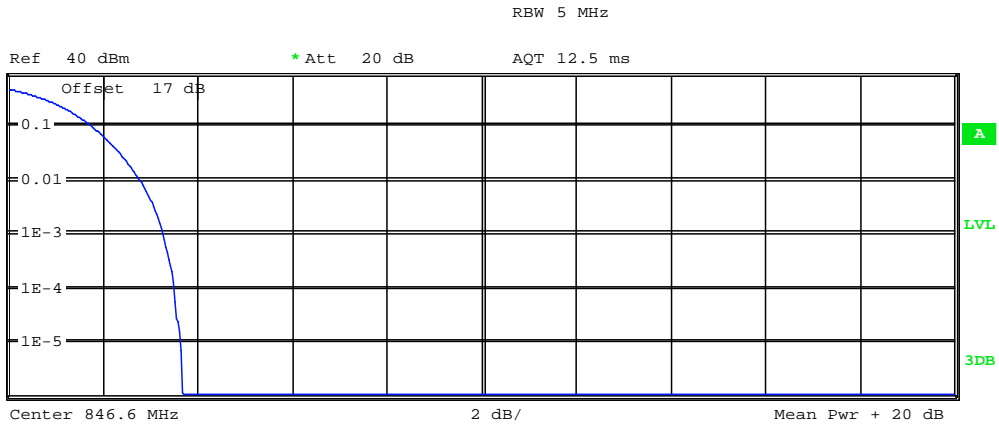

Complementary Cumulative Distribution Function (100000 samples)

Trace 1	
Mean	22.44 dBm
Peak	26.11 dBm
Crest	3.67 dB
10 %	1.76 dB
1 %	2.79 dB
.1 %	3.27 dB
.01 %	3.49 dB

Date: 13.AUG.2020 19:15:47



# Worldwide Testing Services(Taiwan) Co., Ltd.

Report Number: W6M22006-20020-P-247

FCC ID: GX9CTC1052QT

LTE

Band II



RBW 10 MHz

Ref 40 dBm \*Att 20 dB AQT 3.125 ms

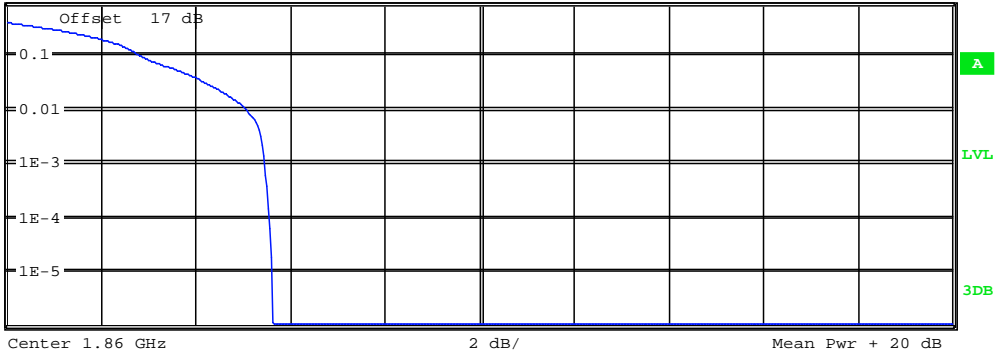

Complementary Cumulative Distribution Function (100000 samples)

Trace 1	
Mean	15.63 dBm
Peak	21.25 dBm
Crest	5.61 dB
10 %	2.85 dB
1 %	5.06 dB
.1 %	5.45 dB
.01 %	5.58 dB

Date: 13.AUG.2020 19:25:53



Report Number: W6M22006-20020-P-247  
 FCC ID: GX9CTC1052QT

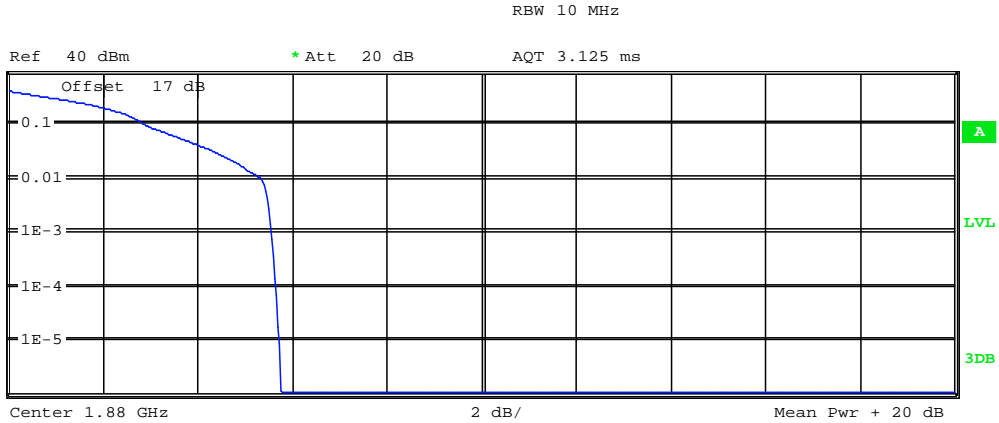

Complementary Cumulative Distribution Function (100000 samples)

Trace 1	
Mean	15.42 dBm
Peak	21.18 dBm
Crest	5.76 dB
10 %	2.92 dB
1 %	5.32 dB
.1 %	5.58 dB
.01 %	5.67 dB

Date: 13.AUG.2020 19:26:26



Report Number: W6M22006-20020-P-247  
 FCC ID: GX9CTC1052QT

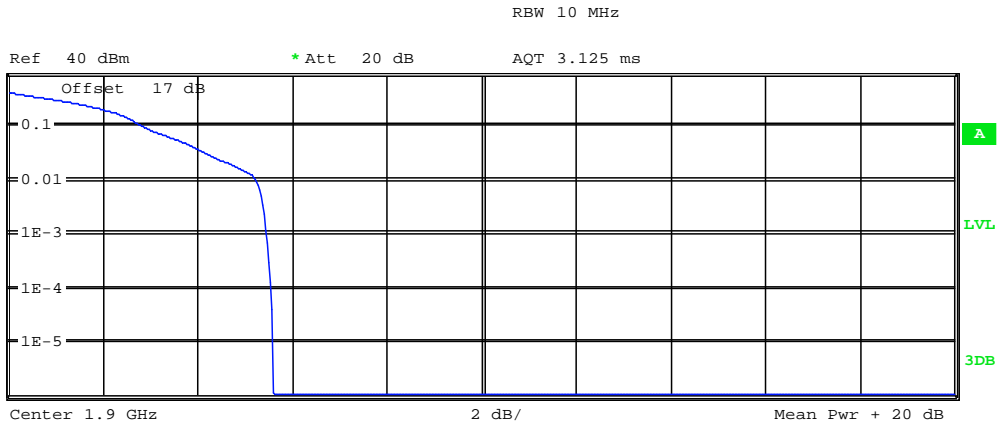

Complementary Cumulative Distribution Function (100000 samples)

Trace 1	
Mean	14.60 dBm
Peak	20.19 dBm
Crest	5.58 dB
10 %	2.85 dB
1 %	5.22 dB
.1 %	5.45 dB
.01 %	5.54 dB

Date: 13.AUG.2020 19:26:54



# Worldwide Testing Services(Taiwan) Co., Ltd.

Report Number: W6M22006-20020-P-247

FCC ID: GX9CTC1052QT

Band IV



RBW 10 MHz

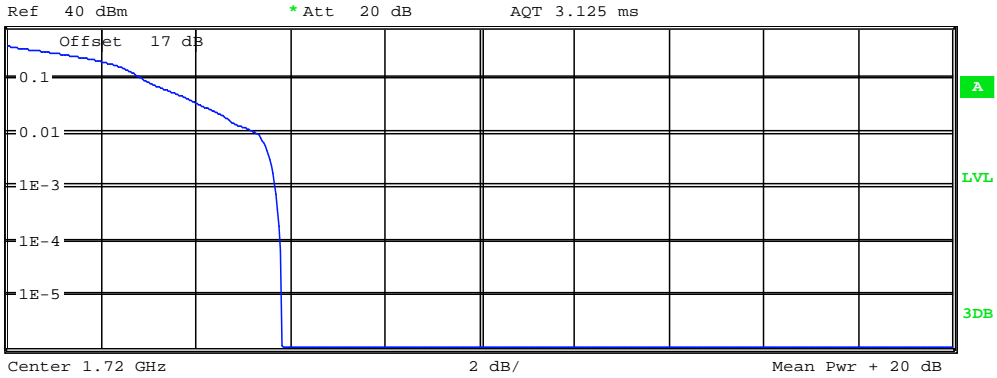

Complementary Cumulative Distribution Function (100000 samples)

Trace 1	
Mean	14.80 dBm
Peak	20.61 dBm
Crest	5.81 dB
10 %	2.88 dB
1 %	5.29 dB
.1 %	5.67 dB
.01 %	5.80 dB

Date: 13.AUG.2020 19:27:57



Report Number: W6M22006-20020-P-247  
FCC ID: GX9CTC1052QT



RBW 10 MHz

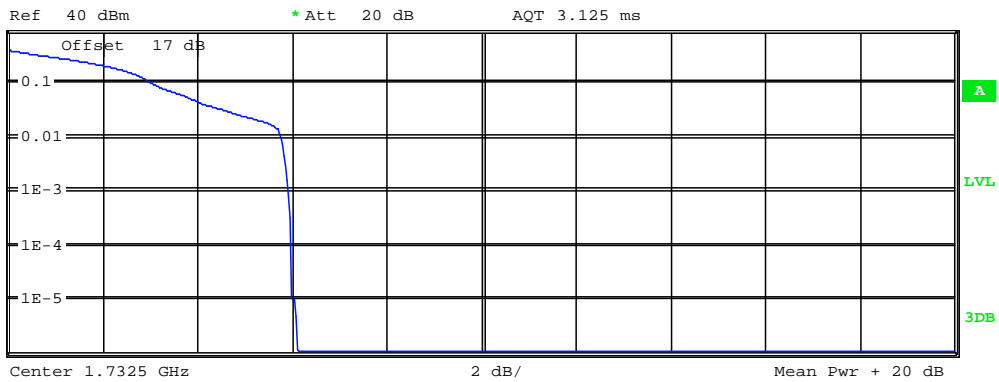

Complementary Cumulative Distribution Function (100000 samples)

Trace 1	
Mean	15.13 dBm
Peak	21.25 dBm
Crest	6.11 dB
10 %	3.08 dB
1 %	5.77 dB
.1 %	5.93 dB
.01 %	5.99 dB

Date: 13.AUG.2020 19:28:43



Report Number: W6M22006-20020-P-247  
 FCC ID: GX9CTC1052QT



RBW 10 MHz

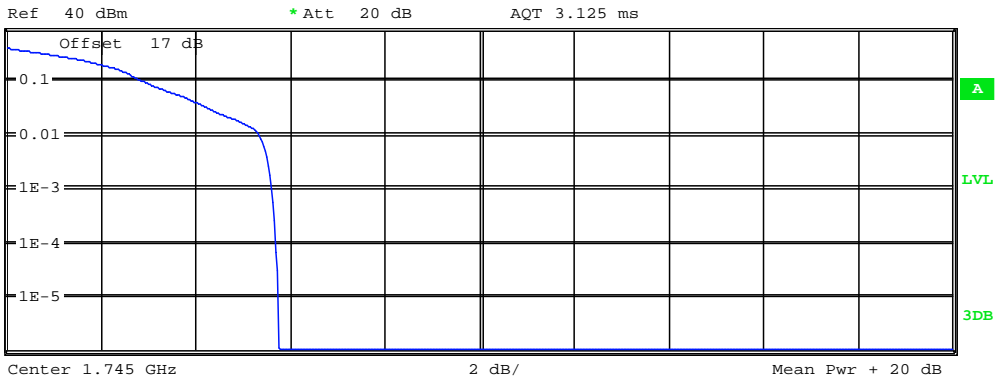

Complementary Cumulative Distribution Function (100000 samples)

Trace 1	
Mean	14.72 dBm
Peak	20.47 dBm
Crest	5.75 dB
10 %	2.92 dB
1 %	5.35 dB
.1 %	5.61 dB
.01 %	5.71 dB

Date: 13.AUG.2020 19:29:07





# Worldwide Testing Services(Taiwan) Co., Ltd.

Report Number: W6M22006-20020-P-247

FCC ID: GX9CTC1052QT

Band V



RBW 10 MHz

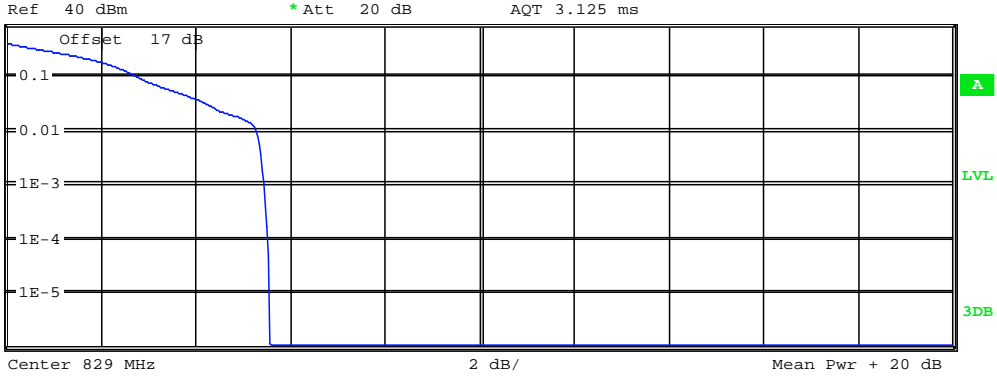

Complementary Cumulative Distribution Function (100000 samples)

Trace 1	
Mean	19.79 dBm
Peak	25.34 dBm
Crest	5.55 dB
10 %	2.79 dB
1 %	5.29 dB
.1 %	5.45 dB
.01 %	5.54 dB

Date: 13.AUG.2020 20:14:21



# Worldwide Testing Services(Taiwan) Co., Ltd.

Report Number: W6M22006-20020-P-247  
 FCC ID: GX9CTC1052QT



RBW 10 MHz

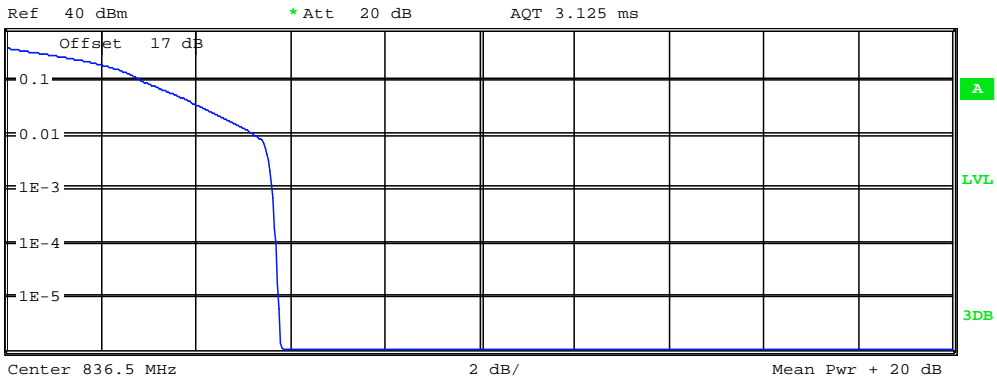

Complementary Cumulative Distribution Function (100000 samples)

Trace 1	
Mean	20.45 dBm
Peak	26.26 dBm
Crest	5.80 dB
10 %	2.92 dB
1 %	5.26 dB
.1 %	5.61 dB
.01 %	5.71 dB

Date: 13.AUG.2020 20:14:43

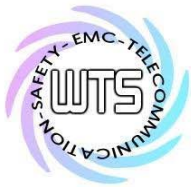

Report Number: W6M22006-20020-P-247

FCC ID: GX9CTC1052QT



RBW 10 MHz

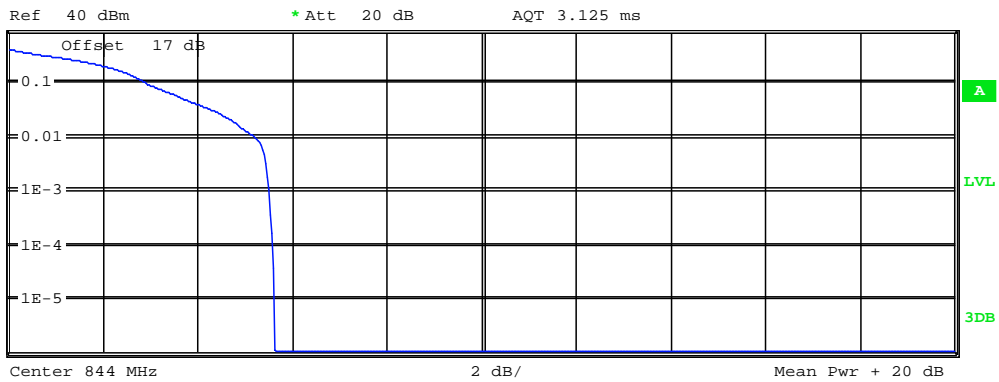

Complementary Cumulative Distribution Function (100000 samples)

Trace 1	
Mean	19.94 dBm
Peak	25.55 dBm
Crest	5.61 dB
10 %	2.95 dB
1 %	5.22 dB
.1 %	5.51 dB
.01 %	5.61 dB

Date: 13.AUG.2020 20:15:05



# Worldwide Testing Services(Taiwan) Co., Ltd.

Report Number: W6M22006-20020-P-247

FCC ID: GX9CTC1052QT

Band XII



RBW 10 MHz

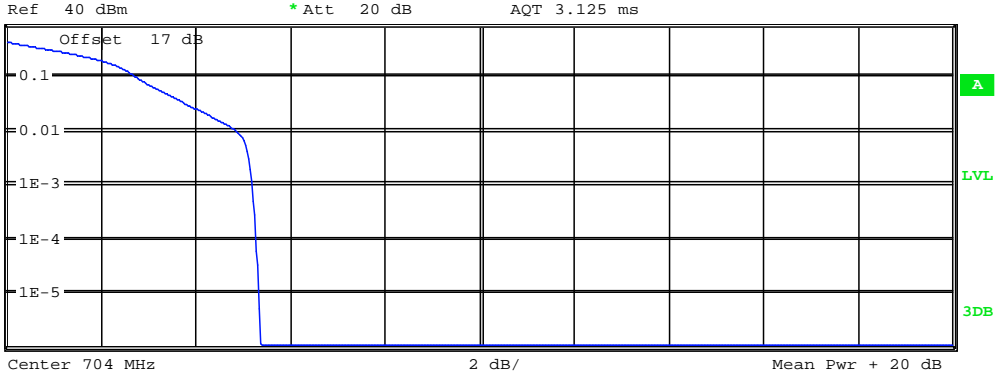

Complementary Cumulative Distribution Function (100000 samples)

Trace 1	
Mean	20.13 dBm
Peak	25.48 dBm
Crest	5.35 dB
10 %	2.76 dB
1 %	4.87 dB
.1 %	5.19 dB
.01 %	5.29 dB

Date: 13.AUG.2020 20:17:54



Report Number: W6M22006-20020-P-247  
FCC ID: GX9CTC1052QT



RBW 10 MHz

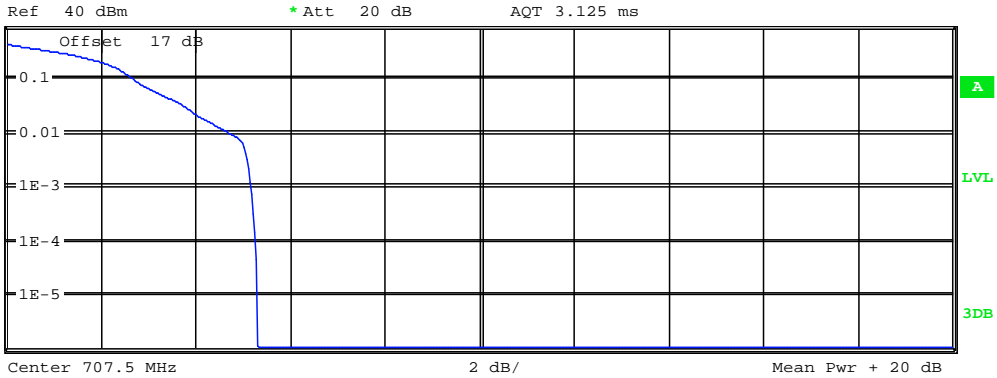

Complementary Cumulative Distribution Function (100000 samples)

Trace 1	
Mean	19.41 dBm
Peak	24.70 dBm
Crest	5.29 dB
10 %	2.69 dB
1 %	4.71 dB
.1 %	5.16 dB
.01 %	5.26 dB

Date: 13.AUG.2020 20:18:15



Report Number: W6M22006-20020-P-247  
FCC ID: GX9CTC1052QT



RBW 10 MHz

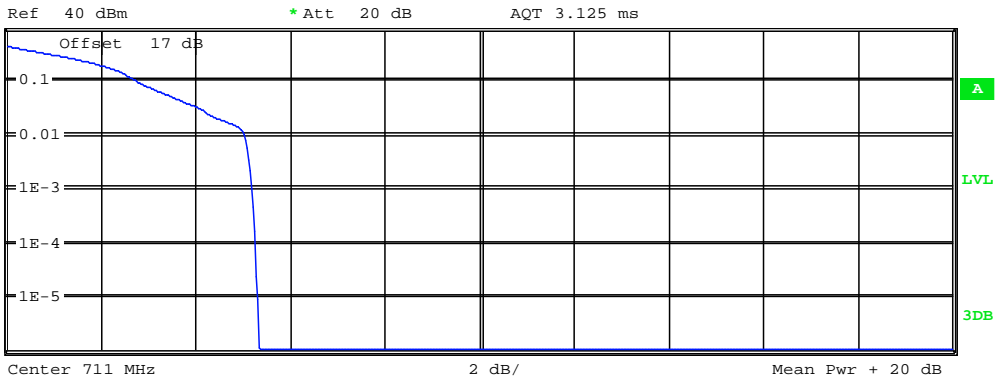

Complementary Cumulative Distribution Function (100000 samples)

Trace 1	
Mean	19.72 dBm
Peak	25.06 dBm
Crest	5.33 dB
10 %	2.79 dB
1 %	5.03 dB
.1 %	5.19 dB
.01 %	5.26 dB

Date: 13.AUG.2020 20:18:41



Report Number: W6M22006-20020-P-247

FCC ID: GX9CTC1052QT

Band XIII



RBW 10 MHz

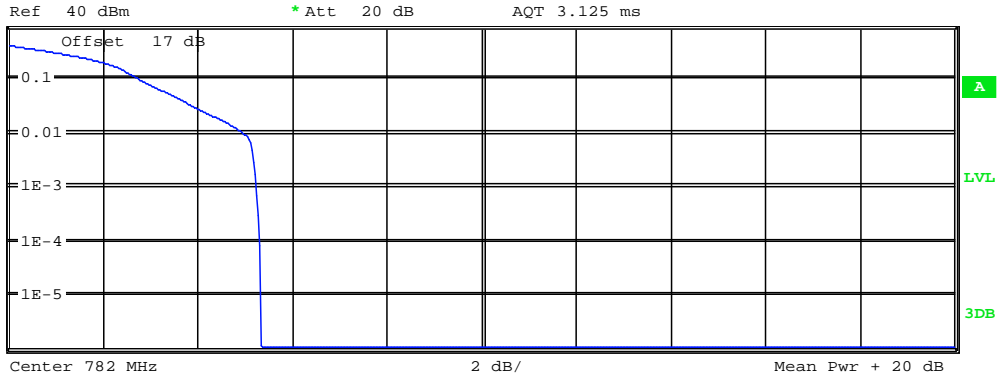

Complementary Cumulative Distribution Function (100000 samples)

Trace 1	
Mean	22.62 dBm
Peak	27.95 dBm
Crest	5.32 dB
10 %	2.79 dB
1 %	4.97 dB
.1 %	5.26 dB
.01 %	5.32 dB

Date: 13.AUG.2020 20:19:38

Limit according to FCC §24.232 and §27.50, The peak-to-average ratio(PAR) of the transmission may not exceed 13dB.

Test equipment: ETSTW-RE 055, ETSTW-GSM 002, ETSTW-GSM 023, ETSTW-GSM 004

Report Number: W6M22006-20020-P-247

FCC ID: GX9CTC1052QT

**6. Occupied Bandwidth**

The occupied bandwidth (OBW) is the frequency bandwidth such that, below its lower and above its upper frequency limits, the mean powers radiated are each equal to a specified percentage 0.5% of the total mean transmitted power.

The 26 dB occupied bandwidth is the width of a frequency band such that, below its lower and above its upper frequency limits, the mean powers radiated are each equal 26 dB.

The 26 dB emission bandwidth is defined as the frequency range between two points, one above and one below the carrier frequency, at which the spectral density of the emission is attenuated 26 dB below the maximum in-band spectral density of the modulated signal. Spectral density (power per unit bandwidth) is to be measured with a detector of resolution bandwidth equal to approximately 1.0% of the emission bandwidth.

**6.1 Test procedure**

The RF output of the transceiver was connected as the following figure.

Occupied Bandwidth was measured with a occupied bandwidth function of the analyzer at 99% power was occupied. Then set the spectrum analyzer to cover the upper and lower band edges to

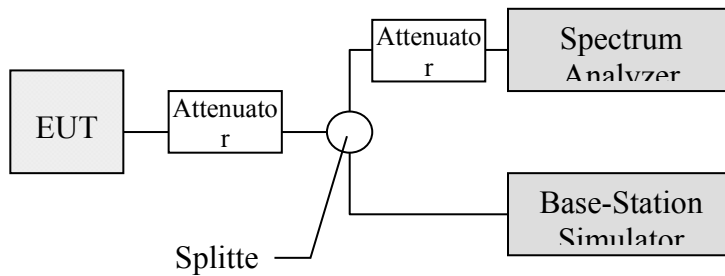

measure emission mask.





Report Number: W6M22006-20020-P-247  
 FCC ID: GX9CTC1052QT

**6.2 Test Results**

Test date: August 06, 2020  
 Temperature: 24.9 °C  
 Humidity: 48.2 %  
 Tester: Kent

**Occupied Channel Bandwidth**

WCDMA  
 Band II

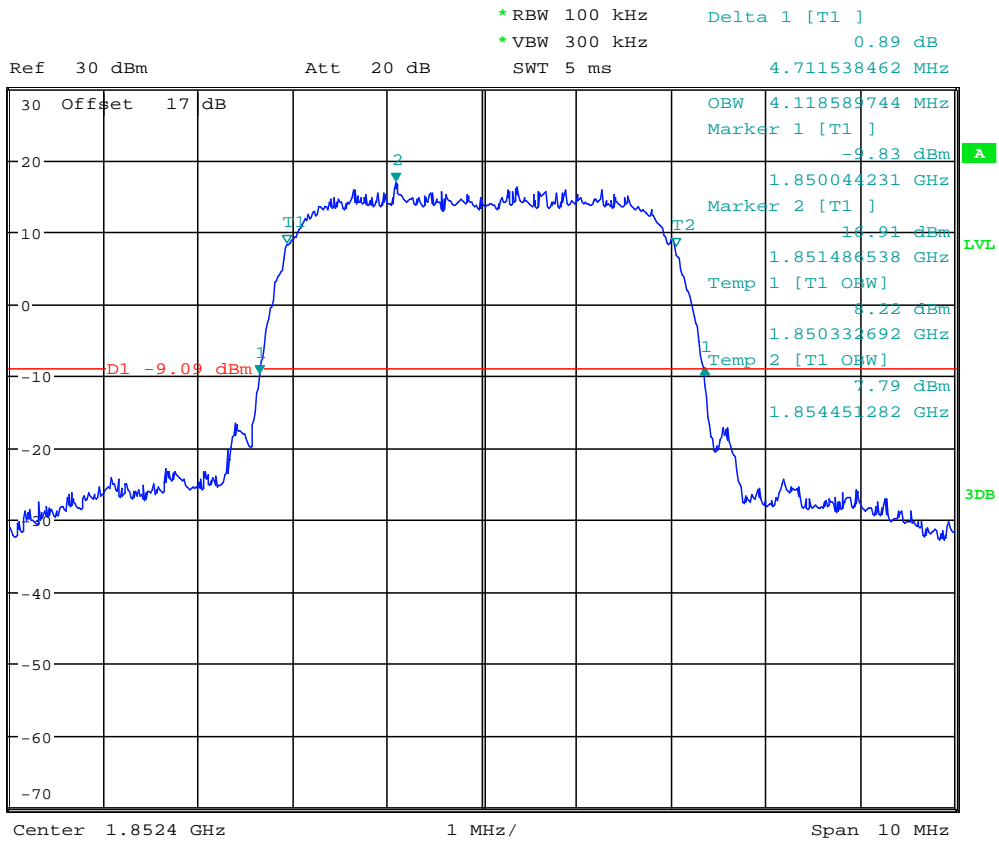

Date: 6.AUG.2020 16:10:07



Report Number: W6M22006-20020-P-247  
 FCC ID: GX9CTC1052QT

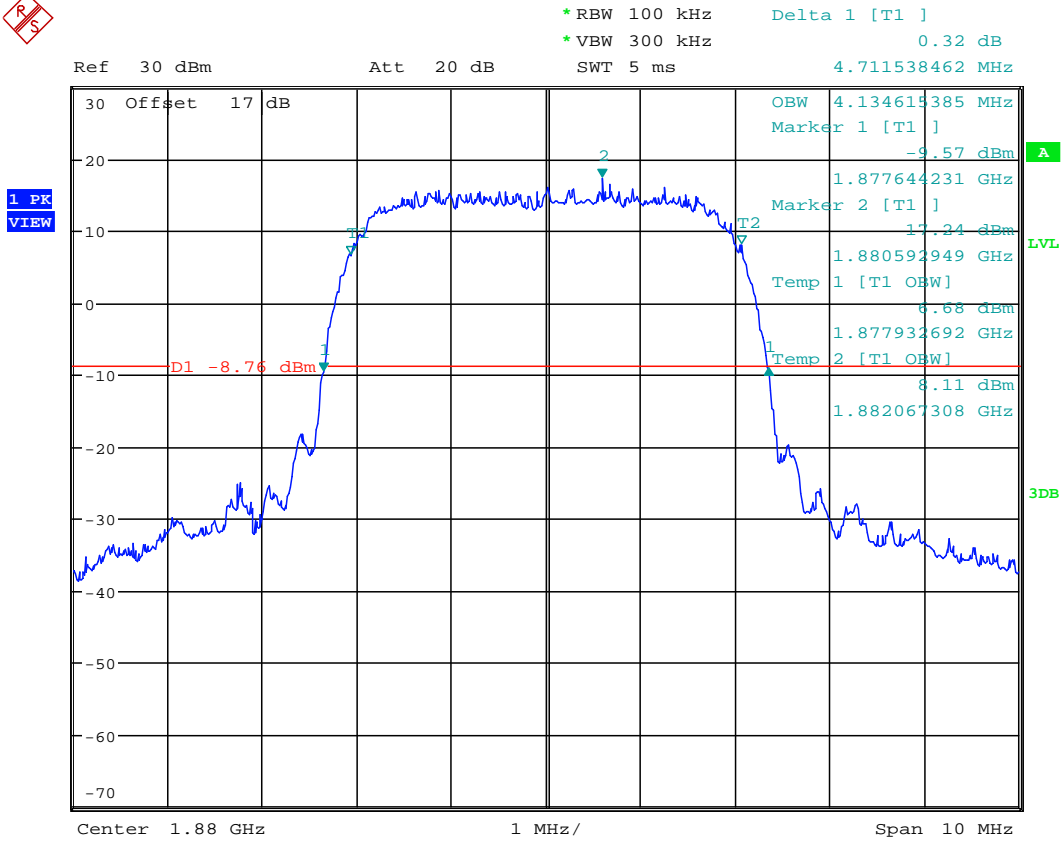

Date: 6.AUG.2020 16:11:06



Report Number: W6M22006-20020-P-247  
 FCC ID: GX9CTC1052QT

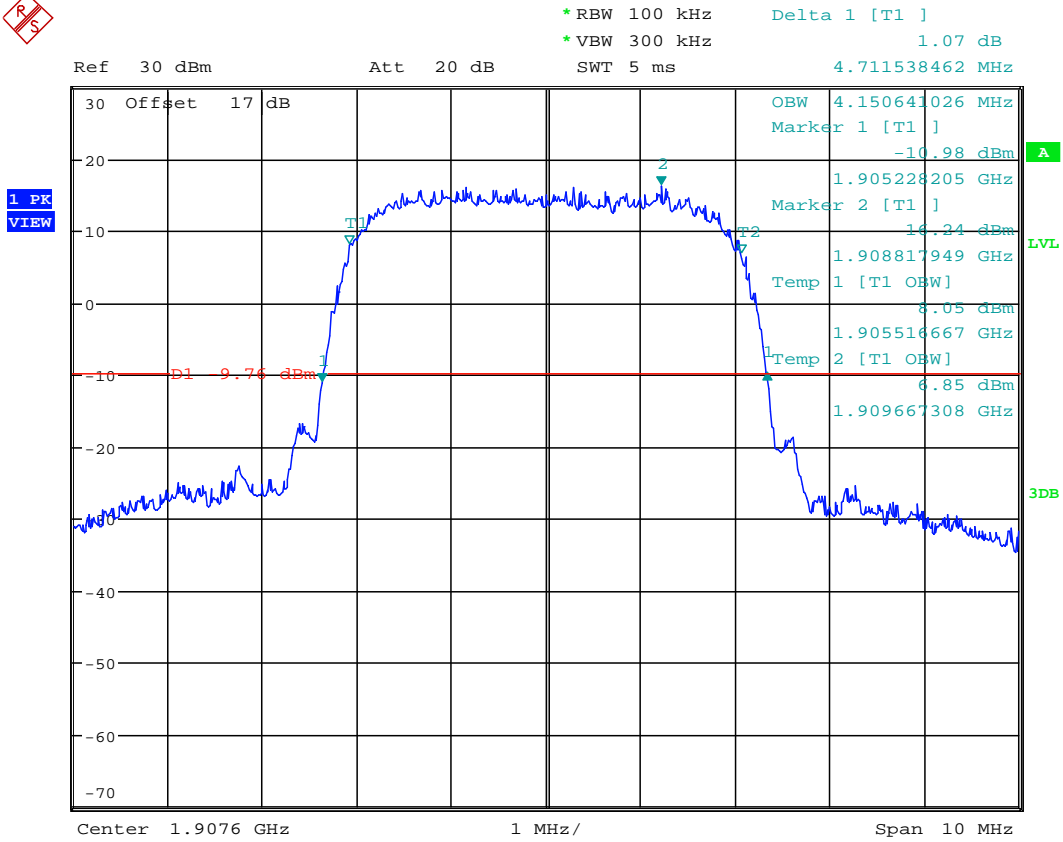

Date: 6.AUG.2020 16:12:11

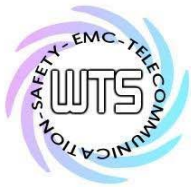

Report Number: W6M22006-20020-P-247

FCC ID: GX9CTC1052QT

Band IV

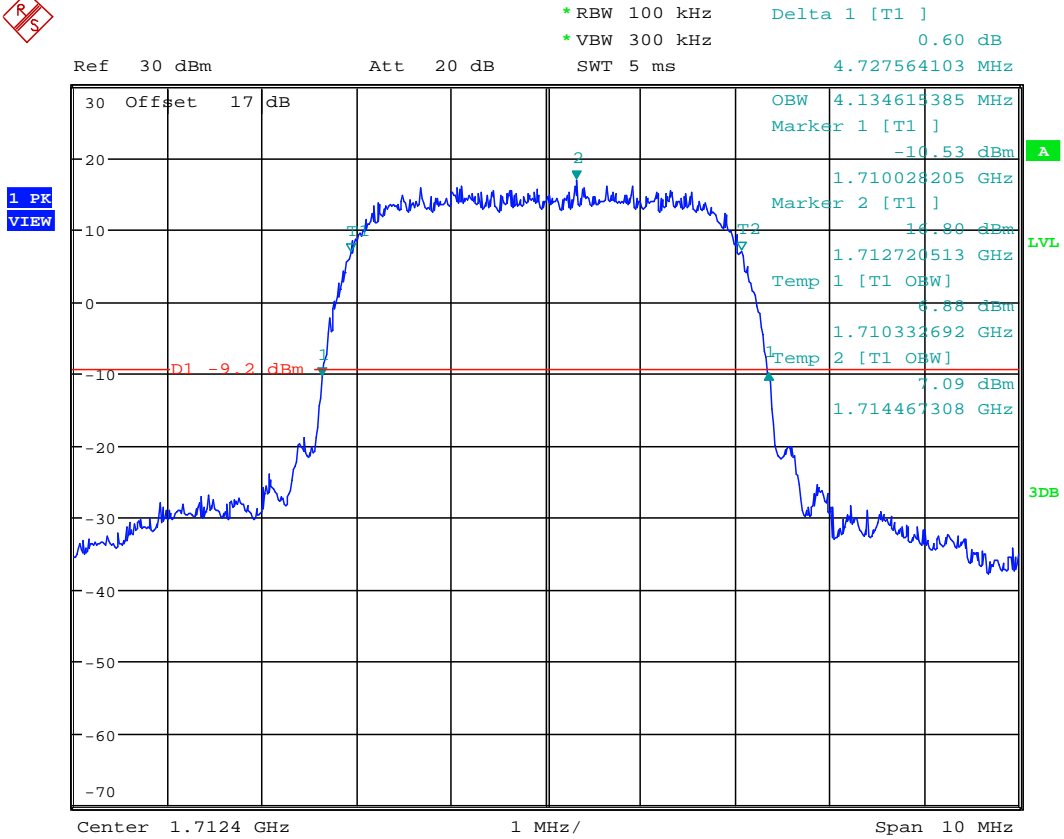

Date: 6.AUG.2020 16:13:30



Report Number: W6M22006-20020-P-247  
 FCC ID: GX9CTC1052QT

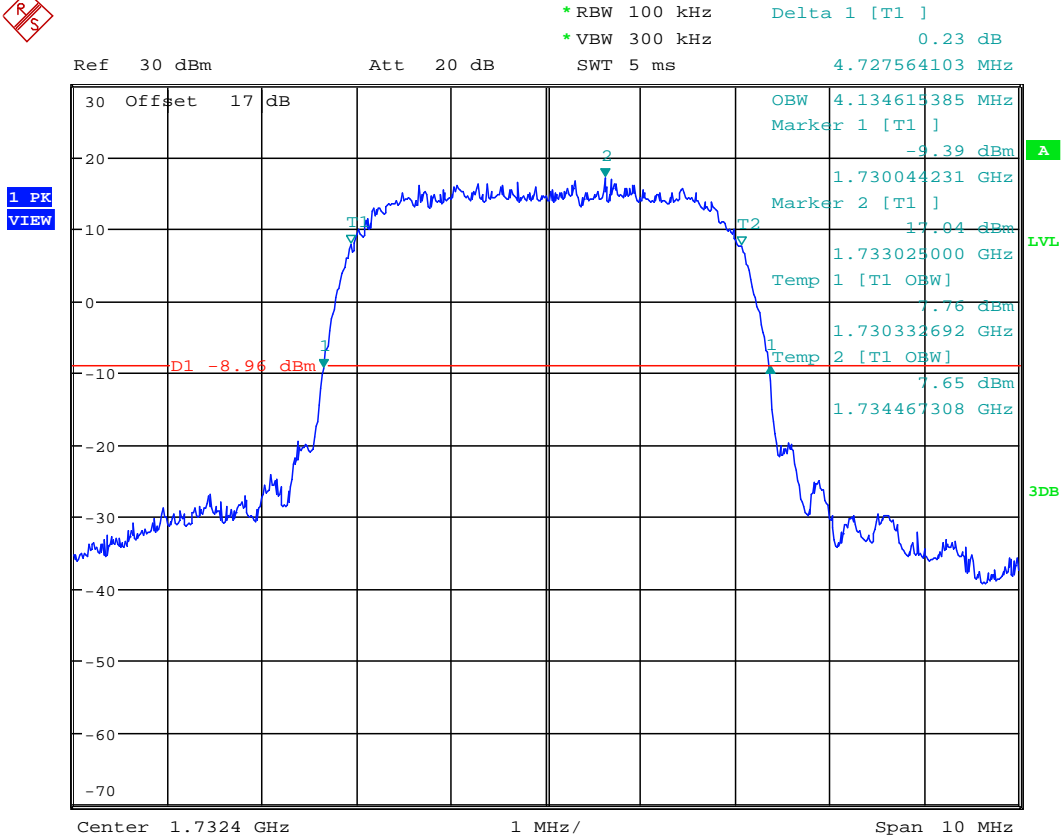

Date: 6.AUG.2020 16:14:27



Report Number: W6M22006-20020-P-247  
 FCC ID: GX9CTC1052QT

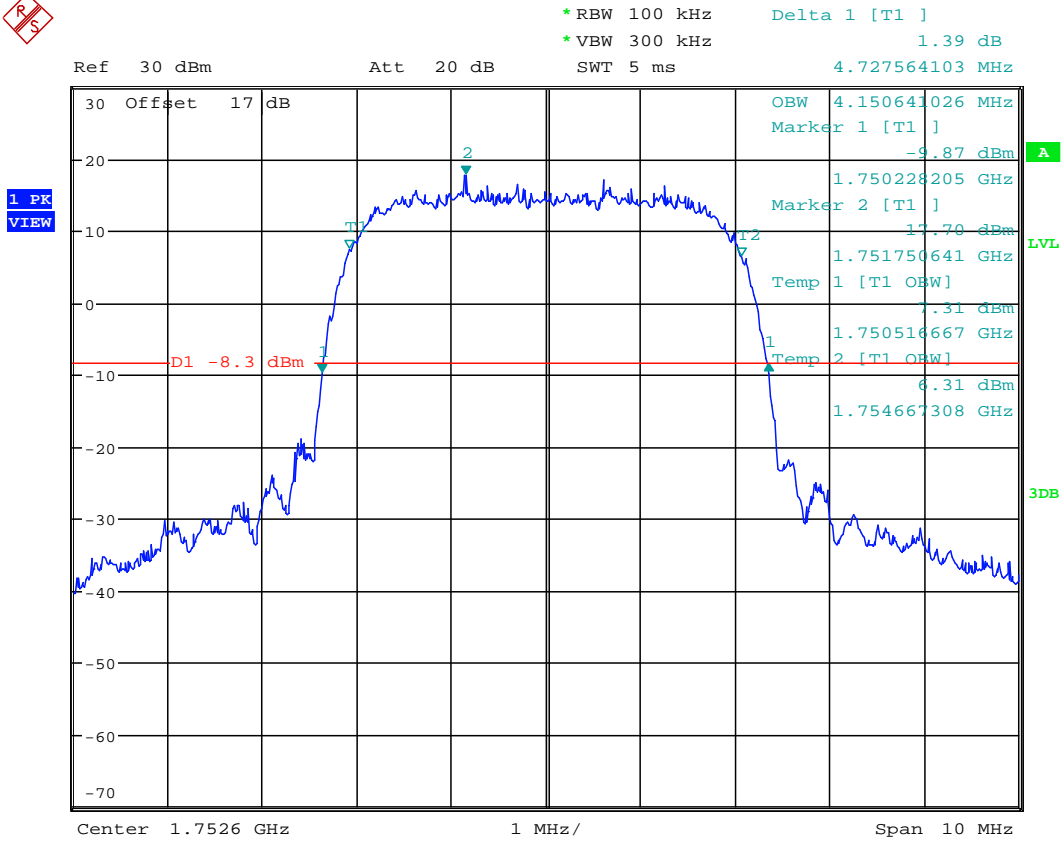

Date: 6.AUG.2020 16:15:27



# Worldwide Testing Services(Taiwan) Co., Ltd.

Report Number: W6M22006-20020-P-247

FCC ID: GX9CTC1052QT

Band V

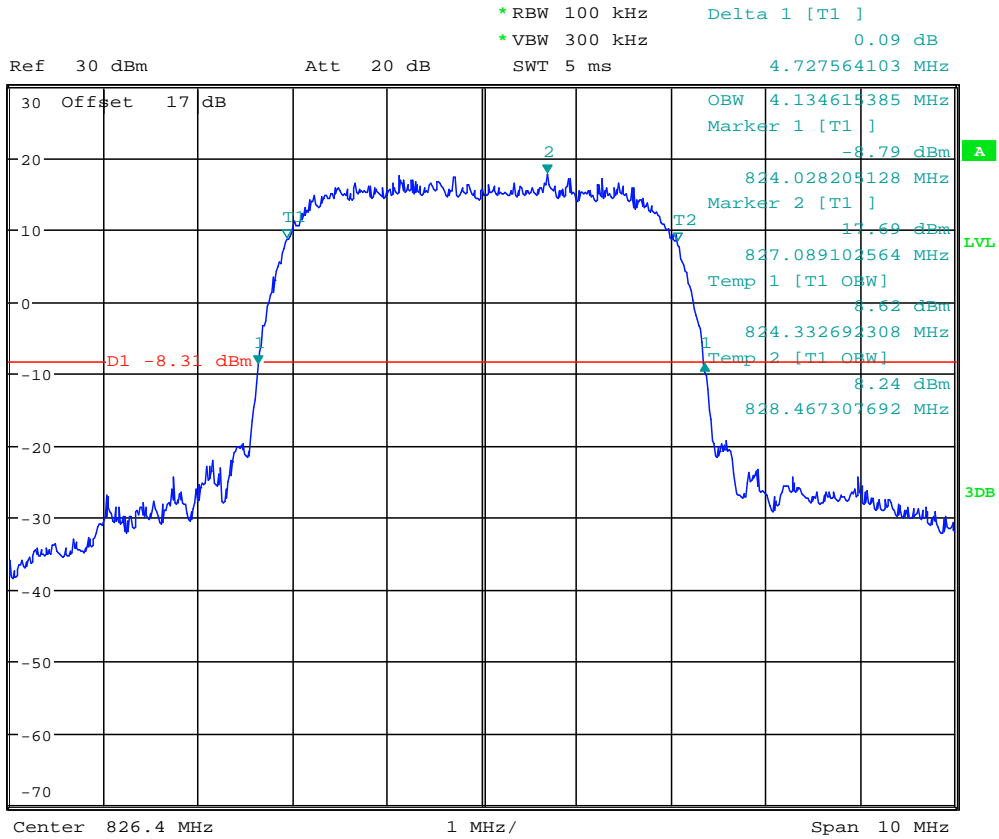

Date: 6.AUG.2020 16:16:22

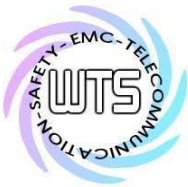

Report Number: W6M22006-20020-P-247  
 FCC ID: GX9CTC1052QT

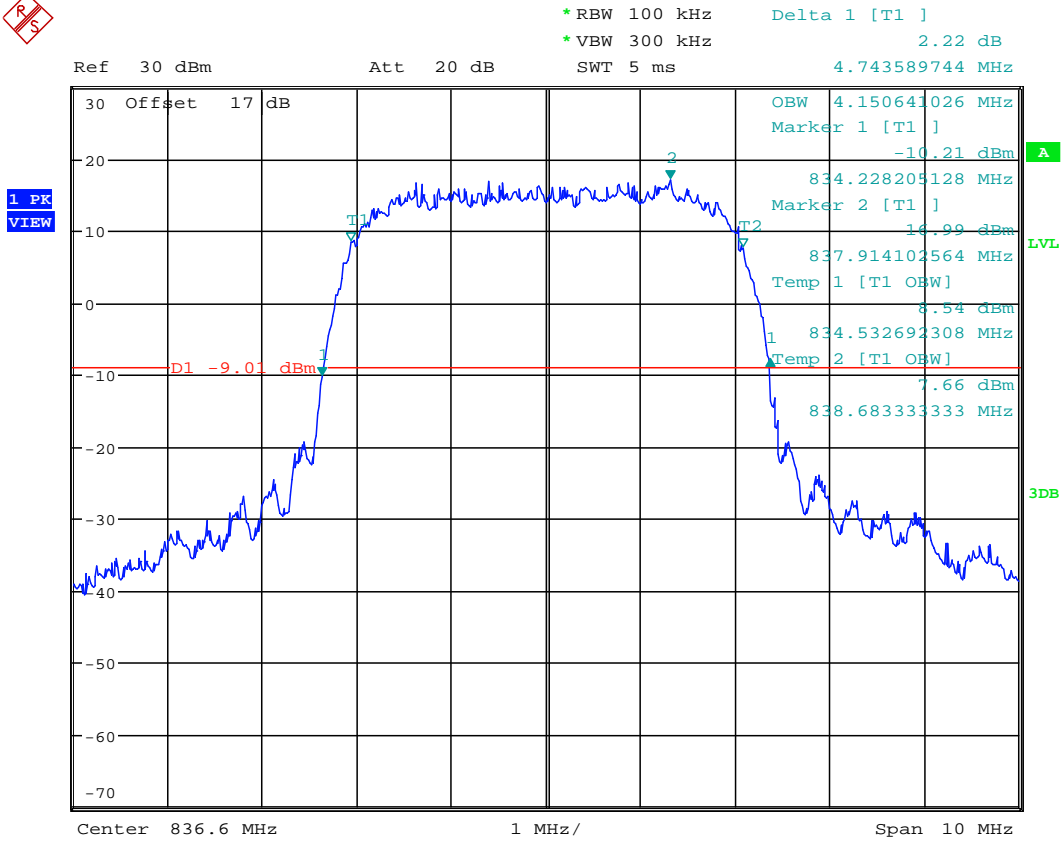

Date: 6.AUG.2020 16:17:24





Report Number: W6M22006-20020-P-247  
 FCC ID: GX9CTC1052QT

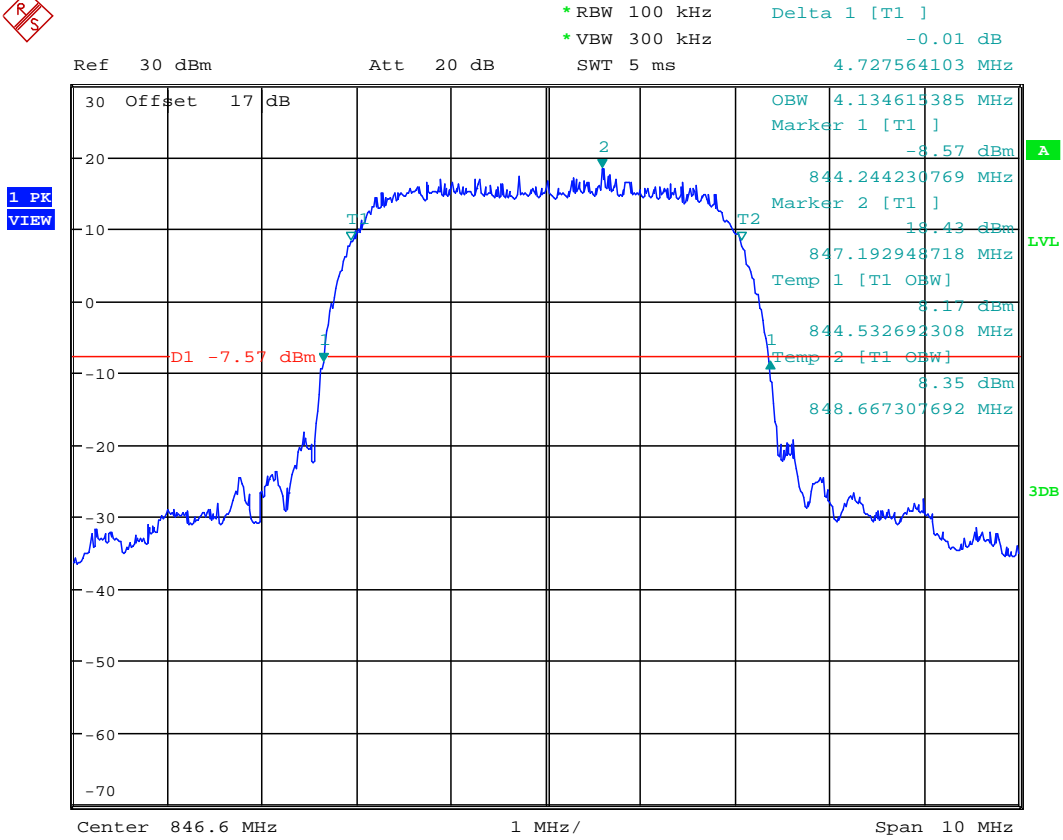

Date: 6.AUG.2020 16:18:21



# Worldwide Testing Services(Taiwan) Co., Ltd.

Report Number: W6M22006-20020-P-247  
 FCC ID: GX9CTC1052QT

LTE  
 Band II  
 QPSK  
 1.4MHz

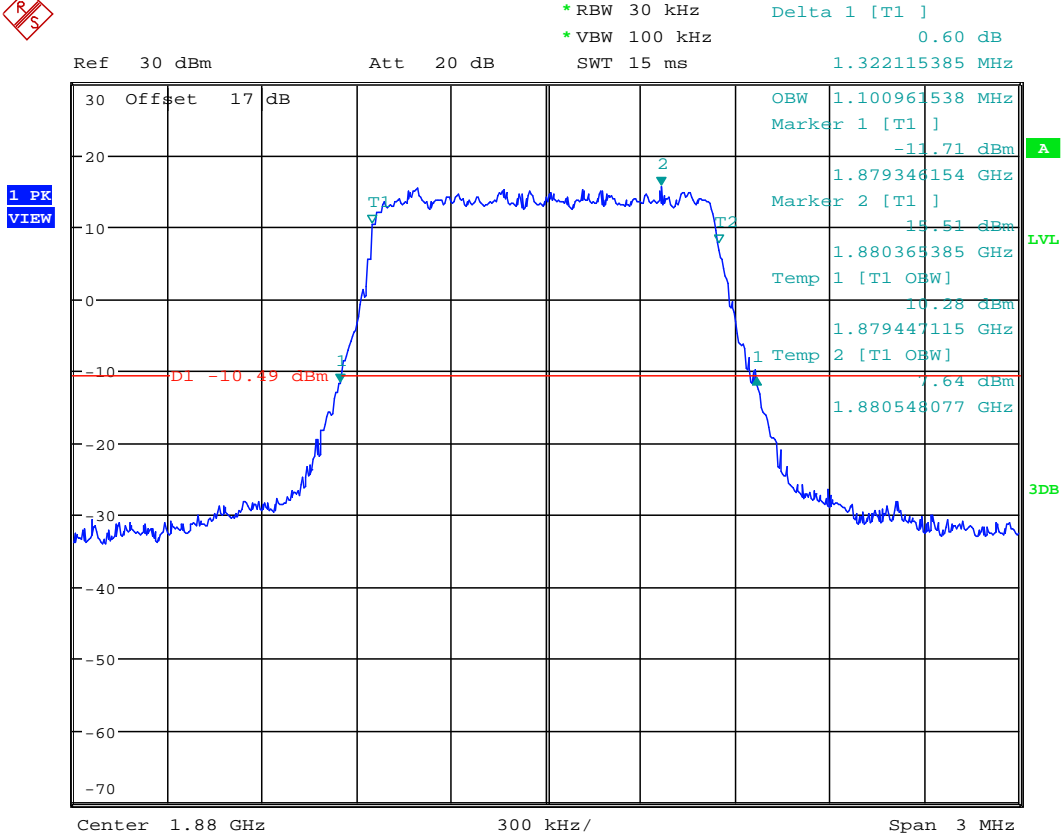

Date: 6.AUG.2020 16:30:34



# Worldwide Testing Services(Taiwan) Co., Ltd.

Report Number: W6M22006-20020-P-247

FCC ID: GX9CTC1052QT

3MHz

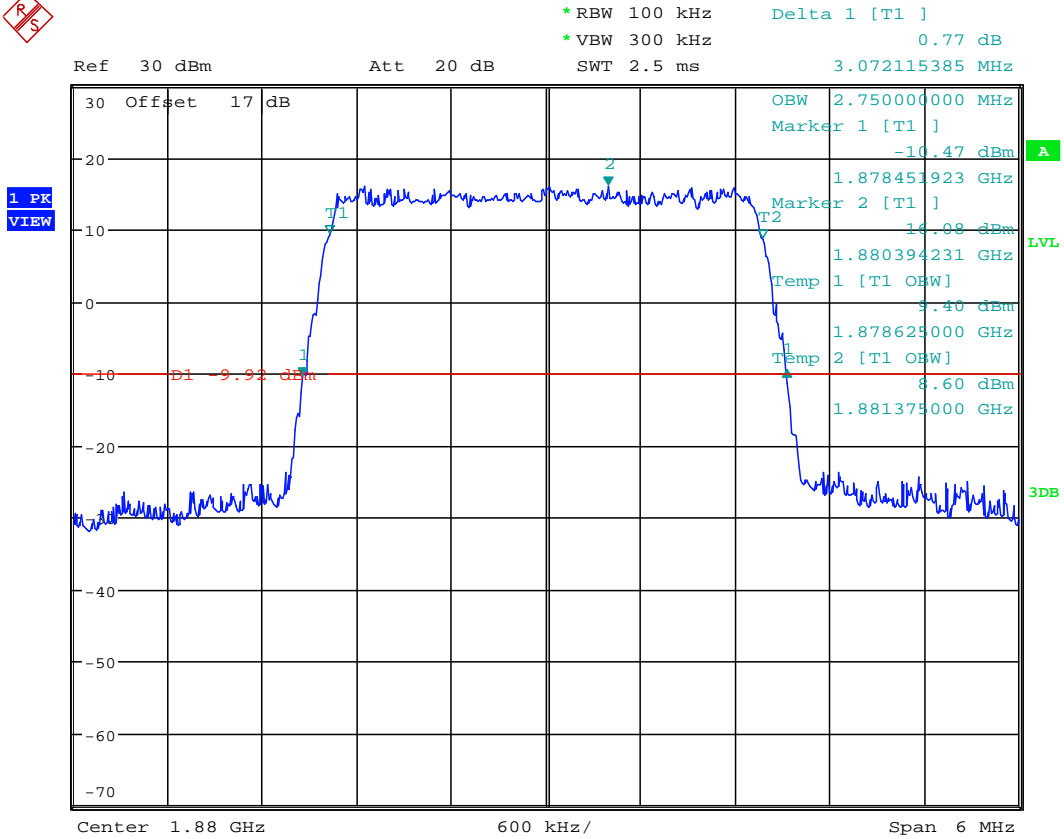

Date: 6.AUG.2020 16:32:02



Report Number: W6M22006-20020-P-247

FCC ID: GX9CTC1052QT

5MHz

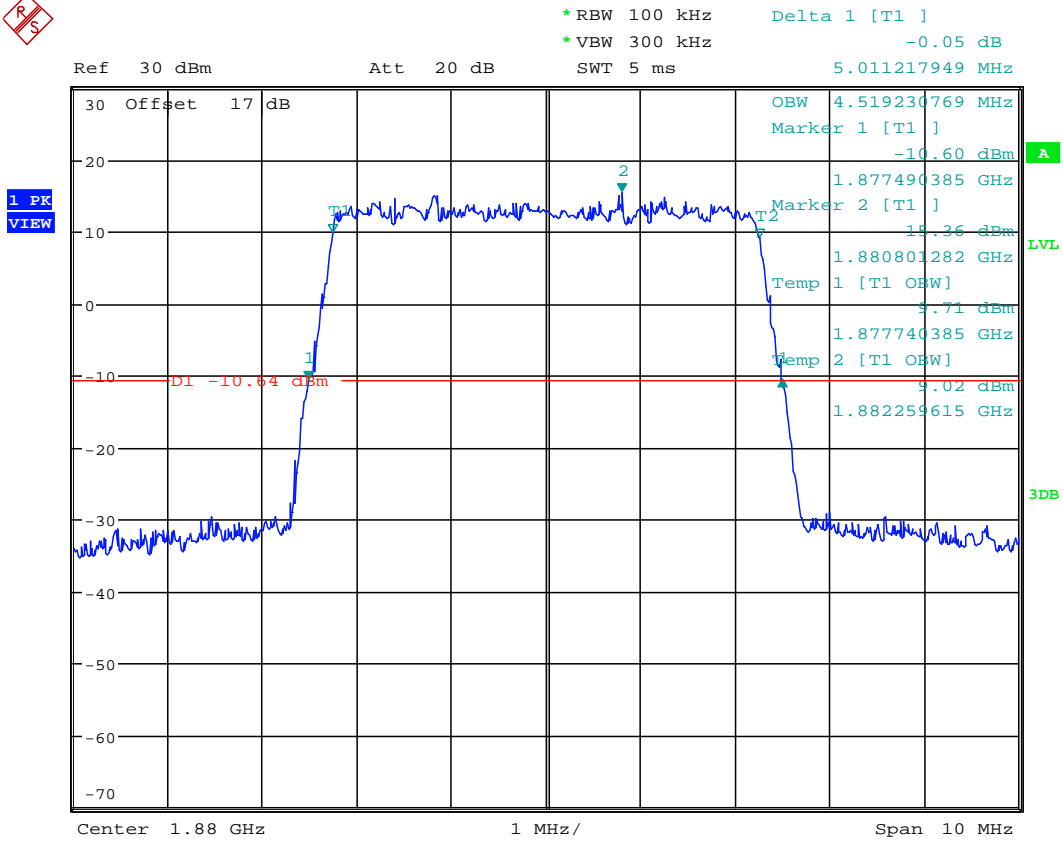

Date: 6.AUG.2020 16:33:22



# Worldwide Testing Services(Taiwan) Co., Ltd.

Report Number: W6M22006-20020-P-247

FCC ID: GX9CTC1052QT

10MHz

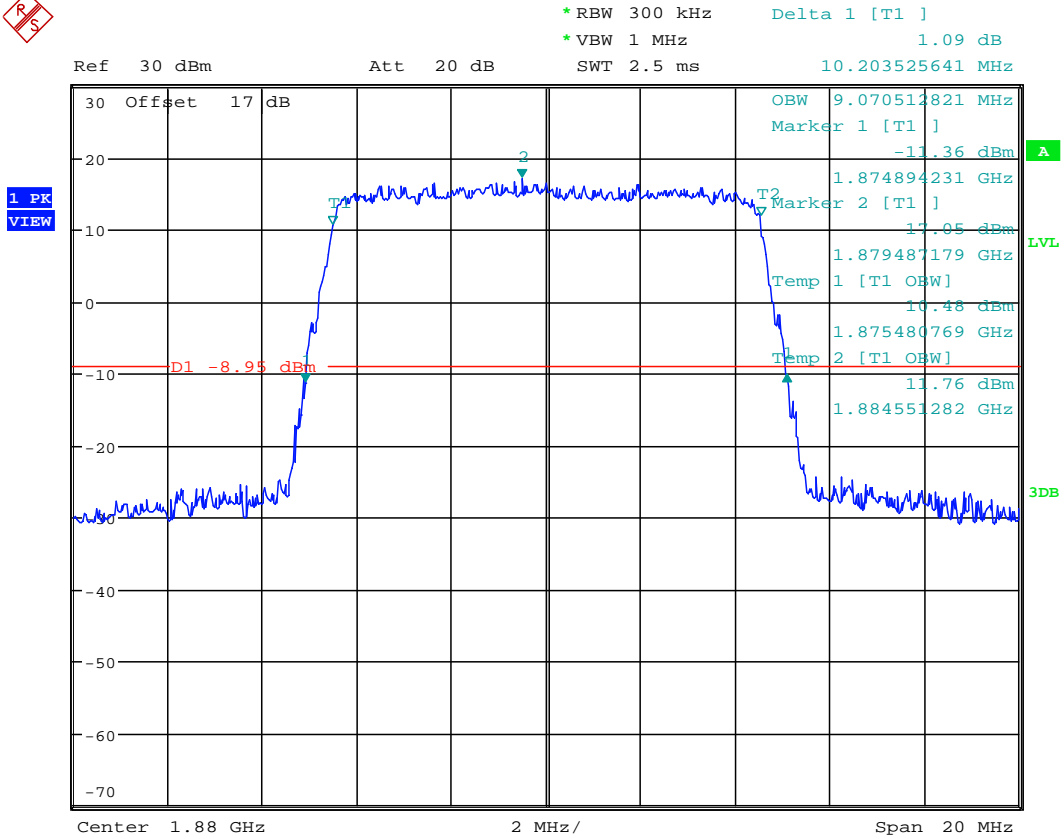

Date: 6.AUG.2020 16:34:32

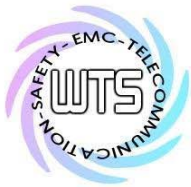

Report Number: W6M22006-20020-P-247

FCC ID: GX9CTC1052QT

15MHz

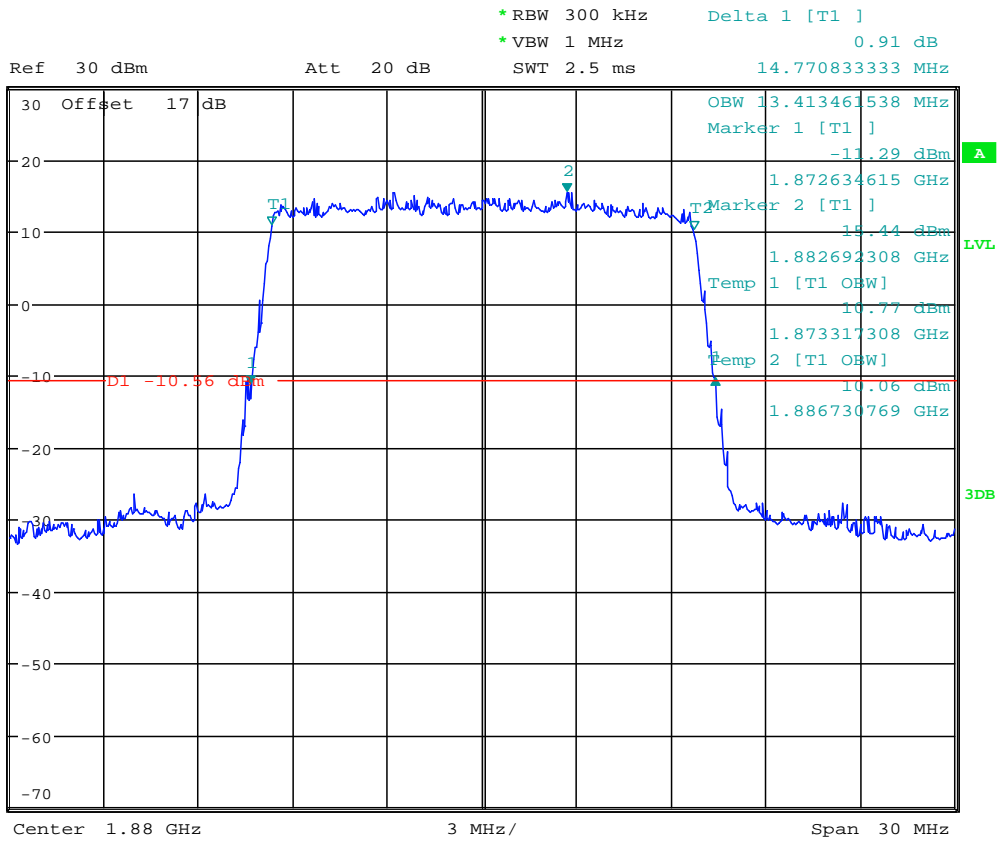

Date: 6.AUG.2020 16:35:40



# Worldwide Testing Services(Taiwan) Co., Ltd.

Report Number: W6M22006-20020-P-247

FCC ID: GX9CTC1052QT

20MHz

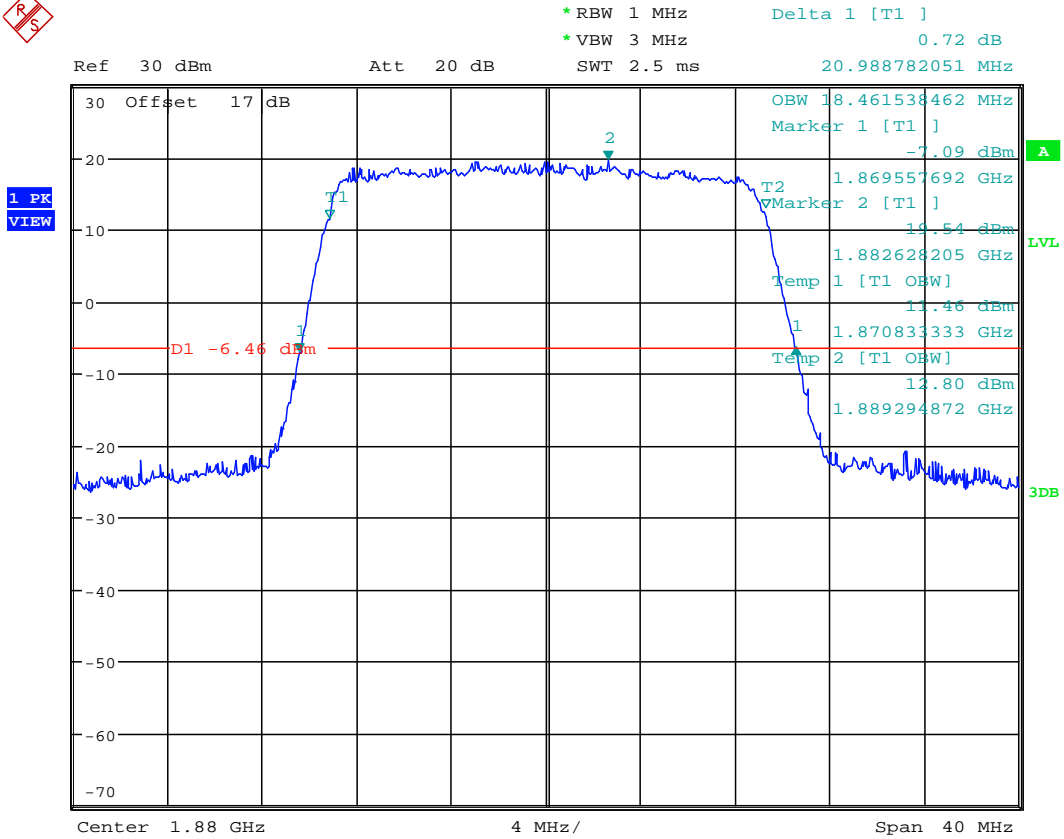

Date: 6.AUG.2020 16:36:42



# Worldwide Testing Services(Taiwan) Co., Ltd.

Report Number: W6M22006-20020-P-247  
 FCC ID: GX9CTC1052QT

Band IV  
 QPSK  
 1.4MHz

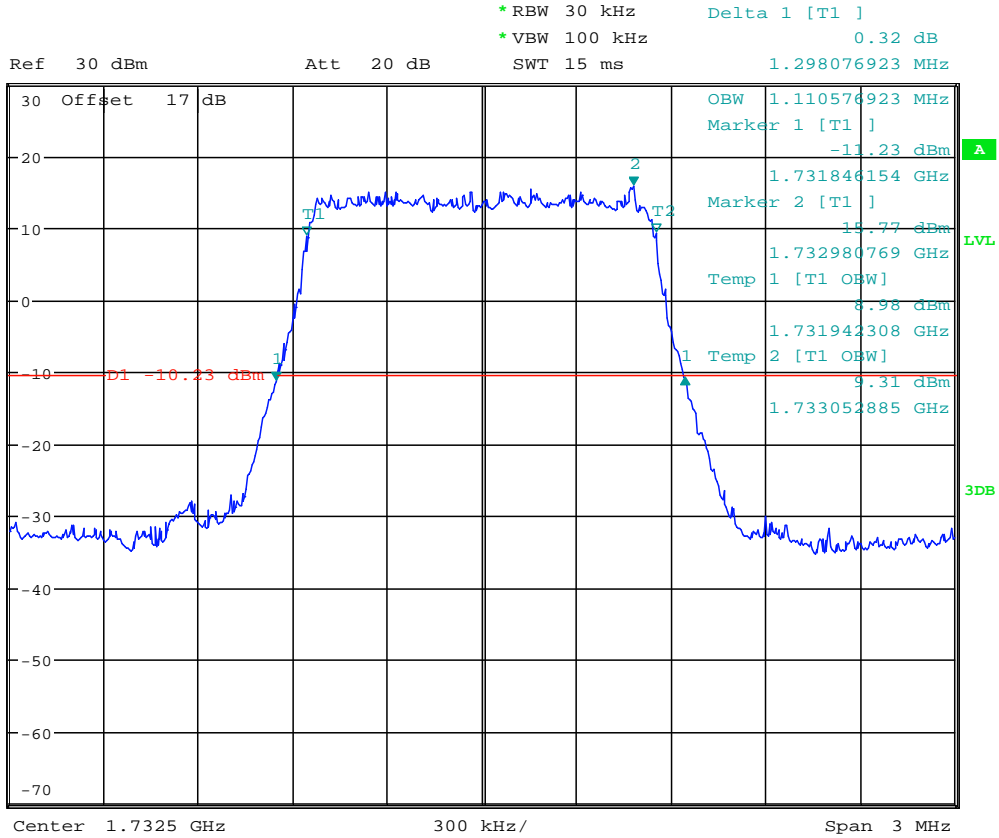

Date: 6.AUG.2020 16:38:50



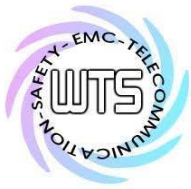

Report Number: W6M22006-20020-P-247

FCC ID: GX9CTC1052QT

3MHz

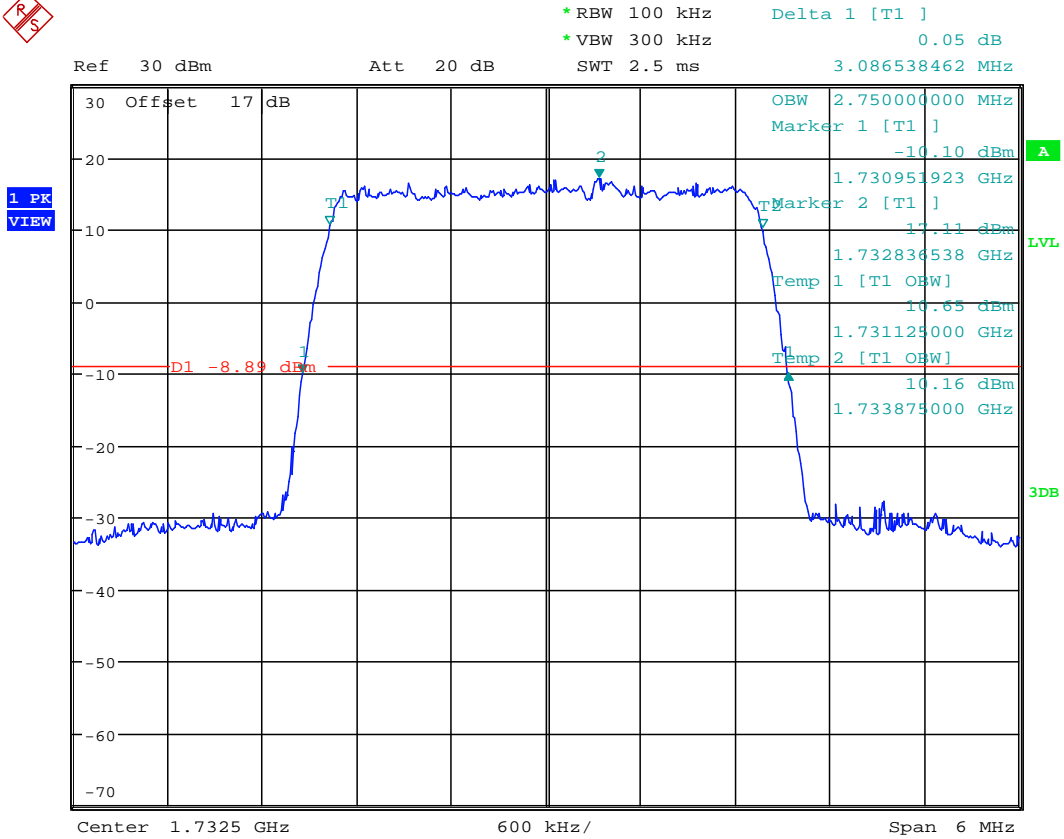

Date: 6.AUG.2020 16:40:27



# Worldwide Testing Services(Taiwan) Co., Ltd.

Report Number: W6M22006-20020-P-247

FCC ID: GX9CTC1052QT

5MHz

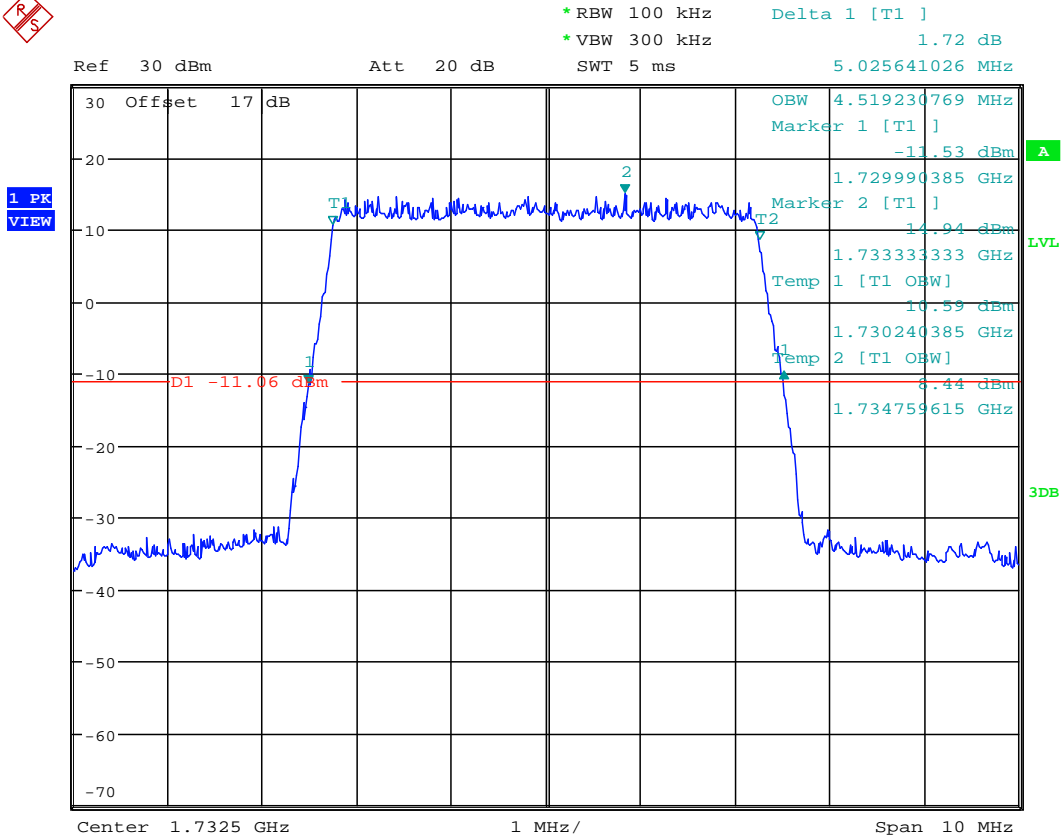

Date: 6.AUG.2020 16:41:26

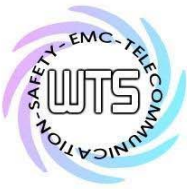

# Worldwide Testing Services(Taiwan) Co., Ltd.

Report Number: W6M22006-20020-P-247

FCC ID: GX9CTC1052QT

10MHz



\*RBW 300 kHz Delta 1 [T1 ]  
\*VBW 1 MHz 1.82 dB  
SWT 2.5 ms 10.185897436 MHz

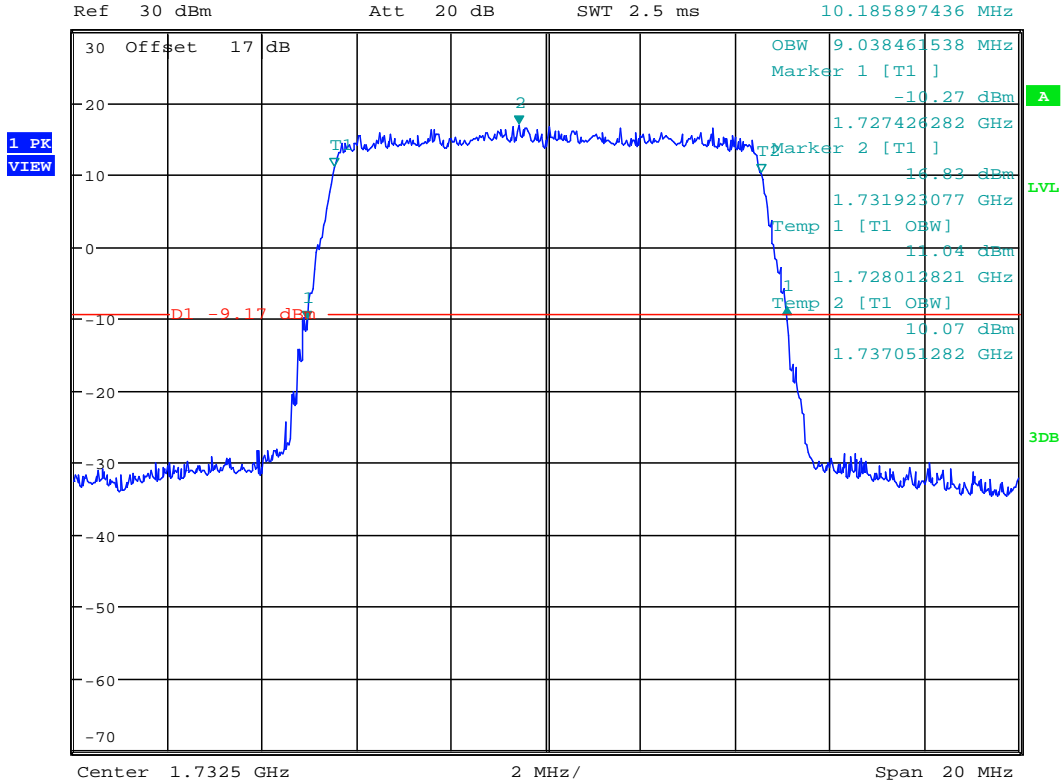

Date: 6.AUG.2020 16:42:33



Report Number: W6M22006-20020-P-247

FCC ID: GX9CTC1052QT

15MHz

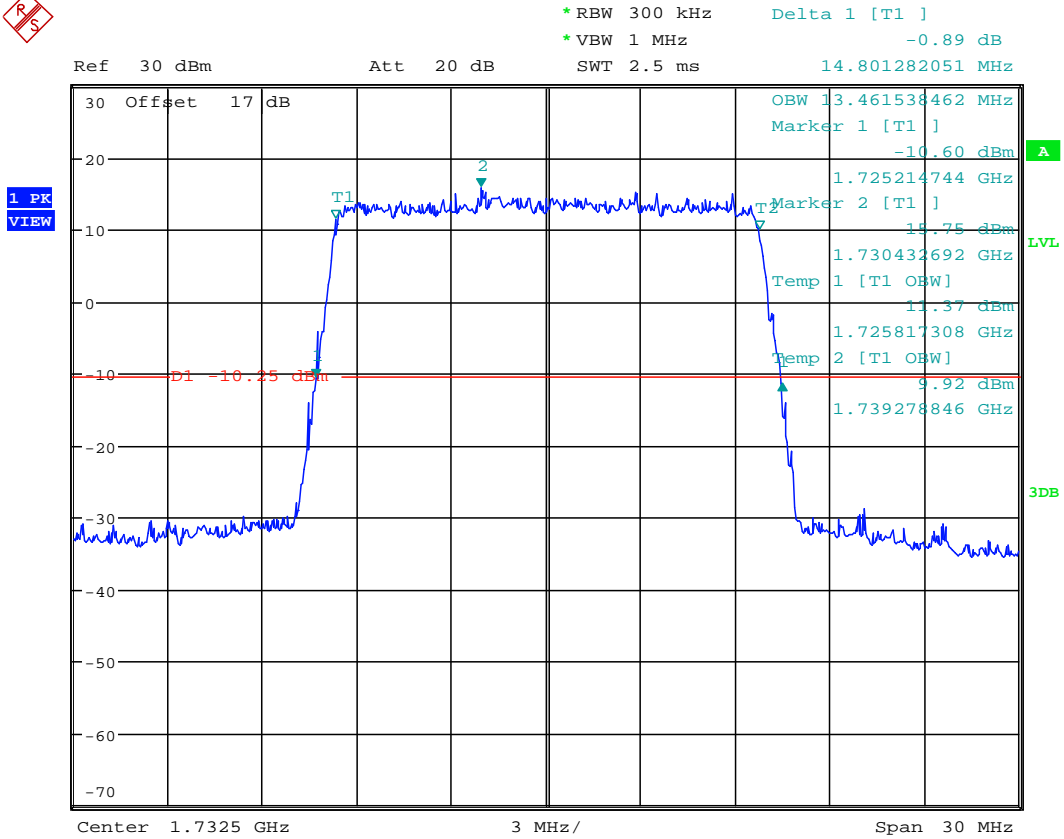

Date: 6.AUG.2020 16:43:32

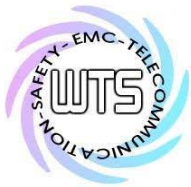

Report Number: W6M22006-20020-P-247

FCC ID: GX9CTC1052QT

20MHz

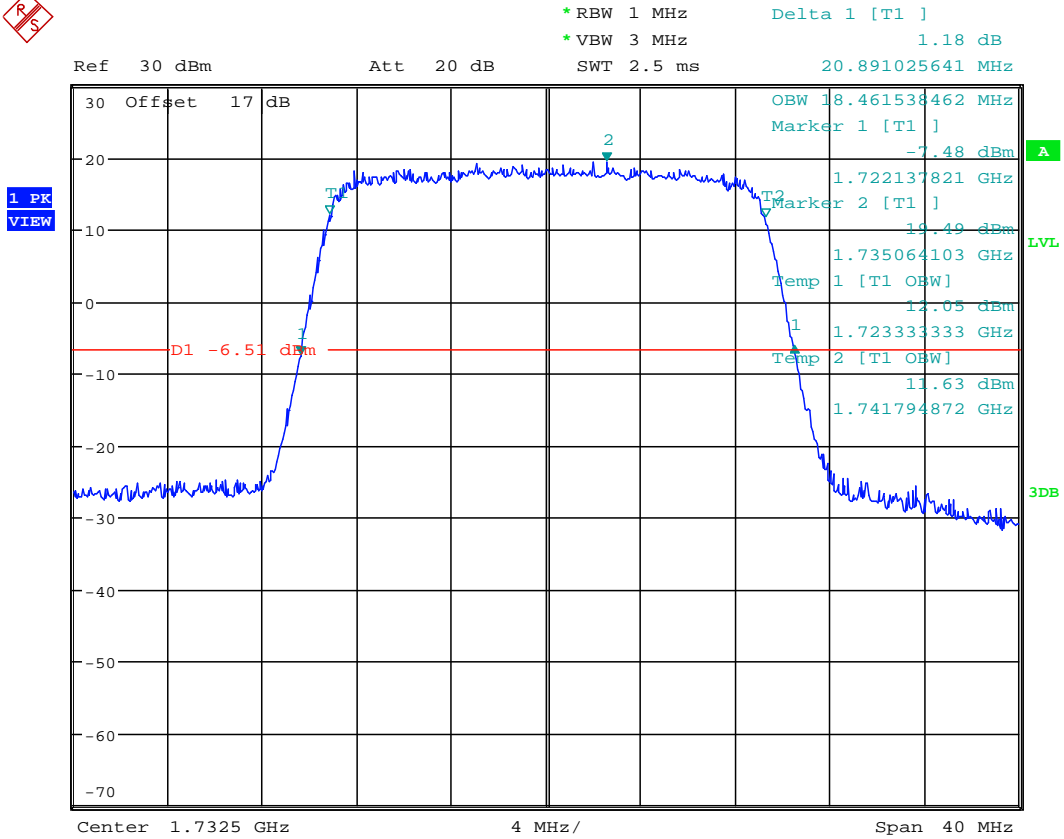

Date: 6.AUG.2020 16:44:26



# Worldwide Testing Services(Taiwan) Co., Ltd.

Report Number: W6M22006-20020-P-247  
 FCC ID: GX9CTC1052QT

Band V  
 QPSK  
 1.4MHz

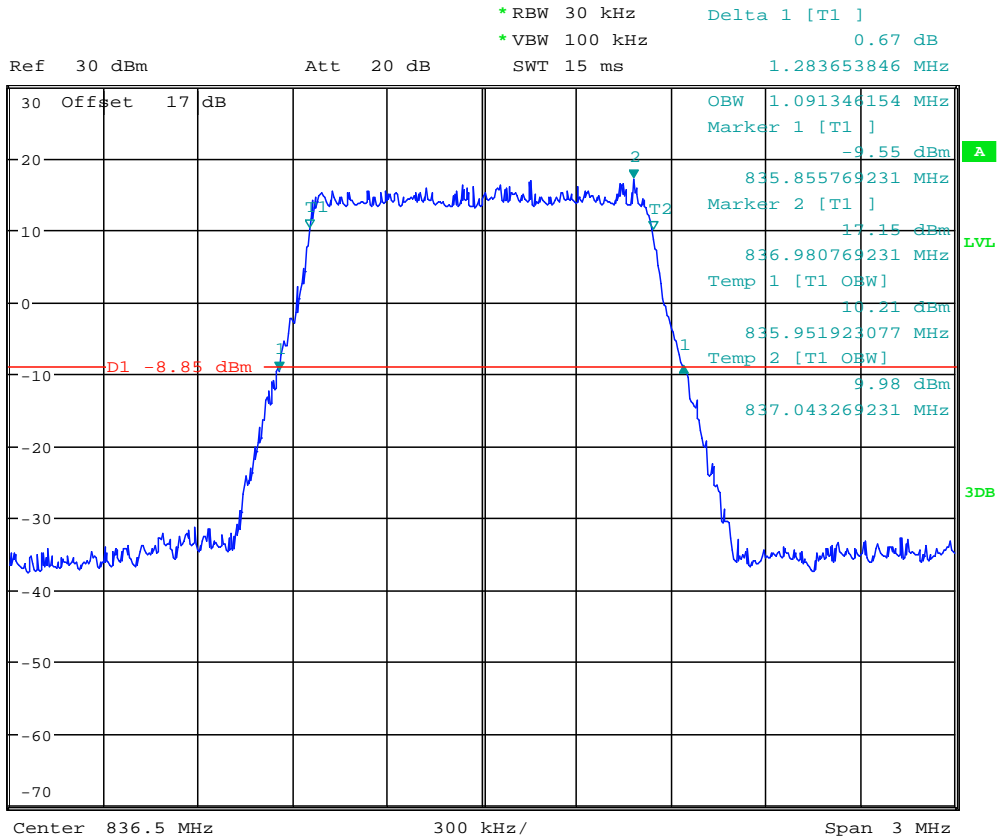

Date: 6.AUG.2020 16:46:17

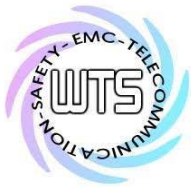

Report Number: W6M22006-20020-P-247

FCC ID: GX9CTC1052QT

3MHz

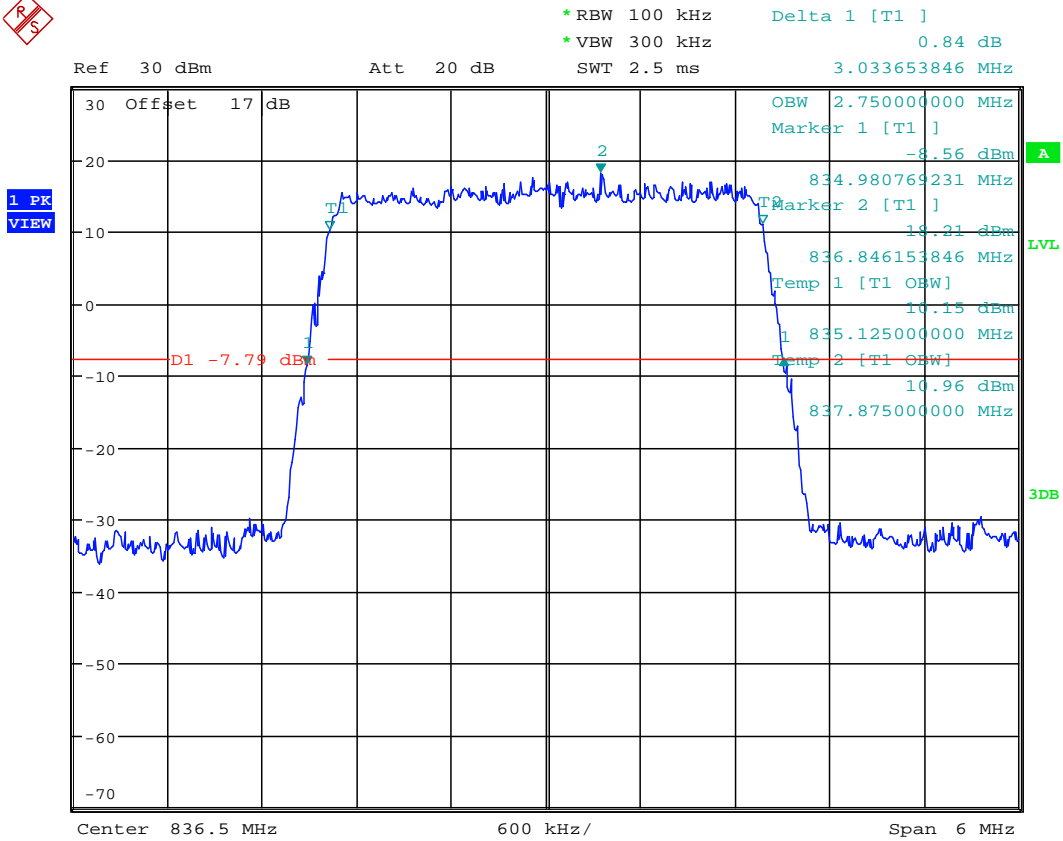

Date: 6.AUG.2020 16:47:19



# Worldwide Testing Services(Taiwan) Co., Ltd.

Report Number: W6M22006-20020-P-247

FCC ID: GX9CTC1052QT

5MHz

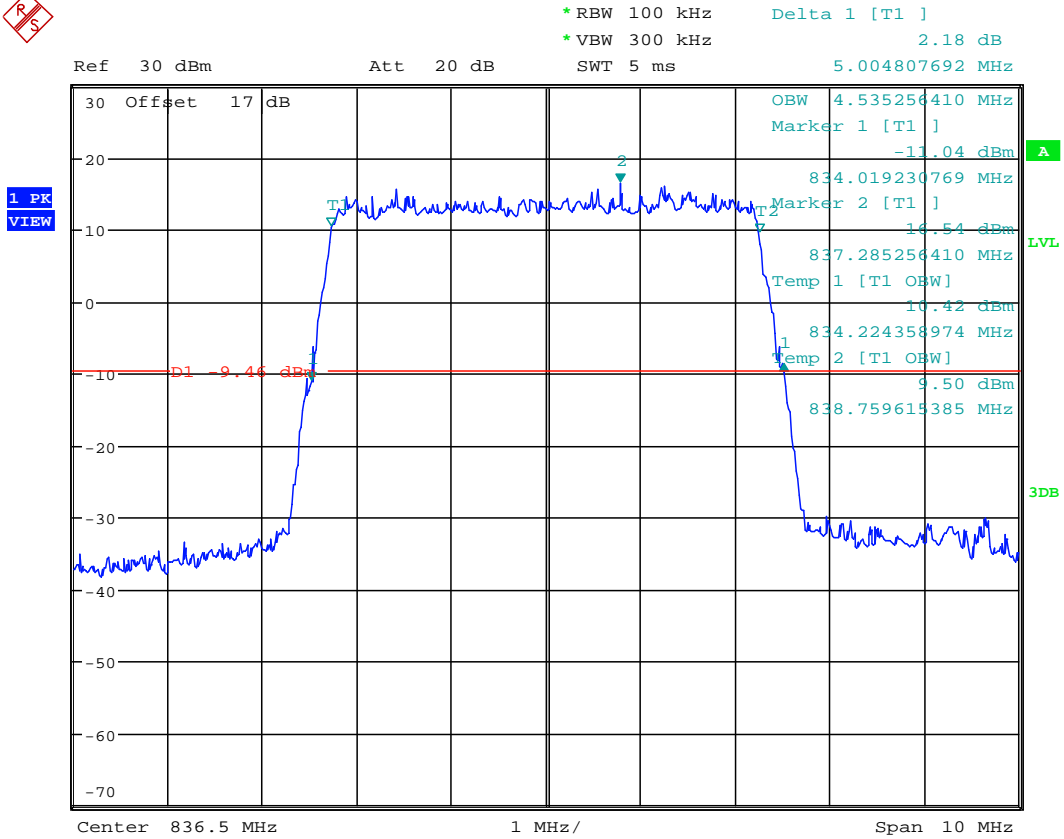

Date: 6.AUG.2020 16:48:38





# Worldwide Testing Services(Taiwan) Co., Ltd.

Report Number: W6M22006-20020-P-247

FCC ID: GX9CTC1052QT

10MHz

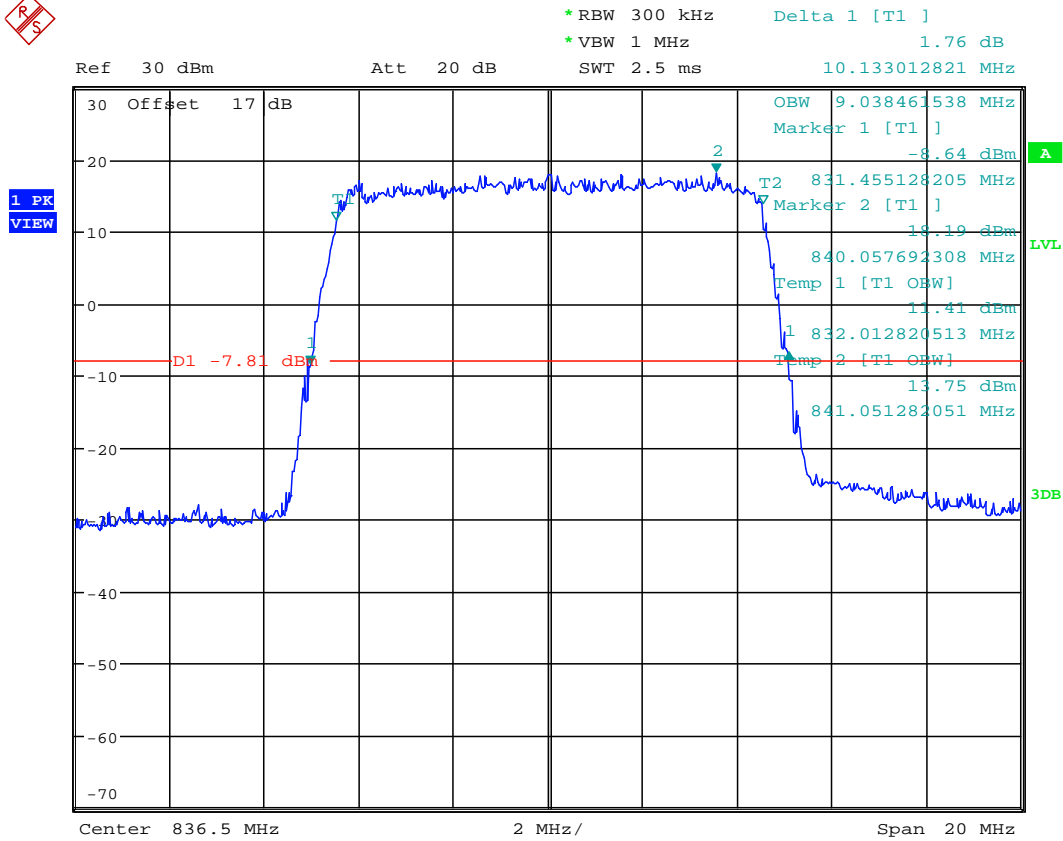

Date: 6.AUG.2020 16:49:43



# Worldwide Testing Services(Taiwan) Co., Ltd.

Report Number: W6M22006-20020-P-247

FCC ID: GX9CTC1052QT

Band XII

QPSK

1.4MHz

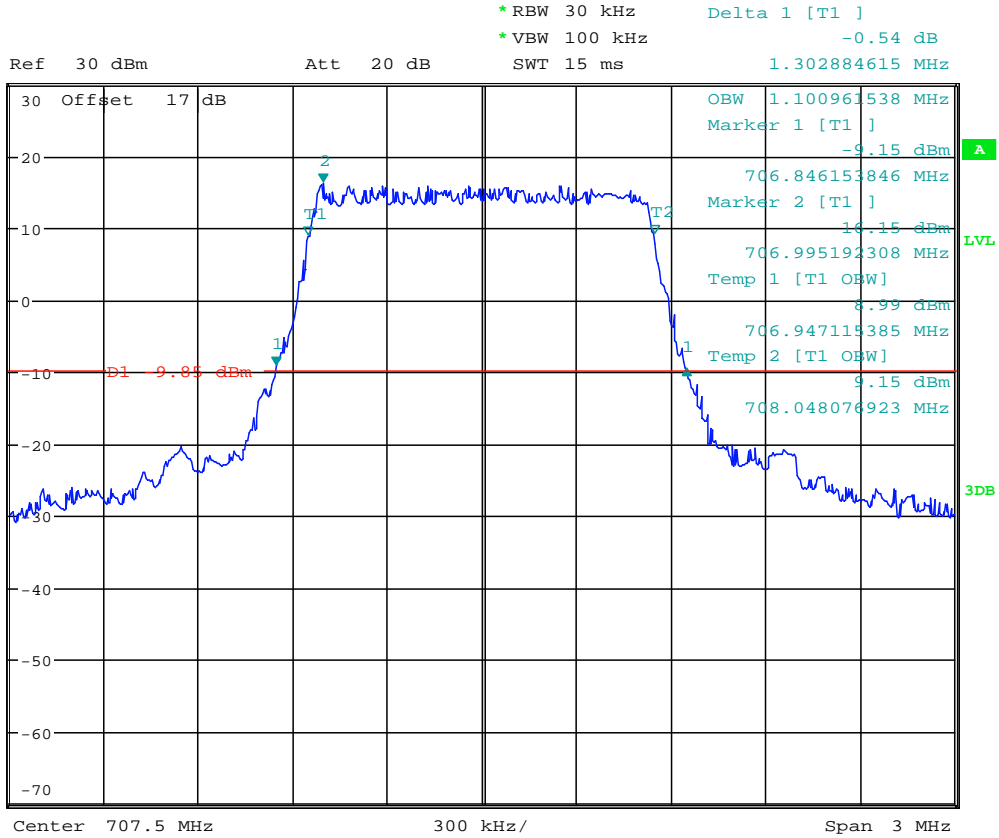

Date: 6.AUG.2020 16:51:26



# Worldwide Testing Services(Taiwan) Co., Ltd.

Report Number: W6M22006-20020-P-247

FCC ID: GX9CTC1052QT

3MHz

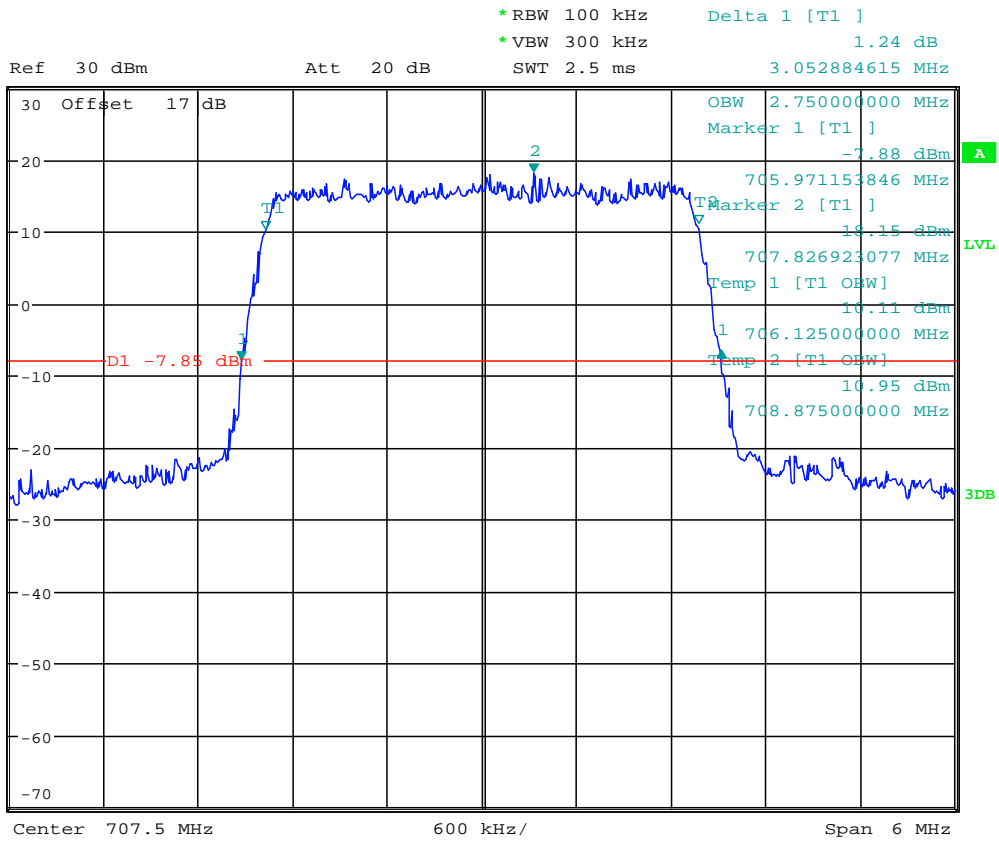

Date: 6.AUG.2020 16:52:24



# Worldwide Testing Services(Taiwan) Co., Ltd.

Report Number: W6M22006-20020-P-247

FCC ID: GX9CTC1052QT

5MHz

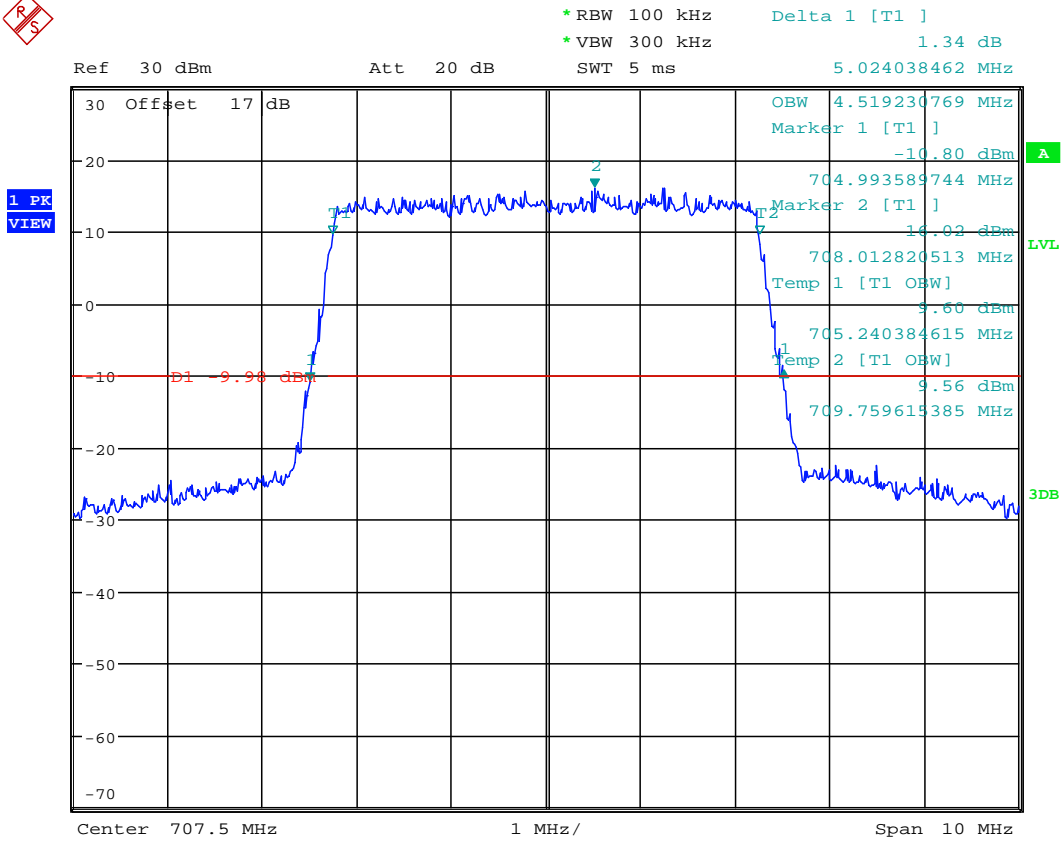

Date: 6.AUG.2020 16:53:30



Report Number: W6M22006-20020-P-247

FCC ID: GX9CTC1052QT

10MHz

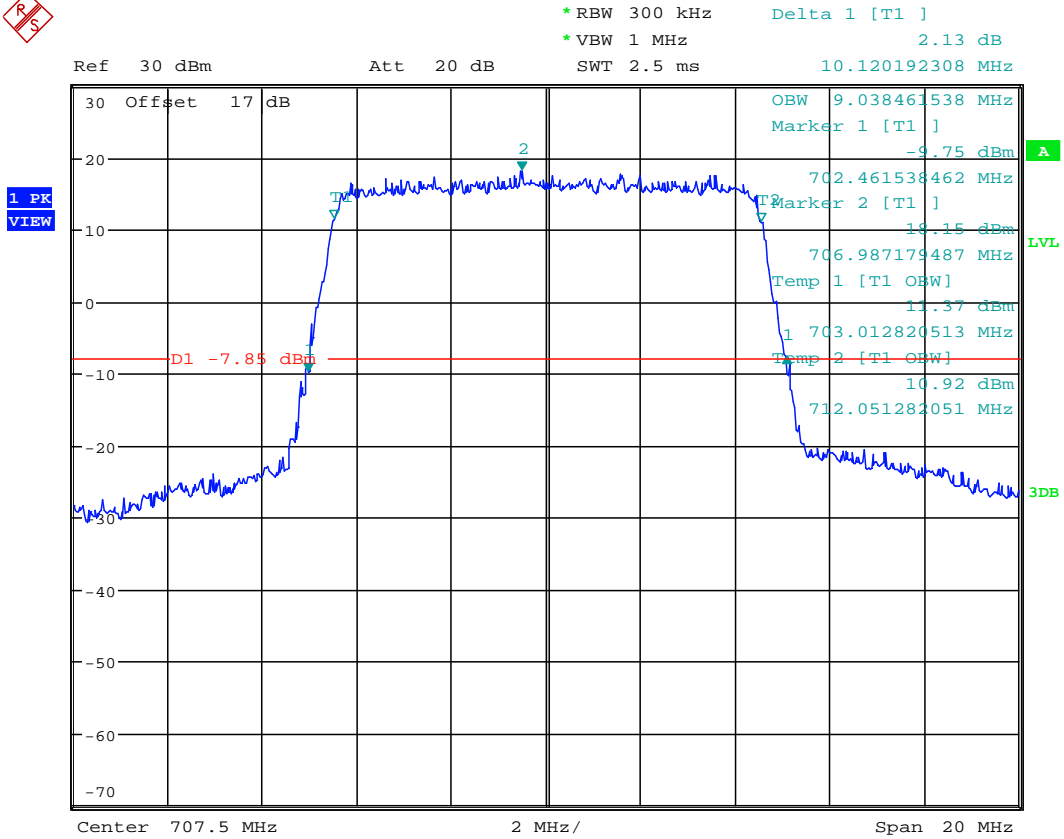

Date: 6.AUG.2020 16:54:35



# Worldwide Testing Services(Taiwan) Co., Ltd.

Report Number: W6M22006-20020-P-247

FCC ID: GX9CTC1052QT

Band XIII

QPSK

5MHz

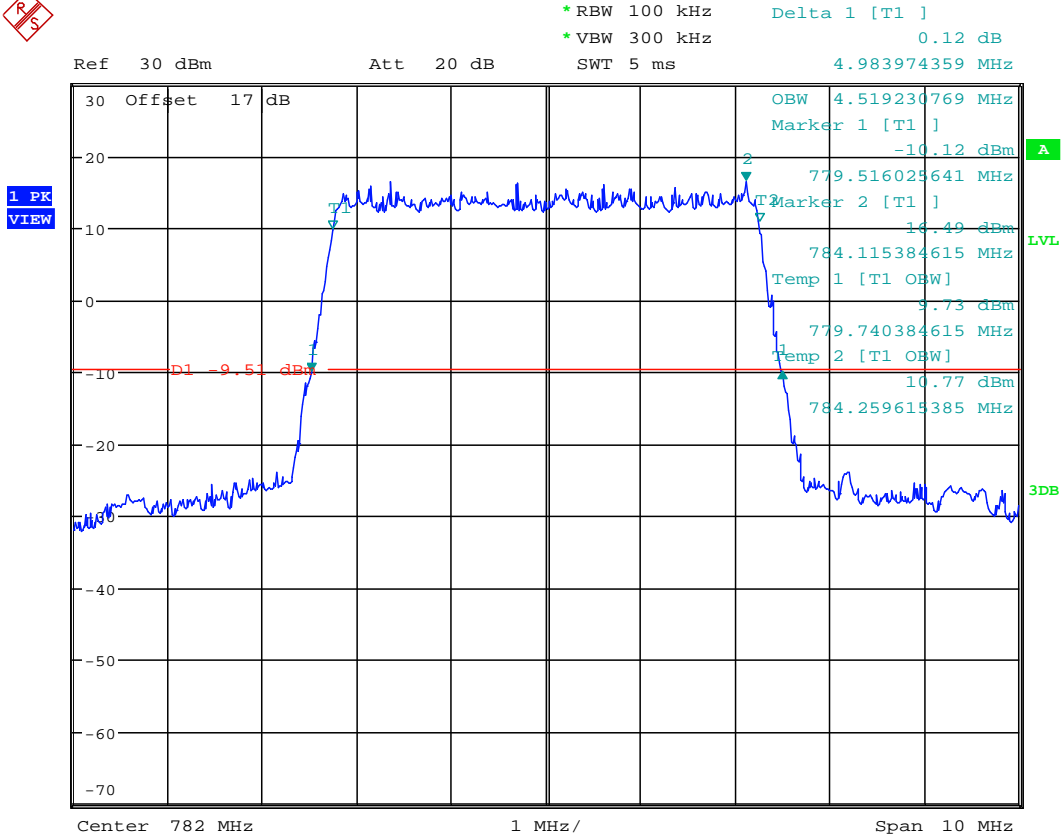

Date: 6.AUG.2020 16:57:32



Report Number: W6M22006-20020-P-247

FCC ID: GX9CTC1052QT

10MHz

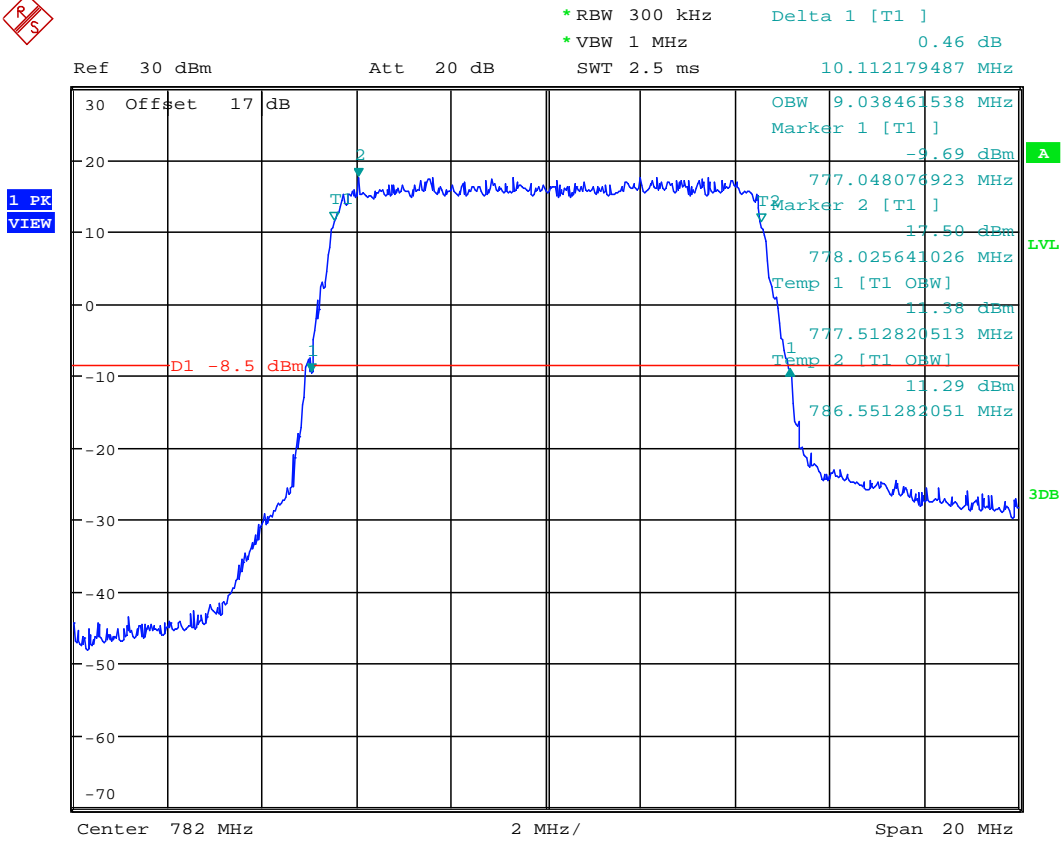

Date: 6.AUG.2020 16:58:28

Test equipment: ETSTW-RE 055, ETSTW-GSM 002, ETSTW-GSM 023, ETSTW-GSM 004

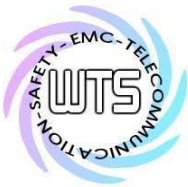

Report Number: W6M22006-20020-P-247

FCC ID: GX9CTC1052QT

## 7. Spurious Emissions at Antenna Terminals

### 7.1 Test procedure

This transmitter output was connected to a calibrated coaxial attenuator, the other end of which was connected to a spectrum analyzer via a three-port splitter. Please refer to the following figure. Transmitter output was derived with the spectrum analyzer in dBm.

The Spurious Emissions at Antenna Terminals was measured by the spectrum analyzer with a suitable notch filter and/or Band-pass filter.

Tests were performed with an unmodulated carrier at three frequencies (low, middle and high channels ) and on all power levels , which can be set-up on the transmitters.

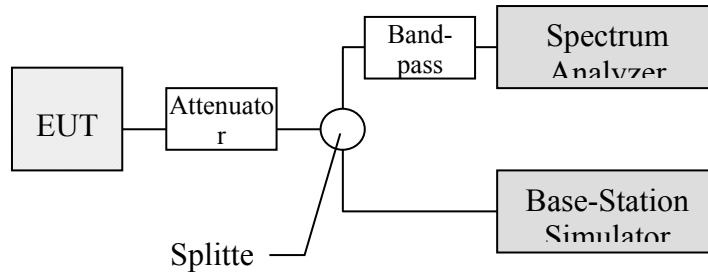

### 7.2 Test Results

Test date: August 11, 2020-August 12, 2020

Temperature: 23.2 °C

Humidity: 48.5 %

Tester: Kent

WCDMA

Band II

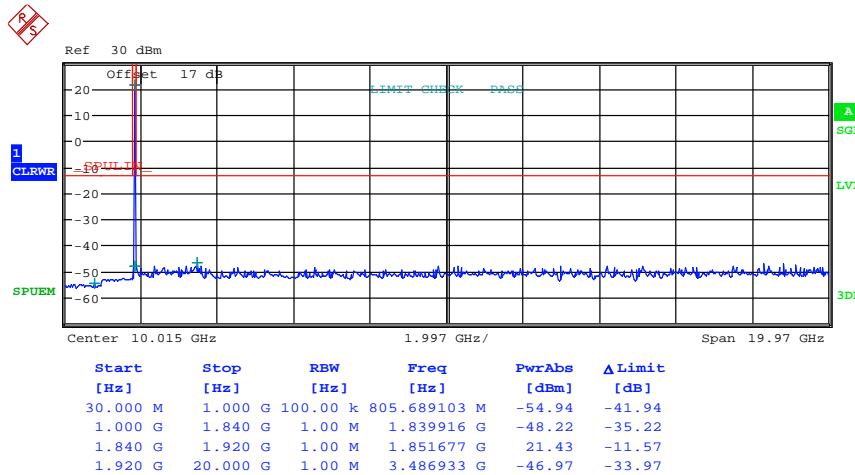

CONDUCTED SPURIOUS EMISSION

Date: 11.AUG.2020 19:39:42





# Worldwide Testing Services(Taiwan) Co., Ltd.

Report Number: W6M22006-20020-P-247  
 FCC ID: GX9CTC1052QT

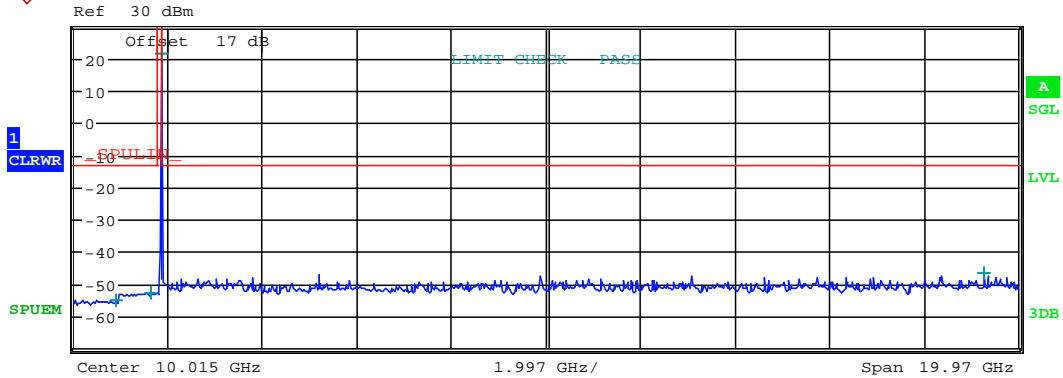

Start [Hz]	Stop [Hz]	RBW [Hz]	Freq [Hz]	PwrAbs [dBm]	ΔLimit [dB]
30.000 M	1.000 G	100.00 k	937.820513 M	-55.00	-42.00
1.000 G	1.840 G	1.00 M	1.674520 G	-52.69	-39.69
1.840 G	1.920 G	1.00 M	1.879256 G	21.38	-11.62
1.920 G	20.000 G	1.00 M	19.272581 G	-46.61	-33.61

CONDUCTED SPURIOUS EMISSION

Date: 11.AUG.2020 19:40:07



Report Number: W6M22006-20020-P-247  
 FCC ID: GX9CTC1052QT

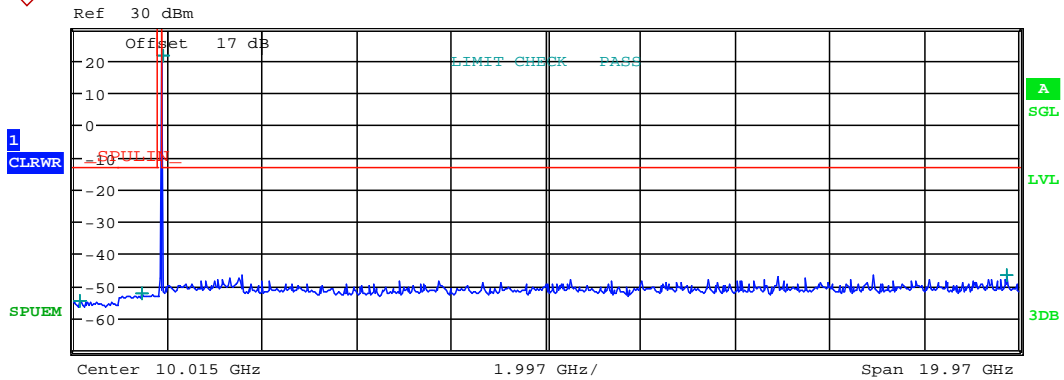

Start [Hz]	Stop [Hz]	RBW [Hz]	Freq [Hz]	PwrAbs [dBm]	ΔLimit [dB]
30.000 M	1.000 G	100.00 k	154.358974 M	-54.95	-41.95
1.000 G	1.840 G	1.00 M	1.468300 G	-52.62	-39.62
1.840 G	1.920 G	1.00 M	1.906989 G	21.55	-11.45
1.920 G	20.000 G	1.00 M	19.737237 G	-46.78	-33.78

CONDUCTED SPURIOUS EMISSION

Date: 11.AUG.2020 19:40:32



# Worldwide Testing Services(Taiwan) Co., Ltd.

Report Number: W6M22006-20020-P-247

FCC ID: GX9CTC1052QT

Band IV

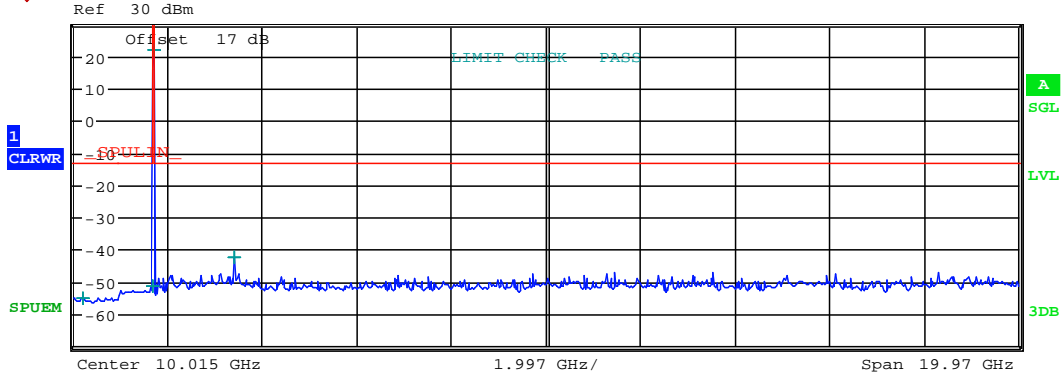

Start [Hz]	Stop [Hz]	RBW [Hz]	Freq [Hz]	PwrAbs [dBm]	ΔLimit [dB]
30.000 M	1.000 G	100.00 k	230.528846 M	-55.29	-42.29
1.000 G	1.700 G	1.00 M	1.699790 G	-51.52	-38.52
1.700 G	1.765 G	1.00 M	1.711644 G	21.81	-11.19
1.765 G	20.000 G	1.00 M	3.426209 G	-42.46	-29.46

CONDUCTED SPURIOUS EMISSION

Date: 11.AUG.2020 19:43:06



Report Number: W6M22006-20020-P-247  
 FCC ID: GX9CTC1052QT

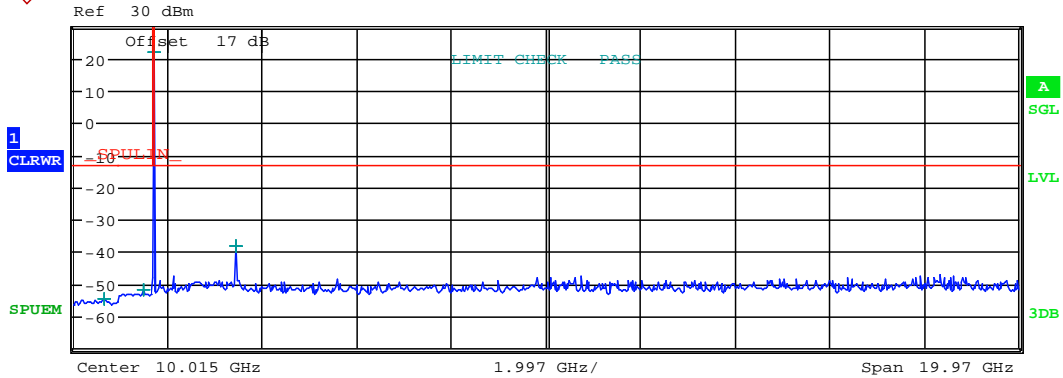

Start [Hz]	Stop [Hz]	RBW [Hz]	Freq [Hz]	PwrAbs [dBm]	Δ Limit [dB]
30.000 M	1.000 G	100.00 k	658.012821 M	-54.93	-41.93
1.000 G	1.700 G	1.00 M	1.512120 G	-52.05	-39.05
1.700 G	1.765 G	1.00 M	1.733414 G	21.70	-11.30
1.765 G	20.000 G	1.00 M	3.466325 G	-38.09	-25.09

CONDUCTED SPURIOUS EMISSION

Date: 11.AUG.2020 19:43:27

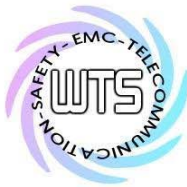

Report Number: W6M22006-20020-P-247  
 FCC ID: GX9CTC1052QT

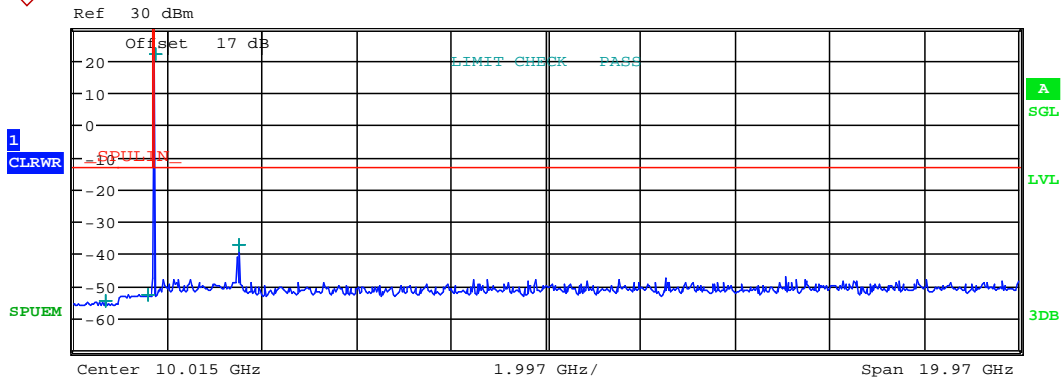

Start [Hz]	Stop [Hz]	RBW [Hz]	Freq [Hz]	PwrAbs [dBm]	Δ Limit [dB]
30.000 M	1.000 G	100.00 k	695.320513 M	-54.72	-41.72
1.000 G	1.700 G	1.00 M	1.586180 G	-52.74	-39.74
1.700 G	1.765 G	1.00 M	1.751413 G	21.99	-11.01
1.765 G	20.000 G	1.00 M	3.502796 G	-37.56	-24.56

CONDUCTED SPURIOUS EMISSION

Date: 11.AUG.2020 19:43:49



# Worldwide Testing Services(Taiwan) Co., Ltd.

Report Number: W6M22006-20020-P-247

FCC ID: GX9CTC1052QT

Band V

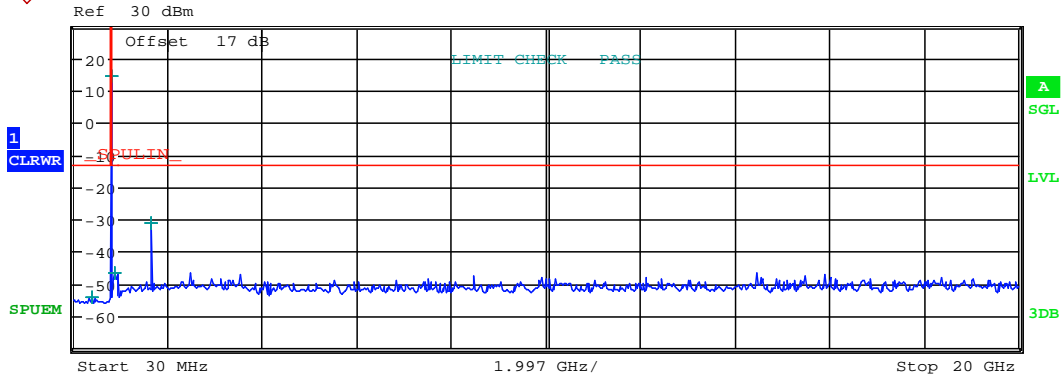

Start [Hz]	Stop [Hz]	RBW [Hz]	Freq [Hz]	PwrAbs [dBm]	ΔLimit [dB]
30.000 M	814.000 M	100.00 k	405.666667 M	-54.50	-41.50
814.000 M	859.000 M	100.00 k	825.709000 M	14.29	-18.71
859.000 M	1.000 G	100.00 k	905.760300 M	-46.73	-33.73
1.000 G	20.000 G	1.00 M	1.649167 G	-31.32	-18.32

CONDUCTED SPURIOUS EMISSION

Date: 11.AUG.2020 19:47:50

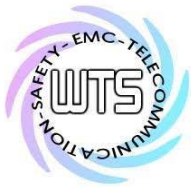

Report Number: W6M22006-20020-P-247  
 FCC ID: GX9CTC1052QT

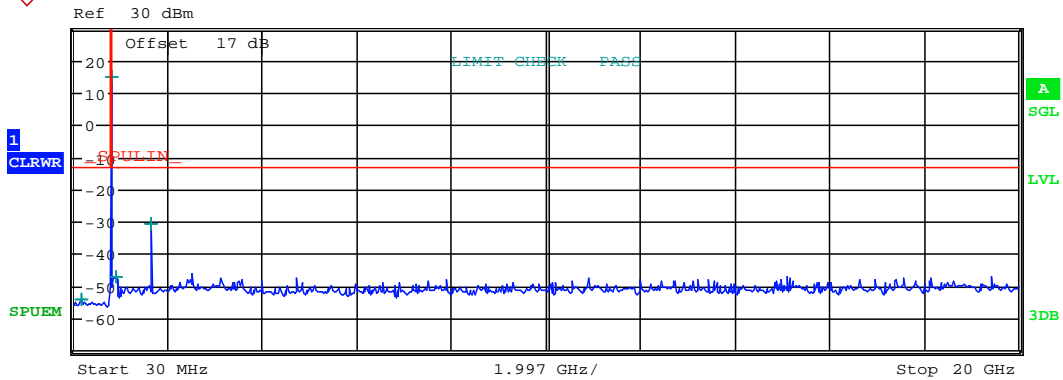

Start [Hz]	Stop [Hz]	RBW [Hz]	Freq [Hz]	PwrAbs [dBm]	ΔLimit [dB]
30.000 M	814.000 M	100.00 k	198.358974 M	-54.43	-41.43
814.000 M	859.000 M	100.00 k	837.350500 M	14.52	-18.48
859.000 M	1.000 G	100.00 k	934.627700 M	-47.24	-34.24
1.000 G	20.000 G	1.00 M	1.670067 G	-30.85	-17.85

CONDUCTED SPURIOUS EMISSION

Date: 11.AUG.2020 19:48:19



Report Number: W6M22006-20020-P-247  
 FCC ID: GX9CTC1052QT

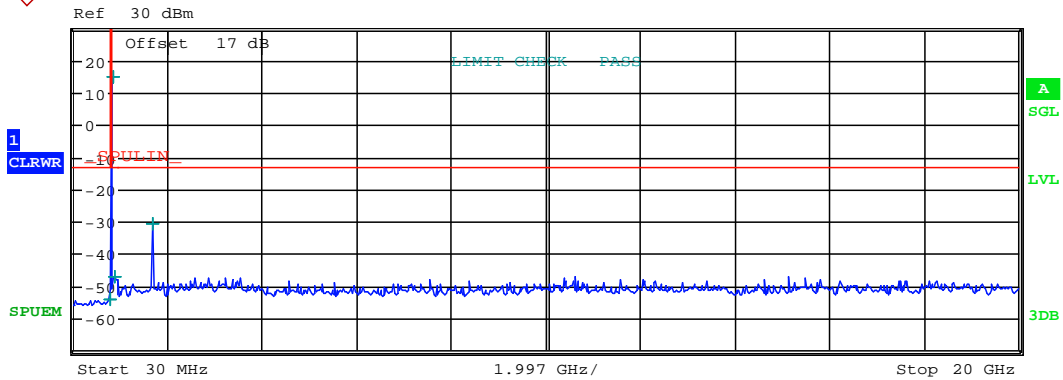

Start 30 MHz 1.997 GHz/ Stop 20 GHz

Start [Hz]	Stop [Hz]	RBW [Hz]	Freq [Hz]	PwrAbs [dBm]	ΔLimit [dB]
30.000 M	814.000 M	100.00 k	797.666667 M	-54.21	-41.21
814.000 M	859.000 M	100.00 k	847.484500 M	14.89	-18.11
859.000 M	1.000 G	100.00 k	891.768400 M	-47.20	-34.20
1.000 G	20.000 G	1.00 M	1.690333 G	-30.58	-17.58

CONDUCTED SPURIOUS EMISSION

Date: 11.AUG.2020 19:48:38





# Worldwide Testing Services(Taiwan) Co., Ltd.

Report Number: W6M22006-20020-P-247  
 FCC ID: GX9CTC1052QT

LTE  
 Band II  
 16QAM  
 1.4MHz

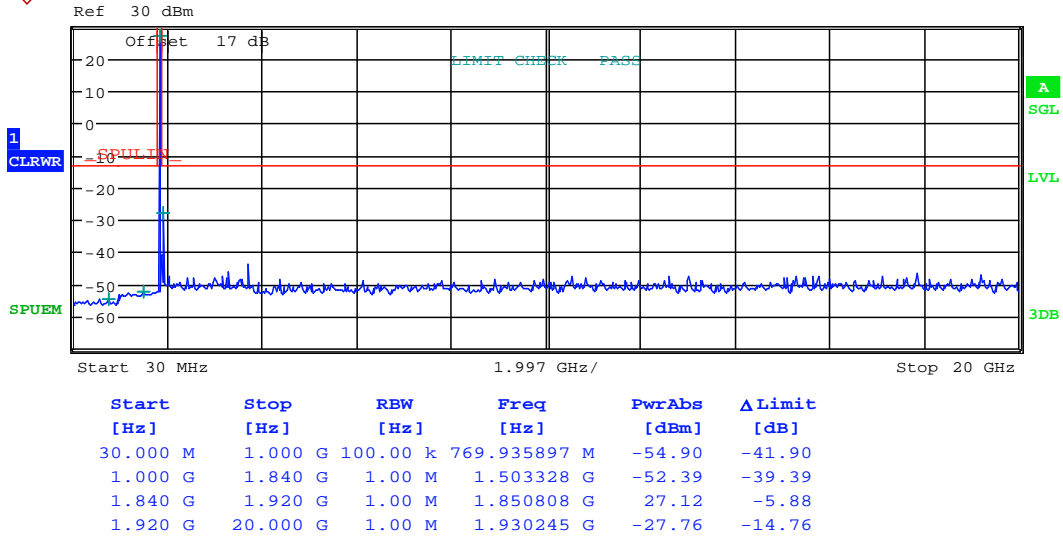

CONDUCTED SPURIOUS EMISSION

Date: 11.AUG.2020 19:57:46



Report Number: W6M22006-20020-P-247  
 FCC ID: GX9CTC1052QT

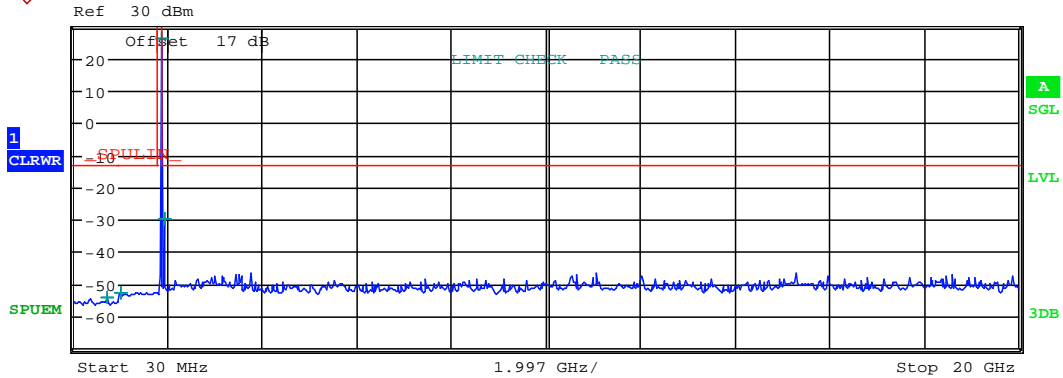

Start [Hz]	Stop [Hz]	RBW [Hz]	Freq [Hz]	PwrAbs [dBm]	ΔLimit [dB]
30.000 M	1.000 G	100.00 k	745.064103 M	-54.37	-41.37
1.000 G	1.840 G	1.00 M	1.022512 G	-52.70	-39.70
1.840 G	1.920 G	1.00 M	1.880141 G	26.11	-6.89
1.920 G	20.000 G	1.00 M	1.959776 G	-29.98	-16.98

CONDUCTED SPURIOUS EMISSION

Date: 11.AUG.2020 19:58:33



# Worldwide Testing Services(Taiwan) Co., Ltd.

Report Number: W6M22006-20020-P-247  
 FCC ID: GX9CTC1052QT

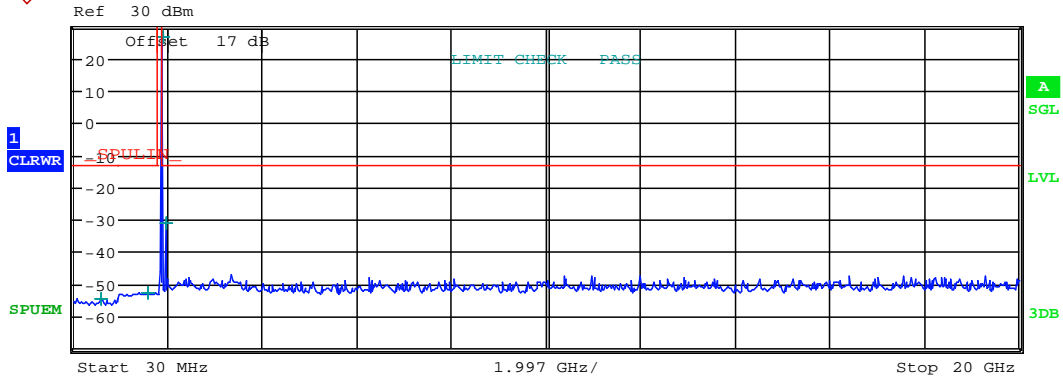

Start [Hz]	Stop [Hz]	RBW [Hz]	Freq [Hz]	PwrAbs [dBm]	ΔLimit [dB]
30.000 M	1.000 G	100.00 k	603.605769 M	-54.52	-41.52
1.000 G	1.840 G	1.00 M	1.607068 G	-52.80	-39.80
1.840 G	1.920 G	1.00 M	1.909363 G	26.67	-6.33
1.920 G	20.000 G	1.00 M	1.988704 G	-31.19	-18.19

CONDUCTED SPURIOUS EMISSION

Date: 11.AUG.2020 19:58:59



# Worldwide Testing Services(Taiwan) Co., Ltd.

Report Number: W6M22006-20020-P-247

FCC ID: GX9CTC1052QT

3MHz

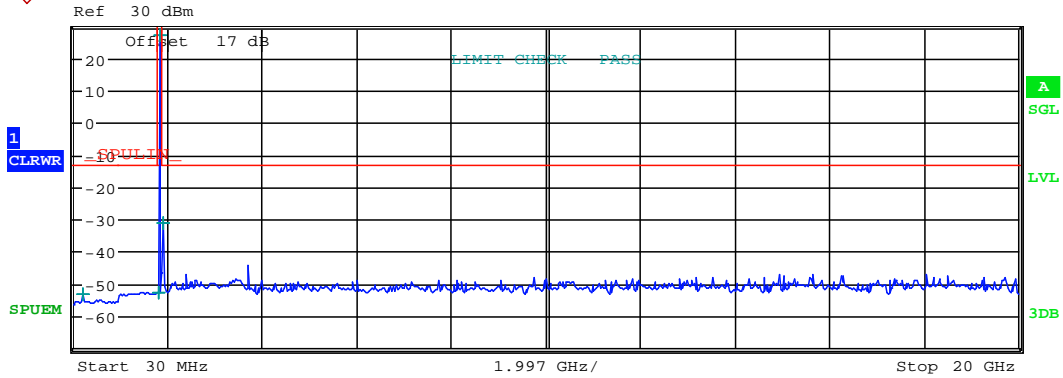

Start [Hz]	Stop [Hz]	RBW [Hz]	Freq [Hz]	PwrAbs [dBm]	ΔLimit [dB]
30.000 M	1.000 G	100.00 k	218.092949 M	-53.54	-40.54
1.000 G	1.840 G	1.00 M	1.815052 G	-52.78	-39.78
1.840 G	1.920 G	1.00 M	1.851808 G	27.04	-5.96
1.920 G	20.000 G	1.00 M	1.931451 G	-31.37	-18.37

CONDUCTED SPURIOUS EMISSION

Date: 11.AUG.2020 20:02:39



Report Number: W6M22006-20020-P-247  
 FCC ID: GX9CTC1052QT

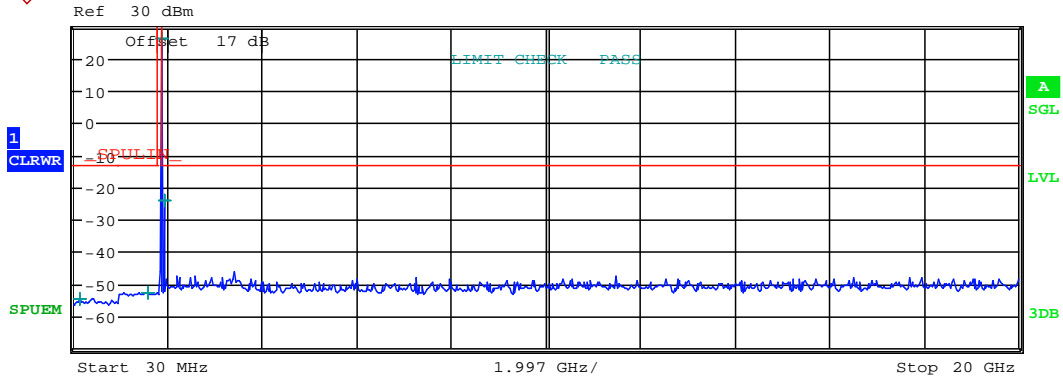

Start [Hz]	Stop [Hz]	RBW [Hz]	Freq [Hz]	PwrAbs [dBm]	ΔLimit [dB]
30.000 M	1.000 G	100.00 k	155.913462 M	-54.60	-41.60
1.000 G	1.840 G	1.00 M	1.585312 G	-52.70	-39.70
1.840 G	1.920 G	1.00 M	1.880104 G	26.16	-6.84
1.920 G	20.000 G	1.00 M	1.959173 G	-24.39	-11.39

CONDUCTED SPURIOUS EMISSION

Date: 11.AUG.2020 20:03:03



Report Number: W6M22006-20020-P-247  
 FCC ID: GX9CTC1052QT

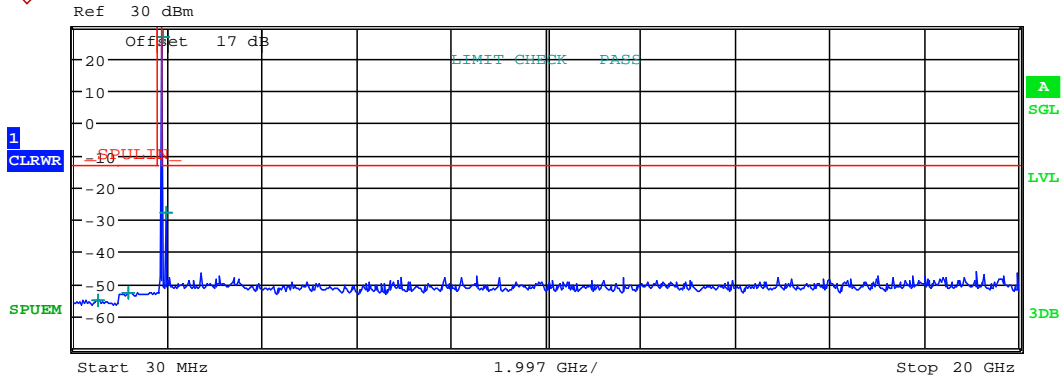

Start [Hz]	Stop [Hz]	RBW [Hz]	Freq [Hz]	PwrAbs [dBm]	ΔLimit [dB]
30.000 M	1.000 G	100.00 k	552.307692 M	-55.12	-42.12
1.000 G	1.840 G	1.00 M	1.172368 G	-52.73	-39.73
1.840 G	1.920 G	1.00 M	1.908691 G	26.58	-6.42
1.920 G	20.000 G	1.00 M	1.988704 G	-28.14	-15.14

CONDUCTED SPURIOUS EMISSION

Date: 11.AUG.2020 20:03:32



Report Number: W6M22006-20020-P-247

FCC ID: GX9CTC1052QT

5MHz

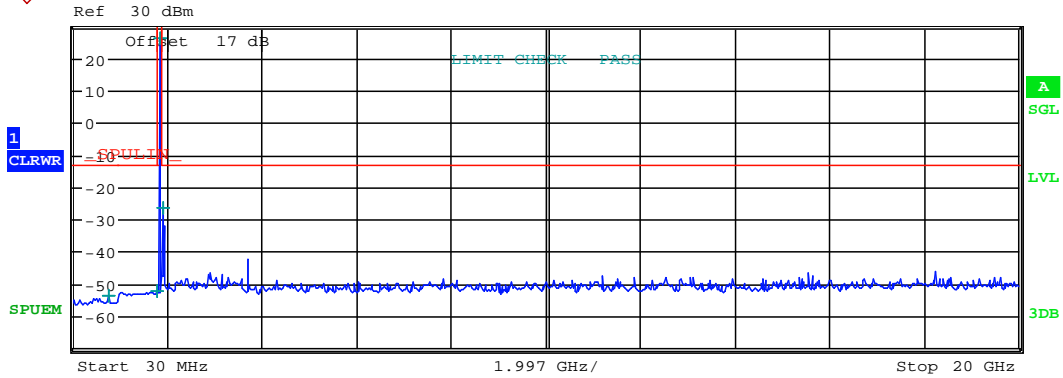

Start [Hz]	Stop [Hz]	RBW [Hz]	Freq [Hz]	PwrAbs [dBm]	ΔLimit [dB]
30.000 M	1.000 G	100.00 k	757.500000 M	-53.91	-40.91
1.000 G	1.840 G	1.00 M	1.797244 G	-52.61	-39.61
1.840 G	1.920 G	1.00 M	1.852576 G	26.18	-6.82
1.920 G	20.000 G	1.00 M	1.932053 G	-26.64	-13.64

CONDUCTED SPURIOUS EMISSION

Date: 11.AUG.2020 20:19:09



Report Number: W6M22006-20020-P-247  
 FCC ID: GX9CTC1052QT

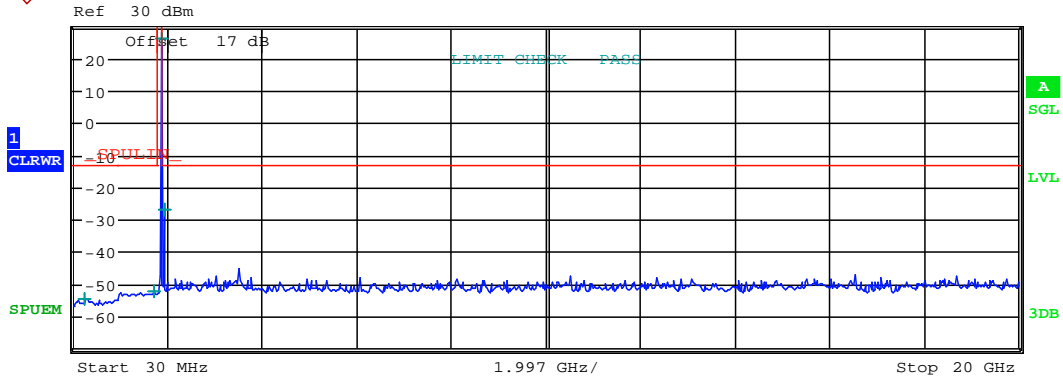

Start [Hz]	Stop [Hz]	RBW [Hz]	Freq [Hz]	PwrAbs [dBm]	ΔLimit [dB]
30.000 M	1.000 G	100.00 k	269.391026 M	-54.76	-41.76
1.000 G	1.840 G	1.00 M	1.730296 G	-52.61	-39.61
1.840 G	1.920 G	1.00 M	1.880189 G	25.88	-7.12
1.920 G	20.000 G	1.00 M	1.960379 G	-27.12	-14.12

CONDUCTED SPURIOUS EMISSION

Date: 11.AUG.2020 20:19:28





# Worldwide Testing Services(Taiwan) Co., Ltd.

Report Number: W6M22006-20020-P-247  
 FCC ID: GX9CTC1052QT

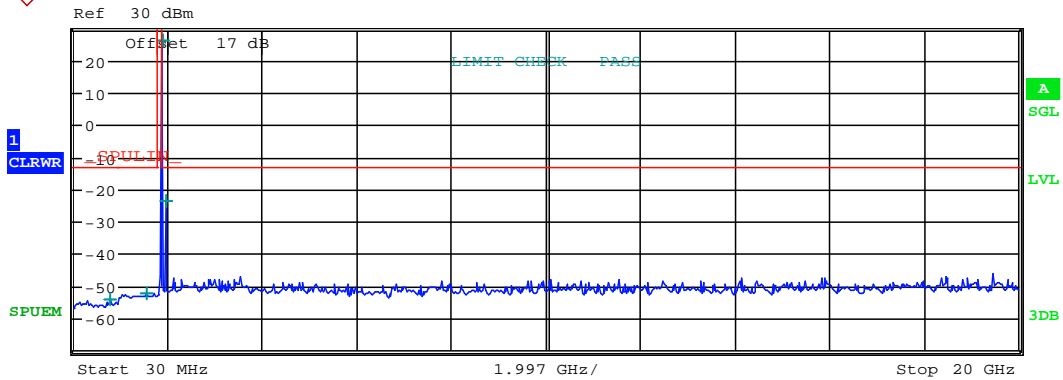

Start [Hz]	Stop [Hz]	RBW [Hz]	Freq [Hz]	PwrAbs [dBm]	ΔLimit [dB]
30.000 M	1.000 G	100.00 k	805.689103 M	-54.20	-41.20
1.000 G	1.840 G	1.00 M	1.559272 G	-52.47	-39.47
1.840 G	1.920 G	1.00 M	1.907725 G	25.83	-7.17
1.920 G	20.000 G	1.00 M	1.985691 G	-23.53	-10.53

CONDUCTED SPURIOUS EMISSION

Date: 11.AUG.2020 20:19:50



# Worldwide Testing Services(Taiwan) Co., Ltd.

Report Number: W6M22006-20020-P-247

FCC ID: GX9CTC1052QT

10MHz

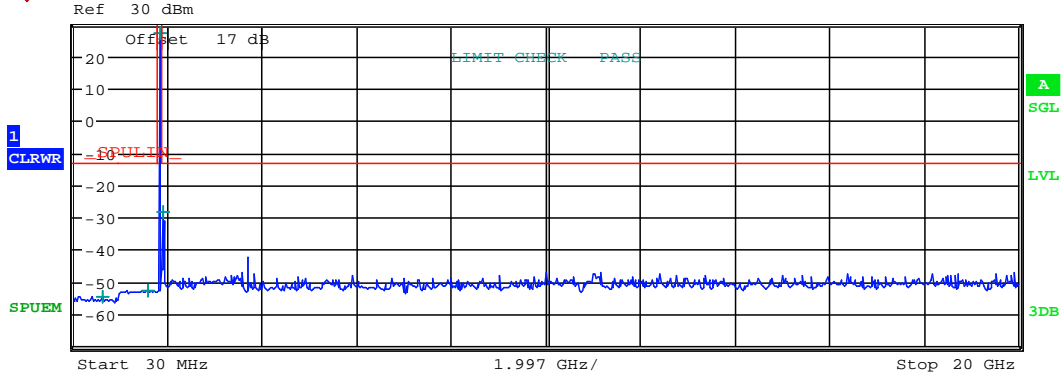

Start [Hz]	Stop [Hz]	RBW [Hz]	Freq [Hz]	PwrAbs [dBm]	ΔLimit [dB]
30.000 M	1.000 G	100.00 k	628.477564 M	-54.80	-41.80
1.000 G	1.840 G	1.00 M	1.612192 G	-52.70	-39.70
1.840 G	1.920 G	1.00 M	1.855229 G	27.15	-5.85
1.920 G	20.000 G	1.00 M	1.932053 G	-28.39	-15.39

CONDUCTED SPURIOUS EMISSION

Date: 11.AUG.2020 20:23:33



Report Number: W6M22006-20020-P-247  
 FCC ID: GX9CTC1052QT

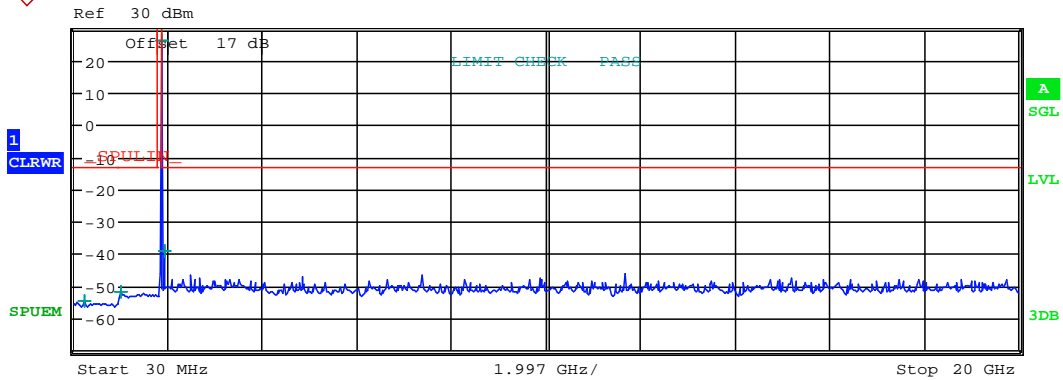

Start [Hz]	Stop [Hz]	RBW [Hz]	Freq [Hz]	PwrAbs [dBm]	ΔLimit [dB]
30.000 M	1.000 G	100.00 k	247.628205 M	-54.81	-41.81
1.000 G	1.840 G	1.00 M	1.012516 G	-52.16	-39.16
1.840 G	1.920 G	1.00 M	1.880139 G	26.05	-6.95
1.920 G	20.000 G	1.00 M	1.955557 G	-39.10	-26.10

CONDUCTED SPURIOUS EMISSION

Date: 11.AUG.2020 20:23:51



# Worldwide Testing Services(Taiwan) Co., Ltd.

Report Number: W6M22006-20020-P-247  
 FCC ID: GX9CTC1052QT

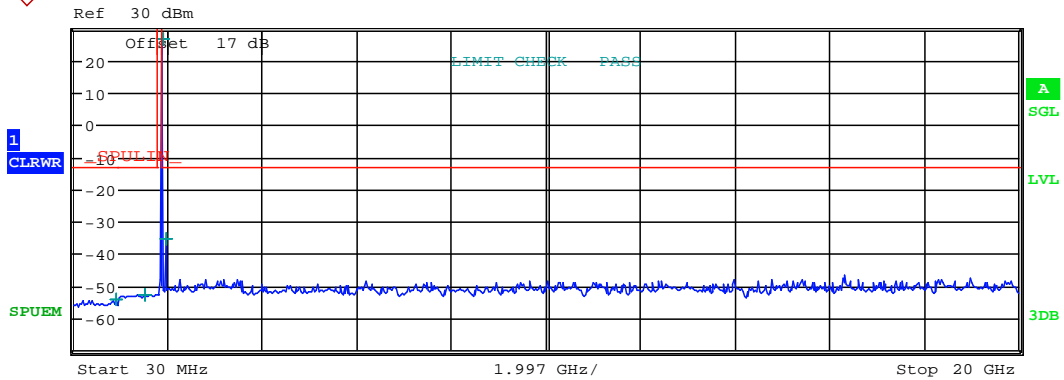

Start [Hz]	Stop [Hz]	RBW [Hz]	Freq [Hz]	PwrAbs [dBm]	ΔLimit [dB]
30.000 M	1.000 G	100.00 k	914.503205 M	-54.45	-41.45
1.000 G	1.840 G	1.00 M	1.522732 G	-52.65	-39.65
1.840 G	1.920 G	1.00 M	1.905064 G	26.47	-6.53
1.920 G	20.000 G	1.00 M	1.980267 G	-35.40	-22.40

CONDUCTED SPURIOUS EMISSION

Date: 11.AUG.2020 20:24:18



# Worldwide Testing Services(Taiwan) Co., Ltd.

Report Number: W6M22006-20020-P-247

FCC ID: GX9CTC1052QT

15MHz

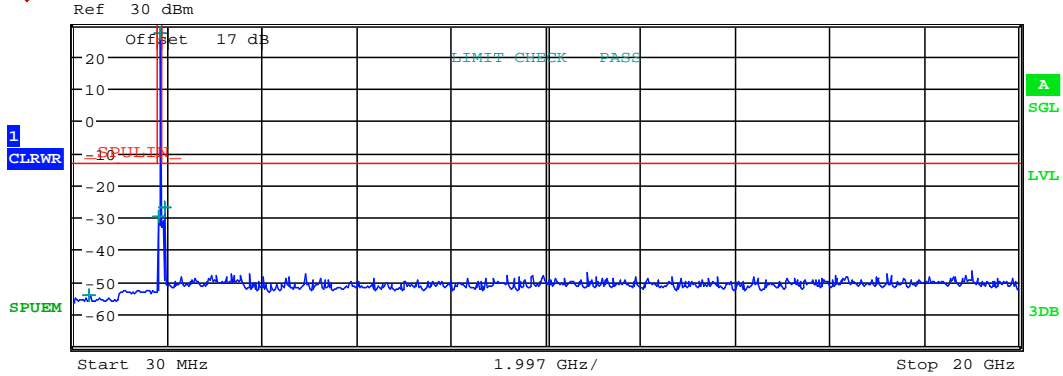

Start [Hz]	Stop [Hz]	RBW [Hz]	Freq [Hz]	PwrAbs [dBm]	ΔLimit [dB]
30.000 M	1.000 G	100.00 k	365.769231 M	-54.32	-41.32
1.000 G	1.840 G	1.00 M	1.837648 G	-29.77	-16.77
1.840 G	1.920 G	1.00 M	1.864128 G	26.98	-6.02
1.920 G	20.000 G	1.00 M	1.934464 G	-27.21	-14.21

CONDUCTED SPURIOUS EMISSION

Date: 11.AUG.2020 20:28:23



Report Number: W6M22006-20020-P-247  
 FCC ID: GX9CTC1052QT

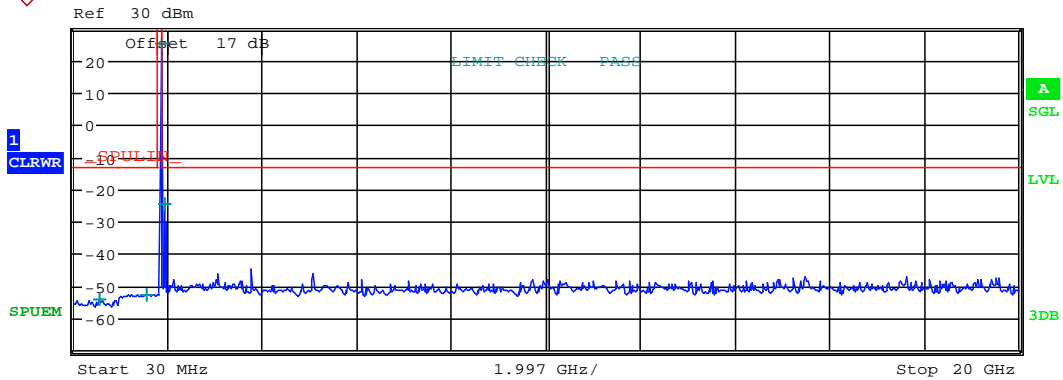

Start [Hz]	Stop [Hz]	RBW [Hz]	Freq [Hz]	PwrAbs [dBm]	ΔLimit [dB]
30.000 M	1.000 G	100.00 k	578.733974 M	-54.49	-41.49
1.000 G	1.840 G	1.00 M	1.581784 G	-52.76	-39.76
1.840 G	1.920 G	1.00 M	1.886683 G	25.15	-7.85
1.920 G	20.000 G	1.00 M	1.959776 G	-24.81	-11.81

CONDUCTED SPURIOUS EMISSION

Date: 11.AUG.2020 20:28:45



# Worldwide Testing Services(Taiwan) Co., Ltd.

Report Number: W6M22006-20020-P-247  
 FCC ID: GX9CTC1052QT

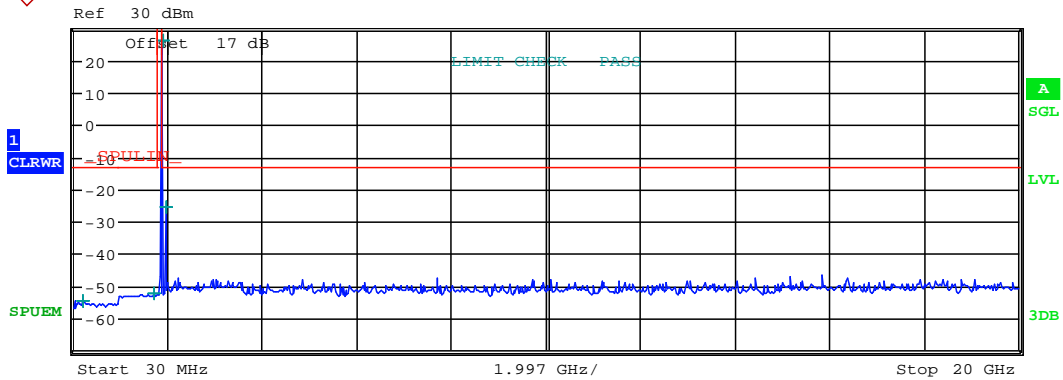

Start [Hz]	Stop [Hz]	RBW [Hz]	Freq [Hz]	PwrAbs [dBm]	ΔLimit [dB]
30.000 M	1.000 G	100.00 k	235.192308 M	-54.70	-41.70
1.000 G	1.840 G	1.00 M	1.711732 G	-52.59	-39.59
1.840 G	1.920 G	1.00 M	1.909136 G	25.84	-7.16
1.920 G	20.000 G	1.00 M	1.978459 G	-25.59	-12.59

CONDUCTED SPURIOUS EMISSION

Date: 11.AUG.2020 20:29:07



# Worldwide Testing Services(Taiwan) Co., Ltd.

Report Number: W6M22006-20020-P-247

FCC ID: GX9CTC1052QT

20MHz

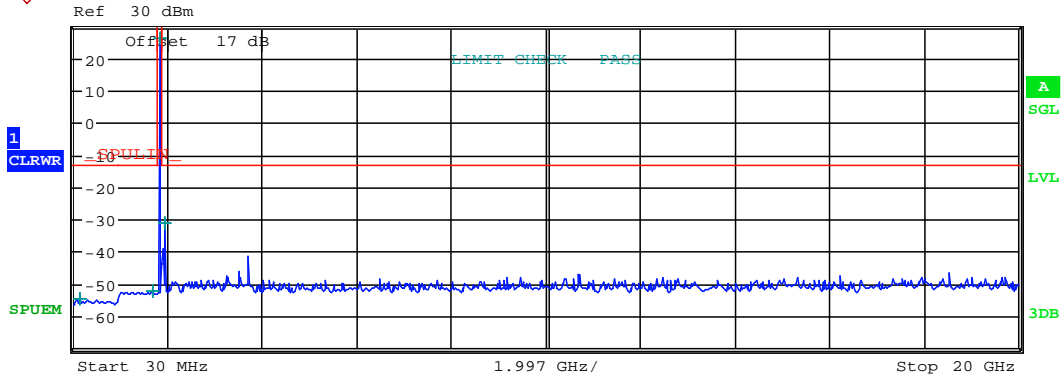

Start [Hz]	Stop [Hz]	RBW [Hz]	Freq [Hz]	PwrAbs [dBm]	ΔLimit [dB]
30.000 M	1.000 G	100.00 k	160.576923 M	-54.76	-41.76
1.000 G	1.840 G	1.00 M	1.698460 G	-52.54	-39.54
1.840 G	1.920 G	1.00 M	1.860155 G	25.96	-7.04
1.920 G	20.000 G	1.00 M	1.944709 G	-31.42	-18.42

CONDUCTED SPURIOUS EMISSION

Date: 11.AUG.2020 20:31:15





Report Number: W6M22006-20020-P-247  
 FCC ID: GX9CTC1052QT

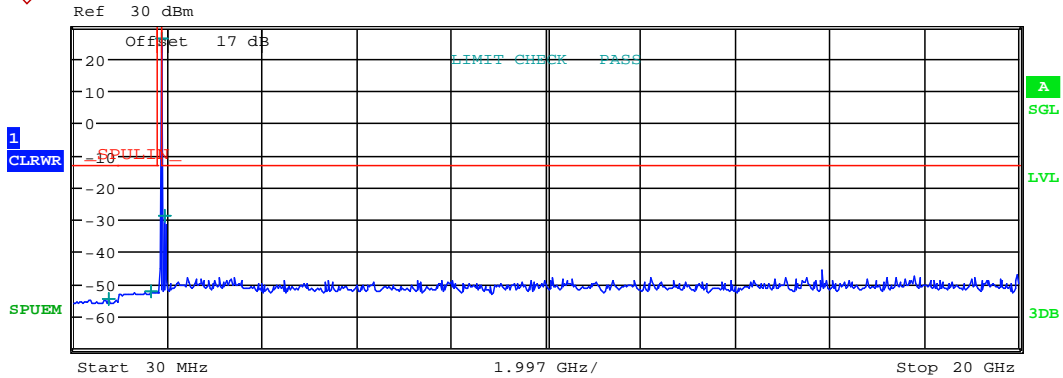

Start [Hz]	Stop [Hz]	RBW [Hz]	Freq [Hz]	PwrAbs [dBm]	ΔLimit [dB]
30.000 M	1.000 G	100.00 k	754.391026 M	-54.78	-41.78
1.000 G	1.840 G	1.00 M	1.650580 G	-52.56	-39.56
1.840 G	1.920 G	1.00 M	1.880037 G	26.21	-6.79
1.920 G	20.000 G	1.00 M	1.958571 G	-29.03	-16.03

CONDUCTED SPURIOUS EMISSION

Date: 11.AUG.2020 20:32:10



Report Number: W6M22006-20020-P-247  
 FCC ID: GX9CTC1052QT

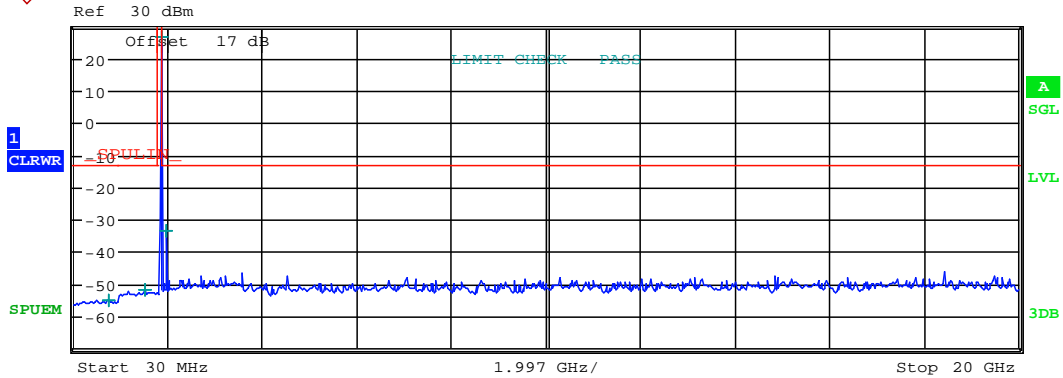

Start [Hz]	Stop [Hz]	RBW [Hz]	Freq [Hz]	PwrAbs [dBm]	ΔLimit [dB]
30.000 M	1.000 G	100.00 k	776.153846 M	-55.21	-42.21
1.000 G	1.840 G	1.00 M	1.530796 G	-51.98	-38.98
1.840 G	1.920 G	1.00 M	1.900336 G	26.39	-6.61
1.920 G	20.000 G	1.00 M	1.979664 G	-33.38	-20.38

CONDUCTED SPURIOUS EMISSION

Date: 11.AUG.2020 20:33:33



# Worldwide Testing Services(Taiwan) Co., Ltd.

Report Number: W6M22006-20020-P-247

FCC ID: GX9CTC1052QT

QPSK

1.4MHz

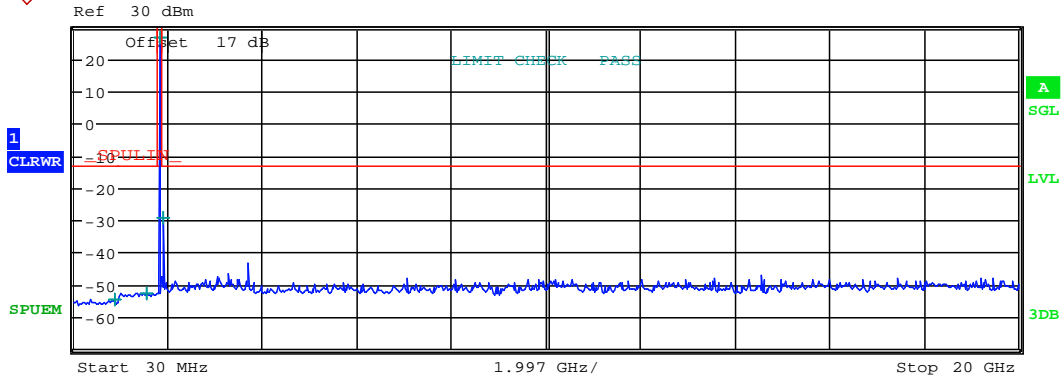

Start [Hz]	Stop [Hz]	RBW [Hz]	Freq [Hz]	PwrAbs [dBm]	ΔLimit [dB]
30.000 M	1.000 G	100.00 k	886.522436 M	-54.60	-41.60
1.000 G	1.840 G	1.00 M	1.561708 G	-52.81	-39.81
1.840 G	1.920 G	1.00 M	1.850760 G	26.54	-6.46
1.920 G	20.000 G	1.00 M	1.930848 G	-29.22	-16.22

CONDUCTED SPURIOUS EMISSION

Date: 11.AUG.2020 19:59:55



Report Number: W6M22006-20020-P-247  
 FCC ID: GX9CTC1052QT

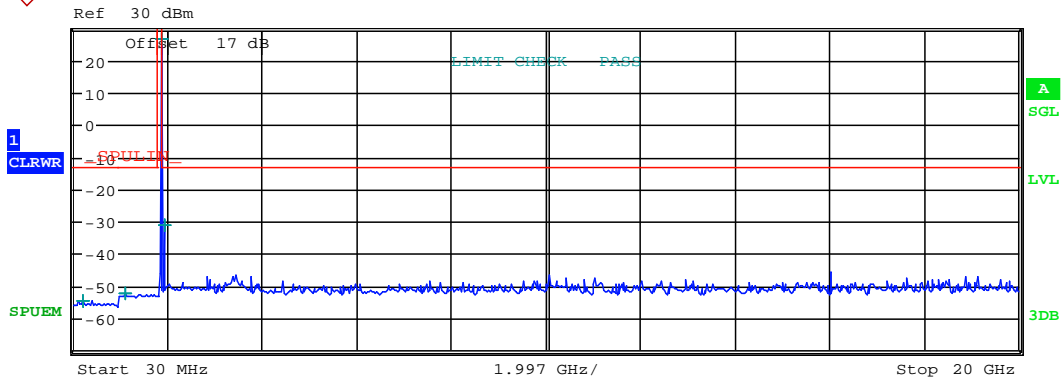

Start [Hz]	Stop [Hz]	RBW [Hz]	Freq [Hz]	PwrAbs [dBm]	ΔLimit [dB]
30.000 M	1.000 G	100.00 k	213.429487 M	-54.63	-41.63
1.000 G	1.840 G	1.00 M	1.128100 G	-52.42	-39.42
1.840 G	1.920 G	1.00 M	1.879984 G	26.29	-6.71
1.920 G	20.000 G	1.00 M	1.959173 G	-31.22	-18.22

CONDUCTED SPURIOUS EMISSION

Date: 11.AUG.2020 20:00:19



Report Number: W6M22006-20020-P-247  
 FCC ID: GX9CTC1052QT

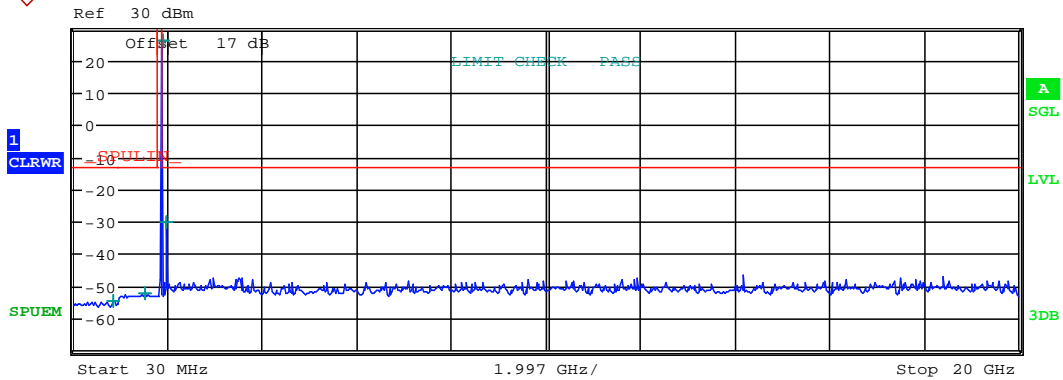

Start [Hz]	Stop [Hz]	RBW [Hz]	Freq [Hz]	PwrAbs [dBm]	Δ Limit [dB]
30.000 M	1.000 G	100.00 k	877.195513 M	-54.95	-41.95
1.000 G	1.840 G	1.00 M	1.538944 G	-52.37	-39.37
1.840 G	1.920 G	1.00 M	1.909416 G	26.22	-6.78
1.920 G	20.000 G	1.00 M	1.989307 G	-30.34	-17.34

CONDUCTED SPURIOUS EMISSION

Date: 11.AUG.2020 20:01:18



# Worldwide Testing Services(Taiwan) Co., Ltd.

Report Number: W6M22006-20020-P-247

FCC ID: GX9CTC1052QT

3MHz

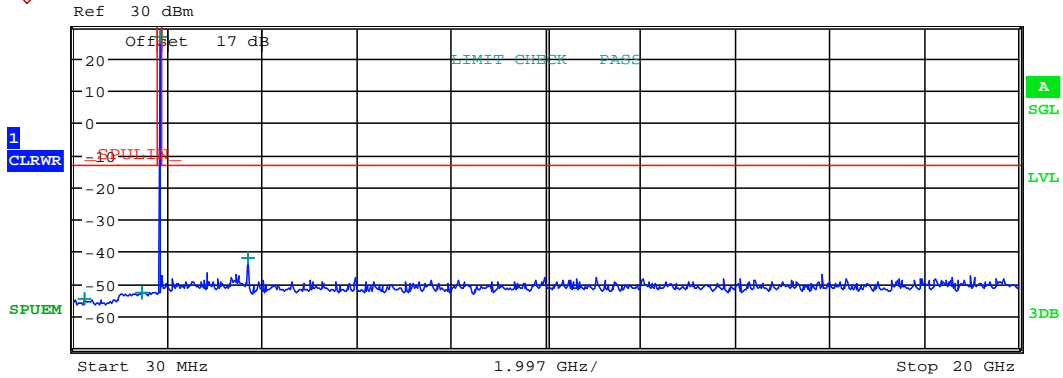

Start [Hz]	Stop [Hz]	RBW [Hz]	Freq [Hz]	PwrAbs [dBm]	ΔLimit [dB]
30.000 M	1.000 G	100.00 k	255.400641 M	-54.97	-41.97
1.000 G	1.840 G	1.00 M	1.459480 G	-52.71	-39.71
1.840 G	1.920 G	1.00 M	1.851763 G	26.36	-6.64
1.920 G	20.000 G	1.00 M	3.702688 G	-41.91	-28.91

CONDUCTED SPURIOUS EMISSION

Date: 11.AUG.2020 20:04:25



# Worldwide Testing Services(Taiwan) Co., Ltd.

Report Number: W6M22006-20020-P-247  
 FCC ID: GX9CTC1052QT

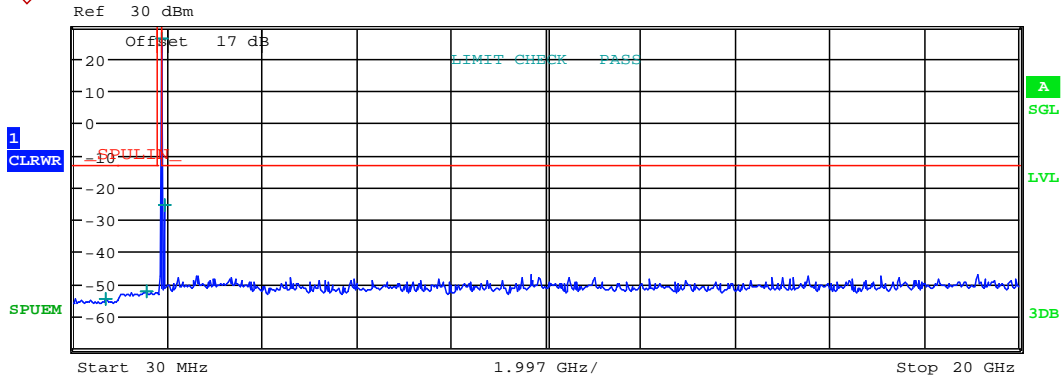

Start [Hz]	Stop [Hz]	RBW [Hz]	Freq [Hz]	PwrAbs [dBm]	ΔLimit [dB]
30.000 M	1.000 G	100.00 k	695.320513 M	-54.54	-41.54
1.000 G	1.840 G	1.00 M	1.573636 G	-52.54	-39.54
1.840 G	1.920 G	1.00 M	1.880291 G	26.20	-6.80
1.920 G	20.000 G	1.00 M	1.960379 G	-25.51	-12.51

CONDUCTED SPURIOUS EMISSION

Date: 11.AUG.2020 20:04:44



Report Number: W6M22006-20020-P-247  
 FCC ID: GX9CTC1052QT

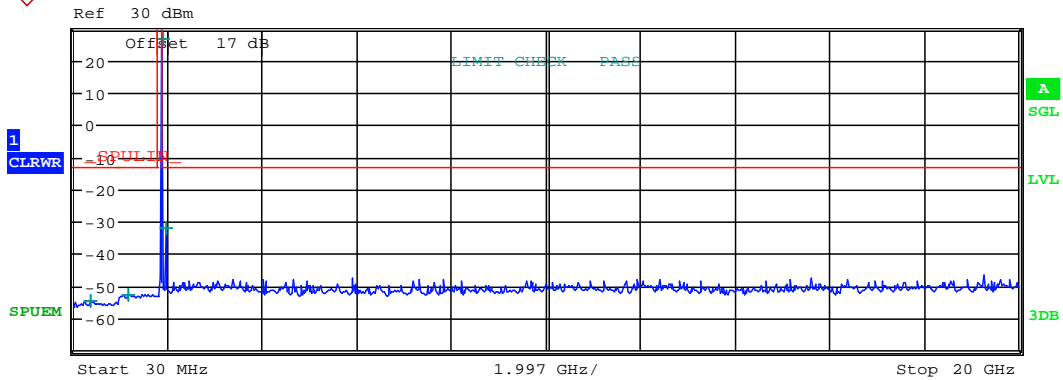

Start [Hz]	Stop [Hz]	RBW [Hz]	Freq [Hz]	PwrAbs [dBm]	ΔLimit [dB]
30.000 M	1.000 G	100.00 k	392.195513 M	-54.66	-41.66
1.000 G	1.840 G	1.00 M	1.184296 G	-52.64	-39.64
1.840 G	1.920 G	1.00 M	1.908667 G	26.37	-6.63
1.920 G	20.000 G	1.00 M	1.988101 G	-32.33	-19.33

CONDUCTED SPURIOUS EMISSION

Date: 11.AUG.2020 20:05:08





# Worldwide Testing Services(Taiwan) Co., Ltd.

Report Number: W6M22006-20020-P-247

FCC ID: GX9CTC1052QT

5MHz

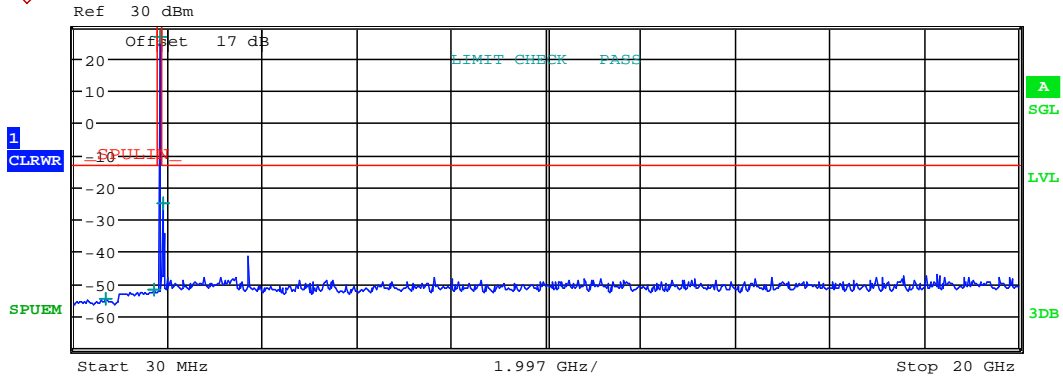

Start [Hz]	Stop [Hz]	RBW [Hz]	Freq [Hz]	PwrAbs [dBm]	ΔLimit [dB]
30.000 M	1.000 G	100.00 k	701.538462 M	-54.77	-41.77
1.000 G	1.840 G	1.00 M	1.722232 G	-52.09	-39.09
1.840 G	1.920 G	1.00 M	1.852661 G	26.60	-6.40
1.920 G	20.000 G	1.00 M	1.932053 G	-25.39	-12.39

CONDUCTED SPURIOUS EMISSION

Date: 11.AUG.2020 20:20:59



# Worldwide Testing Services(Taiwan) Co., Ltd.

Report Number: W6M22006-20020-P-247  
 FCC ID: GX9CTC1052QT

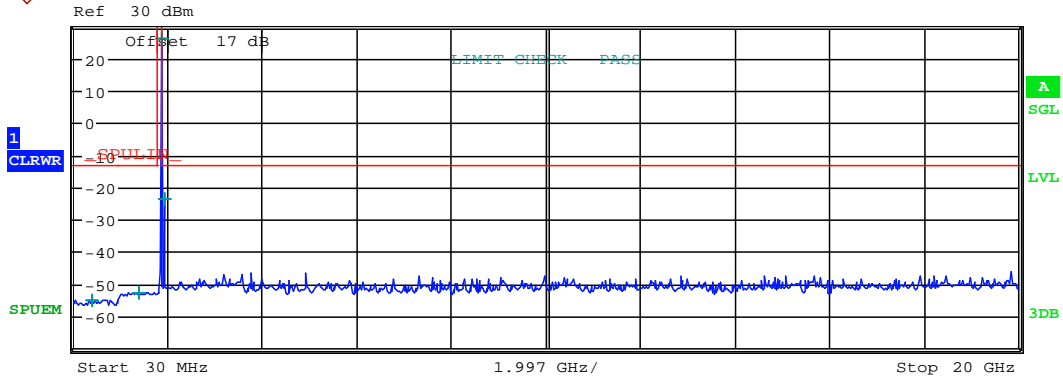

Start [Hz]	Stop [Hz]	RBW [Hz]	Freq [Hz]	PwrAbs [dBm]	ΔLimit [dB]
30.000 M	1.000 G	100.00 k	412.403846 M	-54.99	-41.99
1.000 G	1.840 G	1.00 M	1.419916 G	-52.64	-39.64
1.840 G	1.920 G	1.00 M	1.880144 G	26.13	-6.87
1.920 G	20.000 G	1.00 M	1.959173 G	-23.73	-10.73

CONDUCTED SPURIOUS EMISSION

Date: 11.AUG.2020 20:20:39



Report Number: W6M22006-20020-P-247  
 FCC ID: GX9CTC1052QT

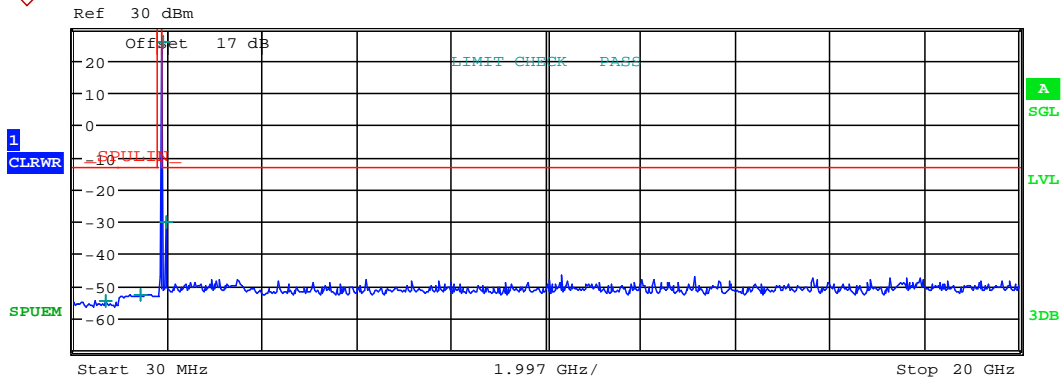

Start [Hz]	Stop [Hz]	RBW [Hz]	Freq [Hz]	PwrAbs [dBm]	ΔLimit [dB]
30.000 M	1.000 G	100.00 k	712.419872 M	-54.71	-41.71
1.000 G	1.840 G	1.00 M	1.432768 G	-52.79	-39.79
1.840 G	1.920 G	1.00 M	1.907571 G	25.31	-7.69
1.920 G	20.000 G	1.00 M	1.985088 G	-30.41	-17.41

CONDUCTED SPURIOUS EMISSION

Date: 11.AUG.2020 20:20:14



# Worldwide Testing Services(Taiwan) Co., Ltd.

Report Number: W6M22006-20020-P-247

FCC ID: GX9CTC1052QT

10MHz

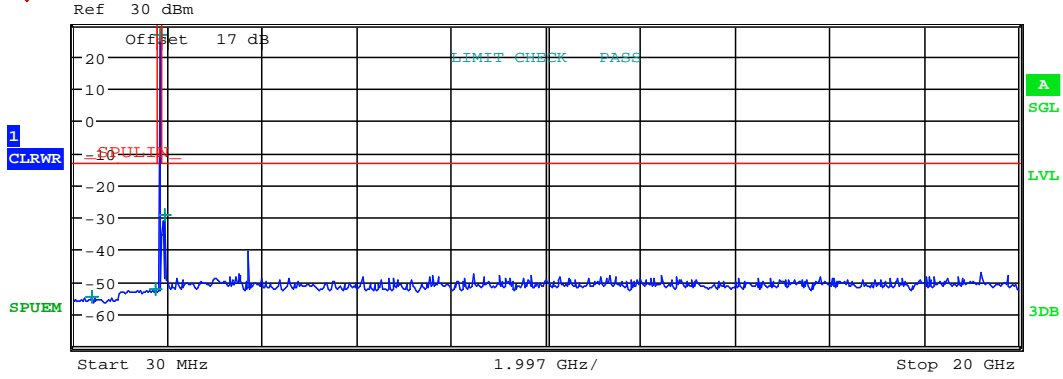

Start [Hz]	Stop [Hz]	RBW [Hz]	Freq [Hz]	PwrAbs [dBm]	ΔLimit [dB]
30.000 M	1.000 G	100.00 k	398.413462 M	-54.92	-41.92
1.000 G	1.840 G	1.00 M	1.748356 G	-52.53	-39.53
1.840 G	1.920 G	1.00 M	1.855064 G	26.45	-6.55
1.920 G	20.000 G	1.00 M	1.934464 G	-29.45	-16.45

CONDUCTED SPURIOUS EMISSION

Date: 11.AUG.2020 20:25:30



# Worldwide Testing Services(Taiwan) Co., Ltd.

Report Number: W6M22006-20020-P-247  
 FCC ID: GX9CTC1052QT

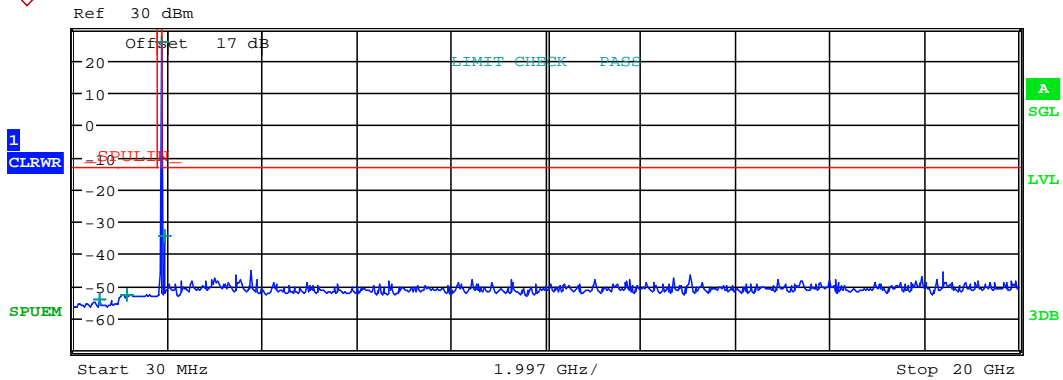

Start [Hz]	Stop [Hz]	RBW [Hz]	Freq [Hz]	PwrAbs [dBm]	ΔLimit [dB]
30.000 M	1.000 G	100.00 k	561.634615 M	-54.18	-41.18
1.000 G	1.840 G	1.00 M	1.156324 G	-52.87	-39.87
1.840 G	1.920 G	1.00 M	1.879995 G	25.71	-7.29
1.920 G	20.000 G	1.00 M	1.954955 G	-34.55	-21.55

CONDUCTED SPURIOUS EMISSION

Date: 11.AUG.2020 20:25:48



Report Number: W6M22006-20020-P-247  
 FCC ID: GX9CTC1052QT

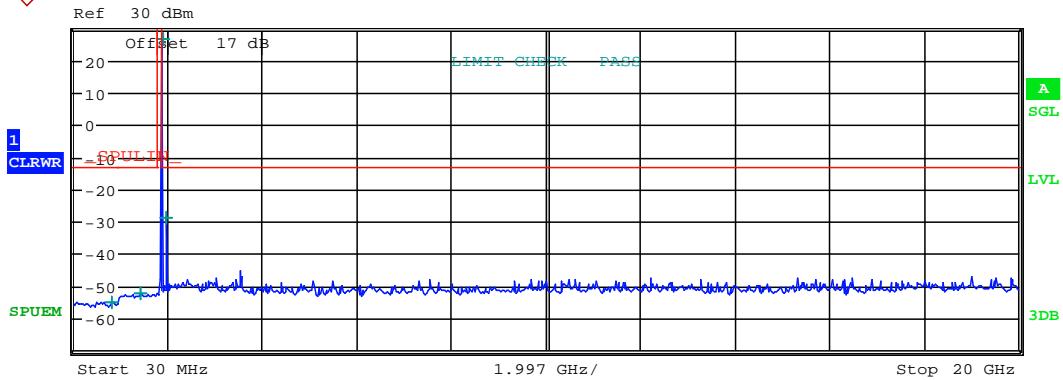

Start [Hz]	Stop [Hz]	RBW [Hz]	Freq [Hz]	PwrAbs [dBm]	ΔLimit [dB]
30.000 M	1.000 G	100.00 k	815.016026 M	-55.11	-42.11
1.000 G	1.840 G	1.00 M	1.427644 G	-52.41	-39.41
1.840 G	1.920 G	1.00 M	1.905168 G	26.46	-6.54
1.920 G	20.000 G	1.00 M	1.986293 G	-28.78	-15.78

CONDUCTED SPURIOUS EMISSION

Date: 11.AUG.2020 20:27:22



# Worldwide Testing Services(Taiwan) Co., Ltd.

Report Number: W6M22006-20020-P-247

FCC ID: GX9CTC1052QT

15MHz

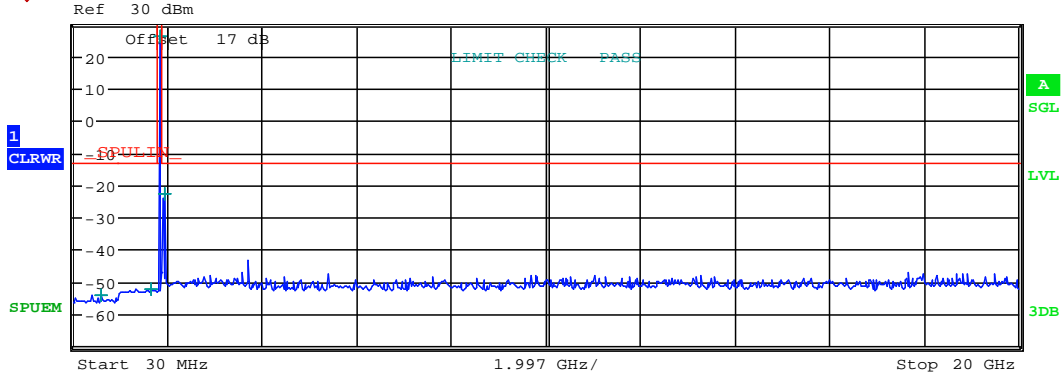

Start [Hz]	Stop [Hz]	RBW [Hz]	Freq [Hz]	PwrAbs [dBm]	ΔLimit [dB]
30.000 M	1.000 G	100.00 k	603.605769 M	-54.42	-41.42
1.000 G	1.840 G	1.00 M	1.675360 G	-52.57	-39.57
1.840 G	1.920 G	1.00 M	1.857787 G	26.18	-6.82
1.920 G	20.000 G	1.00 M	1.939888 G	-23.05	-10.05

CONDUCTED SPURIOUS EMISSION

Date: 11.AUG.2020 20:30:20



Report Number: W6M22006-20020-P-247  
 FCC ID: GX9CTC1052QT

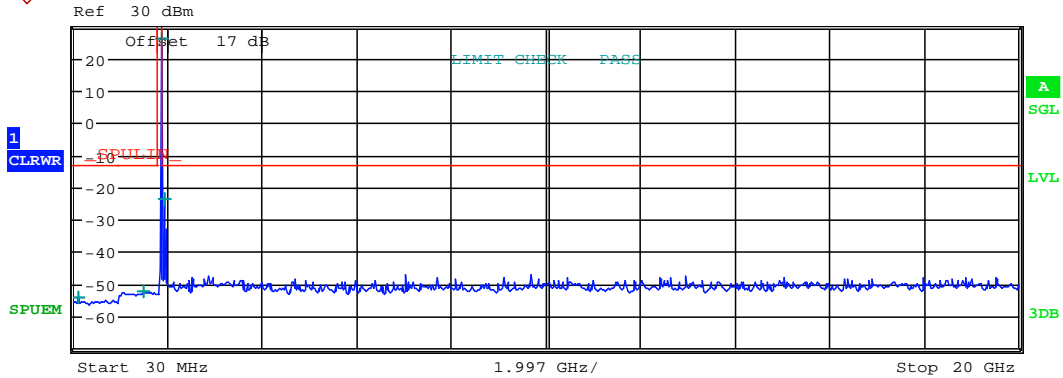

Start [Hz]	Stop [Hz]	RBW [Hz]	Freq [Hz]	PwrAbs [dBm]	ΔLimit [dB]
30.000 M	1.000 G	100.00 k	115.496795 M	-54.32	-41.32
1.000 G	1.840 G	1.00 M	1.487704 G	-52.55	-39.55
1.840 G	1.920 G	1.00 M	1.880181 G	26.02	-6.98
1.920 G	20.000 G	1.00 M	1.959173 G	-23.90	-10.90

CONDUCTED SPURIOUS EMISSION

Date: 11.AUG.2020 20:29:58





# Worldwide Testing Services(Taiwan) Co., Ltd.

Report Number: W6M22006-20020-P-247  
 FCC ID: GX9CTC1052QT

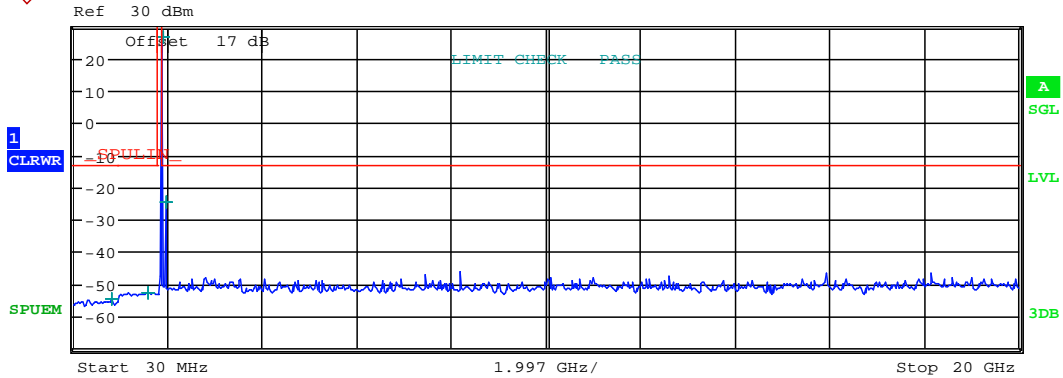

Start [Hz]	Stop [Hz]	RBW [Hz]	Freq [Hz]	PwrAbs [dBm]	ΔLimit [dB]
30.000 M	1.000 G	100.00 k	832.115385 M	-54.68	-41.68
1.000 G	1.840 G	1.00 M	1.593712 G	-52.74	-39.74
1.840 G	1.920 G	1.00 M	1.902576 G	26.42	-6.58
1.920 G	20.000 G	1.00 M	1.980869 G	-24.64	-11.64

CONDUCTED SPURIOUS EMISSION

Date: 11.AUG.2020 20:29:33



# Worldwide Testing Services(Taiwan) Co., Ltd.

Report Number: W6M22006-20020-P-247

FCC ID: GX9CTC1052QT

20MHz

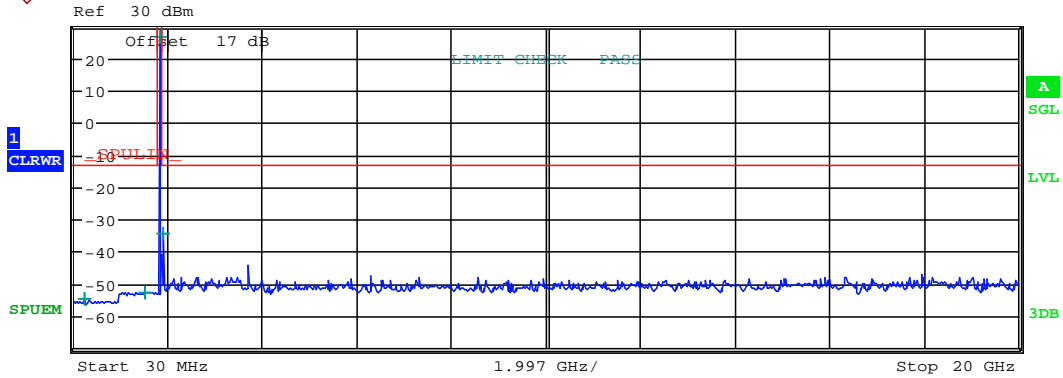

Start [Hz]	Stop [Hz]	RBW [Hz]	Freq [Hz]	PwrAbs [dBm]	ΔLimit [dB]
30.000 M	1.000 G	100.00 k	244.519231 M	-54.83	-41.83
1.000 G	1.840 G	1.00 M	1.548100 G	-52.63	-39.63
1.840 G	1.920 G	1.00 M	1.860181 G	26.46	-6.54
1.920 G	20.000 G	1.00 M	1.930245 G	-34.63	-21.63

CONDUCTED SPURIOUS EMISSION

Date: 11.AUG.2020 20:35:32



Report Number: W6M22006-20020-P-247  
 FCC ID: GX9CTC1052QT

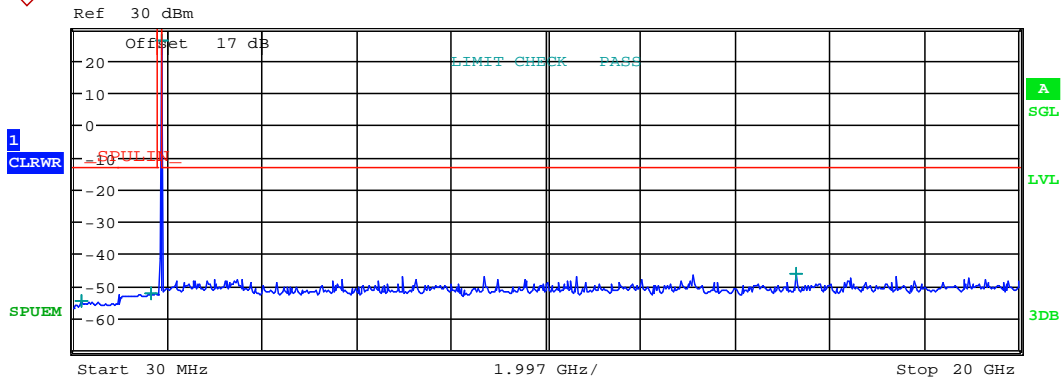

Start [Hz]	Stop [Hz]	RBW [Hz]	Freq [Hz]	PwrAbs [dBm]	ΔLimit [dB]
30.000 M	1.000 G	100.00 k	176.121795 M	-54.91	-41.91
1.000 G	1.840 G	1.00 M	1.652596 G	-52.41	-39.41
1.840 G	1.920 G	1.00 M	1.880205 G	26.01	-6.99
1.920 G	20.000 G	1.00 M	15.288352 G	-46.06	-33.06

CONDUCTED SPURIOUS EMISSION

Date: 11.AUG.2020 20:35:51



# Worldwide Testing Services(Taiwan) Co., Ltd.

Report Number: W6M22006-20020-P-247  
 FCC ID: GX9CTC1052QT

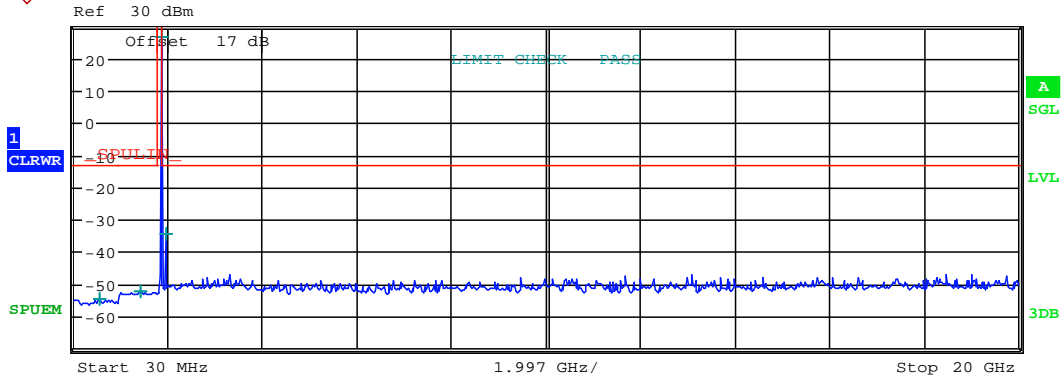

Start [Hz]	Stop [Hz]	RBW [Hz]	Freq [Hz]	PwrAbs [dBm]	Δ Limit [dB]
30.000 M	1.000 G	100.00 k	583.397436 M	-54.95	-41.95
1.000 G	1.840 G	1.00 M	1.435120 G	-52.60	-39.60
1.840 G	1.920 G	1.00 M	1.900003 G	26.30	-6.70
1.920 G	20.000 G	1.00 M	1.983883 G	-34.52	-21.52

CONDUCTED SPURIOUS EMISSION

Date: 11.AUG.2020 20:36:20



# Worldwide Testing Services(Taiwan) Co., Ltd.

Report Number: W6M22006-20020-P-247

FCC ID: GX9CTC1052QT

Band IV

16QAM

1.4MHz

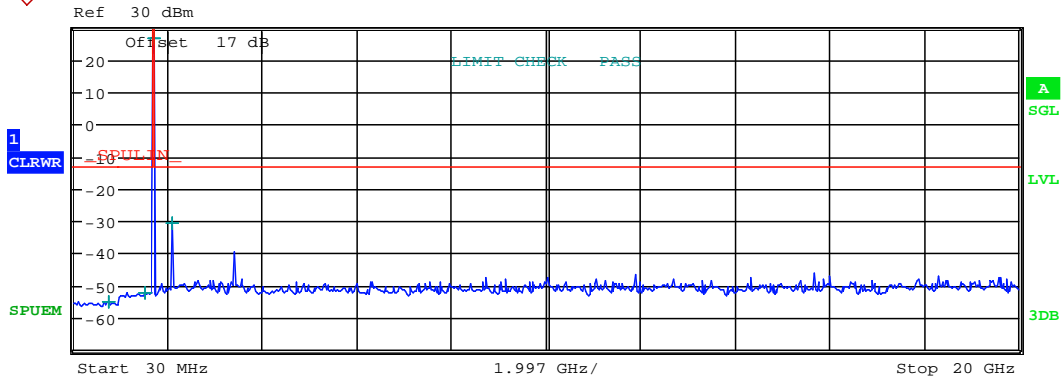

Start [Hz]	Stop [Hz]	RBW [Hz]	Freq [Hz]	PwrAbs [dBm]	ΔLimit [dB]
30.000 M	1.000 G	100.00 k	759.054487 M	-55.01	-42.01
1.000 G	1.700 G	1.00 M	1.520030 G	-52.52	-39.52
1.700 G	1.765 G	1.00 M	1.710744 G	26.44	-6.56
1.765 G	20.000 G	1.00 M	2.110249 G	-30.87	-17.87

CONDUCTED SPURIOUS EMISSION

Date: 11.AUG.2020 20:40:41



# Worldwide Testing Services(Taiwan) Co., Ltd.

Report Number: W6M22006-20020-P-247  
 FCC ID: GX9CTC1052QT

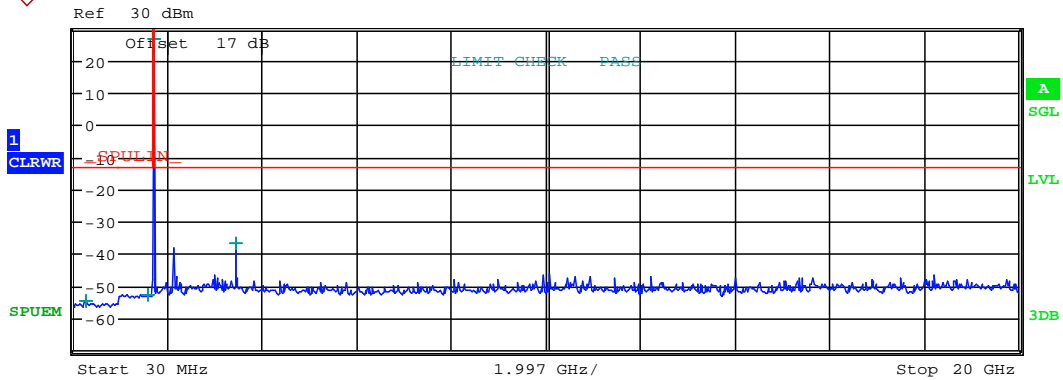

Start [Hz]	Stop [Hz]	RBW [Hz]	Freq [Hz]	PwrAbs [dBm]	Δ Limit [dB]
30.000 M	1.000 G	100.00 k	292.708333 M	-54.55	-41.55
1.000 G	1.700 G	1.00 M	1.590870 G	-52.68	-39.68
1.700 G	1.765 G	1.00 M	1.732645 G	26.41	-6.59
1.765 G	20.000 G	1.00 M	3.465110 G	-36.81	-23.81

CONDUCTED SPURIOUS EMISSION

Date: 11.AUG.2020 20:41:08



Report Number: W6M22006-20020-P-247  
 FCC ID: GX9CTC1052QT

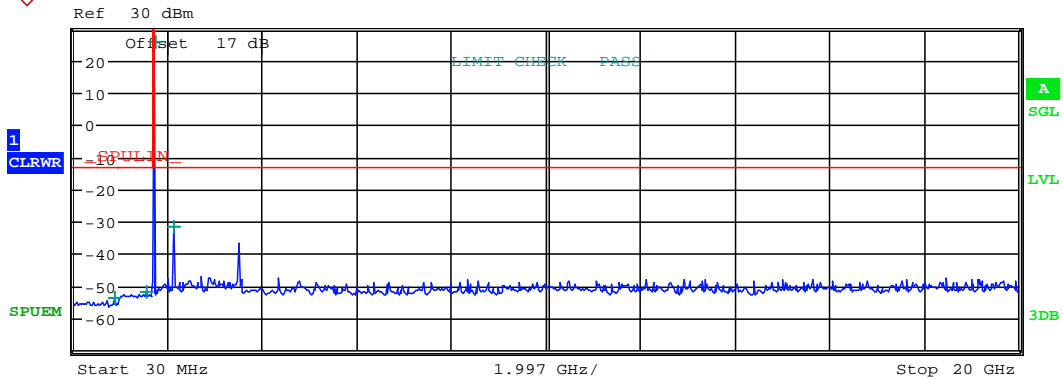

Start [Hz]	Stop [Hz]	RBW [Hz]	Freq [Hz]	PwrAbs [dBm]	Δ Limit [dB]
30.000 M	1.000 G	100.00 k	892.740385 M	-53.99	-40.99
1.000 G	1.700 G	1.00 M	1.557200 G	-51.79	-38.79
1.700 G	1.765 G	1.00 M	1.754336 G	25.45	-7.55
1.765 G	20.000 G	1.00 M	2.154013 G	-31.51	-18.51

CONDUCTED SPURIOUS EMISSION

Date: 11.AUG.2020 20:41:32



# Worldwide Testing Services(Taiwan) Co., Ltd.

Report Number: W6M22006-20020-P-247

FCC ID: GX9CTC1052QT

3MHz

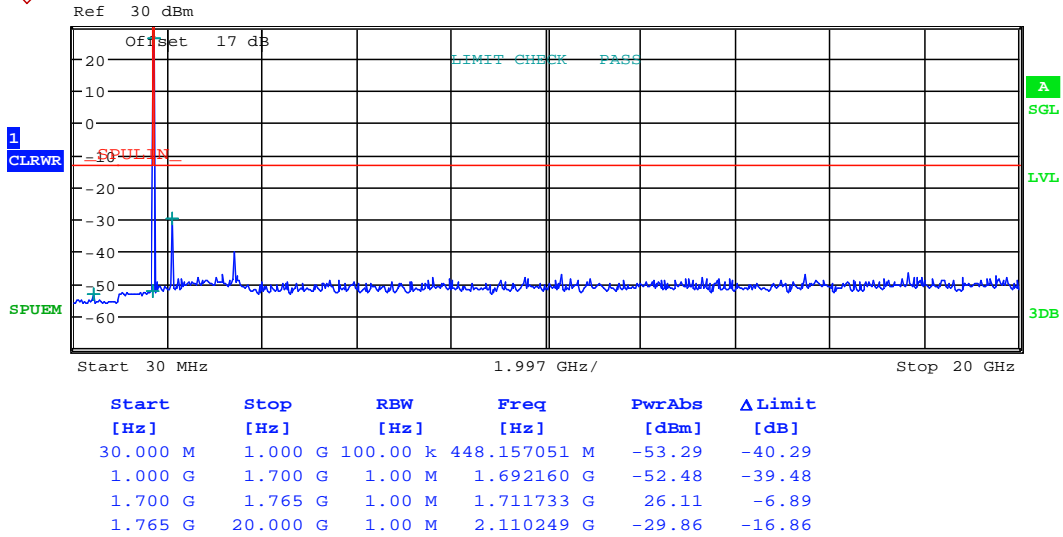

CONDUCTED SPURIOUS EMISSION

Date: 11.AUG.2020 20:44:38





# Worldwide Testing Services(Taiwan) Co., Ltd.

Report Number: W6M22006-20020-P-247  
 FCC ID: GX9CTC1052QT

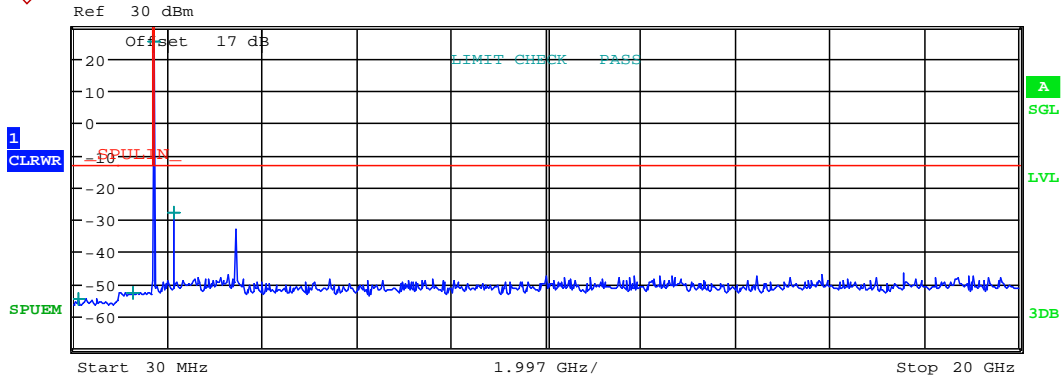

Start [Hz]	Stop [Hz]	RBW [Hz]	Freq [Hz]	PwrAbs [dBm]	ΔLimit [dB]
30.000 M	1.000 G	100.00 k	138.814103 M	-54.79	-41.79
1.000 G	1.700 G	1.00 M	1.275170 G	-52.72	-39.72
1.700 G	1.765 G	1.00 M	1.732853 G	25.14	-7.86
1.765 G	20.000 G	1.00 M	2.132739 G	-27.75	-14.75

CONDUCTED SPURIOUS EMISSION

Date: 11.AUG.2020 20:44:57



# Worldwide Testing Services(Taiwan) Co., Ltd.

Report Number: W6M22006-20020-P-247  
 FCC ID: GX9CTC1052QT

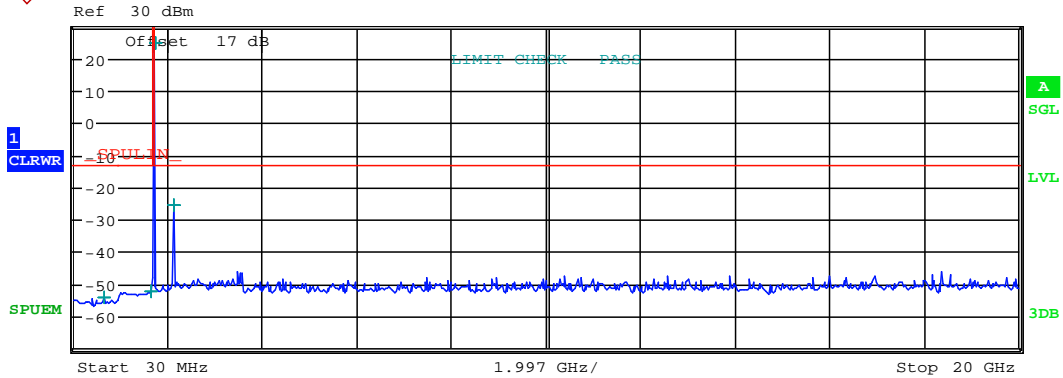

Start [Hz]	Stop [Hz]	RBW [Hz]	Freq [Hz]	PwrAbs [dBm]	ΔLimit [dB]
30.000 M	1.000 G	100.00 k	665.785256 M	-54.45	-41.45
1.000 G	1.700 G	1.00 M	1.650230 G	-52.41	-39.41
1.700 G	1.765 G	1.00 M	1.753720 G	24.73	-8.27
1.765 G	20.000 G	1.00 M	2.154013 G	-25.47	-12.47

CONDUCTED SPURIOUS EMISSION

Date: 11.AUG.2020 20:45:34



# Worldwide Testing Services(Taiwan) Co., Ltd.

Report Number: W6M22006-20020-P-247

FCC ID: GX9CTC1052QT

5MHz

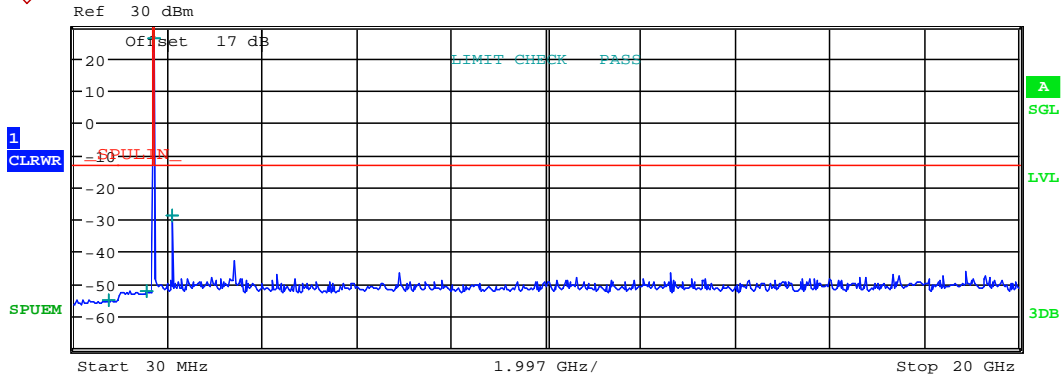

Start [Hz]	Stop [Hz]	RBW [Hz]	Freq [Hz]	PwrAbs [dBm]	ΔLimit [dB]
30.000 M	1.000 G	100.00 k	757.500000 M	-55.05	-42.05
1.000 G	1.700 G	1.00 M	1.555450 G	-52.20	-39.20
1.700 G	1.765 G	1.00 M	1.712565 G	25.90	-7.10
1.765 G	20.000 G	1.00 M	2.110857 G	-28.82	-15.82

CONDUCTED SPURIOUS EMISSION

Date: 11.AUG.2020 20:49:31



Report Number: W6M22006-20020-P-247  
 FCC ID: GX9CTC1052QT

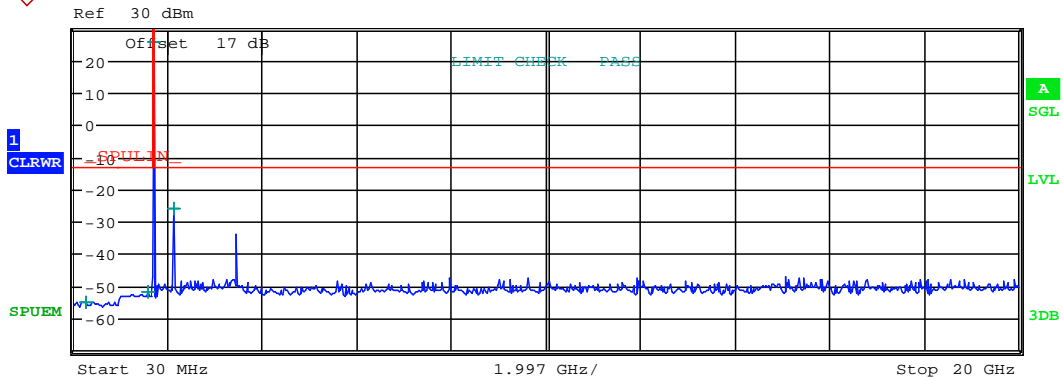

Start [Hz]	Stop [Hz]	RBW [Hz]	Freq [Hz]	PwrAbs [dBm]	Δ Limit [dB]
30.000 M	1.000 G	100.00 k	280.272436 M	-54.98	-41.98
1.000 G	1.700 G	1.00 M	1.587860 G	-52.15	-39.15
1.700 G	1.765 G	1.00 M	1.732799 G	25.55	-7.45
1.765 G	20.000 G	1.00 M	2.132739 G	-26.29	-13.29

CONDUCTED SPURIOUS EMISSION

Date: 11.AUG.2020 20:50:10



Report Number: W6M22006-20020-P-247  
 FCC ID: GX9CTC1052QT

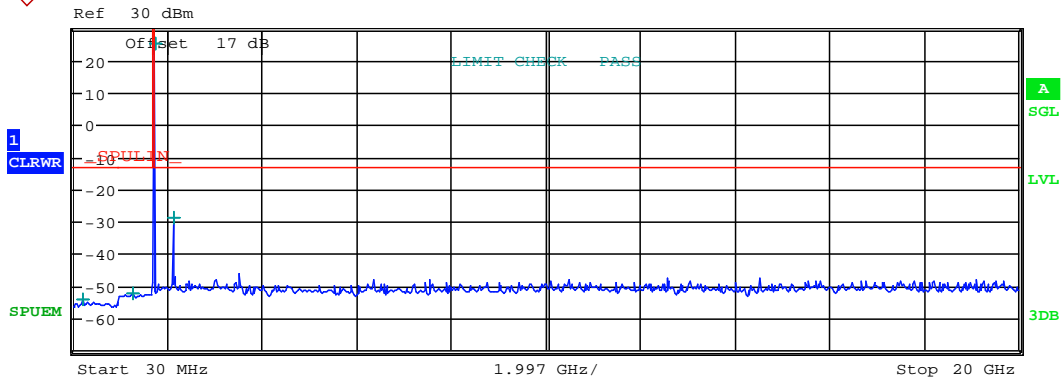

Start [Hz]	Stop [Hz]	RBW [Hz]	Freq [Hz]	PwrAbs [dBm]	ΔLimit [dB]
30.000 M	1.000 G	100.00 k	221.201923 M	-54.11	-41.11
1.000 G	1.700 G	1.00 M	1.287700 G	-52.37	-39.37
1.700 G	1.765 G	1.00 M	1.752579 G	25.22	-7.78
1.765 G	20.000 G	1.00 M	2.151582 G	-29.13	-16.13

CONDUCTED SPURIOUS EMISSION

Date: 11.AUG.2020 20:50:36



# Worldwide Testing Services(Taiwan) Co., Ltd.

Report Number: W6M22006-20020-P-247

FCC ID: GX9CTC1052QT

10MHz

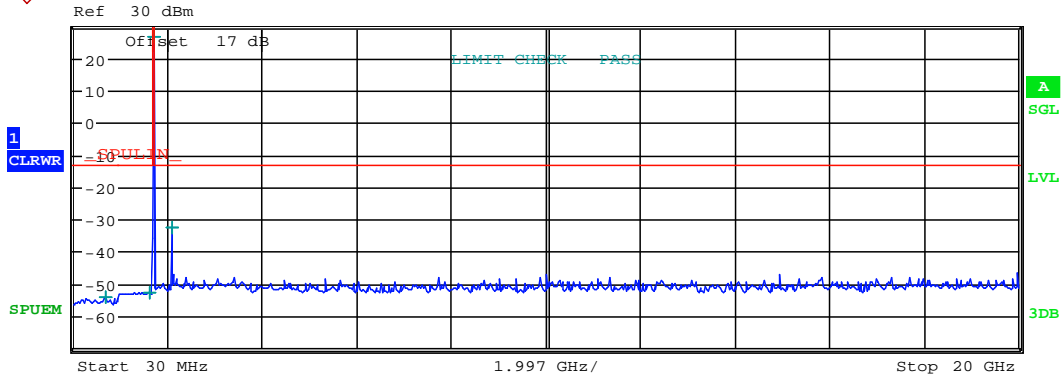

Start [Hz]	Stop [Hz]	RBW [Hz]	Freq [Hz]	PwrAbs [dBm]	ΔLimit [dB]
30.000 M	1.000 G	100.00 k	715.528846 M	-54.42	-41.42
1.000 G	1.700 G	1.00 M	1.623980 G	-52.86	-39.86
1.700 G	1.765 G	1.00 M	1.715063 G	26.49	-6.51
1.765 G	20.000 G	1.00 M	2.110249 G	-32.48	-19.48

CONDUCTED SPURIOUS EMISSION

Date: 11.AUG.2020 20:53:29



Report Number: W6M22006-20020-P-247  
 FCC ID: GX9CTC1052QT

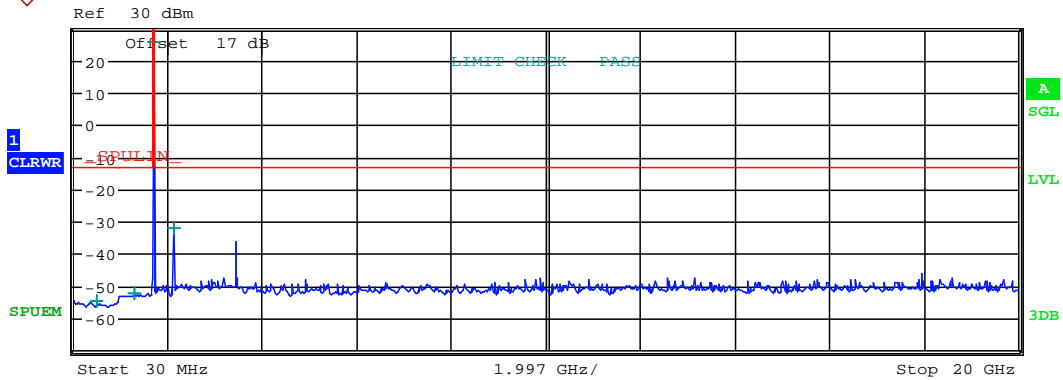

Start [Hz]	Stop [Hz]	RBW [Hz]	Freq [Hz]	PwrAbs [dBm]	Δ Limit [dB]
30.000 M	1.000 G	100.00 k	497.900641 M	-54.51	-41.51
1.000 G	1.700 G	1.00 M	1.301630 G	-52.26	-39.26
1.700 G	1.765 G	1.00 M	1.732569 G	25.59	-7.41
1.765 G	20.000 G	1.00 M	2.128484 G	-32.28	-19.28

CONDUCTED SPURIOUS EMISSION

Date: 11.AUG.2020 20:53:46



Report Number: W6M22006-20020-P-247  
 FCC ID: GX9CTC1052QT

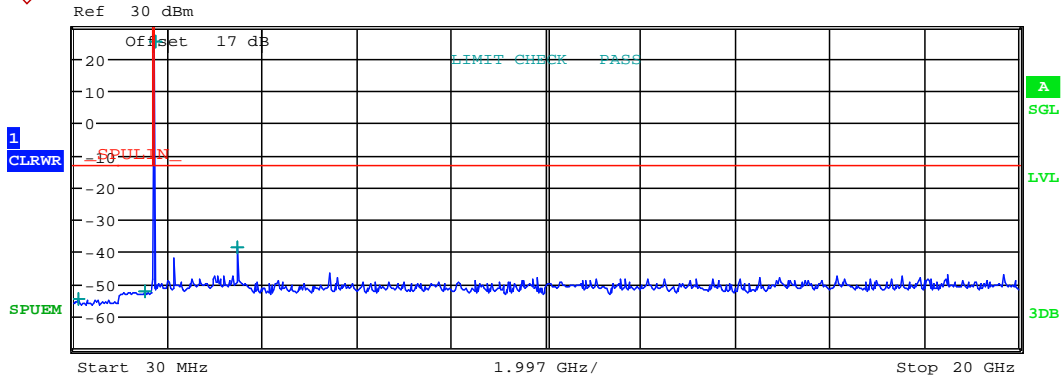

Start [Hz]	Stop [Hz]	RBW [Hz]	Freq [Hz]	PwrAbs [dBm]	ΔLimit [dB]
30.000 M	1.000 G	100.00 k	132.596154 M	-54.83	-41.83
1.000 G	1.700 G	1.00 M	1.546770 G	-52.50	-39.50
1.700 G	1.765 G	1.00 M	1.750148 G	25.15	-7.85
1.765 G	20.000 G	1.00 M	3.500364 G	-38.94	-25.94

CONDUCTED SPURIOUS EMISSION

Date: 11.AUG.2020 20:54:06





# Worldwide Testing Services(Taiwan) Co., Ltd.

Report Number: W6M22006-20020-P-247

FCC ID: GX9CTC1052QT

15MHz

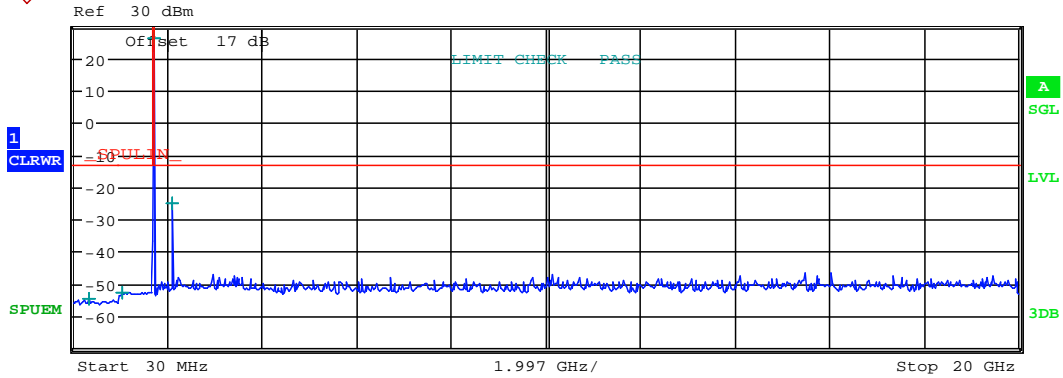

Start [Hz]	Stop [Hz]	RBW [Hz]	Freq [Hz]	PwrAbs [dBm]	ΔLimit [dB]
30.000 M	1.000 G	100.00 k	361.105769 M	-54.80	-41.80
1.000 G	1.700 G	1.00 M	1.056490 G	-52.71	-39.71
1.700 G	1.765 G	1.00 M	1.717762 G	26.16	-6.84
1.765 G	20.000 G	1.00 M	2.112073 G	-24.93	-11.93

CONDUCTED SPURIOUS EMISSION

Date: 11.AUG.2020 20:56:31



Report Number: W6M22006-20020-P-247  
 FCC ID: GX9CTC1052QT

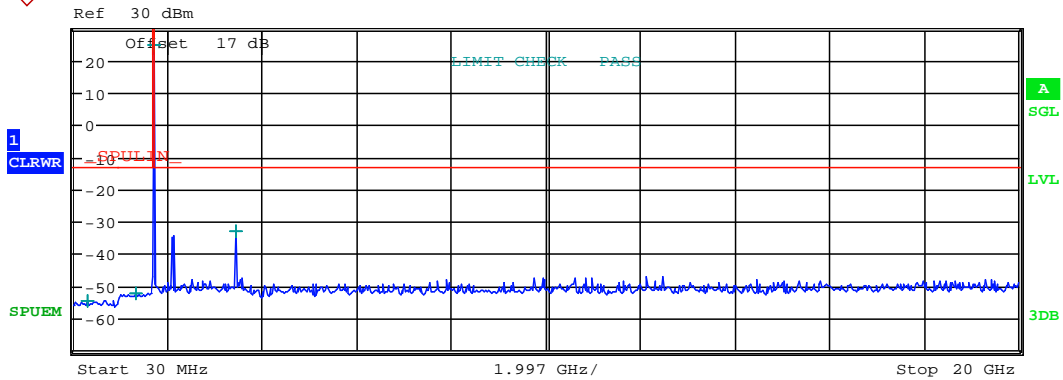

Start [Hz]	Stop [Hz]	RBW [Hz]	Freq [Hz]	PwrAbs [dBm]	Δ Limit [dB]
30.000 M	1.000 G	100.00 k	314.471154 M	-54.51	-41.51
1.000 G	1.700 G	1.00 M	1.333270 G	-52.43	-39.43
1.700 G	1.765 G	1.00 M	1.732513 G	24.40	-8.60
1.765 G	20.000 G	1.00 M	3.465110 G	-33.36	-20.36

CONDUCTED SPURIOUS EMISSION

Date: 11.AUG.2020 20:57:02



Report Number: W6M22006-20020-P-247  
 FCC ID: GX9CTC1052QT

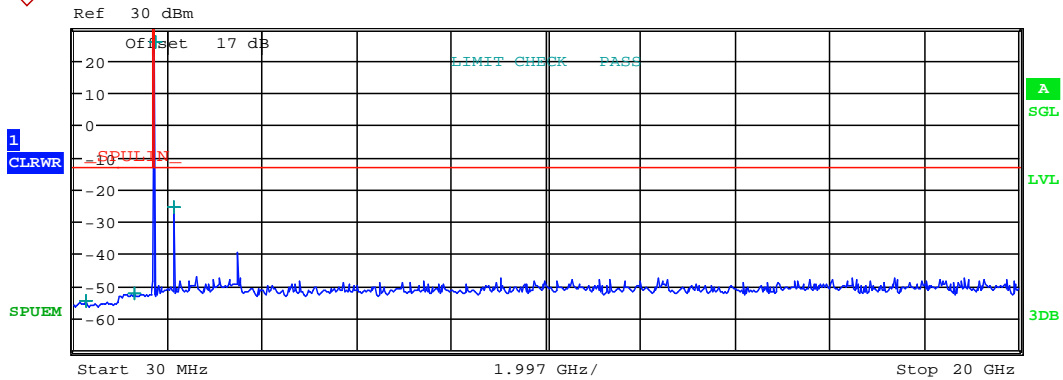

Start [Hz]	Stop [Hz]	RBW [Hz]	Freq [Hz]	PwrAbs [dBm]	ΔLimit [dB]
30.000 M	1.000 G	100.00 k	289.599359 M	-54.92	-41.92
1.000 G	1.700 G	1.00 M	1.319270 G	-52.44	-39.44
1.700 G	1.765 G	1.00 M	1.747632 G	25.35	-7.65
1.765 G	20.000 G	1.00 M	2.146111 G	-25.52	-12.52

CONDUCTED SPURIOUS EMISSION

Date: 11.AUG.2020 20:57:20



# Worldwide Testing Services(Taiwan) Co., Ltd.

Report Number: W6M22006-20020-P-247

FCC ID: GX9CTC1052QT

20MHz

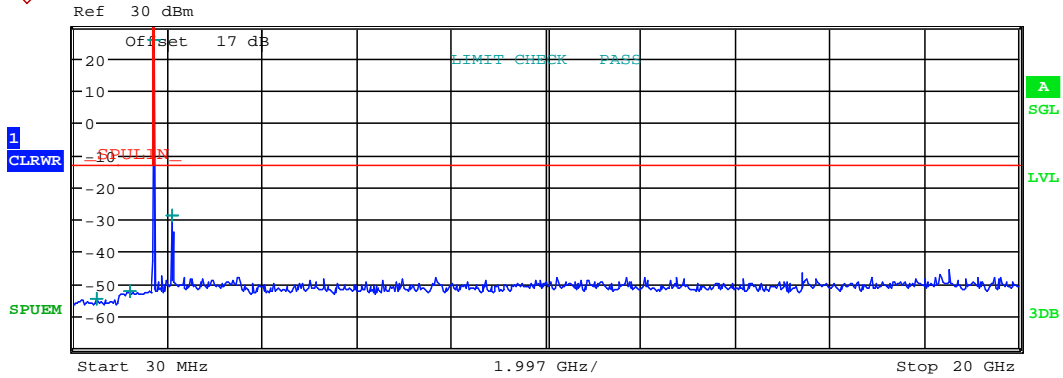

Start [Hz]	Stop [Hz]	RBW [Hz]	Freq [Hz]	PwrAbs [dBm]	ΔLimit [dB]
30.000 M	1.000 G	100.00 k	518.108974 M	-54.71	-41.71
1.000 G	1.700 G	1.00 M	1.203910 G	-52.51	-39.51
1.700 G	1.765 G	1.00 M	1.720104 G	25.43	-7.57
1.765 G	20.000 G	1.00 M	2.110857 G	-28.98	-15.98

CONDUCTED SPURIOUS EMISSION

Date: 11.AUG.2020 21:00:54



# Worldwide Testing Services(Taiwan) Co., Ltd.

Report Number: W6M22006-20020-P-247  
 FCC ID: GX9CTC1052QT

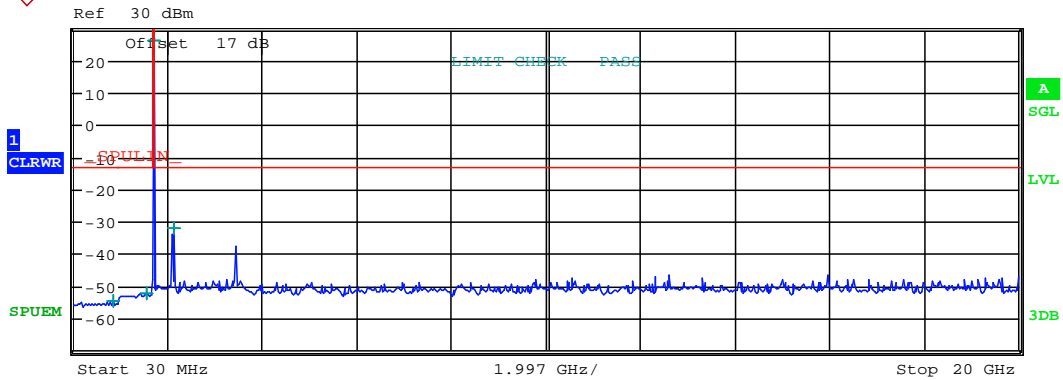

Start [Hz]	Stop [Hz]	RBW [Hz]	Freq [Hz]	PwrAbs [dBm]	ΔLimit [dB]
30.000 M	1.000 G	100.00 k	864.759615 M	-54.90	-41.90
1.000 G	1.700 G	1.00 M	1.577780 G	-52.26	-39.26
1.700 G	1.765 G	1.00 M	1.732513 G	26.19	-6.81
1.765 G	20.000 G	1.00 M	2.132131 G	-32.07	-19.07

CONDUCTED SPURIOUS EMISSION

Date: 11.AUG.2020 21:01:30



Report Number: W6M22006-20020-P-247  
 FCC ID: GX9CTC1052QT

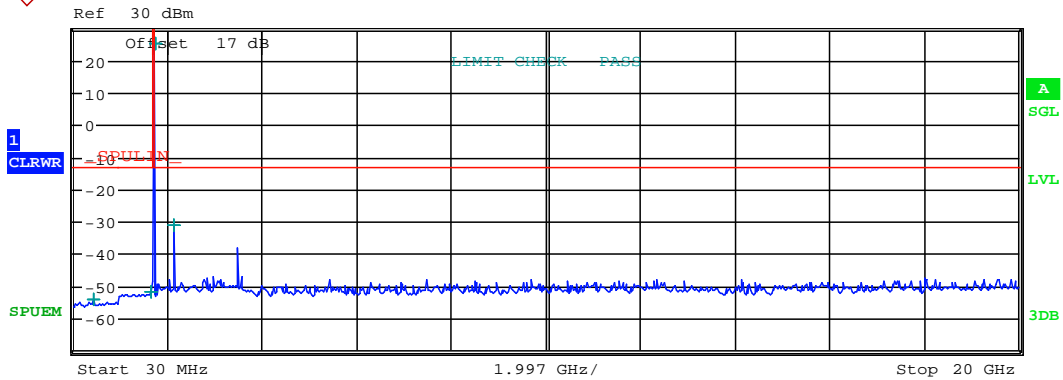

Start [Hz]	Stop [Hz]	RBW [Hz]	Freq [Hz]	PwrAbs [dBm]	ΔLimit [dB]
30.000 M	1.000 G	100.00 k	459.038462 M	-54.32	-41.32
1.000 G	1.700 G	1.00 M	1.651070 G	-51.83	-38.83
1.700 G	1.765 G	1.00 M	1.745153 G	25.06	-7.94
1.765 G	20.000 G	1.00 M	2.152190 G	-31.40	-18.40

CONDUCTED SPURIOUS EMISSION

Date: 11.AUG.2020 21:01:56



# Worldwide Testing Services(Taiwan) Co., Ltd.

Report Number: W6M22006-20020-P-247

FCC ID: GX9CTC1052QT

QPSK

1.4MHz

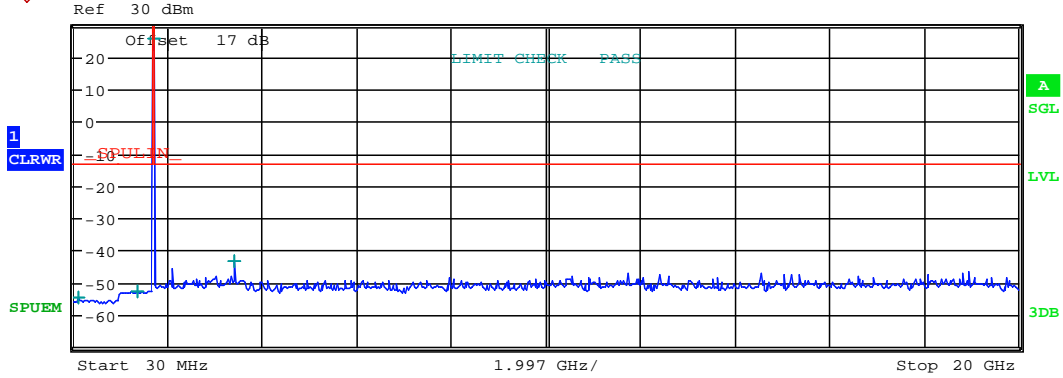

Start [Hz]	Stop [Hz]	RBW [Hz]	Freq [Hz]	PwrAbs [dBm]	ΔLimit [dB]
30.000 M	1.000 G	100.00 k	137.259615 M	-54.65	-41.65
1.000 G	1.700 G	1.00 M	1.388640 G	-52.90	-39.90
1.700 G	1.765 G	1.00 M	1.710914 G	25.62	-7.38
1.765 G	20.000 G	1.00 M	3.421954 G	-43.40	-30.40

CONDUCTED SPURIOUS EMISSION

Date: 11.AUG.2020 20:43:19



# Worldwide Testing Services(Taiwan) Co., Ltd.

Report Number: W6M22006-20020-P-247  
 FCC ID: GX9CTC1052QT

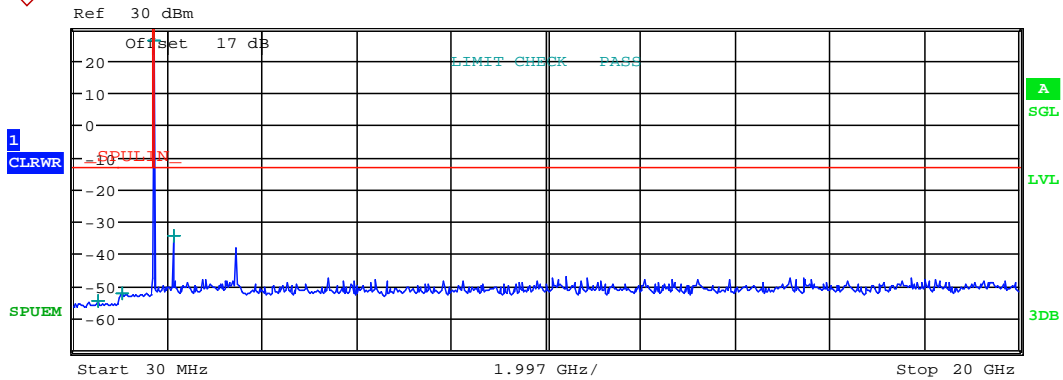

Start [Hz]	Stop [Hz]	RBW [Hz]	Freq [Hz]	PwrAbs [dBm]	Δ Limit [dB]
30.000 M	1.000 G	100.00 k	549.198718 M	-54.83	-41.83
1.000 G	1.700 G	1.00 M	1.064470 G	-52.37	-39.37
1.700 G	1.765 G	1.00 M	1.732669 G	25.92	-7.08
1.765 G	20.000 G	1.00 M	2.133347 G	-34.52	-21.52

CONDUCTED SPURIOUS EMISSION

Date: 11.AUG.2020 20:42:56





Report Number: W6M22006-20020-P-247  
 FCC ID: GX9CTC1052QT

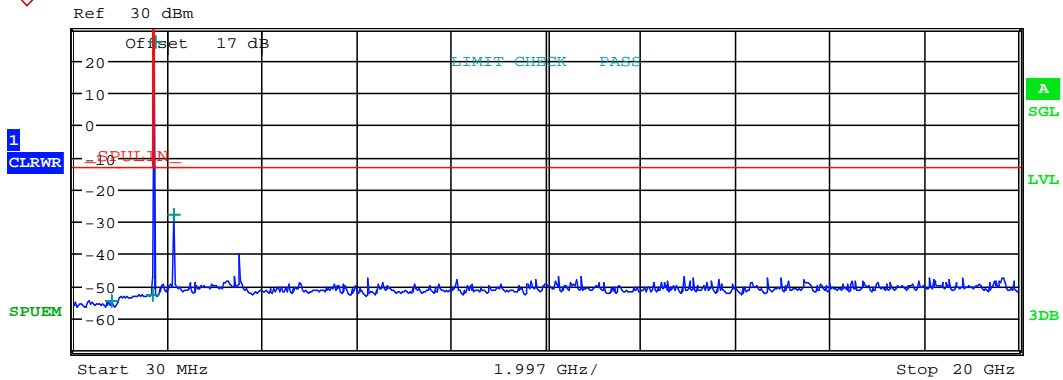

Start [Hz]	Stop [Hz]	RBW [Hz]	Freq [Hz]	PwrAbs [dBm]	ΔLimit [dB]
30.000 M	1.000 G	100.00 k	825.897436 M	-54.85	-41.85
1.000 G	1.700 G	1.00 M	1.693700 G	-52.69	-39.69
1.700 G	1.765 G	1.00 M	1.754312 G	25.58	-7.42
1.765 G	20.000 G	1.00 M	2.153405 G	-28.18	-15.18

CONDUCTED SPURIOUS EMISSION

Date: 11.AUG.2020 20:42:33



Report Number: W6M22006-20020-P-247

FCC ID: GX9CTC1052QT

3MHz

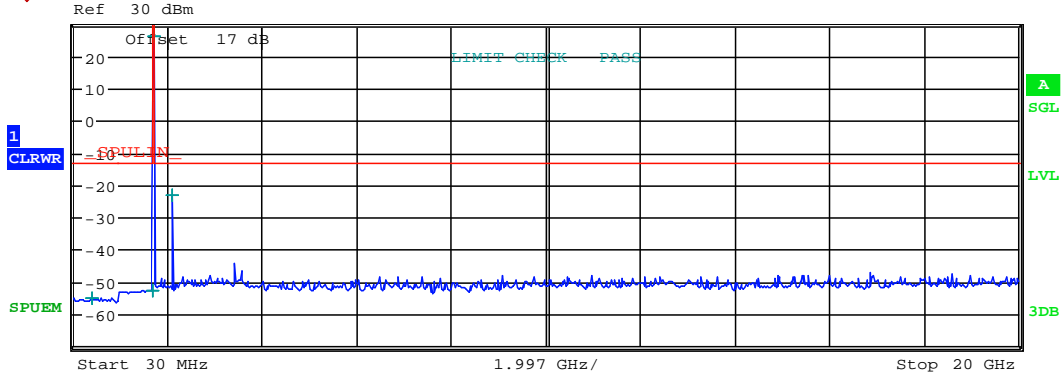

Start [Hz]	Stop [Hz]	RBW [Hz]	Freq [Hz]	PwrAbs [dBm]	ΔLimit [dB]
30.000 M	1.000 G	100.00 k	409.294872 M	-55.02	-42.02
1.000 G	1.700 G	1.00 M	1.699860 G	-52.81	-39.81
1.700 G	1.765 G	1.00 M	1.711613 G	26.02	-6.98
1.765 G	20.000 G	1.00 M	2.112073 G	-23.50	-10.50

CONDUCTED SPURIOUS EMISSION

Date: 11.AUG.2020 20:46:21



Report Number: W6M22006-20020-P-247  
 FCC ID: GX9CTC1052QT

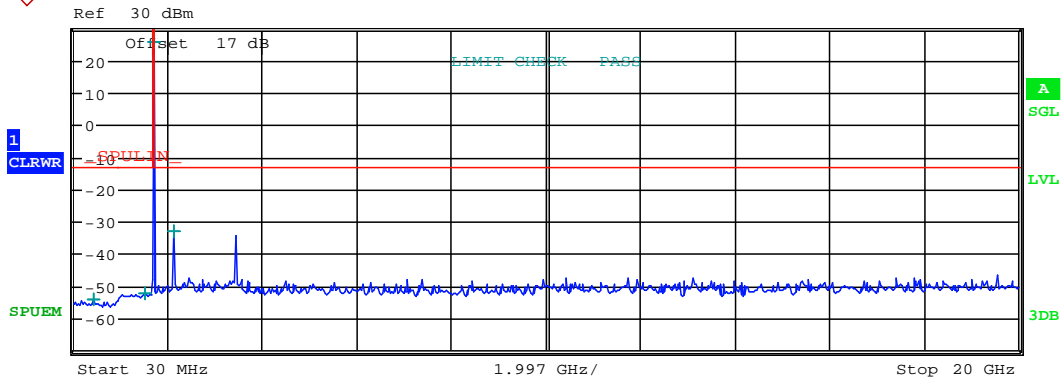

Start [Hz]	Stop [Hz]	RBW [Hz]	Freq [Hz]	PwrAbs [dBm]	ΔLimit [dB]
30.000 M	1.000 G	100.00 k	457.483974 M	-54.48	-41.48
1.000 G	1.700 G	1.00 M	1.542360 G	-52.54	-39.54
1.700 G	1.765 G	1.00 M	1.732689 G	25.71	-7.29
1.765 G	20.000 G	1.00 M	2.132131 G	-33.02	-20.02

CONDUCTED SPURIOUS EMISSION

Date: 11.AUG.2020 20:46:50



Report Number: W6M22006-20020-P-247  
 FCC ID: GX9CTC1052QT

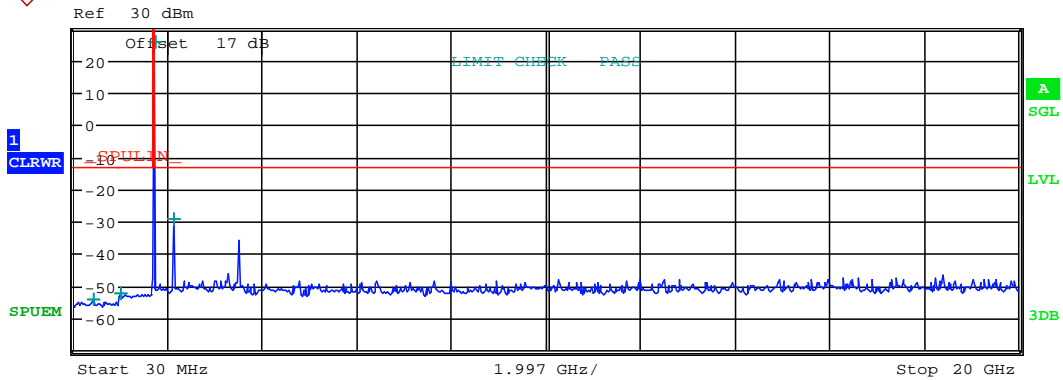

Start [Hz]	Stop [Hz]	RBW [Hz]	Freq [Hz]	PwrAbs [dBm]	ΔLimit [dB]
30.000 M	1.000 G	100.00 k	434.166667 M	-54.11	-41.11
1.000 G	1.700 G	1.00 M	1.036120 G	-52.50	-39.50
1.700 G	1.765 G	1.00 M	1.753762 G	25.70	-7.30
1.765 G	20.000 G	1.00 M	2.154013 G	-29.60	-16.60

CONDUCTED SPURIOUS EMISSION

Date: 11.AUG.2020 20:47:11



# Worldwide Testing Services(Taiwan) Co., Ltd.

Report Number: W6M22006-20020-P-247

FCC ID: GX9CTC1052QT

5MHz

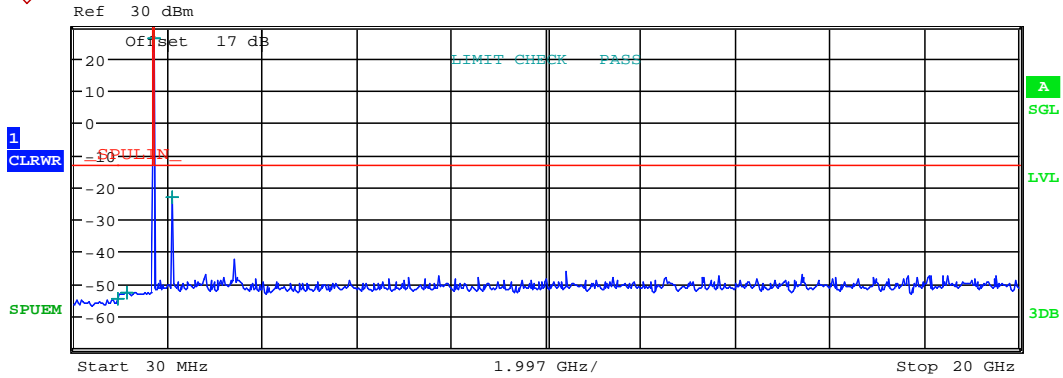

Start [Hz]	Stop [Hz]	RBW [Hz]	Freq [Hz]	PwrAbs [dBm]	ΔLimit [dB]
30.000 M	1.000 G	100.00 k	942.483974 M	-54.71	-41.71
1.000 G	1.700 G	1.00 M	1.145250 G	-52.65	-39.65
1.700 G	1.765 G	1.00 M	1.712679 G	25.89	-7.11
1.765 G	20.000 G	1.00 M	2.113288 G	-23.28	-10.28

CONDUCTED SPURIOUS EMISSION

Date: 11.AUG.2020 20:52:07



Report Number: W6M22006-20020-P-247  
 FCC ID: GX9CTC1052QT

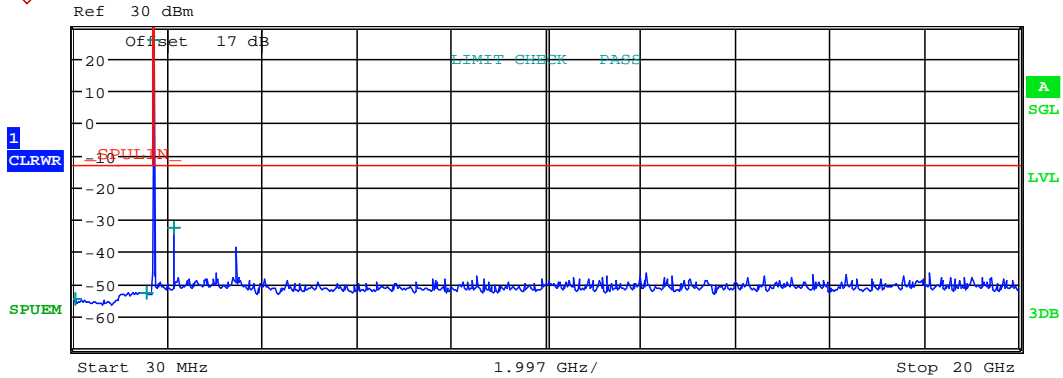

Start [Hz]	Stop [Hz]	RBW [Hz]	Freq [Hz]	PwrAbs [dBm]	ΔLimit [dB]
30.000 M	1.000 G	100.00 k	65.753205 M	-54.86	-41.86
1.000 G	1.700 G	1.00 M	1.570430 G	-52.71	-39.71
1.700 G	1.765 G	1.00 M	1.732747 G	25.36	-7.64
1.765 G	20.000 G	1.00 M	2.131524 G	-32.52	-19.52

CONDUCTED SPURIOUS EMISSION

Date: 11.AUG.2020 20:51:42



Report Number: W6M22006-20020-P-247  
 FCC ID: GX9CTC1052QT

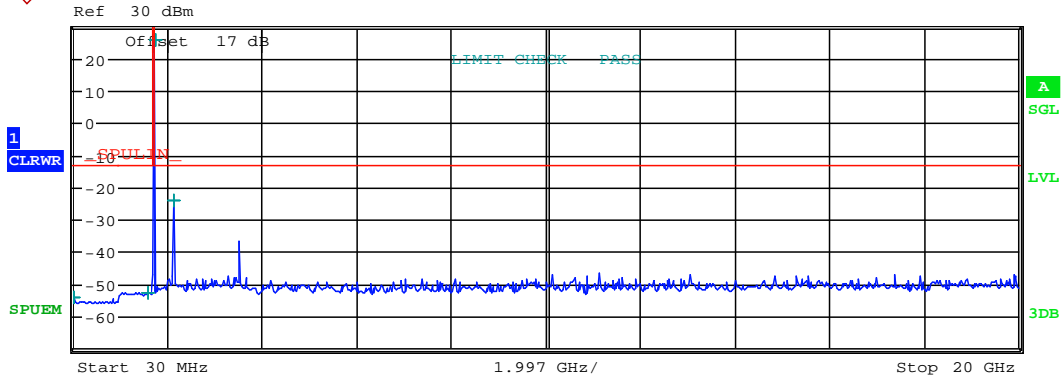

Start [Hz]	Stop [Hz]	RBW [Hz]	Freq [Hz]	PwrAbs [dBm]	ΔLimit [dB]
30.000 M	1.000 G	100.00 k	34.663462 M	-54.35	-41.35
1.000 G	1.700 G	1.00 M	1.608440 G	-52.68	-39.68
1.700 G	1.765 G	1.00 M	1.752704 G	25.60	-7.40
1.765 G	20.000 G	1.00 M	2.151582 G	-24.43	-11.43

CONDUCTED SPURIOUS EMISSION

Date: 11.AUG.2020 20:51:13



# Worldwide Testing Services(Taiwan) Co., Ltd.

Report Number: W6M22006-20020-P-247

FCC ID: GX9CTC1052QT

10MHz

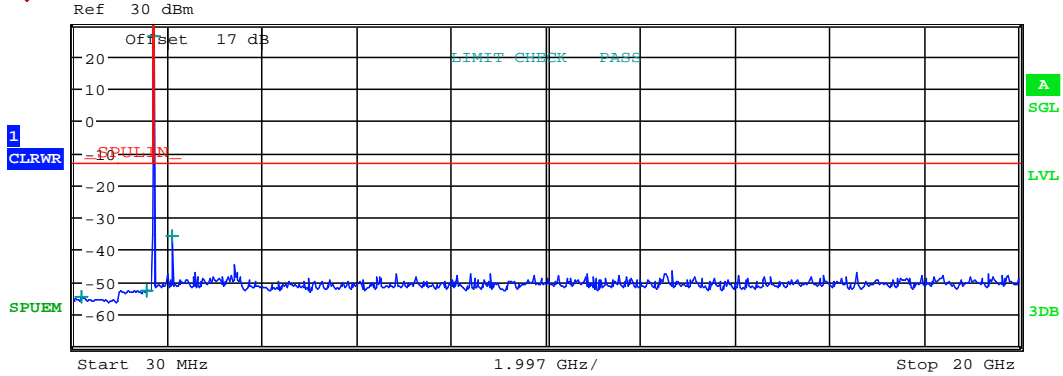

Start [Hz]	Stop [Hz]	RBW [Hz]	Freq [Hz]	PwrAbs [dBm]	ΔLimit [dB]
30.000 M	1.000 G	100.00 k	183.894231 M	-54.87	-41.87
1.000 G	1.700 G	1.00 M	1.559370 G	-52.69	-39.69
1.700 G	1.765 G	1.00 M	1.715000 G	25.91	-7.09
1.765 G	20.000 G	1.00 M	2.110249 G	-36.09	-23.09

CONDUCTED SPURIOUS EMISSION

Date: 11.AUG.2020 20:55:10





Report Number: W6M22006-20020-P-247  
 FCC ID: GX9CTC1052QT

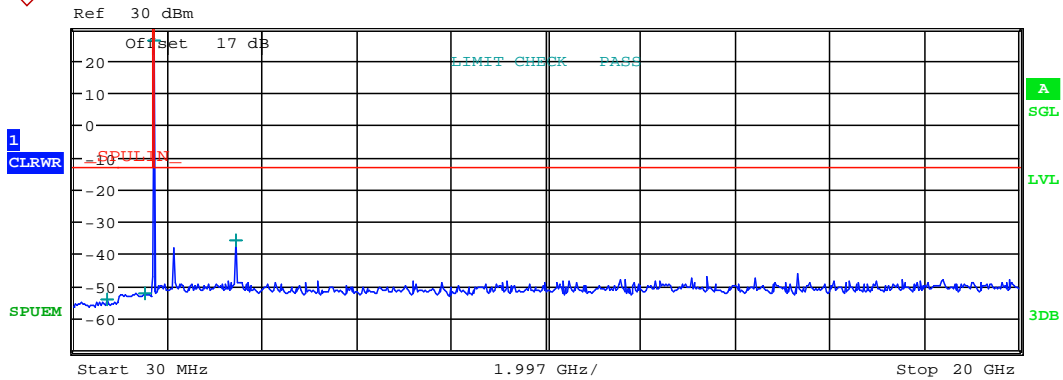

Start [Hz]	Stop [Hz]	RBW [Hz]	Freq [Hz]	PwrAbs [dBm]	ΔLimit [dB]
30.000 M	1.000 G	100.00 k	748.173077 M	-54.34	-41.34
1.000 G	1.700 G	1.00 M	1.548520 G	-52.29	-39.29
1.700 G	1.765 G	1.00 M	1.732589 G	26.04	-6.96
1.765 G	20.000 G	1.00 M	3.465110 G	-35.85	-22.85

CONDUCTED SPURIOUS EMISSION

Date: 11.AUG.2020 20:54:51



Report Number: W6M22006-20020-P-247  
 FCC ID: GX9CTC1052QT

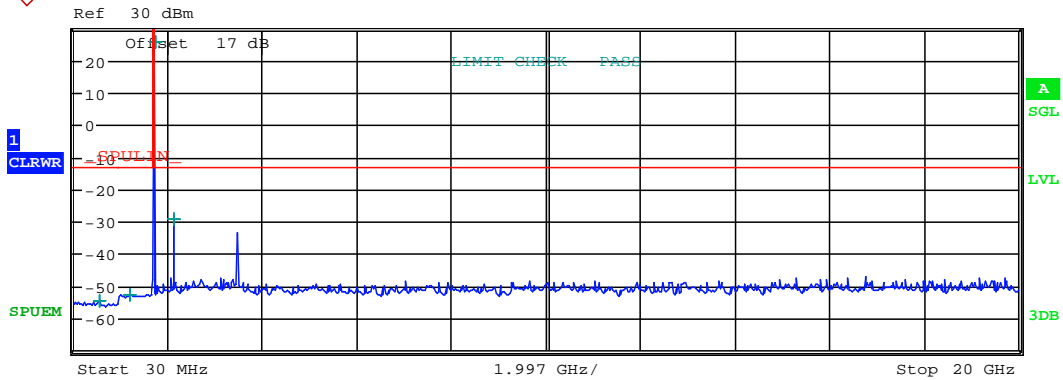

Start [Hz]	Stop [Hz]	RBW [Hz]	Freq [Hz]	PwrAbs [dBm]	ΔLimit [dB]
30.000 M	1.000 G	100.00 k	583.397436 M	-54.61	-41.61
1.000 G	1.700 G	1.00 M	1.206430 G	-52.78	-39.78
1.700 G	1.765 G	1.00 M	1.750158 G	25.54	-7.46
1.765 G	20.000 G	1.00 M	2.146111 G	-29.24	-16.24

CONDUCTED SPURIOUS EMISSION

Date: 11.AUG.2020 20:54:27



# Worldwide Testing Services(Taiwan) Co., Ltd.

Report Number: W6M22006-20020-P-247

FCC ID: GX9CTC1052QT

15MHz

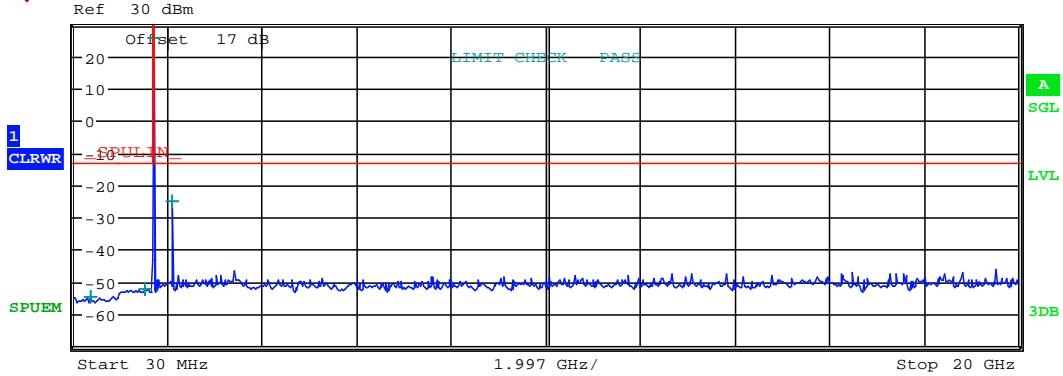

Start [Hz]	Stop [Hz]	RBW [Hz]	Freq [Hz]	PwrAbs [dBm]	ΔLimit [dB]
30.000 M	1.000 G	100.00 k	389.086538 M	-54.54	-41.54
1.000 G	1.700 G	1.00 M	1.530810 G	-52.62	-39.62
1.700 G	1.765 G	1.00 M	1.717719 G	25.56	-7.44
1.765 G	20.000 G	1.00 M	2.119975 G	-25.02	-12.02

CONDUCTED SPURIOUS EMISSION

Date: 11.AUG.2020 20:58:16



Report Number: W6M22006-20020-P-247  
 FCC ID: GX9CTC1052QT

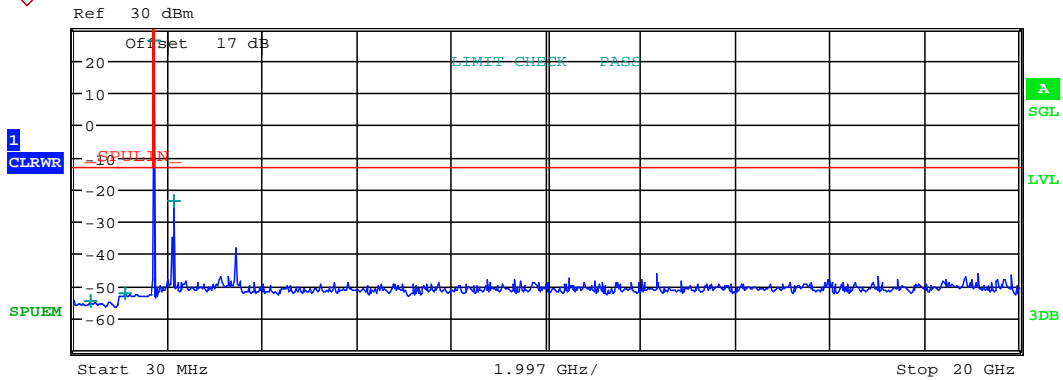

Start [Hz]	Stop [Hz]	RBW [Hz]	Freq [Hz]	PwrAbs [dBm]	ΔLimit [dB]
30.000 M	1.000 G	100.00 k	376.650641 M	-54.88	-41.88
1.000 G	1.700 G	1.00 M	1.108920 G	-52.42	-39.42
1.700 G	1.765 G	1.00 M	1.732680 G	26.02	-6.98
1.765 G	20.000 G	1.00 M	2.127877 G	-23.86	-10.86

CONDUCTED SPURIOUS EMISSION

Date: 11.AUG.2020 20:57:59



# Worldwide Testing Services(Taiwan) Co., Ltd.

Report Number: W6M22006-20020-P-247  
 FCC ID: GX9CTC1052QT

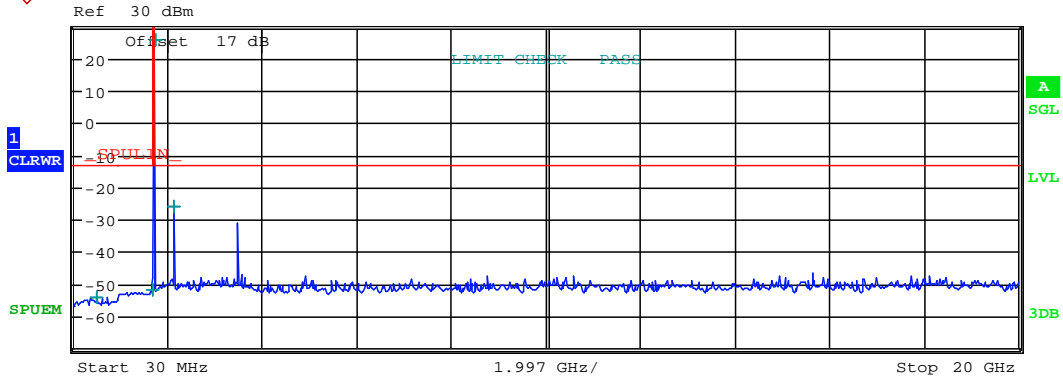

Start [Hz]	Stop [Hz]	RBW [Hz]	Freq [Hz]	PwrAbs [dBm]	Δ Limit [dB]
30.000 M	1.000 G	100.00 k	508.782051 M	-54.31	-41.31
1.000 G	1.700 G	1.00 M	1.690410 G	-52.15	-39.15
1.700 G	1.765 G	1.00 M	1.747704 G	25.47	-7.53
1.765 G	20.000 G	1.00 M	2.148543 G	-26.29	-13.29

CONDUCTED SPURIOUS EMISSION

Date: 11.AUG.2020 20:57:40

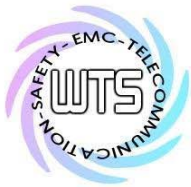

# Worldwide Testing Services(Taiwan) Co., Ltd.

Report Number: W6M22006-20020-P-247

FCC ID: GX9CTC1052QT

20MHz

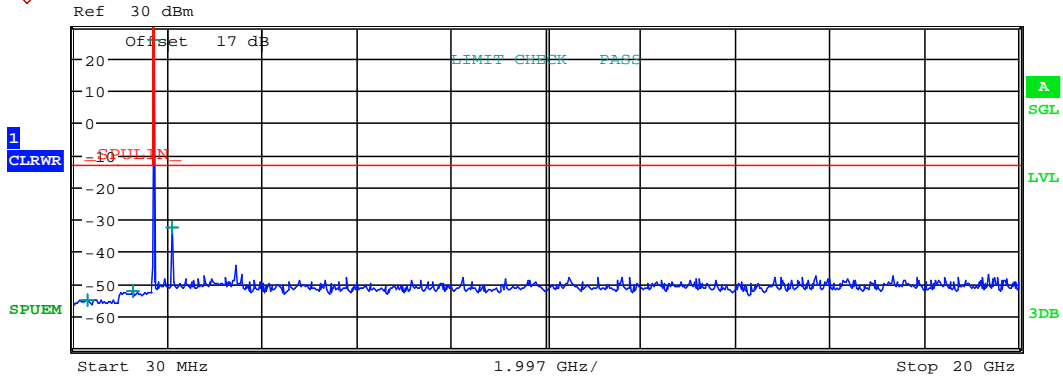

Start [Hz]	Stop [Hz]	RBW [Hz]	Freq [Hz]	PwrAbs [dBm]	ΔLimit [dB]
30.000 M	1.000 G	100.00 k	323.798077 M	-55.13	-42.13
1.000 G	1.700 G	1.00 M	1.280770 G	-52.61	-39.61
1.700 G	1.765 G	1.00 M	1.720157 G	25.54	-7.46
1.765 G	20.000 G	1.00 M	2.110249 G	-32.79	-19.79

CONDUCTED SPURIOUS EMISSION

Date: 11.AUG.2020 21:03:21



Report Number: W6M22006-20020-P-247  
 FCC ID: GX9CTC1052QT

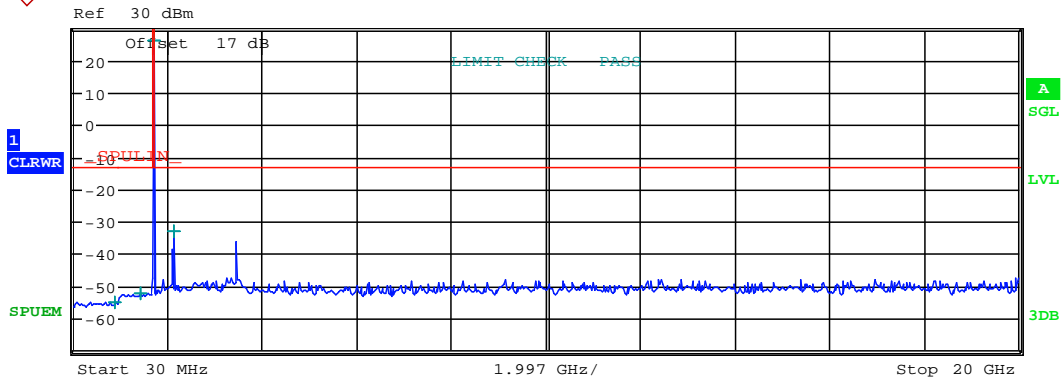

Start [Hz]	Stop [Hz]	RBW [Hz]	Freq [Hz]	PwrAbs [dBm]	ΔLimit [dB]
30.000 M	1.000 G	100.00 k	909.839744 M	-55.21	-42.21
1.000 G	1.700 G	1.00 M	1.435190 G	-52.40	-39.40
1.700 G	1.765 G	1.00 M	1.732400 G	25.79	-7.21
1.765 G	20.000 G	1.00 M	2.128484 G	-32.96	-19.96

CONDUCTED SPURIOUS EMISSION

Date: 11.AUG.2020 21:02:54







# Worldwide Testing Services(Taiwan) Co., Ltd.

Report Number: W6M22006-20020-P-247  
 FCC ID: GX9CTC1052QT

Band V  
 16QAM  
 1.4MHz

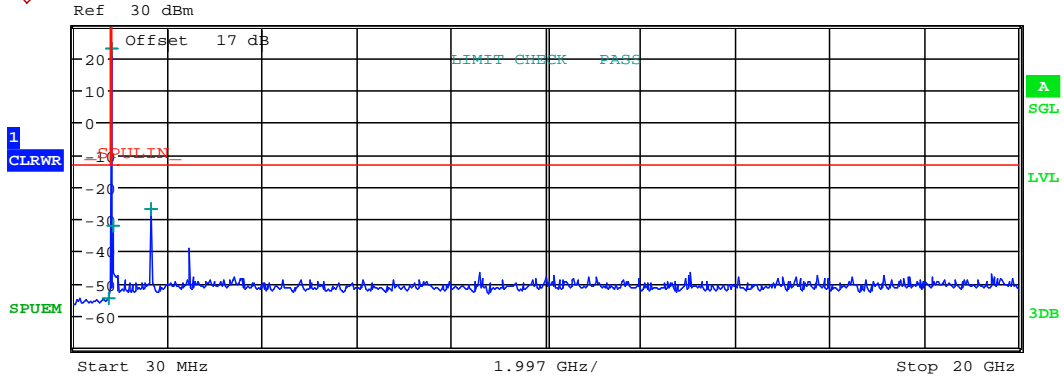

Start [Hz]	Stop [Hz]	RBW [Hz]	Freq [Hz]	PwrAbs [dBm]	ΔLimit [dB]
30.000 M	814.000 M	100.00 k	757.461538 M	-54.59	-41.59
814.000 M	859.000 M	100.00 k	824.800000 M	22.88	-10.12
859.000 M	1.000 G	100.00 k	869.255400 M	-32.30	-19.30
1.000 G	20.000 G	1.00 M	1.649167 G	-26.96	-13.96

CONDUCTED SPURIOUS EMISSION  
 Date: 11.AUG.2020 21:11:34



Report Number: W6M22006-20020-P-247  
 FCC ID: GX9CTC1052QT

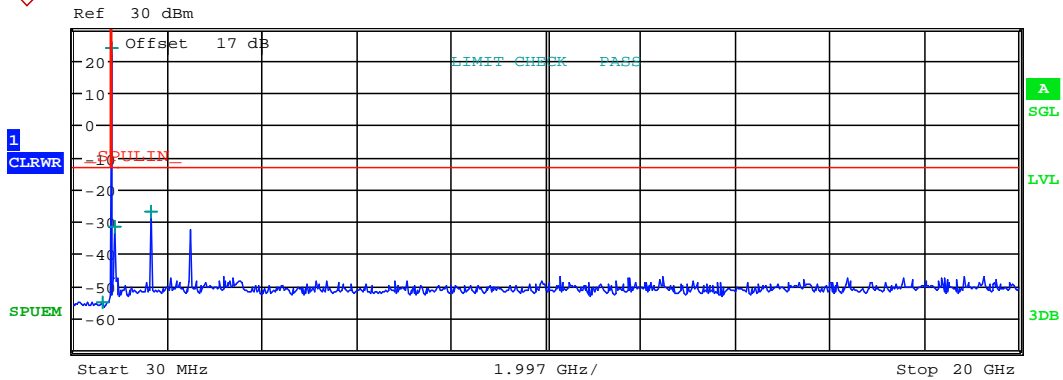

Start 30 MHz 1.997 GHz/ Stop 20 GHz

Start [Hz]	Stop [Hz]	RBW [Hz]	Freq [Hz]	PwrAbs [dBm]	ΔLimit [dB]
30.000 M	814.000 M	100.00 k	646.897436 M	-55.23	-42.23
814.000 M	859.000 M	100.00 k	836.608000 M	23.50	-9.50
859.000 M	1.000 G	100.00 k	881.348500 M	-31.71	-18.71
1.000 G	20.000 G	1.00 M	1.673233 G	-26.91	-13.91

CONDUCTED SPURIOUS EMISSION

Date: 11.AUG.2020 21:12:01



# Worldwide Testing Services(Taiwan) Co., Ltd.

Report Number: W6M22006-20020-P-247  
 FCC ID: GX9CTC1052QT

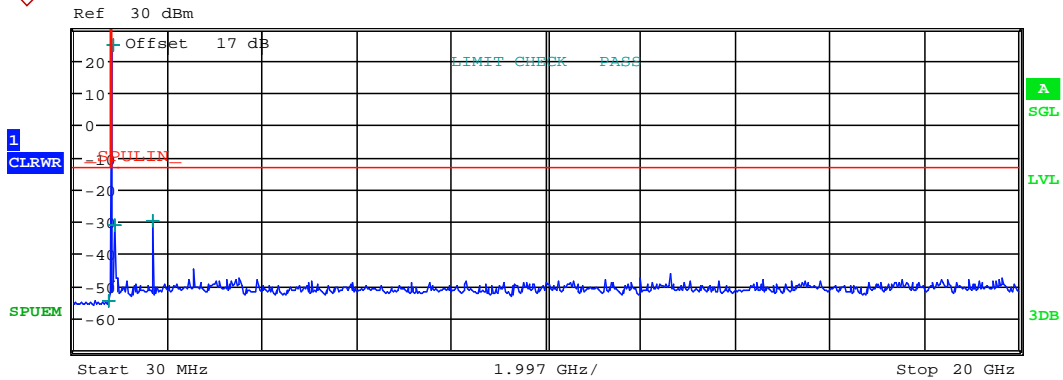

Start 30 MHz 1.997 GHz/ Stop 20 GHz

Start [Hz]	Stop [Hz]	RBW [Hz]	Freq [Hz]	PwrAbs [dBm]	ΔLimit [dB]
30.000 M	814.000 M	100.00 k	762.487179 M	-54.59	-41.59
814.000 M	859.000 M	100.00 k	848.375500 M	24.72	-8.28
859.000 M	1.000 G	100.00 k	893.122000 M	-31.13	-18.13
1.000 G	20.000 G	1.00 M	1.696033 G	-29.76	-16.76

CONDUCTED SPURIOUS EMISSION

Date: 11.AUG.2020 21:12:33



# Worldwide Testing Services(Taiwan) Co., Ltd.

Report Number: W6M22006-20020-P-247

FCC ID: GX9CTC1052QT

3MHz

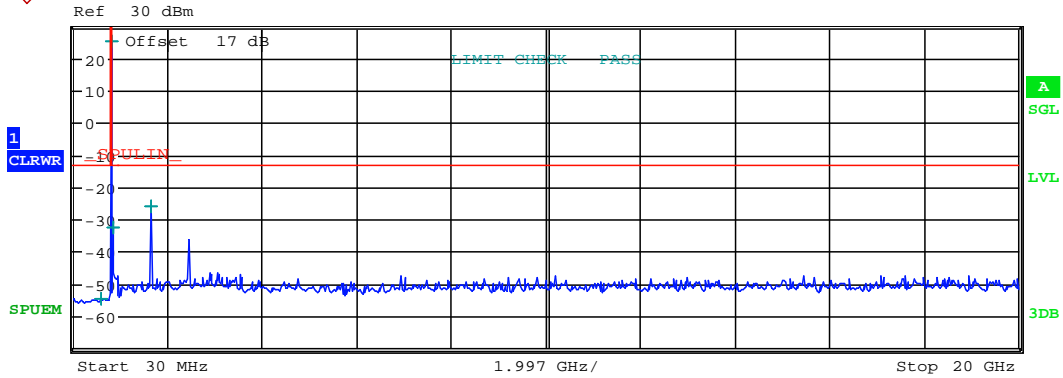

Start [Hz]	Stop [Hz]	RBW [Hz]	Freq [Hz]	PwrAbs [dBm]	ΔLimit [dB]
30.000 M	814.000 M	100.00 k	602.923077 M	-54.89	-41.89
814.000 M	859.000 M	100.00 k	825.682000 M	24.92	-8.08
859.000 M	1.000 G	100.00 k	871.765200 M	-32.80	-19.80
1.000 G	20.000 G	1.00 M	1.651067 G	-26.07	-13.07

CONDUCTED SPURIOUS EMISSION

Date: 11.AUG.2020 21:18:37





Report Number: W6M22006-20020-P-247  
 FCC ID: GX9CTC1052QT

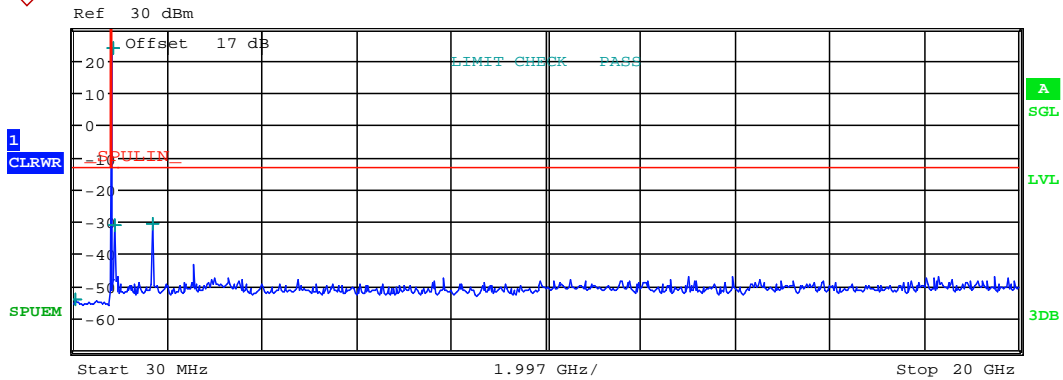

Start 30 MHz 1.997 GHz/ Stop 20 GHz

Start [Hz]	Stop [Hz]	RBW [Hz]	Freq [Hz]	PwrAbs [dBm]	Δ Limit [dB]
30.000 M	814.000 M	100.00 k	65.179487 M	-54.50	-41.50
814.000 M	859.000 M	100.00 k	847.687000 M	23.59	-9.41
859.000 M	1.000 G	100.00 k	892.285400 M	-31.27	-18.27
1.000 G	20.000 G	1.00 M	1.695400 G	-30.67	-17.67

CONDUCTED SPURIOUS EMISSION

Date: 11.AUG.2020 21:19:22



# Worldwide Testing Services(Taiwan) Co., Ltd.

Report Number: W6M22006-20020-P-247

FCC ID: GX9CTC1052QT

5MHz

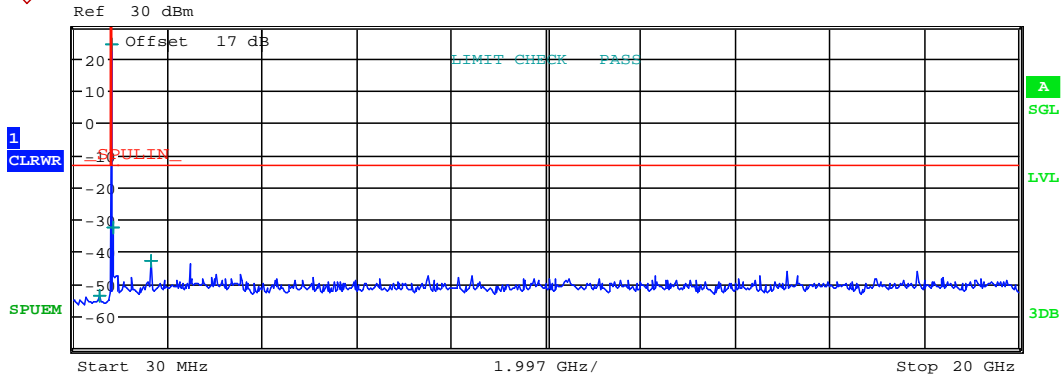

Start [Hz]	Stop [Hz]	RBW [Hz]	Freq [Hz]	PwrAbs [dBm]	ΔLimit [dB]
30.000 M	814.000 M	100.00 k	560.205128 M	-53.75	-40.75
814.000 M	859.000 M	100.00 k	826.654000 M	23.96	-9.04
859.000 M	1.000 G	100.00 k	869.589100 M	-32.51	-19.51
1.000 G	20.000 G	1.00 M	1.654233 G	-42.88	-29.88

CONDUCTED SPURIOUS EMISSION

Date: 11.AUG.2020 21:21:31







Report Number: W6M22006-20020-P-247  
 FCC ID: GX9CTC1052QT

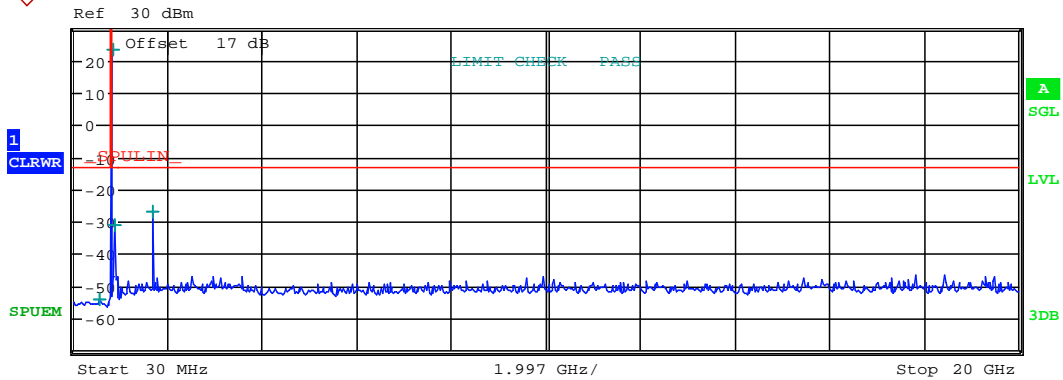

Start [Hz]	Stop [Hz]	RBW [Hz]	Freq [Hz]	PwrAbs [dBm]	Δ Limit [dB]
30.000 M	814.000 M	100.00 k	558.948718 M	-54.31	-41.31
814.000 M	859.000 M	100.00 k	846.643000 M	23.37	-9.63
859.000 M	1.000 G	100.00 k	893.535600 M	-31.41	-18.41
1.000 G	20.000 G	1.00 M	1.692867 G	-26.88	-13.88

CONDUCTED SPURIOUS EMISSION

Date: 11.AUG.2020 21:22:28



# Worldwide Testing Services(Taiwan) Co., Ltd.

Report Number: W6M22006-20020-P-247

FCC ID: GX9CTC1052QT

10MHz

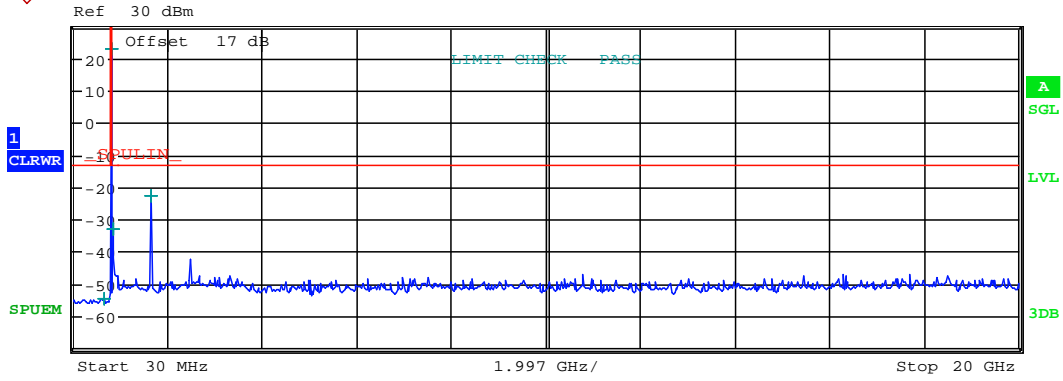

Start [Hz]	Stop [Hz]	RBW [Hz]	Freq [Hz]	PwrAbs [dBm]	ΔLimit [dB]
30.000 M	814.000 M	100.00 k	660.717949 M	-54.71	-41.71
814.000 M	859.000 M	100.00 k	828.989500 M	22.54	-10.46
859.000 M	1.000 G	100.00 k	875.680300 M	-33.35	-20.35
1.000 G	20.000 G	1.00 M	1.658033 G	-22.70	-9.70

CONDUCTED SPURIOUS EMISSION

Date: 11.AUG.2020 21:27:33



Report Number: W6M22006-20020-P-247  
 FCC ID: GX9CTC1052QT

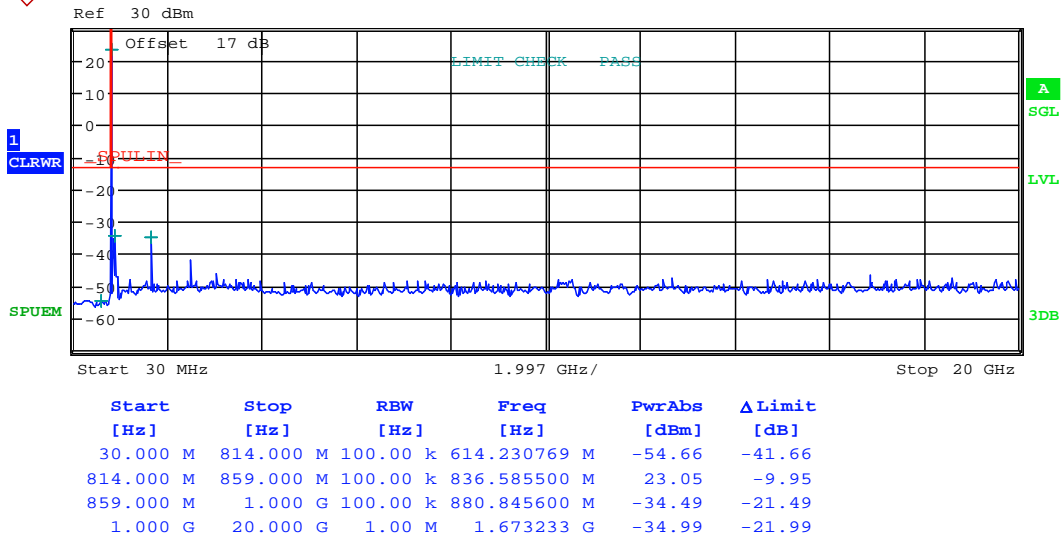

CONDUCTED SPURIOUS EMISSION

Date: 11.AUG.2020 21:27:49



Report Number: W6M22006-20020-P-247  
 FCC ID: GX9CTC1052QT

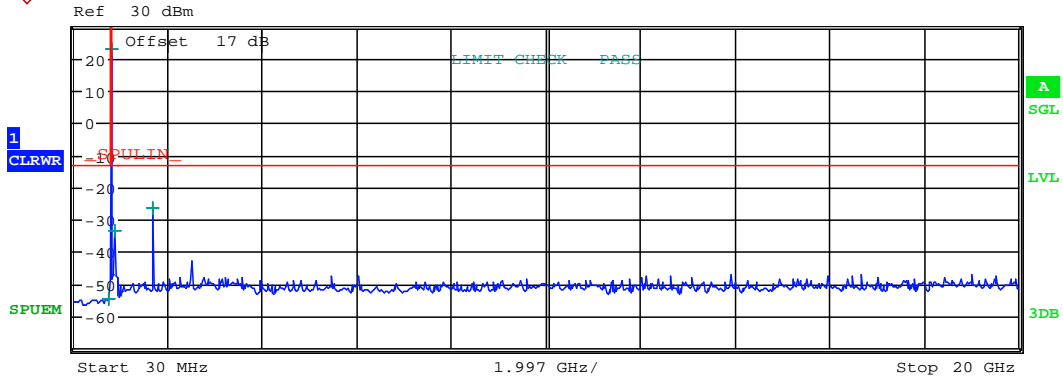

Start [Hz]	Stop [Hz]	RBW [Hz]	Freq [Hz]	PwrAbs [dBm]	ΔLimit [dB]
30.000 M	814.000 M	100.00 k	753.692308 M	-54.72	-41.72
814.000 M	859.000 M	100.00 k	844.109500 M	22.87	-10.13
859.000 M	1.000 G	100.00 k	884.638500 M	-33.57	-20.57
1.000 G	20.000 G	1.00 M	1.687800 G	-26.46	-13.46

CONDUCTED SPURIOUS EMISSION

Date: 11.AUG.2020 21:28:09



# Worldwide Testing Services(Taiwan) Co., Ltd.

Report Number: W6M22006-20020-P-247

FCC ID: GX9CTC1052QT

QPSK

1.4MHz

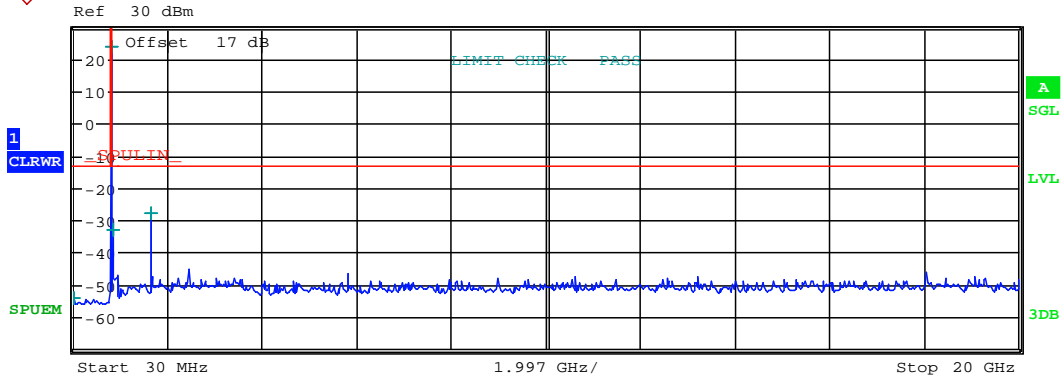

Start [Hz]	Stop [Hz]	RBW [Hz]	Freq [Hz]	PwrAbs [dBm]	ΔLimit [dB]
30.000 M	814.000 M	100.00 k	31.256410 M	-54.36	-41.36
814.000 M	859.000 M	100.00 k	824.813500 M	23.48	-9.52
859.000 M	1.000 G	100.00 k	869.753600 M	-32.94	-19.94
1.000 G	20.000 G	1.00 M	1.649167 G	-27.99	-14.99

CONDUCTED SPURIOUS EMISSION

Date: 11.AUG.2020 21:15:54



Report Number: W6M22006-20020-P-247  
 FCC ID: GX9CTC1052QT

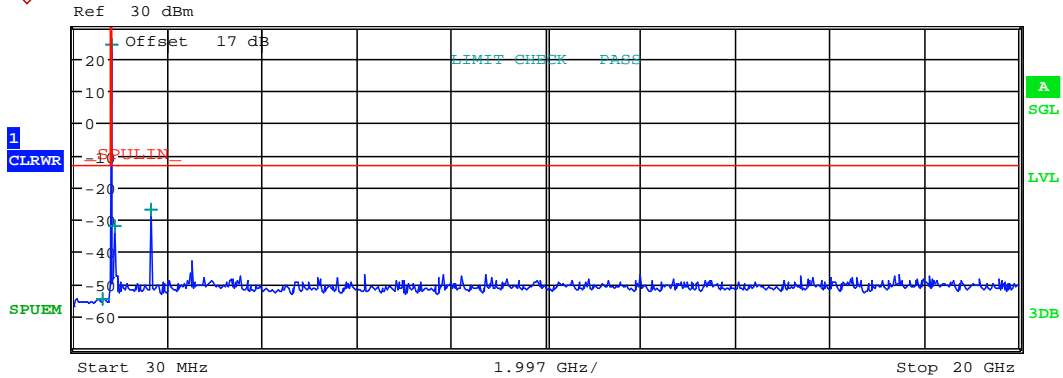

Start [Hz]	Stop [Hz]	RBW [Hz]	Freq [Hz]	PwrAbs [dBm]	ΔLimit [dB]
30.000 M	814.000 M	100.00 k	653.179487 M	-54.77	-41.77
814.000 M	859.000 M	100.00 k	836.626000 M	24.15	-8.85
859.000 M	1.000 G	100.00 k	881.038300 M	-32.15	-19.15
1.000 G	20.000 G	1.00 M	1.673233 G	-26.82	-13.82

CONDUCTED SPURIOUS EMISSION

Date: 11.AUG.2020 21:14:56



Report Number: W6M22006-20020-P-247  
 FCC ID: GX9CTC1052QT

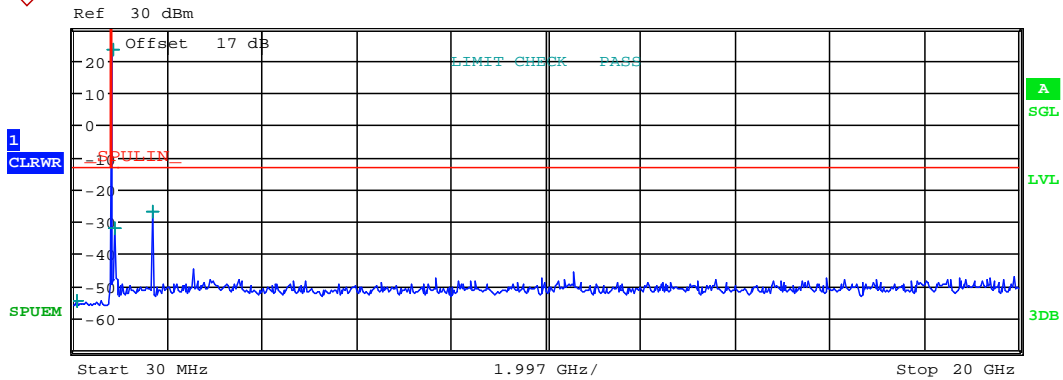

Start [Hz]	Stop [Hz]	RBW [Hz]	Freq [Hz]	PwrAbs [dBm]	Δ Limit [dB]
30.000 M	814.000 M	100.00 k	87.794872 M	-54.83	-41.83
814.000 M	859.000 M	100.00 k	848.326000 M	23.04	-9.96
859.000 M	1.000 G	100.00 k	893.695400 M	-32.22	-19.22
1.000 G	20.000 G	1.00 M	1.696667 G	-27.00	-14.00

CONDUCTED SPURIOUS EMISSION

Date: 11.AUG.2020 21:12:55



# Worldwide Testing Services(Taiwan) Co., Ltd.

Report Number: W6M22006-20020-P-247

FCC ID: GX9CTC1052QT

3MHz

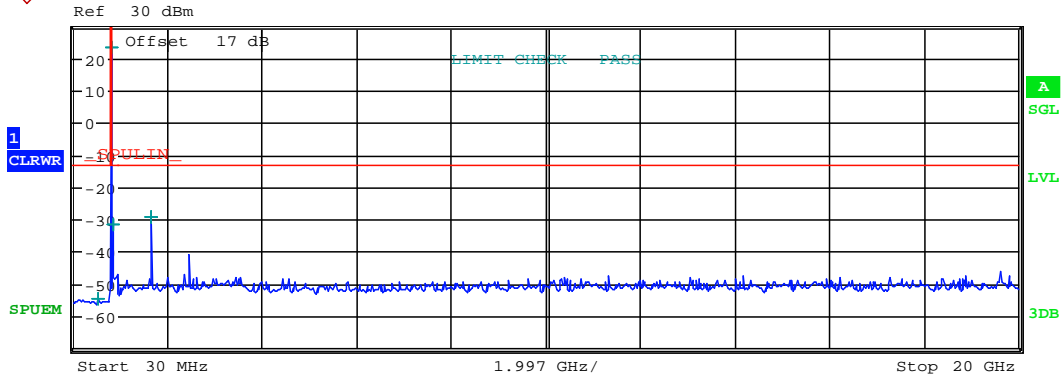

Start [Hz]	Stop [Hz]	RBW [Hz]	Freq [Hz]	PwrAbs [dBm]	ΔLimit [dB]
30.000 M	814.000 M	100.00 k	531.307692 M	-54.67	-41.67
814.000 M	859.000 M	100.00 k	825.677500 M	23.40	-9.60
859.000 M	1.000 G	100.00 k	871.506700 M	-31.69	-18.69
1.000 G	20.000 G	1.00 M	1.651067 G	-29.56	-16.56

CONDUCTED SPURIOUS EMISSION

Date: 11.AUG.2020 21:20:32





Report Number: W6M22006-20020-P-247  
 FCC ID: GX9CTC1052QT

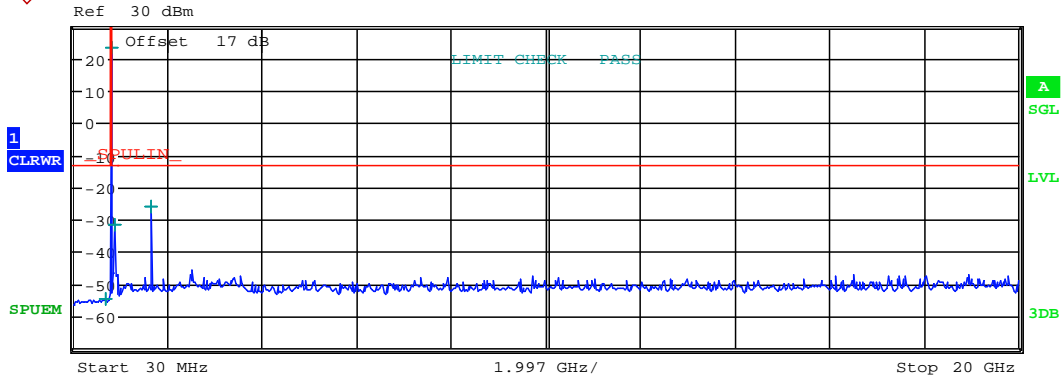

Start 30 MHz      1.997 GHz/      Stop 20 GHz

Start [Hz]	Stop [Hz]	RBW [Hz]	Freq [Hz]	PwrAbs [dBm]	Δ Limit [dB]
30.000 M	814.000 M	100.00 k	709.717949 M	-54.71	-41.71
814.000 M	859.000 M	100.00 k	836.770000 M	23.37	-9.63
859.000 M	1.000 G	100.00 k	881.893700 M	-31.64	-18.64
1.000 G	20.000 G	1.00 M	1.673233 G	-25.91	-12.91

CONDUCTED SPURIOUS EMISSION

Date: 11.AUG.2020 21:20:03



Report Number: W6M22006-20020-P-247  
 FCC ID: GX9CTC1052QT

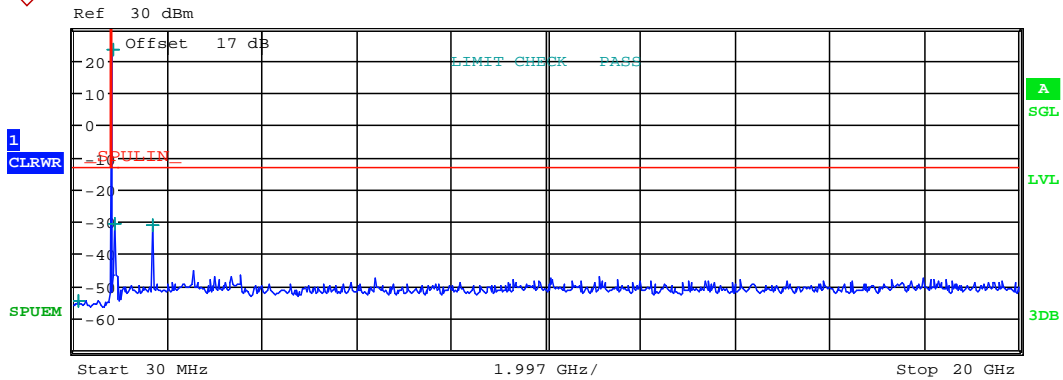

Start 30 MHz 1.997 GHz/ Stop 20 GHz

Start [Hz]	Stop [Hz]	RBW [Hz]	Freq [Hz]	PwrAbs [dBm]	Δ Limit [dB]
30.000 M	814.000 M	100.00 k	134.282051 M	-54.69	-41.69
814.000 M	859.000 M	100.00 k	847.691500 M	23.20	-9.80
859.000 M	1.000 G	100.00 k	892.670800 M	-30.86	-17.86
1.000 G	20.000 G	1.00 M	1.695400 G	-31.40	-18.40

CONDUCTED SPURIOUS EMISSION

Date: 11.AUG.2020 21:19:44



# Worldwide Testing Services(Taiwan) Co., Ltd.

Report Number: W6M22006-20020-P-247

FCC ID: GX9CTC1052QT

5MHz

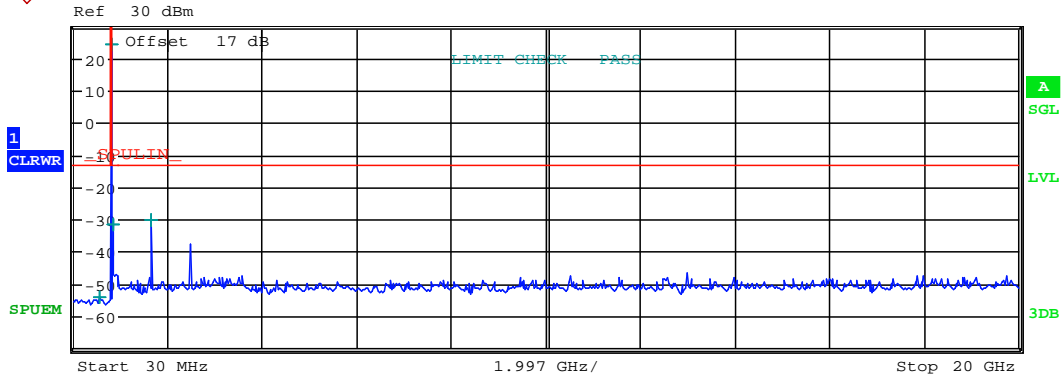

Start [Hz]	Stop [Hz]	RBW [Hz]	Freq [Hz]	PwrAbs [dBm]	ΔLimit [dB]
30.000 M	814.000 M	100.00 k	577.794872 M	-54.48	-41.48
814.000 M	859.000 M	100.00 k	826.703500 M	24.09	-8.91
859.000 M	1.000 G	100.00 k	870.576100 M	-31.97	-18.97
1.000 G	20.000 G	1.00 M	1.652333 G	-30.17	-17.17

CONDUCTED SPURIOUS EMISSION

Date: 11.AUG.2020 21:24:55



Report Number: W6M22006-20020-P-247  
 FCC ID: GX9CTC1052QT

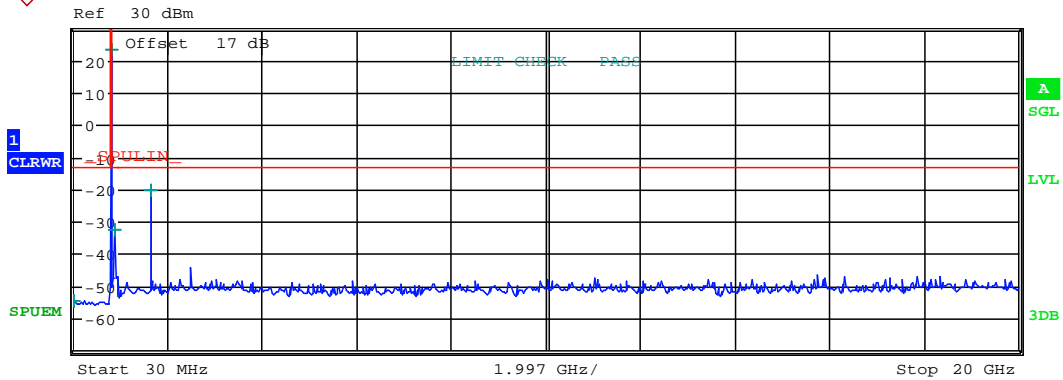

Start [Hz]	Stop [Hz]	RBW [Hz]	Freq [Hz]	PwrAbs [dBm]	Δ Limit [dB]
30.000 M	814.000 M	100.00 k	36.282051 M	-54.58	-41.58
814.000 M	859.000 M	100.00 k	836.693500 M	23.03	-9.97
859.000 M	1.000 G	100.00 k	881.879600 M	-32.45	-19.45
1.000 G	20.000 G	1.00 M	1.672600 G	-20.43	-7.43

CONDUCTED SPURIOUS EMISSION

Date: 11.AUG.2020 21:24:26

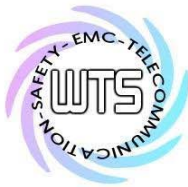

Report Number: W6M22006-20020-P-247  
 FCC ID: GX9CTC1052QT

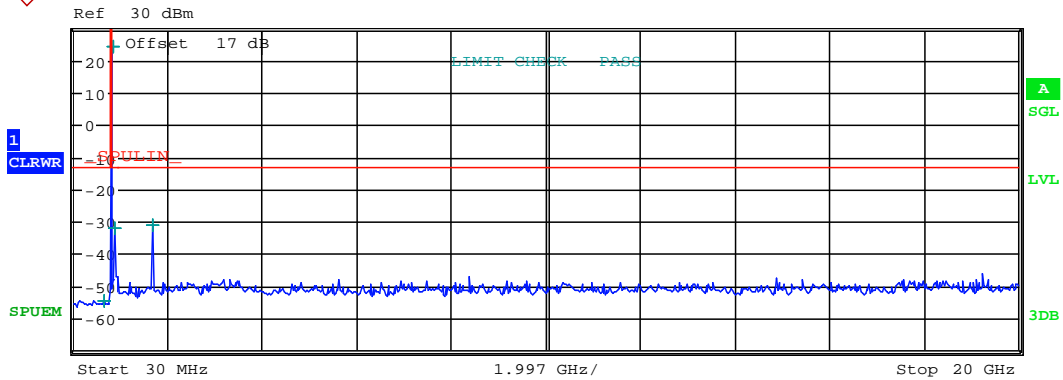

Start [Hz]	Stop [Hz]	RBW [Hz]	Freq [Hz]	PwrAbs [dBm]	ΔLimit [dB]
30.000 M	814.000 M	100.00 k	683.333333 M	-54.73	-41.73
814.000 M	859.000 M	100.00 k	846.706000 M	24.17	-8.83
859.000 M	1.000 G	100.00 k	890.833100 M	-32.39	-19.39
1.000 G	20.000 G	1.00 M	1.693500 G	-31.25	-18.25

CONDUCTED SPURIOUS EMISSION

Date: 11.AUG.2020 21:23:43



# Worldwide Testing Services(Taiwan) Co., Ltd.

Report Number: W6M22006-20020-P-247

FCC ID: GX9CTC1052QT

10MHz

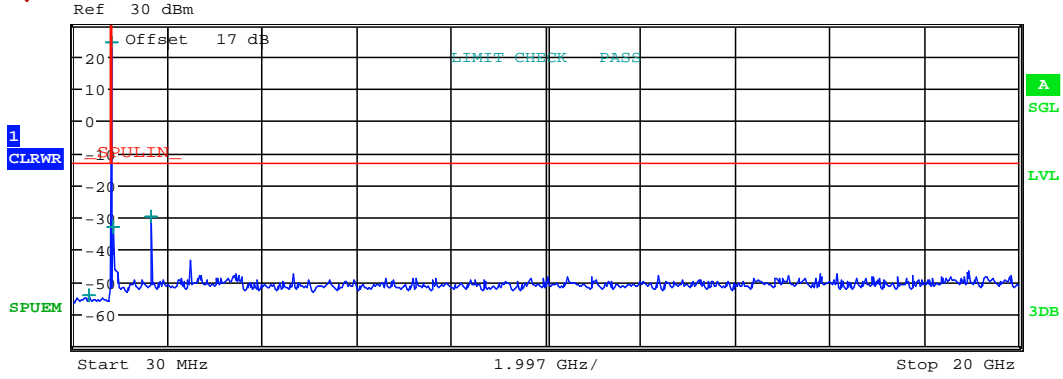

Start [Hz]	Stop [Hz]	RBW [Hz]	Freq [Hz]	PwrAbs [dBm]	ΔLimit [dB]
30.000 M	814.000 M	100.00 k	345.358974 M	-54.44	-41.44
814.000 M	859.000 M	100.00 k	829.097500 M	24.12	-8.88
859.000 M	1.000 G	100.00 k	870.876900 M	-33.00	-20.00
1.000 G	20.000 G	1.00 M	1.657400 G	-29.78	-16.78

CONDUCTED SPURIOUS EMISSION

Date: 11.AUG.2020 21:31:19



# Worldwide Testing Services(Taiwan) Co., Ltd.

Report Number: W6M22006-20020-P-247  
 FCC ID: GX9CTC1052QT

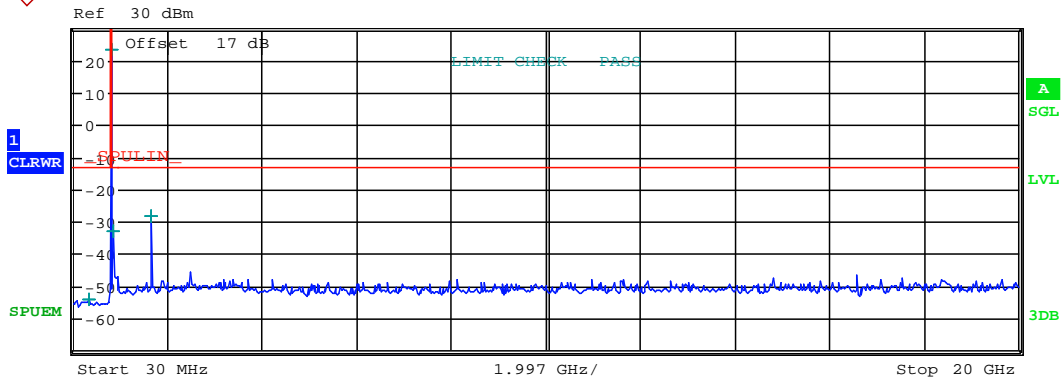

Start 30 MHz 1.997 GHz/ Stop 20 GHz

Start [Hz]	Stop [Hz]	RBW [Hz]	Freq [Hz]	PwrAbs [dBm]	ΔLimit [dB]
30.000 M	814.000 M	100.00 k	356.666667 M	-54.50	-41.50
814.000 M	859.000 M	100.00 k	836.635000 M	23.29	-9.71
859.000 M	1.000 G	100.00 k	877.048000 M	-33.07	-20.07
1.000 G	20.000 G	1.00 M	1.672600 G	-28.38	-15.38

CONDUCTED SPURIOUS EMISSION

Date: 11.AUG.2020 21:30:39



Report Number: W6M22006-20020-P-247  
 FCC ID: GX9CTC1052QT

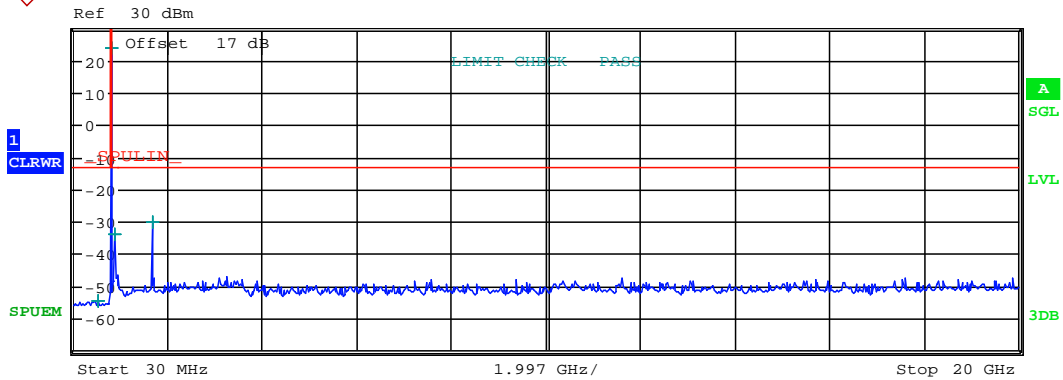

Start [Hz]	Stop [Hz]	RBW [Hz]	Freq [Hz]	PwrAbs [dBm]	ΔLimit [dB]
30.000 M	814.000 M	100.00 k	535.076923 M	-54.62	-41.62
814.000 M	859.000 M	100.00 k	844.069000 M	23.56	-9.44
859.000 M	1.000 G	100.00 k	885.108500 M	-34.23	-21.23
1.000 G	20.000 G	1.00 M	1.687800 G	-30.16	-17.16

CONDUCTED SPURIOUS EMISSION

Date: 11.AUG.2020 21:29:43





# Worldwide Testing Services(Taiwan) Co., Ltd.

Report Number: W6M22006-20020-P-247

FCC ID: GX9CTC1052QT

Band XII

16QAM

1.4MHz

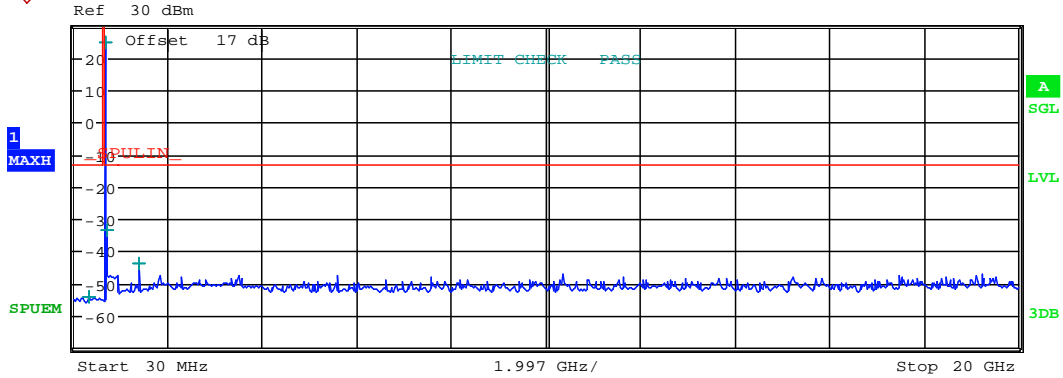

Start [Hz]	Stop [Hz]	RBW [Hz]	Freq [Hz]	PwrAbs [dBm]	ΔLimit [dB]
30.000 M	688.000 M	100.00 k	334.746795 M	-54.07	-41.07
688.000 M	726.000 M	100.00 k	699.764800 M	24.50	-8.50
726.000 M	1.000 G	100.00 k	729.909067 M	-33.50	-20.50
1.000 G	20.000 G	1.00 M	1.399000 G	-44.08	-31.08

CONDUCTED SPURIOUS EMISSION

Date: 12.AUG.2020 21:18:11



Report Number: W6M22006-20020-P-247  
 FCC ID: GX9CTC1052QT

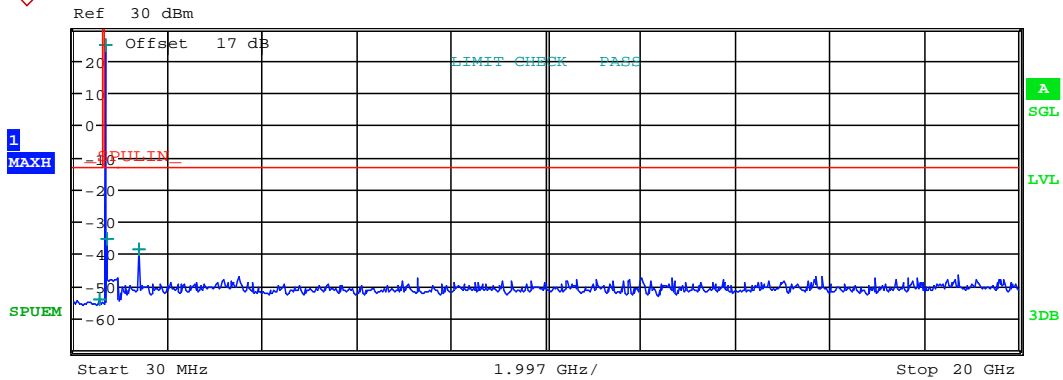

Start [Hz]	Stop [Hz]	RBW [Hz]	Freq [Hz]	PwrAbs [dBm]	ΔLimit [dB]
30.000 M	688.000 M	100.00 k	588.878205 M	-54.35	-41.35
688.000 M	726.000 M	100.00 k	707.611800 M	24.45	-8.55
726.000 M	1.000 G	100.00 k	737.763733 M	-35.39	-22.39
1.000 G	20.000 G	1.00 M	1.414200 G	-38.65	-25.65

CONDUCTED SPURIOUS EMISSION

Date: 12.AUG.2020 21:18:36



Report Number: W6M22006-20020-P-247  
 FCC ID: GX9CTC1052QT

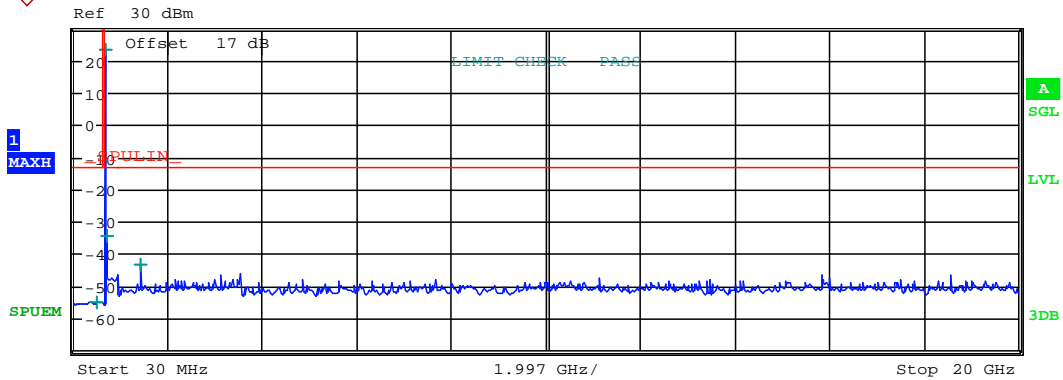

Start 30 MHz 1.997 GHz/ Stop 20 GHz

Start [Hz]	Stop [Hz]	RBW [Hz]	Freq [Hz]	PwrAbs [dBm]	Δ Limit [dB]
30.000 M	688.000 M	100.00 k	512.955128 M	-54.98	-41.98
688.000 M	726.000 M	100.00 k	715.348600 M	23.04	-9.96
726.000 M	1.000 G	100.00 k	744.933400 M	-34.49	-21.49
1.000 G	20.000 G	1.00 M	1.430667 G	-43.29	-30.29

CONDUCTED SPURIOUS EMISSION

Date: 12.AUG.2020 21:18:56

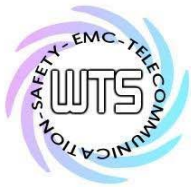

# Worldwide Testing Services(Taiwan) Co., Ltd.

Report Number: W6M22006-20020-P-247

FCC ID: GX9CTC1052QT

3MHz

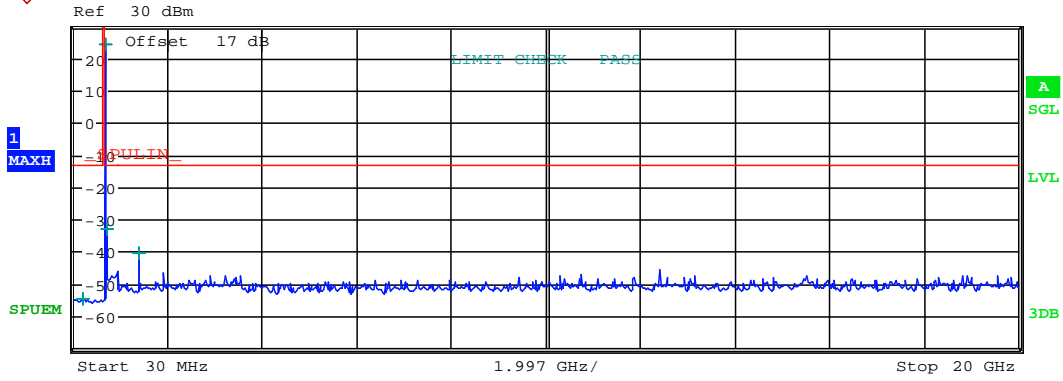

Start [Hz]	Stop [Hz]	RBW [Hz]	Freq [Hz]	PwrAbs [dBm]	ΔLimit [dB]
30.000 M	688.000 M	100.00 k	237.733974 M	-54.61	-41.61
688.000 M	726.000 M	100.00 k	700.718600 M	24.30	-8.70
726.000 M	1.000 G	100.00 k	730.849800 M	-32.97	-19.97
1.000 G	20.000 G	1.00 M	1.400900 G	-40.66	-27.66

CONDUCTED SPURIOUS EMISSION

Date: 12.AUG.2020 21:21:16



Report Number: W6M22006-20020-P-247  
 FCC ID: GX9CTC1052QT

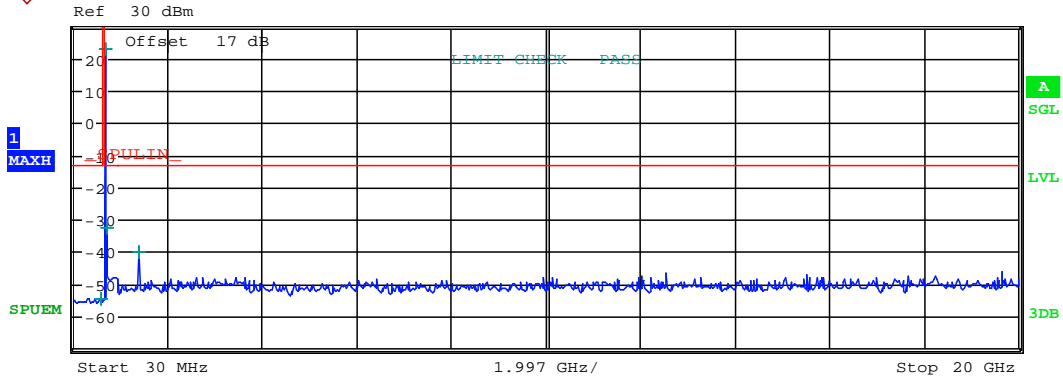

Start 30 MHz 1.997 GHz/ Stop 20 GHz

Start [Hz]	Stop [Hz]	RBW [Hz]	Freq [Hz]	PwrAbs [dBm]	Δ Limit [dB]
30.000 M	688.000 M	100.00 k	617.349359 M	-54.65	-41.65
688.000 M	726.000 M	100.00 k	707.744800 M	22.86	-10.14
726.000 M	1.000 G	100.00 k	738.412200 M	-32.62	-19.62
1.000 G	20.000 G	1.00 M	1.415467 G	-40.41	-27.41

CONDUCTED SPURIOUS EMISSION

Date: 12.AUG.2020 21:21:38



# Worldwide Testing Services(Taiwan) Co., Ltd.

Report Number: W6M22006-20020-P-247  
 FCC ID: GX9CTC1052QT

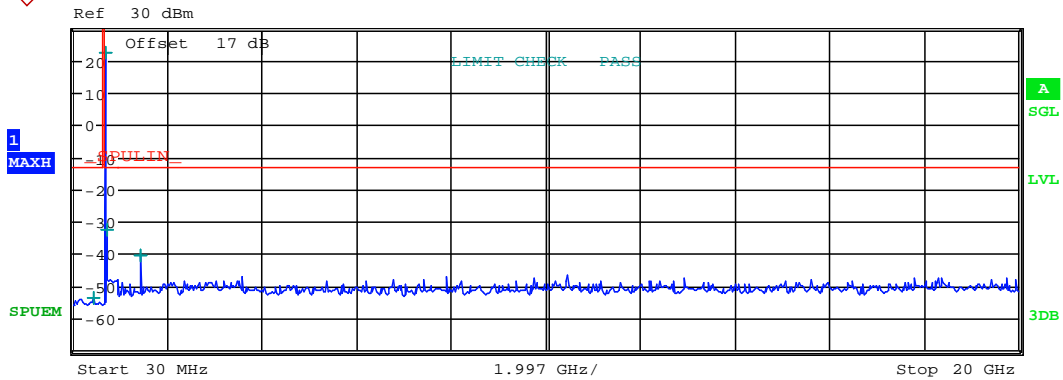

Start 30 MHz 1.997 GHz/ Stop 20 GHz

Start [Hz]	Stop [Hz]	RBW [Hz]	Freq [Hz]	PwrAbs [dBm]	ΔLimit [dB]
30.000 M	688.000 M	100.00 k	441.250000 M	-53.77	-40.77
688.000 M	726.000 M	100.00 k	714.660800 M	22.38	-10.62
726.000 M	1.000 G	100.00 k	745.225667 M	-32.49	-19.49
1.000 G	20.000 G	1.00 M	1.429400 G	-40.76	-27.76

CONDUCTED SPURIOUS EMISSION

Date: 12.AUG.2020 21:21:59



# Worldwide Testing Services(Taiwan) Co., Ltd.

Report Number: W6M22006-20020-P-247

FCC ID: GX9CTC1052QT

5MHz

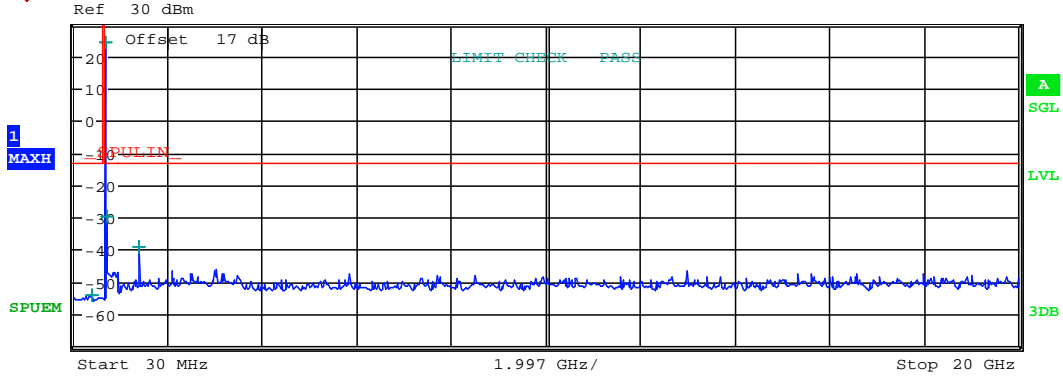

Start [Hz]	Stop [Hz]	RBW [Hz]	Freq [Hz]	PwrAbs [dBm]	ΔLimit [dB]
30.000 M	688.000 M	100.00 k	411.724359 M	-54.41	-41.41
688.000 M	726.000 M	100.00 k	701.657200 M	23.90	-9.10
726.000 M	1.000 G	100.00 k	730.466200 M	-29.72	-16.72
1.000 G	20.000 G	1.00 M	1.402800 G	-39.06	-26.06

CONDUCTED SPURIOUS EMISSION

Date: 12.AUG.2020 21:26:14



Report Number: W6M22006-20020-P-247  
 FCC ID: GX9CTC1052QT

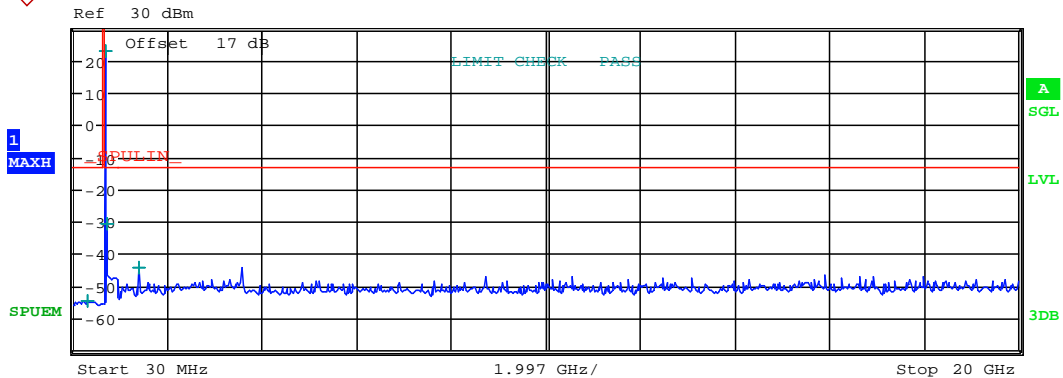

Start 30 MHz Stop 20 GHz

Start [Hz]	Stop [Hz]	RBW [Hz]	Freq [Hz]	PwrAbs [dBm]	$\Delta$ Limit [dB]
30.000 M	688.000 M	100.00 k	323.147436 M	-54.60	-41.60
688.000 M	726.000 M	100.00 k	707.661200 M	22.51	-10.49
726.000 M	1.000 G	100.00 k	736.868667 M	-30.69	-17.69
1.000 G	20.000 G	1.00 M	1.414833 G	-44.22	-31.22

CONDUCTED SPURIOUS EMISSION

Date: 12.AUG.2020 21:26:33





# Worldwide Testing Services(Taiwan) Co., Ltd.

Report Number: W6M22006-20020-P-247  
 FCC ID: GX9CTC1052QT

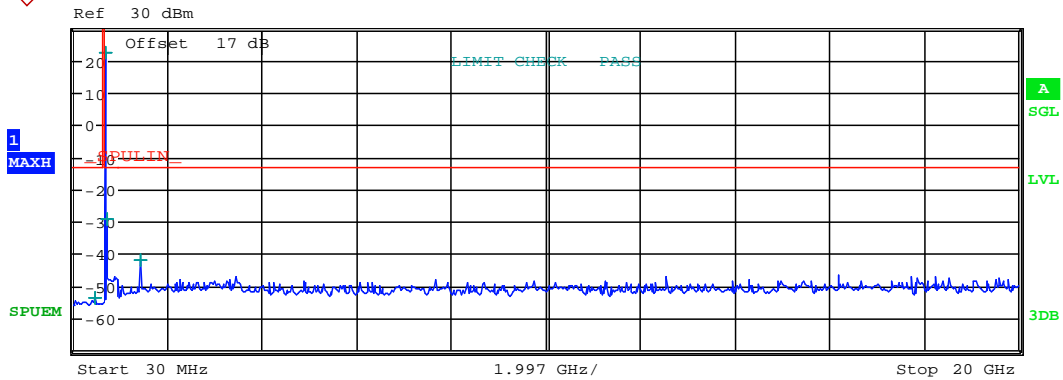

Start 30 MHz      1.997 GHz/      Stop 20 GHz

Start [Hz]	Stop [Hz]	RBW [Hz]	Freq [Hz]	PwrAbs [dBm]	Δ Limit [dB]
30.000 M	688.000 M	100.00 k	477.102564 M	-53.82	-40.82
688.000 M	726.000 M	100.00 k	713.726000 M	22.06	-10.94
726.000 M	1.000 G	100.00 k	741.645400 M	-29.43	-16.43
1.000 G	20.000 G	1.00 M	1.427500 G	-41.95	-28.95

CONDUCTED SPURIOUS EMISSION

Date: 12.AUG.2020 21:26:54



# Worldwide Testing Services(Taiwan) Co., Ltd.

Report Number: W6M22006-20020-P-247

FCC ID: GX9CTC1052QT

10MHz

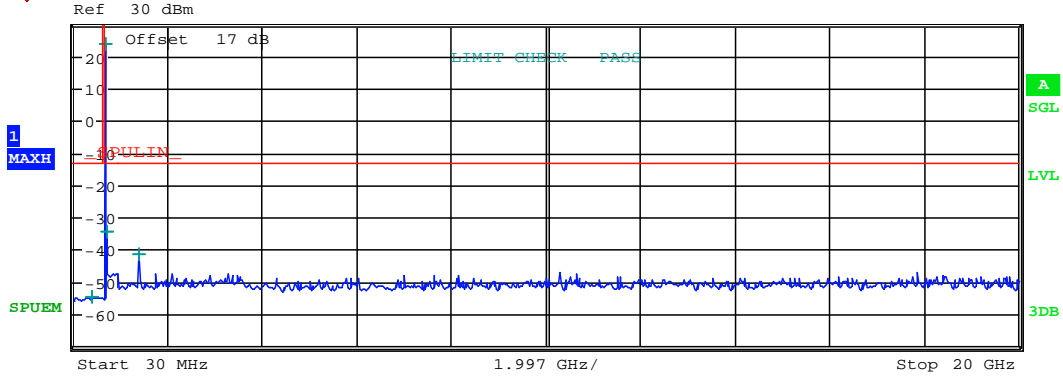

Start [Hz]	Stop [Hz]	RBW [Hz]	Freq [Hz]	PwrAbs [dBm]	ΔLimit [dB]
30.000 M	688.000 M	100.00 k	406.451923 M	-54.91	-41.91
688.000 M	726.000 M	100.00 k	704.115800 M	23.69	-9.31
726.000 M	1.000 G	100.00 k	735.736133 M	-34.60	-21.60
1.000 G	20.000 G	1.00 M	1.407233 G	-41.74	-28.74

CONDUCTED SPURIOUS EMISSION

Date: 12.AUG.2020 21:29:32



# Worldwide Testing Services(Taiwan) Co., Ltd.

Report Number: W6M22006-20020-P-247  
 FCC ID: GX9CTC1052QT

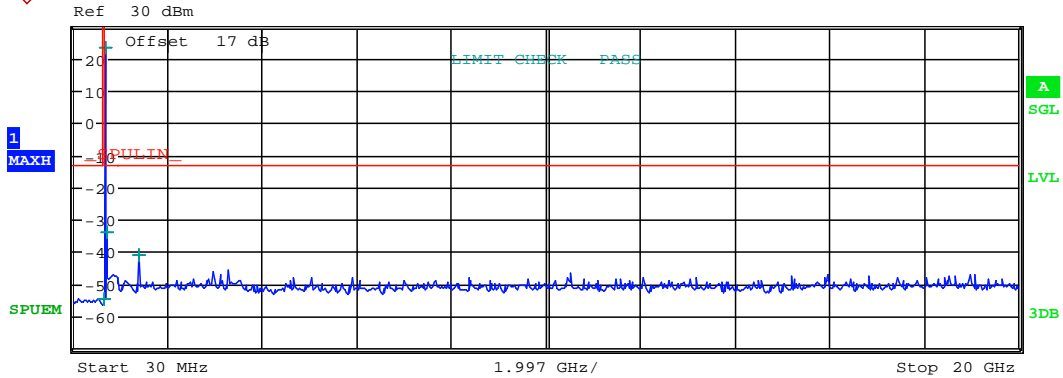

Start [Hz]	Stop [Hz]	RBW [Hz]	Freq [Hz]	PwrAbs [dBm]	ΔLimit [dB]
30.000 M	688.000 M	100.00 k	657.419872 M	-54.76	-41.76
688.000 M	726.000 M	100.00 k	707.653600 M	23.34	-9.66
726.000 M	1.000 G	100.00 k	738.878000 M	-34.25	-21.25
1.000 G	20.000 G	1.00 M	1.414833 G	-41.16	-28.16

CONDUCTED SPURIOUS EMISSION

Date: 12.AUG.2020 21:29:50



# Worldwide Testing Services(Taiwan) Co., Ltd.

Report Number: W6M22006-20020-P-247  
 FCC ID: GX9CTC1052QT

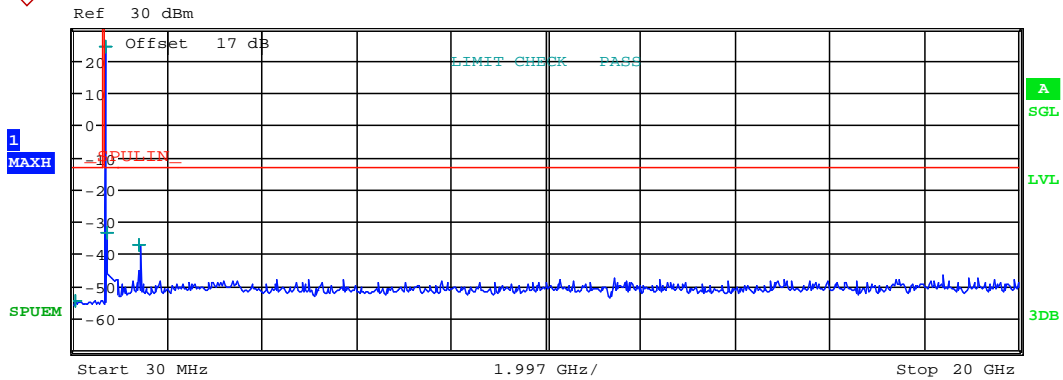

Start [Hz]	Stop [Hz]	RBW [Hz]	Freq [Hz]	PwrAbs [dBm]	Δ Limit [dB]
30.000 M	688.000 M	100.00 k	48.980769 M	-54.67	-41.67
688.000 M	726.000 M	100.00 k	711.119200 M	23.99	-9.01
726.000 M	1.000 G	100.00 k	736.859533 M	-33.62	-20.62
1.000 G	20.000 G	1.00 M	1.421800 G	-37.40	-24.40

CONDUCTED SPURIOUS EMISSION

Date: 12.AUG.2020 21:30:55



# Worldwide Testing Services(Taiwan) Co., Ltd.

Report Number: W6M22006-20020-P-247

FCC ID: GX9CTC1052QT

QPSK

1.4MHz

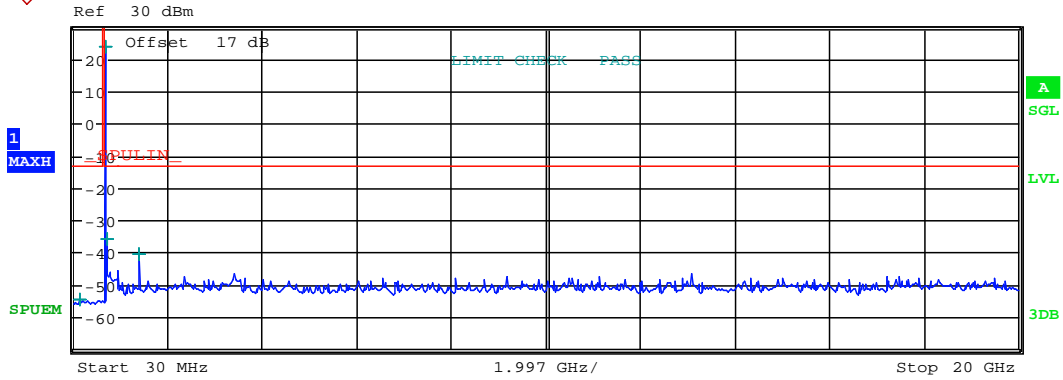

Start [Hz]	Stop [Hz]	RBW [Hz]	Freq [Hz]	PwrAbs [dBm]	ΔLimit [dB]
30.000 M	688.000 M	100.00 k	168.137821 M	-54.71	-41.71
688.000 M	726.000 M	100.00 k	699.761000 M	23.75	-9.25
726.000 M	1.000 G	100.00 k	729.370200 M	-35.97	-22.97
1.000 G	20.000 G	1.00 M	1.399000 G	-40.52	-27.52

CONDUCTED SPURIOUS EMISSION

Date: 12.AUG.2020 21:19:35



# Worldwide Testing Services(Taiwan) Co., Ltd.

Report Number: W6M22006-20020-P-247  
 FCC ID: GX9CTC1052QT

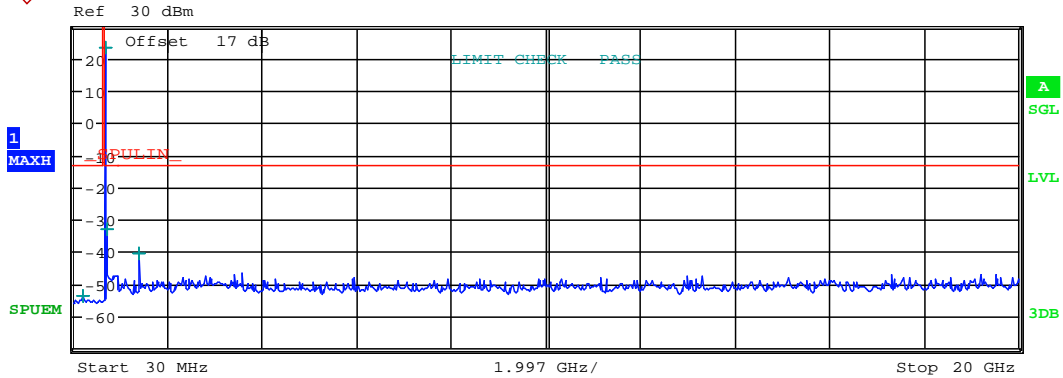

Start 30 MHz 1.997 GHz/ Stop 20 GHz

Start [Hz]	Stop [Hz]	RBW [Hz]	Freq [Hz]	PwrAbs [dBm]	Δ Limit [dB]
30.000 M	688.000 M	100.00 k	212.426282 M	-53.94	-40.94
688.000 M	726.000 M	100.00 k	707.543400 M	23.11	-9.89
726.000 M	1.000 G	100.00 k	737.389267 M	-33.16	-20.16
1.000 G	20.000 G	1.00 M	1.414833 G	-40.49	-27.49

CONDUCTED SPURIOUS EMISSION

Date: 12.AUG.2020 21:19:54



Report Number: W6M22006-20020-P-247  
 FCC ID: GX9CTC1052QT

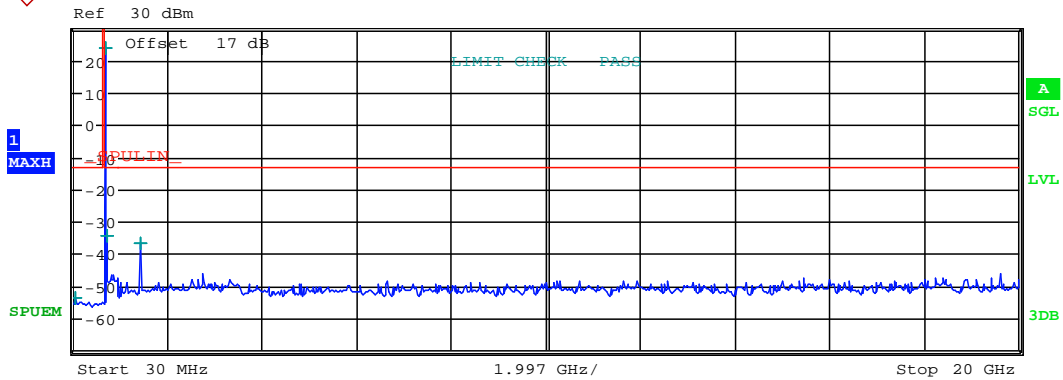

Start [Hz]	Stop [Hz]	RBW [Hz]	Freq [Hz]	PwrAbs [dBm]	Δ Limit [dB]
30.000 M	688.000 M	100.00 k	76.397436 M	-53.70	-40.70
688.000 M	726.000 M	100.00 k	715.424600 M	23.51	-9.49
726.000 M	1.000 G	100.00 k	745.070400 M	-34.37	-21.37
1.000 G	20.000 G	1.00 M	1.430667 G	-36.97	-23.97

CONDUCTED SPURIOUS EMISSION

Date: 12.AUG.2020 21:20:17

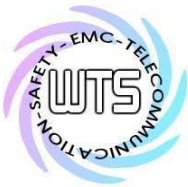

# Worldwide Testing Services(Taiwan) Co., Ltd.

Report Number: W6M22006-20020-P-247

FCC ID: GX9CTC1052QT

3MHz

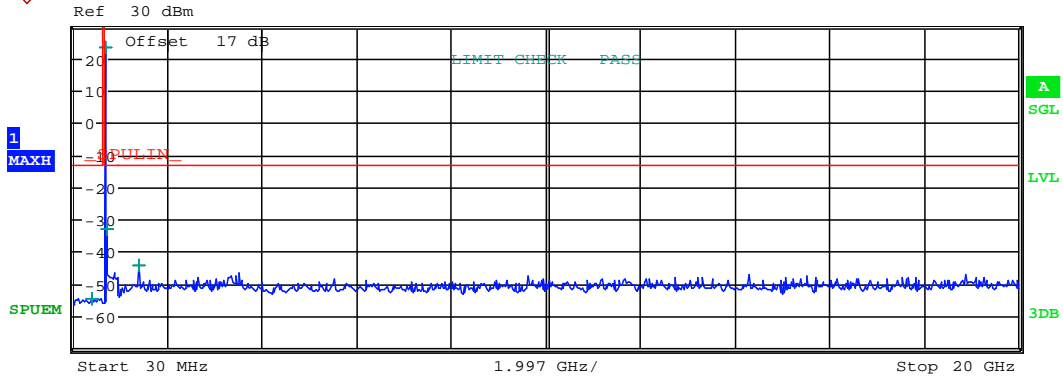

Start 30 MHz 1.997 GHz/ Stop 20 GHz

Start [Hz]	Stop [Hz]	RBW [Hz]	Freq [Hz]	PwrAbs [dBm]	ΔLimit [dB]
30.000 M	688.000 M	100.00 k	428.596154 M	-54.84	-41.84
688.000 M	726.000 M	100.00 k	700.657800 M	23.29	-9.71
726.000 M	1.000 G	100.00 k	730.630600 M	-33.13	-20.13
1.000 G	20.000 G	1.00 M	1.401533 G	-44.41	-31.41

CONDUCTED SPURIOUS EMISSION

Date: 12.AUG.2020 21:22:51





Report Number: W6M22006-20020-P-247  
 FCC ID: GX9CTC1052QT

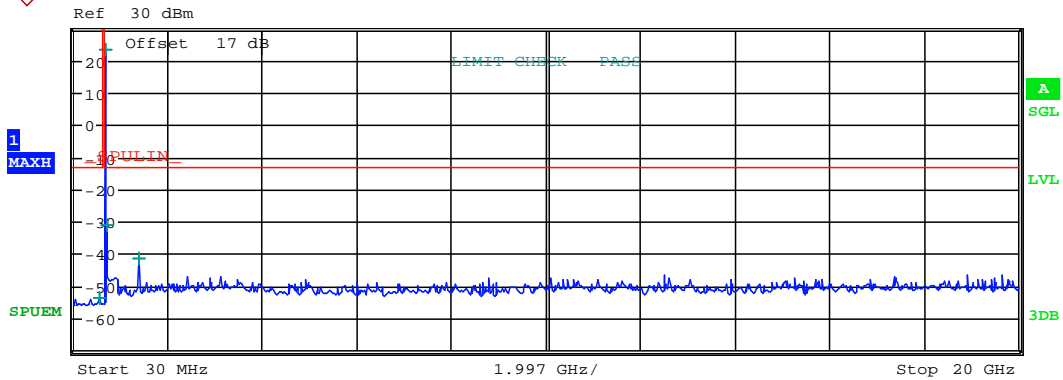

Start 30 MHz 1.997 GHz/ Stop 20 GHz

Start [Hz]	Stop [Hz]	RBW [Hz]	Freq [Hz]	PwrAbs [dBm]	ΔLimit [dB]
30.000 M	688.000 M	100.00 k	566.733974 M	-53.87	-40.87
688.000 M	726.000 M	100.00 k	707.638400 M	23.36	-9.64
726.000 M	1.000 G	100.00 k	736.832133 M	-31.50	-18.50
1.000 G	20.000 G	1.00 M	1.414833 G	-41.59	-28.59

CONDUCTED SPURIOUS EMISSION

Date: 12.AUG.2020 21:23:13



# Worldwide Testing Services(Taiwan) Co., Ltd.

Report Number: W6M22006-20020-P-247  
 FCC ID: GX9CTC1052QT

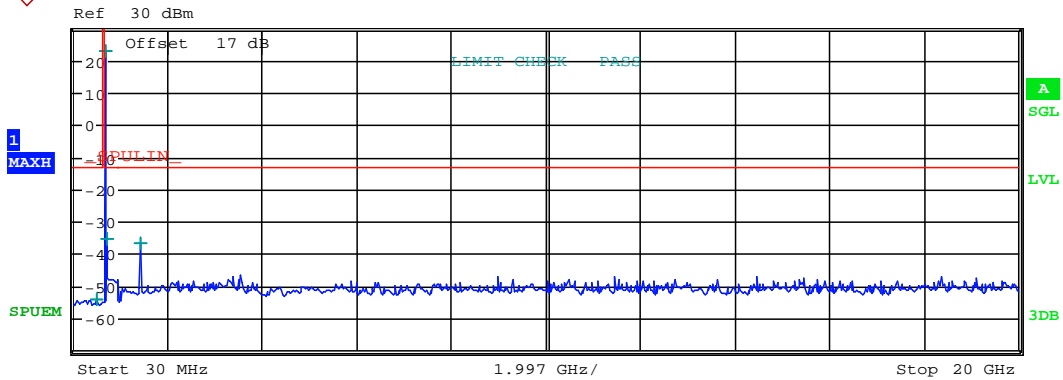

Start 30 MHz 1.997 GHz/ Stop 20 GHz

Start [Hz]	Stop [Hz]	RBW [Hz]	Freq [Hz]	PwrAbs [dBm]	ΔLimit [dB]
30.000 M	688.000 M	100.00 k	511.900641 M	-54.22	-41.22
688.000 M	726.000 M	100.00 k	714.619000 M	22.68	-10.32
726.000 M	1.000 G	100.00 k	745.554467 M	-35.30	-22.30
1.000 G	20.000 G	1.00 M	1.428767 G	-36.78	-23.78

CONDUCTED SPURIOUS EMISSION

Date: 12.AUG.2020 21:24:28



# Worldwide Testing Services(Taiwan) Co., Ltd.

Report Number: W6M22006-20020-P-247

FCC ID: GX9CTC1052QT

5MHz

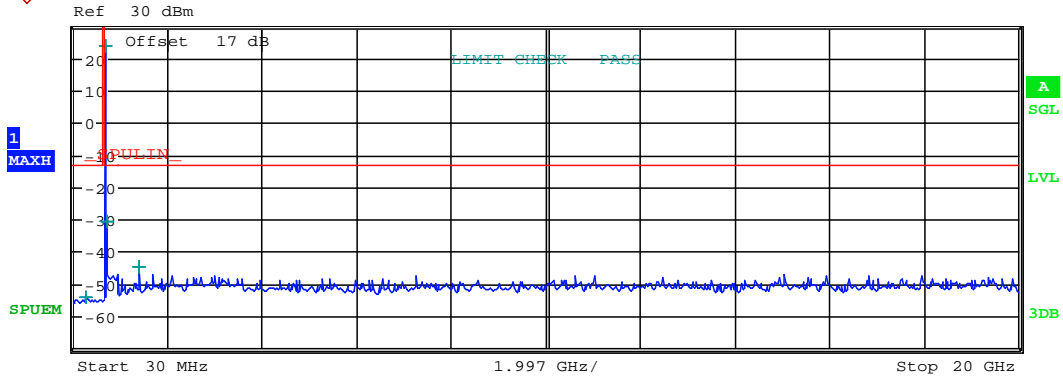

Start [Hz]	Stop [Hz]	RBW [Hz]	Freq [Hz]	PwrAbs [dBm]	ΔLimit [dB]
30.000 M	688.000 M	100.00 k	286.240385 M	-54.43	-41.43
688.000 M	726.000 M	100.00 k	701.695200 M	23.60	-9.40
726.000 M	1.000 G	100.00 k	732.767800 M	-30.98	-17.98
1.000 G	20.000 G	1.00 M	1.402800 G	-45.01	-32.01

CONDUCTED SPURIOUS EMISSION

Date: 12.AUG.2020 21:27:34



# Worldwide Testing Services(Taiwan) Co., Ltd.

Report Number: W6M22006-20020-P-247  
 FCC ID: GX9CTC1052QT

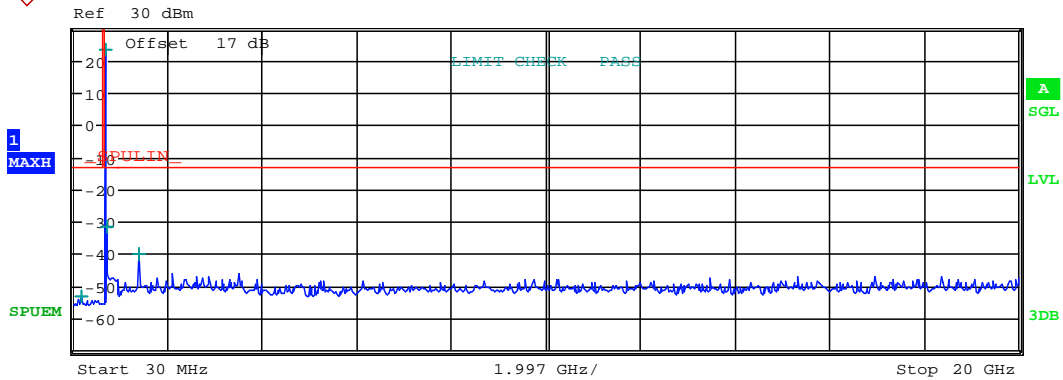

Start 30 MHz 1.997 GHz/ Stop 20 GHz

Start [Hz]	Stop [Hz]	RBW [Hz]	Freq [Hz]	PwrAbs [dBm]	ΔLimit [dB]
30.000 M	688.000 M	100.00 k	192.391026 M	-53.46	-40.46
688.000 M	726.000 M	100.00 k	707.623200 M	23.05	-9.95
726.000 M	1.000 G	100.00 k	739.544733 M	-31.89	-18.89
1.000 G	20.000 G	1.00 M	1.414833 G	-40.21	-27.21

CONDUCTED SPURIOUS EMISSION

Date: 12.AUG.2020 21:27:52



# Worldwide Testing Services(Taiwan) Co., Ltd.

Report Number: W6M22006-20020-P-247  
FCC ID: GX9CTC1052QT

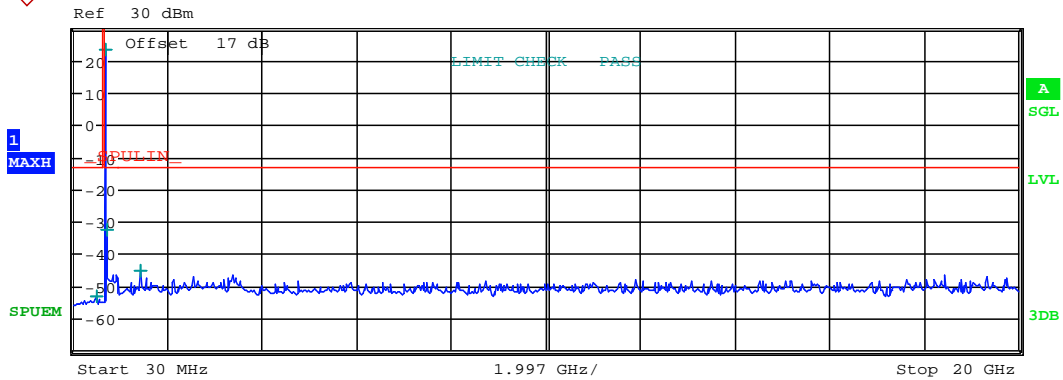

Start 30 MHz 1.997 GHz/ Stop 20 GHz

Start [Hz]	Stop [Hz]	RBW [Hz]	Freq [Hz]	PwrAbs [dBm]	Δ Limit [dB]
30.000 M	688.000 M	100.00 k	524.554487 M	-53.51	-40.51
688.000 M	726.000 M	100.00 k	713.737400 M	23.04	-9.96
726.000 M	1.000 G	100.00 k	743.892200 M	-32.79	-19.79
1.000 G	20.000 G	1.00 M	1.427500 G	-45.35	-32.35

CONDUCTED SPURIOUS EMISSION

Date: 12.AUG.2020 21:28:11



# Worldwide Testing Services(Taiwan) Co., Ltd.

Report Number: W6M22006-20020-P-247

FCC ID: GX9CTC1052QT

10MHz

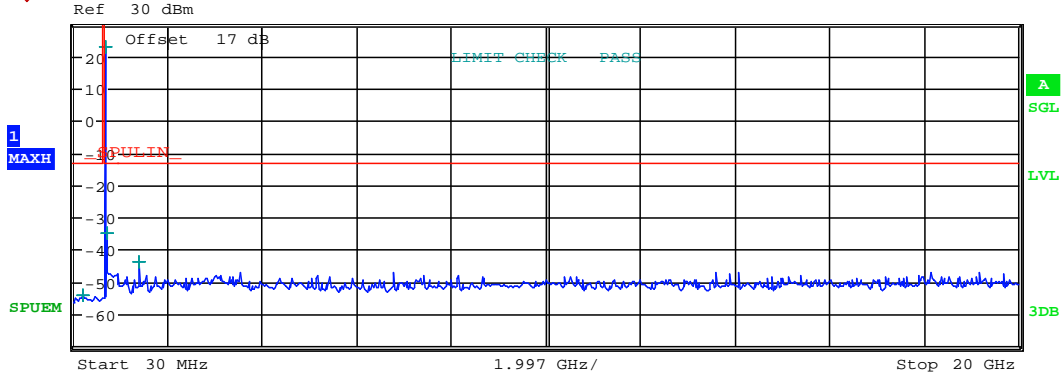

Start [Hz]	Stop [Hz]	RBW [Hz]	Freq [Hz]	PwrAbs [dBm]	ΔLimit [dB]
30.000 M	688.000 M	100.00 k	218.753205 M	-54.35	-41.35
688.000 M	726.000 M	100.00 k	704.036000 M	22.60	-10.40
726.000 M	1.000 G	100.00 k	731.543933 M	-35.09	-22.09
1.000 G	20.000 G	1.00 M	1.407867 G	-43.72	-30.72

CONDUCTED SPURIOUS EMISSION

Date: 12.AUG.2020 21:31:29



# Worldwide Testing Services(Taiwan) Co., Ltd.

Report Number: W6M22006-20020-P-247  
 FCC ID: GX9CTC1052QT

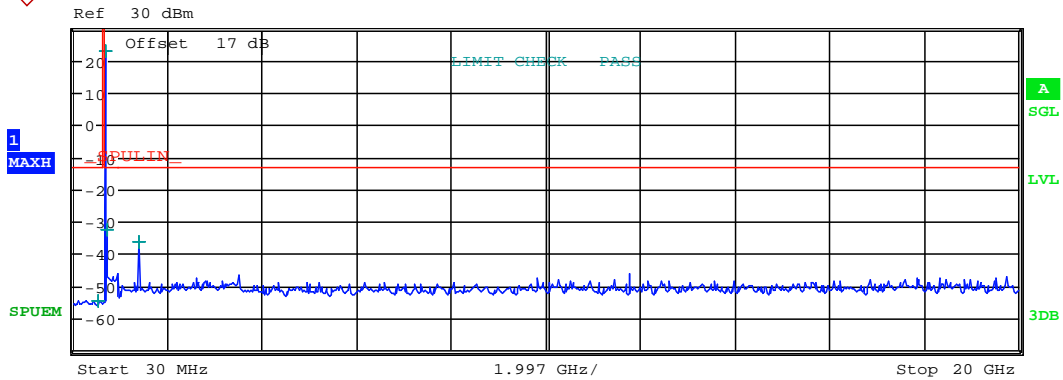

Start 30 MHz 1.997 GHz/ Stop 20 GHz

Start [Hz]	Stop [Hz]	RBW [Hz]	Freq [Hz]	PwrAbs [dBm]	Δ Limit [dB]
30.000 M	688.000 M	100.00 k	557.243590 M	-54.66	-41.66
688.000 M	726.000 M	100.00 k	707.573800 M	22.77	-10.23
726.000 M	1.000 G	100.00 k	734.895867 M	-32.56	-19.56
1.000 G	20.000 G	1.00 M	1.414833 G	-36.64	-23.64

CONDUCTED SPURIOUS EMISSION

Date: 12.AUG.2020 21:33:58



# Worldwide Testing Services(Taiwan) Co., Ltd.

Report Number: W6M22006-20020-P-247  
 FCC ID: GX9CTC1052QT

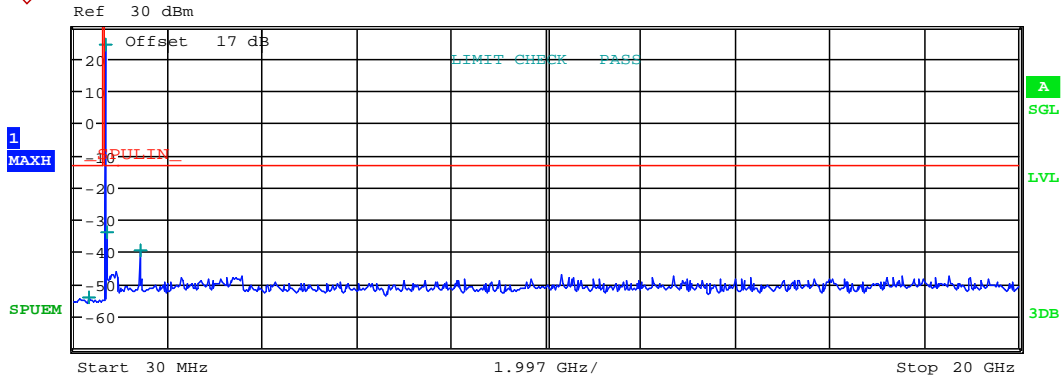

Start [Hz]	Stop [Hz]	RBW [Hz]	Freq [Hz]	PwrAbs [dBm]	ΔLimit [dB]
30.000 M	688.000 M	100.00 k	342.128205 M	-54.46	-41.46
688.000 M	726.000 M	100.00 k	711.107800 M	24.28	-8.72
726.000 M	1.000 G	100.00 k	741.818933 M	-34.25	-21.25
1.000 G	20.000 G	1.00 M	1.422433 G	-39.65	-26.65

CONDUCTED SPURIOUS EMISSION

Date: 12.AUG.2020 21:34:22





# Worldwide Testing Services(Taiwan) Co., Ltd.

Report Number: W6M22006-20020-P-247

FCC ID: GX9CTC1052QT

Band XIII

16QAM

5MHz

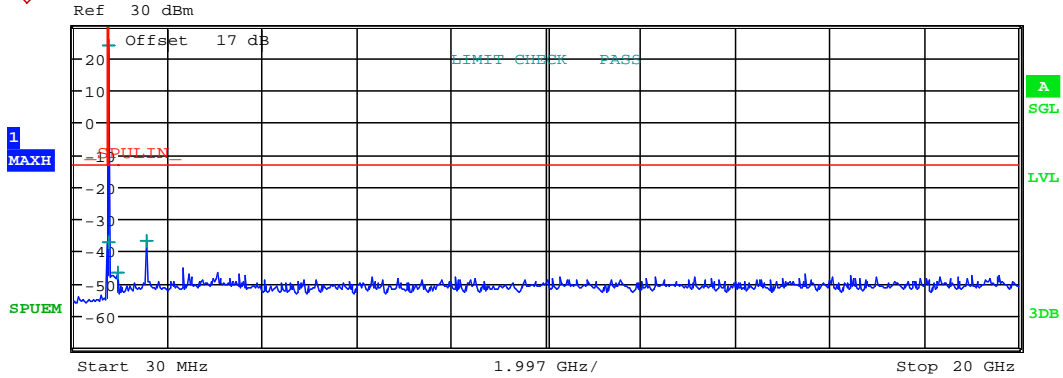

Start [Hz]	Stop [Hz]	RBW [Hz]	Freq [Hz]	PwrAbs [dBm]	ΔLimit [dB]
30.000 M	767.000 M	100.00 k	750.464744 M	-37.16	-24.16
767.000 M	797.000 M	100.00 k	779.711000 M	23.50	-9.50
797.000 M	1.000 G	100.00 k	973.028067 M	-46.99	-33.99
1.000 G	20.000 G	1.00 M	1.558600 G	-37.01	-24.01

CONDUCTED SPURIOUS EMISSION

Date: 12.AUG.2020 21:36:44



Report Number: W6M22006-20020-P-247  
 FCC ID: GX9CTC1052QT

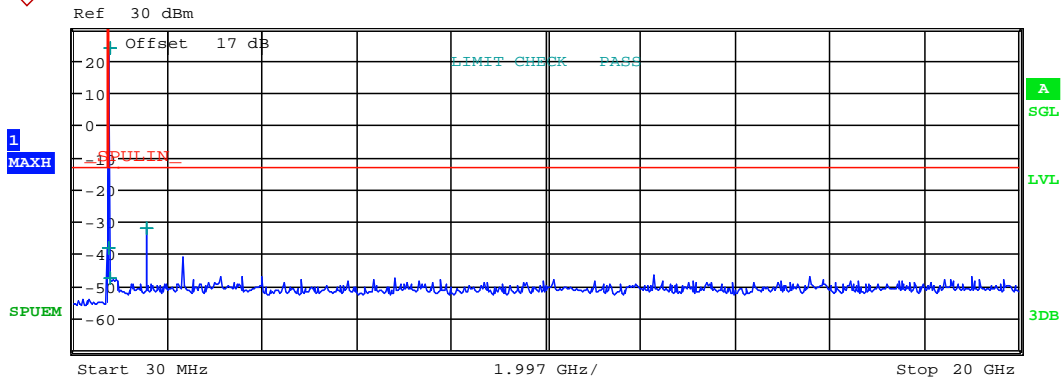

Start [Hz]	Stop [Hz]	RBW [Hz]	Freq [Hz]	PwrAbs [dBm]	ΔLimit [dB]
30.000 M	767.000 M	100.00 k	751.645833 M	-38.48	-25.48
767.000 M	797.000 M	100.00 k	782.225000 M	23.57	-9.43
797.000 M	1.000 G	100.00 k	806.365067 M	-47.74	-34.74
1.000 G	20.000 G	1.00 M	1.563667 G	-32.27	-19.27

CONDUCTED SPURIOUS EMISSION

Date: 12.AUG.2020 21:37:03



Report Number: W6M22006-20020-P-247  
 FCC ID: GX9CTC1052QT

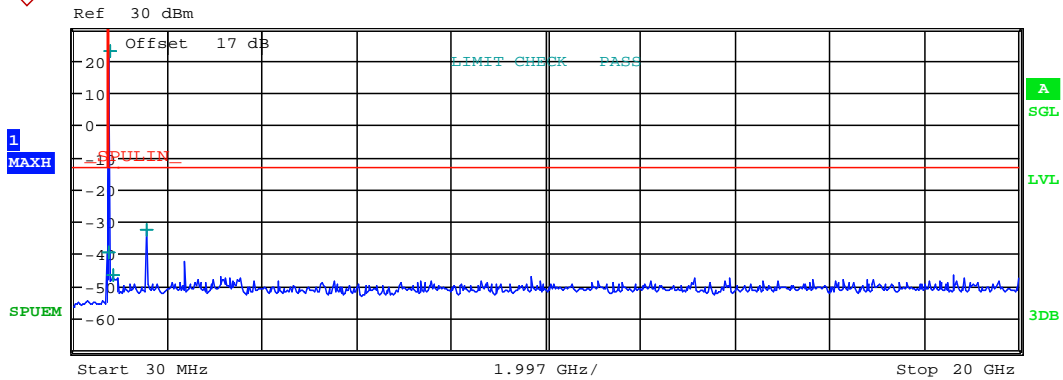

Start 30 MHz 1.997 GHz/ Stop 20 GHz

Start [Hz]	Stop [Hz]	RBW [Hz]	Freq [Hz]	PwrAbs [dBm]	Δ Limit [dB]
30.000 M	767.000 M	100.00 k	752.826923 M	-39.91	-26.91
767.000 M	797.000 M	100.00 k	784.706000 M	22.53	-10.47
797.000 M	1.000 G	100.00 k	869.816100 M	-46.71	-33.71
1.000 G	20.000 G	1.00 M	1.569367 G	-32.70	-19.70

CONDUCTED SPURIOUS EMISSION

Date: 12.AUG.2020 21:37:20



# Worldwide Testing Services(Taiwan) Co., Ltd.

Report Number: W6M22006-20020-P-247

FCC ID: GX9CTC1052QT

10MHz

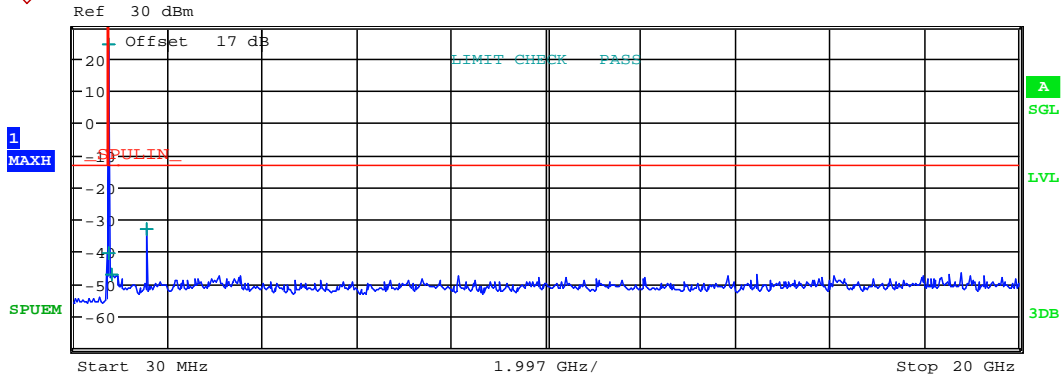

Start 30 MHz 1.997 GHz/ Stop 20 GHz

Start [Hz]	Stop [Hz]	RBW [Hz]	Freq [Hz]	PwrAbs [dBm]	ΔLimit [dB]
30.000 M	767.000 M	100.00 k	751.645833 M	-40.72	-27.72
767.000 M	797.000 M	100.00 k	782.060000 M	24.35	-8.65
797.000 M	1.000 G	100.00 k	834.974533 M	-47.24	-34.24
1.000 G	20.000 G	1.00 M	1.564300 G	-33.02	-20.02

CONDUCTED SPURIOUS EMISSION

Date: 12.AUG.2020 21:39:01



# Worldwide Testing Services(Taiwan) Co., Ltd.

Report Number: W6M22006-20020-P-247

FCC ID: GX9CTC1052QT

QPSK

5MHz

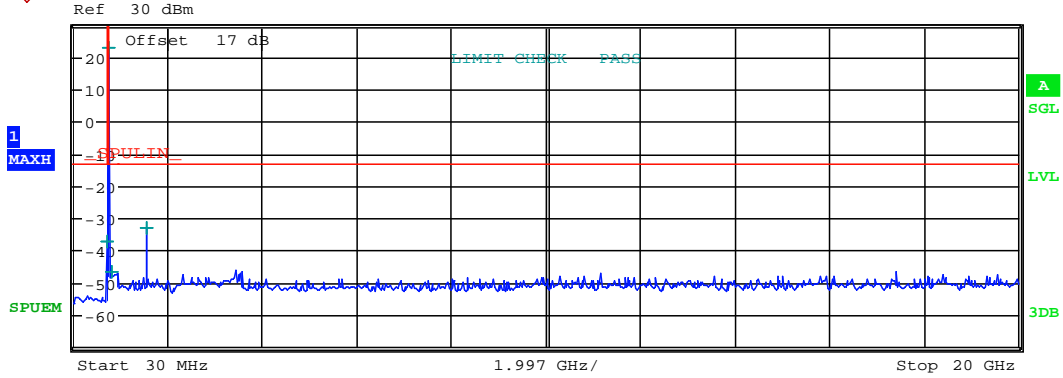

Start [Hz]	Stop [Hz]	RBW [Hz]	Freq [Hz]	PwrAbs [dBm]	ΔLimit [dB]
30.000 M	767.000 M	100.00 k	748.102564 M	-37.56	-24.56
767.000 M	797.000 M	100.00 k	779.696000 M	22.61	-10.39
797.000 M	1.000 G	100.00 k	827.206400 M	-46.85	-33.85
1.000 G	20.000 G	1.00 M	1.559233 G	-33.06	-20.06

CONDUCTED SPURIOUS EMISSION

Date: 12.AUG.2020 21:37:48



Report Number: W6M22006-20020-P-247  
 FCC ID: GX9CTC1052QT

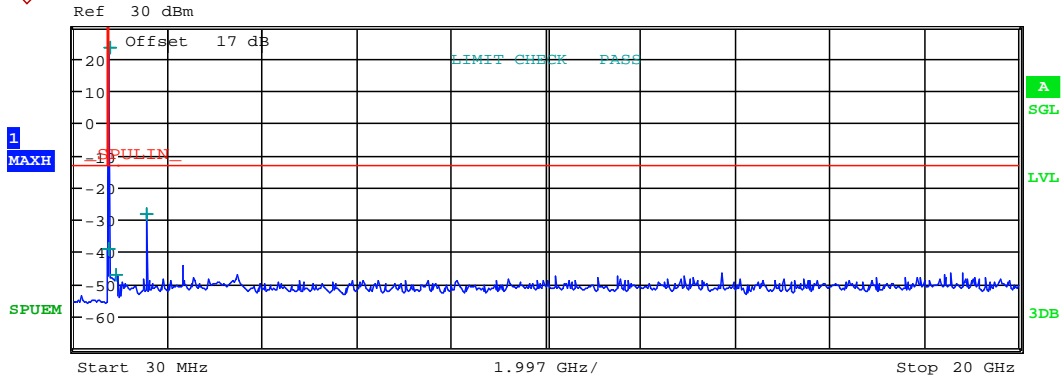

Start 30 MHz 1.997 GHz/ Stop 20 GHz

Start [Hz]	Stop [Hz]	RBW [Hz]	Freq [Hz]	PwrAbs [dBm]	ΔLimit [dB]
30.000 M	767.000 M	100.00 k	752.826923 M	-39.22	-26.22
767.000 M	797.000 M	100.00 k	782.108000 M	23.16	-9.84
797.000 M	1.000 G	100.00 k	939.593967 M	-47.11	-34.11
1.000 G	20.000 G	1.00 M	1.564300 G	-28.48	-15.48

CONDUCTED SPURIOUS EMISSION

Date: 12.AUG.2020 21:38:04



# Worldwide Testing Services(Taiwan) Co., Ltd.

Report Number: W6M22006-20020-P-247  
 FCC ID: GX9CTC1052QT

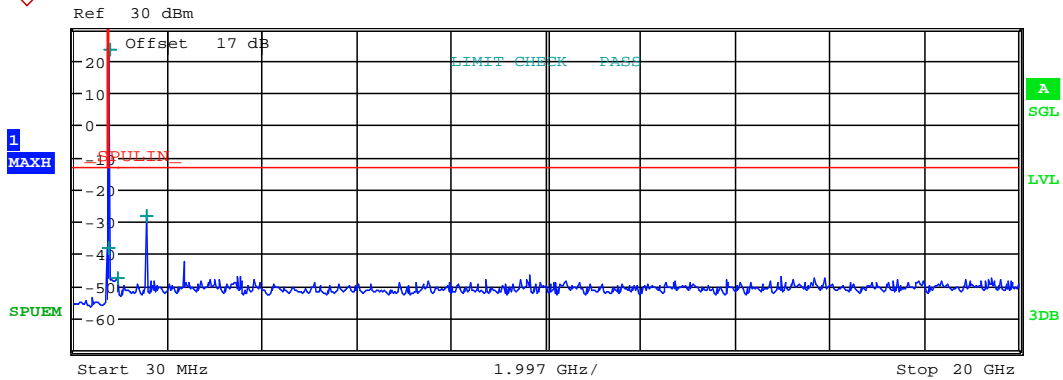

Start 30 MHz 1.997 GHz/ Stop 20 GHz

Start [Hz]	Stop [Hz]	RBW [Hz]	Freq [Hz]	PwrAbs [dBm]	Δ Limit [dB]
30.000 M	767.000 M	100.00 k	752.826923 M	-38.31	-25.31
767.000 M	797.000 M	100.00 k	784.640000 M	23.33	-9.67
797.000 M	1.000 G	100.00 k	960.990167 M	-47.67	-34.67
1.000 G	20.000 G	1.00 M	1.568733 G	-28.50	-15.50

CONDUCTED SPURIOUS EMISSION

Date: 12.AUG.2020 21:38:21



Report Number: W6M22006-20020-P-247

FCC ID: GX9CTC1052QT

10MHz

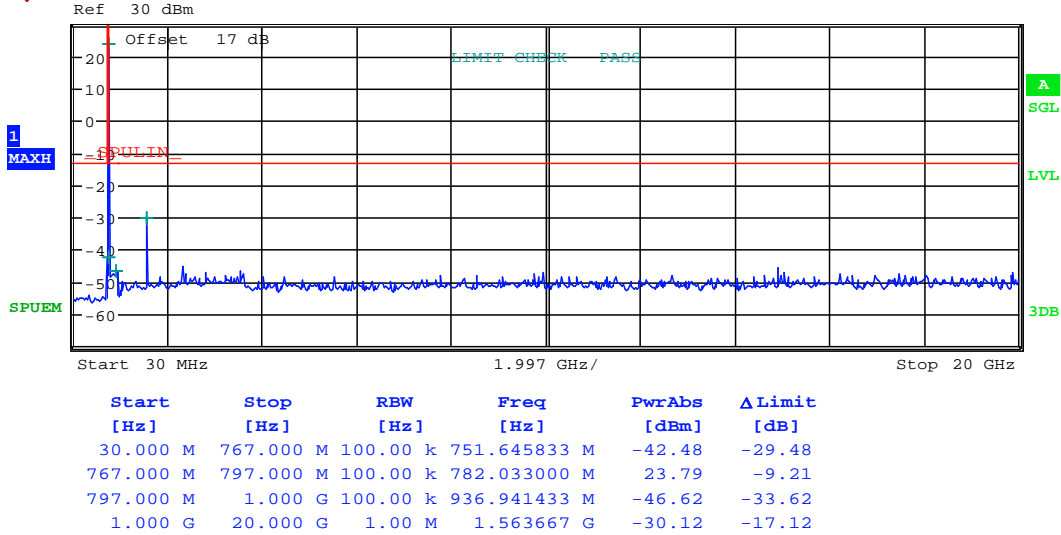

CONDUCTED SPURIOUS EMISSION

Date: 12.AUG.2020 21:39:28

Test equipment: ETSTW-RE 055, ETSTW-GSM 002, ETSTW-GSM 023, ETSTW-GSM 004

### 7.3 Explanation of test result

All factors like cable loss and external attenuation etc. are already included in the provided measurement results. This is done by using validated test software and calibrated test system according to the accreditation requirements.

### 7.4 Calculation of Limit for Spurious at Antenna Terminals

Compliance with § 22.917, §24.238, §27.53 requires that any emission be attenuated below the transmitter power at least  $43 + 10 \log P$  ( $P$  = transmitter power in Watts).

Limit for Spurious Emissions at Antenna Terminals:  $L=P-A=-13\text{dBm}$





Report Number: W6M22006-20020-P-247

FCC ID: GX9CTC1052QT

## 8. Field Strength of Spurious Radiation

### 8.1 Test procedure

The test procedure for filed strength measurement is same as radiated power except for a notch filter or band pass filter is used to avoid the influence of fundamental to the pre-amplifier. The measurements below 1GHz were performed with a measurement bandwidth of 100kHz, above 1GHz with a bandwidth of 1 MHz.

### 8.2 Test Results

The measurements of the spurious emission are at the upper, center and lower channel.

CTC-1052xxx-  
xxxxx Series  
Model: (x=0~9, A~Z or blank) Date: \_\_\_\_\_

Mode: -- Temperature: -- °C Engineer: --  
Polarization: Horizontal Humidity: -- %

Frequency (MHz)	Reading (dBm) Peak	Factor (dB) Corr.	Result (dBm)	Limit (dBm)	Margin (dB)	Table Degree (Deg.)	Ant. High (cm)
--	--	--	--	--	--	--	--
--	--	--	--	--	--	--	--

Polarization: Vertical

Frequency (MHz)	Reading (dBm) Peak	Factor (dB) Corr.	Result (dBm)	Limit (dBm)	Margin (dB)	Table Degree (Deg.)	Ant. High (cm)
--	--	--	--	--	--	--	--
--	--	--	--	--	--	--	--

- Note**
1. Correction Factor = Antenna factor + Cable loss - Preamplifier
  2. The formula of measured value as: Test Result = Reading + Correction Factor
  3. Detector function in the form: PK = Peak, QP = Quasi Peak, AV = Average
  4. All not in the table noted test results are more than 20 dB below the relevant limits.
  5. See attached diagrams in appendix.

### 8.3 Explanation of test result

Result Level = Reading Level + Corrected Factor

Corrected Factor = SG level – Received level-Cable loss + substitution antenna gain

### 8.4 Calculation of Limit for Field Strength of Spurious

Compliance with § 22.917, § 24.238, § 27.53 requires that any emission be attenuated below the transmitter power at least  $43 + 10 \log P$  (P = transmitter power in Watts).

Limit for Spurious Emissions at Antenna Terminals:  $L=P-A=-13\text{dBm}$

Test equipment: ETSTW-RE 004, ETSTW-RE 018, ETSTW-RE 030, ETSTW-RE 062,  
ETSTW-RE 142, ETSTW-RE 147, ETSTW-GSM 004



Report Number: W6M22006-20020-P-247

FCC ID: GX9CTC1052QT

## 8.5 Test result of band edge emissions

Test date: August 05, 2020- August 06, 2020

Temperature: 24.9 °C

Humidity: 48.2 %

Tester: Kent

WCDMA

Band II

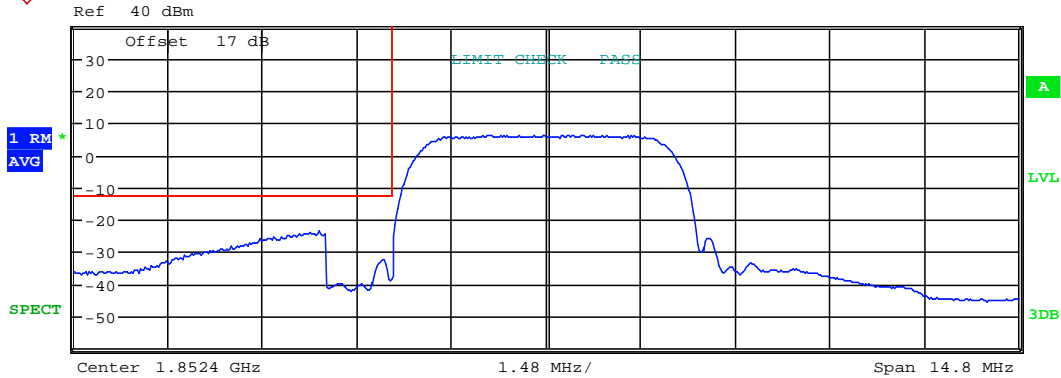

Tx Channel				-BW_4_8_MHz_lower UL			
Bandwidth		4.8 MHz	Power			21.06 dBm	
Start [Hz]	Stop [Hz]	RBW [Hz]	Freq [Hz]	PwrAbs [dBm]	PwrRel [dBc]	ΔLimit [dB]	
-7.400 M	-3.400 M	1.00 M	1.848842 G	-23.84	-44.90	-10.84	
-3.400 M	-2.400 M	20.00 k	1.849862 G	-32.47	-53.53	-19.47	
2.400 M	7.400 M	100.00 k	1.854938 G	-25.80	-46.86	-325.80	

Date: 5.AUG.2020 20:03:27



# Worldwide Testing Services(Taiwan) Co., Ltd.

Report Number: W6M22006-20020-P-247  
 FCC ID: GX9CTC1052QT

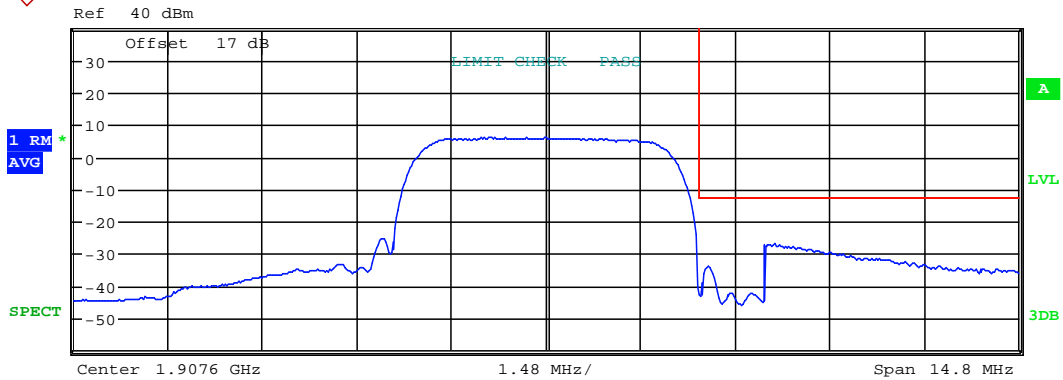

Tx Channel				-BW_4_8_MHz_higher UL		
Bandwidth		4.8 MHz	Power		20.86 dBm	
Start	Stop	RBW	Freq	PwrAbs	PwrRel	Δ Limit
[Hz]	[Hz]	[Hz]	[Hz]	[dBm]	[dBc]	[dB]
-7.400 M	-2.400 M	100.00 k	1.905062 G	-25.38	-46.25	-325.38
2.400 M	3.400 M	20.00 k	1.910138 G	-34.15	-55.01	-21.15
3.400 M	7.400 M	1.00 M	1.911181 G	-27.03	-47.89	-14.03

Date: 5.AUG.2020 20:04:41



# Worldwide Testing Services(Taiwan) Co., Ltd.

Report Number: W6M22006-20020-P-247

FCC ID: GX9CTC1052QT

Band IV

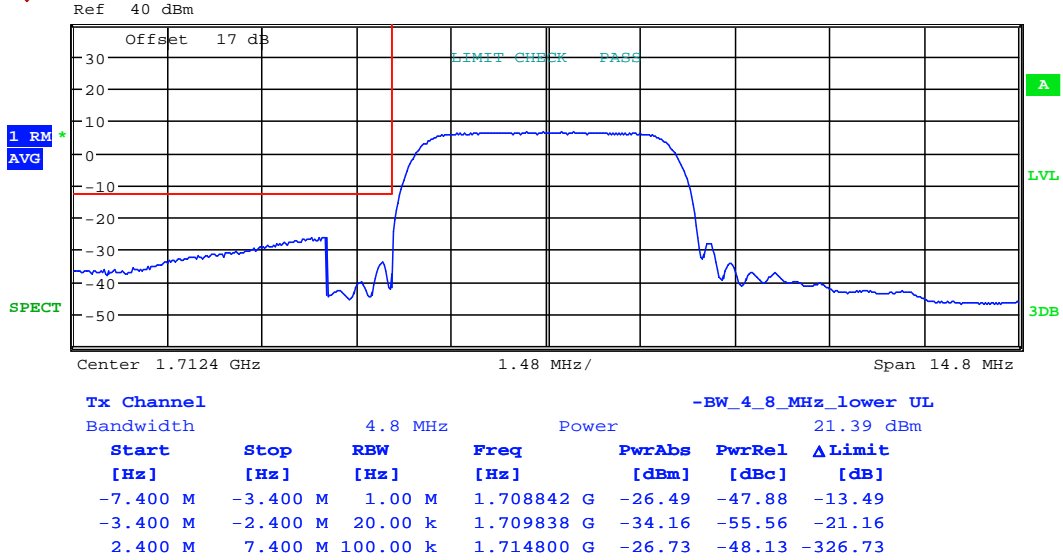

Date: 5.AUG.2020 20:09:47



# Worldwide Testing Services(Taiwan) Co., Ltd.

Report Number: W6M22006-20020-P-247  
 FCC ID: GX9CTC1052QT

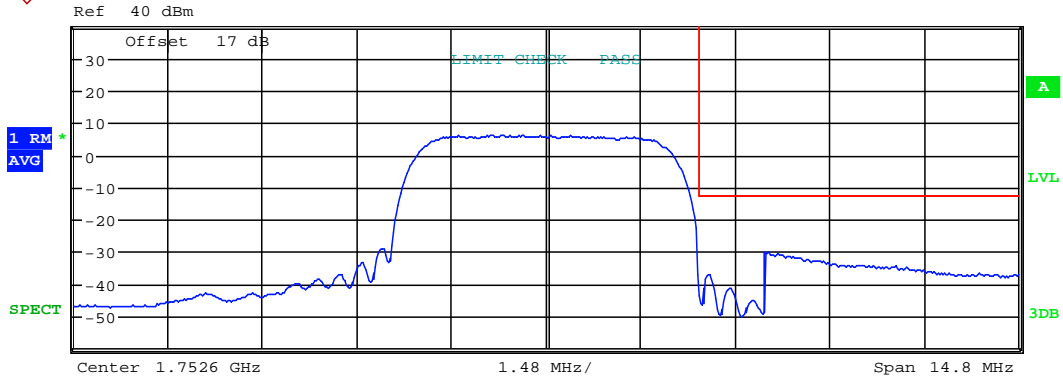

Tx Channel				-BW_4_8_MHz_higher UL		
Bandwidth		4.8 MHz	Power		20.89 dBm	
Start [Hz]	Stop [Hz]	RBW [Hz]	Freq [Hz]	PwrAbs [dBm]	PwrRel [dBc]	Δ Limit [dB]
-7.400 M	-2.400 M	100.00 k	1.750181 G	-28.23	-49.12	-328.23
2.400 M	3.400 M	20.00 k	1.755138 G	-37.09	-57.98	-24.09
3.400 M	7.400 M	1.00 M	1.756015 G	-29.97	-50.86	-16.97

Date: 5.AUG.2020 20:05:38



# Worldwide Testing Services(Taiwan) Co., Ltd.

Report Number: W6M22006-20020-P-247

FCC ID: GX9CTC1052QT

Band V

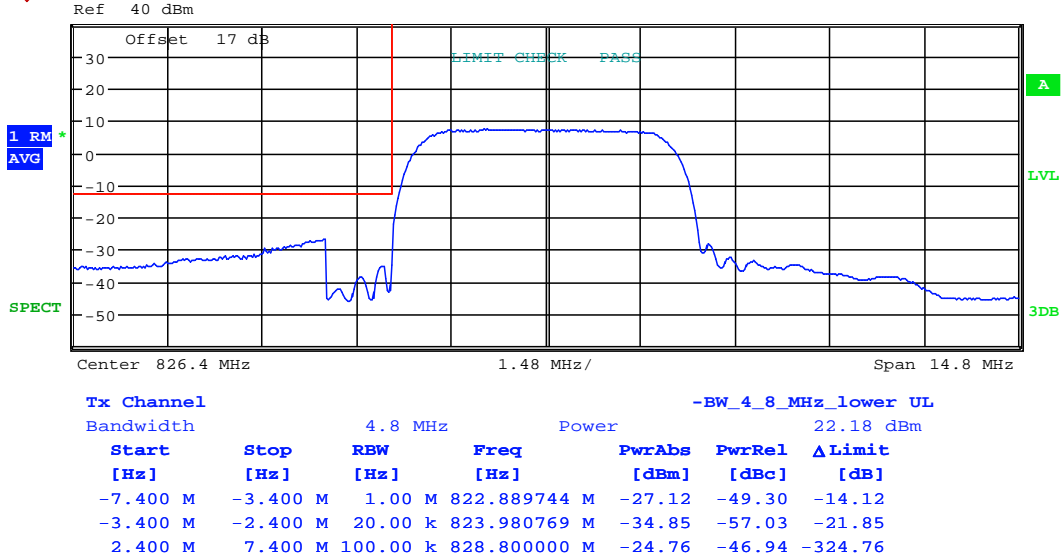

Date: 5.AUG.2020 20:08:58



# Worldwide Testing Services(Taiwan) Co., Ltd.

Report Number: W6M22006-20020-P-247  
 FCC ID: GX9CTC1052QT

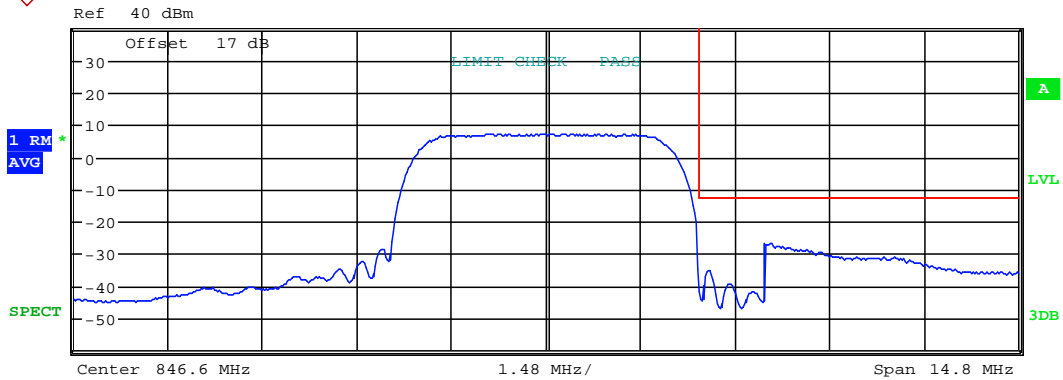

Tx Channel				-BW_4_8_MHz_higher UL			
Bandwidth		4.8 MHz		Power		22.09 dBm	
Start	Stop	RBW	Freq	PwrAbs	PwrRel	Δ Limit	
[Hz]	[Hz]	[Hz]	[Hz]	[dBm]	[dBc]	[dB]	
-7.400 M	-2.400 M	100.00 k	844.180769 M	-26.29	-48.38	-326.29	
2.400 M	3.400 M	20.00 k	849.161538 M	-35.35	-57.44	-22.35	
3.400 M	7.400 M	1.00 M	850.015385 M	-26.83	-48.92	-13.83	

Date: 5.AUG.2020 20:08:06



# Worldwide Testing Services(Taiwan) Co., Ltd.

Report Number: W6M22006-20020-P-247  
 FCC ID: GX9CTC1052QT

LTE  
 Band II  
 16QAM  
 1RB  
 1.4MHz

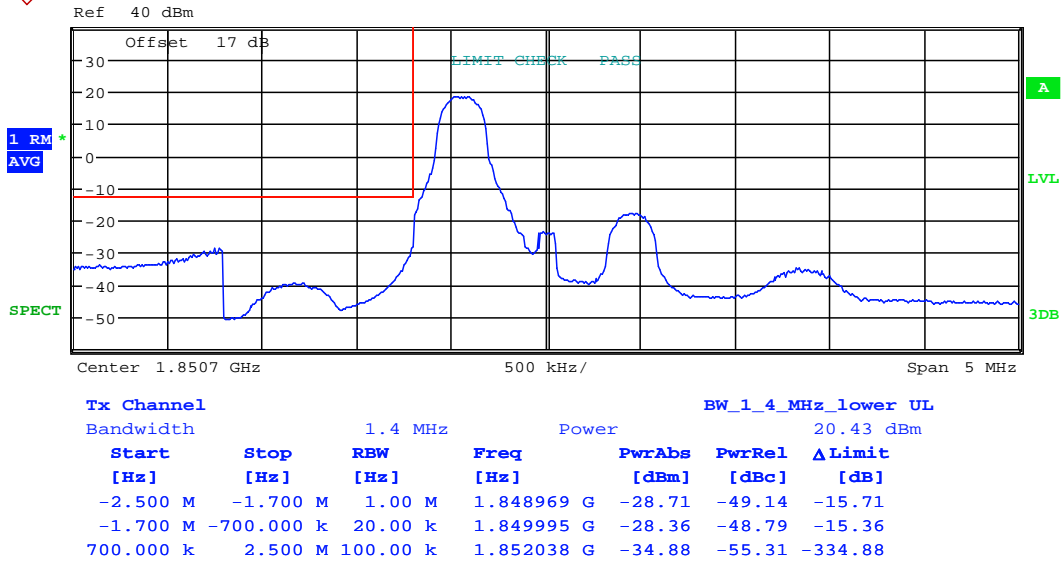

Date: 5.AUG.2020 20:16:53





# Worldwide Testing Services(Taiwan) Co., Ltd.

Report Number: W6M22006-20020-P-247  
 FCC ID: GX9CTC1052QT

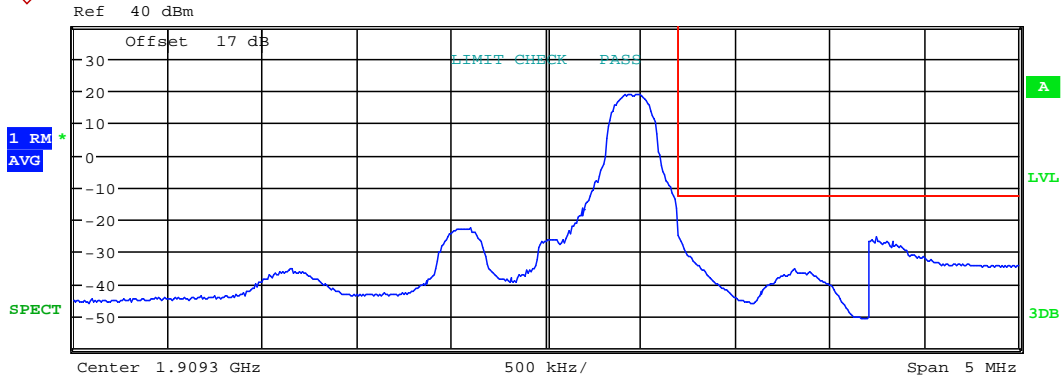

Tx Channel				BW_1_4_MHz_higher UL		
Bandwidth		1.4 MHz	Power		20.71 dBm	
Start	Stop	RBW	Freq	PwrAbs	PwrRel	ΔLimit
[Hz]	[Hz]	[Hz]	[Hz]	[dBm]	[dBc]	[dB]
-2.500 M	-700.000 k	100.00 k	1.907946 G	-35.58	-56.29	-335.58
700.000 k	1.700 M	20.00 k	1.910000 G	-16.86	-37.57	-3.86
1.700 M	2.500 M	1.00 M	1.911047 G	-25.42	-46.13	-12.42

Date: 5.AUG.2020 20:18:49



# Worldwide Testing Services(Taiwan) Co., Ltd.

Report Number: W6M22006-20020-P-247

FCC ID: GX9CTC1052QT

3MHz

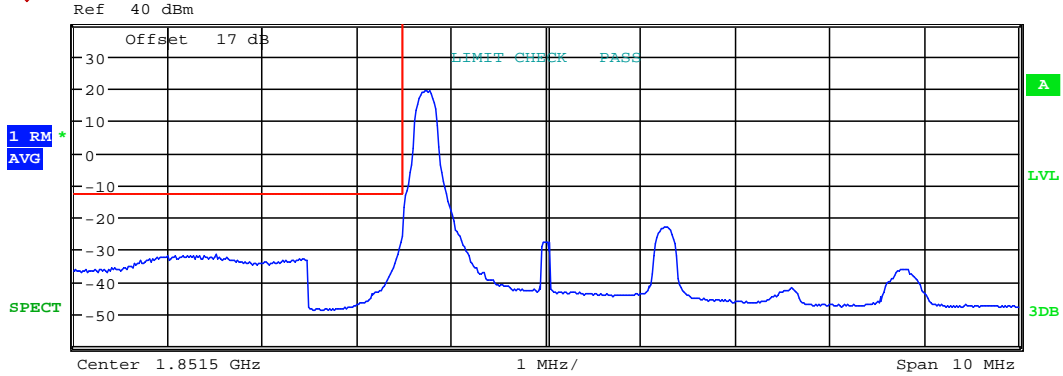

Tx Channel				BW_3_MHz_lower UL		
Bandwidth				Power		
Start	Stop	RBW	Freq	PwrAbs	PwrRel	ΔLimit
[Hz]	[Hz]	[Hz]	[Hz]	[dBm]	[dBc]	[dB]
-5.000 M	-2.500 M	1.00 M	1.847878 G	-31.86	-52.96	-18.86
-2.500 M	-1.500 M	30.00 k	1.849978 G	-25.99	-47.09	-12.99
1.500 M	5.000 M	100.00 k	1.855282 G	-36.06	-57.16	-336.06

Date: 5.AUG.2020 20:20:53



# Worldwide Testing Services(Taiwan) Co., Ltd.

Report Number: W6M22006-20020-P-247  
 FCC ID: GX9CTC1052QT

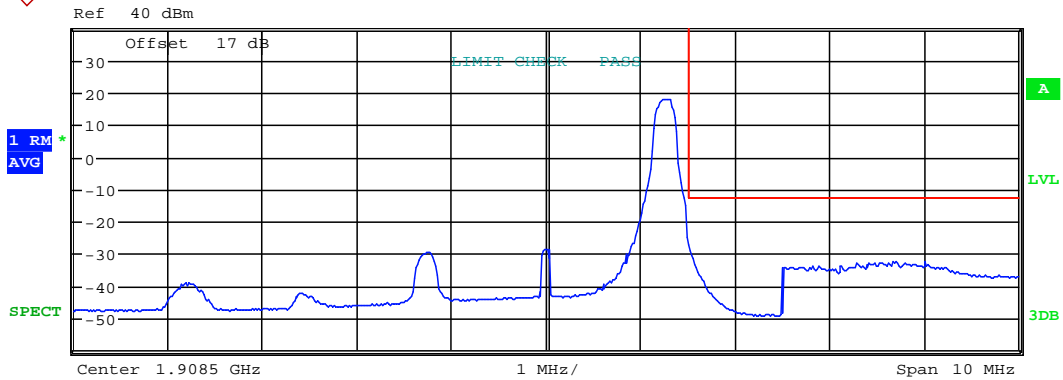

Tx Channel				BW_3_MHz_higher UL		
Bandwidth		3 MHz	Power		19.99 dBm	
Start [Hz]	Stop [Hz]	RBW [Hz]	Freq [Hz]	PwrAbs [dBm]	PwrRel [dBc]	Δ Limit [dB]
-5.000 M	-1.500 M	100.00 k	1.904718 G	-38.97	-58.96	-338.97
1.500 M	2.500 M	30.00 k	1.910006 G	-25.57	-45.56	-12.57
2.500 M	5.000 M	1.00 M	1.912170 G	-32.51	-52.50	-19.51

Date: 5.AUG.2020 20:22:25



# Worldwide Testing Services(Taiwan) Co., Ltd.

Report Number: W6M22006-20020-P-247

FCC ID: GX9CTC1052QT

5MHz

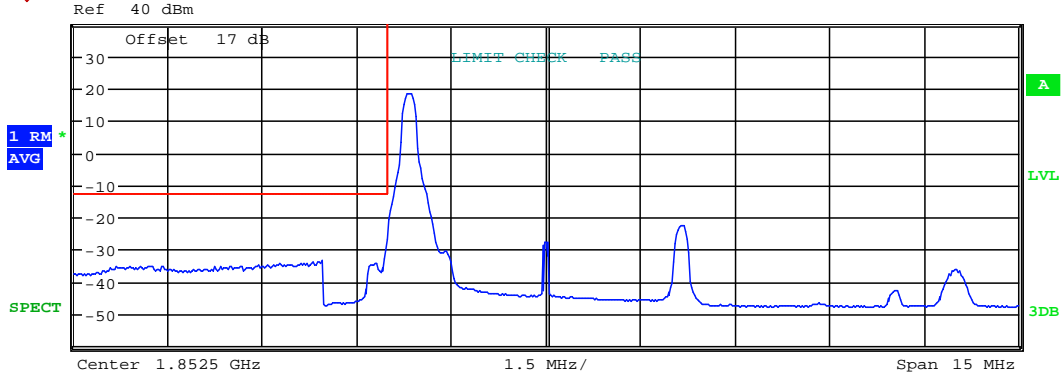

Tx Channel				BW_5_MHz_lower UL		
Bandwidth			5 MHz	Power		
Start	Stop	RBW	Freq	PwrAbs	PwrRel	ΔLimit
[Hz]	[Hz]	[Hz]	[Hz]	[dBm]	[dBc]	[dB]
-7.500 M	-3.500 M	1.00 M	1.848942 G	-33.13	-53.69	-20.13
-3.500 M	-2.500 M	50.00 k	1.849976 G	-26.88	-47.44	-13.88
2.500 M	7.500 M	100.00 k	1.858990 G	-36.17	-56.74	-336.17

Date: 5.AUG.2020 20:24:01



# Worldwide Testing Services(Taiwan) Co., Ltd.

Report Number: W6M22006-20020-P-247  
 FCC ID: GX9CTC1052QT

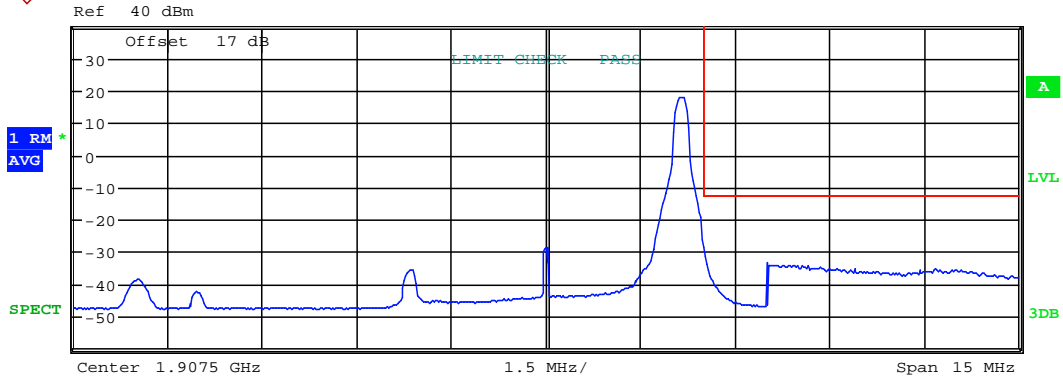

Tx Channel				BW_5_MHz_higher UL		
Bandwidth		5 MHz	Power		20.16 dBm	
Start [Hz]	Stop [Hz]	RBW [Hz]	Freq [Hz]	PwrAbs [dBm]	PwrRel [dBc]	Δ Limit [dB]
-7.500 M	-2.500 M	100.00 k	1.901010 G	-38.66	-58.82	-338.66
2.500 M	3.500 M	50.00 k	1.910000 G	-26.74	-46.90	-13.74
3.500 M	7.500 M	1.00 M	1.911034 G	-34.18	-54.34	-21.18

Date: 5.AUG.2020 20:25:00



# Worldwide Testing Services(Taiwan) Co., Ltd.

Report Number: W6M22006-20020-P-247

FCC ID: GX9CTC1052QT

10MHz

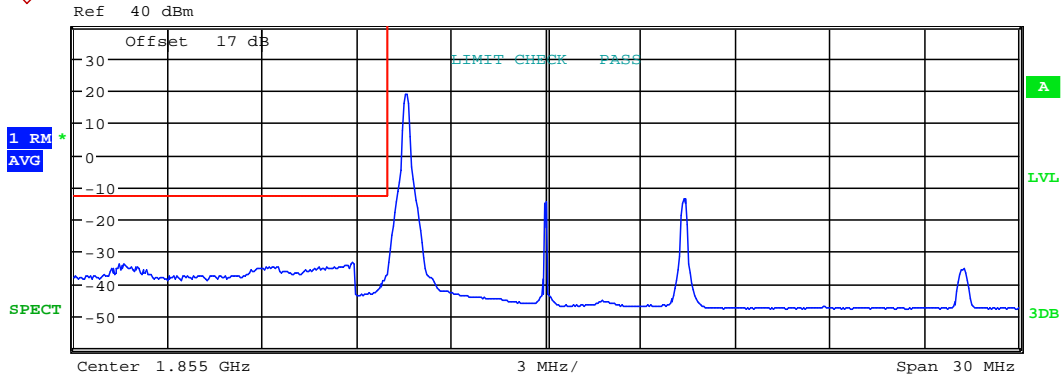

Tx Channel				BW_10_MHz_lower UL		
Bandwidth		10 MHz	Power		21.30 dBm	
Start [Hz]	Stop [Hz]	RBW [Hz]	Freq [Hz]	PwrAbs [dBm]	PwrRel [dBc]	ΔLimit [dB]
-15.000 M	-6.000 M	1.00 M	1.841442 G	-33.42	-54.72	-20.42
-6.000 M	-5.000 M	100.00 k	1.849952 G	-37.12	-58.42	-24.12
5.000 M	15.000 M	100.00 k	1.868269 G	-35.12	-56.43	-335.12

Date: 5.AUG.2020 20:26:25



Report Number: W6M22006-20020-P-247  
 FCC ID: GX9CTC1052QT

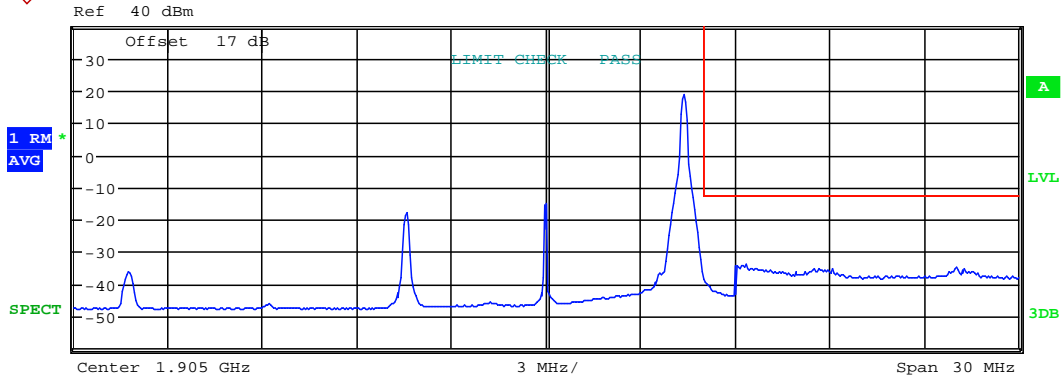

Tx Channel				BW_10_MHz_higher UL		
Bandwidth		10 MHz	Power		20.69 dBm	
Start [Hz]	Stop [Hz]	RBW [Hz]	Freq [Hz]	PwrAbs [dBm]	PwrRel [dBc]	ΔLimit [dB]
-15.000 M	-5.000 M	100.00 k	1.891731 G	-36.37	-57.06	-336.37
5.000 M	6.000 M	100.00 k	1.910000 G	-36.90	-57.60	-23.90
6.000 M	15.000 M	1.00 M	1.911346 G	-34.05	-54.74	-21.05

Date: 5.AUG.2020 20:27:43



# Worldwide Testing Services(Taiwan) Co., Ltd.

Report Number: W6M22006-20020-P-247

FCC ID: GX9CTC1052QT

15MHz

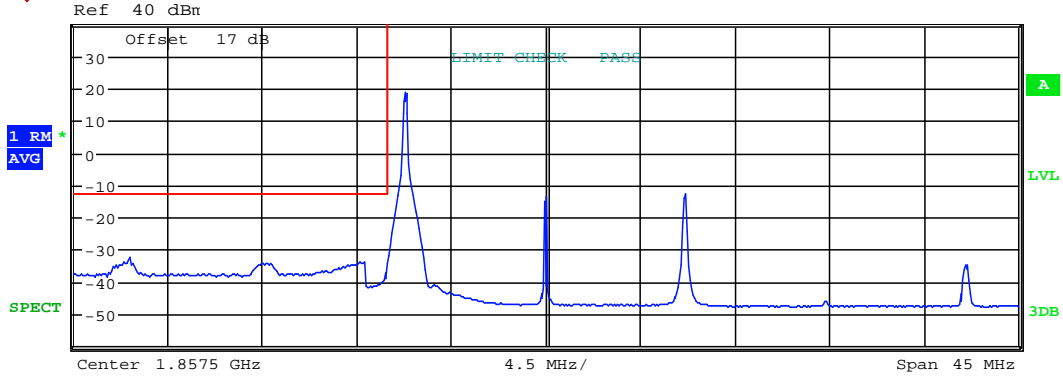

Tx Channel				BW_15_MHz_lower UL		
Bandwidth		15 MHz	Power		21.30 dBm	
Start [Hz]	Stop [Hz]	RBW [Hz]	Freq [Hz]	PwrAbs [dBm]	PwrRel [dBc]	ΔLimit [dB]
-22.500 M	-8.500 M	1.00 M	1.837668 G	-33.12	-54.42	-20.12
-8.500 M	-7.500 M	150.00 k	1.849928 G	-34.06	-55.36	-21.06
7.500 M	22.500 M	100.00 k	1.877476 G	-34.66	-55.96	-334.66

Date: 5.AUG.2020 20:29:02





# Worldwide Testing Services(Taiwan) Co., Ltd.

Report Number: W6M22006-20020-P-247  
 FCC ID: GX9CTC1052QT

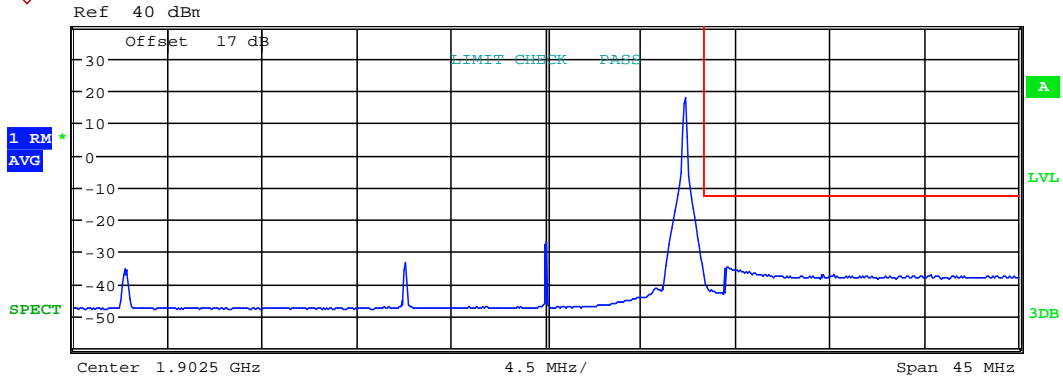

Tx Channel				BW_15_MHz_higher UL			
Bandwidth		15 MHz		Power		19.94 dBm	
Start	Stop	RBW	Freq	PwrAbs	PwrRel	Δ Limit	
[Hz]	[Hz]	[Hz]	[Hz]	[dBm]	[dBc]	[dB]	
-22.500 M	-7.500 M	100.00 k	1.882452 G	-35.45	-55.39	-335.45	
7.500 M	8.500 M	150.00 k	1.910000 G	-34.60	-54.54	-21.60	
8.500 M	22.500 M	1.00 M	1.911082 G	-35.03	-54.97	-22.03	

Date: 5.AUG.2020 20:30:01



# Worldwide Testing Services(Taiwan) Co., Ltd.

Report Number: W6M22006-20020-P-247

FCC ID: GX9CTC1052QT

20MHz

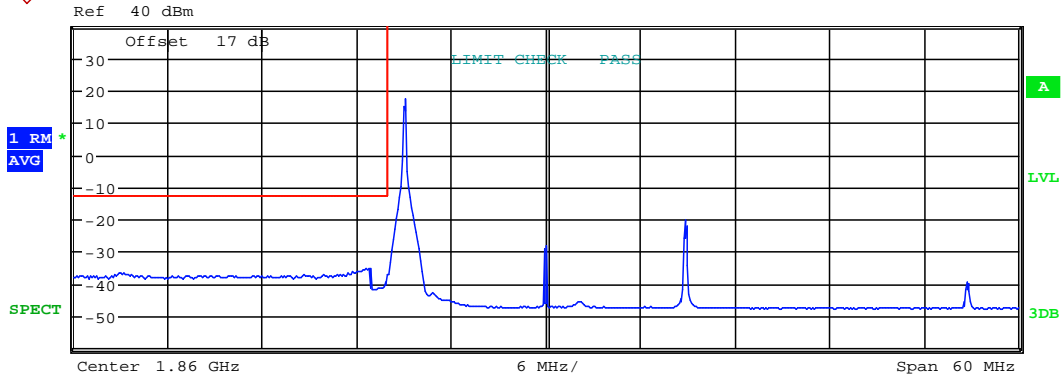

Tx Channel				BW_20_MHz_lower UL		
Bandwidth		20 MHz	Power		19.83 dBm	
Start [Hz]	Stop [Hz]	RBW [Hz]	Freq [Hz]	PwrAbs [dBm]	PwrRel [dBc]	Δ Limit [dB]
-30.000 M	-11.000 M	1.00 M	1.848750 G	-35.25	-55.08	-22.25
-11.000 M	-10.000 M	200.00 k	1.849904 G	-37.24	-57.07	-24.24
10.000 M	30.000 M	100.00 k	1.886731 G	-39.76	-59.59	-339.76

Date: 5.AUG.2020 20:31:06



# Worldwide Testing Services(Taiwan) Co., Ltd.

Report Number: W6M22006-20020-P-247  
 FCC ID: GX9CTC1052QT

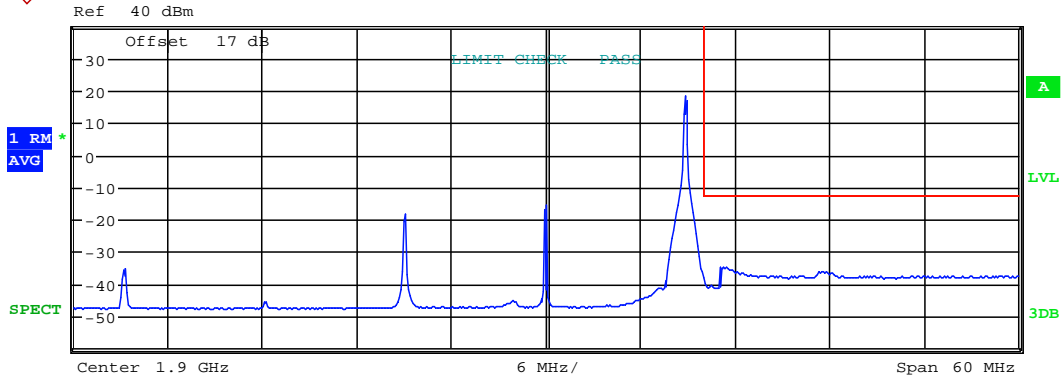

Tx Channel				BW_20_MHz_higher UL		
Bandwidth		20 MHz	Power		20.72 dBm	
Start	Stop	RBW	Freq	PwrAbs	PwrRel	Δ Limit
[Hz]	[Hz]	[Hz]	[Hz]	[dBm]	[dBc]	[dB]
-30.000 M	-10.000 M	100.00 k	1.873269 G	-35.52	-56.24	-335.52
10.000 M	11.000 M	200.00 k	1.910000 G	-36.71	-57.43	-23.71
11.000 M	30.000 M	1.00 M	1.911058 G	-34.91	-55.63	-21.91

Date: 5.AUG.2020 20:32:03



# Worldwide Testing Services(Taiwan) Co., Ltd.

Report Number: W6M22006-20020-P-247

FCC ID: GX9CTC1052QT

QPSK

FRB

1.4MHz

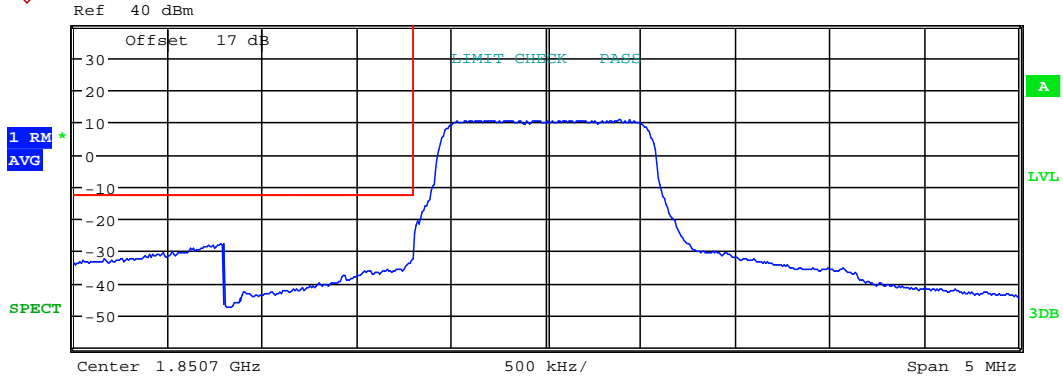

Tx Channel				BW_1_4_MHz_lower UL		
Bandwidth		1.4 MHz		Power		20.04 dBm
Start	Stop	RBW	Freq	PwrAbs	PwrRel	Δ Limit
[Hz]	[Hz]	[Hz]	[Hz]	[dBm]	[dBc]	[dB]
-2.500 M	-1.700 M	1.00 M	1.848993 G	-27.53	-47.57	-14.53
-1.700 M	-700.000 k	20.00 k	1.849995 G	-32.50	-52.54	-19.50
700.000 k	2.500 M	100.00 k	1.851400 G	-23.05	-43.09	-323.05

Date: 5.AUG.2020 20:37:23



# Worldwide Testing Services(Taiwan) Co., Ltd.

Report Number: W6M22006-20020-P-247  
 FCC ID: GX9CTC1052QT

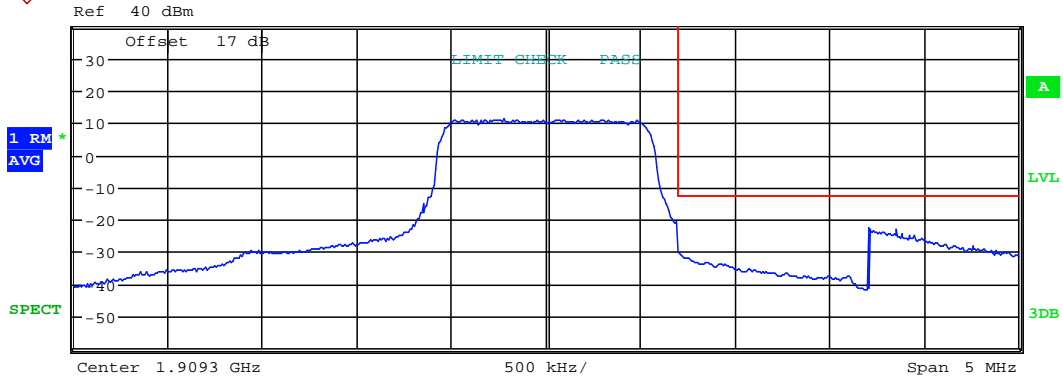

Tx Channel				BW_1_4_MHz_higher UL		
Bandwidth		1.4 MHz	Power		20.36 dBm	
Start	Stop	RBW	Freq	PwrAbs	PwrRel	ΔLimit
[Hz]	[Hz]	[Hz]	[Hz]	[dBm]	[dBc]	[dB]
-2.500 M	-700.000 k	100.00 k	1.908595 G	-21.83	-42.19	-321.83
700.000 k	1.700 M	20.00 k	1.910000 G	-20.95	-41.31	-7.95
1.700 M	2.500 M	1.00 M	1.911007 G	-22.74	-43.10	-9.74

Date: 5.AUG.2020 20:38:10



# Worldwide Testing Services(Taiwan) Co., Ltd.

Report Number: W6M22006-20020-P-247

FCC ID: GX9CTC1052QT

3MHz

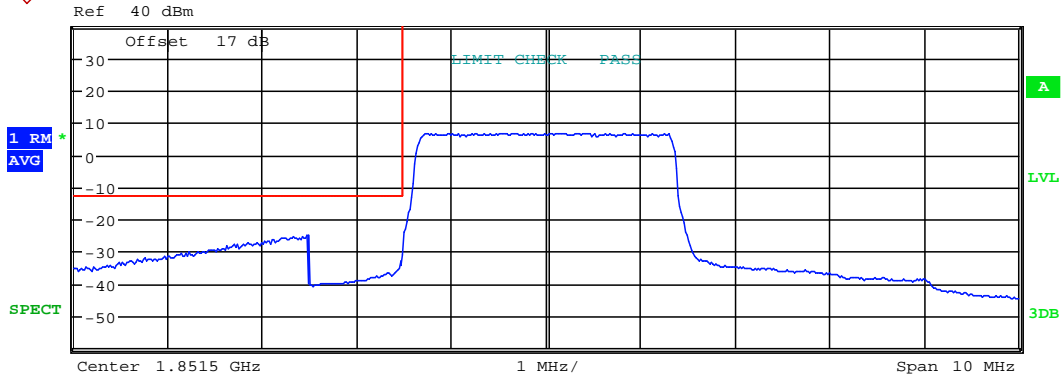

Tx Channel				BW_3_MHz_lower UL		
Bandwidth		3 MHz	Power		20.16 dBm	
Start [Hz]	Stop [Hz]	RBW [Hz]	Freq [Hz]	PwrAbs [dBm]	PwrRel [dBc]	ΔLimit [dB]
-5.000 M	-2.500 M	1.00 M	1.848984 G	-24.66	-44.82	-11.66
-2.500 M	-1.500 M	30.00 k	1.849978 G	-31.30	-51.46	-18.30
1.500 M	5.000 M	100.00 k	1.853006 G	-25.48	-45.65	-325.48

Date: 5.AUG.2020 20:40:41



# Worldwide Testing Services(Taiwan) Co., Ltd.

Report Number: W6M22006-20020-P-247  
 FCC ID: GX9CTC1052QT

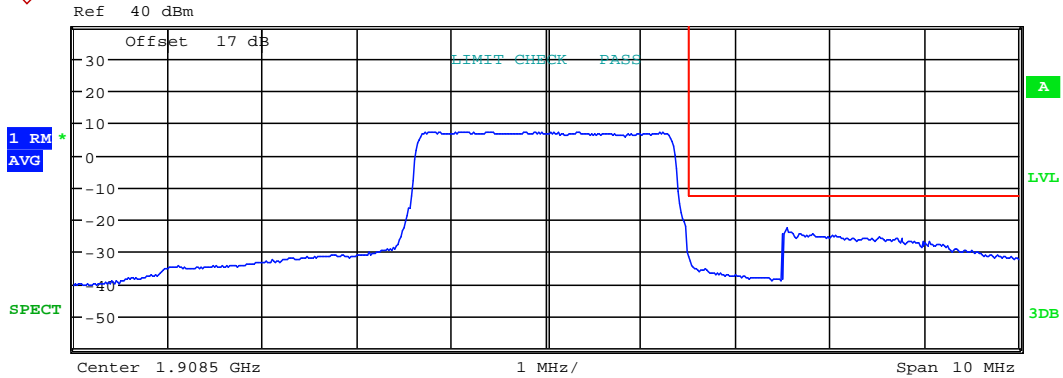

Tx Channel				BW_3_MHz_higher UL		
Bandwidth		3 MHz	Power		20.54 dBm	
Start [Hz]	Stop [Hz]	RBW [Hz]	Freq [Hz]	PwrAbs [dBm]	PwrRel [dBc]	Δ Limit [dB]
-5.000 M	-1.500 M	100.00 k	1.906978 G	-23.65	-44.19	-323.65
1.500 M	2.500 M	30.00 k	1.910006 G	-30.56	-51.10	-17.56
2.500 M	5.000 M	1.00 M	1.911048 G	-22.77	-43.31	-9.77

Date: 5.AUG.2020 20:42:41



# Worldwide Testing Services(Taiwan) Co., Ltd.

Report Number: W6M22006-20020-P-247

FCC ID: GX9CTC1052QT

5MHz

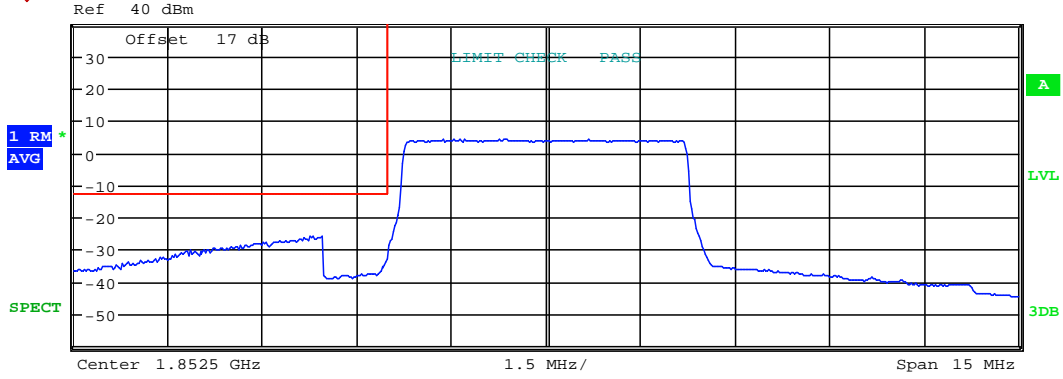

Tx Channel				BW_5_MHz_lower UL		
Bandwidth		5 MHz	Power		19.83 dBm	
Start [Hz]	Stop [Hz]	RBW [Hz]	Freq [Hz]	PwrAbs [dBm]	PwrRel [dBc]	Δ Limit [dB]
-7.500 M	-3.500 M	1.00 M	1.848942 G	-26.12	-45.95	-13.12
-3.500 M	-2.500 M	50.00 k	1.849976 G	-33.02	-52.85	-20.02
2.500 M	7.500 M	100.00 k	1.855000 G	-29.60	-49.43	-329.60

Date: 5.AUG.2020 21:06:55





# Worldwide Testing Services(Taiwan) Co., Ltd.

Report Number: W6M22006-20020-P-247  
 FCC ID: GX9CTC1052QT

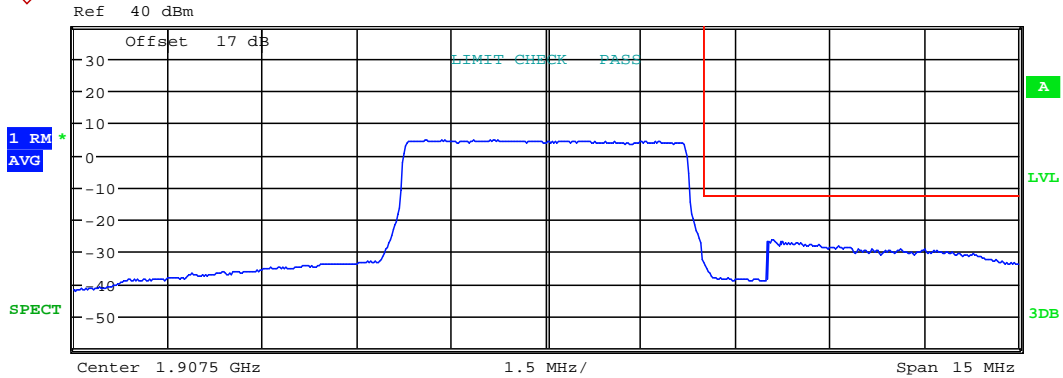

Tx Channel				BW_5_MHz_higher UL		
Bandwidth		5 MHz	Power		20.19 dBm	
Start [Hz]	Stop [Hz]	RBW [Hz]	Freq [Hz]	PwrAbs [dBm]	PwrRel [dBc]	Δ Limit [dB]
-7.500 M	-2.500 M	100.00 k	1.904976 G	-28.68	-48.87	-328.68
2.500 M	3.500 M	50.00 k	1.910000 G	-32.78	-52.97	-19.78
3.500 M	7.500 M	1.00 M	1.911082 G	-26.50	-46.68	-13.50

Date: 5.AUG.2020 21:07:34



# Worldwide Testing Services(Taiwan) Co., Ltd.

Report Number: W6M22006-20020-P-247

FCC ID: GX9CTC1052QT

10MHz

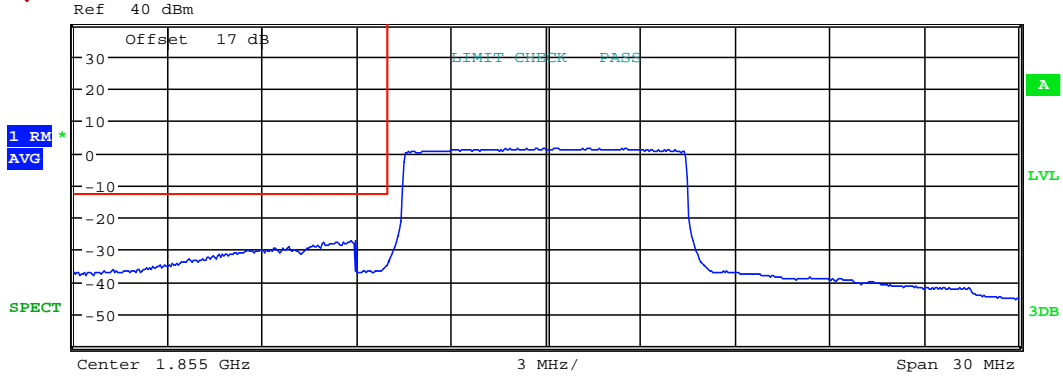

Tx Channel				BW_10_MHz_lower UL		
Bandwidth				Power		
Start	Stop	RBW	Freq	PwrAbs	PwrRel	ΔLimit
[Hz]	[Hz]	[Hz]	[Hz]	[dBm]	[dBc]	[dB]
-15.000 M	-6.000 M	1.00 M	1.848798 G	-27.33	-47.33	-14.33
-6.000 M	-5.000 M	100.00 k	1.849952 G	-34.43	-54.43	-21.43
5.000 M	15.000 M	100.00 k	1.860000 G	-34.91	-54.91	-334.91

Date: 5.AUG.2020 21:09:22



# Worldwide Testing Services(Taiwan) Co., Ltd.

Report Number: W6M22006-20020-P-247  
 FCC ID: GX9CTC1052QT

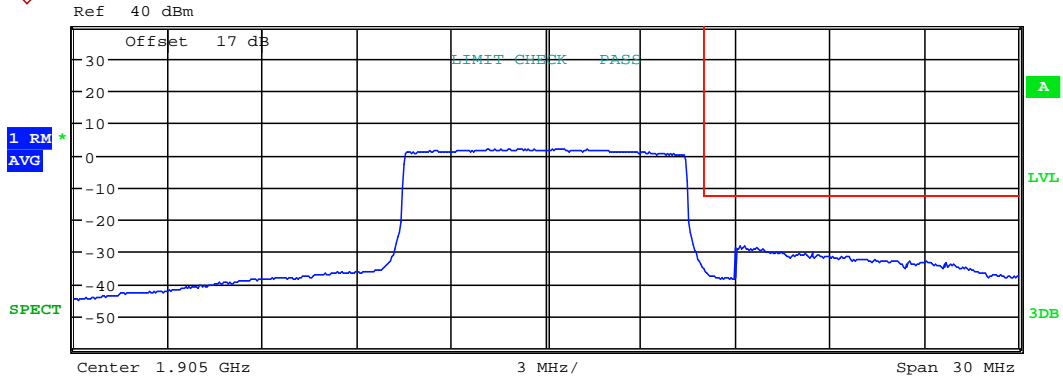

Tx Channel				BW_10_MHz_higher UL		
Bandwidth		10 MHz	Power		20.27 dBm	
Start [Hz]	Stop [Hz]	RBW [Hz]	Freq [Hz]	PwrAbs [dBm]	PwrRel [dBc]	Δ Limit [dB]
-15.000 M	-5.000 M	100.00 k	1.899952 G	-34.03	-54.30	-334.03
5.000 M	6.000 M	100.00 k	1.910000 G	-35.33	-55.60	-22.33
6.000 M	15.000 M	1.00 M	1.911298 G	-28.53	-48.80	-15.53

Date: 5.AUG.2020 21:10:11

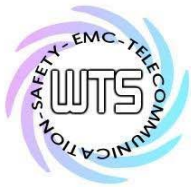

# Worldwide Testing Services(Taiwan) Co., Ltd.

Report Number: W6M22006-20020-P-247

FCC ID: GX9CTC1052QT

15MHz

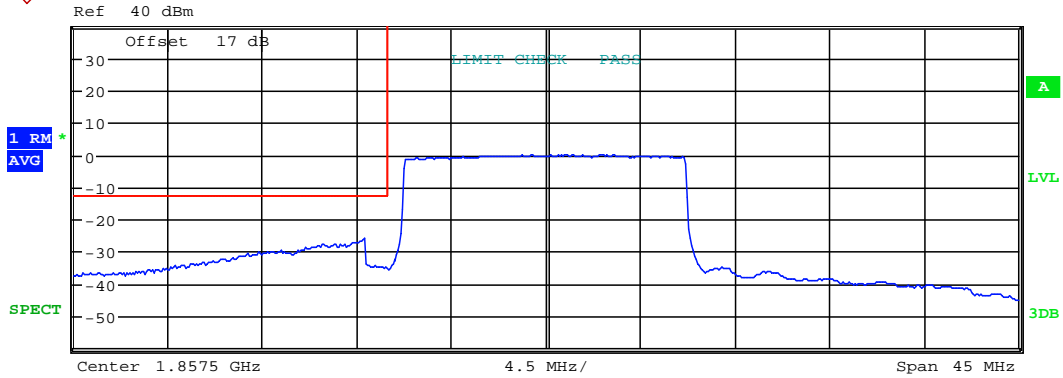

Tx Channel				BW_15_MHz_lower UL		
Bandwidth		15 MHz	Power		20.29 dBm	
Start [Hz]	Stop [Hz]	RBW [Hz]	Freq [Hz]	PwrAbs [dBm]	PwrRel [dBc]	ΔLimit [dB]
-22.500 M	-8.500 M	1.00 M	1.848846 G	-26.34	-46.64	-13.34
-8.500 M	-7.500 M	150.00 k	1.849063 G	-34.38	-54.67	-21.38
7.500 M	22.500 M	100.00 k	1.865865 G	-35.08	-55.37	-335.08

Date: 5.AUG.2020 21:13:42



# Worldwide Testing Services(Taiwan) Co., Ltd.

Report Number: W6M22006-20020-P-247  
 FCC ID: GX9CTC1052QT

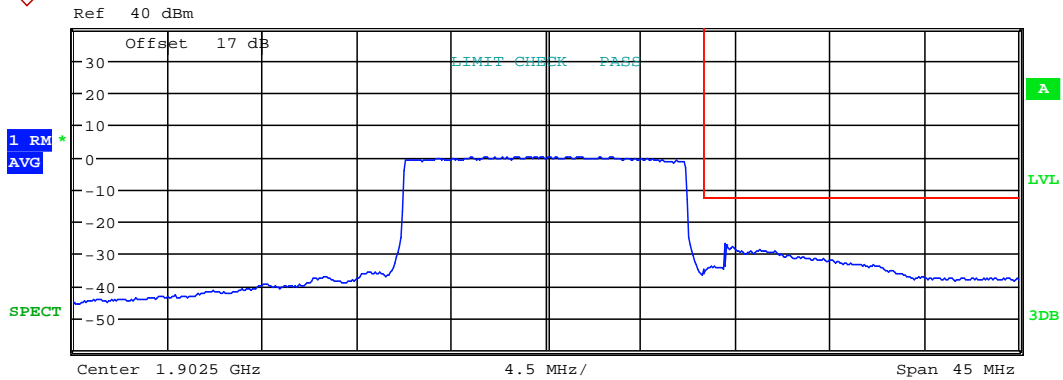

Tx Channel				BW_15_MHz_higher UL		
Bandwidth		15 MHz	Power		20.33 dBm	
Start	Stop	RBW	Freq	PwrAbs	PwrRel	Δ Limit
[Hz]	[Hz]	[Hz]	[Hz]	[dBm]	[dBc]	[dB]
-22.500 M	-7.500 M	100.00 k	1.894063 G	-35.90	-56.23	-335.90
7.500 M	8.500 M	150.00 k	1.910361 G	-34.01	-54.34	-21.01
8.500 M	22.500 M	1.00 M	1.911082 G	-27.48	-47.81	-14.48

Date: 5.AUG.2020 21:14:28



# Worldwide Testing Services(Taiwan) Co., Ltd.

Report Number: W6M22006-20020-P-247

FCC ID: GX9CTC1052QT

20MHz

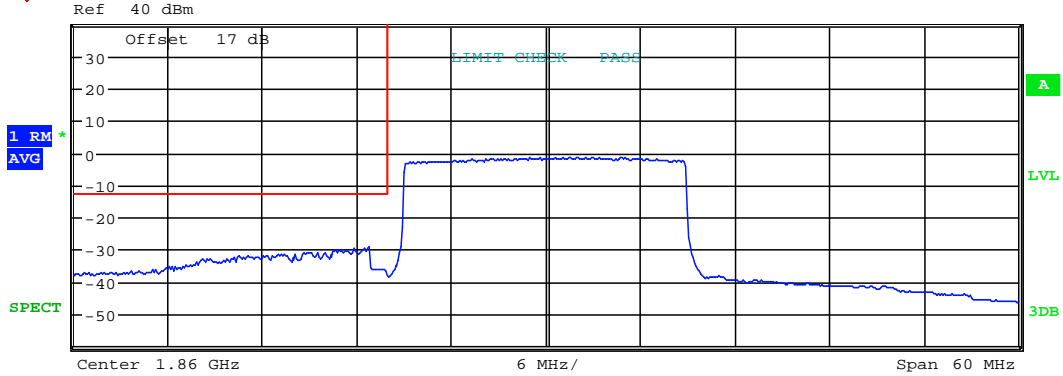

Tx Channel				BW_20_MHz_lower UL		
Bandwidth		20 MHz	Power		19.96 dBm	
Start [Hz]	Stop [Hz]	RBW [Hz]	Freq [Hz]	PwrAbs [dBm]	PwrRel [dBc]	ΔLimit [dB]
-30.000 M	-11.000 M	1.00 M	1.848750 G	-29.52	-49.48	-16.52
-11.000 M	-10.000 M	200.00 k	1.849904 G	-36.02	-55.98	-23.02
10.000 M	30.000 M	100.00 k	1.870962 G	-38.36	-58.31	-338.36

Date: 5.AUG.2020 21:16:23



# Worldwide Testing Services(Taiwan) Co., Ltd.

Report Number: W6M22006-20020-P-247  
 FCC ID: GX9CTC1052QT

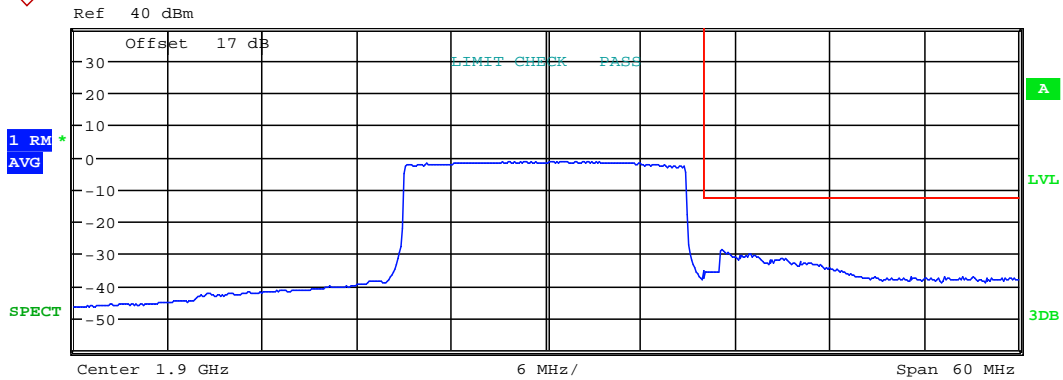

Tx Channel				BW_20_MHz_higher UL		
Bandwidth		20 MHz	Power		20.12 dBm	
Start	Stop	RBW	Freq	PwrAbs	PwrRel	Δ Limit
[Hz]	[Hz]	[Hz]	[Hz]	[dBm]	[dBc]	[dB]
-30.000 M	-10.000 M	100.00 k	1.889423 G	-38.59	-58.71	-338.59
10.000 M	11.000 M	200.00 k	1.910000 G	-35.15	-55.27	-22.15
11.000 M	30.000 M	1.00 M	1.911154 G	-28.82	-48.94	-15.82

Date: 5.AUG.2020 21:17:14



# Worldwide Testing Services(Taiwan) Co., Ltd.

Report Number: W6M22006-20020-P-247  
 FCC ID: GX9CTC1052QT

1RB  
 1.4MHz

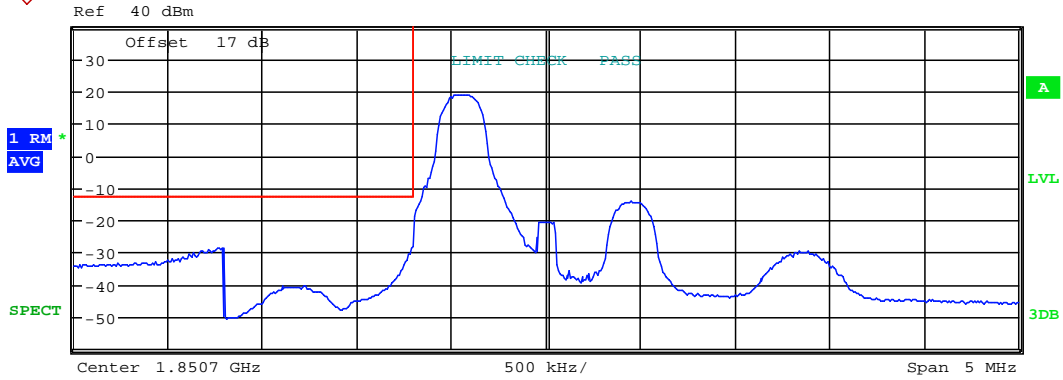

Tx Channel				BW_1_4_MHz_lower UL			
Bandwidth		1.4 MHz		Power		20.91 dBm	
Start [Hz]	Stop [Hz]	RBW [Hz]	Freq [Hz]	PwrAbs [dBm]	PwrRel [dBc]	ΔLimit [dB]	
-2.500 M	-1.700 M	1.00 M	1.848993 G	-28.57	-49.48	-15.57	
-1.700 M	-700.000 k	20.00 k	1.849995 G	-28.20	-49.11	-15.20	
700.000 k	2.500 M	100.00 k	1.852038 G	-29.82	-50.74	-329.82	

Date: 5.AUG.2020 20:36:43





# Worldwide Testing Services(Taiwan) Co., Ltd.

Report Number: W6M22006-20020-P-247  
 FCC ID: GX9CTC1052QT

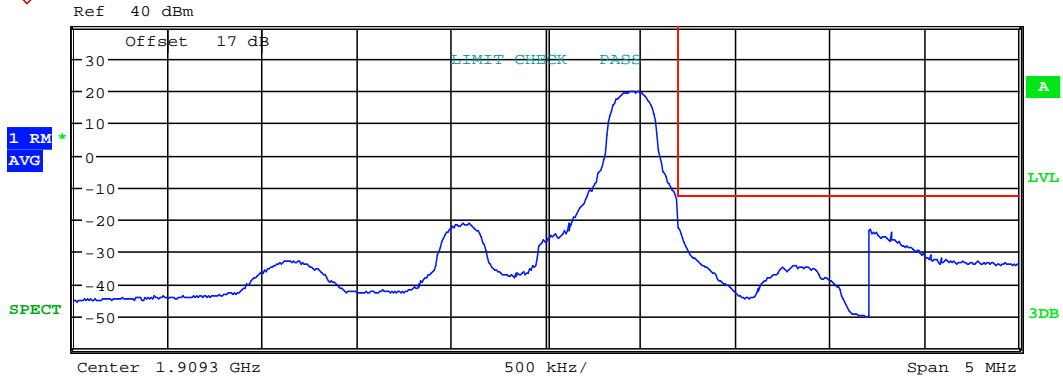

Tx Channel				BW_1_4_MHz_higher UL		
Bandwidth		1.4 MHz	Power		21.69 dBm	
Start	Stop	RBW	Freq	PwrAbs	PwrRel	Δ Limit
[Hz]	[Hz]	[Hz]	[Hz]	[dBm]	[dBc]	[dB]
-2.500 M	-700.000 k	100.00 k	1.907946 G	-32.84	-54.54	-332.84
700.000 k	1.700 M	20.00 k	1.910000 G	-14.08	-35.77	-1.08
1.700 M	2.500 M	1.00 M	1.911015 G	-23.34	-45.03	-10.34

Date: 5.AUG.2020 20:38:37



# Worldwide Testing Services(Taiwan) Co., Ltd.

Report Number: W6M22006-20020-P-247

FCC ID: GX9CTC1052QT

3MHz

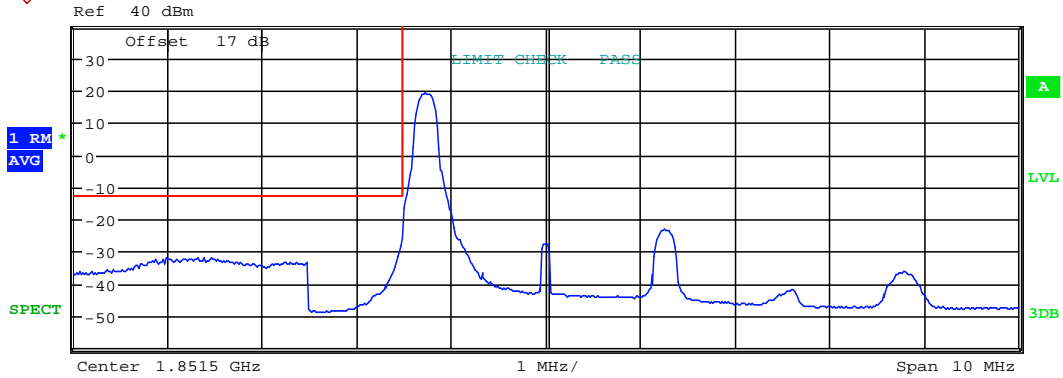

Tx Channel				BW_3_MHz_lower UL		
Bandwidth		3 MHz	Power		21.00 dBm	
Start [Hz]	Stop [Hz]	RBW [Hz]	Freq [Hz]	PwrAbs [dBm]	PwrRel [dBc]	ΔLimit [dB]
-5.000 M	-2.500 M	1.00 M	1.847878 G	-32.07	-53.07	-19.07
-2.500 M	-1.500 M	30.00 k	1.849978 G	-26.14	-47.14	-13.14
1.500 M	5.000 M	100.00 k	1.855282 G	-36.16	-57.16	-336.16

Date: 5.AUG.2020 20:40:10



Report Number: W6M22006-20020-P-247  
 FCC ID: GX9CTC1052QT

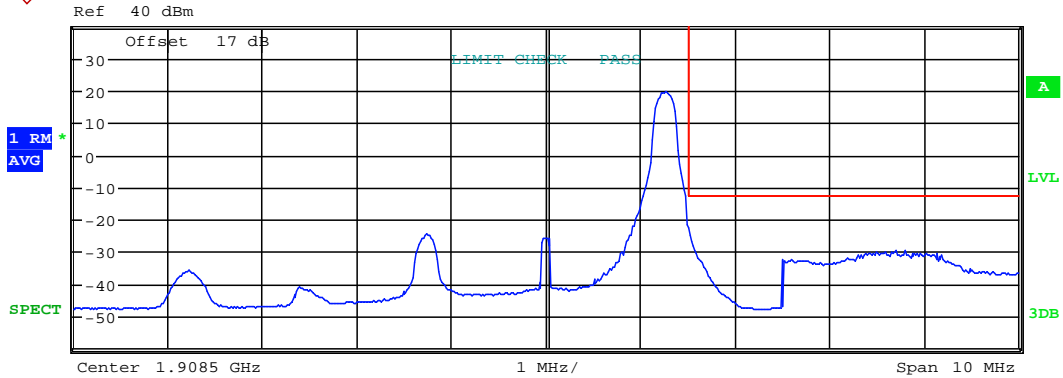

Tx Channel				BW_3_MHz_higher UL		
Bandwidth		3 MHz	Power		21.36 dBm	
Start [Hz]	Stop [Hz]	RBW [Hz]	Freq [Hz]	PwrAbs [dBm]	PwrRel [dBc]	Δ Limit [dB]
-5.000 M	-1.500 M	100.00 k	1.904718 G	-35.98	-57.34	-335.98
1.500 M	2.500 M	30.00 k	1.910006 G	-22.02	-43.38	-9.02
2.500 M	5.000 M	1.00 M	1.912202 G	-29.75	-51.11	-16.75

Date: 5.AUG.2020 20:43:06



# Worldwide Testing Services(Taiwan) Co., Ltd.

Report Number: W6M22006-20020-P-247

FCC ID: GX9CTC1052QT

5MHz

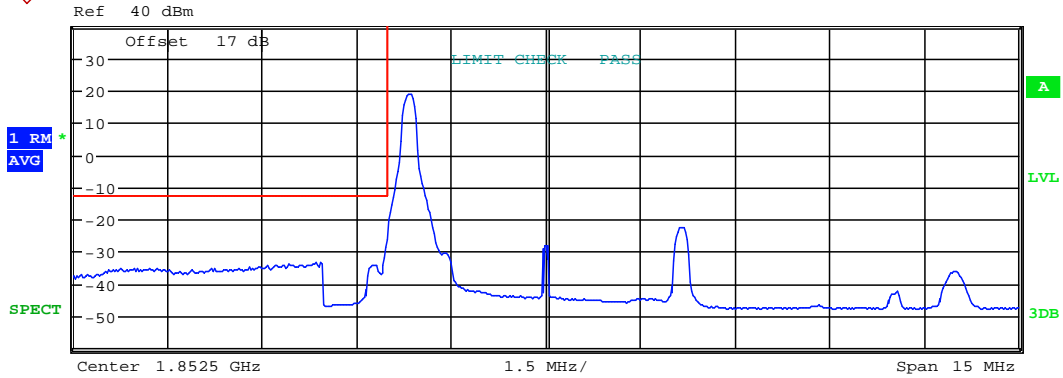

Tx Channel				BW_5_MHz_lower UL		
Bandwidth			5 MHz	Power		
Start	Stop	RBW	Freq	PwrAbs	PwrRel	Δ Limit
[Hz]	[Hz]	[Hz]	[Hz]	[dBm]	[dBc]	[dB]
-7.500 M	-3.500 M	1.00 M	1.848846 G	-33.21	-54.05	-20.21
-3.500 M	-2.500 M	50.00 k	1.849976 G	-26.41	-47.24	-13.41
2.500 M	7.500 M	100.00 k	1.859014 G	-36.08	-56.91	-336.08

Date: 5.AUG.2020 21:06:29



# Worldwide Testing Services(Taiwan) Co., Ltd.

Report Number: W6M22006-20020-P-247  
 FCC ID: GX9CTC1052QT

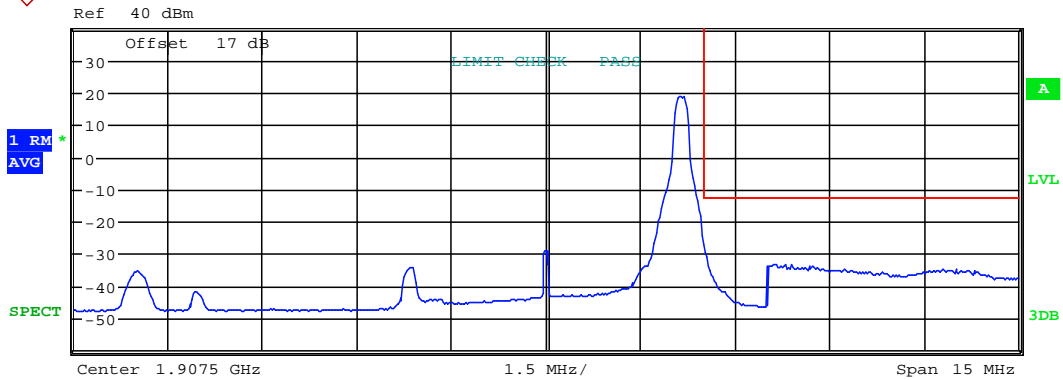

Tx Channel				BW_5_MHz_higher UL		
Bandwidth		5 MHz	Power		21.03 dBm	
Start [Hz]	Stop [Hz]	RBW [Hz]	Freq [Hz]	PwrAbs [dBm]	PwrRel [dBc]	Δ Limit [dB]
-7.500 M	-2.500 M	100.00 k	1.901010 G	-35.50	-56.52	-335.50
2.500 M	3.500 M	50.00 k	1.910000 G	-25.11	-46.14	-12.11
3.500 M	7.500 M	1.00 M	1.911130 G	-33.28	-54.31	-20.28

Date: 5.AUG.2020 21:08:03



# Worldwide Testing Services(Taiwan) Co., Ltd.

Report Number: W6M22006-20020-P-247

FCC ID: GX9CTC1052QT

10MHz

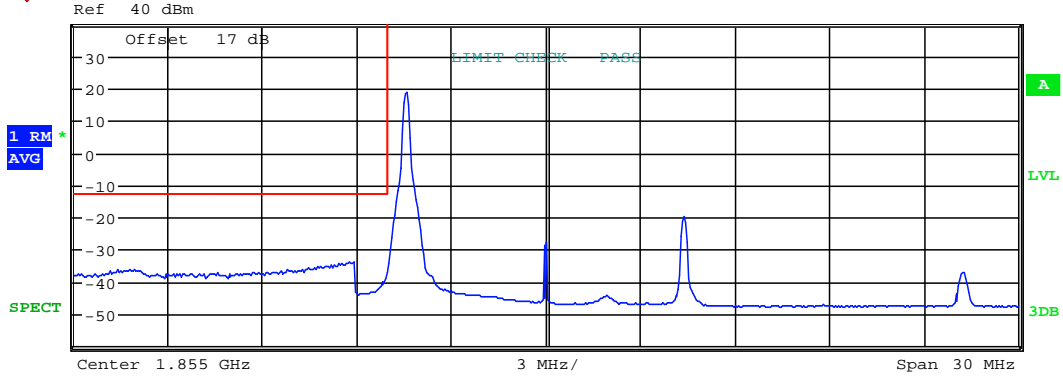

Tx Channel				BW_10_MHz_lower UL		
Bandwidth		10 MHz	Power		21.00 dBm	
Start [Hz]	Stop [Hz]	RBW [Hz]	Freq [Hz]	PwrAbs [dBm]	PwrRel [dBc]	ΔLimit [dB]
-15.000 M	-6.000 M	1.00 M	1.848750 G	-33.85	-54.85	-20.85
-6.000 M	-5.000 M	100.00 k	1.849952 G	-37.25	-58.25	-24.25
5.000 M	15.000 M	100.00 k	1.868221 G	-37.09	-58.09	-337.09

Date: 5.AUG.2020 21:08:59



Report Number: W6M22006-20020-P-247  
 FCC ID: GX9CTC1052QT

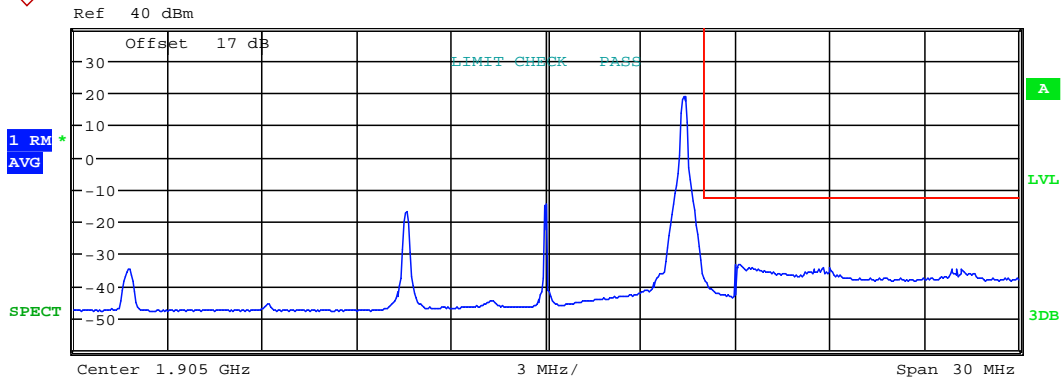

Tx Channel				BW_10_MHz_higher UL		
Bandwidth		10 MHz	Power		21.16 dBm	
Start [Hz]	Stop [Hz]	RBW [Hz]	Freq [Hz]	PwrAbs [dBm]	PwrRel [dBc]	Δ Limit [dB]
-15.000 M	-5.000 M	100.00 k	1.891731 G	-34.90	-56.06	-334.90
5.000 M	6.000 M	100.00 k	1.910000 G	-36.65	-57.81	-23.65
6.000 M	15.000 M	1.00 M	1.911106 G	-33.61	-54.77	-20.61

Date: 5.AUG.2020 21:10:36

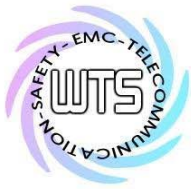

# Worldwide Testing Services(Taiwan) Co., Ltd.

Report Number: W6M22006-20020-P-247

FCC ID: GX9CTC1052QT

15MHz

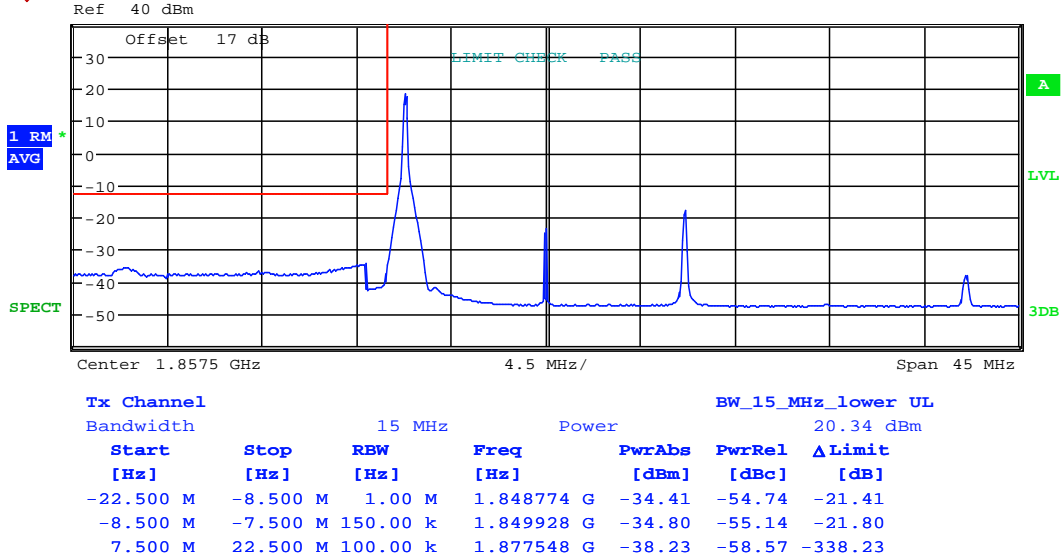

Date: 5.AUG.2020 21:11:56





# Worldwide Testing Services(Taiwan) Co., Ltd.

Report Number: W6M22006-20020-P-247  
 FCC ID: GX9CTC1052QT

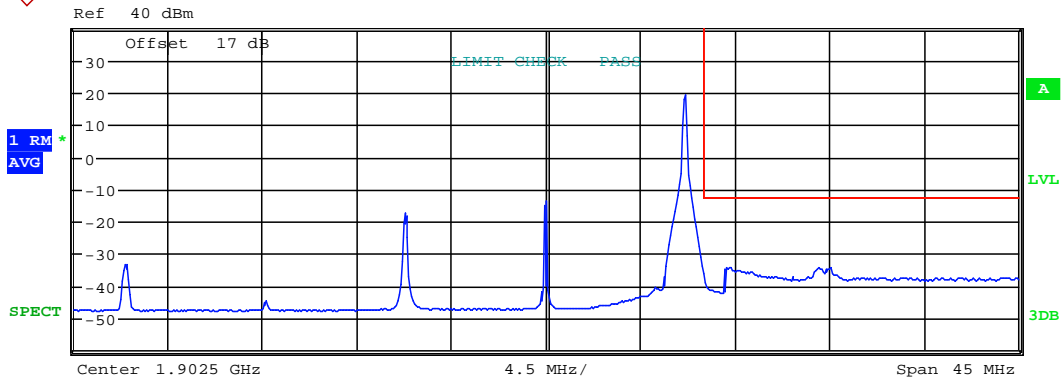

Tx Channel				BW_15_MHz_higher UL		
Bandwidth		15 MHz		Power		
Start	Stop	RBW	Freq	PwrAbs	PwrRel	Δ Limit
[Hz]	[Hz]	[Hz]	[Hz]	[dBm]	[dBc]	[dB]
-22.500 M	-7.500 M	100.00 k	1.882524 G	-33.35	-54.62	-333.35
7.500 M	8.500 M	150.00 k	1.910000 G	-34.20	-55.47	-21.20
8.500 M	22.500 M	1.00 M	1.911226 G	-34.32	-55.59	-21.32

Date: 5.AUG.2020 21:15:02



# Worldwide Testing Services(Taiwan) Co., Ltd.

Report Number: W6M22006-20020-P-247

FCC ID: GX9CTC1052QT

20MHz

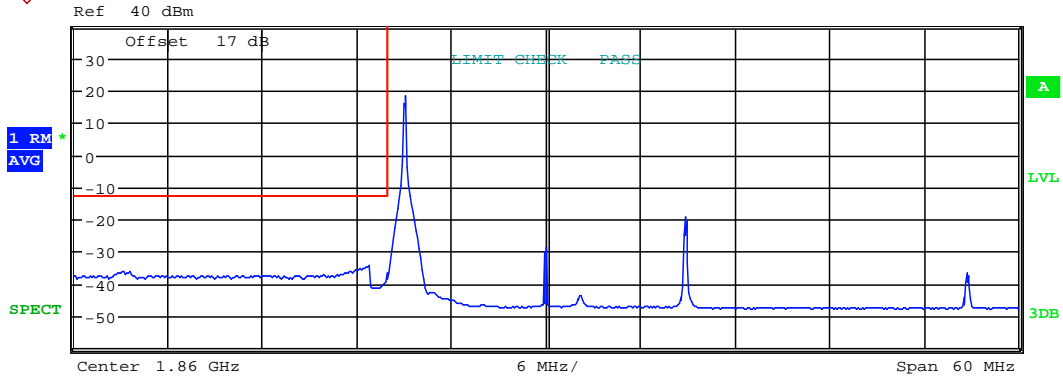

Tx Channel				BW_20_MHz_lower UL		
Bandwidth		20 MHz	Power		20.86 dBm	
Start [Hz]	Stop [Hz]	RBW [Hz]	Freq [Hz]	PwrAbs [dBm]	PwrRel [dBc]	ΔLimit [dB]
-30.000 M	-11.000 M	1.00 M	1.848750 G	-34.42	-55.28	-21.42
-11.000 M	-10.000 M	200.00 k	1.849904 G	-36.87	-57.73	-23.87
10.000 M	30.000 M	100.00 k	1.886731 G	-36.79	-57.66	-336.79

Date: 5.AUG.2020 21:16:01



# Worldwide Testing Services(Taiwan) Co., Ltd.

Report Number: W6M22006-20020-P-247  
 FCC ID: GX9CTC1052QT

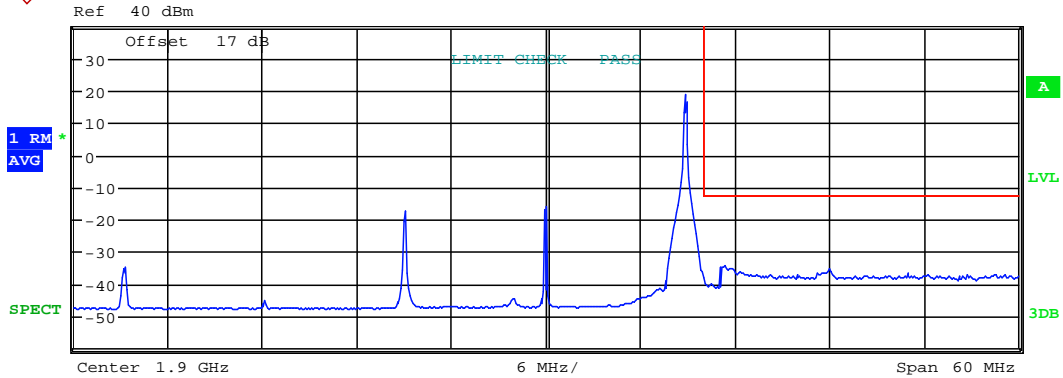

Tx Channel				BW_20_MHz_higher UL		
Bandwidth		20 MHz	Power		21.07 dBm	
Start	Stop	RBW	Freq	PwrAbs	PwrRel	Δ Limit
[Hz]	[Hz]	[Hz]	[Hz]	[dBm]	[dBc]	[dB]
-30.000 M	-10.000 M	100.00 k	1.873269 G	-35.00	-56.07	-335.00
10.000 M	11.000 M	200.00 k	1.910000 G	-36.31	-57.37	-23.31
11.000 M	30.000 M	1.00 M	1.911346 G	-34.51	-55.58	-21.51

Date: 5.AUG.2020 21:17:36



# Worldwide Testing Services(Taiwan) Co., Ltd.

Report Number: W6M22006-20020-P-247  
 FCC ID: GX9CTC1052QT

Band IV  
 16QAM  
 1RB  
 1.4MHz

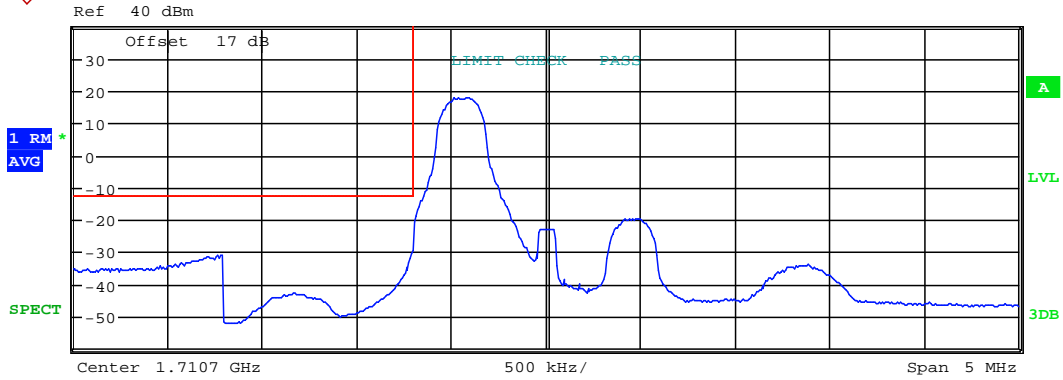

Tx Channel				BW_1_4_MHz_lower UL		
Bandwidth		1.4 MHz		Power		19.87 dBm
Start [Hz]	Stop [Hz]	RBW [Hz]	Freq [Hz]	PwrAbs [dBm]	PwrRel [dBc]	ΔLimit [dB]
-2.500 M	-1.700 M	1.00 M	1.708961 G	-31.35	-51.23	-18.35
-1.700 M	-700.000 k	20.00 k	1.709995 G	-29.64	-49.51	-16.64
700.000 k	2.500 M	100.00 k	1.712086 G	-34.05	-53.93	-334.05

Date: 6.AUG.2020 19:32:43



# Worldwide Testing Services(Taiwan) Co., Ltd.

Report Number: W6M22006-20020-P-247  
 FCC ID: GX9CTC1052QT

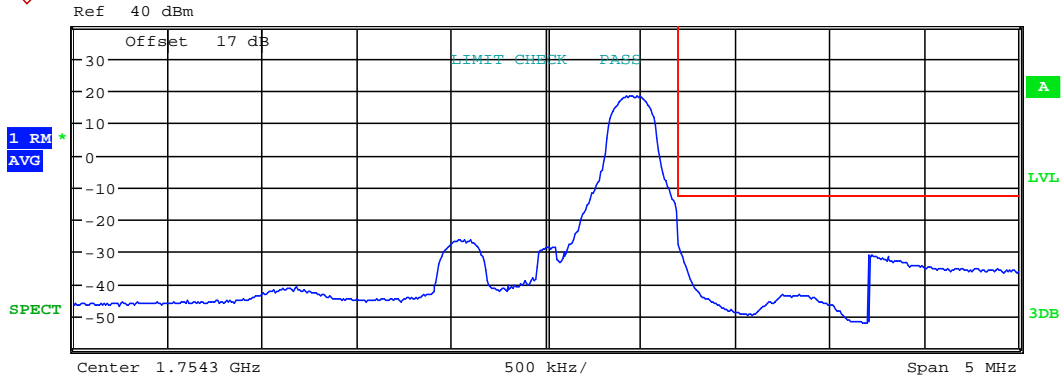

Tx Channel				BW_1_4_MHz_higher UL		
Bandwidth		1.4 MHz	Power		20.25 dBm	
Start	Stop	RBW	Freq	PwrAbs	PwrRel	Δ Limit
[Hz]	[Hz]	[Hz]	[Hz]	[dBm]	[dBc]	[dB]
-2.500 M	-700.000 k	100.00 k	1.752978 G	-40.87	-61.12	-340.87
700.000 k	1.700 M	20.00 k	1.755000 G	-18.02	-38.26	-5.02
1.700 M	2.500 M	1.00 M	1.756007 G	-31.15	-51.40	-18.15

Date: 6.AUG.2020 19:37:21



# Worldwide Testing Services(Taiwan) Co., Ltd.

Report Number: W6M22006-20020-P-247

FCC ID: GX9CTC1052QT

3MHz

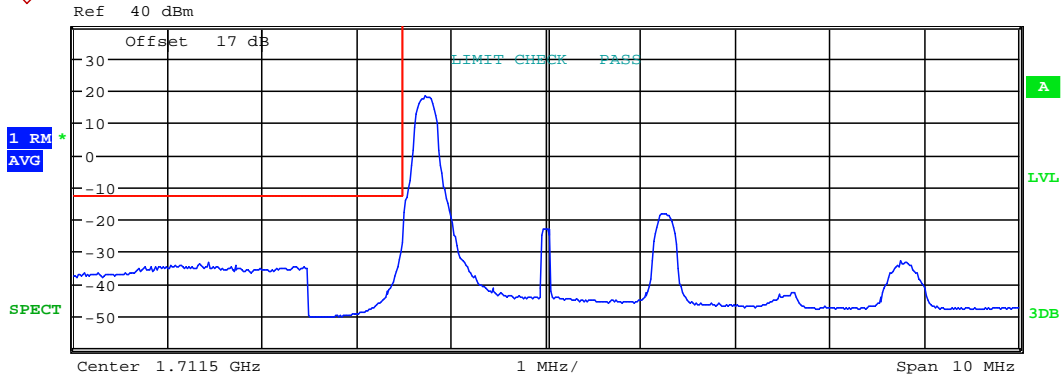

Tx Channel				BW_3_MHz_lower UL		
Bandwidth		3 MHz	Power		20.02 dBm	
Start [Hz]	Stop [Hz]	RBW [Hz]	Freq [Hz]	PwrAbs [dBm]	PwrRel [dBc]	ΔLimit [dB]
-5.000 M	-2.500 M	1.00 M	1.707926 G	-33.99	-54.01	-20.99
-2.500 M	-1.500 M	30.00 k	1.709978 G	-27.24	-47.26	-14.24
1.500 M	5.000 M	100.00 k	1.715250 G	-33.18	-53.20	-333.18

Date: 6.AUG.2020 19:39:43



# Worldwide Testing Services(Taiwan) Co., Ltd.

Report Number: W6M22006-20020-P-247

FCC ID: GX9CTC1052QT

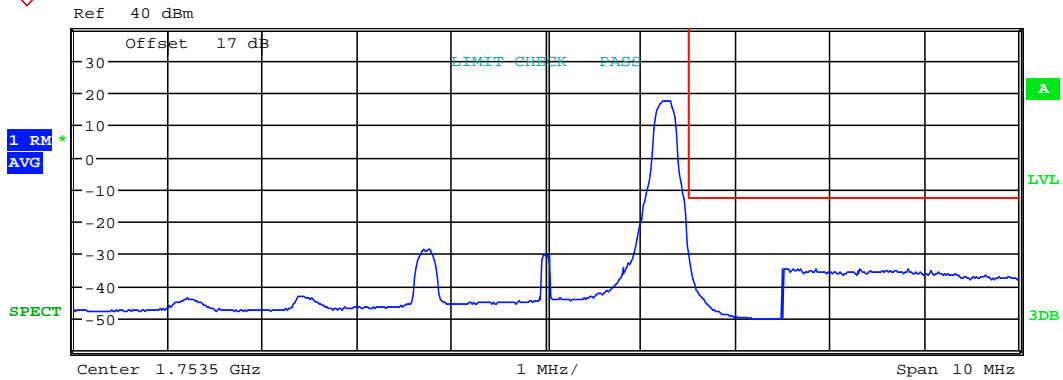

Tx Channel				BW_3_MHz_higher UL		
Bandwidth		3 MHz	Power		19.61 dBm	
Start [Hz]	Stop [Hz]	RBW [Hz]	Freq [Hz]	PwrAbs [dBm]	PwrRel [dBc]	Δ Limit [dB]
-5.000 M	-1.500 M	100.00 k	1.750904 G	-43.19	-62.80	-343.19
1.500 M	2.500 M	30.00 k	1.755006 G	-27.93	-47.53	-14.93
2.500 M	5.000 M	1.00 M	1.756032 G	-34.86	-54.46	-21.86

Date: 6.AUG.2020 19:47:25

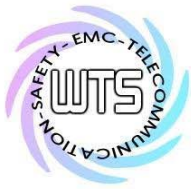

# Worldwide Testing Services(Taiwan) Co., Ltd.

Report Number: W6M22006-20020-P-247

FCC ID: GX9CTC1052QT

5MHz

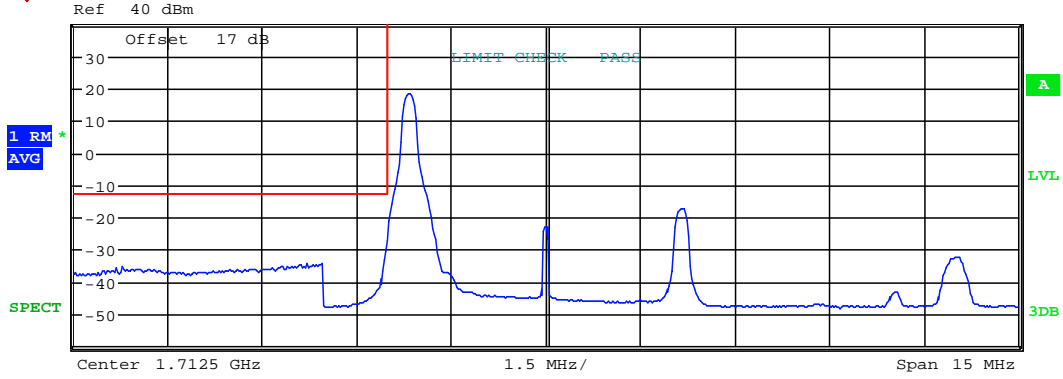

Tx Channel				BW_5_MHz_lower UL		
Bandwidth				Power		
Start	Stop	RBW	Freq	PwrAbs	PwrRel	ΔLimit
[Hz]	[Hz]	[Hz]	[Hz]	[dBm]	[dBc]	[dB]
-7.500 M	-3.500 M	1.00 M	1.708942 G	-34.55	-54.85	-21.55
-3.500 M	-2.500 M	50.00 k	1.709976 G	-27.34	-47.63	-14.34
2.500 M	7.500 M	100.00 k	1.718990 G	-32.30	-52.60	-332.30

Date: 6.AUG.2020 19:49:22





# Worldwide Testing Services(Taiwan) Co., Ltd.

Report Number: W6M22006-20020-P-247  
 FCC ID: GX9CTC1052QT

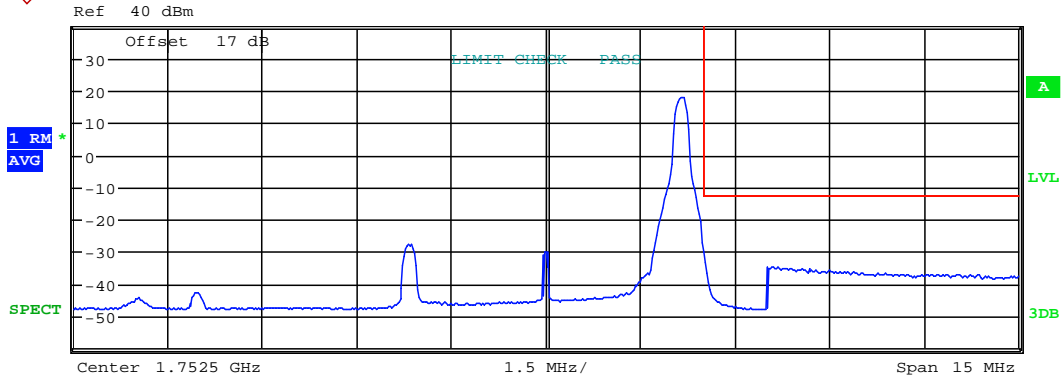

Tx Channel				BW_5_MHz_higher UL		
Bandwidth		5 MHz	Power		19.83 dBm	
Start [Hz]	Stop [Hz]	RBW [Hz]	Freq [Hz]	PwrAbs [dBm]	PwrRel [dBc]	Δ Limit [dB]
-7.500 M	-2.500 M	100.00 k	1.746947 G	-42.86	-62.69	-342.86
2.500 M	3.500 M	50.00 k	1.755000 G	-27.95	-47.78	-14.95
3.500 M	7.500 M	1.00 M	1.756178 G	-34.89	-54.72	-21.89

Date: 6.AUG.2020 19:51:47



# Worldwide Testing Services(Taiwan) Co., Ltd.

Report Number: W6M22006-20020-P-247

FCC ID: GX9CTC1052QT

10MHz

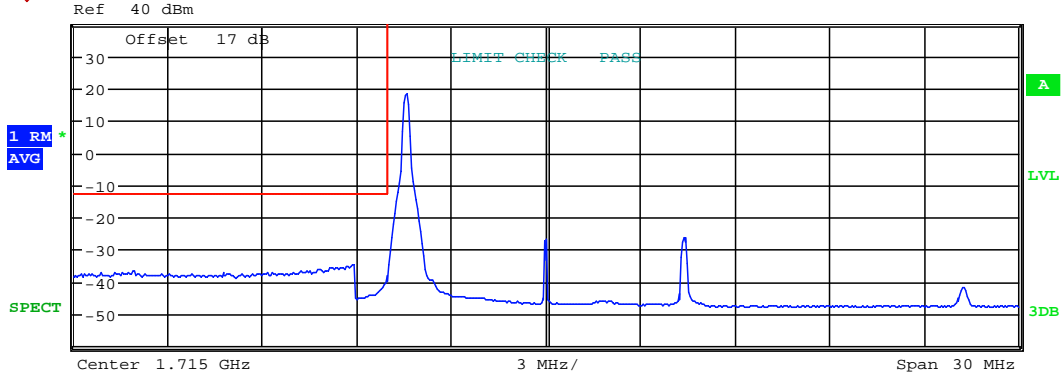

Tx Channel				BW_10_MHz_lower UL		
Bandwidth		10 MHz	Power		20.60 dBm	
Start [Hz]	Stop [Hz]	RBW [Hz]	Freq [Hz]	PwrAbs [dBm]	PwrRel [dBc]	ΔLimit [dB]
-15.000 M	-6.000 M	1.00 M	1.708846 G	-34.91	-55.51	-21.91
-6.000 M	-5.000 M	100.00 k	1.709952 G	-38.15	-58.75	-25.15
5.000 M	15.000 M	100.00 k	1.728269 G	-41.94	-62.54	-341.94

Date: 6.AUG.2020 19:53:45



Report Number: W6M22006-20020-P-247  
 FCC ID: GX9CTC1052QT

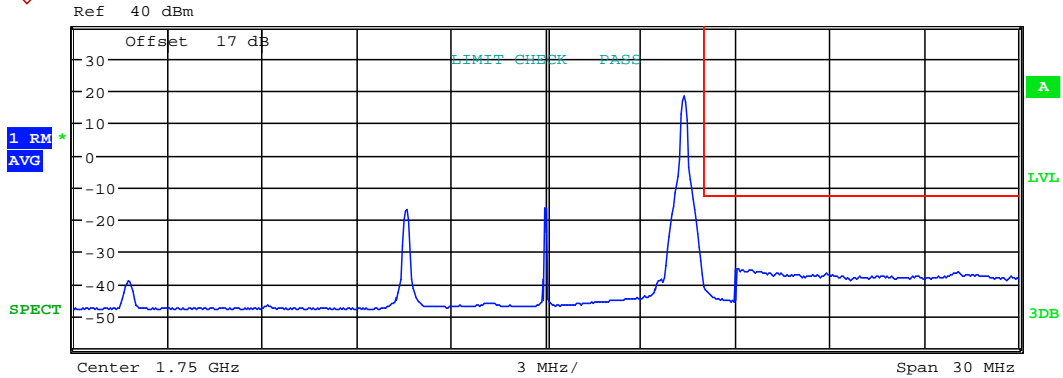

Tx Channel				BW_10_MHz_higher UL		
Bandwidth		10 MHz	Power		20.36 dBm	
Start [Hz]	Stop [Hz]	RBW [Hz]	Freq [Hz]	PwrAbs [dBm]	PwrRel [dBc]	Δ Limit [dB]
-15.000 M	-5.000 M	100.00 k	1.736731 G	-39.25	-59.60	-339.25
5.000 M	6.000 M	100.00 k	1.755000 G	-37.76	-58.11	-24.76
6.000 M	15.000 M	1.00 M	1.756058 G	-35.43	-55.78	-22.43

Date: 6.AUG.2020 19:54:28



# Worldwide Testing Services(Taiwan) Co., Ltd.

Report Number: W6M22006-20020-P-247

FCC ID: GX9CTC1052QT

15MHz

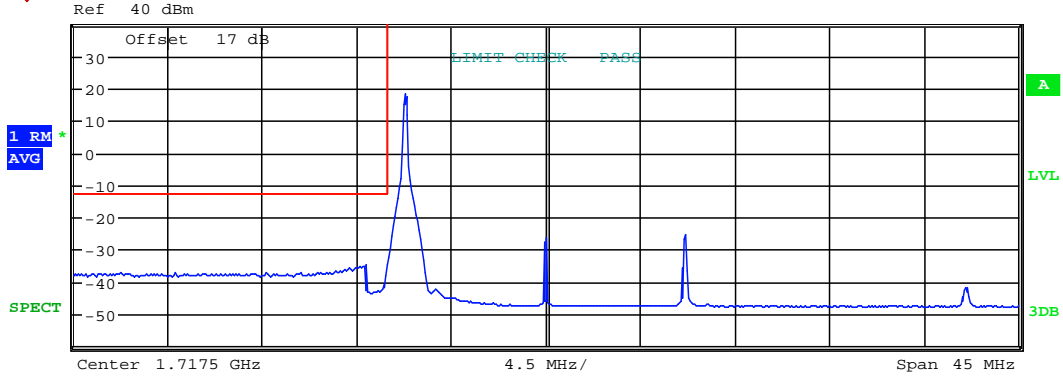

Tx Channel				BW_15_MHz_lower UL		
Bandwidth		15 MHz	Power		20.52 dBm	
Start [Hz]	Stop [Hz]	RBW [Hz]	Freq [Hz]	PwrAbs [dBm]	PwrRel [dBc]	ΔLimit [dB]
-22.500 M	-8.500 M	1.00 M	1.708918 G	-35.05	-55.58	-22.05
-8.500 M	-7.500 M	150.00 k	1.709928 G	-34.78	-55.30	-21.78
7.500 M	22.500 M	100.00 k	1.737476 G	-41.74	-62.26	-341.74

Date: 6.AUG.2020 19:57:49



Report Number: W6M22006-20020-P-247  
 FCC ID: GX9CTC1052QT

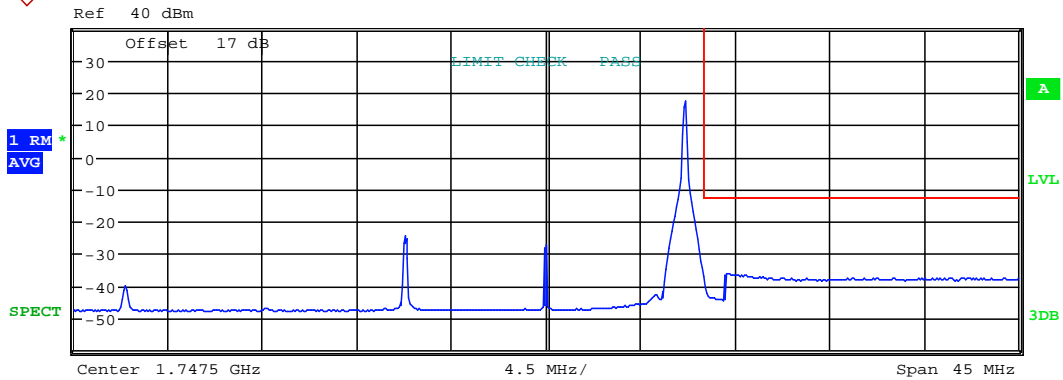

Tx Channel				BW_15_MHz_higher UL		
Bandwidth		15 MHz	Power		19.37 dBm	
Start	Stop	RBW	Freq	PwrAbs	PwrRel	Δ Limit
[Hz]	[Hz]	[Hz]	[Hz]	[dBm]	[dBc]	[dB]
-22.500 M	-7.500 M	100.00 k	1.727452 G	-40.25	-59.62	-340.25
7.500 M	8.500 M	150.00 k	1.755000 G	-34.91	-54.28	-21.91
8.500 M	22.500 M	1.00 M	1.756154 G	-36.15	-55.52	-23.15

Date: 6.AUG.2020 19:59:06





# Worldwide Testing Services(Taiwan) Co., Ltd.

Report Number: W6M22006-20020-P-247

FCC ID: GX9CTC1052QT

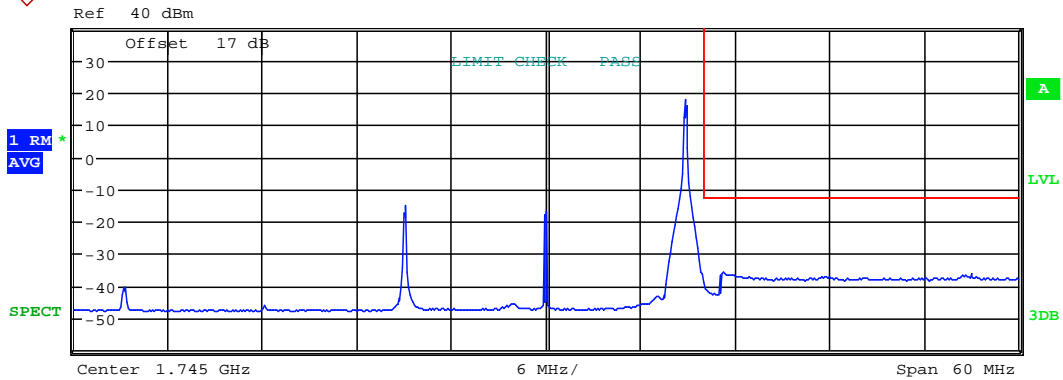

Tx Channel				BW_20_MHz_higher UL		
Bandwidth		20 MHz	Power		20.20 dBm	
Start	Stop	RBW	Freq	PwrAbs	PwrRel	Δ Limit
[Hz]	[Hz]	[Hz]	[Hz]	[dBm]	[dBc]	[dB]
-30.000 M	-10.000 M	100.00 k	1.718269 G	-40.36	-60.55	-340.36
10.000 M	11.000 M	200.00 k	1.755000 G	-36.60	-56.79	-23.60
11.000 M	30.000 M	1.00 M	1.756250 G	-36.01	-56.21	-23.01

Date: 6.AUG.2020 20:04:37



# Worldwide Testing Services(Taiwan) Co., Ltd.

Report Number: W6M22006-20020-P-247

FCC ID: GX9CTC1052QT

QPSK

FRB

1.4MHz

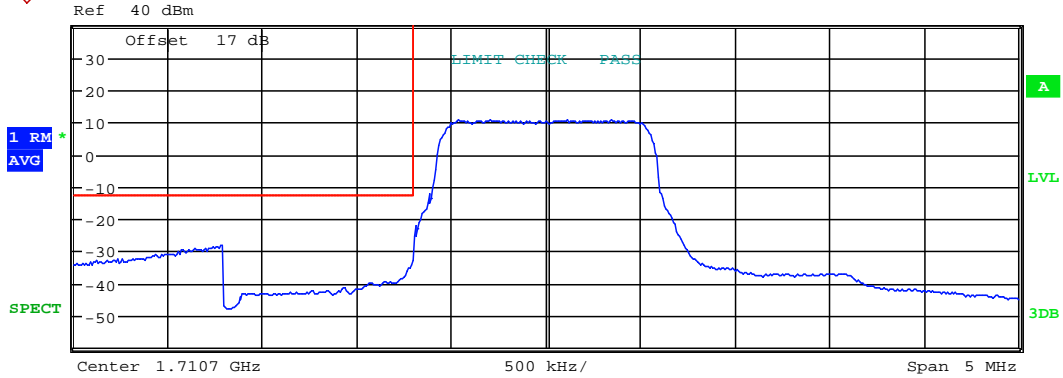

Tx Channel				BW_1_4_MHz_lower UL		
Bandwidth				Power		
Start	Stop	RBW	Freq	PwrAbs	PwrRel	Δ Limit
[Hz]	[Hz]	[Hz]	[Hz]	[dBm]	[dBc]	[dB]
-2.500 M	-1.700 M	1.00 M	1.708977 G	-28.51	-48.61	-15.51
-1.700 M	-700.000 k	20.00 k	1.709995 G	-33.20	-53.30	-20.20
700.000 k	2.500 M	100.00 k	1.711400 G	-24.56	-44.65	-324.56

Date: 6.AUG.2020 19:35:23





# Worldwide Testing Services(Taiwan) Co., Ltd.

Report Number: W6M22006-20020-P-247

FCC ID: GX9CTC1052QT

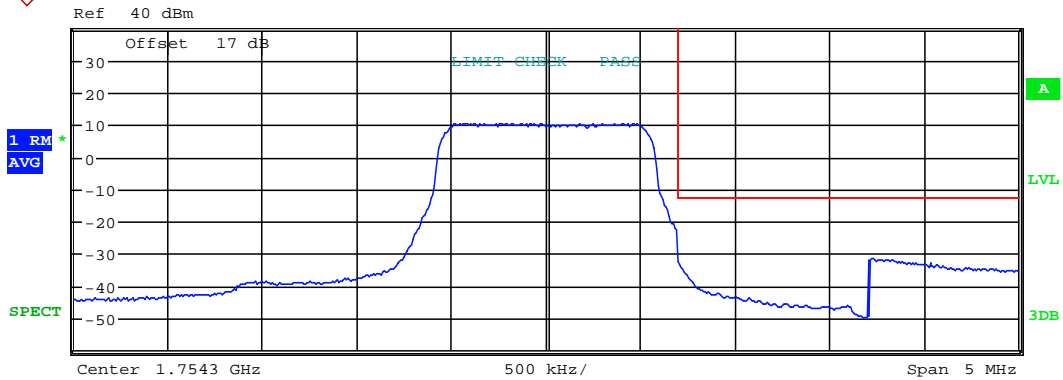

Tx Channel				BW_1_4_MHz_higher UL		
Bandwidth		1.4 MHz	Power		19.90 dBm	
Start	Stop	RBW	Freq	PwrAbs	PwrRel	Δ Limit
[Hz]	[Hz]	[Hz]	[Hz]	[dBm]	[dBc]	[dB]
-2.500 M	-700.000 k	100.00 k	1.753595 G	-25.56	-45.47	-325.56
700.000 k	1.700 M	20.00 k	1.755000 G	-22.75	-42.66	-9.75
1.700 M	2.500 M	1.00 M	1.756031 G	-31.54	-51.45	-18.54

Date: 6.AUG.2020 19:36:15



# Worldwide Testing Services(Taiwan) Co., Ltd.

Report Number: W6M22006-20020-P-247

FCC ID: GX9CTC1052QT

3MHz

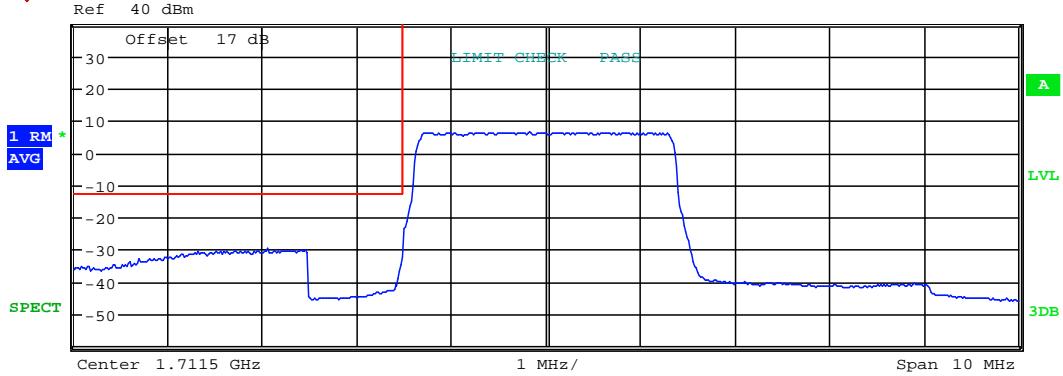

Tx Channel				BW_3_MHz_lower UL		
Bandwidth		3 MHz	Power		19.84 dBm	
Start [Hz]	Stop [Hz]	RBW [Hz]	Freq [Hz]	PwrAbs [dBm]	PwrRel [dBc]	ΔLimit [dB]
-5.000 M	-2.500 M	1.00 M	1.708551 G	-30.06	-49.90	-17.06
-2.500 M	-1.500 M	30.00 k	1.709978 G	-32.59	-52.42	-19.59
1.500 M	5.000 M	100.00 k	1.713006 G	-26.72	-46.56	-326.72

Date: 6.AUG.2020 19:40:11



Report Number: W6M22006-20020-P-247  
 FCC ID: GX9CTC1052QT

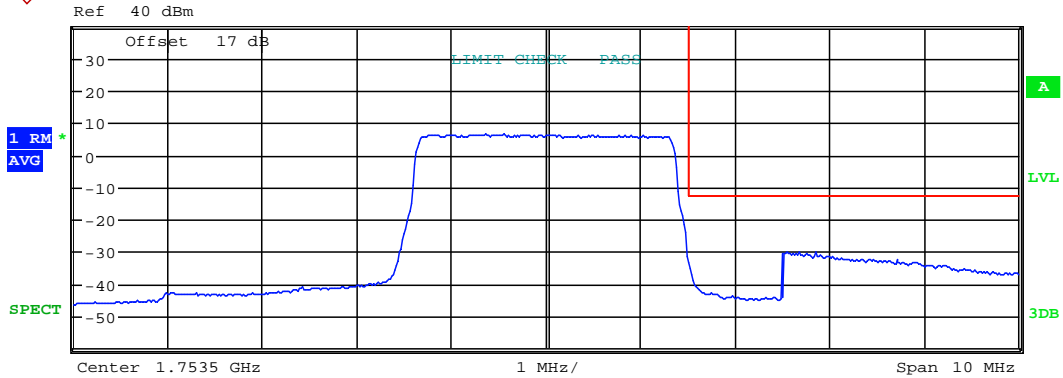

Tx Channel				BW_3_MHz_higher UL		
Bandwidth		3 MHz	Power		19.75 dBm	
Start [Hz]	Stop [Hz]	RBW [Hz]	Freq [Hz]	PwrAbs [dBm]	PwrRel [dBc]	Δ Limit [dB]
-5.000 M	-1.500 M	100.00 k	1.751978 G	-26.44	-46.19	-326.44
1.500 M	2.500 M	30.00 k	1.755006 G	-32.13	-51.88	-19.13
2.500 M	5.000 M	1.00 M	1.756048 G	-30.22	-49.97	-17.22

Date: 6.AUG.2020 19:40:58



# Worldwide Testing Services(Taiwan) Co., Ltd.

Report Number: W6M22006-20020-P-247

FCC ID: GX9CTC1052QT

5MHz

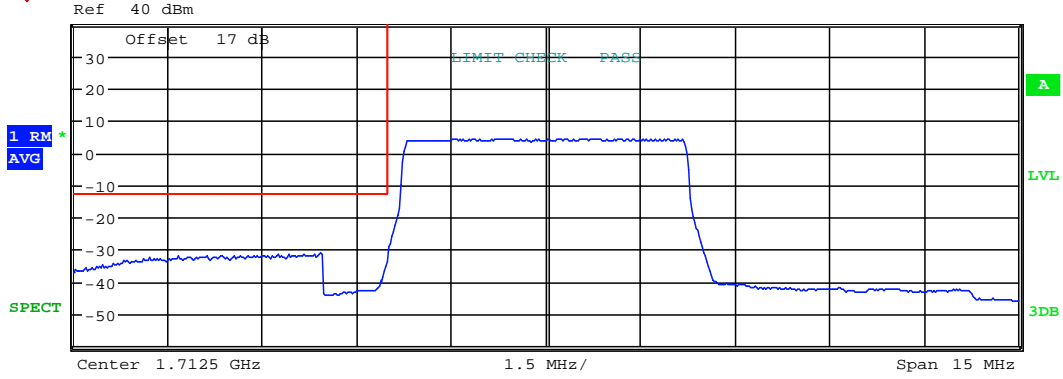

Tx Channel				BW_5_MHz_lower UL		
Bandwidth		5 MHz	Power		20.07 dBm	
Start [Hz]	Stop [Hz]	RBW [Hz]	Freq [Hz]	PwrAbs [dBm]	PwrRel [dBc]	ΔLimit [dB]
-7.500 M	-3.500 M	1.00 M	1.708918 G	-31.27	-51.34	-18.27
-3.500 M	-2.500 M	50.00 k	1.709976 G	-33.81	-53.88	-20.81
2.500 M	7.500 M	100.00 k	1.715000 G	-29.93	-49.99	-329.93

Date: 6.AUG.2020 19:49:55



# Worldwide Testing Services(Taiwan) Co., Ltd.

Report Number: W6M22006-20020-P-247  
 FCC ID: GX9CTC1052QT

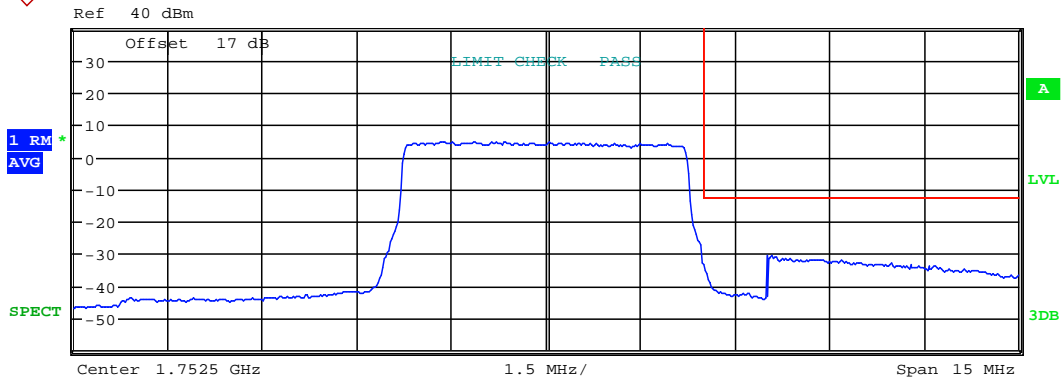

Tx Channel				BW_5_MHz_higher UL		
Bandwidth		5 MHz	Power		20.03 dBm	
Start [Hz]	Stop [Hz]	RBW [Hz]	Freq [Hz]	PwrAbs [dBm]	PwrRel [dBc]	Δ Limit [dB]
-7.500 M	-2.500 M	100.00 k	1.749976 G	-29.86	-49.89	-329.86
2.500 M	3.500 M	50.00 k	1.755000 G	-33.27	-53.30	-20.27
3.500 M	7.500 M	1.00 M	1.756082 G	-30.83	-50.86	-17.83

Date: 6.AUG.2020 19:50:55



# Worldwide Testing Services(Taiwan) Co., Ltd.

Report Number: W6M22006-20020-P-247

FCC ID: GX9CTC1052QT

10MHz

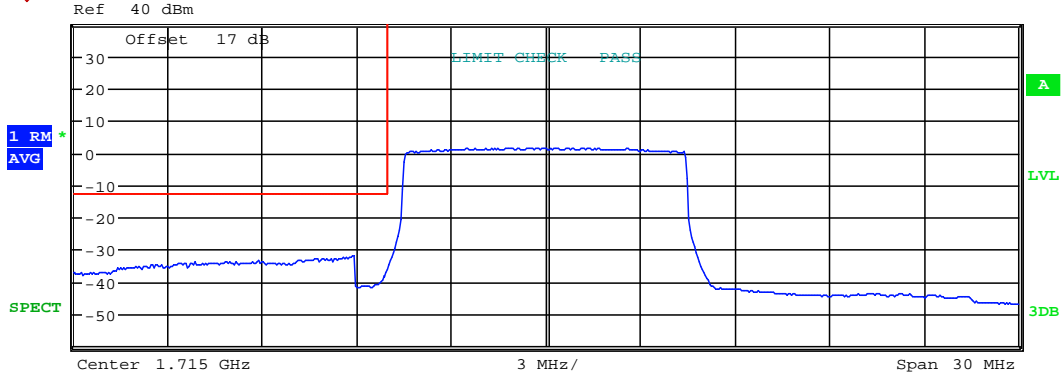

Tx Channel				BW_10_MHz_lower UL		
Bandwidth				Power		
Start	Stop	RBW	Freq	PwrAbs	PwrRel	ΔLimit
[Hz]	[Hz]	[Hz]	[Hz]	[dBm]	[dBc]	[dB]
-15.000 M	-6.000 M	1.00 M	1.708846 G	-32.09	-52.15	-19.09
-6.000 M	-5.000 M	100.00 k	1.709952 G	-36.10	-56.16	-23.10
5.000 M	15.000 M	100.00 k	1.720000 G	-36.84	-56.90	-336.84

Date: 6.AUG.2020 19:53:02



# Worldwide Testing Services(Taiwan) Co., Ltd.

Report Number: W6M22006-20020-P-247

FCC ID: GX9CTC1052QT

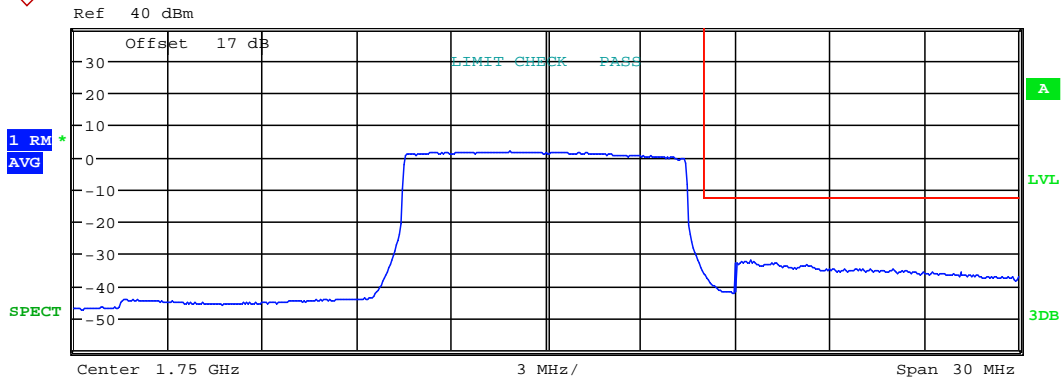

Tx Channel				BW_10_MHz_higher UL		
Bandwidth		10 MHz	Power		20.08 dBm	
Start	Stop	RBW	Freq	PwrAbs	PwrRel	Δ Limit
[Hz]	[Hz]	[Hz]	[Hz]	[dBm]	[dBc]	[dB]
-15.000 M	-5.000 M	100.00 k	1.744952 G	-35.71	-55.79	-335.71
5.000 M	6.000 M	100.00 k	1.755000 G	-35.90	-55.98	-22.90
6.000 M	15.000 M	1.00 M	1.756490 G	-32.28	-52.36	-19.28

Date: 6.AUG.2020 19:55:23

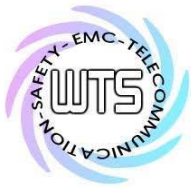

# Worldwide Testing Services(Taiwan) Co., Ltd.

Report Number: W6M22006-20020-P-247

FCC ID: GX9CTC1052QT

15MHz

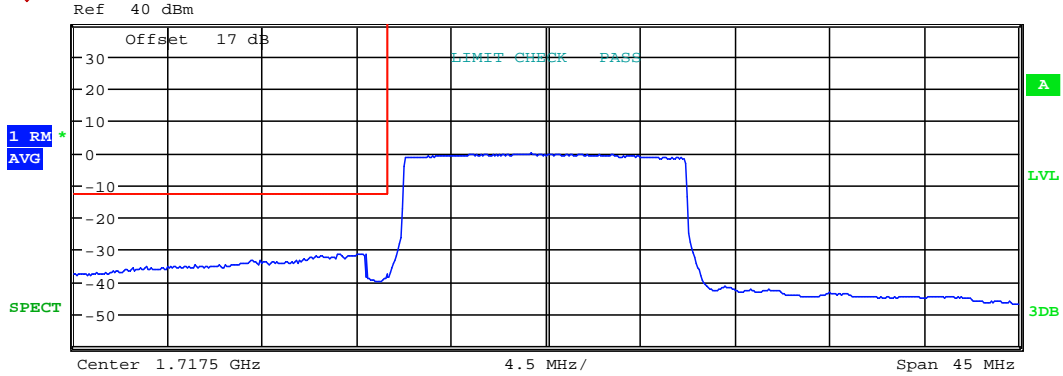

Tx Channel				BW_15_MHz_lower UL		
Bandwidth		15 MHz	Power		19.93 dBm	
Start [Hz]	Stop [Hz]	RBW [Hz]	Freq [Hz]	PwrAbs [dBm]	PwrRel [dBc]	ΔLimit [dB]
-22.500 M	-8.500 M	1.00 M	1.708918 G	-31.52	-51.44	-18.52
-8.500 M	-7.500 M	150.00 k	1.709928 G	-37.96	-57.89	-24.96
7.500 M	22.500 M	100.00 k	1.725000 G	-40.05	-59.97	-340.05

Date: 6.AUG.2020 19:56:51





# Worldwide Testing Services(Taiwan) Co., Ltd.

Report Number: W6M22006-20020-P-247  
 FCC ID: GX9CTC1052QT

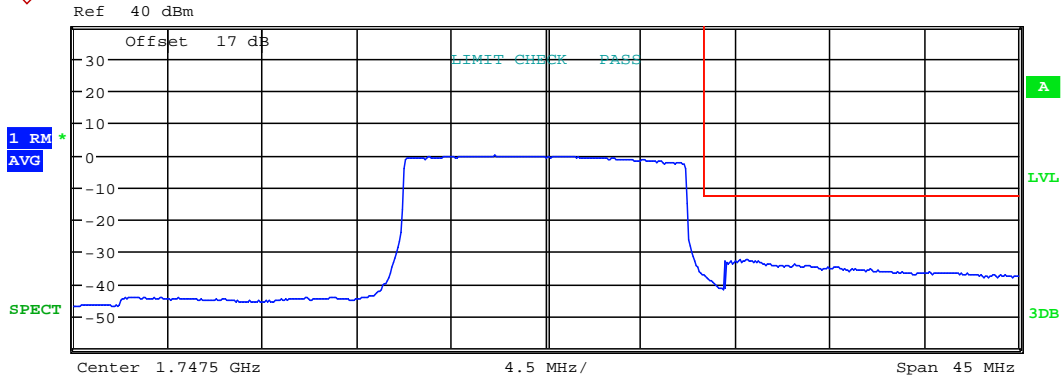

Tx Channel				BW_15_MHz_higher UL		
Bandwidth		15 MHz	Power		19.94 dBm	
Start [Hz]	Stop [Hz]	RBW [Hz]	Freq [Hz]	PwrAbs [dBm]	PwrRel [dBc]	Δ Limit [dB]
-22.500 M	-7.500 M	100.00 k	1.739928 G	-39.16	-59.10	-339.16
7.500 M	8.500 M	150.00 k	1.755000 G	-36.72	-56.66	-23.72
8.500 M	22.500 M	1.00 M	1.757091 G	-32.38	-52.32	-19.38

Date: 6.AUG.2020 20:00:37



# Worldwide Testing Services(Taiwan) Co., Ltd.

Report Number: W6M22006-20020-P-247

FCC ID: GX9CTC1052QT

20MHz

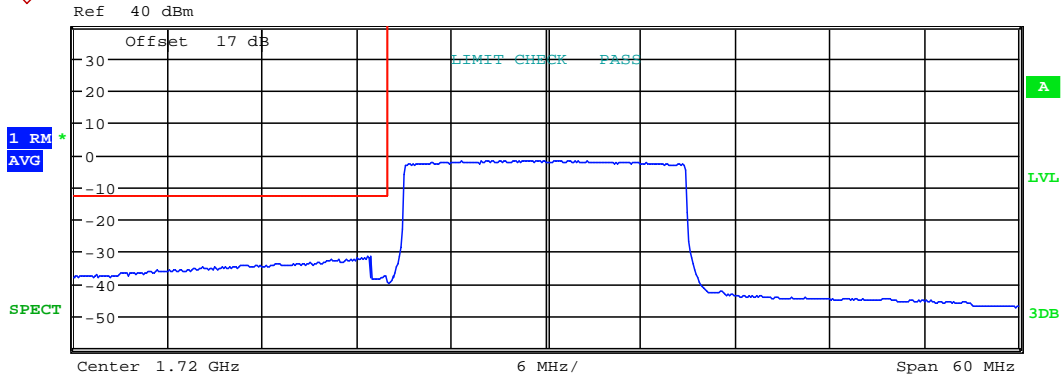

Tx Channel				BW_20_MHz_lower UL		
Bandwidth				Power		
Start	Stop	RBW	Freq	PwrAbs	PwrRel	ΔLimit
[Hz]	[Hz]	[Hz]	[Hz]	[dBm]	[dBc]	[dB]
-30.000 M	-11.000 M	1.00 M	1.708846 G	-31.61	-51.34	-18.61
-11.000 M	-10.000 M	200.00 k	1.709904 G	-37.48	-57.21	-24.48
10.000 M	30.000 M	100.00 k	1.730000 G	-41.52	-61.25	-341.52

Date: 6.AUG.2020 20:02:35



# Worldwide Testing Services(Taiwan) Co., Ltd.

Report Number: W6M22006-20020-P-247  
 FCC ID: GX9CTC1052QT

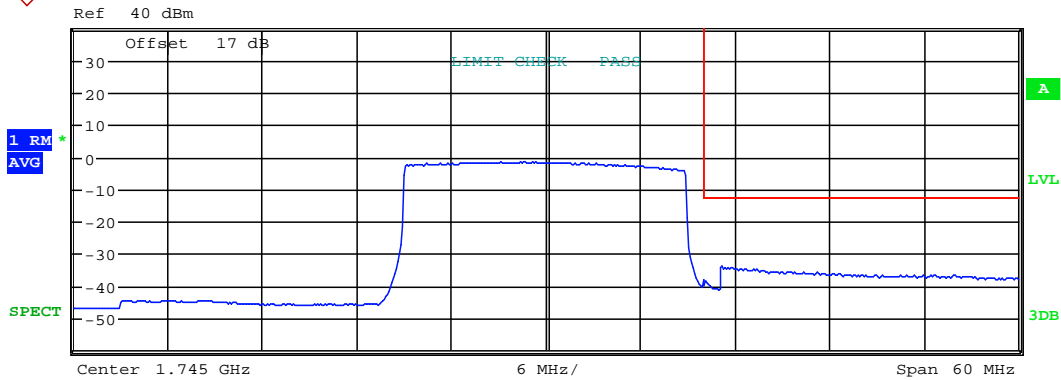

Tx Channel				BW_20_MHz_higher UL		
Bandwidth	20 MHz		Power	19.81 dBm		
Start [Hz]	Stop [Hz]	RBW [Hz]	Freq [Hz]	PwrAbs [dBm]	PwrRel [dBc]	Δ Limit [dB]
-30.000 M	-10.000 M	100.00 k	1.734904 G	-42.65	-62.46	-342.65
10.000 M	11.000 M	200.00 k	1.755000 G	-38.01	-57.81	-25.01
11.000 M	30.000 M	1.00 M	1.756154 G	-33.90	-53.71	-20.90

Date: 6.AUG.2020 20:05:32



# Worldwide Testing Services(Taiwan) Co., Ltd.

Report Number: W6M22006-20020-P-247

FCC ID: GX9CTC1052QT

1RB

1.4MHz

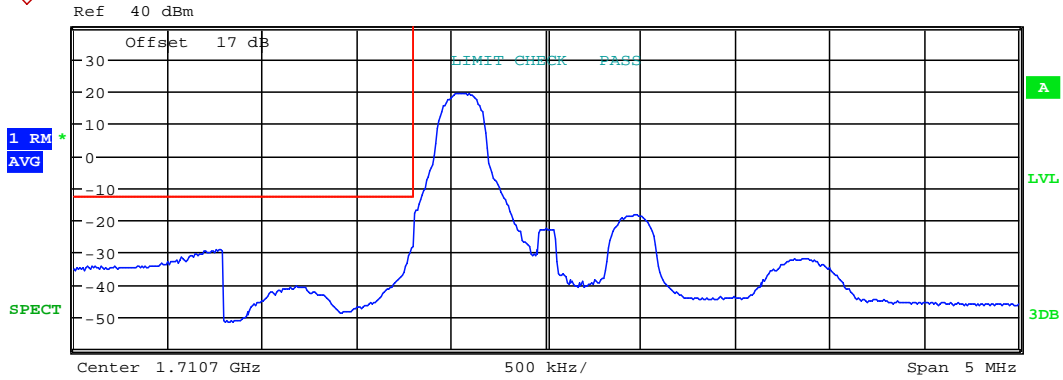

Tx Channel				BW_1_4_MHz_lower UL			
Bandwidth		1.4 MHz		Power		21.27 dBm	
Start [Hz]	Stop [Hz]	RBW [Hz]	Freq [Hz]	PwrAbs [dBm]	PwrRel [dBc]	ΔLimit [dB]	
-2.500 M	-1.700 M	1.00 M	1.708977 G	-29.03	-50.30	-16.03	
-1.700 M	-700.000 k	20.00 k	1.709995 G	-28.16	-49.43	-15.16	
700.000 k	2.500 M	100.00 k	1.712054 G	-31.83	-53.10	-331.83	

Date: 6.AUG.2020 19:34:48



# Worldwide Testing Services(Taiwan) Co., Ltd.

Report Number: W6M22006-20020-P-247  
 FCC ID: GX9CTC1052QT

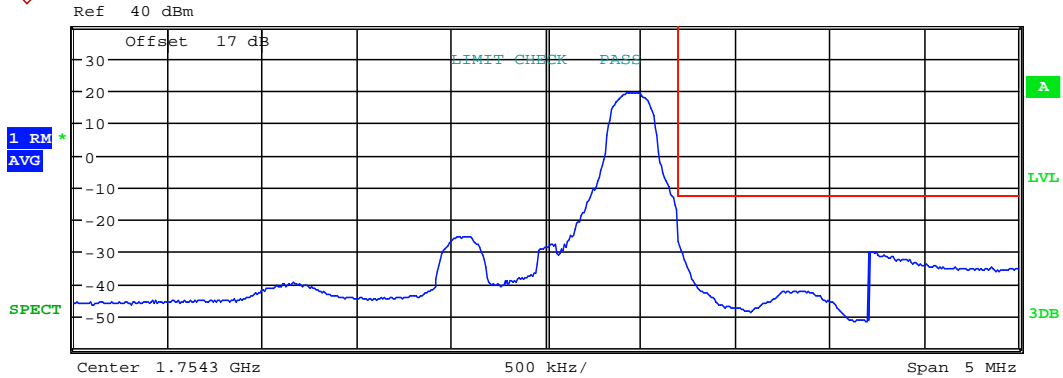

Tx Channel				BW_1_4_MHz_higher UL		
Bandwidth		1.4 MHz	Power		21.23 dBm	
Start	Stop	RBW	Freq	PwrAbs	PwrRel	Δ Limit
[Hz]	[Hz]	[Hz]	[Hz]	[dBm]	[dBc]	[dB]
-2.500 M	-700.000 k	100.00 k	1.752962 G	-39.81	-61.04	-339.81
700.000 k	1.700 M	20.00 k	1.755000 G	-17.29	-38.52	-4.29
1.700 M	2.500 M	1.00 M	1.756023 G	-30.22	-51.45	-17.22

Date: 6.AUG.2020 19:36:45



# Worldwide Testing Services(Taiwan) Co., Ltd.

Report Number: W6M22006-20020-P-247

FCC ID: GX9CTC1052QT

3MHz

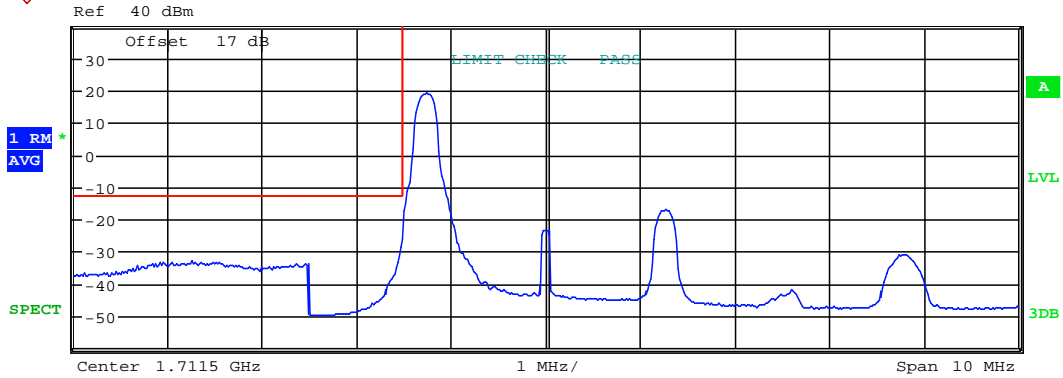

Tx Channel				BW_3_MHz_lower UL		
Bandwidth		3 MHz	Power		21.05 dBm	
Start [Hz]	Stop [Hz]	RBW [Hz]	Freq [Hz]	PwrAbs [dBm]	PwrRel [dBc]	ΔLimit [dB]
-5.000 M	-2.500 M	1.00 M	1.707750 G	-33.15	-54.20	-20.15
-2.500 M	-1.500 M	30.00 k	1.709978 G	-26.61	-47.66	-13.61
1.500 M	5.000 M	100.00 k	1.715282 G	-31.10	-52.15	-331.10

Date: 6.AUG.2020 19:39:21



# Worldwide Testing Services(Taiwan) Co., Ltd.

Report Number: W6M22006-20020-P-247  
 FCC ID: GX9CTC1052QT

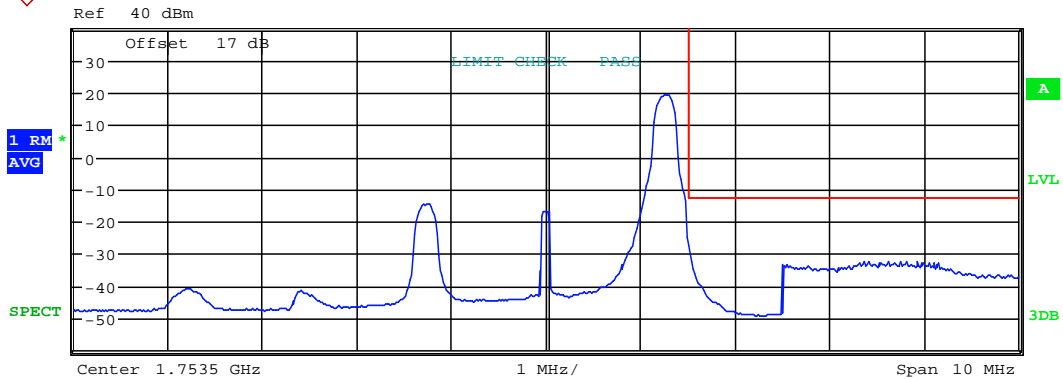

Tx Channel				BW_3_MHz_higher UL		
Bandwidth		3 MHz	Power		21.25 dBm	
Start [Hz]	Stop [Hz]	RBW [Hz]	Freq [Hz]	PwrAbs [dBm]	PwrRel [dBc]	Δ Limit [dB]
-5.000 M	-1.500 M	100.00 k	1.749702 G	-41.01	-62.26	-341.01
1.500 M	2.500 M	30.00 k	1.755006 G	-25.27	-46.53	-12.27
2.500 M	5.000 M	1.00 M	1.756913 G	-32.40	-53.65	-19.40

Date: 6.AUG.2020 19:41:20



# Worldwide Testing Services(Taiwan) Co., Ltd.

Report Number: W6M22006-20020-P-247

FCC ID: GX9CTC1052QT

5MHz

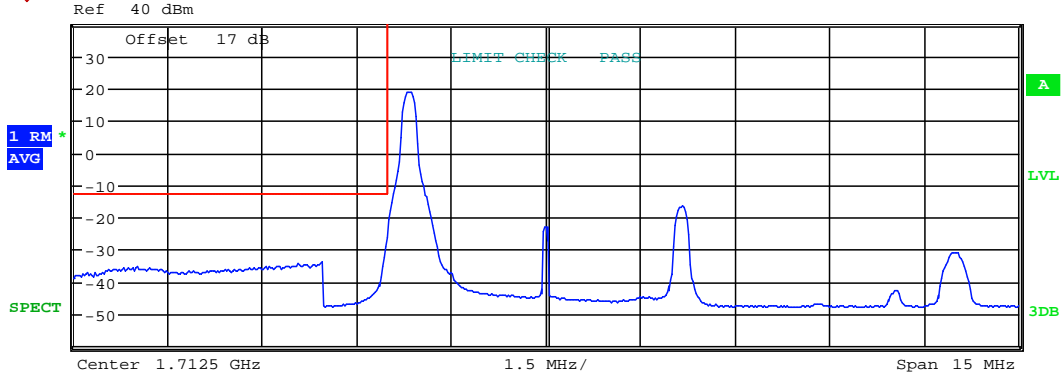

Tx Channel				BW_5_MHz_lower UL		
Bandwidth		5 MHz	Power		20.98 dBm	
Start [Hz]	Stop [Hz]	RBW [Hz]	Freq [Hz]	PwrAbs [dBm]	PwrRel [dBc]	ΔLimit [dB]
-7.500 M	-3.500 M	1.00 M	1.708966 G	-34.33	-55.31	-21.33
-3.500 M	-2.500 M	50.00 k	1.709976 G	-26.26	-47.24	-13.26
2.500 M	7.500 M	100.00 k	1.719014 G	-30.96	-51.94	-330.96

Date: 6.AUG.2020 19:49:01





Report Number: W6M22006-20020-P-247  
 FCC ID: GX9CTC1052QT

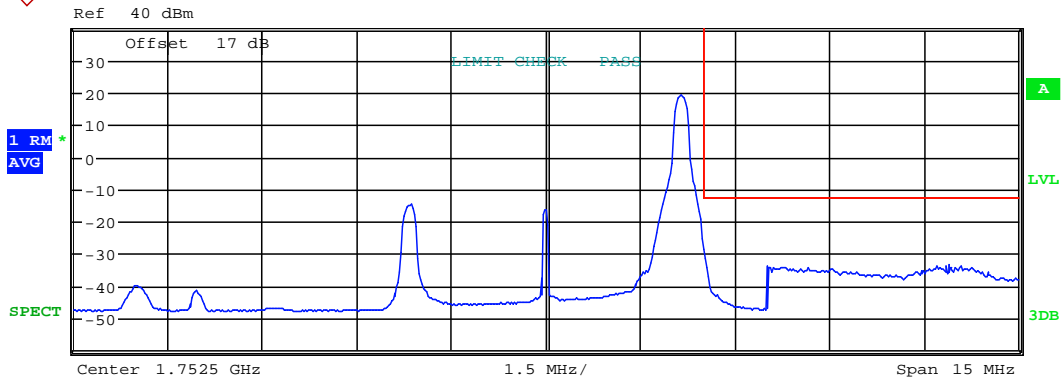

Tx Channel				BW_5_MHz_higher UL		
Bandwidth		5 MHz	Power		21.22 dBm	
Start [Hz]	Stop [Hz]	RBW [Hz]	Freq [Hz]	PwrAbs [dBm]	PwrRel [dBc]	Δ Limit [dB]
-7.500 M	-2.500 M	100.00 k	1.745986 G	-40.09	-61.31	-340.09
2.500 M	3.500 M	50.00 k	1.755000 G	-26.02	-47.24	-13.02
3.500 M	7.500 M	1.00 M	1.758894 G	-33.61	-54.83	-20.61

Date: 6.AUG.2020 19:51:23

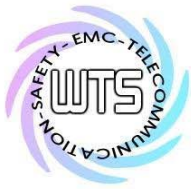

# Worldwide Testing Services(Taiwan) Co., Ltd.

Report Number: W6M22006-20020-P-247

FCC ID: GX9CTC1052QT

10MHz

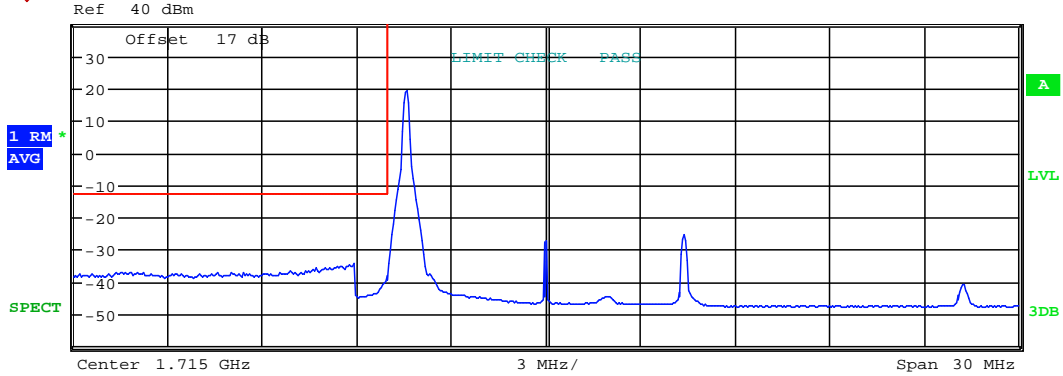

Tx Channel				BW_10_MHz_lower UL		
Bandwidth				Power		
Start	Stop	RBW	Freq	PwrAbs	PwrRel	ΔLimit
[Hz]	[Hz]	[Hz]	[Hz]	[dBm]	[dBc]	[dB]
-15.000 M	-6.000 M	1.00 M	1.708894 G	-34.59	-55.76	-21.59
-6.000 M	-5.000 M	100.00 k	1.709952 G	-38.00	-59.16	-25.00
5.000 M	15.000 M	100.00 k	1.728221 G	-41.07	-62.23	-341.07

Date: 6.AUG.2020 19:53:24



Report Number: W6M22006-20020-P-247  
 FCC ID: GX9CTC1052QT

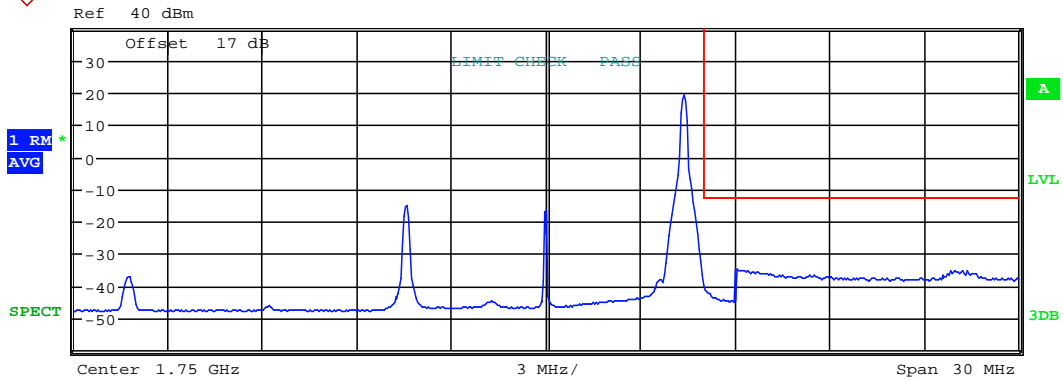

Tx Channel				BW_10_MHz_higher UL		
Bandwidth		10 MHz	Power		21.24 dBm	
Start [Hz]	Stop [Hz]	RBW [Hz]	Freq [Hz]	PwrAbs [dBm]	PwrRel [dBc]	Δ Limit [dB]
-15.000 M	-5.000 M	100.00 k	1.736731 G	-37.18	-58.43	-337.18
5.000 M	6.000 M	100.00 k	1.755000 G	-37.18	-58.42	-24.18
6.000 M	15.000 M	1.00 M	1.756058 G	-34.92	-56.16	-21.92

Date: 6.AUG.2020 19:54:48



# Worldwide Testing Services(Taiwan) Co., Ltd.

Report Number: W6M22006-20020-P-247

FCC ID: GX9CTC1052QT

15MHz

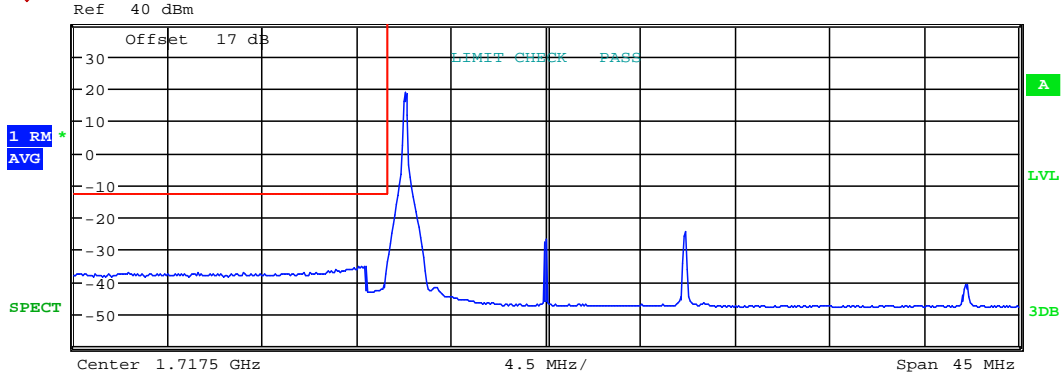

Tx Channel				BW_15_MHz_lower UL		
Bandwidth		15 MHz	Power		21.15 dBm	
Start [Hz]	Stop [Hz]	RBW [Hz]	Freq [Hz]	PwrAbs [dBm]	PwrRel [dBc]	ΔLimit [dB]
-22.500 M	-8.500 M	1.00 M	1.708846 G	-35.15	-56.29	-22.15
-8.500 M	-7.500 M	150.00 k	1.709928 G	-34.01	-55.15	-21.01
7.500 M	22.500 M	100.00 k	1.737476 G	-40.94	-62.09	-340.94

Date: 6.AUG.2020 19:57:21



Report Number: W6M22006-20020-P-247  
 FCC ID: GX9CTC1052QT

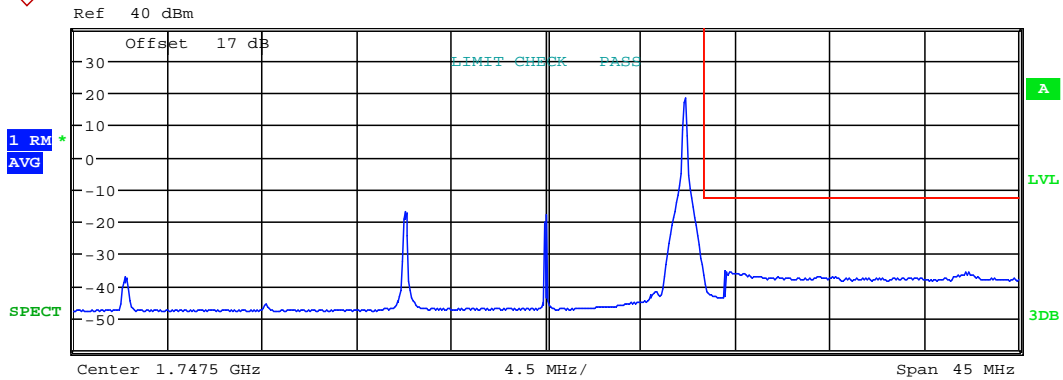

Tx Channel				BW_15_MHz_higher UL			
Bandwidth			Power		Power		
Start	Stop	RBW	Freq	PwrAbs	PwrRel	Δ Limit	
[Hz]	[Hz]	[Hz]	[Hz]	[dBm]	[dBc]	[dB]	
-22.500 M	-7.500 M	100.00 k	1.727452 G	-37.35	-58.00	-337.35	
7.500 M	8.500 M	150.00 k	1.755000 G	-34.02	-54.67	-21.02	
8.500 M	22.500 M	1.00 M	1.756082 G	-35.63	-56.28	-22.63	

Date: 6.AUG.2020 19:59:30



# Worldwide Testing Services(Taiwan) Co., Ltd.

Report Number: W6M22006-20020-P-247

FCC ID: GX9CTC1052QT

20MHz

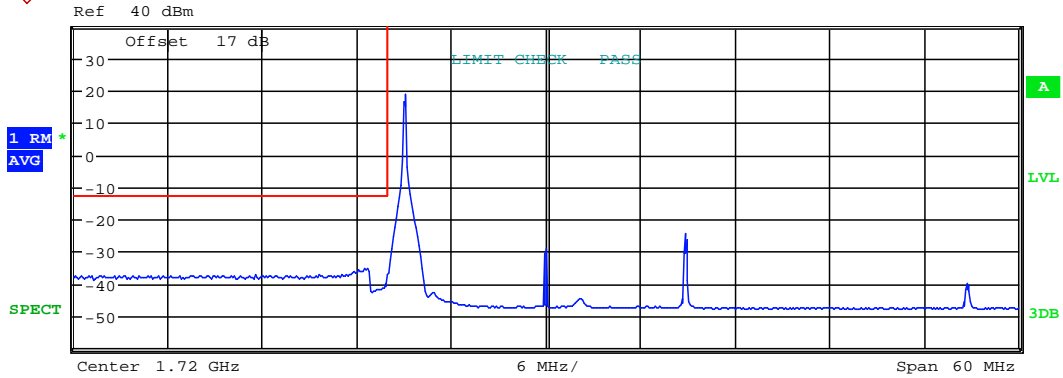

Tx Channel				BW_20_MHz_lower UL		
Bandwidth				Power		
Start	Stop	RBW	Freq	PwrAbs	PwrRel	ΔLimit
[Hz]	[Hz]	[Hz]	[Hz]	[dBm]	[dBc]	[dB]
-30.000 M	-11.000 M	1.00 M	1.708462 G	-35.27	-56.49	-22.27
-11.000 M	-10.000 M	200.00 k	1.709904 G	-37.25	-58.47	-24.25
10.000 M	30.000 M	100.00 k	1.746731 G	-40.22	-61.45	-340.22

Date: 6.AUG.2020 20:03:02



# Worldwide Testing Services(Taiwan) Co., Ltd.

Report Number: W6M22006-20020-P-247  
 FCC ID: GX9CTC1052QT

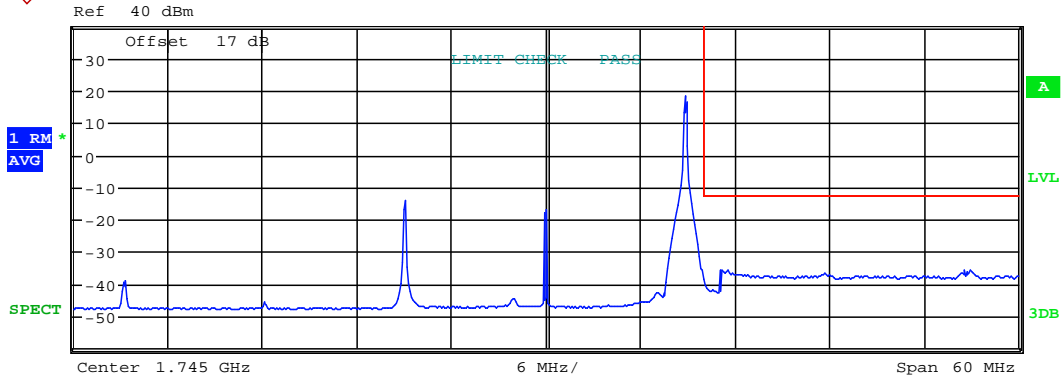

Tx Channel				BW_20_MHz_higher UL		
Bandwidth		20 MHz	Power		20.87 dBm	
Start	Stop	RBW	Freq	PwrAbs	PwrRel	Δ Limit
[Hz]	[Hz]	[Hz]	[Hz]	[dBm]	[dBc]	[dB]
-30.000 M	-10.000 M	100.00 k	1.718269 G	-39.21	-60.09	-339.21
10.000 M	11.000 M	200.00 k	1.755000 G	-35.85	-56.72	-22.85
11.000 M	30.000 M	1.00 M	1.756154 G	-35.59	-56.46	-22.59

Date: 6.AUG.2020 20:04:59



# Worldwide Testing Services(Taiwan) Co., Ltd.

Report Number: W6M22006-20020-P-247  
 FCC ID: GX9CTC1052QT

Band V  
 16QAM  
 1RB  
 1.4MHz

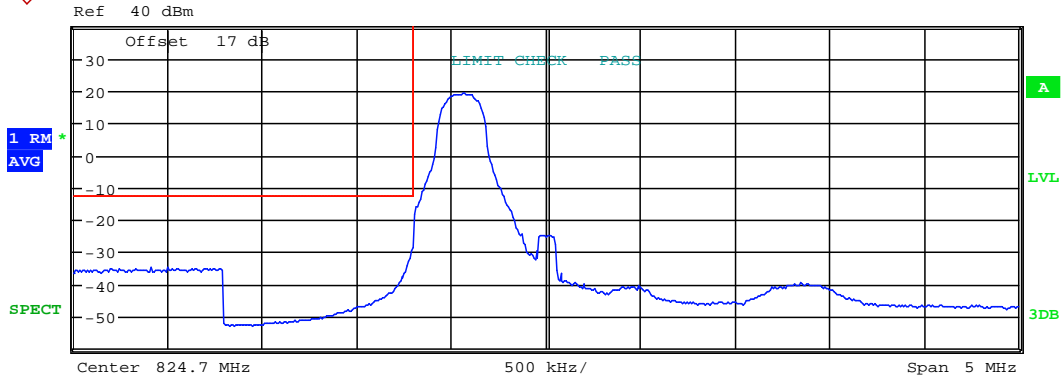

Tx Channel				BW_1_4_MHz_lower UL		
Bandwidth		1.4 MHz	Power		21.18 dBm	
Start [Hz]	Stop [Hz]	RBW [Hz]	Freq [Hz]	PwrAbs [dBm]	PwrRel [dBc]	ΔLimit [dB]
-2.500 M	-1.700 M	1.00 M	822.608654 M	-34.85	-56.03	-21.85
-1.700 M	-700.000 k	20.00 k	823.994872 M	-28.60	-49.78	-15.60
700.000 k	2.500 M	100.00 k	826.046154 M	-39.78	-60.96	-339.78

Date: 6.AUG.2020 20:08:38



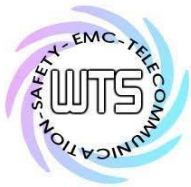

Report Number: W6M22006-20020-P-247  
 FCC ID: GX9CTC1052QT

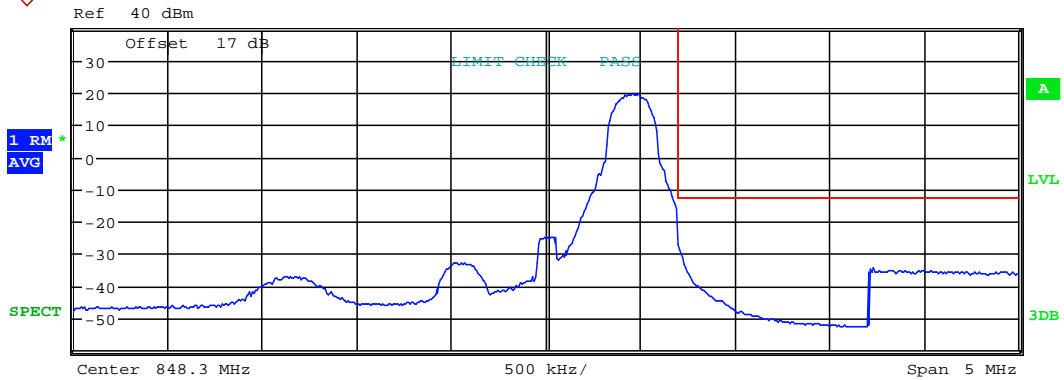

Tx Channel				BW_1_4_MHz_higher UL		
Bandwidth		1.4 MHz	Power		21.29 dBm	
Start	Stop	RBW	Freq	PwrAbs	PwrRel	Δ Limit
[Hz]	[Hz]	[Hz]	[Hz]	[dBm]	[dBc]	[dB]
-2.500 M	-700.000 k	100.00 k	846.969872 M	-37.00	-58.30	-337.00
700.000 k	1.700 M	20.00 k	849.000000 M	-17.11	-38.41	-4.11
1.700 M	2.500 M	1.00 M	850.030769 M	-34.18	-55.48	-21.18

Date: 6.AUG.2020 20:12:40



# Worldwide Testing Services(Taiwan) Co., Ltd.

Report Number: W6M22006-20020-P-247

FCC ID: GX9CTC1052QT

3MHz

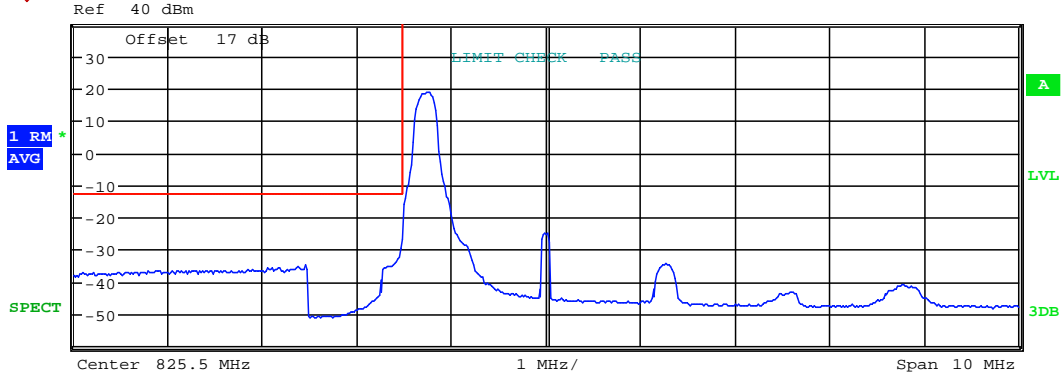

Tx Channel				BW_3_MHz_lower UL		
Bandwidth				Power		
Start	Stop	RBW	Freq	PwrAbs	PwrRel	ΔLimit
[Hz]	[Hz]	[Hz]	[Hz]	[dBm]	[dBc]	[dB]
-5.000 M	-2.500 M	1.00 M	822.951923 M	-35.02	-55.82	-22.02
-2.500 M	-1.500 M	30.00 k	823.977564 M	-26.71	-47.51	-13.71
1.500 M	5.000 M	100.00 k	829.266026 M	-41.04	-61.84	-341.04

Date: 6.AUG.2020 20:15:02

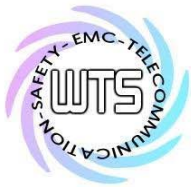

Report Number: W6M22006-20020-P-247  
 FCC ID: GX9CTC1052QT

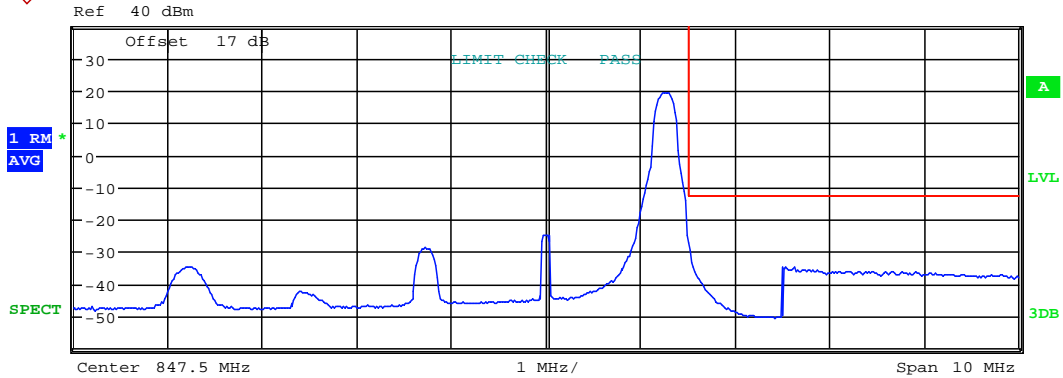

Tx Channel				BW_3_MHz_higher UL		
Bandwidth		3 MHz		Power		21.28 dBm
Start	Stop	RBW	Freq	PwrAbs	PwrRel	Δ Limit
[Hz]	[Hz]	[Hz]	[Hz]	[dBm]	[dBc]	[dB]
-5.000 M	-1.500 M	100.00 k	843.701923 M	-34.77	-56.05	-334.77
1.500 M	2.500 M	30.00 k	849.006410 M	-25.33	-46.61	-12.33
2.500 M	5.000 M	1.00 M	850.032051 M	-35.01	-56.30	-22.01

Date: 6.AUG.2020 20:16:58

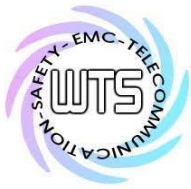

# Worldwide Testing Services(Taiwan) Co., Ltd.

Report Number: W6M22006-20020-P-247

FCC ID: GX9CTC1052QT

5MHz

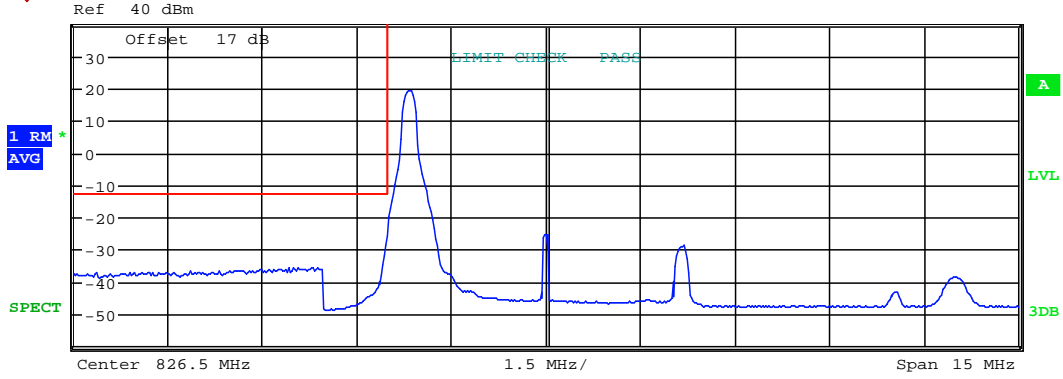

Tx Channel				BW_5_MHz_lower UL		
Bandwidth				Power		
Start	Stop	RBW	Freq	PwrAbs	PwrRel	ΔLimit
[Hz]	[Hz]	[Hz]	[Hz]	[dBm]	[dBc]	[dB]
-7.500 M	-3.500 M	1.00 M	822.557692 M	-35.44	-56.85	-22.44
-3.500 M	-2.500 M	50.00 k	823.975962 M	-26.17	-47.58	-13.17
2.500 M	7.500 M	100.00 k	832.966346 M	-38.61	-60.02	-338.61

Date: 6.AUG.2020 20:17:56



# Worldwide Testing Services(Taiwan) Co., Ltd.

Report Number: W6M22006-20020-P-247  
 FCC ID: GX9CTC1052QT

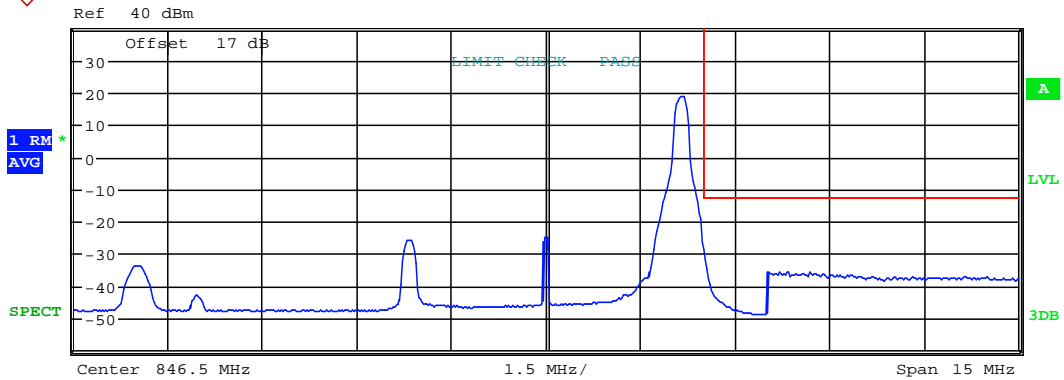

Tx Channel				BW_5_MHz_higher UL		
Bandwidth		5 MHz		Power		
Start	Stop	RBW	Freq	PwrAbs	PwrRel	Δ Limit
[Hz]	[Hz]	[Hz]	[Hz]	[dBm]	[dBc]	[dB]
-7.500 M	-2.500 M	100.00 k	840.009615 M	-33.76	-54.63	-333.76
2.500 M	3.500 M	50.00 k	849.000000 M	-26.74	-47.61	-13.74
3.500 M	7.500 M	1.00 M	850.682692 M	-35.76	-56.63	-22.76

Date: 6.AUG.2020 20:19:53



# Worldwide Testing Services(Taiwan) Co., Ltd.

Report Number: W6M22006-20020-P-247

FCC ID: GX9CTC1052QT

10MHz

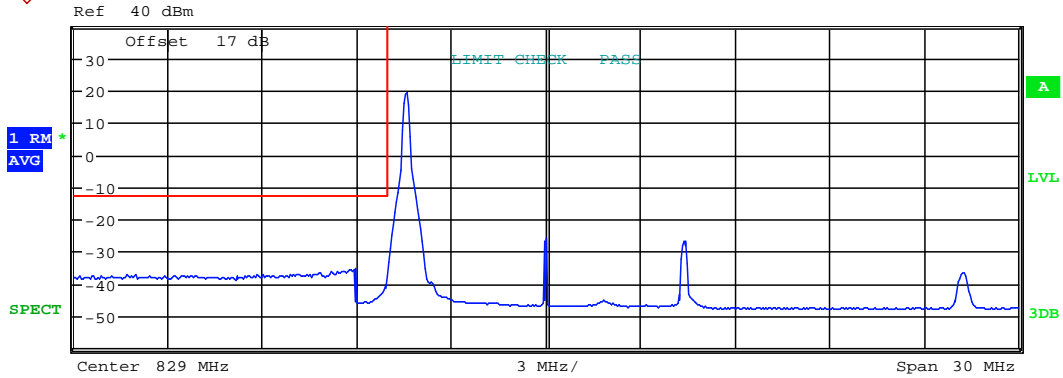

Tx Channel				BW_10_MHz_lower UL		
Bandwidth		10 MHz	Power		21.42 dBm	
Start [Hz]	Stop [Hz]	RBW [Hz]	Freq [Hz]	PwrAbs [dBm]	PwrRel [dBc]	ΔLimit [dB]
-15.000 M	-6.000 M	1.00 M	822.942308 M	-35.69	-57.11	-22.69
-6.000 M	-5.000 M	100.00 k	823.951923 M	-37.97	-59.39	-24.97
5.000 M	15.000 M	100.00 k	842.269231 M	-36.58	-58.00	-336.58

Date: 6.AUG.2020 20:22:51



Report Number: W6M22006-20020-P-247  
 FCC ID: GX9CTC1052QT

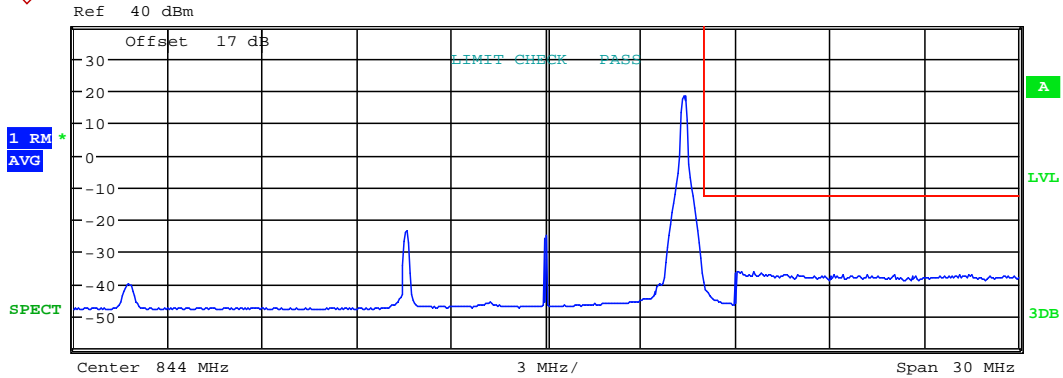

Tx Channel				BW_10_MHz_higher UL		
Bandwidth		10 MHz	Power		20.75 dBm	
Start [Hz]	Stop [Hz]	RBW [Hz]	Freq [Hz]	PwrAbs [dBm]	PwrRel [dBc]	Δ Limit [dB]
-15.000 M	-5.000 M	100.00 k	830.730769 M	-40.10	-60.85	-340.10
5.000 M	6.000 M	100.00 k	849.000000 M	-37.26	-58.01	-24.26
6.000 M	15.000 M	1.00 M	850.057692 M	-36.21	-56.96	-23.21

Date: 6.AUG.2020 20:23:39



# Worldwide Testing Services(Taiwan) Co., Ltd.

Report Number: W6M22006-20020-P-247

FCC ID: GX9CTC1052QT

QPSK

FRB

1.4MHz

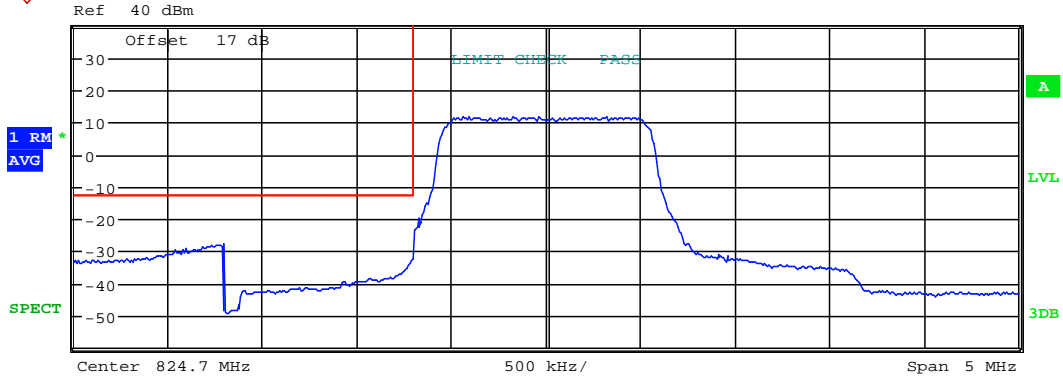

Tx Channel				BW_1_4_MHz_lower UL		
Bandwidth		1.4 MHz		Power		20.97 dBm
Start [Hz]	Stop [Hz]	RBW [Hz]	Freq [Hz]	PwrAbs [dBm]	PwrRel [dBc]	Δ Limit [dB]
-2.500 M	-1.700 M	1.00 M	822.993269 M	-27.87	-48.84	-14.87
-1.700 M	-700.000 k	20.00 k	823.994872 M	-32.69	-53.66	-19.69
700.000 k	2.500 M	100.00 k	825.400000 M	-21.90	-42.87	-321.90

Date: 6.AUG.2020 20:10:14





# Worldwide Testing Services(Taiwan) Co., Ltd.

Report Number: W6M22006-20020-P-247

FCC ID: GX9CTC1052QT

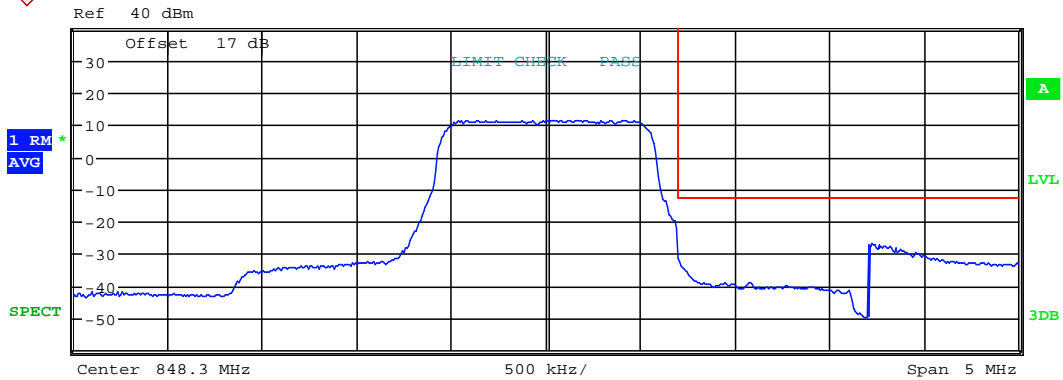

Tx Channel				BW_1_4_MHz_higher UL		
Bandwidth		1.4 MHz	Power		20.83 dBm	
Start [Hz]	Stop [Hz]	RBW [Hz]	Freq [Hz]	PwrAbs [dBm]	PwrRel [dBc]	Δ Limit [dB]
-2.500 M	-700.000 k	100.00 k	847.594872 M	-23.47	-44.30	-323.47
700.000 k	1.700 M	20.00 k	849.000000 M	-22.57	-43.41	-9.57
1.700 M	2.500 M	1.00 M	850.022756 M	-26.81	-47.64	-13.81

Date: 6.AUG.2020 20:11:46



# Worldwide Testing Services(Taiwan) Co., Ltd.

Report Number: W6M22006-20020-P-247

FCC ID: GX9CTC1052QT

3MHz

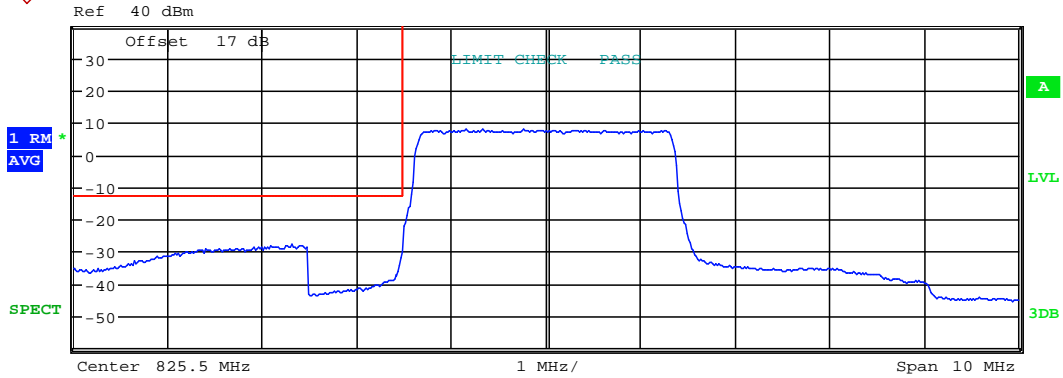

Tx Channel				BW_3_MHz_lower UL		
Bandwidth				Power		
Start	Stop	RBW	Freq	PwrAbs	PwrRel	ΔLimit
[Hz]	[Hz]	[Hz]	[Hz]	[dBm]	[dBc]	[dB]
-5.000 M	-2.500 M	1.00 M	822.807692 M	-27.90	-48.98	-14.90
-2.500 M	-1.500 M	30.00 k	823.977564 M	-30.27	-51.35	-17.27
1.500 M	5.000 M	100.00 k	827.006410 M	-24.44	-45.52	-324.44

Date: 6.AUG.2020 20:15:43



Report Number: W6M22006-20020-P-247  
 FCC ID: GX9CTC1052QT

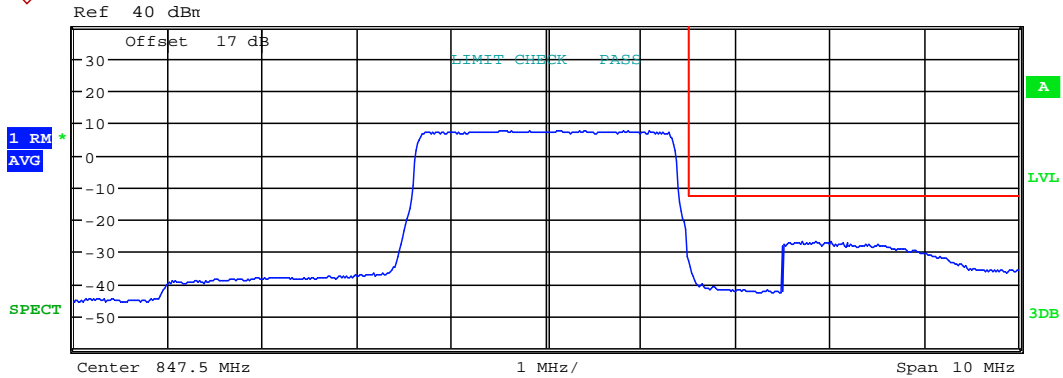

Tx Channel				BW_3_MHz_higher UL		
Bandwidth		3 MHz	Power		20.93 dBm	
Start	Stop	RBW	Freq	PwrAbs	PwrRel	Δ Limit
[Hz]	[Hz]	[Hz]	[Hz]	[dBm]	[dBc]	[dB]
-5.000 M	-1.500 M	100.00 k	845.977564 M	-25.77	-46.70	-325.77
1.500 M	2.500 M	30.00 k	849.006410 M	-31.87	-52.81	-18.87
2.500 M	5.000 M	1.00 M	850.512821 M	-26.86	-47.79	-13.86

Date: 6.AUG.2020 20:16:18



# Worldwide Testing Services(Taiwan) Co., Ltd.

Report Number: W6M22006-20020-P-247

FCC ID: GX9CTC1052QT

5MHz

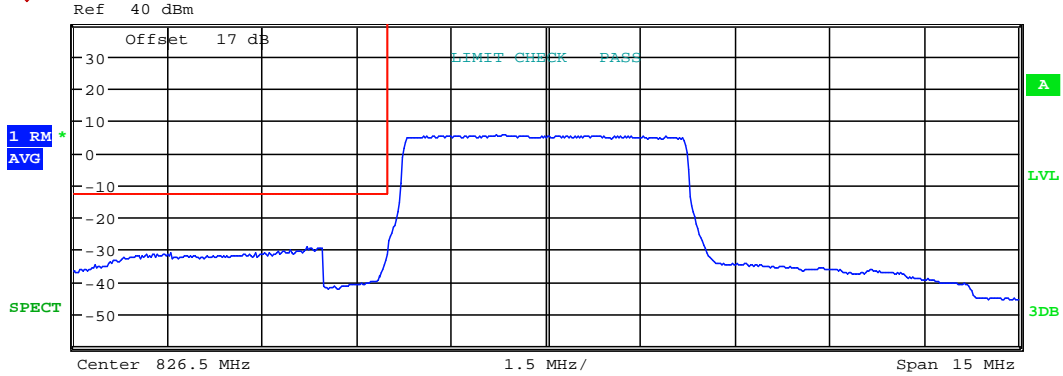

Tx Channel				BW_5_MHz_lower UL		
Bandwidth				Power		
Start	Stop	RBW	Freq	PwrAbs	PwrRel	ΔLimit
[Hz]	[Hz]	[Hz]	[Hz]	[dBm]	[dBc]	[dB]
-7.500 M	-3.500 M	1.00 M	822.701923 M	-29.26	-50.32	-16.26
-3.500 M	-2.500 M	50.00 k	823.975962 M	-31.80	-52.85	-18.80
2.500 M	7.500 M	100.00 k	829.000000 M	-27.93	-48.99	-327.93

Date: 6.AUG.2020 20:18:31



# Worldwide Testing Services(Taiwan) Co., Ltd.

Report Number: W6M22006-20020-P-247  
 FCC ID: GX9CTC1052QT

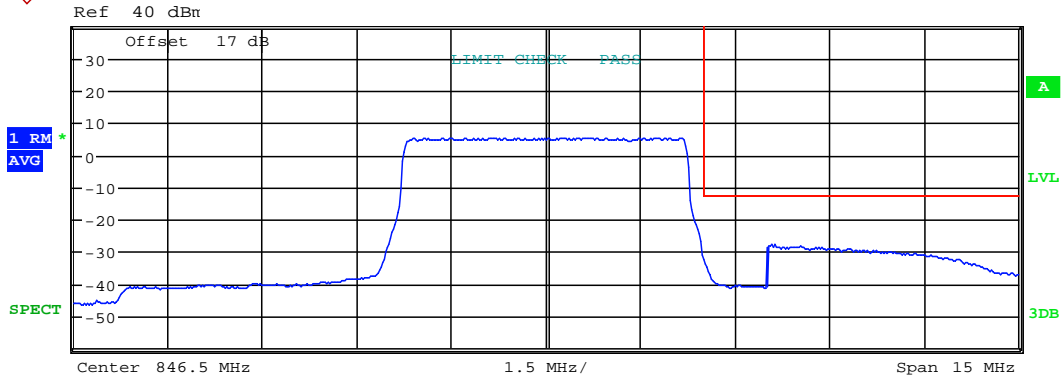

Tx Channel				BW_5_MHz_higher UL		
Bandwidth		5 MHz		Power		21.00 dBm
Start	Stop	RBW	Freq	PwrAbs	PwrRel	Δ Limit
[Hz]	[Hz]	[Hz]	[Hz]	[dBm]	[dBc]	[dB]
-7.500 M	-2.500 M	100.00 k	843.975962 M	-28.89	-49.89	-328.89
2.500 M	3.500 M	50.00 k	849.000000 M	-31.54	-52.55	-18.54
3.500 M	7.500 M	1.00 M	850.081731 M	-27.78	-48.78	-14.78

Date: 6.AUG.2020 20:19:09



# Worldwide Testing Services(Taiwan) Co., Ltd.

Report Number: W6M22006-20020-P-247

FCC ID: GX9CTC1052QT

10MHz

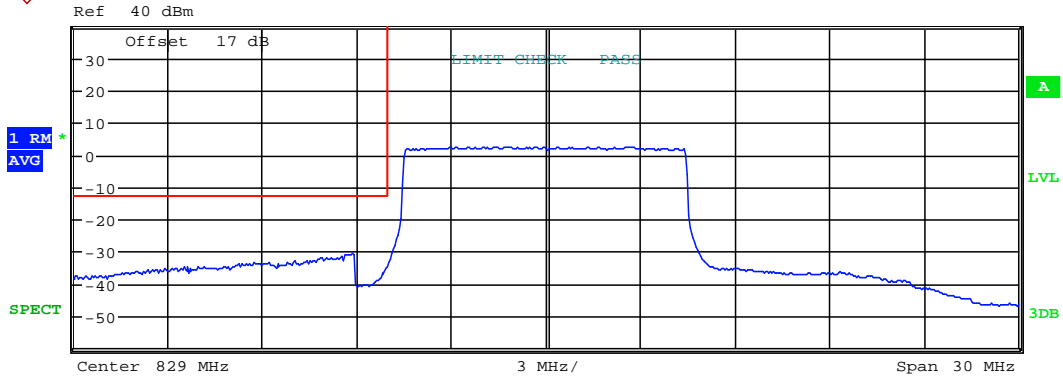

Tx Channel				BW_10_MHz_lower UL		
Bandwidth	10 MHz		Power	21.07 dBm		
Start [Hz]	Stop [Hz]	RBW [Hz]	Freq [Hz]	PwrAbs [dBm]	PwrRel [dBc]	ΔLimit [dB]
-15.000 M	-6.000 M	1.00 M	822.605769 M	-30.88	-51.95	-17.88
-6.000 M	-5.000 M	100.00 k	823.951923 M	-34.82	-55.89	-21.82
5.000 M	15.000 M	100.00 k	834.000000 M	-32.77	-53.84	-332.77

Date: 6.AUG.2020 20:22:05



Report Number: W6M22006-20020-P-247  
 FCC ID: GX9CTC1052QT

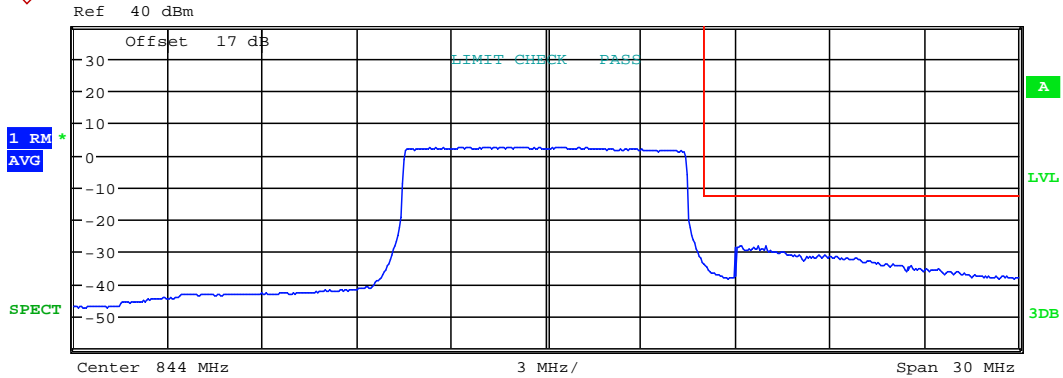

Tx Channel				BW_10_MHz_higher UL		
Bandwidth		10 MHz	Power		21.05 dBm	
Start	Stop	RBW	Freq	PwrAbs	PwrRel	Δ Limit
[Hz]	[Hz]	[Hz]	[Hz]	[dBm]	[dBc]	[dB]
-15.000 M	-5.000 M	100.00 k	838.951923 M	-34.79	-55.84	-334.79
5.000 M	6.000 M	100.00 k	849.000000 M	-33.78	-54.82	-20.78
6.000 M	15.000 M	1.00 M	850.730769 M	-28.39	-49.44	-15.39

Date: 6.AUG.2020 20:24:23



# Worldwide Testing Services(Taiwan) Co., Ltd.

Report Number: W6M22006-20020-P-247  
 FCC ID: GX9CTC1052QT

1RB  
 1.4MHz

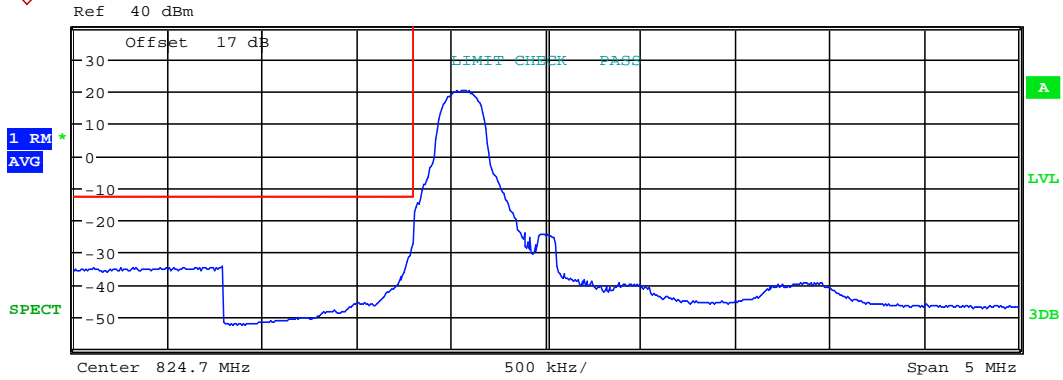

Tx Channel				BW_1_4_MHz_lower UL			
Bandwidth		1.4 MHz		Power		22.03 dBm	
Start [Hz]	Stop [Hz]	RBW [Hz]	Freq [Hz]	PwrAbs [dBm]	PwrRel [dBc]	ΔLimit [dB]	
-2.500 M	-1.700 M	1.00 M	822.841026 M	-34.63	-56.66	-21.63	
-1.700 M	-700.000 k	20.00 k	823.994872 M	-27.26	-49.29	-14.26	
700.000 k	2.500 M	100.00 k	826.150321 M	-39.52	-61.54	-339.52	

Date: 6.AUG.2020 20:09:05





# Worldwide Testing Services(Taiwan) Co., Ltd.

Report Number: W6M22006-20020-P-247  
 FCC ID: GX9CTC1052QT

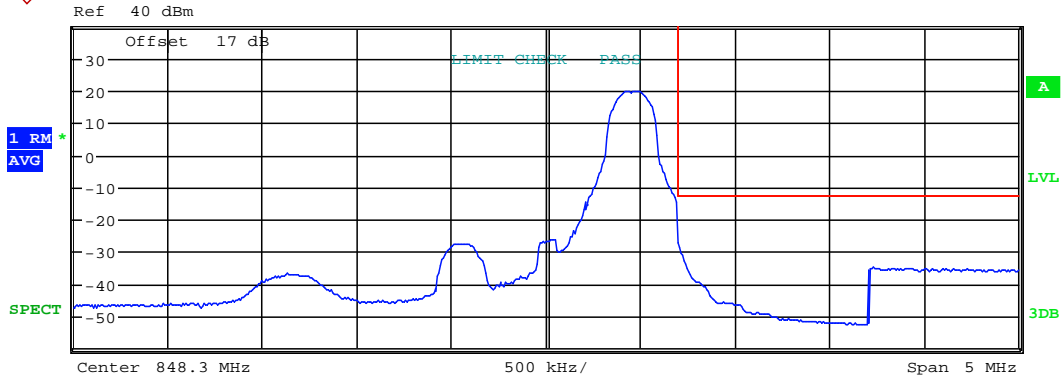

Tx Channel				BW_1_4_MHz_higher UL		
Bandwidth		1.4 MHz	Power		21.74 dBm	
Start	Stop	RBW	Freq	PwrAbs	PwrRel	Δ Limit
[Hz]	[Hz]	[Hz]	[Hz]	[dBm]	[dBc]	[dB]
-2.500 M	-700.000 k	100.00 k	846.929808 M	-36.94	-58.68	-336.94
700.000 k	1.700 M	20.00 k	849.000000 M	-15.52	-37.26	-2.52
1.700 M	2.500 M	1.00 M	850.030769 M	-35.06	-56.80	-22.06

Date: 6.AUG.2020 20:12:18



# Worldwide Testing Services(Taiwan) Co., Ltd.

Report Number: W6M22006-20020-P-247

FCC ID: GX9CTC1052QT

3MHz

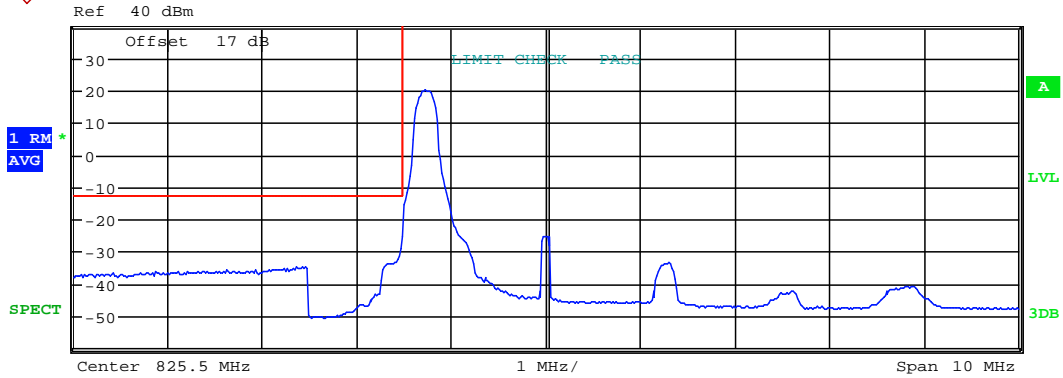

Tx Channel				BW_3_MHz_lower UL		
Bandwidth				Power		
Start	Stop	RBW	Freq	PwrAbs	PwrRel	ΔLimit
[Hz]	[Hz]	[Hz]	[Hz]	[dBm]	[dBc]	[dB]
-5.000 M	-2.500 M	1.00 M	822.919872 M	-34.92	-56.89	-21.92
-2.500 M	-1.500 M	30.00 k	823.977564 M	-25.69	-47.66	-12.69
1.500 M	5.000 M	100.00 k	829.298077 M	-41.07	-63.04	-341.07

Date: 6.AUG.2020 20:15:23



# Worldwide Testing Services(Taiwan) Co., Ltd.

Report Number: W6M22006-20020-P-247  
 FCC ID: GX9CTC1052QT

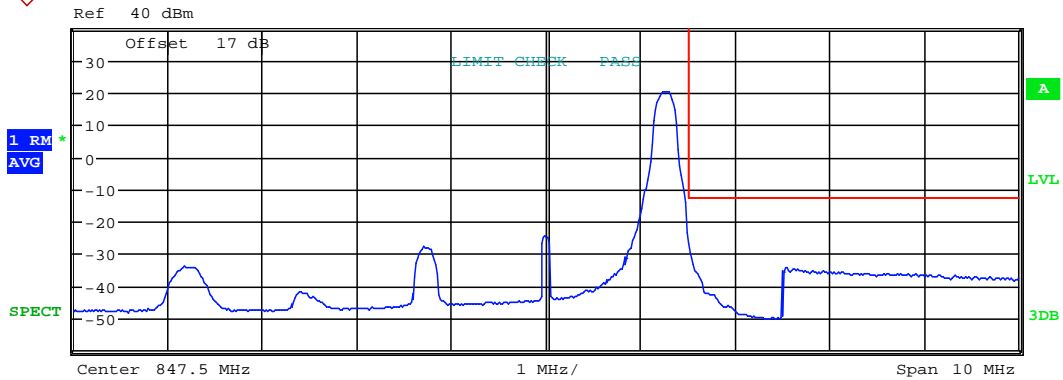

Tx Channel				BW_3_MHz_higher UL		
Bandwidth		3 MHz		Power		22.22 dBm
Start	Stop	RBW	Freq	PwrAbs	PwrRel	Δ Limit
[Hz]	[Hz]	[Hz]	[Hz]	[dBm]	[dBc]	[dB]
-5.000 M	-1.500 M	100.00 k	843.669872 M	-34.03	-56.25	-334.03
1.500 M	2.500 M	30.00 k	849.006410 M	-24.21	-46.44	-11.21
2.500 M	5.000 M	1.00 M	850.032051 M	-34.37	-56.59	-21.37

Date: 6.AUG.2020 20:16:40



# Worldwide Testing Services(Taiwan) Co., Ltd.

Report Number: W6M22006-20020-P-247

FCC ID: GX9CTC1052QT

5MHz

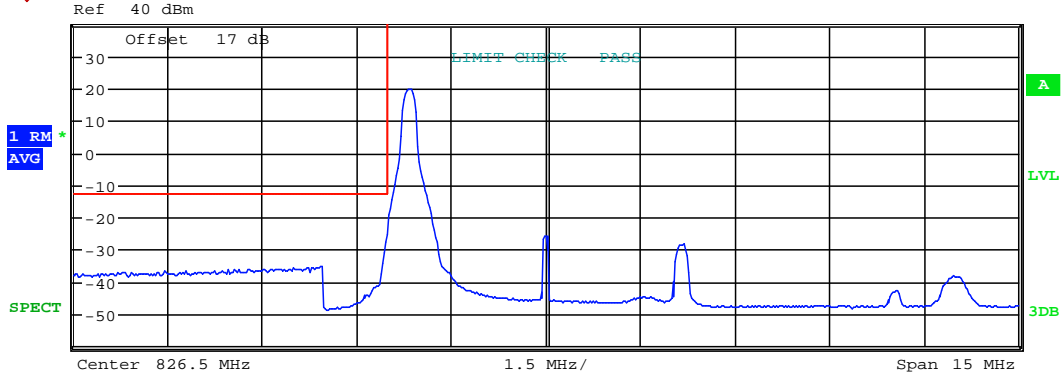

Tx Channel				BW_5_MHz_lower UL		
Bandwidth				Power		
Start	Stop	RBW	Freq	PwrAbs	PwrRel	ΔLimit
[Hz]	[Hz]	[Hz]	[Hz]	[dBm]	[dBc]	[dB]
-7.500 M	-3.500 M	1.00 M	822.918269 M	-35.37	-57.24	-22.37
-3.500 M	-2.500 M	50.00 k	823.975962 M	-25.29	-47.16	-12.29
2.500 M	7.500 M	100.00 k	832.966346 M	-38.30	-60.18	-338.30

Date: 6.AUG.2020 20:18:13



# Worldwide Testing Services(Taiwan) Co., Ltd.

Report Number: W6M22006-20020-P-247  
 FCC ID: GX9CTC1052QT

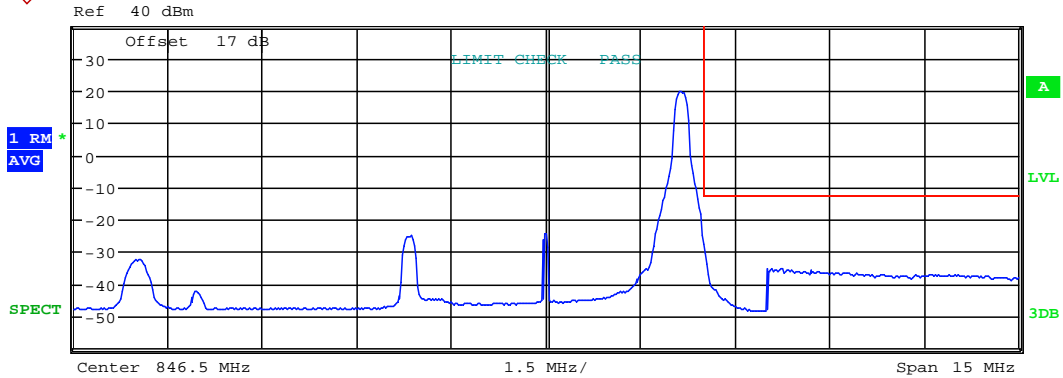

Tx Channel				BW_5_MHz_higher UL		
Bandwidth		5 MHz		Power		
Start	Stop	RBW	Freq	PwrAbs	PwrRel	Δ Limit
[Hz]	[Hz]	[Hz]	[Hz]	[dBm]	[dBc]	[dB]
-7.500 M	-2.500 M	100.00 k	840.033654 M	-32.67	-54.47	-332.67
2.500 M	3.500 M	50.00 k	849.000000 M	-25.72	-47.52	-12.72
3.500 M	7.500 M	1.00 M	850.081731 M	-35.20	-57.00	-22.20

Date: 6.AUG.2020 20:19:32



# Worldwide Testing Services(Taiwan) Co., Ltd.

Report Number: W6M22006-20020-P-247

FCC ID: GX9CTC1052QT

10MHz

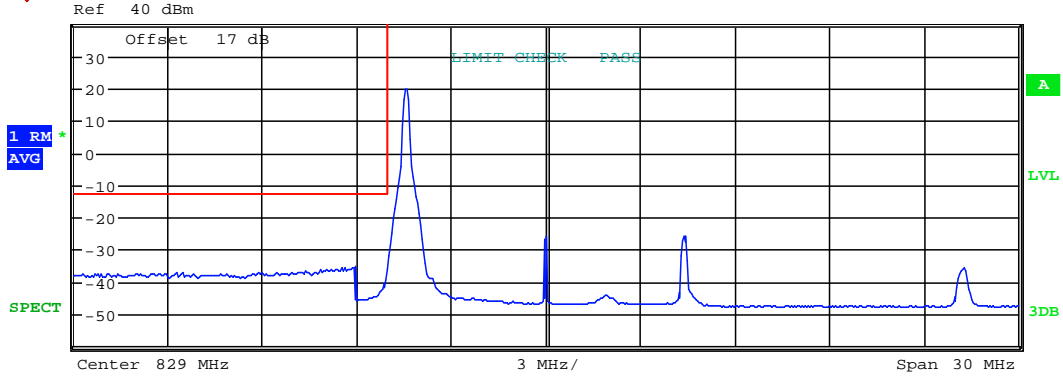

Tx Channel				BW_10_MHz_lower UL		
Bandwidth				Power		
Start	Stop	RBW	Freq	PwrAbs	PwrRel	ΔLimit
[Hz]	[Hz]	[Hz]	[Hz]	[dBm]	[dBc]	[dB]
-15.000 M	-6.000 M	1.00 M	822.942308 M	-35.25	-57.29	-22.25
-6.000 M	-5.000 M	100.00 k	823.951923 M	-36.26	-58.30	-23.26
5.000 M	15.000 M	100.00 k	842.269231 M	-36.00	-58.03	-336.00

Date: 6.AUG.2020 20:22:28



Report Number: W6M22006-20020-P-247  
 FCC ID: GX9CTC1052QT

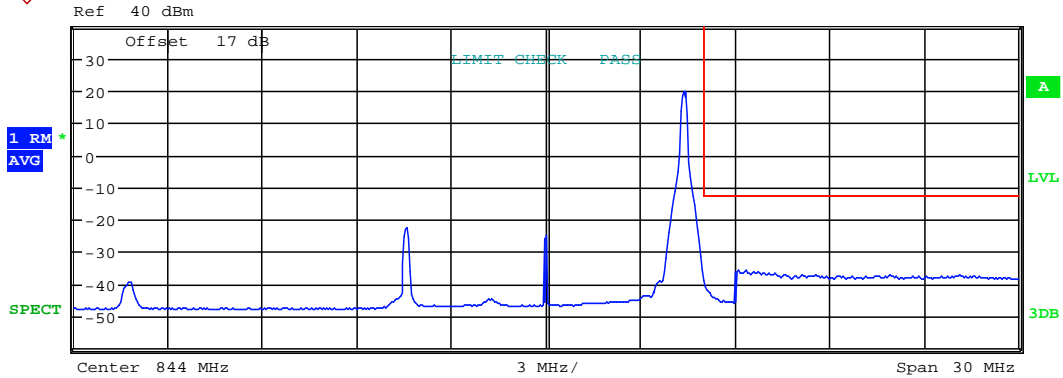

Tx Channel				BW_10_MHz_higher UL		
Bandwidth		10 MHz	Power		21.91 dBm	
Start [Hz]	Stop [Hz]	RBW [Hz]	Freq [Hz]	PwrAbs [dBm]	PwrRel [dBc]	Δ Limit [dB]
-15.000 M	-5.000 M	100.00 k	830.778846 M	-39.68	-61.59	-339.68
5.000 M	6.000 M	100.00 k	849.000000 M	-36.40	-58.31	-23.40
6.000 M	15.000 M	1.00 M	850.105769 M	-35.95	-57.86	-22.95

Date: 6.AUG.2020 20:24:02



# Worldwide Testing Services(Taiwan) Co., Ltd.

Report Number: W6M22006-20020-P-247  
 FCC ID: GX9CTC1052QT

Band XII  
 16QAM  
 1RB  
 1.4MHz

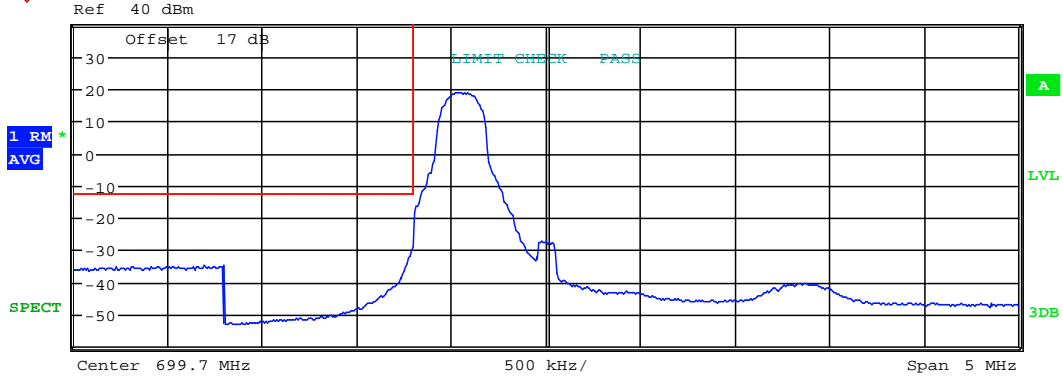

Tx Channel				BW_1_4_MHz_lower UL		
Bandwidth		1.4 MHz		Power		20.80 dBm
Start [Hz]	Stop [Hz]	RBW [Hz]	Freq [Hz]	PwrAbs [dBm]	PwrRel [dBc]	ΔLimit [dB]
-2.500 M	-1.700 M	1.00 M	697.889103 M	-34.93	-55.73	-21.93
-1.700 M	-700.000 k	20.00 k	698.994872 M	-29.29	-50.09	-16.29
700.000 k	2.500 M	100.00 k	701.062179 M	-40.60	-61.40	-340.60

Date: 6.AUG.2020 20:29:11





# Worldwide Testing Services(Taiwan) Co., Ltd.

Report Number: W6M22006-20020-P-247  
 FCC ID: GX9CTC1052QT

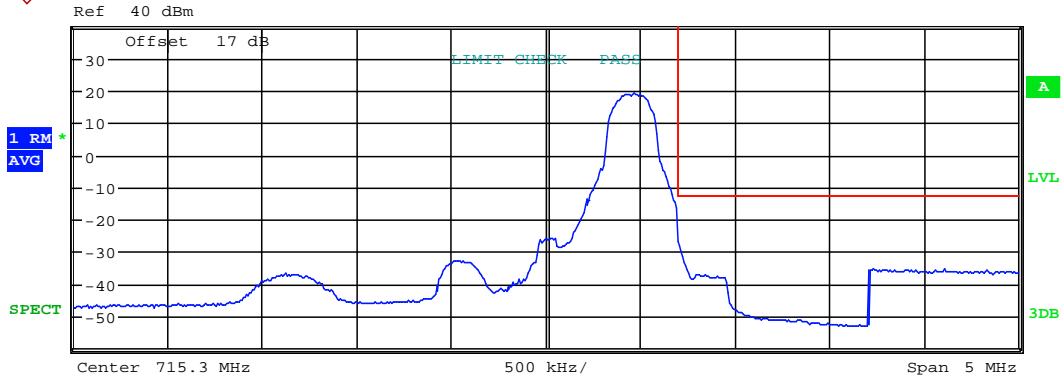

Tx Channel				BW_1_4_MHz_higher UL		
Bandwidth		1.4 MHz	Power		20.97 dBm	
Start	Stop	RBW	Freq	PwrAbs	PwrRel	Δ Limit
[Hz]	[Hz]	[Hz]	[Hz]	[dBm]	[dBc]	[dB]
-2.500 M	-700.000 k	100.00 k	713.921795 M	-36.78	-57.75	-336.78
700.000 k	1.700 M	20.00 k	716.000000 M	-17.01	-37.98	-4.01
1.700 M	2.500 M	1.00 M	717.030769 M	-35.40	-56.37	-22.40

Date: 6.AUG.2020 20:49:27



# Worldwide Testing Services(Taiwan) Co., Ltd.

Report Number: W6M22006-20020-P-247

FCC ID: GX9CTC1052QT

3MHz

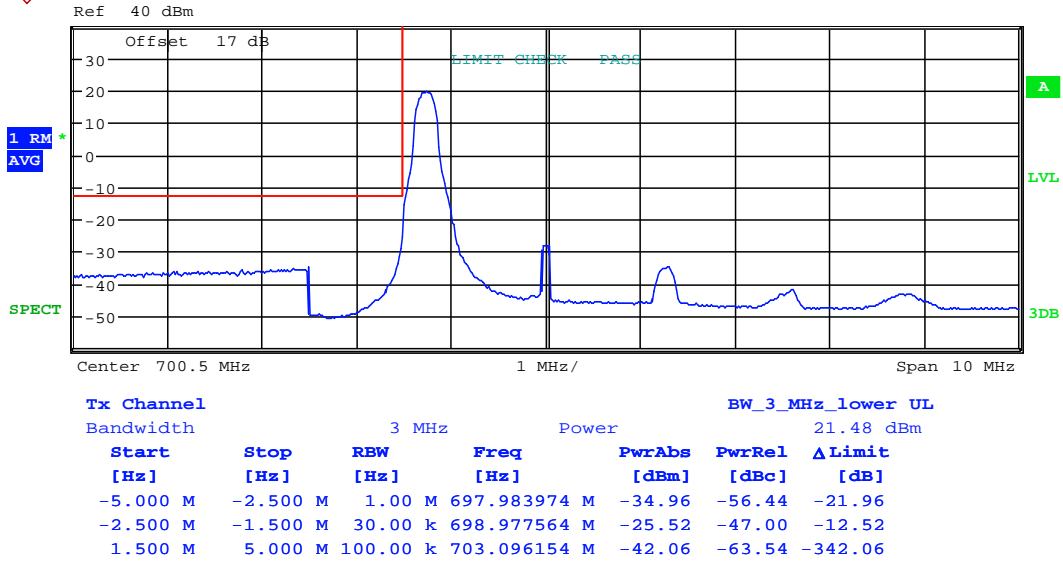

Date: 6.AUG.2020 20:52:19



Report Number: W6M22006-20020-P-247  
 FCC ID: GX9CTC1052QT

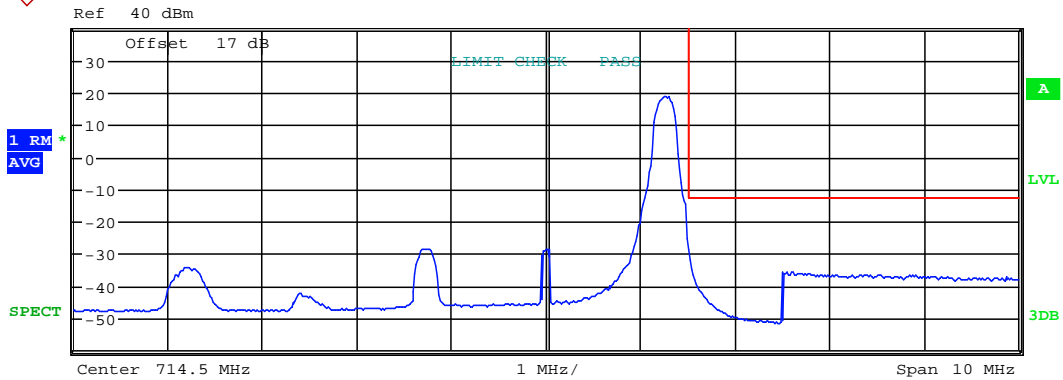

Tx Channel				BW_3_MHz_higher UL		
Bandwidth		3 MHz		Power		20.65 dBm
Start	Stop	RBW	Freq	PwrAbs	PwrRel	Δ Limit
[Hz]	[Hz]	[Hz]	[Hz]	[dBm]	[dBc]	[dB]
-5.000 M	-1.500 M	100.00 k	710.685897 M	-34.40	-55.05	-334.40
1.500 M	2.500 M	30.00 k	716.006410 M	-26.05	-46.71	-13.05
2.500 M	5.000 M	1.00 M	717.096154 M	-35.62	-56.28	-22.62

Date: 6.AUG.2020 20:55:32



# Worldwide Testing Services(Taiwan) Co., Ltd.

Report Number: W6M22006-20020-P-247

FCC ID: GX9CTC1052QT

5MHz

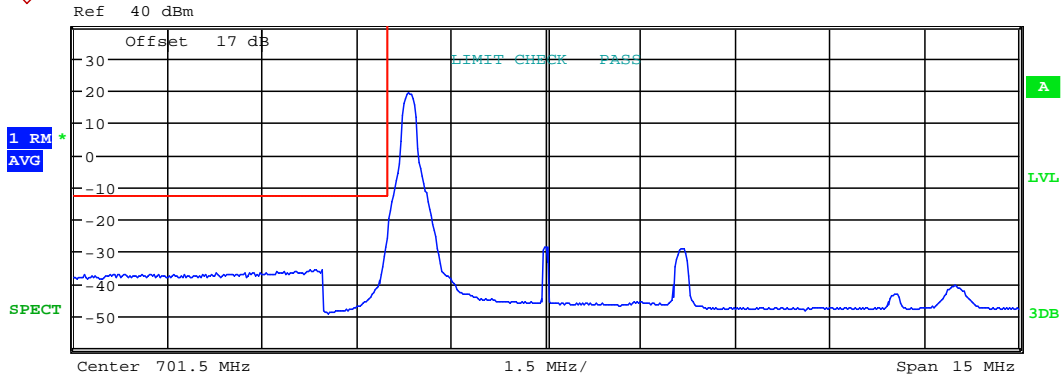

Tx Channel				BW_5_MHz_lower UL		
Bandwidth				Power		
Start	Stop	RBW	Freq	PwrAbs	PwrRel	ΔLimit
[Hz]	[Hz]	[Hz]	[Hz]	[dBm]	[dBc]	[dB]
-7.500 M	-3.500 M	1.00 M	697.750000 M	-35.81	-56.88	-22.81
-3.500 M	-2.500 M	50.00 k	698.975962 M	-25.79	-46.87	-12.79
2.500 M	7.500 M	100.00 k	707.990385 M	-40.69	-61.76	-340.69

Date: 6.AUG.2020 20:56:36



Report Number: W6M22006-20020-P-247  
 FCC ID: GX9CTC1052QT

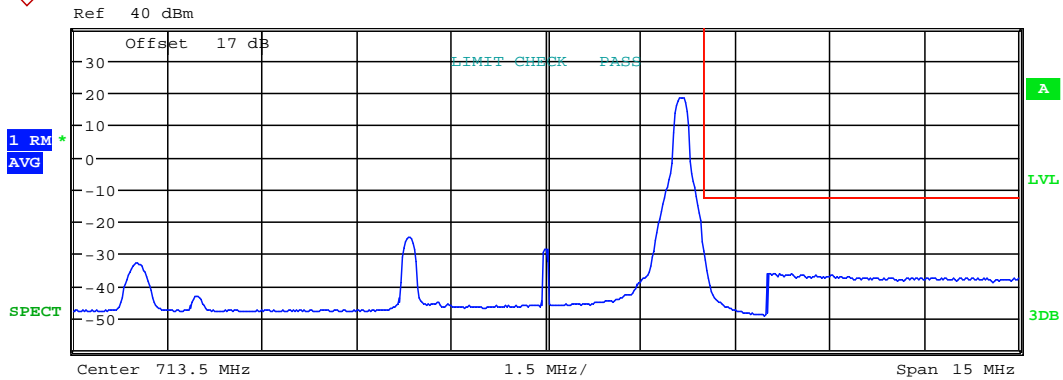

Tx Channel				BW_5_MHz_higher UL		
Bandwidth		5 MHz		Power		20.67 dBm
Start [Hz]	Stop [Hz]	RBW [Hz]	Freq [Hz]	PwrAbs [dBm]	PwrRel [dBc]	Δ Limit [dB]
-7.500 M	-2.500 M	100.00 k	707.009615 M	-33.06	-53.73	-333.06
2.500 M	3.500 M	50.00 k	716.000000 M	-26.87	-47.54	-13.87
3.500 M	7.500 M	1.00 M	717.129808 M	-36.33	-57.00	-23.33

Date: 6.AUG.2020 21:01:39



# Worldwide Testing Services(Taiwan) Co., Ltd.

Report Number: W6M22006-20020-P-247

FCC ID: GX9CTC1052QT

10MHz

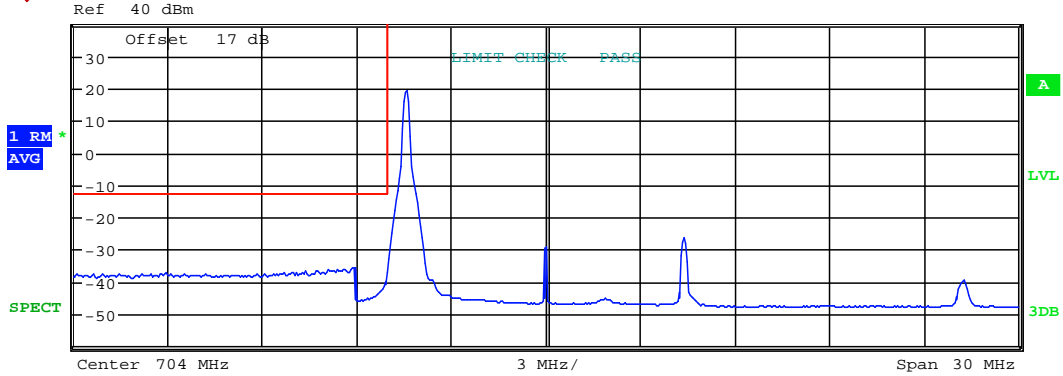

Tx Channel				BW_10_MHz_lower UL		
Bandwidth	10 MHz			Power		
Start [Hz]	Stop [Hz]	RBW [Hz]	Freq [Hz]	PwrAbs [dBm]	PwrRel [dBc]	ΔLimit [dB]
-15.000 M	-6.000 M	1.00 M	697.942308 M	-35.82	-57.39	-22.82
-6.000 M	-5.000 M	100.00 k	698.951923 M	-37.28	-58.84	-24.28
5.000 M	15.000 M	100.00 k	717.269231 M	-39.60	-61.17	-339.60

Date: 6.AUG.2020 21:05:02



# Worldwide Testing Services(Taiwan) Co., Ltd.

Report Number: W6M22006-20020-P-247  
 FCC ID: GX9CTC1052QT

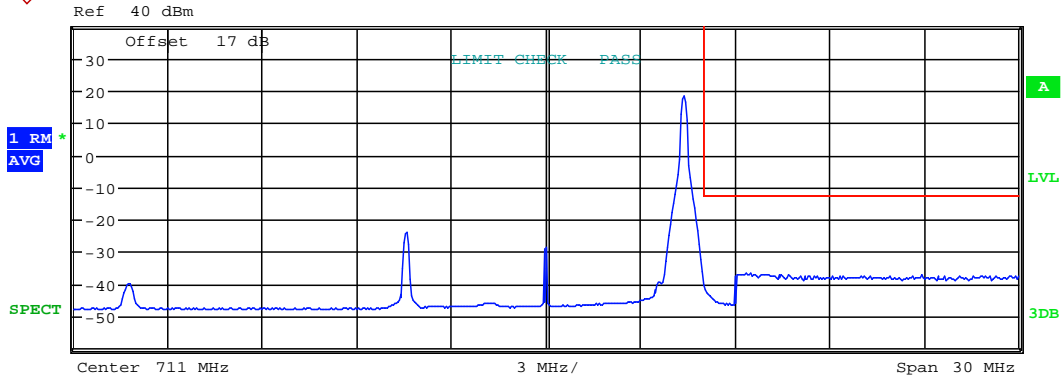

Tx Channel				BW_10_MHz_higher UL		
Bandwidth		10 MHz	Power		20.47 dBm	
Start [Hz]	Stop [Hz]	RBW [Hz]	Freq [Hz]	PwrAbs [dBm]	PwrRel [dBc]	Δ Limit [dB]
-15.000 M	-5.000 M	100.00 k	697.730769 M	-40.08	-60.55	-340.08
5.000 M	6.000 M	100.00 k	716.000000 M	-36.89	-57.36	-23.89
6.000 M	15.000 M	1.00 M	717.490385 M	-36.82	-57.29	-23.82

Date: 6.AUG.2020 21:08:12



# Worldwide Testing Services(Taiwan) Co., Ltd.

Report Number: W6M22006-20020-P-247

FCC ID: GX9CTC1052QT

QPSK

FRB

1.4MHz

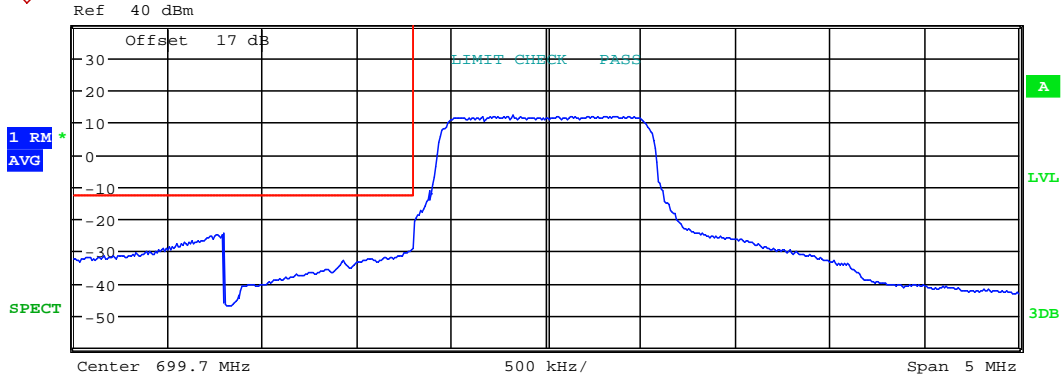

Tx Channel				BW_1_4_MHz_lower UL		
Bandwidth		1.4 MHz	Power		21.29 dBm	
Start	Stop	RBW	Freq	PwrAbs	PwrRel	Δ Limit
[Hz]	[Hz]	[Hz]	[Hz]	[dBm]	[dBc]	[dB]
-2.500 M	-1.700 M	1.00 M	697.993269 M	-24.49	-45.78	-11.49
-1.700 M	-700.000 k	20.00 k	698.994872 M	-29.18	-50.47	-16.18
700.000 k	2.500 M	100.00 k	700.400000 M	-20.86	-42.15	-320.86

Date: 6.AUG.2020 20:30:24





# Worldwide Testing Services(Taiwan) Co., Ltd.

Report Number: W6M22006-20020-P-247  
 FCC ID: GX9CTC1052QT

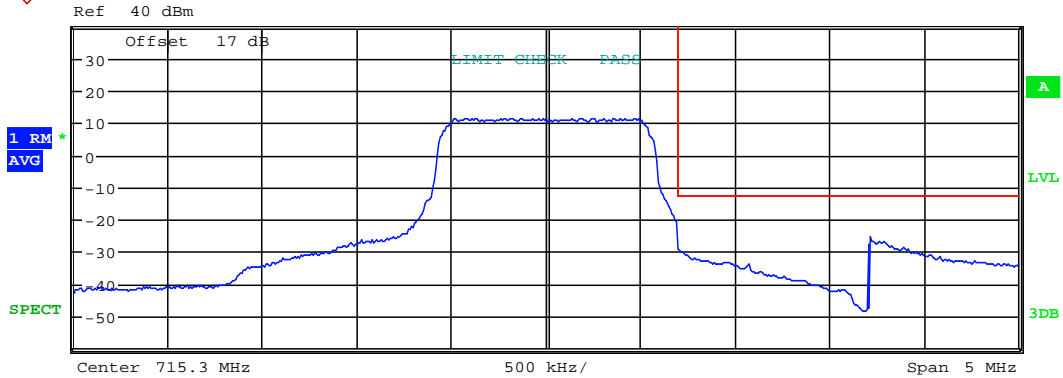

Tx Channel				BW_1_4_MHz_higher UL		
Bandwidth		1.4 MHz	Power		20.80 dBm	
Start	Stop	RBW	Freq	PwrAbs	PwrRel	ΔLimit
[Hz]	[Hz]	[Hz]	[Hz]	[dBm]	[dBc]	[dB]
-2.500 M	-700.000 k	100.00 k	714.586859 M	-22.19	-42.99	-322.19
700.000 k	1.700 M	20.00 k	716.000000 M	-20.48	-41.28	-7.48
1.700 M	2.500 M	1.00 M	717.014744 M	-25.57	-46.37	-12.57

Date: 6.AUG.2020 20:48:11



# Worldwide Testing Services(Taiwan) Co., Ltd.

Report Number: W6M22006-20020-P-247

FCC ID: GX9CTC1052QT

3MHz

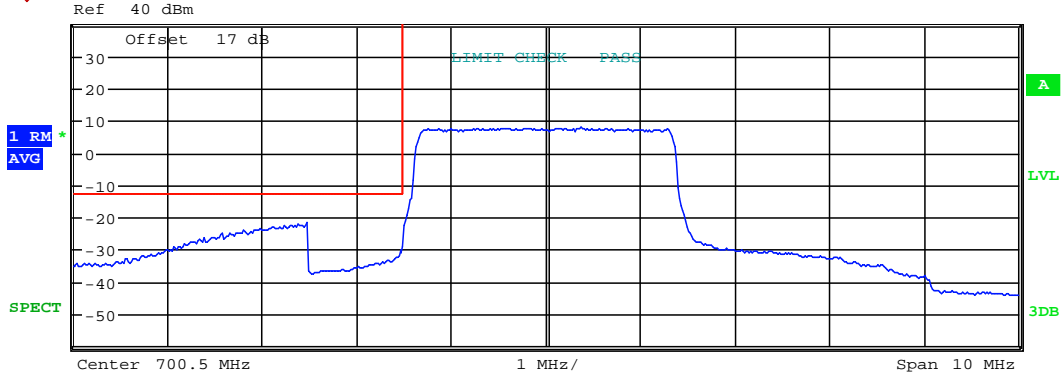

Tx Channel				BW_3_MHz_lower UL		
Bandwidth				Power		
Start	Stop	RBW	Freq	PwrAbs	PwrRel	ΔLimit
[Hz]	[Hz]	[Hz]	[Hz]	[dBm]	[dBc]	[dB]
-5.000 M	-2.500 M	1.00 M	697.967949 M	-21.86	-42.92	-8.86
-2.500 M	-1.500 M	30.00 k	698.977564 M	-29.27	-50.33	-16.27
1.500 M	5.000 M	100.00 k	702.006410 M	-23.54	-44.60	-323.54

Date: 6.AUG.2020 20:53:02



# Worldwide Testing Services(Taiwan) Co., Ltd.

Report Number: W6M22006-20020-P-247  
 FCC ID: GX9CTC1052QT

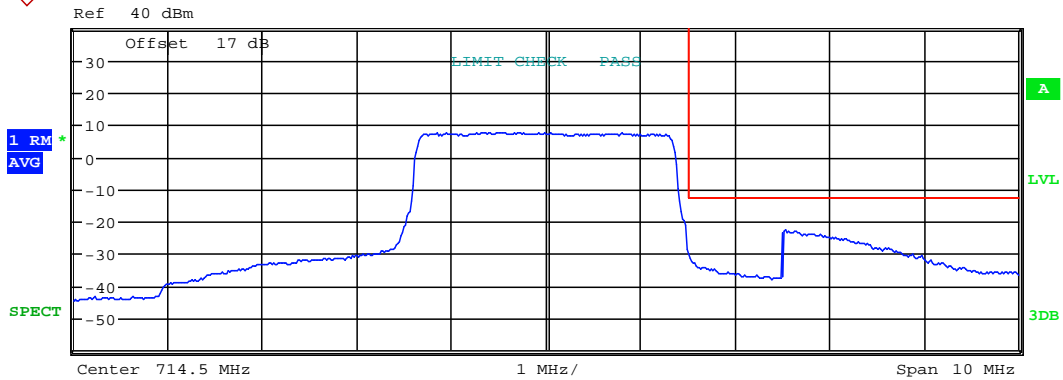

Tx Channel				BW_3_MHz_higher UL		
Bandwidth		3 MHz		Power		20.94 dBm
Start [Hz]	Stop [Hz]	RBW [Hz]	Freq [Hz]	PwrAbs [dBm]	PwrRel [dBc]	Δ Limit [dB]
-5.000 M	-1.500 M	100.00 k	712.977564 M	-23.44	-44.38	-323.44
1.500 M	2.500 M	30.00 k	716.006410 M	-29.10	-50.04	-16.10
2.500 M	5.000 M	1.00 M	717.032051 M	-22.75	-43.69	-9.75

Date: 6.AUG.2020 20:54:25



# Worldwide Testing Services(Taiwan) Co., Ltd.

Report Number: W6M22006-20020-P-247

FCC ID: GX9CTC1052QT

5MHz

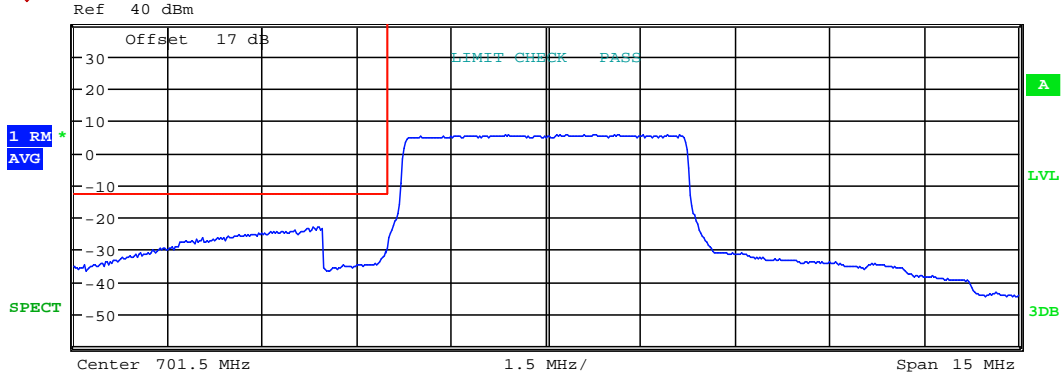

Tx Channel				BW_5_MHz_lower UL		
Bandwidth				Power		
Start	Stop	RBW	Freq	PwrAbs	PwrRel	ΔLimit
[Hz]	[Hz]	[Hz]	[Hz]	[dBm]	[dBc]	[dB]
-7.500 M	-3.500 M	1.00 M	697.870192 M	-23.20	-44.38	-10.20
-3.500 M	-2.500 M	50.00 k	698.975962 M	-29.78	-50.96	-16.78
2.500 M	7.500 M	100.00 k	704.000000 M	-26.23	-47.41	-326.23

Date: 6.AUG.2020 20:57:29



# Worldwide Testing Services(Taiwan) Co., Ltd.

Report Number: W6M22006-20020-P-247  
 FCC ID: GX9CTC1052QT

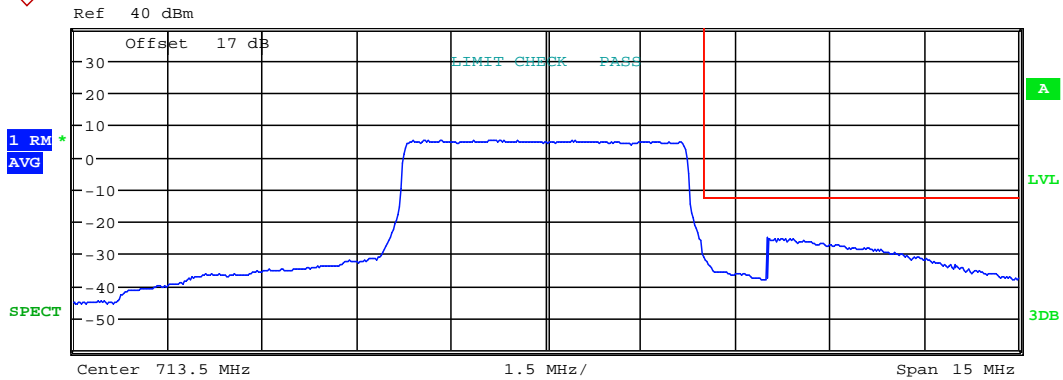

Tx Channel				BW_5_MHz_higher UL		
Bandwidth		5 MHz	Power		20.77 dBm	
Start	Stop	RBW	Freq	PwrAbs	PwrRel	Δ Limit
[Hz]	[Hz]	[Hz]	[Hz]	[dBm]	[dBc]	[dB]
-7.500 M	-2.500 M	100.00 k	710.975962 M	-26.96	-47.73	-326.96
2.500 M	3.500 M	50.00 k	716.000000 M	-30.88	-51.65	-17.88
3.500 M	7.500 M	1.00 M	717.370192 M	-25.28	-46.05	-12.28

Date: 6.AUG.2020 21:00:51



# Worldwide Testing Services(Taiwan) Co., Ltd.

Report Number: W6M22006-20020-P-247

FCC ID: GX9CTC1052QT

10MHz

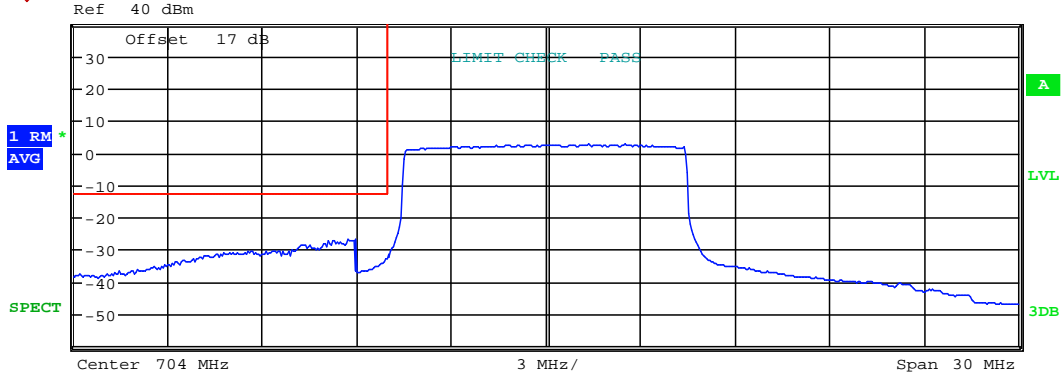

Tx Channel				BW_10_MHz_lower UL		
Bandwidth				Power		
Start	Stop	RBW	Freq	PwrAbs	PwrRel	ΔLimit
[Hz]	[Hz]	[Hz]	[Hz]	[dBm]	[dBc]	[dB]
-15.000 M	-6.000 M	1.00 M	697.942308 M	-26.68	-47.75	-13.68
-6.000 M	-5.000 M	100.0 k	698.951923 M	-32.97	-54.03	-19.97
5.000 M	15.000 M	100.0 k	709.000000 M	-31.90	-52.97	-331.90

Date: 6.AUG.2020 21:04:02



# Worldwide Testing Services(Taiwan) Co., Ltd.

Report Number: W6M22006-20020-P-247

FCC ID: GX9CTC1052QT

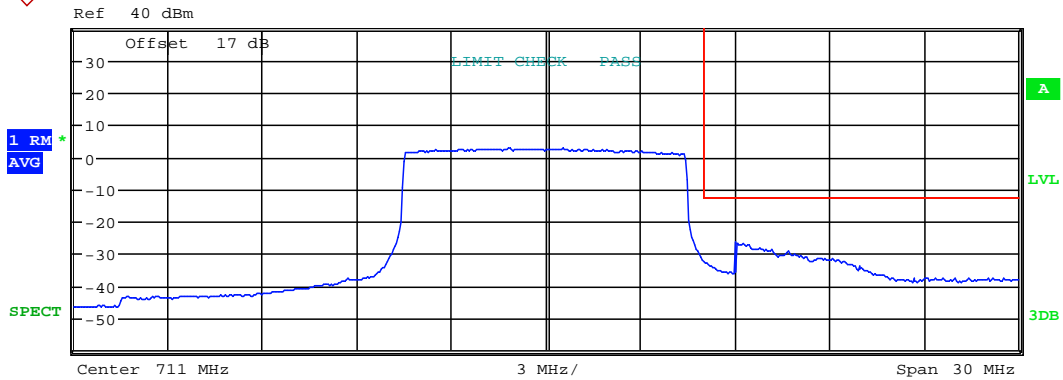

Tx Channel				BW_10_MHz_higher UL		
Bandwidth		10 MHz	Power		21.07 dBm	
Start	Stop	RBW	Freq	PwrAbs	PwrRel	Δ Limit
[Hz]	[Hz]	[Hz]	[Hz]	[dBm]	[dBc]	[dB]
-15.000 M	-5.000 M	100.00 k	705.951923 M	-32.54	-53.61	-332.54
5.000 M	6.000 M	100.00 k	716.000000 M	-32.43	-53.51	-19.43
6.000 M	15.000 M	1.00 M	717.057692 M	-26.78	-47.85	-13.78

Date: 6.AUG.2020 21:09:00



# Worldwide Testing Services(Taiwan) Co., Ltd.

Report Number: W6M22006-20020-P-247  
 FCC ID: GX9CTC1052QT

1RB  
 1.4MHz

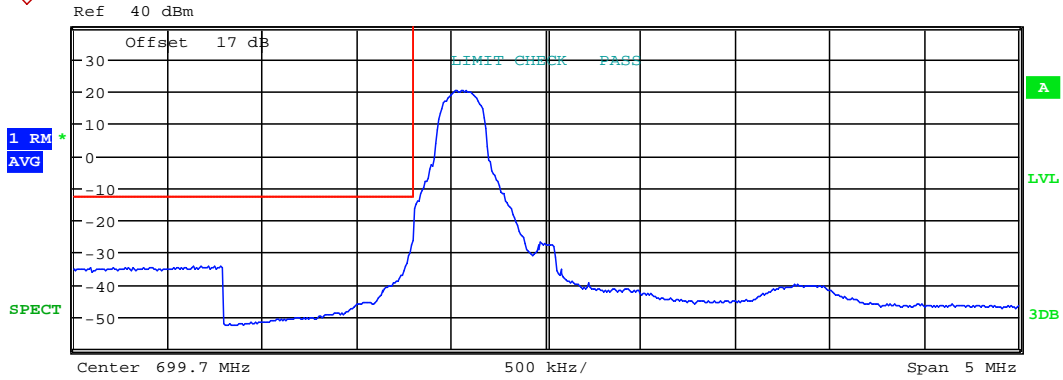

Tx Channel		1.4 MHz		Power			BW_1_4_MHz_lower UL
Bandwidth							22.02 dBm
Start [Hz]	Stop [Hz]	RBW [Hz]	Freq [Hz]	PwrAbs [dBm]	PwrRel [dBc]	ΔLimit [dB]	
-2.500 M	-1.700 M	1.00 M	697.913141 M	-34.35	-56.37	-21.35	
-1.700 M	-700.000 k	20.00 k	698.994872 M	-26.56	-48.58	-13.56	
700.000 k	2.500 M	100.00 k	701.014103 M	-40.08	-62.11	-340.08	

Date: 6.AUG.2020 20:29:44





# Worldwide Testing Services(Taiwan) Co., Ltd.

Report Number: W6M22006-20020-P-247  
 FCC ID: GX9CTC1052QT

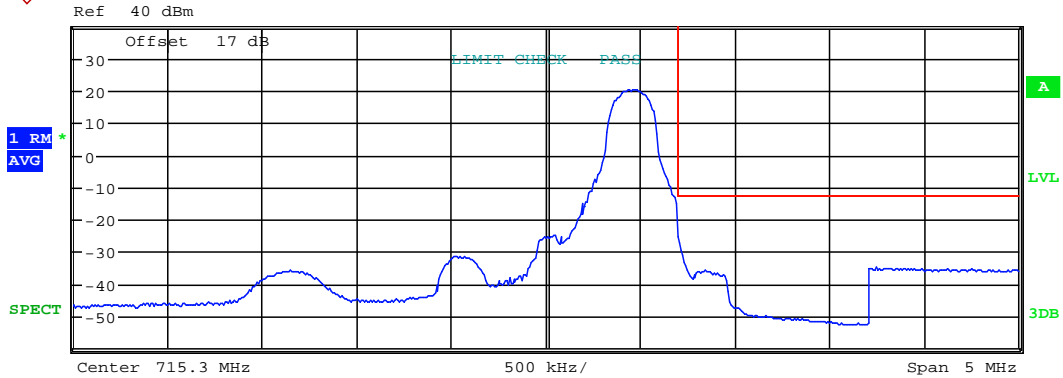

Tx Channel				BW_1_4_MHz_higher UL		
Bandwidth		1.4 MHz	Power		22.05 dBm	
Start [Hz]	Stop [Hz]	RBW [Hz]	Freq [Hz]	PwrAbs [dBm]	PwrRel [dBc]	ΔLimit [dB]
-2.500 M	-700.000 k	100.00 k	713.905769 M	-35.88	-57.93	-335.88
700.000 k	1.700 M	20.00 k	716.000000 M	-15.60	-37.65	-2.60
1.700 M	2.500 M	1.00 M	717.046795 M	-35.06	-57.11	-22.06

Date: 6.AUG.2020 20:48:47

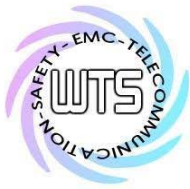

Report Number: W6M22006-20020-P-247

FCC ID: GX9CTC1052QT

3MHz

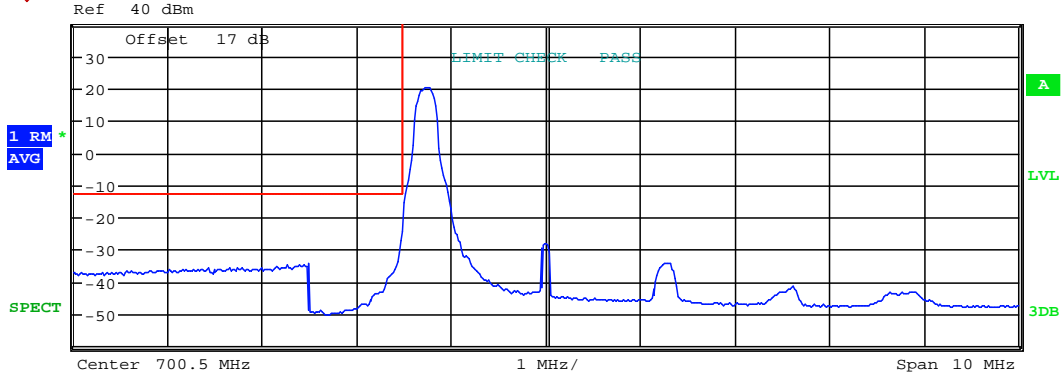

Tx Channel				BW_3_MHz_lower UL		
Bandwidth				Power		
Start	Stop	RBW	Freq	PwrAbs	PwrRel	ΔLimit
[Hz]	[Hz]	[Hz]	[Hz]	[dBm]	[dBc]	[dB]
-5.000 M	-2.500 M	1.00 M	697.983974 M	-34.51	-56.64	-21.51
-2.500 M	-1.500 M	30.00 k	698.977564 M	-24.69	-46.82	-11.69
1.500 M	5.000 M	100.00 k	703.096154 M	-41.67	-63.80	-341.67

Date: 6.AUG.2020 20:52:41



Report Number: W6M22006-20020-P-247  
 FCC ID: GX9CTC1052QT

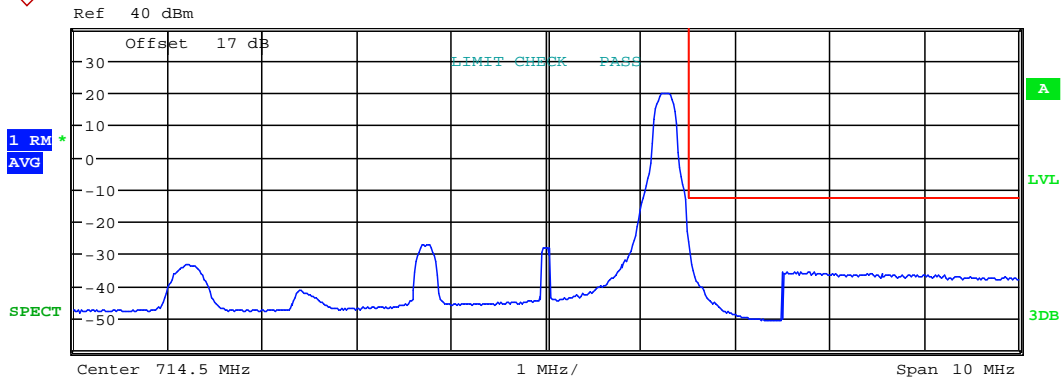

Tx Channel				BW_3_MHz_higher UL		
Bandwidth		3 MHz		Power		
Start	Stop	RBW	Freq	PwrAbs	PwrRel	Δ Limit
[Hz]	[Hz]	[Hz]	[Hz]	[dBm]	[dBc]	[dB]
-5.000 M	-1.500 M	100.00 k	710.701923 M	-33.42	-55.41	-333.42
1.500 M	2.500 M	30.00 k	716.006410 M	-23.67	-45.66	-10.67
2.500 M	5.000 M	1.00 M	717.048077 M	-35.71	-57.70	-22.71

Date: 6.AUG.2020 20:55:02



# Worldwide Testing Services(Taiwan) Co., Ltd.

Report Number: W6M22006-20020-P-247

FCC ID: GX9CTC1052QT

5MHz

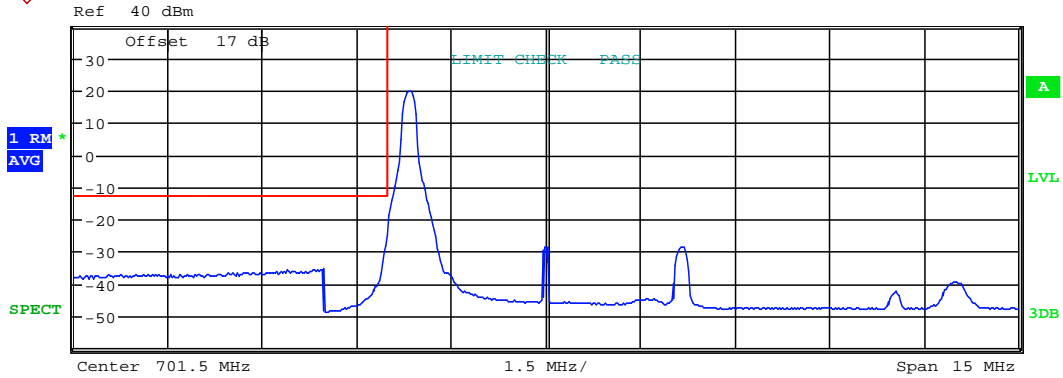

Tx Channel				BW_5_MHz_lower UL		
Bandwidth				Power		
Start	Stop	RBW	Freq	PwrAbs	PwrRel	ΔLimit
[Hz]	[Hz]	[Hz]	[Hz]	[dBm]	[dBc]	[dB]
-7.500 M	-3.500 M	1.00 M	697.870192 M	-35.66	-57.39	-22.66
-3.500 M	-2.500 M	50.00 k	698.975962 M	-25.13	-46.85	-12.13
2.500 M	7.500 M	100.00 k	707.990385 M	-39.46	-61.18	-339.46

Date: 6.AUG.2020 20:57:04



Report Number: W6M22006-20020-P-247  
 FCC ID: GX9CTC1052QT

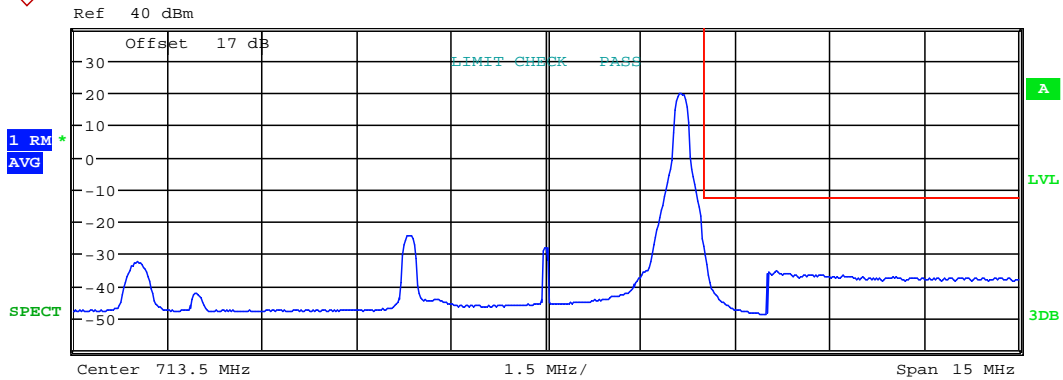

Tx Channel				BW_5_MHz_higher UL		
Bandwidth		5 MHz		Power		21.81 dBm
Start	Stop	RBW	Freq	PwrAbs	PwrRel	Δ Limit
[Hz]	[Hz]	[Hz]	[Hz]	[dBm]	[dBc]	[dB]
-7.500 M	-2.500 M	100.00 k	707.009615 M	-32.74	-54.55	-332.74
2.500 M	3.500 M	50.00 k	716.000000 M	-25.84	-47.65	-12.84
3.500 M	7.500 M	1.00 M	717.153846 M	-35.53	-57.34	-22.53

Date: 6.AUG.2020 21:01:16



# Worldwide Testing Services(Taiwan) Co., Ltd.

Report Number: W6M22006-20020-P-247

FCC ID: GX9CTC1052QT

10MHz

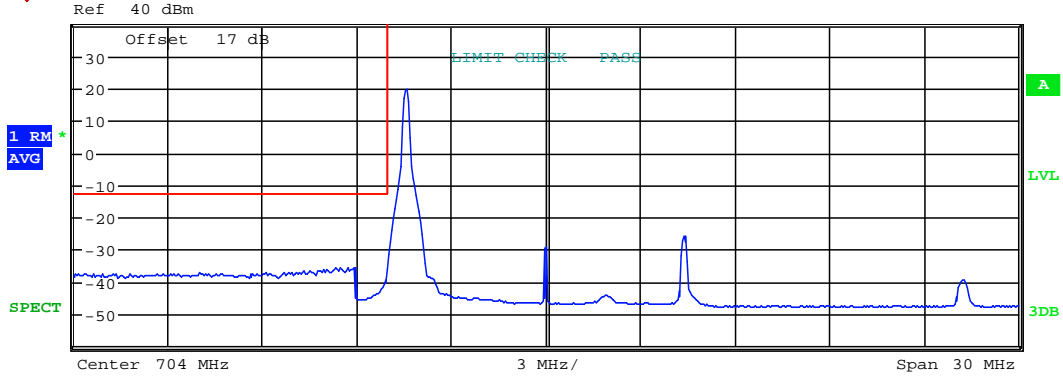

Tx Channel				BW_10_MHz_lower UL		
Bandwidth	10 MHz		Power	22.01 dBm		
Start [Hz]	Stop [Hz]	RBW [Hz]	Freq [Hz]	PwrAbs [dBm]	PwrRel [dBc]	ΔLimit [dB]
-15.000 M	-6.000 M	1.00 M	697.894231 M	-35.65	-57.66	-22.65
-6.000 M	-5.000 M	100.00 k	698.951923 M	-36.71	-58.72	-23.71
5.000 M	15.000 M	100.00 k	717.221154 M	-39.38	-61.39	-339.38

Date: 6.AUG.2020 21:04:26



# Worldwide Testing Services(Taiwan) Co., Ltd.

Report Number: W6M22006-20020-P-247  
 FCC ID: GX9CTC1052QT

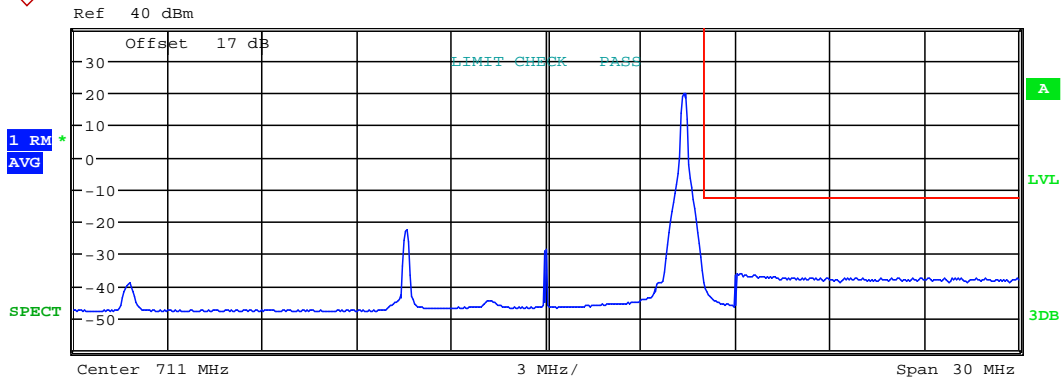

Tx Channel				BW_10_MHz_higher UL		
Bandwidth		10 MHz	Power		21.89 dBm	
Start [Hz]	Stop [Hz]	RBW [Hz]	Freq [Hz]	PwrAbs [dBm]	PwrRel [dBc]	ΔLimit [dB]
-15.000 M	-5.000 M	100.00 k	697.778846 M	-39.29	-61.19	-339.29
5.000 M	6.000 M	100.00 k	716.000000 M	-35.93	-57.82	-22.93
6.000 M	15.000 M	1.00 M	717.201923 M	-36.07	-57.96	-23.07

Date: 6.AUG.2020 21:08:35

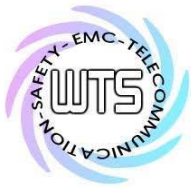

# Worldwide Testing Services(Taiwan) Co., Ltd.

Report Number: W6M22006-20020-P-247

FCC ID: GX9CTC1052QT

Band XIII

16QAM

1RB

5MHz

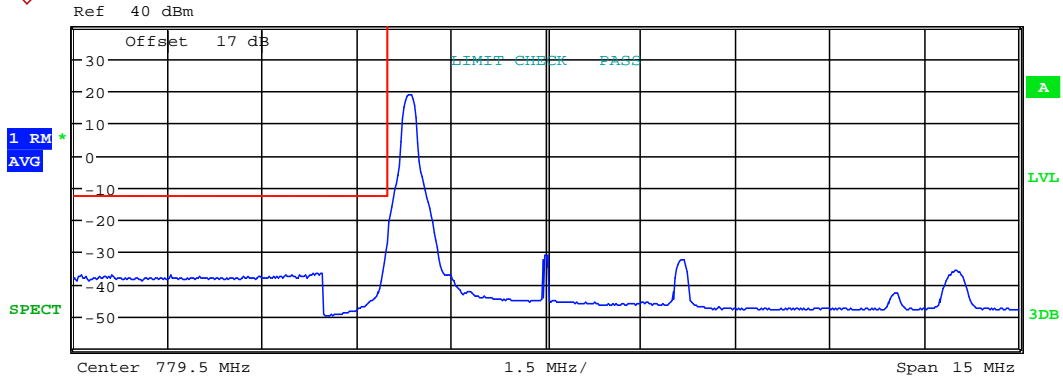

Tx Channel				BW_5_MHz_lower UL		
Bandwidth		5 MHz	Power		20.90 dBm	
Start [Hz]	Stop [Hz]	RBW [Hz]	Freq [Hz]	PwrAbs [dBm]	PwrRel [dBc]	ΔLimit [dB]
-7.500 M	-3.500 M	1.00 M	775.942308 M	-36.48	-57.38	-23.48
-3.500 M	-2.500 M	50.00 k	776.975962 M	-27.18	-48.08	-14.18
2.500 M	7.500 M	100.00 k	786.014423 M	-35.88	-56.78	-335.88

Date: 6.AUG.2020 21:11:46





# Worldwide Testing Services(Taiwan) Co., Ltd.

Report Number: W6M22006-20020-P-247  
 FCC ID: GX9CTC1052QT

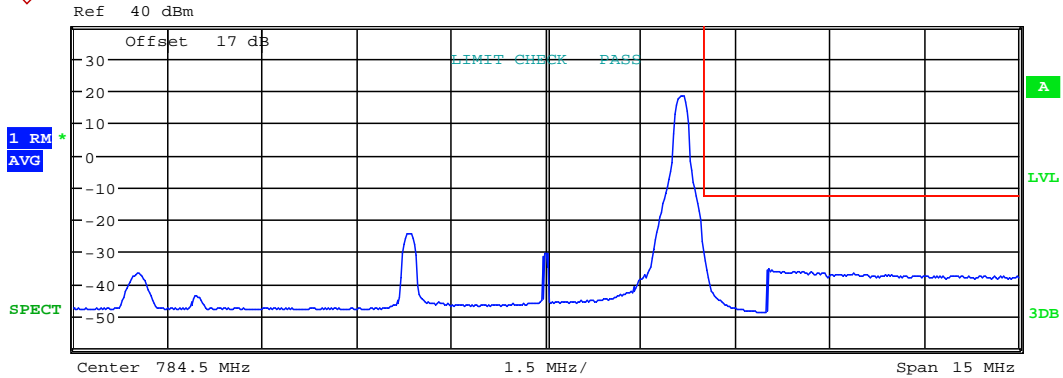

Tx Channel				BW_5_MHz_higher UL		
Bandwidth		5 MHz		Power		20.38 dBm
Start [Hz]	Stop [Hz]	RBW [Hz]	Freq [Hz]	PwrAbs [dBm]	PwrRel [dBc]	Δ Limit [dB]
-7.500 M	-2.500 M	100.00 k	778.009615 M	-36.89	-57.27	-336.89
2.500 M	3.500 M	50.00 k	787.000000 M	-27.52	-47.90	-14.52
3.500 M	7.500 M	1.00 M	788.033654 M	-35.50	-55.89	-22.50

Date: 6.AUG.2020 21:14:12



# Worldwide Testing Services(Taiwan) Co., Ltd.

Report Number: W6M22006-20020-P-247

FCC ID: GX9CTC1052QT

10MHz

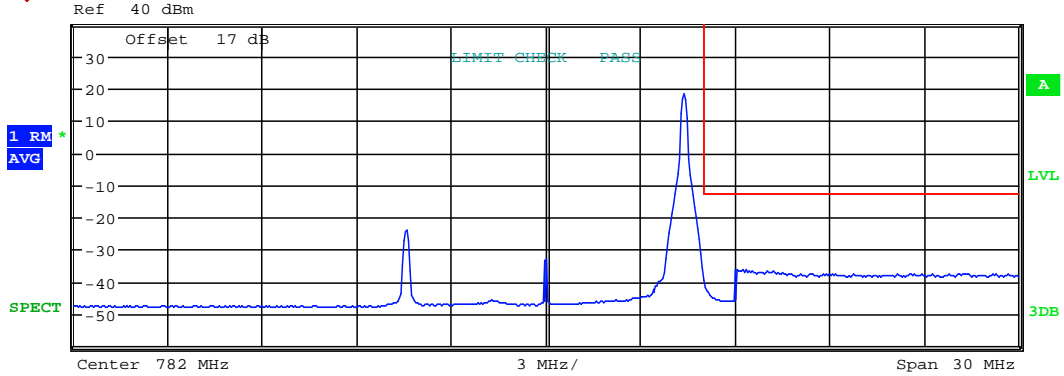

Tx Channel				BW_10_MHz_higher UL		
Bandwidth	10 MHz			Power		
Start [Hz]	Stop [Hz]	RBW [Hz]	Freq [Hz]	PwrAbs [dBm]	PwrRel [dBc]	ΔLimit [dB]
-15.000 M	-5.000 M	100.00 k	776.951923 M	-47.38	-67.64	-347.38
5.000 M	6.000 M	100.00 k	787.000000 M	-36.39	-56.66	-23.39
6.000 M	15.000 M	1.00 M	788.057692 M	-36.22	-56.49	-23.22

Date: 6.AUG.2020 21:18:51



Report Number: W6M22006-20020-P-247  
 FCC ID: GX9CTC1052QT

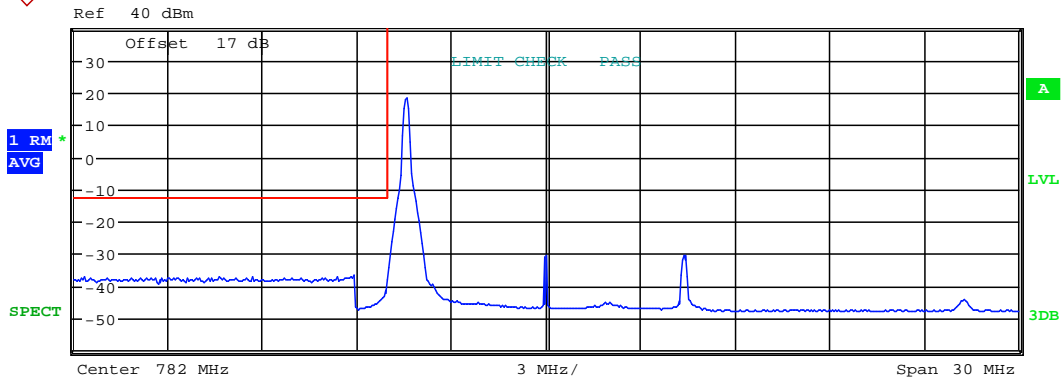

Tx Channel				BW_10_MHz_lower UL		
Bandwidth		10 MHz	Power		20.56 dBm	
Start [Hz]	Stop [Hz]	RBW [Hz]	Freq [Hz]	PwrAbs [dBm]	PwrRel [dBc]	Δ Limit [dB]
-15.000 M	-6.000 M	1.00 M	775.942308 M	-36.92	-57.48	-23.92
-6.000 M	-5.000 M	100.00 k	776.951923 M	-38.08	-58.63	-25.08
5.000 M	15.000 M	100.00 k	795.269231 M	-44.43	-64.99	-344.43

Date: 6.AUG.2020 21:17:59



# Worldwide Testing Services(Taiwan) Co., Ltd.

Report Number: W6M22006-20020-P-247  
 FCC ID: GX9CTC1052QT

QPSK  
 FRB  
 5MHz

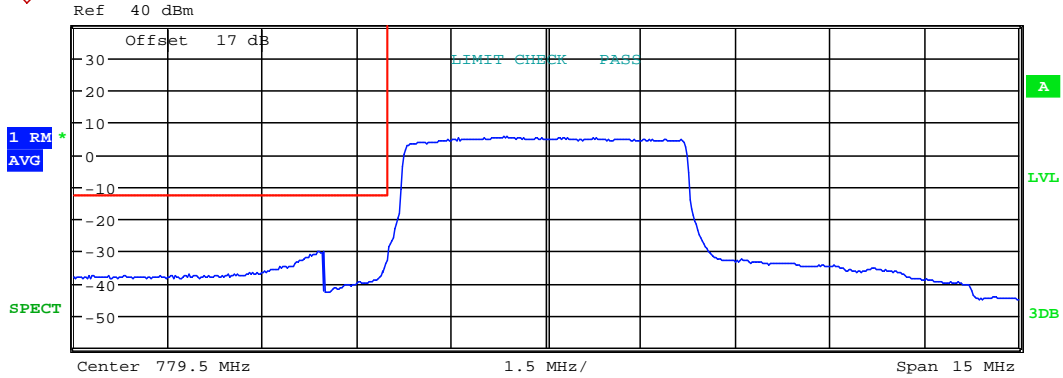

Tx Channel				BW_5_MHz_lower UL		
Bandwidth	5 MHz			Power	20.68 dBm	
Start [Hz]	Stop [Hz]	RBW [Hz]	Freq [Hz]	PwrAbs [dBm]	PwrRel [dBc]	Δ Limit [dB]
-7.500 M	-3.500 M	1.00 M	775.966346 M	-30.13	-50.81	-17.13
-3.500 M	-2.500 M	50.00 k	776.975962 M	-32.94	-53.62	-19.94
2.500 M	7.500 M	100.00 k	782.000000 M	-27.36	-48.04	-327.36

Date: 6.AUG.2020 21:12:43



# Worldwide Testing Services(Taiwan) Co., Ltd.

Report Number: W6M22006-20020-P-247  
 FCC ID: GX9CTC1052QT

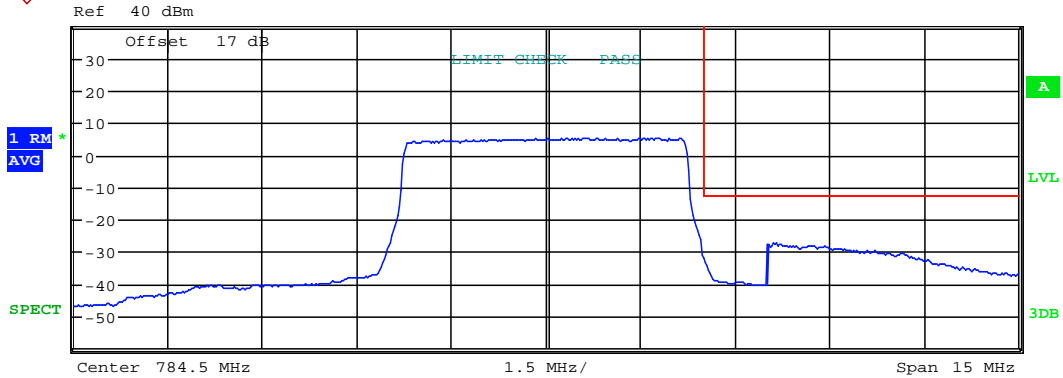

Tx Channel				BW_5_MHz_higher UL		
Bandwidth		5 MHz	Power		20.72 dBm	
Start [Hz]	Stop [Hz]	RBW [Hz]	Freq [Hz]	PwrAbs [dBm]	PwrRel [dBc]	Δ Limit [dB]
-7.500 M	-2.500 M	100.00 k	781.975962 M	-29.17	-49.89	-329.17
2.500 M	3.500 M	50.00 k	787.000000 M	-31.78	-52.50	-18.78
3.500 M	7.500 M	1.00 M	788.105769 M	-27.19	-47.90	-14.19

Date: 6.AUG.2020 21:13:27

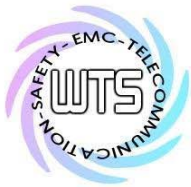

# Worldwide Testing Services(Taiwan) Co., Ltd.

Report Number: W6M22006-20020-P-247

FCC ID: GX9CTC1052QT

10MHz

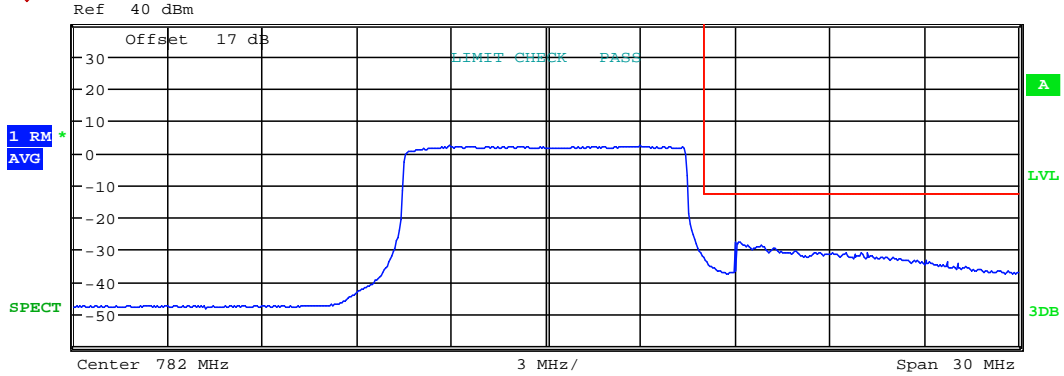

Tx Channel				BW_10_MHz_higher UL		
Bandwidth		10 MHz	Power		20.71 dBm	
Start [Hz]	Stop [Hz]	RBW [Hz]	Freq [Hz]	PwrAbs [dBm]	PwrRel [dBc]	ΔLimit [dB]
-15.000 M	-5.000 M	100.00 k	776.951923 M	-35.16	-55.87	-335.16
5.000 M	6.000 M	100.00 k	787.000000 M	-32.74	-53.45	-19.74
6.000 M	15.000 M	1.00 M	788.105769 M	-27.62	-48.33	-14.62

Date: 6.AUG.2020 21:19:29



# Worldwide Testing Services(Taiwan) Co., Ltd.

Report Number: W6M22006-20020-P-247  
 FCC ID: GX9CTC1052QT

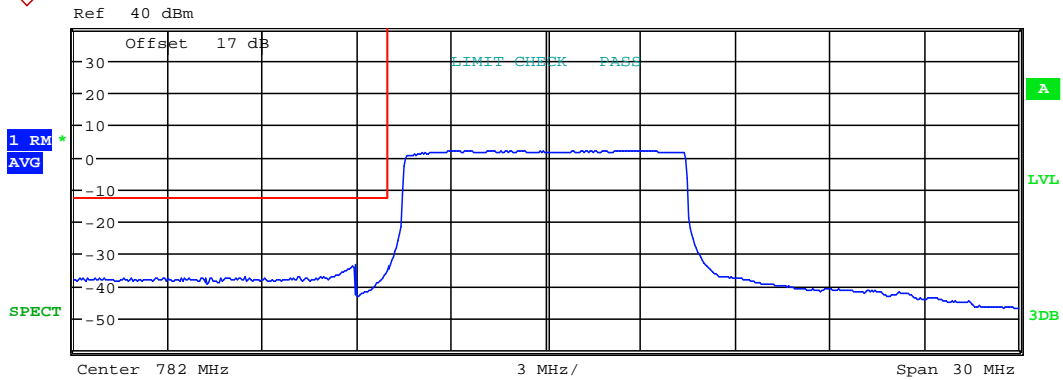

Tx Channel				BW_10_MHz_lower UL		
Bandwidth		10 MHz	Power		20.68 dBm	
Start [Hz]	Stop [Hz]	RBW [Hz]	Freq [Hz]	PwrAbs [dBm]	PwrRel [dBc]	Δ Limit [dB]
-15.000 M	-6.000 M	1.00 M	775.942308 M	-33.65	-54.33	-20.65
-6.000 M	-5.000 M	100.00 k	776.951923 M	-35.20	-55.88	-22.20
5.000 M	15.000 M	100.00 k	787.000000 M	-32.65	-53.33	-332.65

Date: 6.AUG.2020 21:15:50



# Worldwide Testing Services(Taiwan) Co., Ltd.

Report Number: W6M22006-20020-P-247  
 FCC ID: GX9CTC1052QT

1RB  
 5MHz

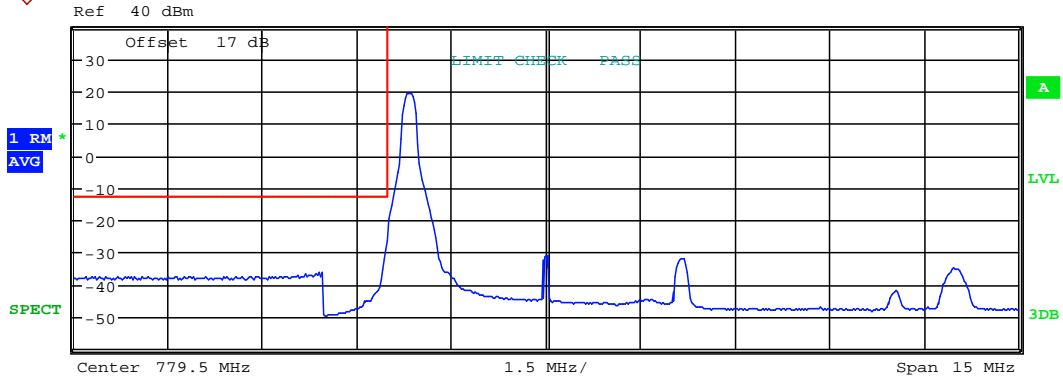

Tx Channel		5 MHz		Power		BW_5_MHz_lower UL	
Start	Stop	RBW	Freq	PwrAbs	PwrRel	ΔLimit	
[Hz]	[Hz]	[Hz]	[Hz]	[dBm]	[dBc]	[dB]	
-7.500 M	-3.500 M	1.00 M	775.942308 M	-36.50	-58.03	-23.50	
-3.500 M	-2.500 M	50.00 k	776.975962 M	-26.18	-47.71	-13.18	
2.500 M	7.500 M	100.00 k	785.966346 M	-34.98	-56.51	-334.98	

Date: 6.AUG.2020 21:12:10





Report Number: W6M22006-20020-P-247  
 FCC ID: GX9CTC1052QT

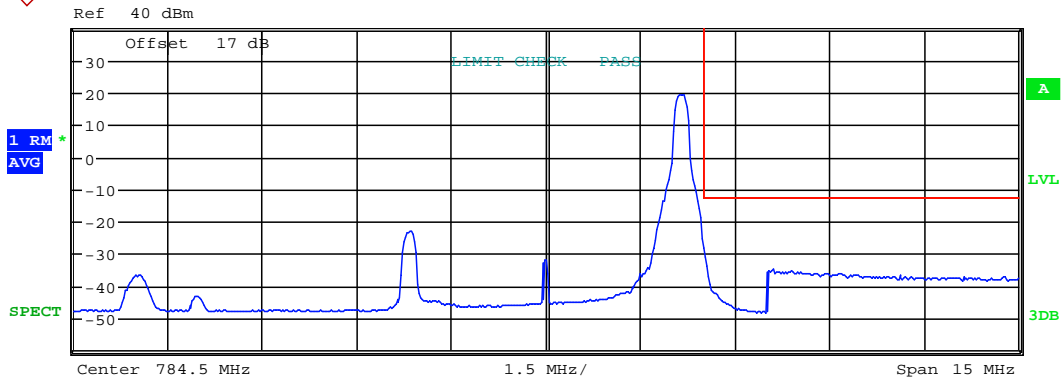

Tx Channel				BW_5_MHz_higher UL		
Bandwidth		5 MHz		Power		21.64 dBm
Start [Hz]	Stop [Hz]	RBW [Hz]	Freq [Hz]	PwrAbs [dBm]	PwrRel [dBc]	Δ Limit [dB]
-7.500 M	-2.500 M	100.00 k	778.033654 M	-36.56	-58.20	-336.56
2.500 M	3.500 M	50.00 k	787.000000 M	-25.97	-47.61	-12.97
3.500 M	7.500 M	1.00 M	788.105769 M	-35.08	-56.72	-22.08

Date: 6.AUG.2020 21:13:51



# Worldwide Testing Services(Taiwan) Co., Ltd.

Report Number: W6M22006-20020-P-247

FCC ID: GX9CTC1052QT

10MHz

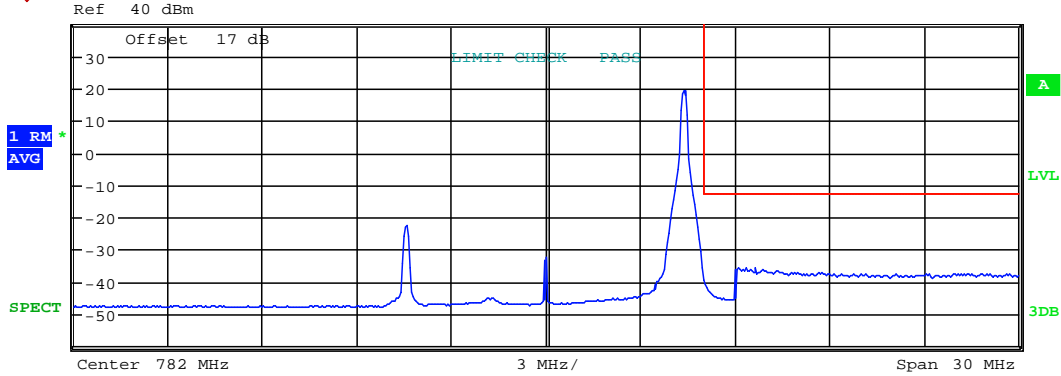

Tx Channel				BW_10_MHz_higher UL		
Bandwidth		10 MHz		Power		21.59 dBm
Start [Hz]	Stop [Hz]	RBW [Hz]	Freq [Hz]	PwrAbs [dBm]	PwrRel [dBc]	ΔLimit [dB]
-15.000 M	-5.000 M	100.00 k	776.951923 M	-47.32	-68.92	-347.32
5.000 M	6.000 M	100.00 k	787.000000 M	-36.17	-57.77	-23.17
6.000 M	15.000 M	1.00 M	788.634615 M	-35.91	-57.50	-22.91

Date: 6.AUG.2020 21:19:12



Report Number: W6M22006-20020-P-247  
 FCC ID: GX9CTC1052QT

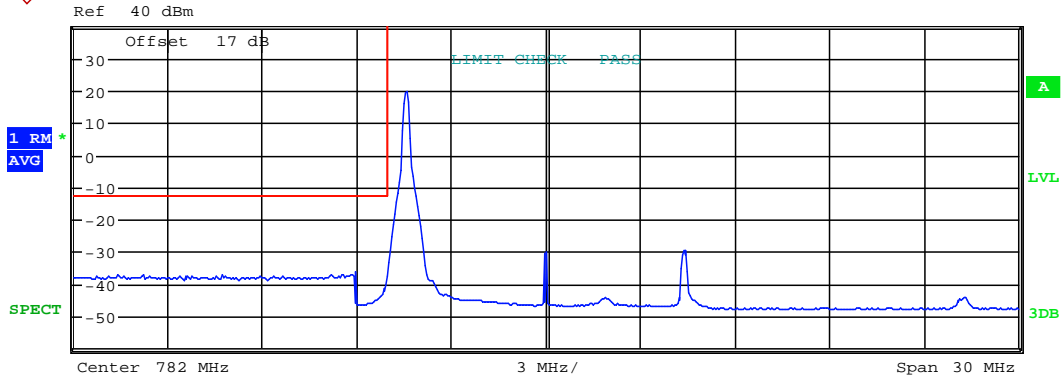

Tx Channel				BW_10_MHz_lower UL		
Bandwidth		10 MHz	Power		21.73 dBm	
Start	Stop	RBW	Freq	PwrAbs	PwrRel	Δ Limit
[Hz]	[Hz]	[Hz]	[Hz]	[dBm]	[dBc]	[dB]
-15.000 M	-6.000 M	1.00 M	775.942308 M	-36.55	-58.28	-23.55
-6.000 M	-5.000 M	100.00 k	776.951923 M	-37.80	-59.53	-24.80
5.000 M	15.000 M	100.00 k	795.317308 M	-44.46	-66.19	-344.46

Date: 6.AUG.2020 21:17:40

Test equipment: ETSTW-RE 055, ETSTW-GSM 002, ETSTW-GSM 023, ETSTW-GSM 004

Report Number: W6M22006-20020-P-247

FCC ID: GX9CTC1052QT

## 9. Frequency Stability

The frequency stability shall be measured by variation of ambient temperature and variation of primary supply voltage to ensure that the fundamental emission stays within the authorized frequency block. The frequency stability of the transmitter shall be maintain within  $\pm 0.00025\%$  ( $\pm 2.5$  ppm) of the center frequency.

### 9.1 Test procedure

- The equipment under test was supplied with rated power supply and the RF output was connected to a frequency counter via feed through attenuators. The EUT was placed inside the temperature chamber. The DC leads and RF output cable, exited the chamber through an opening made for that purpose.  
After the temperature stabilized the frequency output was recorded from the counter.
- An external variable power supply was used to supply nominal voltage and 85% to 115% of nominal voltage to the EUT under room temperature. Record the frequencies measured from the counter.
- End point voltage: For hand carried, battery powered equipment, reduce primary supply voltage to the battery operating end point which shall be specified by the manufacturer. Then record the frequencies measured from the counter.

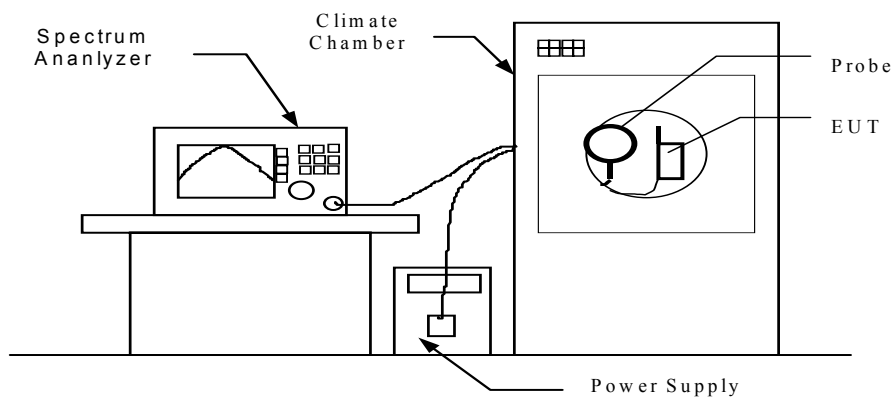

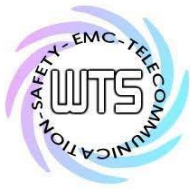

Report Number: W6M22006-20020-P-247

FCC ID: GX9CTC1052QT

**9.2 Test Results**

**9.2.1 Frequency Stability vs. Temperature**

Test date: August 13, 2020

Temperature: 24.5 °C

Humidity: 48.6 %

Tester: Kent

WCDMA BAND II					WCDMA BAND IV				
CH9262	Temp	Frequency drift(Hz)	Frequency drift(ppm)	Limit (ppm)	CH1312	Temp	Frequency drift(Hz)	Frequency drift(ppm)	Limit (ppm)
	-30	11.13	0.006	±2.5		-30	10.22	0.006	±2.5
	-20	-8.33	-0.004			-20	-8.96	-0.005	
	-10	6.55	0.004			-10	6.55	0.004	
	0	-7.43	-0.004			0	5.98	0.003	
	10	3.42	0.002			10	2.93	0.002	
	20	-1.92	-0.001			20	-5.13	-0.003	
	30	4.73	0.003			30	3.99	0.002	
	40	6.51	0.004			40	-4.55	-0.003	
	50	-8.33	-0.004			50	-6.39	-0.004	
132Vac	25	-3.35	-0.002	132Vac	25	-4.25	-0.002		
108Vac	25	-3.74	-0.002	108Vac	25	-1.52	-0.001		
CH9400	Temp	Frequency drift(Hz)	Frequency drift(ppm)	Limit (ppm)	CH1412	Temp	Frequency drift(Hz)	Frequency drift(ppm)	Limit (ppm)
	-30	-9.55	-0.005	±2.5		-30	-10.13	-0.006	±2.5
	-20	8.41	0.004			-20	8.95	0.005	
	-10	8.44	0.004			-10	-7.44	-0.004	
	0	-6.41	-0.003			0	-7.48	-0.004	
	10	-1.31	-0.001			10	5.35	0.003	
	20	2.55	0.001			20	-2.05	-0.001	
	30	4.85	0.003			30	-5.31	-0.003	
	40	-3.04	-0.002			40	-6.15	-0.004	
	50	7.63	0.004			50	7.12	0.004	
132Vac	25	-5.71	-0.003	132Vac	25	-4.07	-0.002		
108Vac	25	-4.28	-0.002	108Vac	25	-4.16	-0.002		
CH9538	Temp	Frequency drift(Hz)	Frequency drift(ppm)	Limit (ppm)	CH1513	Temp	Frequency drift(Hz)	Frequency drift(ppm)	Limit (ppm)
	-30	-9.75	-0.005	±2.5		-30	7.41	0.004	±2.5
	-20	4.43	0.002			-20	8.55	0.005	
	-10	6.18	0.003			-10	6.73	0.004	
	0	-5.29	-0.003			0	-7.42	-0.004	
	10	5.29	0.003			10	5.73	0.003	
	20	-4.32	-0.002			20	-3.16	-0.002	
	30	4.66	0.002			30	3.55	0.002	
	40	5.31	0.003			40	-4.82	-0.003	
	50	-5.98	-0.003			50	6.61	0.004	
132Vac	25	-3.55	-0.002	132Vac	25	-3.93	-0.002		
108Vac	25	-3.60	-0.002	108Vac	25	-3.97	-0.002		



Report Number: W6M22006-20020-P-247

FCC ID: GX9CTC1052QT

WCDMA BAND V				
CH4132	Temp	Frequency drift(Hz)	Frequency drift(ppm)	Limit (ppm)
	-30	-11.23	-0.014	±2.5
	-20	9.33	0.011	
	-10	7.54	0.009	
	0	-8.43	-0.010	
	10	-4.93	-0.006	
	20	3.13	0.004	
	30	5.49	0.007	
	40	-6.11	-0.007	
	50	7.19	0.009	
132Vac	25	1.42	0.002	
108Vac	25	-2.33	-0.003	
CH4183	Temp	Frequency drift(Hz)	Frequency drift(ppm)	Limit (ppm)
	-30	9.14	0.011	±2.5
	-20	-5.77	-0.007	
	-10	-6.39	-0.008	
	0	-7.43	-0.009	
	10	-3.75	-0.004	
	20	4.74	0.006	
	30	4.65	0.006	
	40	5.22	0.006	
	50	7.88	0.009	
132Vac	25	2.93	0.004	
108Vac	25	-5.51	-0.007	
CH4233	Temp	Frequency drift(Hz)	Frequency drift(ppm)	Limit (ppm)
	-30	-9.93	-0.012	±2.5
	-20	-7.78	-0.009	
	-10	8.63	0.010	
	0	-6.16	-0.007	
	10	5.74	0.007	
	20	2.74	0.003	
	30	5.31	0.006	
	40	6.21	0.007	
	50	8.21	0.010	
132Vac	25	-3.33	-0.004	
108Vac	25	-2.87	-0.003	



# Worldwide Testing Services(Taiwan) Co., Ltd.

Report Number: W6M22006-20020-P-247

FCC ID: GX9CTC1052QT

LTE BAND II QPSK 10MHz FRB					LTE BAND IV QPSK 10MHz FRB				
CH18900	Temp	Frequency drift(Hz)	Frequency drift(ppm)	Limit (ppm)	CH20175	Temp	Frequency drift(Hz)	Frequency drift(ppm)	Limit (ppm)
	-30	-11.43	-0.006	±2.5		-30	9.95	0.006	±2.5
	-20	7.48	0.004			-20	-3.98	-0.002	
	-10	-8.93	-0.005			-10	-7.41	-0.004	
	0	-9.21	-0.005			0	-8.92	-0.005	
	10	-8.74	-0.005			10	7.06	0.004	
	20	-5.04	-0.003			20	-2.29	-0.001	
	30	6.89	0.004			30	-3.41	-0.002	
	40	-8.44	-0.004			40	7.45	0.004	
	50	8.56	0.005			50	9.87	0.006	
132Vac	25	-6.51	-0.003	132Vac	25	2.86	0.002		
108Vac	25	-5.58	-0.003	108Vac	25	-3.02	-0.002		

LTE BAND V QPSK 10MHz FRB					LTE BAND XII QPSK 10MHz FRB				
CH20525	Temp	Frequency drift(Hz)	Frequency drift(ppm)	Limit (ppm)	CH23095	Temp	Frequency drift(Hz)	Frequency drift(ppm)	Limit (ppm)
	-30	9.12	0.011	±2.5		-30	8.99	0.013	±2.5
	-20	-8.79	-0.011			-20	-7.41	-0.010	
	-10	5.99	0.007			-10	-5.14	-0.007	
	0	-8.21	-0.010			0	-6.88	-0.010	
	10	7.18	0.009			10	5.48	0.008	
	20	1.85	0.002			20	-2.66	-0.004	
	30	7.44	0.009			30	-4.56	-0.006	
	40	6.35	0.008			40	6.55	0.009	
	50	8.98	0.011			50	7.98	0.011	
132Vac	25	-2.31	-0.003	132Vac	25	-2.03	-0.003		
108Vac	25	-2.55	-0.003	108Vac	25	-2.73	-0.004		

LTE BAND XIII QPSK 10MHz FRB				
CH23230	Temp	Frequency drift(Hz)	Frequency drift(ppm)	Limit (ppm)
	-30	-10.31	-0.013	±2.5
	-20	-8.44	-0.011	
	-10	5.89	0.008	
	0	7.40	0.009	
	10	-6.84	-0.009	
	20	-2.60	-0.003	
	30	7.44	0.010	
	40	-8.66	-0.011	
	50	11.85	0.015	
132Vac	25	1.30	0.002	
108Vac	25	2.70	0.003	

Test equipment: ETSTW-CE 009, ETSTW-GSM 002, ETSTW-GSM 004



Report Number: W6M22006-20020-P-247

FCC ID: GX9CTC1052QT

**10 Maximum Permissible Exposure**

**10.1 Exemption Limits for Routine Evaluation according to 47 CFR FCC Part 2 Subpart J, section 2.1091**

FCC OET Bulletin 65 Edition 97.01 determines the equations for predicting RF fields and applicable limits.

The prediction for power density in the far-field but will over-predict power density in the near field, where it could be used for walking a “worst case” or conservative prediction.

Systems operating under the provisions of this section shall be operated in a manner that ensures that the public is not exposed to radio frequency energy levels in excess limit for maximum permissible exposure. In accordance with 47 CFR FCC Part 2 Subpart J, section 2.1091 this device has been defined as a mobile device whereby a distance of 20 cm normally can be maintained between the user and the device.

**MPE Calculation Method**

**(A) Limits for Occupational/Controlled Exposure**

Frequency Range (MHz)	Electric Field Strength (E) (V/m)	Magnetic Field Strength (H) (A/m)	Power Density (S) (mW/cm <sup>2</sup> )	Averaging Time  E  <sup>2</sup> ,  H  <sup>2</sup> or S (minutes)
0.3-3.0	614	1.63	(100)*	6
3.0-30	1842/f	4.89/f	(900/f <sup>2</sup> )*	6
30-300	61.4	0.163	1.0	6
300-1500	--	--	f/300	6
1500-100,000	--	--	5	6

**(B) Limits for General Population/Uncontrolled Exposure**

Frequency Range (MHz)	Electric Field Strength (E) (V/m)	Magnetic Field Strength (H) (A/m)	Power Density (S) (mW/cm <sup>2</sup> )	Averaging Time  E  <sup>2</sup> ,  H  <sup>2</sup> or S (minutes)
0.3-1.34	614	1.63	(100)*	30
1.34-30	824/f	2.19/f	(180/f <sup>2</sup> )*	30
30-300	27.5	0.073	0.2	30
300-1500	--	--	f/1500	30
1500-100,000	--	--	1.0	30

f = frequency in MHz

\*Plane-wave equivalent power density

E = Electric field (V/m) P = output power (W) G = EUT Antenna numeric gain (numeric)

d = Separation distance between radiator and human body (m)

$$Pd = \frac{30 \times P \times G}{377 \times d^2}$$

The formula can be changed to mW/cm<sup>2</sup>.



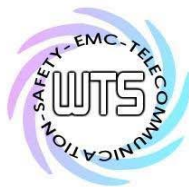

# Worldwide Testing Services(Taiwan) Co., Ltd.

Report Number: W6M22006-20020-P-247

FCC ID: GX9CTC1052QT

Frequency	Max output power		Antenna Gain	Power Density(S) (mW/cm <sup>2</sup> )	Limit of Power Density (S) (mW/cm <sup>2</sup> )	Test Result
	(dBm)	(W)				
WCDMA Band II	22.57	0.18	3.21	0.0753	1	Complies
WCDMA Band IV	22.74	0.19	2.67	0.0691	1	Complies
WCDMA Band V	23.64	0.23	-0.13	0.0446	0.5644	Complies
LTE Band II	23.35	0.22	3.21	0.0901	1	Complies
LTE Band IV	23.15	0.21	2.67	0.0760	1	Complies
LTE Band V	23.81	0.24	-0.13	0.0464	0.5577	Complies
LTE Band XII	23.46	0.22	1.58	0.0635	0.4740	Complies
LTE Band XIII	23.66	0.23	0.85	0.0562	0.5213	Complies

From the peak EUT RF output power, the minimum mobile separation distance,  $d=0.2$  m, as well as the gain of the used antenna, the RF power density can be obtained.