

# FCC Test Report

**Applicant** : ACCO Brands, Inc.

**Address** : 4 Corporate Drive, Lake Zurich, Illinois 60047,  
USA

**Product Name** : Pro Fit® Ergo MY630 EQ Rechargeable Mouse

**Report Date** : May 15, 2024



**Shenzhen Anbotek Compliance Laboratory Limited**

**Shenzhen Anbotek Compliance Laboratory Limited**

Address: 1/F., Building D, Sogood Science and Technology Park, Sanwei Community,  
Hangcheng Street, Bao'an District, Shenzhen, Guangdong, China.  
Tel: (86)0755-26066440 Fax: (86)0755-26014772 Email: service@anbotek.com



Hotline  
400-003-0500  
www.anbotek.com.cn



# Contents

1. General Information .....	6
1.1. Client Information .....	6
1.2. Description of Device (EUT) .....	6
1.3. Auxiliary Equipment Used During Test .....	7
1.4. Operation channel list .....	7
1.5. Description of Test Modes .....	7
1.6. Measurement Uncertainty .....	8
1.7. Test Summary .....	8
1.8. Description of Test Facility .....	9
1.9. Disclaimer .....	9
1.10. Test Equipment List .....	10
2. Antenna requirement .....	12
2.1. Conclusion .....	12
3. Conducted Emission at AC power line .....	13
3.1. EUT Operation .....	13
3.2. Test Setup .....	13
3.3. Test Data .....	14
4. Occupied Bandwidth .....	16
4.1. EUT Operation .....	16
4.2. Test Setup .....	16
4.3. Test Data .....	16
5. Maximum Conducted Output Power .....	17
5.1. EUT Operation .....	17
5.2. Test Setup .....	17
5.3. Test Data .....	17
6. Power Spectral Density .....	18
6.1. EUT Operation .....	18
6.2. Test Setup .....	18
6.3. Test Data .....	18
7. Emissions in non-restricted frequency bands .....	19
7.1. EUT Operation .....	19
7.2. Test Setup .....	19
7.3. Test Data .....	19
8. Band edge emissions (Radiated) .....	20
8.1. EUT Operation .....	20
8.2. Test Setup .....	20
8.3. Test Data .....	21
9. Emissions in frequency bands (below 1GHz) .....	22
9.1. EUT Operation .....	22
9.2. Test Setup .....	23
9.3. Test Data .....	24

**Shenzhen Anbotek Compliance Laboratory Limited**

Address: 1/F., Building D, Sogood Science and Technology Park, Sanwei Community, Hangcheng Street, Bao'an District, Shenzhen, Guangdong, China.  
Tel: (86)0755-26066440 Fax: (86)0755-26014772 Email: service@anbotek.com



Hotline  
400-003-0500  
www.anbotek.com.cn



10. Emissions in frequency bands (above 1GHz)	26
10.1. EUT Operation	26
10.2. Test Setup	26
10.3. Test Data	27
APPENDIX I -- TEST SETUP PHOTOGRAPH	30
APPENDIX II -- EXTERNAL PHOTOGRAPH	30
APPENDIX III -- INTERNAL PHOTOGRAPH	30

### Shenzhen Anbotek Compliance Laboratory Limited

Address: 1/F., Building D, Sogood Science and Technology Park, Sanwei Community, Hangcheng Street, Bao'an District, Shenzhen, Guangdong, China.  
Tel: (86)0755-26066440 Fax: (86)0755-26014772 Email: service@anbotek.com



Hotline  
400-003-0500  
www.anbotek.com.cn



Report No.: 18220WC40055401

FCC ID: GV3M01708-M

Page 4 of 30

# TEST REPORT

Applicant : ACCO Brands, Inc.  
Manufacturer : ACCO Brands, Inc.  
Product Name : Pro Fit® Ergo MY630 EQ Rechargeable Mouse  
Test Model No. : M01708-M  
Reference Model No. : N/A  
Trade Mark : Kensington  
Rating(s) : Input: 5V $\overline{=}$  300mA  
Battery Capacity: DC 3.7V, 500mAh

Test Standard(s) : **47 CFR Part 15.247**  
**ANSI C63.10-2020**  
**KDB 558074 D01 15.247 Meas Guidance v05r02**

The device described above is tested by Shenzhen Anbotek Compliance Laboratory Limited to determine the maximum emission levels emanating from the device and the severe levels of the device can endure and its performance criterion. The measurement results are contained in this test report and Shenzhen Anbotek Compliance Laboratory Limited is assumed full of responsibility for the accuracy and completeness of these measurements. Also, this report shows that the EUT (Equipment Under Test) is technically compliant with above listed standard(s) requirements. This report applies to above tested sample only and shall not be reproduced in part without written approval of Shenzhen Anbotek Compliance Laboratory Limited.

Date of Receipt:

Mar. 25, 2024

Date of Test:

Mar. 25, 2024 to Apr. 15, 2024

Prepared By



(Nianxiu Chen)

Approved &amp; Authorized Signer



(Edward Pan)

## Shenzhen Anbotek Compliance Laboratory Limited

Address: 1/F., Building D, Sogood Science and Technology Park, Sanwei Community,  
Hangcheng Street, Bao'an District, Shenzhen, Guangdong, China.  
Tel: (86)0755-26066440 Fax: (86)0755-26014772 Email: service@anbotek.com



Hotline  
400-003-0500  
www.anbotek.com.cn



**Revision History**

Report Version	Description	Issued Date
R00	Original Issue.	May 15, 2024

**Shenzhen Anbotek Compliance Laboratory Limited**

Address: 1/F., Building D, Sogood Science and Technology Park, Sanwei Community, Hangcheng Street, Bao'an District, Shenzhen, Guangdong, China.  
Tel: (86)0755-26066440 Fax: (86)0755-26014772 Email: service@anbotek.com



Hotline  
400-003-0500  
www.anbotek.com.cn



## 1. General Information

### 1.1. Client Information

Applicant	:	ACCO Brands, Inc.
Address	:	4 Corporate Drive, Lake Zurich, Illinois 60047, USA
Manufacturer	:	ACCO Brands, Inc.
Address	:	4 Corporate Drive, Lake Zurich, Illinois 60047, USA

### 1.2. Description of Device (EUT)

Product Name	:	Pro Fit® Ergo MY630 EQ Rechargeable Mouse
Test Model No.	:	M01708-M
Reference Model No.	:	N/A
Trade Mark	:	Kensington
Test Power Supply	:	DC 5V from Adapter input AC 120V/60Hz; DC 3.7V battery inside
Test Sample No.	:	1-2-1(Normal Sample), 1-2-2(Engineering Sample)
Adapter	:	N/A

#### RF Specification

Operation Frequency	:	2402MHz to 2480MHz
Number of Channel	:	40
Modulation Type	:	GFSK
Antenna Type	:	PCB Antenna
Antenna Gain(Peak)	:	-2.81dBi

#### Remark:

- (1) All of the RF specification are provided by customer.
- (2) For a more detailed features description, please refer to the manufacturer's specifications or the User's Manual.



### 1.3. Auxiliary Equipment Used During Test

Title	Manufacturer	Model No.	Serial No.
Xiaomi 33W adapter	Xiaomi	MDY-11-EX	SA62212LA04358J

### 1.4. Operation channel list

Operation Band:

Channel	Frequency (MHz)	Channel	Frequency (MHz)	Channel	Frequency (MHz)	Channel	Frequency (MHz)
0	2402	10	2422	20	2442	30	2462
1	2404	11	2424	21	2444	31	2464
2	2406	12	2426	22	2446	32	2466
3	2408	13	2428	23	2448	33	2468
4	2410	14	2430	24	2450	34	2470
5	2412	15	2432	25	2452	35	2472
6	2414	16	2434	26	2454	36	2474
7	2416	17	2436	27	2456	37	2476
8	2418	18	2438	28	2458	38	2478
9	2420	19	2440	29	2460	39	2480

### 1.5. Description of Test Modes

Pretest Modes	Descriptions
TM1	Keep the EUT in continuously transmitting mode with GFSK modulation.

#### Shenzhen Anbotek Compliance Laboratory Limited

Address: 1/F., Building D, Sogood Science and Technology Park, Sanwei Community, Hangcheng Street, Bao'an District, Shenzhen, Guangdong, China.  
Tel: (86)0755-26066440 Fax: (86)0755-26014772 Email: service@anbotek.com



Hotline  
400-003-0500  
www.anbotek.com.cn



## 1.6. Measurement Uncertainty

Parameter	Uncertainty
Conducted emissions (AMN 150kHz~30MHz)	3.4dB
Occupied Bandwidth	925Hz
Conducted Output Power	0.76dB
Power Spectral Density	0.76dB
Conducted Spurious Emission	1.24dB
Radiated spurious emissions (above 1GHz)	1G-6GHz: 4.78dB; 6G-18GHz: 4.88dB 18G-40GHz: 5.68dB
Radiated emissions (Below 30MHz)	3.53dB
Radiated spurious emissions (30MHz~1GHz)	Horizontal: 3.92dB; Vertical: 4.52dB
The measurement uncertainty and decision risk evaluated according to AB/WI-RF-F-032. This uncertainty represents an expanded uncertainty expressed at approximately the 95% confidence level using a coverage factor of k=2.	

## 1.7. Test Summary

Test Items	Test Modes	Status
Antenna requirement	/	P
Conducted Emission at AC power line	Mode1	P
Occupied Bandwidth	Mode1	P
Maximum Conducted Output Power	Mode1	P
Power Spectral Density	Mode1	P
Emissions in non-restricted frequency bands	Mode1	P
Band edge emissions (Radiated)	Mode1	P
Emissions in frequency bands (below 1GHz)	Mode1	P
Emissions in frequency bands (above 1GHz)	Mode1	P
Note: P: Pass N: N/A, not applicable		

### Shenzhen Anbotek Compliance Laboratory Limited

Address: 1/F., Building D, Sogood Science and Technology Park, Sanwei Community, Hangcheng Street, Bao'an District, Shenzhen, Guangdong, China.  
Tel: (86)0755-26066440 Fax: (86)0755-26014772 Email: service@anbotek.com



Hotline  
400-003-0500  
www.anbotek.com.cn





## 1.8. Description of Test Facility

The test facility is recognized, certified, or accredited by the following organizations:

### FCC-Registration No.: 434132

Shenzhen Anbotek Compliance Laboratory Limited, EMC Laboratory has been registered and fully described in a report filed with the (FCC) Federal Communications Commission. The acceptance letter from the FCC is maintained in our files. Registration No. 434132.

### ISED-Registration No.: 8058A

Shenzhen Anbotek Compliance Laboratory Limited, EMC Laboratory has been registered and fully described in a report filed with the (ISED) Innovation, Science and Economic Development Canada. The acceptance letter from the ISED is maintained in our files. Registration 8058A.

### Test Location

Shenzhen Anbotek Compliance Laboratory Limited.

1/F, Building D, Sogood Science and Technology Park, Sanwei community, Hangcheng Street, Bao'an District, Shenzhen, Guangdong, China.

## 1.9. Disclaimer

1. The test report is invalid if not marked with the signatures of the persons responsible for preparing and approving the test report.
2. The test report is invalid if there is any evidence and/or falsification.
3. The results documented in this report apply only to the tested sample, under the conditions and modes of operation as described herein.
4. This document may not be altered or revised in any way unless done so by Anbotek and all revisions are duly noted in the revisions section.
5. Content of the test report, in part or in full, cannot be used for publicity and/or promotional purposes without prior written approval from the laboratory.
6. The authenticity of the information provided by the customer is the responsibility of the customer and the laboratory is not responsible for its authenticity.

The laboratory is only responsible for the data released by the laboratory, except for the part provided by the applicant.

### Shenzhen Anbotek Compliance Laboratory Limited

Address: 1/F., Building D, Sogood Science and Technology Park, Sanwei Community, Hangcheng Street, Bao'an District, Shenzhen, Guangdong, China.  
Tel: (86)0755-26066440 Fax: (86)0755-26014772 Email: service@anbotek.com



Hotline  
400-003-0500  
www.anbotek.com.cn



**1.10. Test Equipment List**

Conducted Emission at AC power line						
Item	Equipment	Manufacturer	Model No.	Serial No.	Last Cal.	Cal.Due Date
1	L.I.S.N. Artificial Mains Network	Rohde & Schwarz	ENV216	100055	2024-01-18	2025-01-17
2	Three Phase V-type Artificial Power Network	CYBERTEK	EM5040DT	E215040D T001	2024-01-17	2025-01-16
3	Software Name EZ-EMC	Farad Technology	ANB-03A	N/A	/	/
4	EMI Test Receiver	Rohde & Schwarz	ESPI3	100926	2023-10-12	2024-10-11

Emissions in non-restricted frequency bands						
Occupied Bandwidth						
Maximum Conducted Output Power						
Power Spectral Density						
Item	Equipment	Manufacturer	Model No.	Serial No.	Last Cal.	Cal.Due Date
1	Constant Temperature Humidity Chamber	ZHONGJIAN	ZJ-KHWS80B	N/A	2023-10-16	2024-10-15
2	DC Power Supply	IVYTECH	IV3605	1804D360 510	2023-10-20	2024-10-19
3	Spectrum Analyzer	Rohde & Schwarz	FSV40-N	101792	2023-05-26	2024-05-25
4	MXA Spectrum Analysis	KEYSIGHT	N9020A	MY505318 23	2023-10-12	2024-10-11
5	Oscilloscope	Tektronix	MDO3012	C020298	2023-10-12	2024-10-11
6	MXG RF Vector Signal Generator	Agilent	N5182A	MY474206 47	2024-02-04	2025-02-03

**Shenzhen Anbotek Compliance Laboratory Limited**

Address: 1/F., Building D, Sogood Science and Technology Park, Sanwei Community, Hangcheng Street, Bao'an District, Shenzhen, Guangdong, China.  
 Tel: (86)0755-26066440 Fax: (86)0755-26014772 Email: service@anbotek.com



Hotline  
400-003-0500  
www.anbotek.com.cn



Band edge emissions (Radiated) Emissions in frequency bands (above 1GHz)						
Item	Equipment	Manufacturer	Model No.	Serial No.	Last Cal.	Cal.Due Date
1	EMI Test Receiver	Rohde & Schwarz	ESR26	101481	2024-01-23	2025-01-22
2	EMI Preamplifier	SKET Electronic	LNPA-0118G-45	SKET-PA-002	2024-01-17	2025-01-16
3	Double Ridged Horn Antenna	SCHWARZBECK	BBHA 9120D	02555	2022-10-16	2025-10-15
4	EMI Test Software EZ-EMC	SHURPLE	N/A	N/A	/	/
5	Horn Antenna	A-INFO	LB-180400-KF	J211060628	2023-10-12	2024-10-11
6	Spectrum Analyzer	Rohde & Schwarz	FSV40-N	101792	2023-05-26	2024-05-25
7	Amplifier	Talent Microwave	TLLA18G40 G-50-30	23022802	2023-05-25	2024-05-24

Emissions in frequency bands (below 1GHz)						
Item	Equipment	Manufacturer	Model No.	Serial No.	Last Cal.	Cal.Due Date
1	EMI Test Receiver	Rohde & Schwarz	ESR26	101481	2024-01-23	2025-01-22
2	Pre-amplifier	SONOMA	310N	186860	2024-01-17	2025-01-16
3	Bilog Broadband Antenna	Schwarzbeck	VULB9163	345	2022-10-23	2025-10-22
4	Loop Antenna (9K-30M)	Schwarzbeck	FMZB1519 B	00053	2023-10-12	2024-10-11
5	EMI Test Software EZ-EMC	SHURPLE	N/A	N/A	/	/

**Shenzhen Anbotek Compliance Laboratory Limited**

Address: 1/F., Building D, Sogood Science and Technology Park, Sanwei Community, Hangcheng Street, Bao'an District, Shenzhen, Guangdong, China.  
 Tel: (86)0755-26066440 Fax: (86)0755-26014772 Email: service@anbotek.com



Hotline  
 400-003-0500  
[www.anbotek.com.cn](http://www.anbotek.com.cn)



## 2. Antenna requirement

**Test Requirement:**

Refer to 47 CFR Part 15.203, an intentional radiator shall be designed to ensure that no antenna other than that furnished by the responsible party shall be used with the device. The use of a permanently attached antenna or of an antenna that uses a unique coupling to the intentional radiator shall be considered sufficient to comply with the provisions of this section.

### 2.1. Conclusion

The antenna is a **PCB Antenna** which permanently attached, and the best case gain of the antenna is **-2.81 dBi**. It complies with the standard requirement.

#### Shenzhen Anbotek Compliance Laboratory Limited

Address: 1/F., Building D, Sogood Science and Technology Park, Sanwei Community, Hangcheng Street, Bao'an District, Shenzhen, Guangdong, China.  
Tel: (86)0755-26066440 Fax: (86)0755-26014772 Email: service@anbotek.com



Hotline  
400-003-0500  
www.anbotek.com.cn



### 3. Conducted Emission at AC power line

Test Requirement:	Refer to 47 CFR 15.207(a), Except as shown in paragraphs (b) and (c) of this section, for an intentional radiator that is designed to be connected to the public utility (AC) power line, the radio frequency voltage that is conducted back onto the AC power line on any frequency or frequencies, within the band 150 kHz to 30 MHz, shall not exceed the limits in the following table, as measured using a 50 $\mu$ H/50 ohms line impedance stabilization network (LISN).		
Test Limit:	Frequency of emission (MHz)	Conducted limit (dB $\mu$ V)	
		Quasi-peak	Average
	0.15-0.5	66 to 56*	56 to 46*
	0.5-5	56	46
	5-30	60	50
	*Decreases with the logarithm of the frequency.		
Test Method:	ANSI C63.10-2020 section 6.2		
Procedure:	Refer to ANSI C63.10-2020 section 6.2, standard test method for ac power-line conducted emissions from unlicensed wireless devices		

#### 3.1. EUT Operation

Operating Environment:	
Test mode:	1: TX mode: Keep the EUT in continuously transmitting mode with GFSK modulation.

#### 3.2. Test Setup

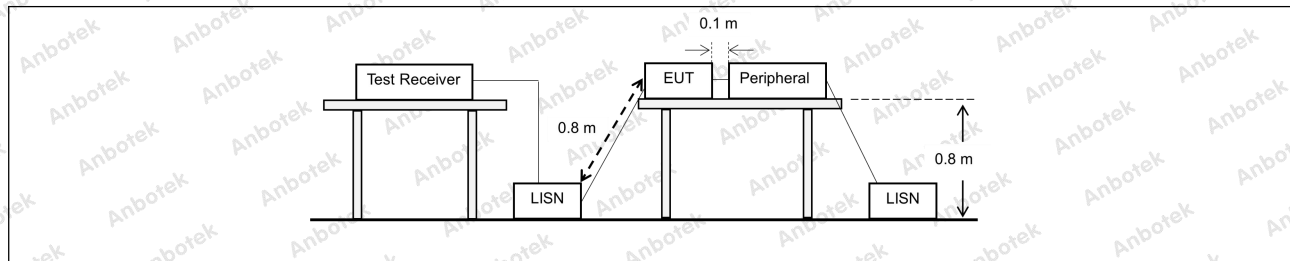

### 3.3. Test Data

Temperature:	25.1 °C	Humidity:	67 %	Atmospheric Pressure:	101 kPa
--------------	---------	-----------	------	-----------------------	---------

TM1 / Line: Line / Band: 2400-2483.5 MHz / BW: 1 / CH: M

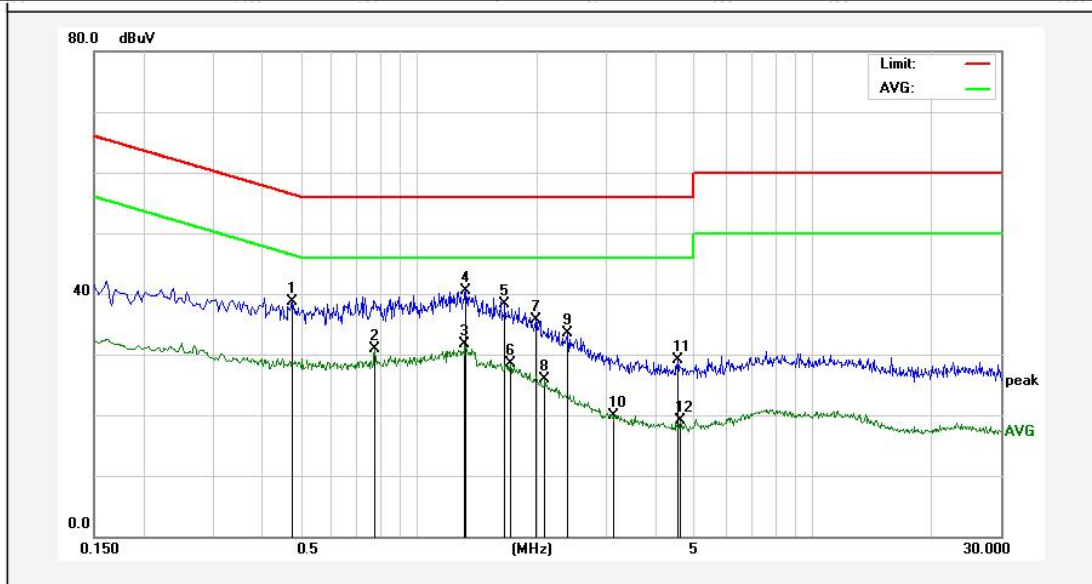

No.	Freq. (MHz)	Reading (dBuV)	Factor (dB)	Result (dBuV)	Limit (dBuV)	Over Limit (dB)	Detector	Remark
1	0.4780	20.93	17.84	38.77	56.37	-17.60	QP	
2	0.7780	12.96	17.86	30.82	46.00	-15.18	AVG	
3	1.3140	13.80	17.84	31.64	46.00	-14.36	AVG	
4	1.3180	22.68	17.84	40.52	56.00	-15.48	QP	
5	1.6620	20.47	17.84	38.31	56.00	-17.69	QP	
6	1.7100	10.71	17.84	28.55	46.00	-17.45	AVG	
7	1.9820	17.92	17.83	35.75	56.00	-20.25	QP	
8	2.0900	8.11	17.83	25.94	46.00	-20.06	AVG	
9	2.3860	15.72	17.83	33.55	56.00	-22.45	QP	
10	3.1220	2.14	17.84	19.98	46.00	-26.02	AVG	
11	4.5260	11.27	17.85	29.12	56.00	-26.88	QP	
12	4.6020	1.34	17.85	19.19	46.00	-26.81	AVG	



Temperature:	25.1 °C	Humidity:	67 %	Atmospheric Pressure:	101 kPa
--------------	---------	-----------	------	-----------------------	---------

TM1 / Line: Neutral / Band: 2400-2483.5 MHz / BW: 1 / CH: M

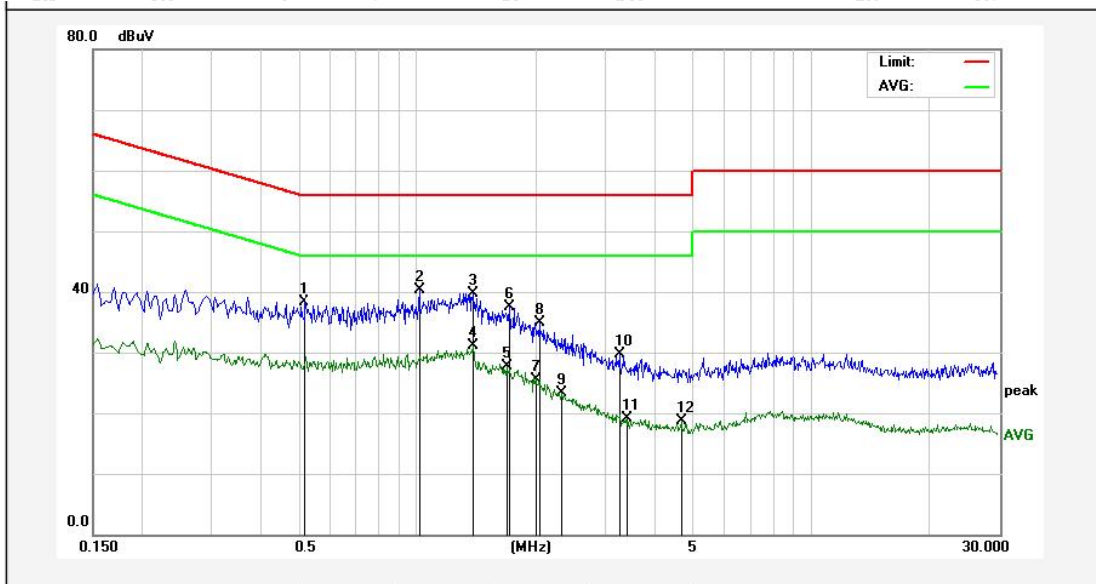

No.	Freq. (MHz)	Reading (dBuV)	Factor (dB)	Result (dBuV)	Limit (dBuV)	Over Limit (dB)	Detector	Remark
1	0.5180	20.36	17.85	38.21	56.00	-17.79	QP	
2	1.0140	22.52	17.85	40.37	56.00	-15.63	QP	
3	1.3820	21.92	17.84	39.76	56.00	-16.24	QP	
4	1.3820	13.32	17.84	31.16	46.00	-14.84	AVG	
5	1.6820	9.94	17.84	27.78	46.00	-18.22	AVG	
6	1.7140	19.70	17.84	37.54	56.00	-18.46	QP	
7	1.9940	7.77	17.83	25.60	46.00	-20.40	AVG	
8	2.0340	17.02	17.83	34.85	56.00	-21.15	QP	
9	2.3140	5.56	17.83	23.39	46.00	-22.61	AVG	
10	3.2500	11.81	17.84	29.65	56.00	-26.35	QP	
11	3.4140	1.33	17.84	19.17	46.00	-26.83	AVG	
12	4.6700	0.89	17.85	18.74	46.00	-27.26	AVG	

Note: Only record the worst data in the report.

**Shenzhen Anbotek Compliance Laboratory Limited**

Address: 1/F., Building D, Sogood Science and Technology Park, Sanwei Community, Hangcheng Street, Bao'an District, Shenzhen, Guangdong, China.  
 Tel: (86)0755-26066440 Fax: (86)0755-26014772 Email: service@anbotek.com

Hotline 400-003-0500  
 www.anbotek.com.cn



## 4. Occupied Bandwidth

Test Requirement:	47 CFR 15.247(a)(2)
Test Limit:	Refer to 47 CFR 15.247(a)(2), Systems using digital modulation techniques may operate in the 902-928 MHz, and 2400-2483.5 MHz bands. The minimum 6 dB bandwidth shall be at least 500 kHz.
Test Method:	ANSI C63.10-2020, section 11.8 KDB 558074 D01 15.247 Meas Guidance v05r02
Procedure:	<p>11.8.1 Option 1 The steps for the first option are as follows:</p> <ul style="list-style-type: none"> <li>a) Set RBW = shall be in the range of 1% to 5% of the OBW but not less than 100 kHz.</li> <li>b) Set the VBW <math>\geq [3 \times \text{RBW}]</math>.</li> <li>c) Detector = peak.</li> <li>d) Trace mode = max-hold.</li> <li>e) Sweep = No faster than coupled (auto) time.</li> <li>f) Allow the trace to stabilize.</li> <li>g) Measure the maximum width of the emission by placing two markers, one at the lowest frequency and the other at the highest frequency of the envelope of the spectral display, such that each marker is at or slightly below the “-6 dB down amplitude”. If a marker is below this “-6 dB down amplitude” value, then it shall be as close as possible to this value.</li> </ul> <p>11.8.2 Option 2 The automatic bandwidth measurement capability of an instrument may be employed using the X dB bandwidth mode with X set to 6 dB, if the functionality described in 11.8.1 (i.e., RBW = 100 kHz, VBW <math>\geq 3 \times \text{RBW}</math>, and peak detector with maximum hold) is implemented by the instrumentation function. When using this capability, care shall be taken so that the bandwidth measurement is not influenced by any intermediate power nulls in the fundamental emission that might be <math>\geq 6</math> dB.</p>

### 4.1. EUT Operation

Operating Environment:	
Test mode:	1: TX mode: Keep the EUT in continuously transmitting mode with GFSK modulation.

### 4.2. Test Setup

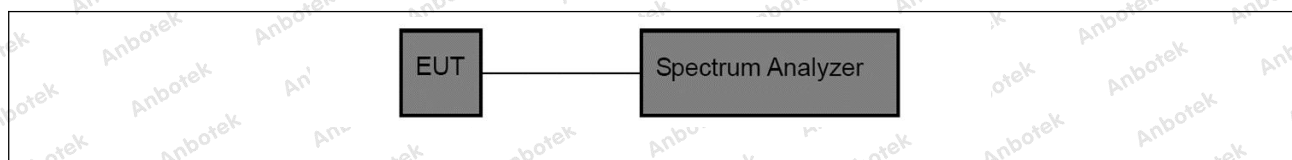

### 4.3. Test Data

Temperature:	25.3 °C	Humidity:	48 %	Atmospheric Pressure:	101 kPa
--------------	---------	-----------	------	-----------------------	---------

Please refer to Appendix A of the Appendix Test Data.





## 5. Maximum Conducted Output Power

Test Requirement:	47 CFR 15.247(b)(3)
Test Limit:	Refer to 47 CFR 15.247(b)(3), For systems using digital modulation in the 902-928 MHz, 2400-2483.5 MHz, and 5725-5850 MHz bands: 1 Watt. As an alternative to a peak power measurement, compliance with the one Watt limit can be based on a measurement of the maximum conducted output power. Maximum Conducted Output Power is defined as the total transmit power delivered to all antennas and antenna elements averaged across all symbols in the signaling alphabet when the transmitter is operating at its maximum power control level. Power must be summed across all antennas and antenna elements. The average must not include any time intervals during which the transmitter is off or is transmitting at a reduced power level. If multiple modes of operation are possible (e.g., alternative modulation methods), the maximum conducted output power is the highest total transmit power occurring in any mode.
Test Method:	ANSI C63.10-2020 section 11.9.1 KDB 558074 D01 15.247 Meas Guidance v05r02
Procedure:	ANSI C63.10-2020, section 11.9.1 Maximum peak conducted output power

### 5.1. EUT Operation

Operating Environment:	
Test mode:	1: TX mode: Keep the EUT in continuously transmitting mode with GFSK modulation.

### 5.2. Test Setup

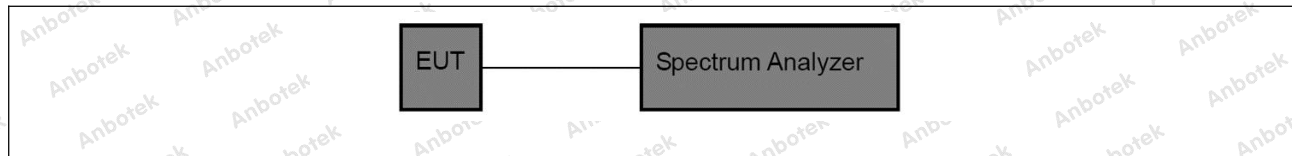

### 5.3. Test Data

Temperature:	25.3 °C	Humidity:	48 %	Atmospheric Pressure:	101 kPa
--------------	---------	-----------	------	-----------------------	---------

Please refer to Appendix C of the Appendix Test Data.



## 6. Power Spectral Density

Test Requirement:	47 CFR 15.247(e)
Test Limit:	Refer to 47 CFR 15.247(e), For digitally modulated systems, the power spectral density conducted from the intentional radiator to the antenna shall not be greater than 8 dBm in any 3 kHz band during any time interval of continuous transmission. This power spectral density shall be determined in accordance with the provisions of paragraph (b) of this section. The same method of determining the conducted output power shall be used to determine the power spectral density.
Test Method:	ANSI C63.10-2020, section 11.10 KDB 558074 D01 15.247 Meas Guidance v05r02
Procedure:	ANSI C63.10-2020, section 11.10, Maximum power spectral density level in the fundamental emission

### 6.1. EUT Operation

Operating Environment:	
Test mode:	1: TX mode: Keep the EUT in continuously transmitting mode with GFSK modulation.

### 6.2. Test Setup

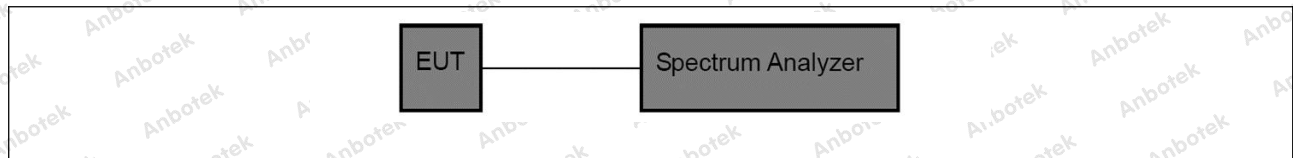

### 6.3. Test Data

Temperature:	25.3 °C	Humidity:	48 %	Atmospheric Pressure:	101 kPa
--------------	---------	-----------	------	-----------------------	---------

Please refer to Appendix D of the Appendix Test Data.



## 7. Emissions in non-restricted frequency bands

Test Requirement:	47 CFR 15.247(d), 15.209, 15.205
Test Limit:	Refer to 47 CFR 15.247(d), In any 100 kHz bandwidth outside the frequency band in which the spread spectrum or digitally modulated intentional radiator is operating, the radio frequency power that is produced by the intentional radiator shall be at least 20 dB below that in the 100 kHz bandwidth within the band that contains the highest level of the desired power, based on either an RF conducted or a radiated measurement, provided the transmitter demonstrates compliance with the peak conducted power limits. If the transmitter complies with the conducted power limits based on the use of RMS averaging over a time interval, as permitted under paragraph (b)(3) of this section, the attenuation required under this paragraph shall be 30 dB instead of 20 dB. Attenuation below the general limits specified in § 15.209(a) is not required.
Test Method:	ANSI C63.10-2020 section 11.11 KDB 558074 D01 15.247 Meas Guidance v05r02
Procedure:	ANSI C63.10-2020 Section 11.11.1, Section 11.11.2, Section 11.11.3

### 7.1. EUT Operation

Operating Environment:	
Test mode:	1: TX mode: Keep the EUT in continuously transmitting mode with GFSK modulation.

### 7.2. Test Setup

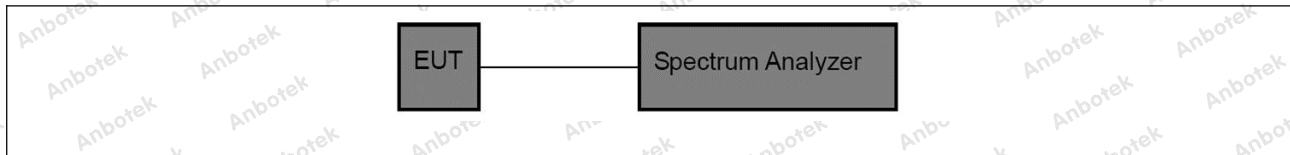

### 7.3. Test Data

Temperature:	25.3 °C	Humidity:	48 %	Atmospheric Pressure:	101 kPa
--------------	---------	-----------	------	-----------------------	---------

Please refer to Appendix E&F of the Appendix Test Data.



## 8. Band edge emissions (Radiated)

Test Requirement:	Refer to 47 CFR 15.247(d), In addition, radiated emissions which fall in the restricted bands, as defined in § 15.205(a), must also comply with the radiated emission limits specified in § 15.209(a)(see § 15.205(c)).		
Test Limit:	Frequency (MHz)	Field strength (microvolts/meter)	Measurement distance (meters)
	0.009-0.490	2400/F(kHz)	300
	0.490-1.705	24000/F(kHz)	30
	1.705-30.0	30	30
	30-88	100 **	3
	88-216	150 **	3
	216-960	200 **	3
	Above 960	500	3
Test Method:	ANSI C63.10-2020 section 6.10 KDB 558074 D01 15.247 Meas Guidance v05r02		
Procedure:	ANSI C63.10-2020 section 6.10.5.2		

\*\* Except as provided in paragraph (g), fundamental emissions from intentional radiators operating under this section shall not be located in the frequency bands 54-72 MHz, 76-88 MHz, 174-216 MHz or 470-806 MHz. However, operation within these frequency bands is permitted under other sections of this part, e.g., §§ 15.231 and 15.241. In the emission table above, the tighter limit applies at the band edges. The emission limits shown in the above table are based on measurements employing a CISPR quasi-peak detector except for the frequency bands 9–90 kHz, 110–490 kHz and above 1000 MHz. Radiated emission limits in these three bands are based on measurements employing an average detector.

### 8.1. EUT Operation

Operating Environment:	
Test mode:	1: TX mode: Keep the EUT in continuously transmitting mode with GFSK modulation.

### 8.2. Test Setup

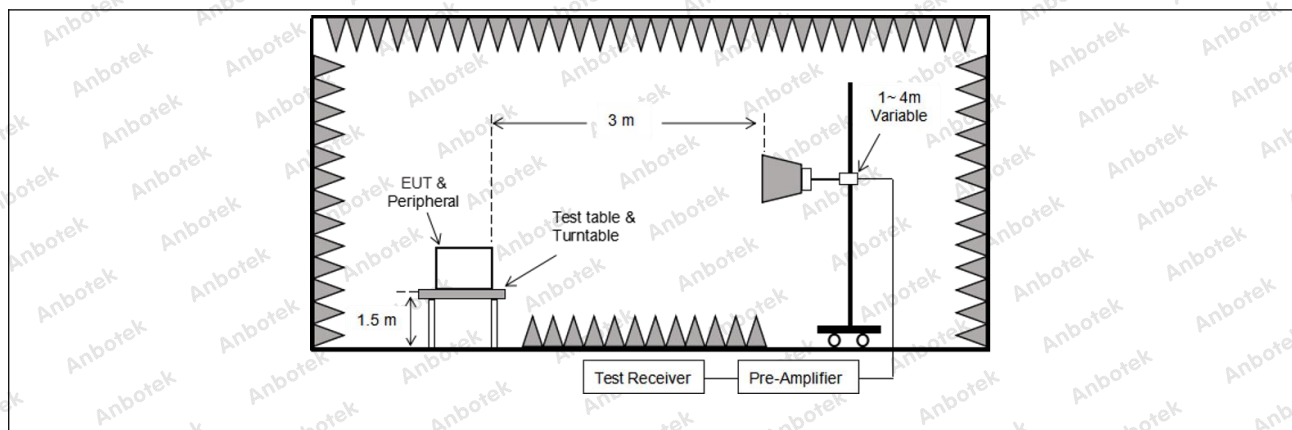

### 8.3. Test Data

Temperature:	25.3 °C	Humidity:	48 %	Atmospheric Pressure:	101 kPa
--------------	---------	-----------	------	-----------------------	---------

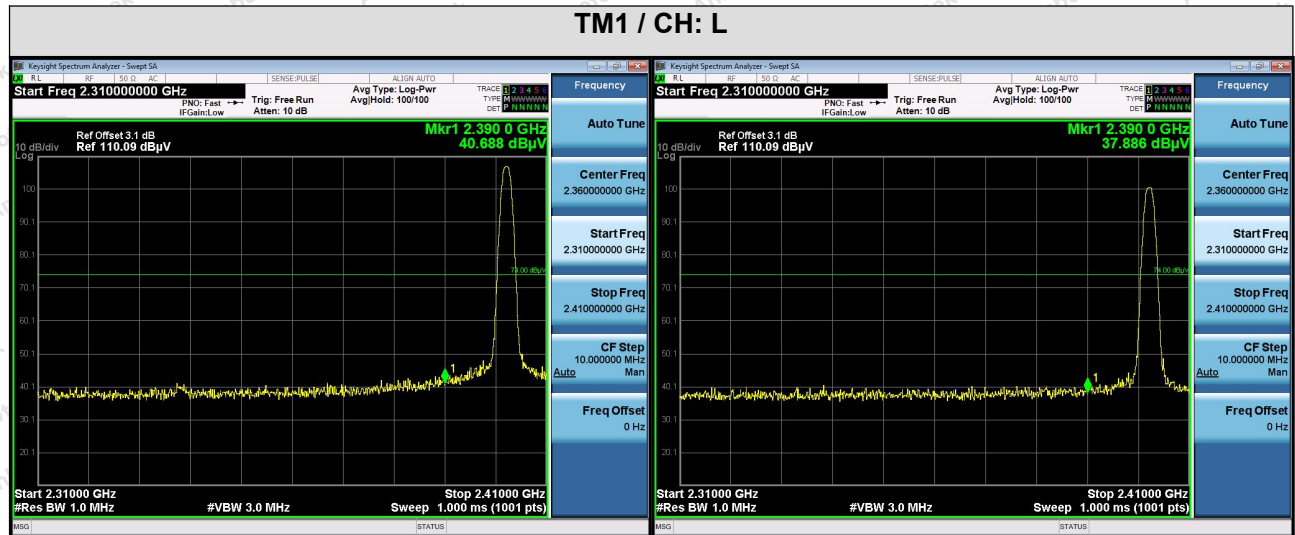

Peak Value(Vertical)

Peak Value(Horizontal)

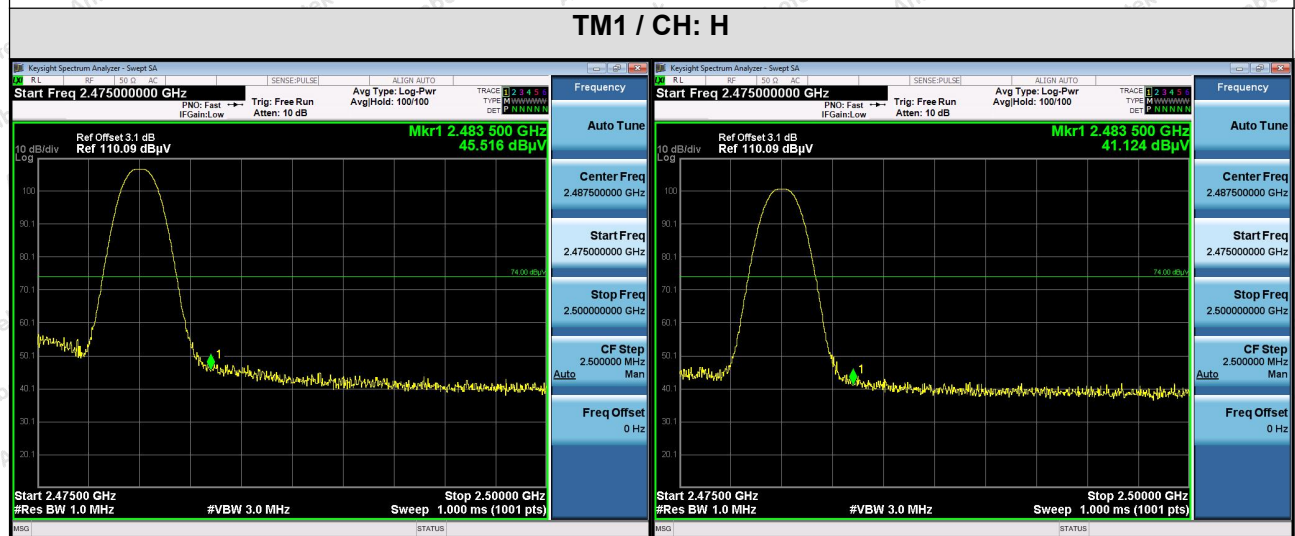

Peak Value(Vertical)

Peak Value(Horizontal)

Remark: When the PK measure result value is less than the AVG limit value, the AV measure result values test not applicable.

### Shenzhen Anbotek Compliance Laboratory Limited

Address: 1/F., Building D, Sogood Science and Technology Park, Sanwei Community, Hangcheng Street, Bao'an District, Shenzhen, Guangdong, China.  
Tel: (86)0755-26066440 Fax: (86)0755-26014772 Email: service@anbotek.com

Hotline  
400-003-0500  
www.anbotek.com.cn



## 9. Emissions in frequency bands (below 1GHz)

Test Requirement:	Refer to 47 CFR 15.247(d), In addition, radiated emissions which fall in the restricted bands, as defined in § 15.205(a), must also comply with the radiated emission limits specified in § 15.209(a)(see § 15.205(c)).`		
Test Limit:	Frequency (MHz)	Field strength (microvolts/meter)	Measurement distance (meters)
	0.009-0.490	2400/F(kHz)	300
	0.490-1.705	24000/F(kHz)	30
	1.705-30.0	30	30
	30-88	100 **	3
	88-216	150 **	3
	216-960	200 **	3
	Above 960	500	3
Test Method:	<p>** Except as provided in paragraph (g), fundamental emissions from intentional radiators operating under this section shall not be located in the frequency bands 54-72 MHz, 76-88 MHz, 174-216 MHz or 470-806 MHz. However, operation within these frequency bands is permitted under other sections of this part, e.g., §§ 15.231 and 15.241.</p> <p>In the emission table above, the tighter limit applies at the band edges. The emission limits shown in the above table are based on measurements employing a CISPR quasi-peak detector except for the frequency bands 9–90 kHz, 110–490 kHz and above 1000 MHz. Radiated emission limits in these three bands are based on measurements employing an average detector.</p>		
Procedure:	ANSI C63.10-2020 section 6.6.4 KDB 558074 D01 15.247 Meas Guidance v05r02		

### 9.1. EUT Operation

Operating Environment:	
Test mode:	1: TX mode: Keep the EUT in continuously transmitting mode with GFSK modulation.



## 9.2. Test Setup

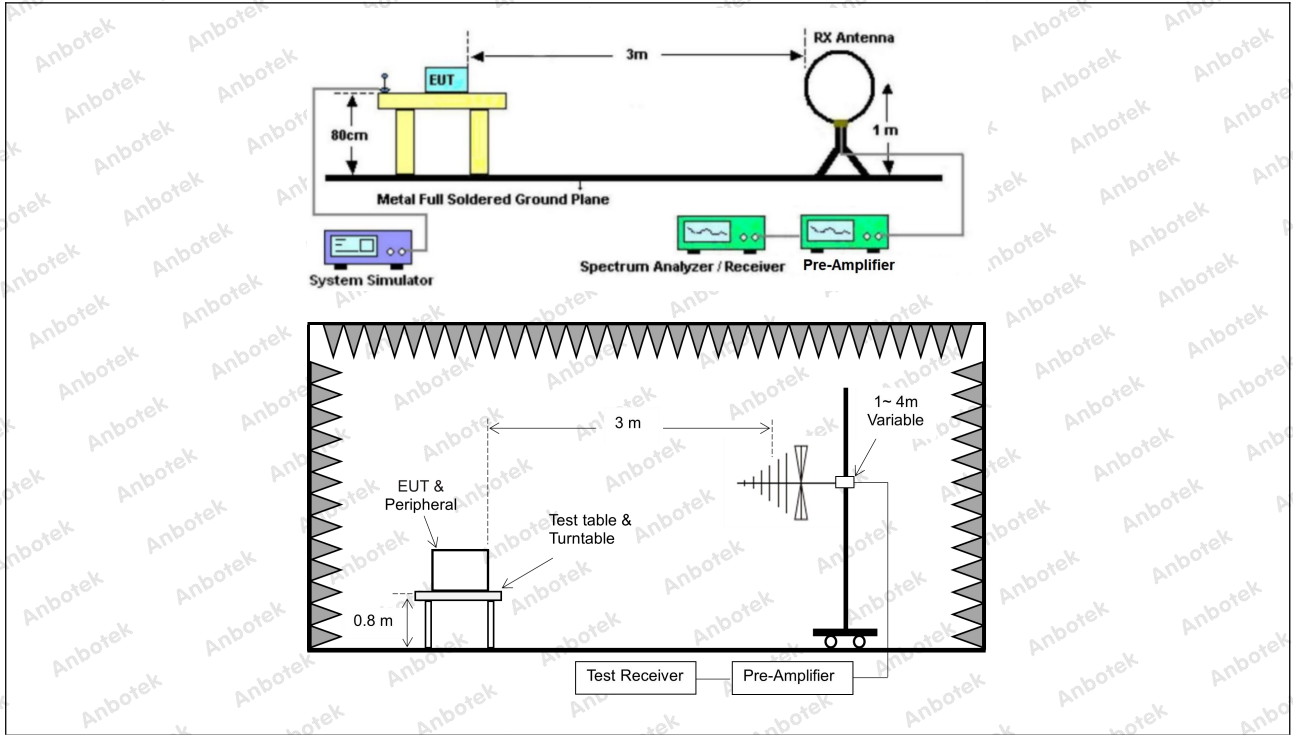

### 9.3. Test Data

The test results of 9kHz-30MHz was attenuated more than 20dB below the permissible limits, so the results don't record in the report.

Temperature:	23.5 °C	Humidity:	55 %	Atmospheric Pressure:	101 kPa
--------------	---------	-----------	------	-----------------------	---------

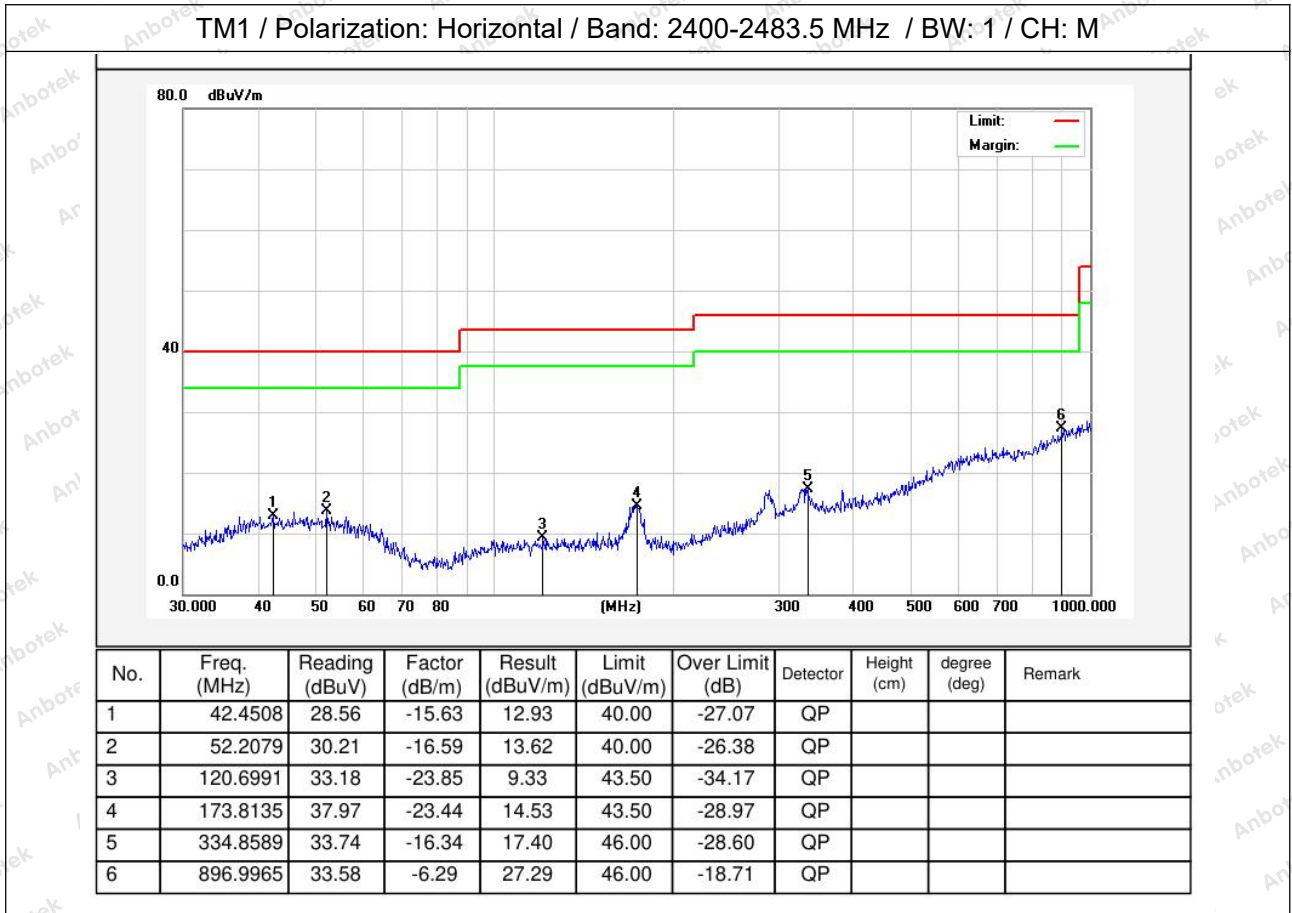



Temperature:	23.5 °C	Humidity:	55 %	Atmospheric Pressure:	101 kPa
--------------	---------	-----------	------	-----------------------	---------

TM1 / Polarization: Vertical / Band: 2400-2483.5 MHz / BW: 1 / CH: M

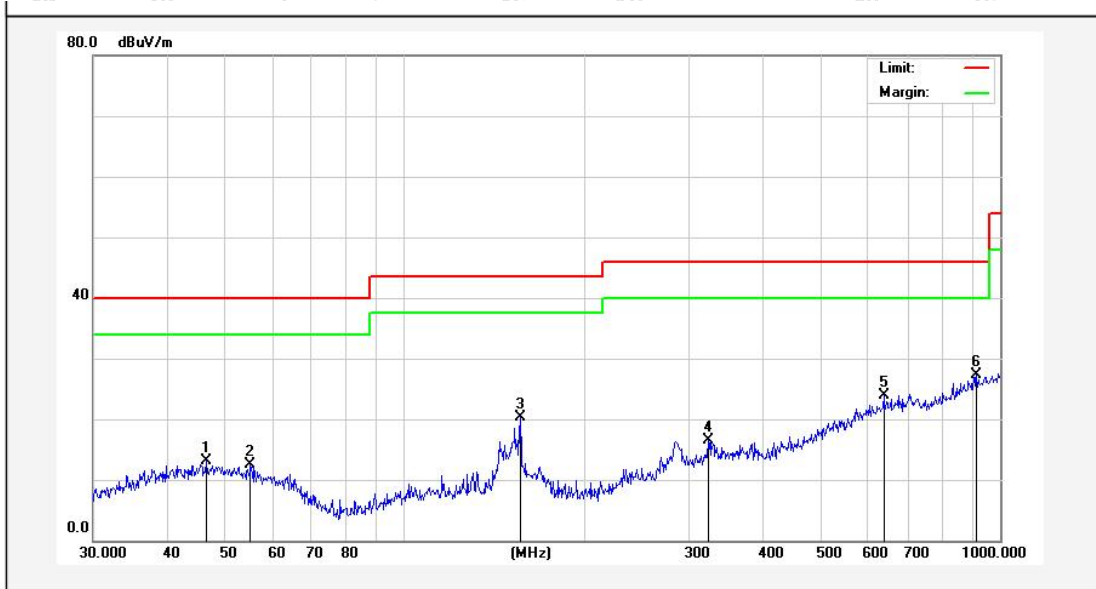

No.	Freq. (MHz)	Reading (dBUV)	Factor (dB/m)	Result (dBUV/m)	Limit (dBUV/m)	Over Limit (dB)	Detector	Height (cm)	degree (deg)	Remark
1	46.3402	28.29	-15.24	13.05	40.00	-26.95	QP			
2	55.0274	30.11	-17.63	12.48	40.00	-27.52	QP			
3	156.4578	42.08	-21.81	20.27	43.50	-23.23	QP			
4	323.3204	32.15	-15.67	16.48	46.00	-29.52	QP			
5	638.3686	34.46	-10.63	23.83	46.00	-22.17	QP			
6	912.8620	33.42	-6.08	27.34	46.00	-18.66	QP			

Note: Only record the worst data in the report.



## 10. Emissions in frequency bands (above 1GHz)

Test Requirement:	In addition, radiated emissions which fall in the restricted bands, as defined in § 15.205(a), must also comply with the radiated emission limits specified in § 15.209(a)(see § 15.205(c)).		
Test Limit:	Frequency (MHz)	Field strength (microvolts/meter)	Measurement distance (meters)
	0.009-0.490	2400/F(kHz)	300
	0.490-1.705	24000/F(kHz)	30
	1.705-30.0	30	30
	30-88	100 **	3
	88-216	150 **	3
	216-960	200 **	3
	Above 960	500	3
	<p>** Except as provided in paragraph (g), fundamental emissions from intentional radiators operating under this section shall not be located in the frequency bands 54-72 MHz, 76-88 MHz, 174-216 MHz or 470-806 MHz. However, operation within these frequency bands is permitted under other sections of this part, e.g., §§ 15.231 and 15.241.</p> <p>In the emission table above, the tighter limit applies at the band edges. The emission limits shown in the above table are based on measurements employing a CISPR quasi-peak detector except for the frequency bands 9–90 kHz, 110–490 kHz and above 1000 MHz. Radiated emission limits in these three bands are based on measurements employing an average detector.</p>		
Test Method:	ANSI C63.10-2020 section 6.6.4 KDB 558074 D01 15.247 Meas Guidance v05r02		
Procedure:	ANSI C63.10-2020 section 6.6.4		

### 10.1. EUT Operation

Operating Environment:	
Test mode:	1: TX mode: Keep the EUT in continuously transmitting mode with GFSK modulation.

### 10.2. Test Setup

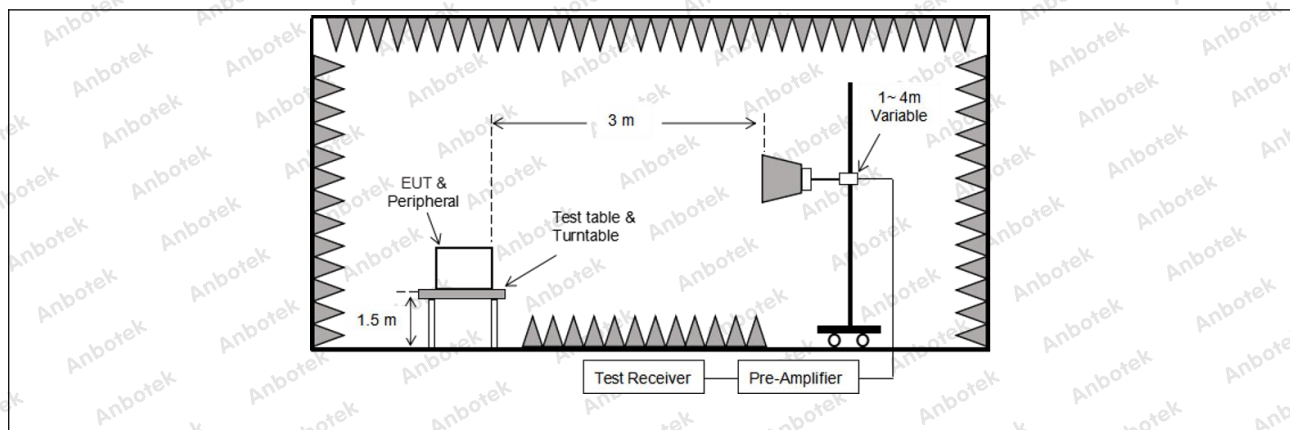

### 10.3. Test Data

Temperature:	23.5 °C	Humidity:	55 %	Atmospheric Pressure:	101 kPa
--------------	---------	-----------	------	-----------------------	---------

TM1 / CH: L						
Peak value:						
Frequency (MHz)	Reading (dBuV)	Factor (dB/m)	Result (dBuV/m)	Limit (dBuV/m)	Over Limit (dB)	polarization
4804.00	28.78	15.27	44.05	74.00	-29.95	Vertical
7206.00	28.79	18.09	46.88	74.00	-27.12	Vertical
9608.00	39.75	23.76	63.51	74.00	-10.49	Vertical
12010.00	*			74.00		Vertical
14412.00	*			74.00		Vertical
4804.00	28.42	15.27	43.69	74.00	-30.31	Horizontal
7206.00	29.44	18.09	47.53	74.00	-26.47	Horizontal
9608.00	38.25	23.76	62.01	74.00	-11.99	Horizontal
12010.00	*			74.00		Horizontal
14412.00	*			74.00		Horizontal
Average value:						
Frequency (MHz)	Reading (dBuV)	Factor (dB/m)	Result (dBuV/m)	Limit (dBuV/m)	Over Limit (dB)	polarization
4804.00	17.05	15.27	32.32	54.00	-21.68	Vertical
7206.00	17.84	18.09	35.93	54.00	-18.07	Vertical
9608.00	27.22	23.76	50.98	54.00	-3.02	Vertical
12010.00	*			54.00		Vertical
14412.00	*			54.00		Vertical
4804.00	16.75	15.27	32.02	54.00	-21.98	Horizontal
7206.00	18.47	18.09	36.56	54.00	-17.44	Horizontal
9608.00	26.76	23.76	50.52	54.00	-3.48	Horizontal
12010.00	*			54.00		Horizontal
14412.00	*			54.00		Horizontal

#### Shenzhen Anbotek Compliance Laboratory Limited

Address: 1/F., Building D, Sogood Science and Technology Park, Sanwei Community, Hangcheng Street, Bao'an District, Shenzhen, Guangdong, China.  
 Tel: (86)0755-26066440 Fax: (86)0755-26014772 Email: service@anbotek.com

Hotline 400-003-0500  
 www.anbotek.com.cn



TM1 / CH: M						
Peak value:						
Frequency (MHz)	Reading (dBuV)	Factor (dB/m)	Result (dBuV/m)	Limit (dBuV/m)	Over Limit (dB)	polarization
4880.00	28.33	15.42	43.75	74.00	-30.25	Vertical
7320.00	28.76	18.02	46.78	74.00	-27.22	Vertical
9760.00	39.25	23.80	63.05	74.00	-10.95	Vertical
12200.00	*			74.00		Vertical
14640.00	*			74.00		Vertical
4880.00	28.23	15.42	43.65	74.00	-30.35	Horizontal
7320.00	29.31	18.02	47.33	74.00	-26.67	Horizontal
9760.00	37.97	23.80	61.77	74.00	-12.23	Horizontal
12200.00	*			74.00		Horizontal
14640.00	*			74.00		Horizontal
Average value:						
Frequency (MHz)	Reading (dBuV)	Factor (dB/m)	Result (dBuV/m)	Limit (dBuV/m)	Over Limit (dB)	polarization
4880.00	17.14	15.42	32.56	54.00	-21.44	Vertical
7320.00	17.70	18.02	35.72	54.00	-18.28	Vertical
9760.00	28.07	23.80	51.87	54.00	-2.13	Vertical
12200.00	*			54.00		Vertical
14640.00	*			54.00		Vertical
4880.00	16.86	15.42	32.28	54.00	-21.72	Horizontal
7320.00	18.82	18.02	36.84	54.00	-17.16	Horizontal
9760.00	26.06	23.80	49.86	54.00	-4.14	Horizontal
12200.00	*			54.00		Horizontal
14640.00	*			54.00		Horizontal

**Shenzhen Anbotek Compliance Laboratory Limited**

Address: 1/F., Building D, Sogood Science and Technology Park, Sanwei Community, Hangcheng Street, Bao'an District, Shenzhen, Guangdong, China.  
 Tel: (86)0755-26066440 Fax: (86)0755-26014772 Email: service@anbotek.com

Hotline 400-003-0500  
 www.anbotek.com.cn



TM1 / CH: H						
Peak value:						
Frequency (MHz)	Reading (dBuV)	Factor (dB/m)	Result (dBuV/m)	Limit (dBuV/m)	Over Limit (dB)	polarization
4960.00	28.46	15.58	44.04	74.00	-29.96	Vertical
7440.00	28.92	17.93	46.85	74.00	-27.15	Vertical
9920.00	39.95	23.83	63.78	74.00	-10.22	Vertical
12400.00	*			74.00		Vertical
14880.00	*			74.00		Vertical
4960.00	28.37	15.58	43.95	74.00	-30.05	Horizontal
7440.00	29.52	17.93	47.45	74.00	-26.55	Horizontal
9920.00	38.35	23.83	62.18	74.00	-11.82	Horizontal
12400.00	*			74.00		Horizontal
14880.00	*			74.00		Horizontal
Average value:						
Frequency (MHz)	Reading (dBuV)	Factor (dB/m)	Result (dBuV/m)	Limit (dBuV/m)	Over Limit (dB)	polarization
4960.00	18.26	15.58	33.84	54.00	-20.16	Vertical
7440.00	18.97	17.93	36.90	54.00	-17.10	Vertical
9920.00	27.72	23.83	51.55	54.00	-2.45	Vertical
12400.00	*			54.00		Vertical
14880.00	*			54.00		Vertical
4960.00	18.04	15.58	33.62	54.00	-20.38	Horizontal
7440.00	19.62	17.93	37.55	54.00	-16.45	Horizontal
9920.00	26.21	23.83	50.04	54.00	-3.96	Horizontal
12400.00	*			54.00		Horizontal
14880.00	*			54.00		Horizontal

Remark:

1. Result = Reading + Factor
2. “\*” means the test results were attenuated more than 20dB below the permissible limits, so the results don't record in the report.

**Shenzhen Anbotek Compliance Laboratory Limited**

Address: 1/F., Building D, Sogood Science and Technology Park, Sanwei Community, Hangcheng Street, Bao'an District, Shenzhen, Guangdong, China.  
 Tel: (86)0755-26066440 Fax: (86)0755-26014772 Email: service@anbotek.com

Hotline  
 400-003-0500  
 www.anbotek.com.cn



**APPENDIX I -- TEST SETUP PHOTOGRAPH**

Please refer to separated files Appendix I -- Test Setup Photograph\_RF

**APPENDIX II -- EXTERNAL PHOTOGRAPH**

Please refer to separated files Appendix II -- External Photograph

**APPENDIX III -- INTERNAL PHOTOGRAPH**

Please refer to separated files Appendix III -- Internal Photograph

----- End of Report -----

**Shenzhen Anbotek Compliance Laboratory Limited**

Address: 1/F., Building D, Sogood Science and Technology Park, Sanwei Community,  
Hangcheng Street, Bao'an District, Shenzhen, Guangdong, China.  
Tel: (86)0755-26066440 Fax: (86)0755-26014772 Email: service@anbotek.com



Hotline  
400-003-0500  
www.anbotek.com.cn

