

K59090 Caddy_IG
 Folded size: 95 mm X 140 mm
 Trim size: 665X140MM

80G书写纸 正反印刷
 (符合Halogen-Free、EU packaging and US TPCH、DMF, 具体限值详见ACCO RSL4.0文件)

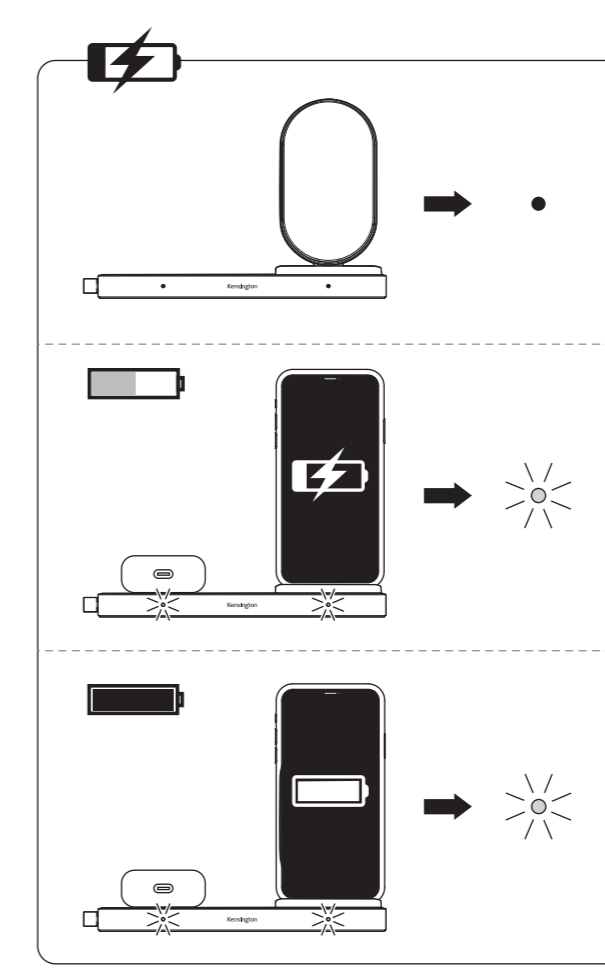

Kensington and the ACCO name and design are registered trademarks of ACCO Brands. All other registered and unregistered trademarks are the property of their respective owners. Qi is a registered trademark of Wireless Power Consortium. iPad, AirPods, and iPhone are trademarks of Apple Inc., registered in the U.S. and other countries.
 ©2021 Kensington Computer Products Group, a division of ACCO Brands. Any unauthorized copying, duplicating, or other reproduction of the contents hereof is prohibited without written consent from Kensington Computer Products Group. All rights reserved. 01/21

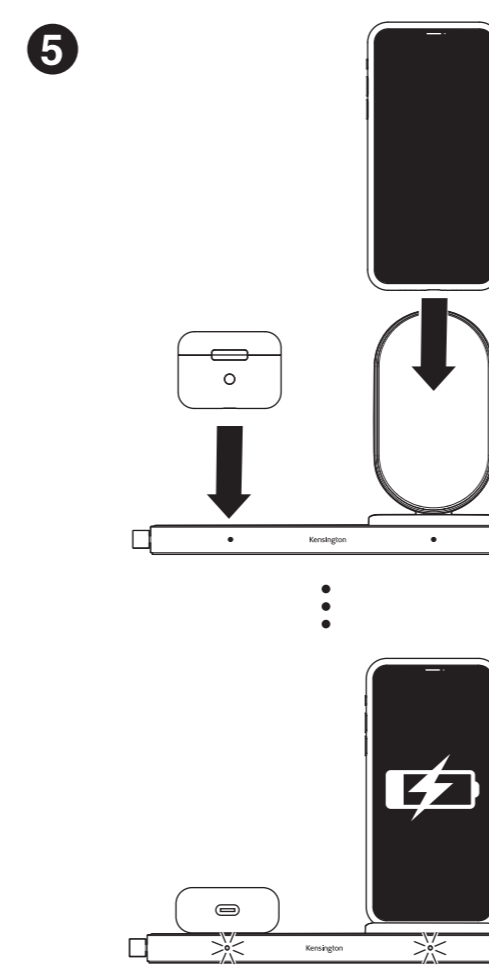
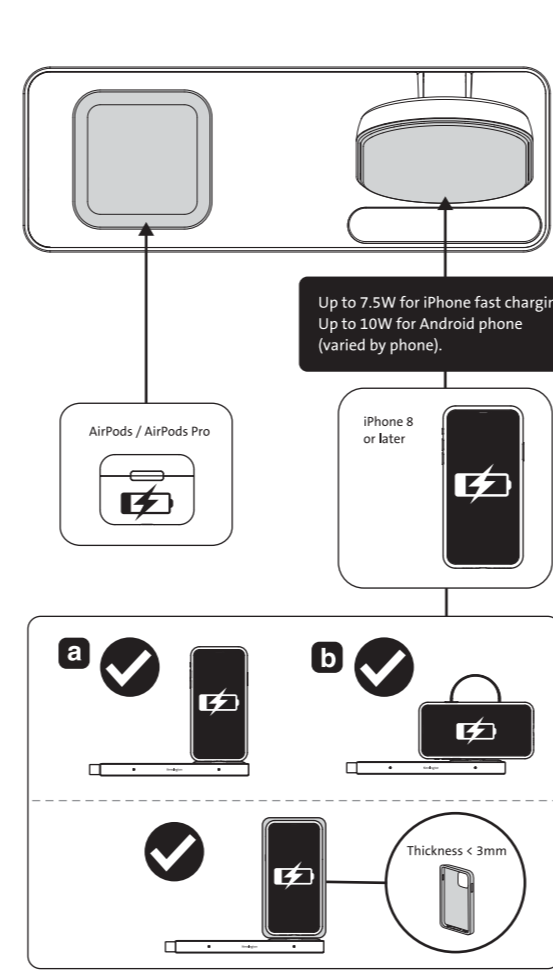
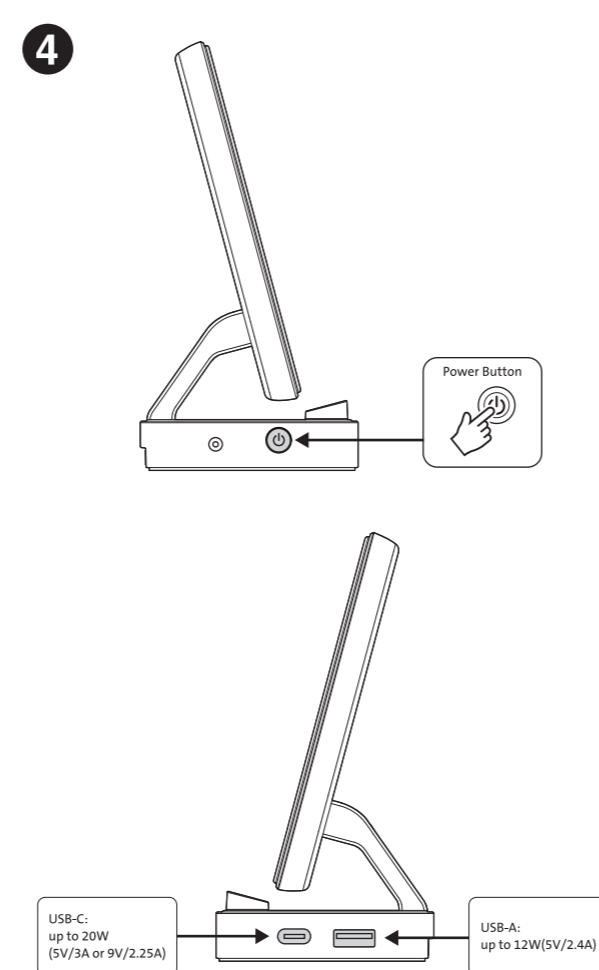
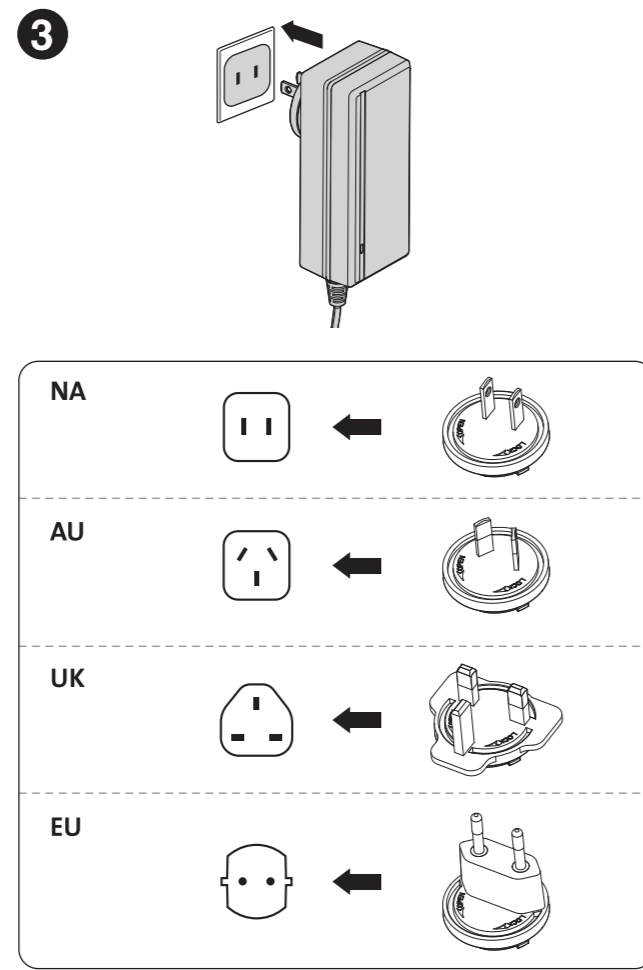
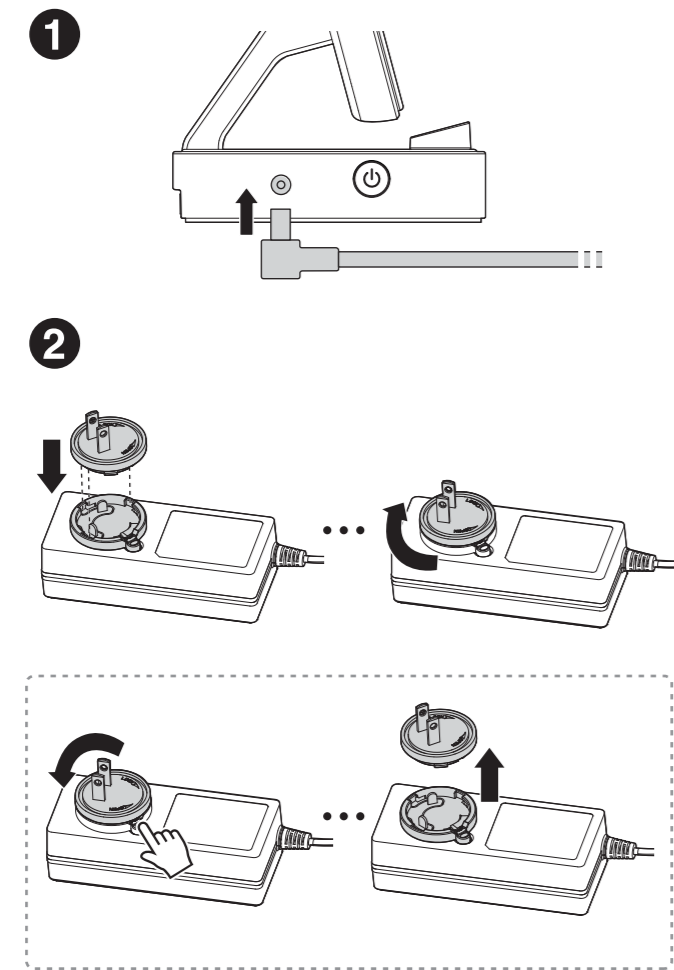

Kensington Computer Products Group
 A Division of ACCO Brands
 3200 Fashion Island Blvd, 3rd Floor
 San Mateo, CA 94404, USA

Importer: ACCO UK Ltd Oxford House, Oxford Road Arlborough, Basingstoke, Hampshire, RG21 8EJ United Kingdom	ACCO Brands Canada Inc 7331 Brimley Rd Mississauga, ON L5S 1C4 https://accobrandscanada.com/	ACCO Brands Australia - Kensington 2 Generation Avenue King Park NSW 2145 Australia
Importer: LEIF ACCO Brands GmbH & Co KG Sternenstraße 44 70469 Stuttgart Germany	Importador e Distribuidor por: Fibra Produções De Produtos Ltda. CNPJ: 44.996.902/0001-43 Rua Arymeris, 6-9 - Baraúna/SP - Brasil CEP: 07033-900 sac@fibra.com.br	Distributor: Eoslike Polska Sp. z o.o. ul. Poznańska 11A, 00-900 Koczanice
ACCO Brands Chile S.A. Avda. Presidente Balmaceda 4 9711, Santiago 20 Lira Corral, Santiago, Chile CP 7501114 www.accobrands.cl	Distribuidor: Eoslike Sales SRL O'Higgins 1160A, LDC, Sector 2, Bucaramanga, Colombia	Distributor: Eoslike, s.r.o., V.Lučič 818, 142 07 Praha 4, Česká republika
Empaquetador: Eoslike s.r.o. V.Lučič 76, V.Lučice I. smčs, 133 00 Budapest, Magyarország	дистрибутор: Eoslike s.r.o. V.Lučice Sp. z o.o., ul. Poznańska 11A, 00-900 Koczanice Импортер: "AGM Kozma" JSC, Autonoma, Chelnyyem lane 405/101	дистрибутор: Eoslike Ukraine Sp. z o.o., вулиця Познанська, 11А, 20-900 Кочаніці
Wholesaler: OOO Chikolaty, Moscow, 125046 Moscow, Russia Reception: +7 (495) 701-1616 +7(495)910-2743	アコブランスジャパン株式会社 〒164-8721 東京都中央区新富町1-2-2 11-モーター7-16F https://www.kensington.com/jp E-MAIL: JP.Kensington@accoco.com	广州市肯明贸易有限公司 广州市天河区林和西路159号 康乐国际大厦3011/101室 邮编: 510620 电话: +86 20 400 4399 网址: https://www.kensington.com/cn 邮箱: china@kensington.com

封底

K59090 901-5314-00

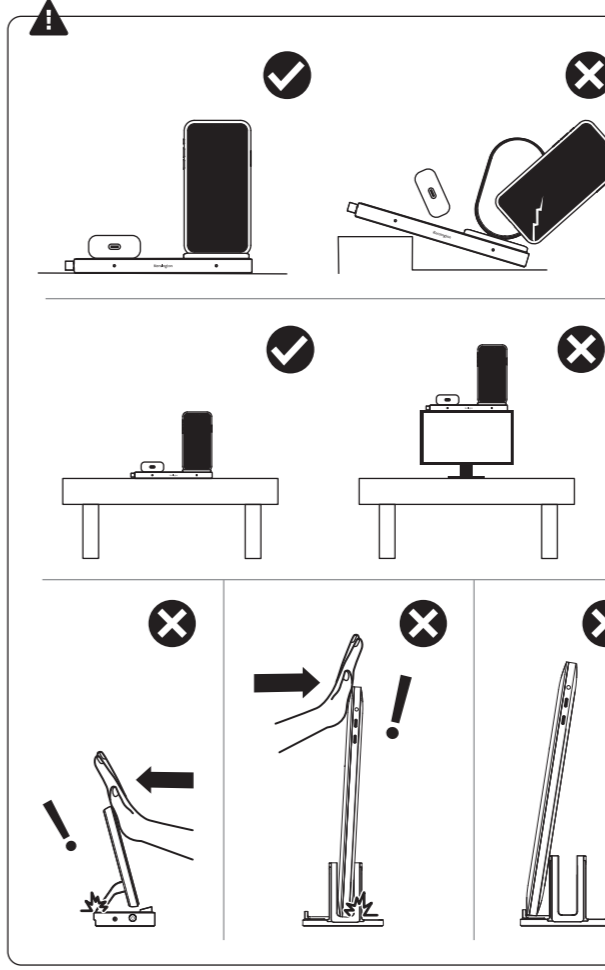
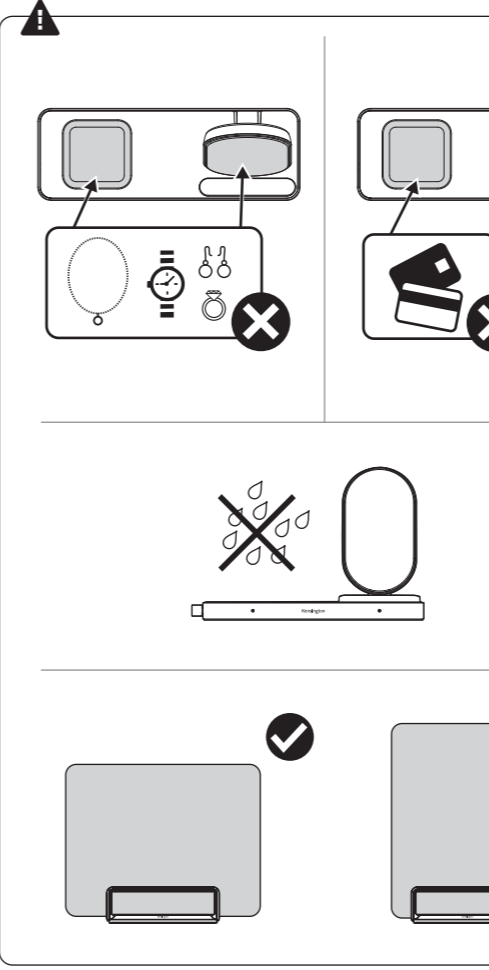
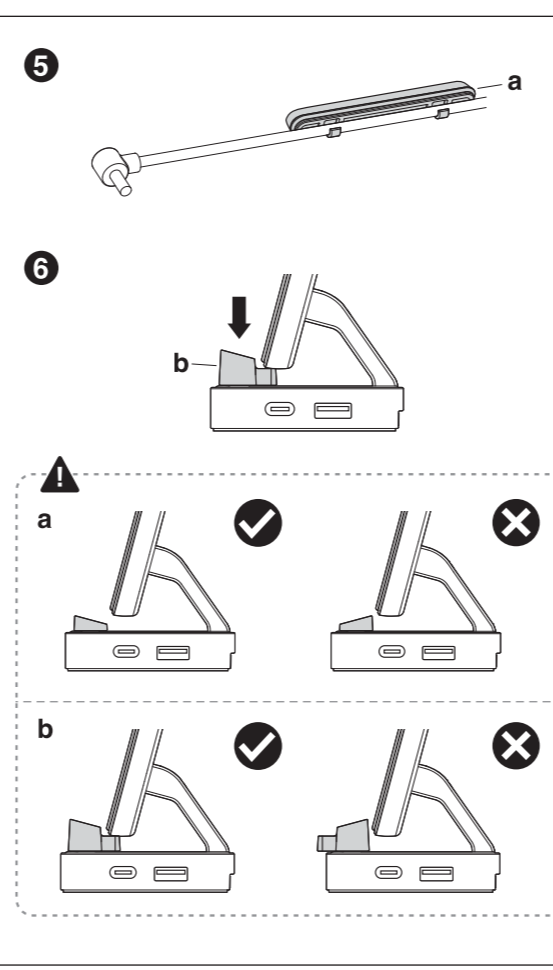
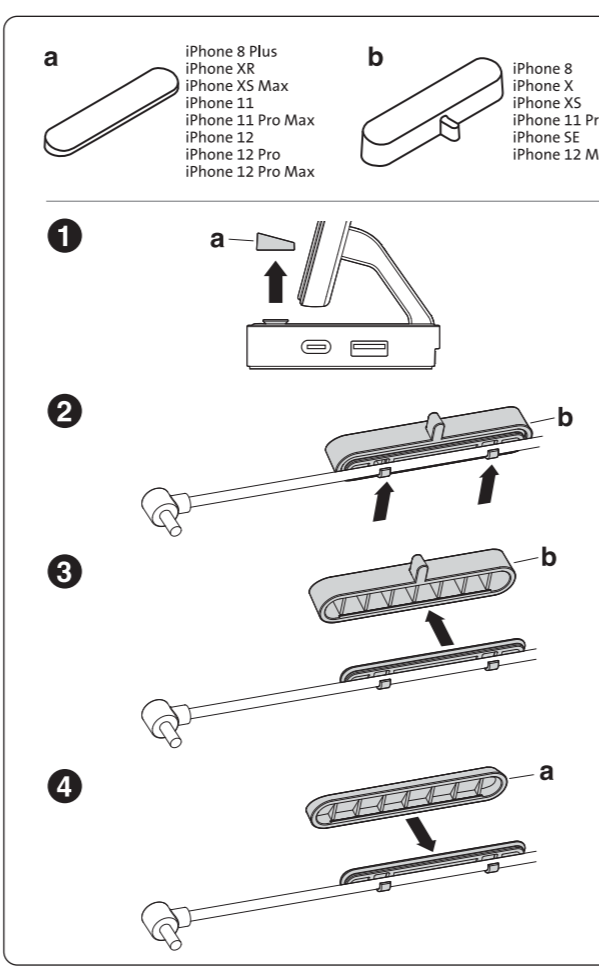
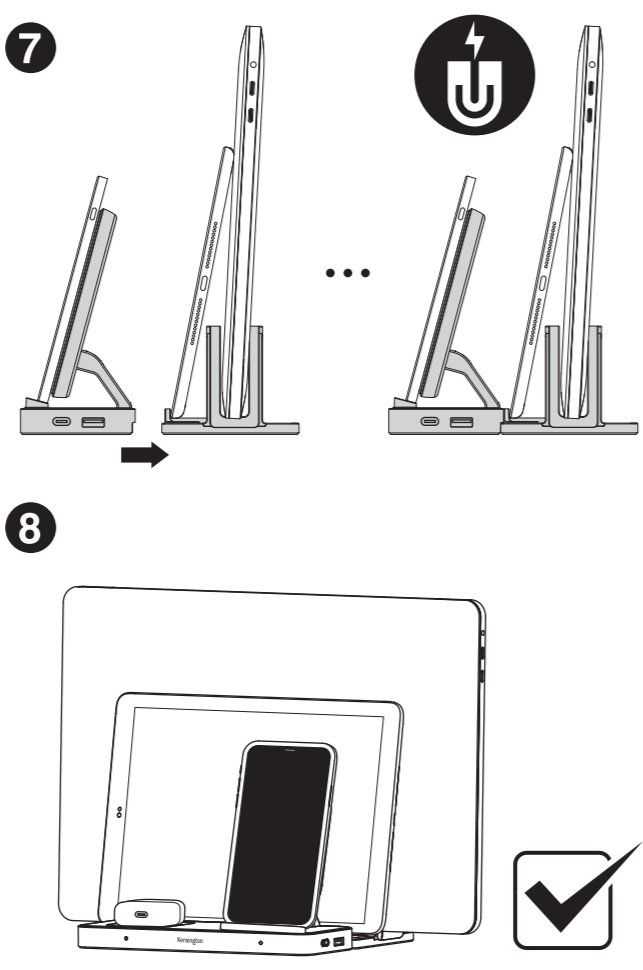
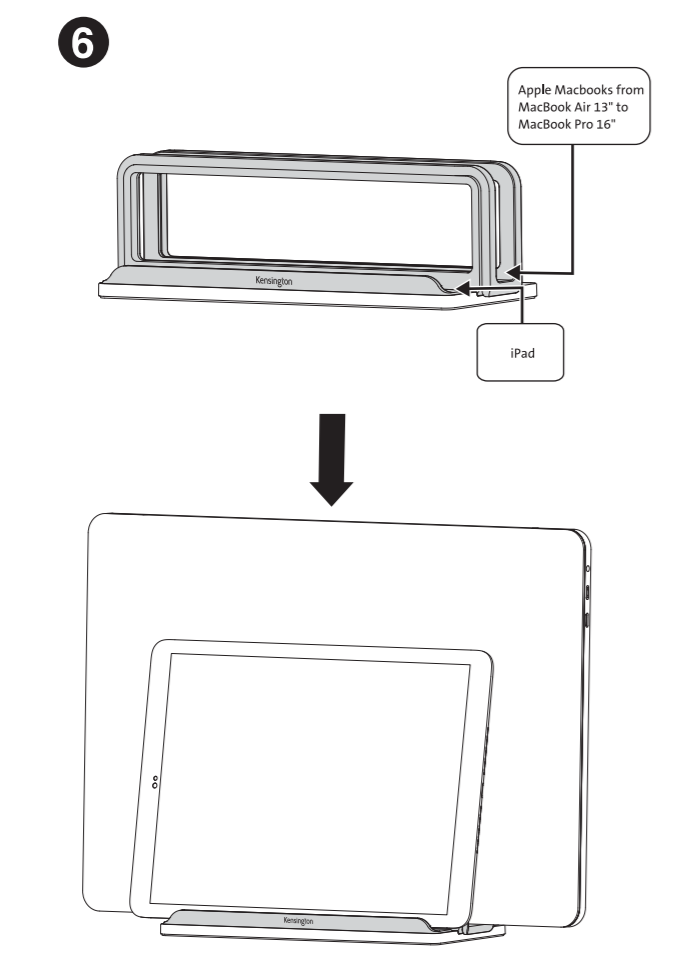

Kensington®

StudioCaddy™ with Wireless Charging

kensington.com/register

封面

DECLARAÇÃO DE CONFORMIDADE DA COMISSÃO FEDERAL DE COMUNICAÇÃO

Este produto está em conformidade com a Parte 15 dos regulamentos da FCC. O funcionamento está sujeito às duas condições: (1) este equipamento não pode causar interferências prejudiciais e (2) tem de suportar as interferências recebidas, incluindo as que possam prejudicar o funcionamento. Como definido na Seção 2.909 dos regulamentos da FCC, a parte responsável por este dispositivo é a Kensington Computer Products Group, 1500 Fashion Island Blvd, 3rd Floor, San Mateo, CA 94404, USA.

DECLARAÇÃO DE CONFORMIDADE DA INDUSTRY CANADA

Este aparelho digital de Classe [B] está em conformidade com a norma canadiana ICES-003, CAN ICES-3(B)/NMB-3(B).

DECLARAÇÃO DE CONFORMIDADE DA CE

A Kensington declara que este produto está em conformidade com os requisitos essenciais e outras disposições relevantes das Directivas da CE aplicáveis.

Para a Europa, pode obter uma cópia da Declaração de Conformidade para este produto, se clicar na ligação Declaração de Conformidade, em www.kensington.com/support.

INFORMAÇÃO APENAS PARA OS ESTADOS-MEMBROS DA UE

 A utilização do símbolo indica que este produto não pode ser tratado como lixo doméstico. Ao certificar-se de que se desfaz deste produto correctamente, ajudará a evitar potenciais consequências negativas para o ambiente e para a saúde, que, de outra forma, poderiam ocorrer pelo mau manuseamento deste produto. Para obter informação mais detalhada sobre a reciclagem deste produto, contacte o município onde reside, os serviços de recolha de resíduos da sua área ou a loja onde adquiriu o produto.

DANSK

CE-OVERENSSTEMMELSESEKLERING

Kensington erklærer, at denne produkt overholder de essentielle krav og andre relevante bestemmelser i gældende EF-direktiver.

I Europa kan man få en kopi af overensstemmelseserklæringen til dette produkt ved at klikke på linket for overensstemmelsesdokumentation på www.kensington.com/support.

INFORMATION UDELUKKENDE TIL EU-MEDLEMSSTATER

 Brugen af dette symbol indikerer, at dette produkt ikke må behandles som husholdningsaffald. Ved at sikre, at dette produkt bortskaffes på korrekt vis bidrager du til at forhindre potentielle negative miljø- og sundhedsmæssige konsekvenser, som ellers kunne blive forårsaget af forkert håndtering af produktet. Du kan få detaljerede oplysninger om genanvendelse af dette produkt ved at kontakte det lokale kommunekontor, din renovationstjeneste eller den forretning, hvor du købte produktet.

NORSK

CE-SAMSVARSEKLERING

Kensington erklærer dette produktet er i samsvar med de nødvendige kravene og andre relevante bestemmelser i aktuelle EU-direktiver.

For Europa kan en kopi av samsvarserklæringen for dette produktet hentes ved å klikke på lenken «Compliance Documentation» på www.kensington.com/support.

INFORMASJON SOM GJELDER KUN FOR EU-MEDLEMSSTATER

 Bruk av symbolet indikerer at dette produktet ikke må behandles som husholdningsavfall. Ved å sørge for at dette produktet kastes på riktig måte, hjelper du til å forhindre potensielle negative konsekvenser for miljøet og menneskehelsen, som ellers kunne ha oppstått ved feil avfallshåndtering av dette produktet. Hvis du vil ha mer detaljert informasjon om resirkulering av dette produktet, må du kontakte en miljøstasjon eller butikken der du kjøpte produktet.

SVENSKA

CE-FÖRSÄKRAN OM ÖVERENSSTÄMMELSE

Kensington försäkrar att denna produkt överensstämmer med de väsentliga kraven och andra relevanta bestämmelser i tillämpliga EU-direktiv.

För Europa kan en kopia av en försäkran om överensstämmelse för denna produkt hittas genom att klicka på länken "Compliance Documentation" (Dokumentation om överensstämmelse) på www.kensington.com/support.

INFORMATION SOM ENDAST AVSER EU-MEDLEMSSTATER

 Symbolen på produkten indikerar att denna produkt inte får behandlas som vanligt hushållsavfall. Genom att säkerställa att produkten hanteras på rätt sätt bidrar du till att förebygga eventuella negativa miljö- och hälsoeffekter som kan uppstå om produkten kasseras som vanligt avfall. För mer information om återvinning av denna produkt bör du kontakta lokala myndigheter eller sophämtningstjänst eller butikken där du köpte produkten.

SUOMI

EY:n vaatimustenmukaisuusvakuutus

Kensington vakuuttaa, että tämä laite noudattaa sovellettavien EY-direktiivien olennaisia vaatimuksia ja muita EY-määräyksiä.

Euroopassa tämän laitteen vaatimustenmukaisuusvakuutus on saatavilla napsauttamalla vaatimustenmukaisuusasiakirjojen linkkiä osoitteessa www.kensington.com/support.

VAIN EU-JÄSENVALTIOITA KOSKEVAT TIEDOT

 Tämä merkki tarkoittaa, että laitetta ei saa hävittää tavallisen kotitalousjätteen mukana. Varmistamalla laitteen asianmukaisen hävittämisen autat estämään vääränlaisen jätteenkäsittelyn mahdollisesti aiheuttamia haitallisia vaikutuksia ympäristölle ja ihmisten terveydelle. Jos tarvitset lisätietoja laitteen kierrättämisestä, ota yhteyttä kuntasi viranomaisiin, paikalliseen jätehuoltoon tai siihen liikkeeseen, josta ostit laitteen.

EESTI KEEL

CE-VASTAVUSDEKLARATSIOON

Kensington kinnitab, et see toode vastab asjakohaste EÜ direktiivide olulistele nõuetele ning muudele asjakohastele sätelete.

Euroopa tarbijad saavad selle toote vastavusdeklaratsiooni, klõpsates vastavusdokumentsiooni linki aadressil www.kensington.com/support.

VAID EL-I LIIKMESRIIKIDELE MÕELDUD TEAVE

 Selle sümboli kasutamine tähendab, et seda toodet ei tohi käsitleda olmejäätmena. Tagades selle toote nõuetekohase kasutamise, aitate ära hoida võimalikke negatiivseid tagajärgi keskkonnale ja inimeste tervisele, mille võiks kaasa tuua selle toote väär kärveldamine. Üksikasjalikumad teavet selle toote ringlussevõtu kohta küsige linnavalitsusest, oma jäätmete kõrvaldamise teenistusest või poest, kust te toote ostsite.

LATVIEŠU

CE ATBILSTĪBAS DEKLARĀCIJA

„Kensington” apliecina, ka šis produkts atbilst piemērojamo EK direktīvu pamatprasībām un citiem attiecīgajiem noteikumiem.

Eiropā šī produkta Atbilstības deklarācijas kopiju var iegūt, uzskicējinoz uz Atbilstības dokumentācijas saites vietnē www.kensington.com/support.

INFORMĀCIJA TIKAI ES DALĪBVALSTĪM

 Šī simbola lietojums nozīmē, ka no šī produkta nedrīkst atbrīvoties kopā ar mājsaimniecības atkritumiem. Atbrīvoties no šī produkta pareizā veidā, jūs palīdzēsiet novērst potenciālo negatīvo ietekmi uz vidi un cilvēku veselību, kas var rasties, rīkojoties ar šī produkta atkritumiem nepareizā veidā. Plašāka informācija par šī produkta pārstrādi lūdzam sazināties ar vietējo pilētās biroju, mājsaimniecības atkritumu pārstrādes pakalpojumu sniedzēju, vai veikal, kurā iegādājāties produktu.

LIEUVIŲ K

ES ATITIKTIES DEKLARACIJA

„Kensington” pareiškia, kad šis gaminys atitinka pagrindinius reikalavimus ir kitas susijusių EB direktyvų nuostatas. Europos rinkai skirtą šio gaminio atitikties deklaracijos kopiją galima rasti paspaudus „Compliance Documentation” (atitikties deklaracija) nuorodą svetainėje www.kensington.com/support.

INFORMACIJA TIK EUROPOS SAJUNGOS VALSTYBĖMS NARĖMS

 Naudojamas simbolis nurodo, kad šis gaminys nėra laikomas buitiniems atliekomis. Užtikrindami, kad šis gaminys yra šalinamas tinkamai, padėsite išvengti galimai neigiamų pasekmių aplinkai ir žmonių sveikatai, kurios gali grėsti netinkamai pašalinus šį gaminį. Dėl išsamesnės informacijos apie šio gaminio perdirimą kreipkitės į savo miesto savivaldybę, buitinių atliekų utilizavimo tarnybą arba parduotuvę, kurioje įsigijote šį gaminį.

SLOVENSKY

PREHLÁSENIE O ZHODE CE

Spoločnosť Kensington vyhlasuje, že tento výrobok je v súlade so základnými požiadavkami a ďalšími príslušnými ustanoveniami uplatniteľných smerníc ES.

Pre Európu, kópiu vyhlásenia o zhode pre tento výrobok možno získať kliknutím na odkaz Dokumentácia preukazujúca súlad s príslušnými podmienkami na adrese www.kensington.com/support.

INFORMÁCIA LEN PRE ČLENSKÉ ŠTÁT Y EÚ

 Použitie tohto symbolu znamená, že s týmto výrobkom sa nesmie zaobchádzať ako s domovým odpadom. Zabezpečení správne likvidácie výrobku pomôžete zabrániť možným negatívnym dôsledkom na životné prostredie a ľudské zdravie, ku ktorým by mohlo dôjsť nesprávnou manipuláciou s výrobkom. Podrobnejšie informácie o recyklácii výrobku vám poskytne váš mestský úrad, služba zberu komunálneho odpadu alebo predajňa, v ktorej ste výrobok zakúpili.

ROMÂNĂ

DECLARAȚIE DE CONFORMITATE CE

Kensington declară că acest model de produs este în conformitate cu cerințele esențiale și cu alte dispoziții relevante ale directivei CE aplicabile.

Pentru Europa, o copie a Declarației de conformitate pentru acest produs poate fi obținută făcând clic pe linkul Documentația privind conformitatea pe www.kensington.com/support.

INFORMAȚII NUMAI PENTRU STATELE MEMBRE ALE UE

 Utilizarea simbolului indică faptul că acest produs nu poate fi tratat ca deșeurii menajere. Prin asigurarea faptului că acest produs este eliminat în mod corect, veți ajuta la prevenirea consecințelor potențial negative pentru mediu și pentru sănătatea umană, care ar putea fi astfel cauzate de gestionarea necorespunzătoare a acestui produs. Pentru mai multe informații detaliate privind reciclarea acestui produs, contactați autoritățile dvs. locale, serviciul dvs. pentru eliminarea deșeurilor menajere, sau magazinul de unde ați achiziționat produsul.

УКРАЇНСЬКА

ДЕКЛАРАЦІЯ ПРО ВІДПОВІДНІСТЬ НОРМАМ ЄС (МАРКУВАННЯ ЄС)

Компанія Kensington заявляє, що цей вирiбiт відповідає основним вимогам та iншим релевантним положенням чинних директив ЄС.

Користувачі з Європи можуть отримати примірник Декларації про відповідність цього виробу нормам ЄС, перейшовши за посиланням на документи про відповідність на сайті www.kensington.com/support.

INFORMAȚIA LIȘIE DĚIA CORISTUVĂCII IZ DĚRĚAV-ȚLEIIV ЄС

 Цей символ використовується для позначення виробів, які не можна утилізувати разом із побутовими відходами. Зabezпечуючи належну утилізацію цього виробу, ви допоможете попередити негативний вплив на довкілля і здоров'я людей, який може виникати внаслідок відсортування цього виробу в неправильну категорію відходів. Щоб дізнатися докладніше про способи переробки цього виробу, зверніться до органів місцевого самоврядування, служб з утилізації відходів або в магазин, де ви придбали свій пристрій.

ҚАЗАҚША

CE СӘЙКЕСТІК ДЕКЛАРАЦИЯСЫ

Kensington бұл өнімнің қолданыстағы ЕҚ директиваларының негізгі талаптарына және басқа шарттарына сәйкестігі туралы мәлімдейді.

Еуропа үшін, осы өнімге арналған Сәйкестік декларациясының көшірмесін www.kensington.com/support.com сайтындағы Сәйкестік құжаттамасы сілтемесін басу арқылы алуға болады.

TEK EYPODАҚ EДEPINE APHАЛГAN AҚPAPAТ

 Тағбының пайдаланылуы бұл өнімді тұрмыстық қалдықтар ретінде қарастыруға болмайтындығын білдіреді. Бұл өнімді дұрыс әдіспен қорықса тастау арқылы қоршаған ортаға және адамдардың денсаулығына ықтимал зиянды әсерлерді болдырмауға көмектесесіз. Бұл өнімді утилизациялау жөнінде толығырақ ақпарат алу үшін жергілікті билік органдарына, тұрмыстық қорықтарды утилизациялау қызметіне немесе осы өнімді сатып алған дүкенге хабарласыңыз.

TÜRK

CE UYGUNLUK BEYANI

Kensington, bu ürünün önemli gereklilikleri ve diğer ilgili hükümleri ile uygulanabilir diğer EC yönetmeliklerine uygun olduğunu beyan etmektedir.

Avrupa için bu ürüne yönelik Uygunluk Beyanı'nın bir kopyası www.kensington.com/support bağlantısında Compliance Documentation (Uygunluk Belgeleri) bağlantısına tıklayarak elde edilebilir.

YALNIZCA AB ÜYESİ ÜLKELERE YÖNELİK BİLGİLER

 Bu sembolün kullanılması, bu ürünün evsel atık olarak işlem göremeyeceğini belirtmektedir. Bu ürünün doğru şekilde imha edilmesini sağlayarak aksi takdirde ürünün uygunsuz şekilde atık işleminde gerçekleştirilmesini yol açacağı ve ve insan sağlığı için olası olumsuz sonuçları önlemeye yardımcı olursunuz. Bu ürünün geri dönüştürülmesi hakkında daha ayrıntılı bilgi için lütfen şehrinizdeki yerel daireye, evsel atık imha hizmetiyne veya ürünü satın aldığınız mağazaya iletişime geçin.

ΕΛΛΗΝΙΚΑ

ΔΗΛΩΣΗ ΣΥΜΜΟΡΦΩΣΗΣ CE

Η Kensington δηλώνει ότι αυτό το προϊόν συμμορφώνεται με τις απαραίτητες απαιτήσεις και άλλες σχετικές προβλέψεις των ισχυουσών οδηγιών της ΕΚ.

Για την Ευρώπη, ένα αντίγραφο της Δήλωσης Συμμόρφωσης για το προϊόν αυτό μπορεί να ληφθεί κάνοντας κλικ στη σύνδεση της Τεκμηρίωσης συμμόρφωσης www.kensington.com/support.

ΠΛΗΡΟΦΟΡΙΕΣ ΑΠΟΚΛΕΙΣΤΙΚΑ ΓΙΑ ΚΡΑΤΗ-ΜΕΛΗ ΤΗΣ Ε.Ε.

 Η χρήση του συμβόλου υποδεικνύει ότι δεν επιτρέπεται η διαχείριση του προϊόντος αυτού ως οικιακό απόβλητο. Εξασφαλίζοντας την ορθή απόρριψη του προϊόντος αυτού, θα βοηθήσετε να αποτρέψετε πιθανές αρνητικές συνέπειες στο περιβάλλον και την ανθρώπινη υγεία, που θα μπορούσαν να προκληθούν από την ακατάλληλη απόρριψη του προϊόντος. Για περισσότερες αναλυτικές πληροφορίες σχετικά με την ανακύκλωση του προϊόντος, επικοινωνήστε με το δημαρχείο της πόλης σας, την αρχή διαχείρισης οικιακών απορριμμάτων σας ή το κατάστημα όπου αγοράσατε το προϊόν.

العربية

إعلان التوافق مع تشريعات السوق الأوربية

تقر كينسينجتون أن هذا المنتج على توافق مع المتطلبات الأساسية في توجيه السوق الأوربية وغيرها من الأحكام ذات الصلة المعمول بها ويمكن لأوروبا الحصول على نسخة من إعلان التوافق الذي حصل عليه هذا المنتج، وذلك بالتقر فوق رابط إعلان التوافق على الموقع الإلكتروني www.kensington.com/support.

معلومات مختصرة على الدول الأعضاء في الاتحاد الأوروبي

 يشير استخدام الرمز إلى أنه قد لا يتعامل مع هذا المنتج على أنه نفايات منزلية. وعند تأكيد من التخلص من هذا المنتج بشكل صحيح، فإنك تساعد على حماية البيئة والصحة البشرية من الآثار السلبية المحتملة عند التخلص منه بشكل غير صحيح. وللمزيد من المعلومات حول إعادة تدوير هذا المنتج، نرجى الاتصال بمكتب البلدية في منطقتك، أو خدمة التخلص من النفايات المنزلية التي تتعامل معها، أو المتجر الذي اشتريته منه المنتج.

Kensington®

ENGLISH

FEDERAL COMMUNICATION COMMISSION INTERFERENCE STATEMENT

Note: This equipment has been tested and found to comply with the limits for a Class B digital device, Pursuant to Part 15 of the FCC Rules. These limits are designed to provide reasonable protection against harmful interference in a residential installation. This equipment generates, uses and can radiate radio frequency energy and, if not installed and used in accordance with the instructions, may cause harmful interference to radio communications. However, there is no guarantee that interference will not occur in a particular installation. If this equipment does cause harmful interference to radio or television reception, which can be determined by turning the equipment off and on, the user is encouraged to try to correct the interference by one or more of the following measures:

- Reorient or relocate the receiving antenna
- Increase the separation between the equipment and receiver
- Connect the equipment into an outlet on a circuit different from that to which the receiver is connected
- Consult the dealer or an experienced radio/TV technician for help

Modifications: Modifications not expressly approved by Kensington may void the user's authority to operate the device under FCC regulations and must not be made.

Shielded Cables: In order to meet FCC requirements, all connections to equipment using a Kensington input device should be made using only the shielded cables.

FCC DECLARATION OF CONFORMITY

This product complies with Part 15 of the FCC rules. Operation is subject to the following two conditions:

(1) This device may not cause harmful interference, and (2) This device must accept any interference received, including interference that may cause undesired operation. As defined in Section 2.909 of the FCC Rules, the responsible party for this device is Kensington Computer Products Group, 1500 Fashion Island Blvd, 3rd Floor, San Mateo, CA 94404, USA, 800-535-4242.

IC STATEMENT

This class [B] digital apparatus complies with Canadian ICES-003, CAN ICES-3(B)/NMB-3(B)

CE DECLARATION OF CONFORMITY

Kensington declares that this product is in compliance with the essential requirements and other relevant provisions of applicable EC directives.

For Europe, a copy of the Declaration of Conformity for this product may be obtained by clicking on the Compliance Documentation link at www.kensington.com/support.

INFORMATION FOR EU MEMBER-STATES ONLY

 The use of the symbol indicates that this product may not be treated as household waste. By ensuring this product is disposed of correctly, you will help prevent potential negative consequences for the environment and human health, which could otherwise be caused by inappropriate waste handling of this product. For more detailed information about recycling of this product, please contact your local city office, your household waste disposal service, or the shop where you purchased the product.

FRANÇAIS

DÉCLARATION DE LA COMMISSION FÉDÉRALE DES COMMUNICATIONS (FCC) SUR L'INTERFÉRENCE DES FRÉQUENCES RADIO

Remarque : Cet équipement a été testé et déclaré conforme aux limitations s'appliquant aux périphériques numériques de classe B, conformément à l'article 15 de la réglementation de la FCC. Ces restrictions ont pour but d'offrir une protection raisonnable contre toute interférence nuisible dans une installation résidentielle. Cet appareil peut produire, utiliser et émettre des fréquences radio. S'il n'est pas installé ni utilisé conformément aux instructions, il risque d'engendrer des interférences nuisibles aux communications radio. Tout risque d'interférences ne peut toutefois pas être entièrement exclu. Si cet appareil provoque des interférences radio ou produit des parasites sur votre télévision, ce qui peut être déterminé en mettant l'appareil tour à tour hors tension puis sous tension, nous vous recommandons d'effectuer l'une des opérations suivantes :

- Réorienter ou déplacer l'antenne de réception
- Eloigner l'équipement du récepteur
- Connecter l'appareil sur une prise appartenant à un circuit différent de celui auquel est branché le récepteur

RF exposure statement

This equipment complies with the FCC RF radiation exposure limits set forth for an uncontrolled environment. This equipment should be installed and operated with a minimum distance of 20cm between the radiator and any part of your body.

This equipment meets the exemption from the routine evaluation limits in section 2.5 of RSS-102. It should be installed and operated with a minimum distance of 20cm between the radiator and any part of your body.

Cet équipement est conforme à l'exemption des limites d'évaluation habituelle de la section 2.5 de la norme RSS-102. Il doit être installé et utilisé à une distance minimale de 20 cm entre le radiateur et toute partie de votre corps.

IC WARNING

This device contains licence-exempt transmitter(s) that comply with Innovation, Science and Economic Development Canada's licence-exempt RSS(s). Operation is subject to the following two conditions:

- (1) This device may not cause interference.
- (2) This device must accept any interference, including interference that may cause undesired operation of the device.

L'émetteur/récepteur exempt de licence contenu dans le présent appareil est conforme aux CNR d'Innovation, Sciences et Développement économique Canada applicables aux appareils radio exempts de licence. L'exploitation est autorisée aux deux conditions suivantes:

1. L'appareil ne doit pas produire de brouillage;
2. L'appareil doit accepter tout brouillage radioélectrique subi, même si le brouillage est susceptible d'en compromettre le fonctionnement.

Caution:

Use the Product in the environment with the temperature Between -10°C and 40°C ; Otherwise, it may damage your product.
Products can only be used below 2000m altitude

For the following equipment:

Product Name: StudioCaddy™ with Wireless Charging

Brand Name: Kensington

Model No.: M01602

Kensington Computer Products Group, A Division of ACCO Brands USA LLC

E-mail: Benjamin.Hsu@kensington.com

hereby declares that this [Name: StudioCaddy™ with Wireless Charging, Model: M01602] is in compliance with the essential requirements and other relevant provisions of Directive 2014/53/EU and Radio Equipment Regulations 2017 (SI 2017 No. 1206, as amended by SI 2019 No. 696).



Adapter shall be installed near the equipment and shall be easily accessible.

Only can use adapter as below:

Power Adapter Model: ICP65-120-5000

Input: 100-240Vac, 50/60Hz, 1.5A Output: 12V, 5.0A, 60W

SHENZHEN SHI YING YUAN ELECTRONICS CO LTD

The plug considered as disconnect device of adapter.

This product is intended for sale and application in a business environment.

RED Article 10 2

-This product can be used across EU member states

RED Article 10 10

-The product is class 1 product, No restrictions

The RF distance between body and product is 20cm

Frequency Range: 112-205 kHz

Radiated H-Field: 38.67dBuA/m(@3m)