

# FCC Test Report

**FCC ID** : GV3M01477-P  
**Equipment** : Kensington PowerPoint ;  
Nobo Wireless Presentation Clicker  
**Model No.** : M01477-P  
**Brand Name** : Kensington ; Nobo  
**Applicant** : ACCO Brands, Inc.  
**Address** : 1500 Fashion Island Blvd., 3rd Floor San  
Mateo California 94404  
**Standard** : 47 CFR FCC Part 15.249  
**Received Date** : Nov. 20, 2019  
**Tested Date** : Dec. 02 ~ Dec. 05, 2019

We, International Certification Corp., would like to declare that the tested sample has been evaluated and in compliance with the requirement of the above standards. The test results contained in this report refer exclusively to the product. It may be duplicated completely for legal use with the approval of the applicant. It shall not be reproduced except in full without the written approval of our laboratory.

Reviewed by:

  
\_\_\_\_\_  
Along Chen / Assistant Manager

Approved by:

  
\_\_\_\_\_  
Gary Chang / Manager



---

## Table of Contents

<b>1</b>	<b>GENERAL DESCRIPTION .....</b>	<b>5</b>
1.1	Information.....	5
1.2	Local Support Equipment List .....	7
1.3	Test Setup Chart .....	7
1.4	The Equipment List .....	8
1.5	Test Standards .....	8
1.6	Deviation from Test Standard and Measurement Procedure.....	9
1.7	Measurement Uncertainty .....	9
<b>2</b>	<b>TEST CONFIGURATION .....</b>	<b>10</b>
2.1	Testing Condition .....	10
2.2	The Worst Test Modes and Channel Details .....	10
<b>3</b>	<b>TRANSMITTER TEST RESULTS.....</b>	<b>11</b>
3.1	Conducted Emissions.....	11
3.2	Radiated Emission .....	14
3.3	20dB and Occupied Bandwidth .....	26
<b>4</b>	<b>TEST LABORATORY INFORMATION .....</b>	<b>27</b>

---

## Release Record

Report No.	Version	Description	Issued Date
FR9N2001	Rev. 01	Initial issue	Jan. 03, 2020

## Summary of Test Results

FCC Rules	Test Items	Measured	Result
15.207	AC Power Line Conducted Emissions	[dBuV]: 4.493MHz 37.75 (Margin -18.25dB) - QP	Pass
15.249(a)	Field Strength of Fundamental	Meet the requirement of limit	Pass
15.249(a)(d)	Field Strength of Harmonics and Emissions Radiated outside of the Specified Frequency Bands	Meet the requirement of limit	Pass
15.215(c)	20dB bandwidth	Meet the requirement of limit	Pass
15.203	Antenna Requirement	Meet the requirement of limit	Pass

### Declaration of Conformity:

The test results with all measurement uncertainty excluded are presented in accordance with the regulation limits or requirements declared by manufacturers.

### Comments and Explanations:

The declared of product specification for EUT presented in the report are provided by the manufacturer, and the manufacturer takes all the responsibilities for the accuracy of product specification.

# 1 General Description

## 1.1 Information

### 1.1.1 Product Details

The following models are provided to this EUT.

Brand Name	Model Name	Product Name	Description
Kensington	M01477-P	Kensington PowerPoint	For black outer appearance
Nobo		Nobo Wireless Presentation Clicker	For white outer appearance
† All models are electrically identical, different brand names are for marketing purpose.			

### 1.1.2 Specification of the Equipment under Test (EUT)

RF General Information				
Frequency Range (MHz)	Modulation	Ch. Freq. (MHz)	Channel Number	Data/Bit Rate
2404-2478	GFSK	2404-2478	1-38 [38]	1 Mbps

### 1.1.3 Antenna Details

Ant. No.	Type	Gain (dBi)	Connector	Remark
1	PIFA	-1	N/A	---

### 1.1.4 Power Supply Type of Equipment under Test (EUT)

<b>Power Supply Type</b>	Built-in 250mAh lithium battery Brand: Shenzhen Calion Power Co., Ltd. Model: PL 502030
--------------------------	---

### 1.1.5 Accessories

No.	Equipment	Description
1	USB cable (for charging use)	0.45m shielded without core

### 1.1.6 Channel List

Channel	Frequency (MHz)	Channel	Frequency (MHz)	Channel	Frequency (MHz)	Channel	Frequency (MHz)
1	2404	11	2424	21	2444	31	2464
2	2406	12	2426	22	2446	32	2466
3	2408	13	2428	23	2448	33	2468
4	2410	14	2430	24	2450	34	2470
5	2412	15	2432	25	2452	35	2472
6	2414	16	2434	26	2454	36	2474
7	2416	17	2436	27	2456	37	2476
8	2418	18	2438	28	2458	38	2478
9	2420	19	2440	29	2460	--	--
10	2422	20	2442	30	2462	--	--

### 1.1.7 Test Tool and Duty Cycle

<b>Test Tool</b>	Hardware-control	
<b>Duty Cycle and Duty Factor</b>	<b>Duty Cycle (%)</b>	<b>Duty Factor (dB)</b>
	100	0

## 1.2 Local Support Equipment List

Support Equipment List					
No.	Equipment	Brand	Model	FCC ID	Remarks
1	Adapter	Samsung	ETA-U90JWS	---	---

## 1.3 Test Setup Chart

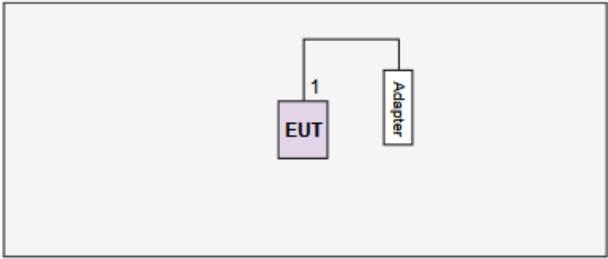
Test Setup Diagram	
 <p>The diagram shows a rectangular box containing two components: a purple box labeled 'EUT' with the number '1' above it, and a white box labeled 'Adapter' to its right. A line connects the top of the 'EUT' box to the top of the 'Adapter' box, indicating a connection between them.</p>	
No.	Signal cable / Length (m)
1	USB, 0.45m shielded

## 1.4 The Equipment List

Test Item	Conducted Emission				
Test Site	Conduction room 1 / (CO01-WS)				
Instrument	Manufacturer	Model No.	Serial No.	Calibration Date	Calibration Until
Receiver	R&S	ESR3	101657	Jan. 08, 2019	Jan. 07, 2020
LISN	R&S	ENV216	101579	Mar. 08, 2019	Mar. 07, 2020
RF Cable-CON	Woken	CFD200-NL	CFD200-NL-001	Oct. 22, 2019	Oct. 21, 2020
Measurement Software	AUDIX	e3	6.120210k	NA	NA

Note: Calibration Interval of instruments listed above is one year.

Test Item	Radiated Emission				
Test Site	966 chamber1 / (03CH01-WS)				
Instrument	Manufacturer	Model No.	Serial No.	Calibration Date	Calibration Until
Spectrum Analyzer	R&S	FSV40	101498	Dec. 27, 2018	Dec. 26, 2019
Receiver	R&S	ESR3	101658	Dec. 11, 2018	Dec. 10, 2019
Bilog Antenna	SCHWARZBECK	VULB9168	VULB9168-522	Jul. 12, 2019	Jul. 11, 2020
Horn Antenna 1G-18G	SCHWARZBECK	BBHA 9120 D	BBHA 9120 D 1096	Dec. 18, 2018	Dec. 17, 2019
Horn Antenna 18G-40G	SCHWARZBECK	BBHA 9170	BBHA 9170517	Nov. 15, 2019	Nov. 14, 2020
Loop Antenna	R&S	HFH2-Z2	100330	Nov. 13, 2019	Nov. 12, 2020
Loop Antenna Cable	KOAX KABEL	101354-BW	101354-BW	Oct. 07, 2019	Oct. 06, 2020
Preamplifier	EMC	EMC02325	980225	Jul. 09, 2019	Jul. 08, 2020
Preamplifier	Agilent	83017A	MY39501308	Oct. 08, 2019	Oct. 07, 2020
Preamplifier	EMC	EMC184045B	980192	Aug. 01, 2019	Jul. 31, 2020
RF Cable	EMC	EMC104-SM-SM-8000	181106	Oct. 07, 2019	Oct. 06, 2020
RF Cable	HUBER+SUHNER	SUCOFLEX104	MY16019/4	Oct. 07, 2019	Oct. 06, 2020
RF Cable	HUBER+SUHNER	SUCOFLEX104	MY16014/4	Oct. 07, 2019	Oct. 06, 2020
LF cable 1M	EMC	EMCCFD400-NM-NM-1000	160502	Oct. 07, 2019	Oct. 06, 2020
LF cable 3M	Woken	CFD400NL-LW	CFD400NL-001	Oct. 07, 2019	Oct. 06, 2020
LF cable 10M	Woken	CFD400NL-LW	CFD400NL-002	Oct. 07, 2019	Oct. 06, 2020
Measurement Software	AUDIX	e3	6.120210g	NA	NA

Note: Calibration Interval of instruments listed above is one year.

## 1.5 Test Standards

According to the specification of EUT, the EUT must comply with following standards and KDB documents.

47 CFR FCC Part 15.249

ANSI C63.10-2013



## 1.6 Deviation from Test Standard and Measurement Procedure

None

## 1.7 Measurement Uncertainty

ISO/IEC 17025 requires that an estimate of the measurement uncertainties associated with the emissions test results be included in the report. The measurement uncertainties given below are based on a 95% confidence level (based on a coverage factor (k=2)).

Measurement Uncertainty	
Parameters	Uncertainty
Bandwidth	±34.130 Hz
AC conducted emission	±2.92 dB
Radiated emission ≤ 1GHz	±3.41 dB
Radiated emission > 1GHz	±4.59 dB

## 2 Test Configuration

### 2.1 Testing Condition

Test Item	Test Site	Ambient Condition	Tested By
AC Conduction	CO01-WS	22°C / 69%	Akun Chung
Radiated Emissions	03CH01-WS	22-23°C / 65-68%	Aska Huang Roger Lu

- FCC Designation No.: TW2732
- FCC site registration No.: 181692
- ISED#: 10807A
- CAB identifier: TW2732

### 2.2 The Worst Test Modes and Channel Details

Test item	Mode	Test Frequency (MHz)	Data Rate	Test Configuration
AC Power Line Conducted Emissions	GFSK	2440	1 Mbps	-
Field Strength of Fundamental	GFSK	2404, 2440, 2478	1 Mbps	-
Radiated Emissions ≤ 1GHz	GFSK	2440	1 Mbps	-
Radiated Emissions > 1GHz	GFSK	2404, 2440, 2478	1 Mbps	-
20dB bandwidth	GFSK	2404, 2440, 2478	1 Mbps	-

**NOTE:**

1. The EUT was pretested with 3 orientations placed on the table for the radiated emission measurement – X, Y, and Z-plane. The **X-plane** results were found as the worst case and were shown in this report.

## 3 Transmitter Test Results

### 3.1 Conducted Emissions

#### 3.1.1 Limit of Conducted Emissions

Conducted Emissions Limit		
Frequency Emission (MHz)	Quasi-Peak	Average
0.15-0.5	66 - 56 *	56 - 46 *
0.5-5	56	46
5-30	60	50

Note 1: \* Decreases with the logarithm of the frequency.

#### 3.1.2 Test Procedures

1. The device is placed on a test table, raised 80 cm above the reference ground plane. The vertical conducting plane is located 40 cm to the rear of the device.
2. The device is connected to line impedance stabilization network (LISN) and other accessories are connected to other LISN. Measured levels of AC power line conducted emission are across the 50  $\Omega$  LISN port.
3. AC conducted emission measurements is made over frequency range from 150 kHz to 30 MHz.
4. This measurement was performed with AC 120V / 60Hz.

#### 3.1.3 Test Setup



- Note: 1. Support units were connected to second LISN.  
 2. Both of LISNs (AMN) are 80 cm from EUT and at least 80 cm from other units and other metal planes

### 3.1.4 Test Result of Conducted Emissions

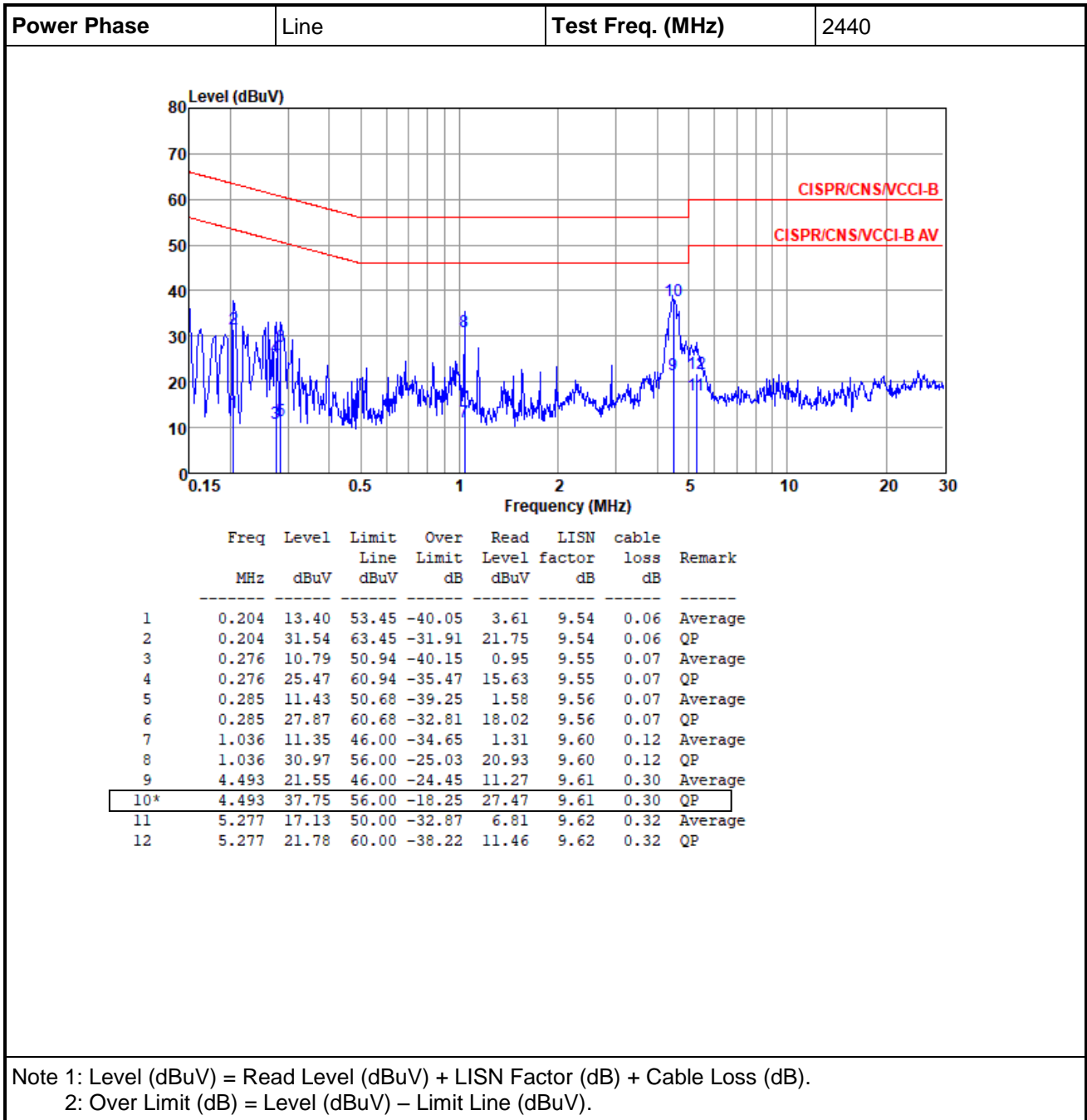

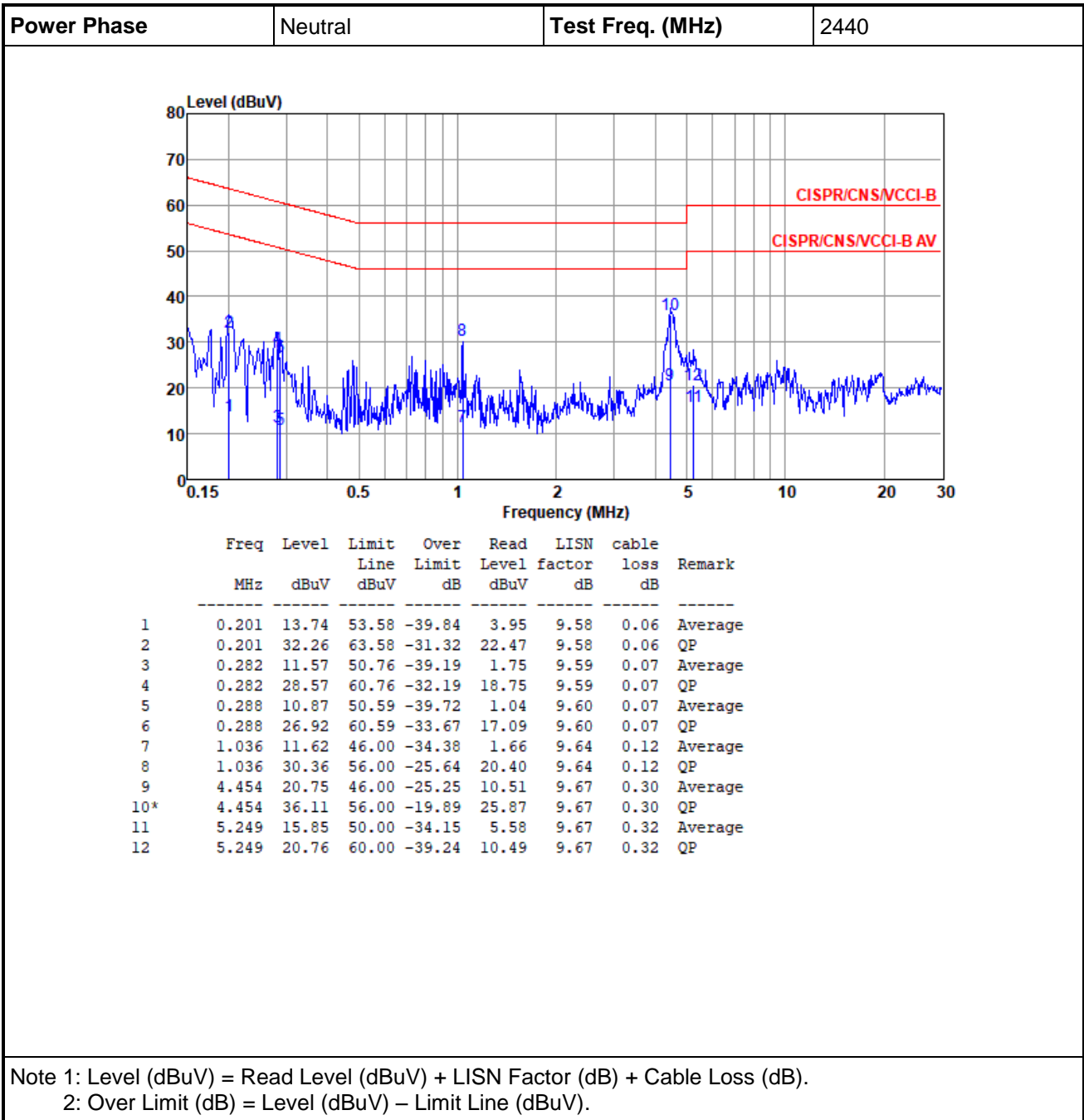

## 3.2 Radiated Emission

This section includes field strength of fundamental, field strength of harmonics and emissions radiated outside of the operating frequency bands.

### 3.2.1 Limit of field strength of fundamental and field strength of harmonics

Fundamental Frequency	Field strength of fundamental (millivolts/meter)	Field strength of harmonics (microvolts/meter)
2400–2483.5 MHz	50	500

### 3.2.2 Limit of Unwanted Emissions

Emissions radiated outside of the specified frequency bands, except for harmonics, shall be attenuated by at least 50 dB below the level of the fundamental or to the general radiated emission limits in below table, whichever is the lesser attenuation.

Radiated emission limits			
Frequency Range (MHz)	Field Strength (uV/m)	Field Strength (dBuV/m)	Measure Distance (m)
0.009~0.490	2400/F(kHz)	48.5 - 13.8	300
0.490~1.705	24000/F(kHz)	33.8 - 23	30
1.705~30.0	30	29	30
30~88	100	40	3
88~216	150	43.5	3
216~960	200	46	3
Above 960	500	54	3

**Note 1:**

Qusai-Peak value is measured for frequency below 1GHz except for 9–90 kHz, 110–490 kHz frequency band. Peak and average value are measured for frequency above 1GHz. The limit on average radio frequency emission is as above table. The limit on peak radio frequency emissions is 20 dB above the maximum permitted average emission limit

**Note 2:**

Measurements may be performed at a distance other than what is specified provided. When performing measurements at a distance other than that specified, the results shall be extrapolated to the specified distance using an extrapolation factor as below, Frequency at or above 30 MHz: 20 dB/decade Frequency below 30 MHz: 40 dB/decade.

### 3.2.3 Test Procedures

1. Measurement is made at a semi-anechoic chamber that incorporates a turntable allowing a EUT rotation of 360°. A continuously-rotating, remotely-controlled turntable is installed at the test site to support the EUT and facilitate determination of the direction of maximum radiation for each EUT emission frequency. The EUT is placed at test table. For emissions testing at or below 1 GHz, the table height is 80 cm above the reference ground plane. For emission measurements above 1 GHz, the table height is 1.5 m
2. Measurement is made with the antenna positioned in both the horizontal and vertical planes of polarization. The measurement antenna is varied in height (1m ~ 4m) above the reference ground plane to obtain the maximum signal strength. Distance between EUT and antenna is 3 m.
3. This investigation is performed with the EUT rotated 360°, the antenna height scanned between 1 m and 4 m, and the antenna rotated to repeat the measurements for both the horizontal and vertical antenna polarizations.

Note:

1. Radiated emission below 1GHz  
120kHz measurement bandwidth of test receiver and Quasi-peak detector is for radiated emission
2. Radiated emission above 1GHz / Peak value except fundamental  
RBW=2MHz, VBW=10MHz and Peak detector
3. Radiated emission above 1GHz / Average value for field strength of fundamental and harmonics  
The average value is: Average = Peak value + 20log(Duty cycle) Where the duty factor is calculated from following formula:

$$20\log (\text{Duty cycle}) = 20\log \frac{0.3 \times 6 \text{ ms}}{100 \text{ ms}} = -34.89\text{dB}$$

Please see page 25 for plotted duty

4. Radiated emission above 1GHz / Average value for other emissions  
RBW=1MHz, VBW=10Hz and Peak detector
5. Radiated emission Peak value for fundamental  
RBW=3MHz, VBW=10MHz and Peak detector

### 3.2.4 Test Setup

#### Radiated Emissions below 1 GHz

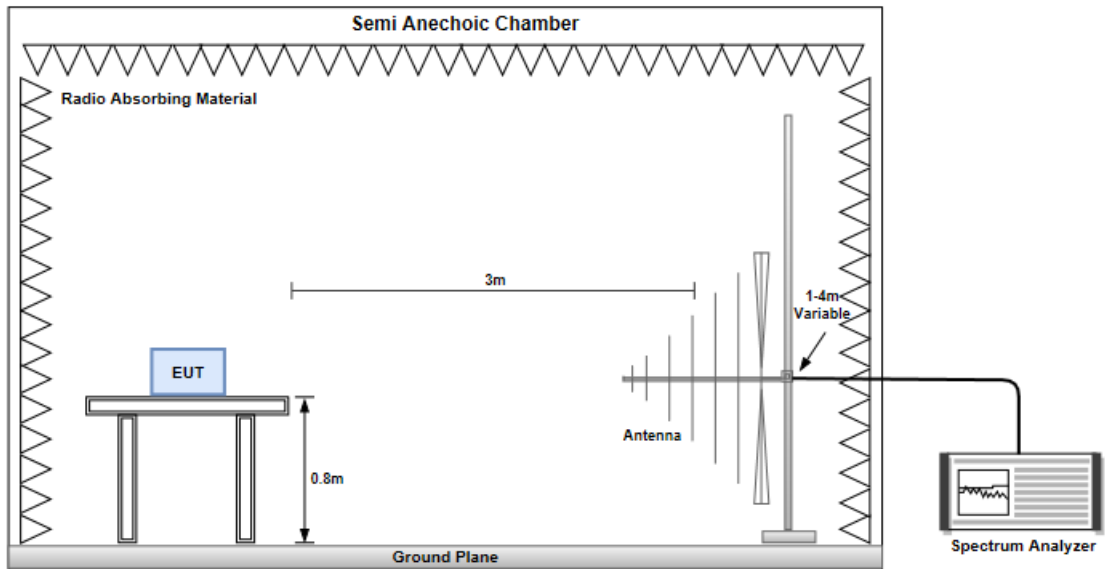

#### Radiated Emissions above 1 GHz

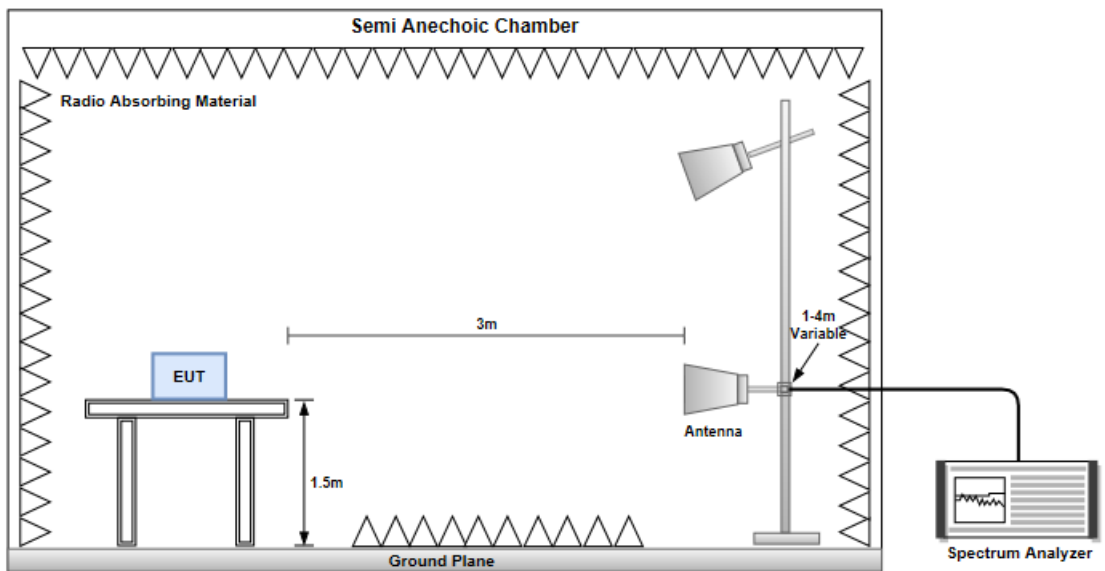



### 3.2.5 Transmitter Radiated Unwanted Emissions (Below 1GHz)

<b>Modulation</b>	GFSK	<b>Test Freq. (MHz)</b>	2440
<b>Polarization</b>	Horizontal		

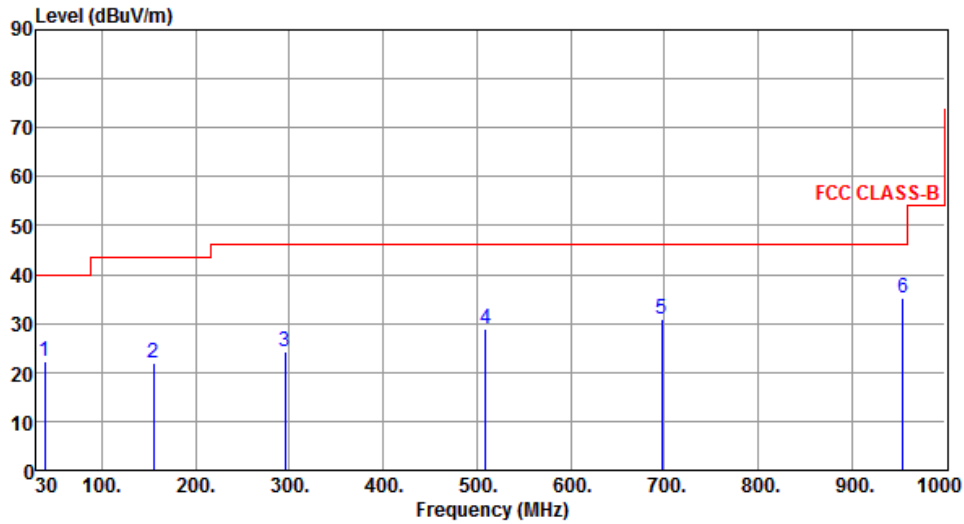

	Freq. MHz	Emission level dBuV/m	Limit dBuV/m	Margin dB	SA reading dBuV	Factor dB	Remark	ANT High cm	Turn Table deg
1	38.73	22.14	40.00	-17.86	30.90	-8.76	Peak	---	---
2	155.13	22.06	43.50	-21.44	30.39	-8.33	Peak	---	---
3	295.78	24.19	46.00	-21.81	32.37	-8.18	Peak	---	---
4	509.18	28.86	46.00	-17.14	31.79	-2.93	Peak	---	---
5	697.36	30.91	46.00	-15.09	30.53	0.38	Peak	---	---
6	954.41	35.26	46.00	-10.74	30.45	4.81	Peak	---	---

Note 1: Emission Level (dBuV/m) = SA Reading (dBuV/m) + Factor\* (dB)

\*Factor includes antenna factor , cable loss and amplifier gain

Note 2: Margin (dB) = Emission level (dBuV/m) – Limit (dBuV/m).

Note 3: All spurious emissions below 30MHz are more than 20 dB below the limit.

<b>Modulation</b>	GFSK	<b>Test Freq. (MHz)</b>	2440
<b>Polarization</b>	Vertical		

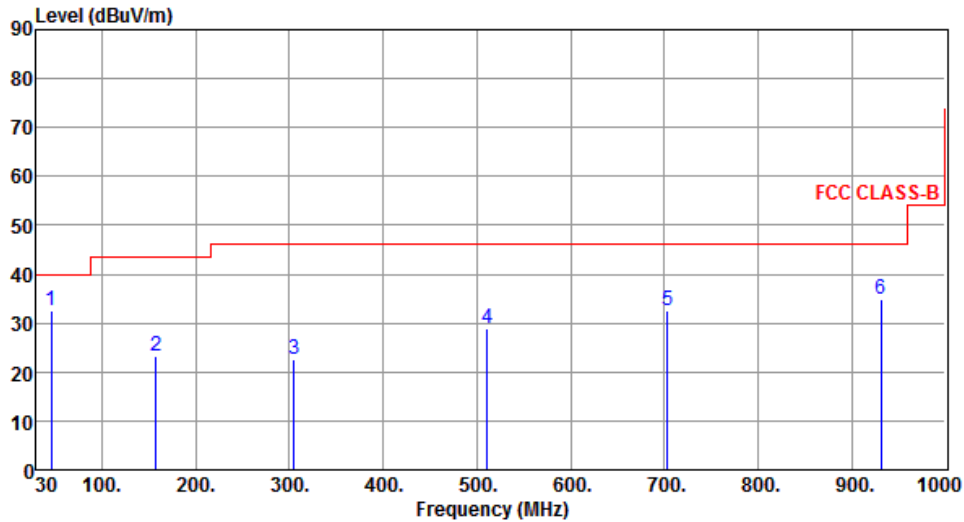

	Freq. MHz	Emission level dBuV/m	Limit dBuV/m	Margin dB	SA reading dBuV	Factor dB	Remark	ANT High cm	Turn Table deg
1	45.52	32.55	40.00	-7.45	40.92	-8.37	Peak	---	---
2	158.04	23.30	43.50	-20.20	31.73	-8.43	Peak	---	---
3	304.51	22.68	46.00	-23.32	30.57	-7.89	Peak	---	---
4	511.12	28.92	46.00	-17.08	31.83	-2.91	Peak	---	---
5	703.18	32.43	46.00	-13.57	31.86	0.57	Peak	---	---
6	931.13	34.77	46.00	-11.23	30.19	4.58	Peak	---	---

Note 1: Emission Level (dBuV/m) = SA Reading (dBuV/m) + Factor\* (dB)

\*Factor includes antenna factor , cable loss and amplifier gain

Note 2: Margin (dB) = Emission level (dBuV/m) – Limit (dBuV/m).

Note 3: All spurious emissions below 30MHz are more than 20 dB below the limit.

### 3.2.6 Transmitter Radiated Unwanted Emissions (Above 1GHz)

<b>Modulation</b>	GFSK	<b>Test Freq. (MHz)</b>	2404
<b>Polarization</b>	Horizontal		

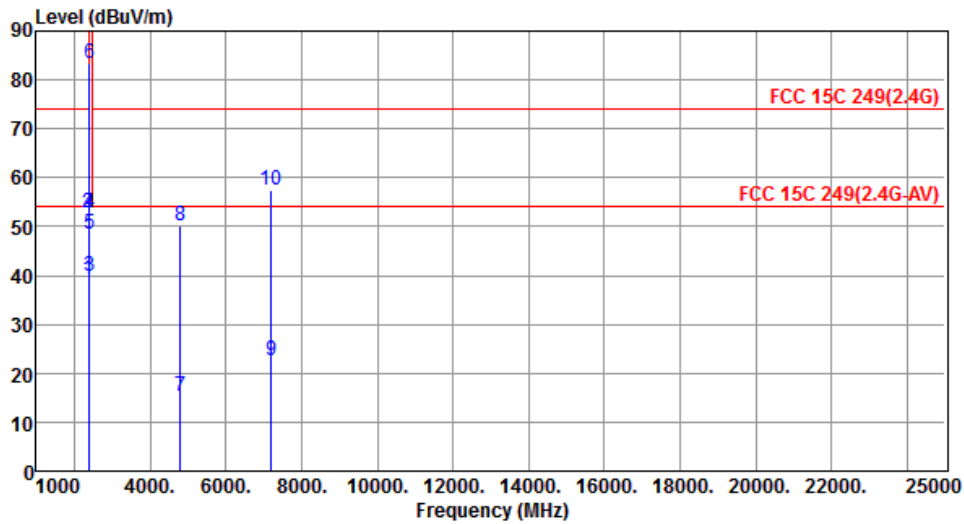

	Freq. MHz	Emission level dBuV/m	Limit dBuV/m	Margin dB	SA reading dBuV	Factor dB	Remark	ANT High cm	Turn Table deg
1	2390.00	39.16	54.00	-14.84	41.98	-2.82	Average	317	239
2	2390.00	52.88	74.00	-21.12	55.70	-2.82	Peak	317	239
3	2400.00	39.91	54.00	-14.09	42.75	-2.84	Average	317	239
4	2400.00	52.88	74.00	-21.12	55.72	-2.84	Peak	317	239
5	2404.00	48.54	94.00	-45.46	51.39	-2.85	Average	317	239
6	2404.00	83.43	114.00	-30.57	86.28	-2.85	Peak	317	239
7	4808.00	15.30	54.00	-38.70	11.77	3.53	Average	227	161
8	4808.00	50.19	74.00	-23.81	46.66	3.53	Peak	227	161
9	7212.00	22.46	54.00	-31.54	13.44	9.02	Average	202	2
10	7212.00	57.35	74.00	-16.65	48.33	9.02	Peak	202	2

Note 1: Emission Level (dBuV/m) = SA Reading (dBuV/m) + Factor\* (dB)

\*Factor includes antenna factor, cable loss and amplifier gain

Note 2: Margin (dB) = Emission level (dBuV/m) – Limit (dBuV/m).

<b>Modulation</b>	GFSK	<b>Test Freq. (MHz)</b>	2404
<b>Polarization</b>	Vertical		

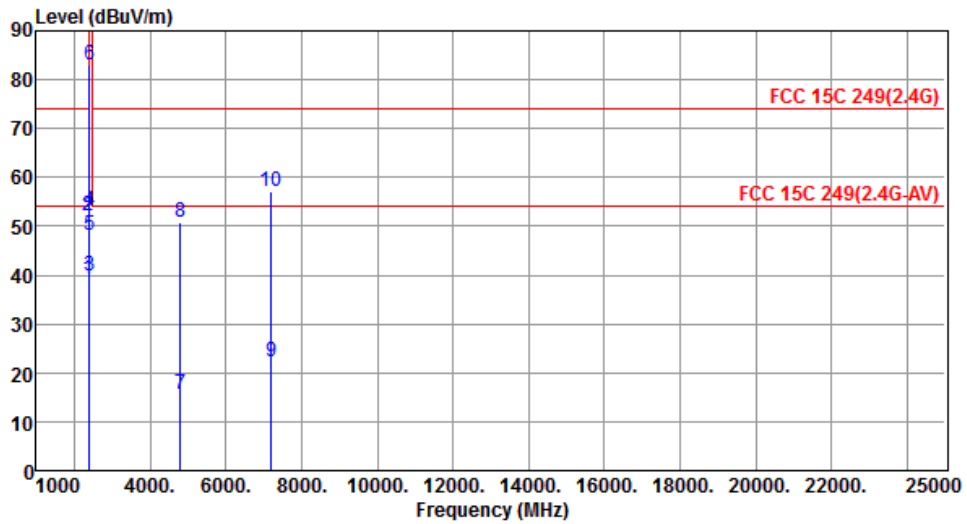

	Freq. MHz	Emission level dBuV/m	Limit dBuV/m	Margin dB	SA reading dBuV	Factor dB	Remark	ANT High cm	Turn Table deg
1	2390.00	39.04	54.00	-14.96	41.86	-2.82	Average	345	189
2	2390.00	52.28	74.00	-21.72	55.10	-2.82	Peak	345	189
3	2400.00	39.73	54.00	-14.27	42.57	-2.84	Average	345	189
4	2400.00	53.05	74.00	-20.95	55.89	-2.84	Peak	345	189
5	2404.00	47.99	94.00	-46.01	50.84	-2.85	Average	345	189
6	2404.00	82.88	114.00	-31.12	85.73	-2.85	Peak	345	189
7	4808.00	15.76	54.00	-38.24	12.23	3.53	Average	289	173
8	4808.00	50.65	74.00	-23.35	47.12	3.53	Peak	289	173
9	7212.00	22.29	54.00	-31.71	13.27	9.02	Average	205	235
10	7212.00	57.18	74.00	-16.82	48.16	9.02	Peak	205	235

Note 1: Emission Level (dBuV/m) = SA Reading (dBuV/m) + Factor\* (dB)

\*Factor includes antenna factor , cable loss and amplifier gain

Note 2: Margin (dB) = Emission level (dBuV/m) – Limit (dBuV/m).

<b>Modulation</b>	GFSK	<b>Test Freq. (MHz)</b>	2440
<b>Polarization</b>	Horizontal		

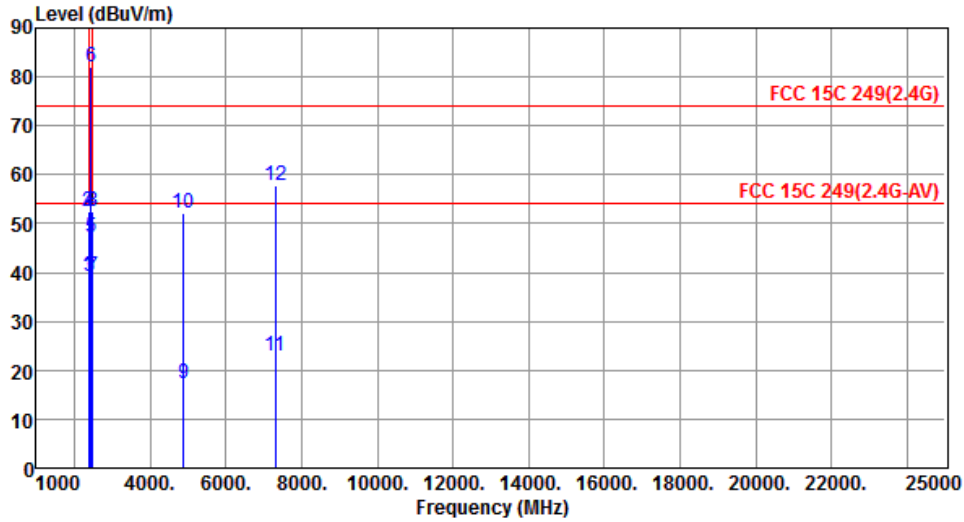

	Freq. MHz	Emission level dBuV/m	Limit dBuV/m	Margin dB	SA reading dBuV	Factor dB	Remark	ANT High cm	Turn Table deg
1	2390.00	39.15	54.00	-14.85	41.97	-2.82	Average	301	49
2	2390.00	52.53	74.00	-21.47	55.35	-2.82	Peak	301	49
3	2400.00	39.13	54.00	-14.87	41.97	-2.84	Average	301	49
4	2400.00	52.39	74.00	-21.61	55.23	-2.84	Peak	301	49
5	2440.00	47.06	94.00	-46.94	49.93	-2.87	Average	301	49
6	2440.00	81.95	114.00	-32.05	84.82	-2.87	Peak	301	49
7	2483.50	39.07	54.00	-14.93	42.03	-2.96	Average	301	49
8	2483.50	52.42	74.00	-21.58	55.38	-2.96	Peak	301	49
9	4880.00	17.25	54.00	-36.75	13.66	3.59	Average	261	155
10	4880.00	52.14	74.00	-21.86	48.55	3.59	Peak	261	155
11	7320.00	22.98	54.00	-31.02	13.82	9.16	Average	204	0
12	7320.00	57.87	74.00	-16.13	48.71	9.16	Peak	204	0

Note 1: Emission Level (dBuV/m) = SA Reading (dBuV/m) + Factor\* (dB)

\*Factor includes antenna factor , cable loss and amplifier gain

Note 2: Margin (dB) = Emission level (dBuV/m) – Limit (dBuV/m).

<b>Modulation</b>	GFSK	<b>Test Freq. (MHz)</b>	2440
<b>Polarization</b>	Vertical		

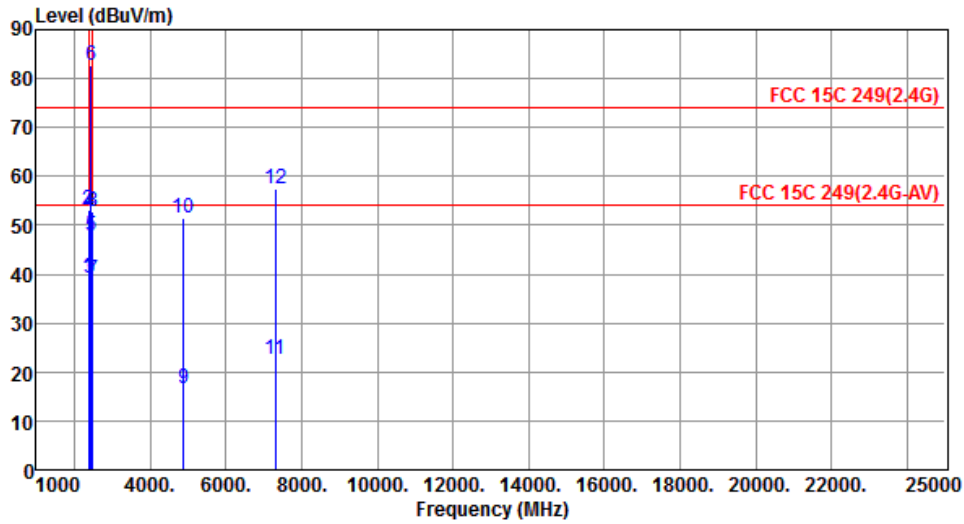

	Freq. MHz	Emission level dBuV/m	Limit dBuV/m	Margin dB	SA reading dBuV	Factor dB	Remark	ANT High cm	Turn Table deg
1	2390.00	39.09	54.00	-14.91	41.91	-2.82	Average	378	206
2	2390.00	53.21	74.00	-20.79	56.03	-2.82	Peak	378	206
3	2400.00	39.11	54.00	-14.89	41.95	-2.84	Average	378	206
4	2400.00	52.89	74.00	-21.11	55.73	-2.84	Peak	378	206
5	2440.00	47.78	94.00	-46.22	50.65	-2.87	Average	378	206
6	2440.00	82.67	114.00	-31.33	85.54	-2.87	Peak	378	206
7	2483.50	38.93	54.00	-15.07	41.89	-2.96	Average	378	206
8	2483.50	52.78	74.00	-21.22	55.74	-2.96	Peak	378	206
9	4880.00	16.70	54.00	-37.30	13.11	3.59	Average	236	189
10	4880.00	51.59	74.00	-22.41	48.00	3.59	Peak	236	189
11	7320.00	22.67	54.00	-31.33	13.51	9.16	Average	214	234
12	7320.00	57.56	74.00	-16.44	48.40	9.16	Peak	214	234

Note 1: Emission Level (dBuV/m) = SA Reading (dBuV/m) + Factor\* (dB)

\*Factor includes antenna factor , cable loss and amplifier gain

Note 2: Margin (dB) = Emission level (dBuV/m) – Limit (dBuV/m).

<b>Modulation</b>	GFSK	<b>Test Freq. (MHz)</b>	2478
<b>Polarization</b>	Horizontal		

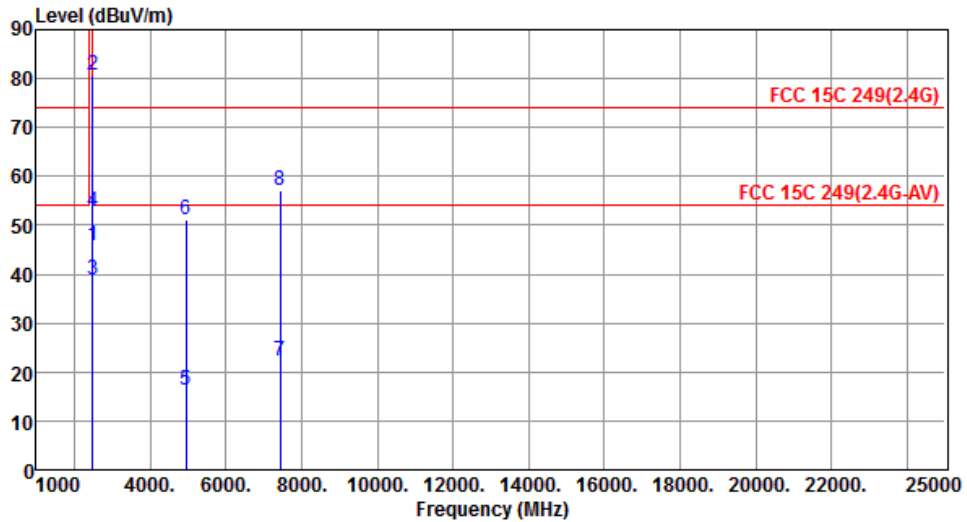

	Freq. MHz	Emission level dBuV/m	Limit dBuV/m	Margin dB	SA reading dBuV	Factor dB	Remark	ANT High cm	Turn Table deg
1	2478.00	45.91	94.00	-48.09	48.86	-2.95	Average	295	50
2	2478.00	80.80	114.00	-33.20	83.75	-2.95	Peak	295	50
3	2483.50	38.80	54.00	-15.20	41.76	-2.96	Average	295	50
4	2483.50	52.77	74.00	-21.23	55.73	-2.96	Peak	295	50
5	4956.00	16.28	54.00	-37.72	12.49	3.79	Average	257	152
6	4956.00	51.17	74.00	-22.83	47.38	3.79	Peak	257	152
7	7434.00	22.30	54.00	-31.70	13.38	8.92	Average	214	0
8	7434.00	57.19	74.00	-16.81	48.27	8.92	Peak	214	0

Note 1: Emission Level (dBuV/m) = SA Reading (dBuV/m) + Factor\* (dB)

\*Factor includes antenna factor , cable loss and amplifier gain

Note 2: Margin (dB) = Emission level (dBuV/m) – Limit (dBuV/m).

<b>Modulation</b>	GFSK	<b>Test Freq. (MHz)</b>	2478
<b>Polarization</b>	Vertical		

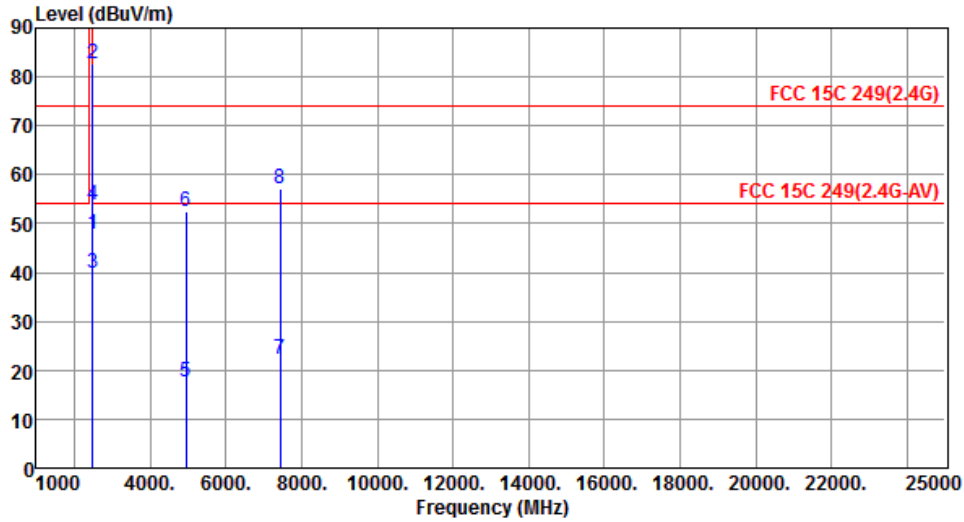

	Freq. MHz	Emission level dBuV/m	Limit dBuV/m	Margin dB	SA reading dBuV	Factor dB	Remark	ANT High cm	Turn Table deg
1	2478.00	47.89	94.00	-46.11	50.84	-2.95	Average	390	183
2	2478.00	82.78	114.00	-31.22	85.73	-2.95	Peak	390	183
3	2483.50	39.93	54.00	-14.07	42.89	-2.96	Average	390	183
4	2483.50	53.92	74.00	-20.08	56.88	-2.96	Peak	390	183
5	4956.00	17.53	54.00	-36.47	13.74	3.79	Average	259	201
6	4956.00	52.42	74.00	-21.58	48.63	3.79	Peak	259	201
7	7434.00	22.17	54.00	-31.83	13.25	8.92	Average	100	228
8	7434.00	57.06	74.00	-16.94	48.14	8.92	Peak	100	228

Note 1: Emission Level (dBuV/m) = SA Reading (dBuV/m) + Factor\* (dB)

\*Factor includes antenna factor, cable loss and amplifier gain

Note 2: Margin (dB) = Emission level (dBuV/m) – Limit (dBuV/m).



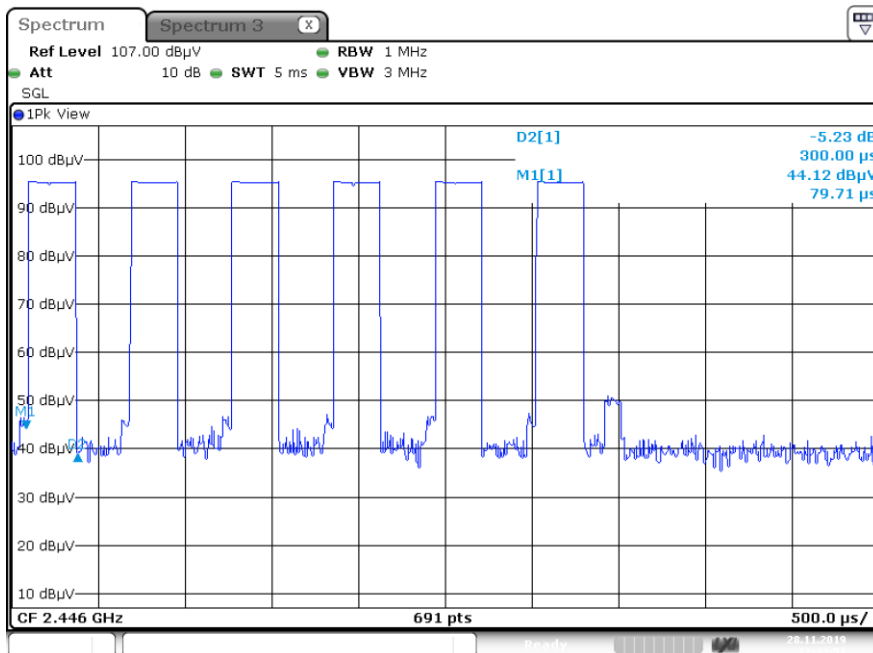
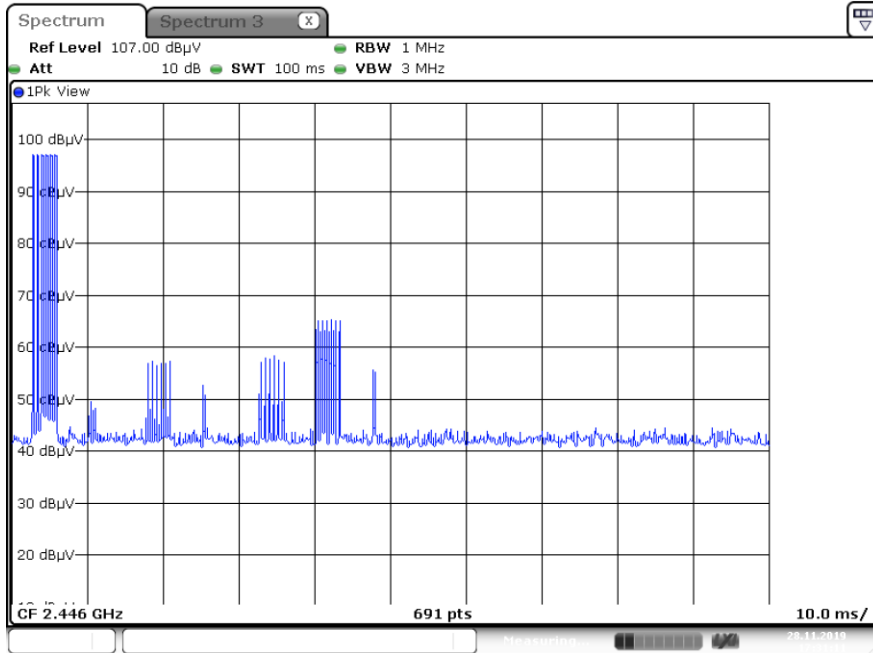

$$20\log(\text{Duty cycle}) = 20\log \frac{0.3 \times 6 \text{ ms}}{100 \text{ ms}} = -34.89\text{dB}$$

### 3.3 20dB and Occupied Bandwidth

#### 3.3.1 Test Procedures

1. Set resolution bandwidth (RBW) =20 kHz, Video bandwidth = 100 kHz.
2. Detector = Peak, Trace mode = max hold
3. Sweep = auto couple, Allow the trace to stabilize.
4. Measure the maximum width of the emission that is constrained by the frequencies associated with the two outermost amplitude points (upper and lower) that are attenuated by 20dB relative to the maximum level measured in the fundamental emission.
5. Use the occupied measurement function of spectrum analyzer to measure 99% occupied bandwidth.

#### 3.3.2 Test Setup

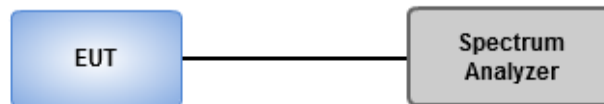

#### 3.3.3 20dB and Occupied Bandwidth

Freq. (MHz)	20dB Bandwidth (MHz)	Occupied Bandwidth (MHz)
2404	1.042	1.027
2440	1.049	1.035
2478	1.042	1.027

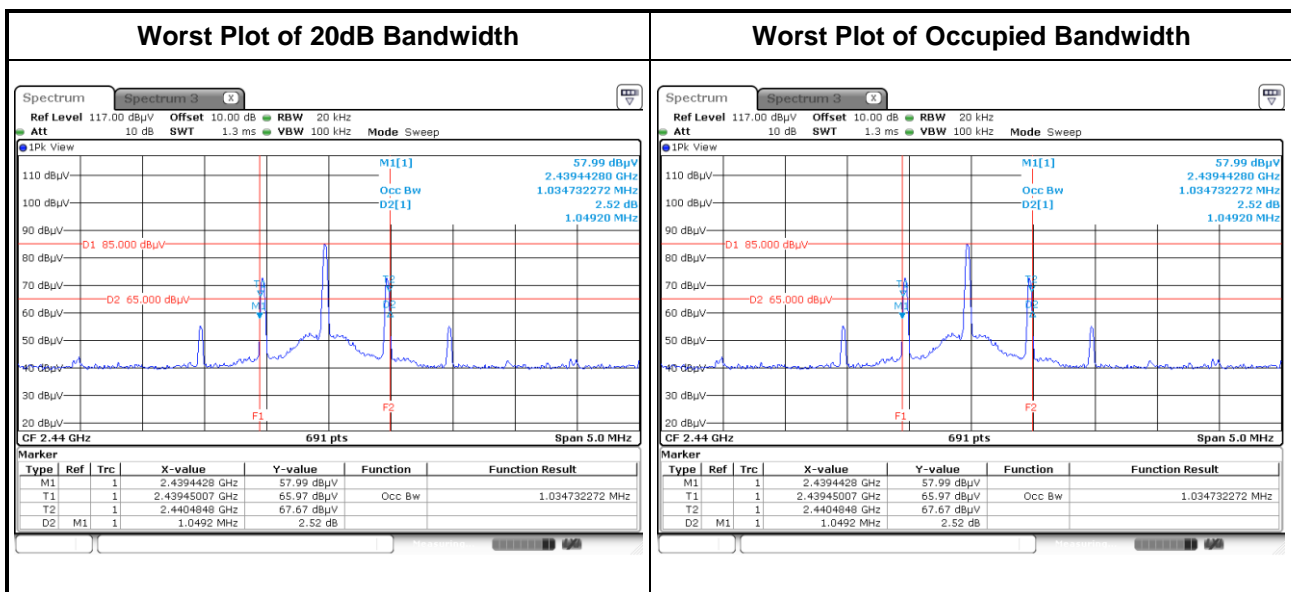

## 4 Test laboratory information

Established in 2012, ICC provides foremost EMC & RF Testing and advisory consultation services by our skilled engineers and technicians. Our services employ a wide variety of advanced edge test equipment and one of the widest certification extents in the business.

International Certification Corp (EMC and Wireless Communication Laboratory), it is our definitive objective is to institute long term, trust-based associations with our clients. The expectation we set up with our clients is based on outstanding service, practical expertise and devotion to a certified value structure. Our passion is to grant our clients with best EMC / RF services by oriented knowledgeable and accommodating staff.

Our Test sites are located at Linkou District and Kwei Shan District. Location map can be found on our website <http://www.icertifi.com.tw>.

### **Linkou**

Tel: 886-2-2601-1640

No. 30-2, Ding Fwu Tsuen, Lin  
Kou District, New Taipei City,  
Taiwan, R.O.C.

### **Kwei Shan**

Tel: 886-3-271-8666

No. 3-1, Lane 6, Wen San 3rd St.,  
Kwei Shan District, Tao Yuan City  
333, Taiwan, R.O.C.

### **Kwei Shan Site II**

Tel: 886-3-271-8640

No. 14-1, Lane 19, Wen San 3rd  
St., Kwei Shan District, Tao Yuan  
City 333, Taiwan, R.O.C.

If you have any suggestion, please feel free to contact us as below information.

Tel: 886-3-271-8666

Fax: 886-3-318-0155

Email: ICC\_Service@icertifi.com.tw

==END==