



FCC RADIO TEST REPORT

FCC ID: GV3M01308-M

Product Name:	Wireless Mouse
Trademark:	N/A
Model Number:	M01308-M
Prepared For :	ACCO Brands, Inc.
Address :	333 Twin Dolphin Drive, 6th Floor, Redwood Shores, California, United States
Prepared By :	Shenzhen BCTC Technology Co., Ltd.
Address :	No.101, Yousong Road, Longhua New District, Shenzhen, China
Test Date:	Dec. 21 - Dec. 30, 2014
Date of Report :	Dec. 30, 2014
Report No.:	BCTC-141125625R

VERIFICATION OF COMPLIANCE

Applicant:	ACCO Brands, Inc.
Address	333 Twin Dolphin Drive, 6th Floor, Redwood Shores, California, United States
Manufacturer Name:	Kensington Computer Products Group
Address:	333, Twin Dolphin Drive, 6th Floor, Redwood Shores, CA 94065, USA
Product Description:	Wireless Mouse
Brand Name:	N/A
Model Name:	M01308-M
Model difference:	Model name is different
Test procedure	ANSI C63.4:2003, RSS-Gen Issue 3
Standards	FCC PART15.249, RSS-210 Issue 8

Prepared by(Engineer):

Eric Yang

Reviewer(Quality Manager):

Sophie Lee

Approved & Authorized Signer(Manager):

Casey Wang

Table of Contents	Page
1 . SUMMARY OF TEST RESULTS	4
1.1 TEST FACILITY	5
1.2 MEASUREMENT UNCERTAINTY	5
2 . GENERAL INFORMATION	6
2.1 GENERAL DESCRIPTION OF EUT	6
2.2 DESCRIPTION OF TEST MODES	8
2.3 BLOCK DIGRAM SHOWING THE CONFIGURATION OF SYSTEM TESTED	9
2.4 DESCRIPTION OF SUPPORT UNITS(CONDUCTED MODE)	10
3 . TEST RESULT	12
3.1 ANTENNA REQUIREMENT	12
3.1.1 STANDARD REQUIREMENT	12
3.1.2 EUT ANTENNA	12
3.2 CONDUCTED EMISSION MEASUREMENT	13
3.2.1 POWER LINE CONDUCTED EMISSION LIMITS	13
3.2.2 TEST PROCEDURE	14
3.2.3 DEVIATION FROM TEST STANDARD	14
3.2.4 TEST SETUP	14
3.2.5 TEST RESULT	15
3.3 RADIATED EMISSION MEASUREMENT	16
3.3.1 RADIATED EMISSION LIMITS	16
3.3.2 TEST PROCEDURE	17
3.3.3 DEVIATION FROM TEST STANDARD	17
3.3.4 TEST SETUP	18
3.3.5 TEST RESULTS (BLOW 30MHZ)	20
3.3.6 TEST RESULTS (BETWEEN 30 – 1000 MHZ)	21
3.3.7 TEST RESULTS (ABOVE 1000 MHZ)	23
4 . BANDWIDTH TEST	33
4.1 TEST PROCEDURE	33
4.2 DEVIATION FROM STANDARD	33
4.3 TEST SETUP	33
4.4 TEST RESULTS	34
5 . EUT TEST PHOTO	37
APPENDIX-PHOTOGRAPHS OF EUT CONSTRUCTIONAL DETAILS	



1. SUMMARY OF TEST RESULTS

Test procedures according to the technical standards:

FCC Part15, Subpart C (15.249) RSS-Gen Issue 3 & RSS-210 Issue 8			
Standard Section	Test Item	Judgment	Remark
15.207& 7.2.4	Conducted Emission	N/A	
15.203	Antenna Requirement	Pass	
15.249& A8.5	Radiated Spurious Emission	Pass	
15.249& A8.1	Occupied Bandwidth	Pass	
15.205& A8.5	Band Edge Emission	Pass	

NOTE: (1) " N/A" denotes test is not applicable in this Test Report

1.1 TEST FACILITY

Shenzhen BCTC Technology Co., Ltd.

Add. : No.101,Yousong Road,Longhua New District, Shenzhen,China

FCC Registered No.: 187086

1.2 MEASUREMENT UNCERTAINTY

The reported uncertainty of measurement $y \pm U$, where expanded uncertainty U is based on a standard uncertainty multiplied by a coverage factor of $k=2$, providing a level of confidence of approximately **95 %**.

No.	Item	Uncertainty
1	Conducted Emission Test	$\pm 1.38\text{dB}$
2	RF power,conducted	$\pm 0.16\text{dB}$
3	Spurious emissions,conducted	$\pm 0.21\text{dB}$
4	All emissions,radiated(<1G)	$\pm 4.68\text{dB}$
5	All emissions,radiated(>1G)	$\pm 4.89\text{dB}$
6	Temperature	$\pm 0.5^{\circ}\text{C}$
7	Humidity	$\pm 2\%$

2. GENERAL INFORMATION

2.1 GENERAL DESCRIPTION OF EUT

Equipment	Wireless Mouse
Trade Name	N/A
Model Name	M01308-M
Serial Model	N/A
Model Difference	N/A
Product Description	The EUT is a Wireless Mouse
	Operation Frequency: 2402~2480MHz
	Modulation Type: GFSK
	Antenna Designation: PCB Antenna
	Antenna Gain(Peak) 1.0 dBi
	EIRP 102.2dbuv/m@3m
	Based on the application, features, or specification exhibited in User's Manual, the EUT is considered as an ITE/Computing Device. More details of EUT technical specification, please refer to the User's Manual.
DC 3.0V	DC 3.0V
Please refer to the Note 2.	Please refer to the Note 2.
N/A	N/A
1.5V*2cell "AA" alkaline battery	1.5V*2cell "AA" alkaline battery

Note:

1. For a more detailed features description, please refer to the manufacturer's specifications or the User's Manual.

2.

Channel	Frequency (MHz)
01	2402
02	2403
.....
40	2441
41	2442
.....
78	2479
79	2480

3.

Table for Filed Antenna

Ant	Brand	Model Name	Antenna Type	Connector	Gain (dBi)	NOTE
1	N/A	N/A	PCB Antenna	NA	1.0	Antenna

2.2 DESCRIPTION OF TEST MODES

To investigate the maximum EMI emission characteristics generates from EUT, the test system was pre-scanning tested base on the consideration of following EUT operation mode or test configuration mode which possible have effect on EMI emission level. Each of these EUT operation mode(s) or test configuration mode(s) mentioned above was evaluated respectively.

Pretest Mode	Description
Mode 1	CH1
Mode 2	CH40
Mode 3	CH79
Mode 4	Charge Mode

For Conducted Emission	
Final Test Mode	Description
Mode 4	Charge Mode

For Radiated Emission	
Final Test Mode	Description
Mode 1	CH1
Mode 2	CH40
Mode 3	CH79

Note:

- (1) The measurements are performed at the highest, middle, lowest available channels.
- (2) The EUT use new battery.



2.3 BLOCK DIGRAM SHOWING THE CONFIGURATION OF SYSTEM TESTED

Radiated Spurious Emission Test

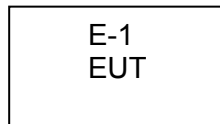



2.4 DESCRIPTION OF SUPPORT UNITS(CONDUCTED MODE)

The EUT has been tested as an independent unit together with other necessary accessories or support units. The following support units or accessories were used to form a representative test configuration during the tests.

Item	Equipment	Mfr/Brand	Model/Type No.	Series No.	Note
E-1	Wireless Mouse	N/A	M01308-M	N/A	EUT

Item	Shielded Type	Ferrite Core	Length	Note

Note:

- (1) The support equipment was authorized by Declaration of Confirmation.
- (2) For detachable type I/O cable should be specified the length in cm in 『Length』 column.

2.5 EQUIPMENTS LIST FOR ALL TEST ITEMS

Radiation Test equipment

Item	Kind of Equipment	Manufacturer	Type No.	Serial No.	Last calibration	Calibrated until	Calibration period
1	Spectrum Analyzer	Agilent	E4407B	MY45108040	2014.07.06	2015.07.05	1 year
2	Test Receiver	R&S	ESPI	101318	2014.06.07	2015.06.06	1 year
3	Bilog Antenna	TESEQ	CBL6111D	31216	2014.07.06	2015.07.05	1 year
4	50Ω Coaxial Switch	Anritsu	MP59B	6200264416	2014.06.07	2015.06.06	1 year
5	Spectrum Analyzer	ADVANTEST	R3132	150900201	2014.06.07	2015.06.06	1 year
6	Horn Antenna	EM	EM-AH-10180	2011071402	2014.07.06	2015.07.05	1 year
7	Horn Ant	Schwarzbeck	BBHA 9170	9170-181	2014.07.06	2015.07.05	1 year
8	Amplifier	EM	EM-30180	060538	2013.12.22	2014.12.21	1 year
9	Amplifier	EM	EM-30180	060538	2014.12.22	2015.12.21	1 year
9-1	Loop Antenna	ARA	PLA-1030/B	1029	2014.06.08	2015.06.07	1 year
10	Power Meter	R&S	NRVS	100696	2014.07.06	2015.07.05	1 year
11	Power Sensor	R&S	URV5-Z4	0395.1619.05	2014.07.06	2015.07.05	1 year
12	RF cables	R&S	N/A	N/A	2014.07.06	2015.07.05	1 year

Conduction Test equipment

Item	Kind of Equipment	Manufacturer	Type No.	Serial No.	Last calibration	Calibrated until	Calibration period
1	Test Receiver	R&S	ESCI	101160	2014.06.06	2015.06.05	1 year
2	LISN	R&S	ENV216	101313	2014.08.24	2015.08.23	1 year
3	LISN	EMCO	3816/2	00042990	2014.08.24	2015.08.23	1 year
4	50Ω Coaxial Switch	Anritsu	MP59B	6200264417	2014.06.07	2015.06.06	1 year
5	Passive Voltage Probe	R&S	ESH2-Z3	100196	2014.06.07	2015.06.06	1 year
6	Absorbing clamp	R&S	MOS-21	100423	2014.06.08	2015.06.07	1 year
7	RF cables	R&S	N/A	N/A	2014.07.06	2015.07.05	1 year



3. TEST RESULT

3.1 ANTENNA REQUIREMENT

3.1.1 STANDARD REQUIREMENT

15.203 requirement: For intentional device, according to 15.203: an intentional radiator shall be designed to ensure that no antenna other than that furnished by the responsible party shall be used with the device.

3.1.2 EUT ANTENNA

The EUT antenna is PCB Antenna. It comply with the standard requirement.

3.2 CONDUCTED EMISSION MEASUREMENT

3.2.1 POWER LINE CONDUCTED EMISSION Limits (Frequency Range 150KHz-30MHz)

FREQUENCY (MHz)	Class A (dBUV)		Class B (dBUV)		Standard
	Quasi-peak	Average	Quasi-peak	Average	
0.15 -0.5			66 - 56 *	56 - 46 *	CISPR
0.50 -5.0			56.00	46.00	CISPR
5.0 -30.0			60.00	50.00	CISPR

0.15 -0.5			66 - 56 *	56 - 46 *	LP002.
0.50 -5.0			56.00	46.00	LP002.
5.0 -30.0			60.00	50.00	LP002.

Note:

- (1) The tighter limit applies at the band edges.
- (2) The limit of " * " marked band means the limitation decreases linearly with the logarithm of the frequency in the range.

The following table is the setting of the receiver

Receiver Parameters	Setting
Attenuation	10 dB
Start Frequency	0.15 MHz
Stop Frequency	30 MHz
IF Bandwidth	9 kHz

3.2.2 TEST PROCEDURE

- a. The EUT was placed 0.4 meters from the horizontal ground plane with EUT being connected to the power mains through a line impedance stabilization network (LISN). All other support equipments powered from additional LISN(s). The LISN provide 50 Ohm/ 50uH of coupling impedance for the measuring instrument.
- b. Interconnecting cables that hang closer than 40 cm to the ground plane shall be folded back and forth in the center forming a bundle 30 to 40 cm long.
- c. I/O cables that are not connected to a peripheral shall be bundled in the center. The end of the cable may be terminated, if required, using the correct terminating impedance. The overall length shall not exceed 1 m.
- d. LISN at least 80 cm from nearest part of EUT chassis.
- e. For the actual test configuration, please refer to the related Item –EUT Test Photos.

3.2.3 DEVIATION FROM TEST STANDARD

No deviation

3.2.4 TEST SETUP

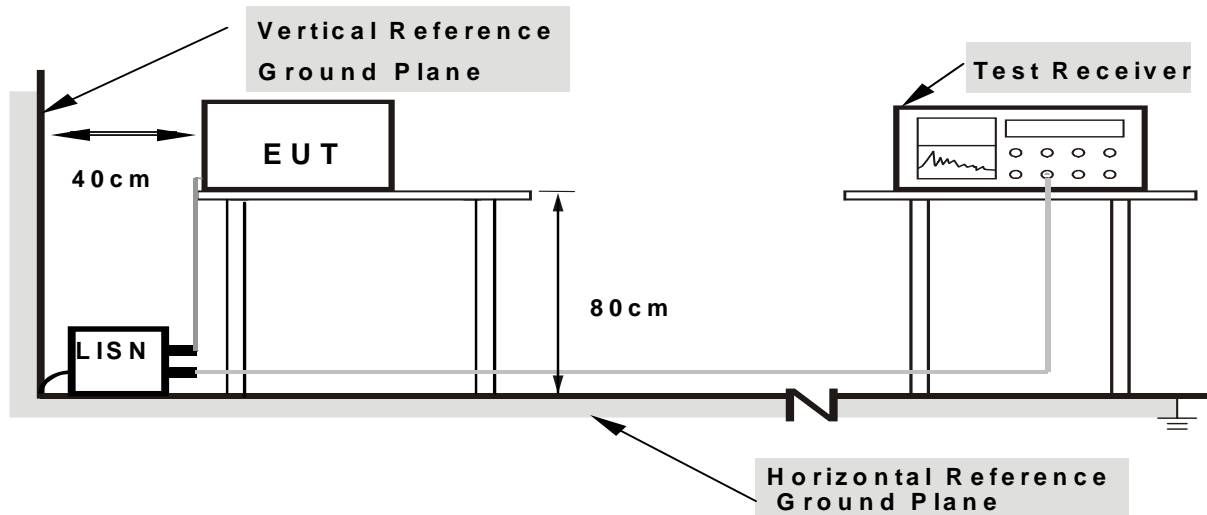

Note: 1. Support units were connected to second LISN.

2. Both of LISNs (AMN) are 80 cm from EUT and at least 80 cm from other units and other metal planes

**3.2.5 TEST RESULT**

EUT :	Wireless Mouse	Model Name. :	M01308-M
Temperature :	26 °C	Relative Humidity :	54%
Pressure :	1010hPa	Phase :	L
Test Voltage :	N/A	Test Mode :	N/A

NOTE: To Conducted Emission, not suitable for battery devices.

3.3 RADIATED EMISSION MEASUREMENT

3.3.1 Radiated Emission Limits (FCC 15.209)

Frequencies (MHz)	Field Strength (micorvolts/meter)	Measurement Distance (meters)
0.009~0.490	2400/F(KHz)	300
0.490~1.705	24000/F(KHz)	30
1.705~30.0	30	30
30~88	100	3
88~216	150	3
216~960	200	3
Above 960	500	3

Note:

- (1) The tighter limit applies at the band edges.
- (2) Emission level (dBuV/m)=20log Emission level (uV/m).

LIMITS OF RADIATED EMISSION MEASUREMENT (FCC 15.249)

Frequency of Emission (MHz)	Field Strength of fundamental ((millivolts /meter)	Field Strength of Harmonics (microvolts/meter)
2400 - 2483.5	50	500

Notes:

- (1) Emissions radiated outside of the specified frequency bands, except for harmonics, shall be attenuated by at least 50 dB below the level of the fundamental or to the general radiated emission limits in Section 15.209, whichever is the lesser attenuation.

Spectrum Parameter	Setting
Attenuation	Auto
Start Frequency	1000 MHz
Stop Frequency	10th carrier harmonic
RB / VB (emission in restricted band)	1MHz / 1MHz for Peak

Receiver Parameter	Setting
Attenuation	Auto
Start ~ Stop Frequency	9kHz~150kHz / RB 200Hz for QP
Start ~ Stop Frequency	150kHz~30MHz / RB 9kHz for QP
Start ~ Stop Frequency	30MHz~1000MHz / RB 120kHz for QP

3.3.2 TEST PROCEDURE

- a. The measuring distance of at 3 m shall be used for measurements at frequency up to 1GHz. For frequencies above 1GHz, any suitable measuring distance may be used.
- b. The EUT was placed on the top of a rotating table 0.8 meters above the ground at a 3m meter open area test site. The table was rotated 360 degrees to determine the position of the highest radiation.
- c. The height of the equipment or of the substitution antenna shall be 0.8 m; the height of the test antenna shall vary between 1 m to 4 m.
- d. The initial step in collecting conducted emission data is a spectrum analyzer peak detector mode pre-scanning the measurement frequency range. Significant peaks are then marked and then Quasi Peak detector mode re-measured.
- e. If the Peak Mode measured value compliance with and lower than Quasi Peak Mode Limit, the EUT shall be deemed to meet QP Limits and then no additional QP Mode measurement performed.
- f. For the actual test configuration, please refer to the related Item –EUT Test Photos.

Note:

Both horizontal and vertical antenna polarities were tested and performed pretest to three orthogonal axis. The worst case emissions were reported

3.3.3 DEVIATION FROM TEST STANDARD

No deviation

3.3.4 TEST SETUP

(A) Radiated Emission Test-Up Frequency Below 30MHz

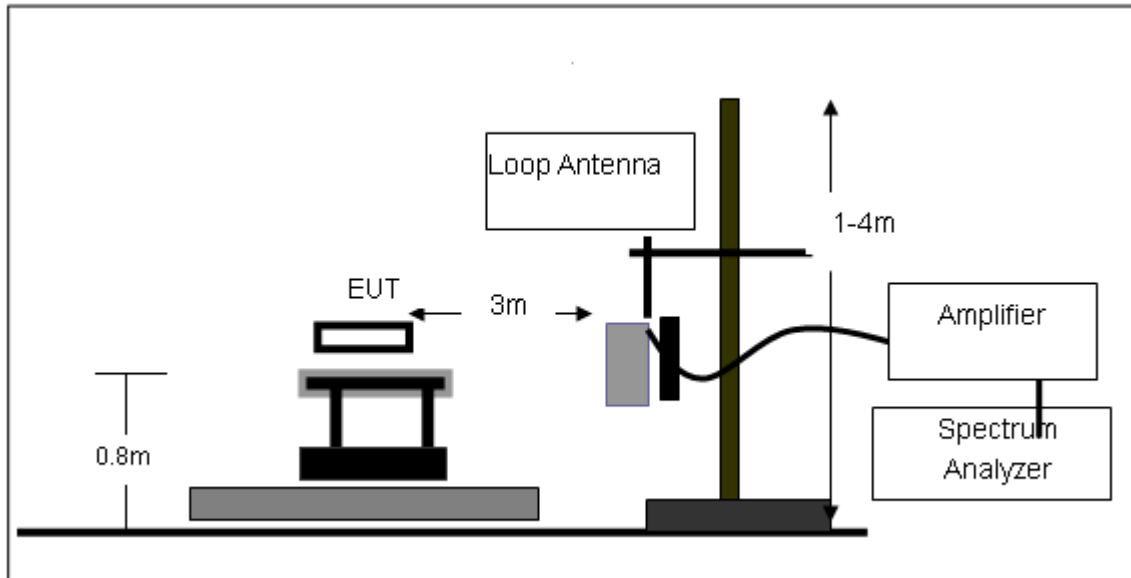

(B) Radiated Emission Test-Up Frequency 30MHz~1GHz

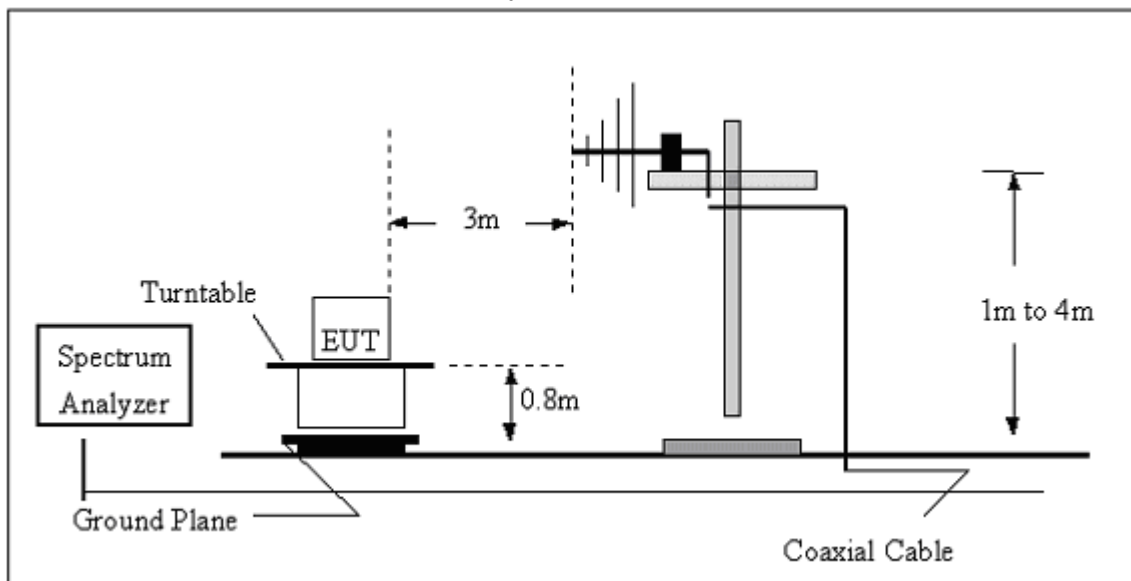

(C) Radiated Emission Test-Up Frequency Above 1GHz

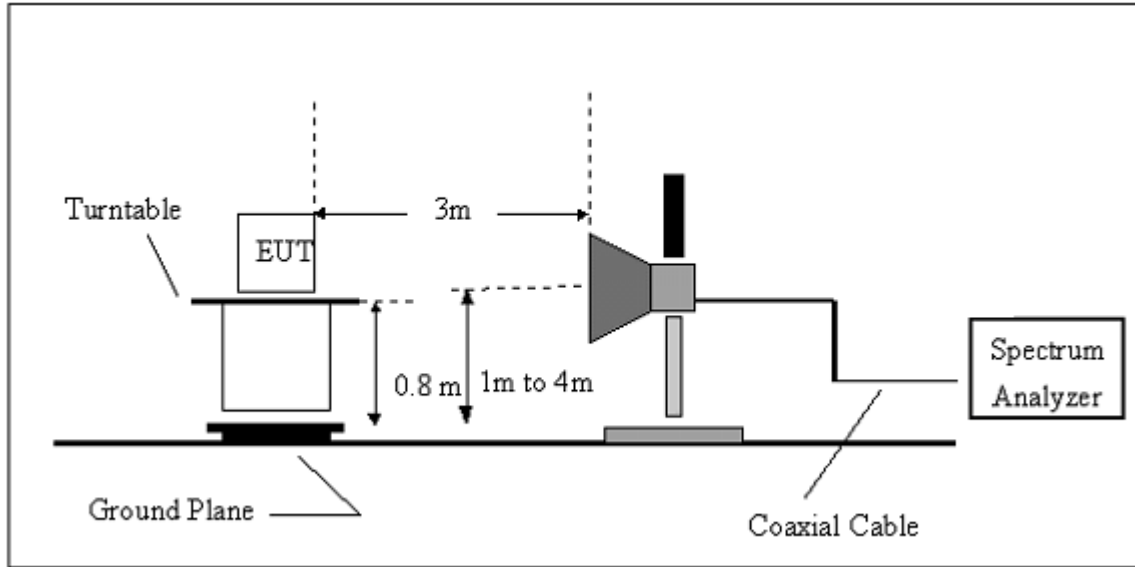

3.3.5 TEST RESULTS (BLOW 30MHz)

EUT :	Wireless Mouse	Model Name. :	M01308-M
Temperature :	20 °C	Relative Humidity :	48%
Pressure :	1010 hPa	Test Voltage :	DC 3.0V
Test Mode :	TX	Polarization :	--

Freq.	Reading	Limit	Margin	State
(MHz)	(dBuV/m)	(dBuV/m)	(dB)	P/F
--	--	--	--	PASS
--	--	--	--	PASS

NOTE:

The amplitude of spurious emissions which are attenuated by more than 20dB below the permissible value has no need to be reported.

Distance extrapolation factor = $40 \log(\text{specific distance}/\text{test distance})$ (dB);

Limit line = specific limits(dBuv) + distance extrapolation factor.

3.3.6 TEST RESULTS (BETWEEN 30 – 1000 MHZ)

EUT :	Wireless Mouse	Model Name :	M01308-M
Temperature :	20 °C	Relative Humidity :	48%
Pressure :	1010 hPa	Test Voltage :	DC 3.0V
Test Mode :	TX	Polarization :	Vertical

Frequency (MHz)	Meter Reading (dBµV)	Factor (dB)	Emission Level (dBµV/m)	Limits (dBµV/m)	Margin (dB)	Detector Type
171.9945	14.6	9.89	24.49	43.5	-19.01	peak
344.3854	16.17	15.22	31.39	46	-14.61	peak
487.315	16.08	19.01	35.09	46	-10.91	peak

Remark:

1. Factor = Antenna Factor + Cable Loss – Pre-amplifier.

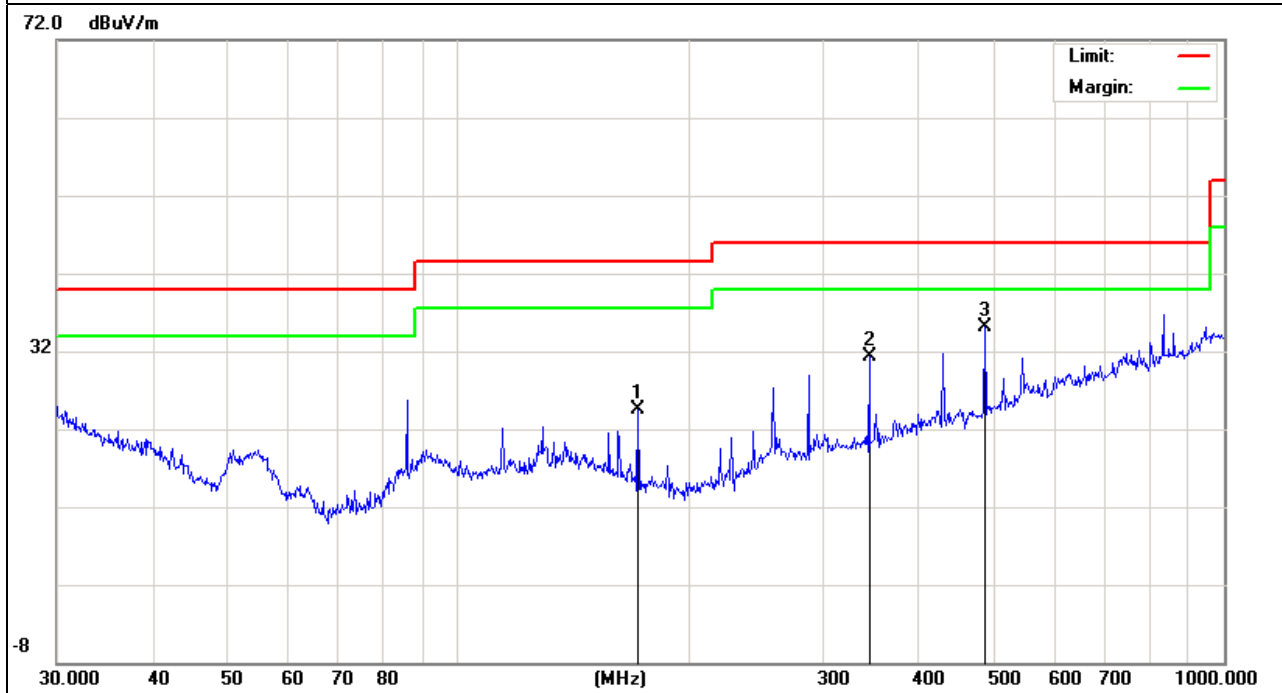

EUT :	Wireless Mouse	Model Name :	M01308-M
Temperature :	20 °C	Relative Humidity :	48%
Pressure :	1010 hPa	Test Voltage :	DC 3.0V
Test Mode :	TX	Polarization :	Horizontal

Frequency (MHz)	Meter Reading (dBμV)	Factor (dB)	Emission Level (dBμV/m)	Limits (dBμV/m)	Margin (dB)	Detector Type
114.5146	14.58	11.66	26.24	43.5	-17.26	peak
171.9945	12.46	9.89	22.35	43.5	-21.15	peak
229.2931	14.95	10.39	25.34	46	-20.66	peak
601.4265	15.29	21.15	36.44	46	-9.56	peak

Remark:

1. Factor = Antenna Factor + Cable Loss – Pre-amplifier.

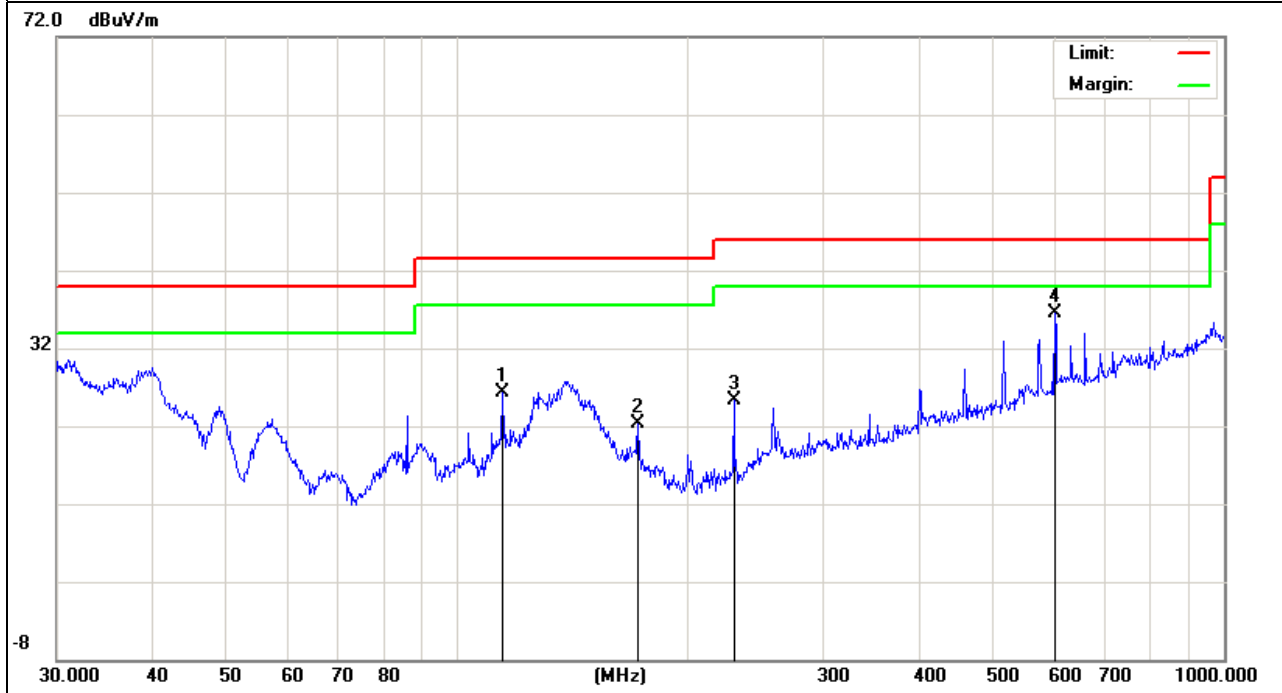

3.3.7 TEST RESULTS (ABOVE 1000 MHZ)

EUT :	Wireless Mouse	Model Name :	M01308-M
Temperature :	20 °C	Relative Humidity :	48%
Pressure :	1010 hPa	Test Voltage :	DC 3.0V
Test Mode :	TX /2402MHz	Polarization :	Horizontal

Frequency (MHz)	Meter Reading (dBμV)	Factor (dB)	Emission Level (dBμV/m)	Limits (dBμV/m)	Margin (dB)	Detector Type
2402	112.63	-12.99	99.64	114.0 0	-14.36	peak
2402	97.96	-12.99	84.97	94	-9.03	AVG
4804	57.27	-3.57	53.7	74	-20.3	peak
4804	41.23	-3.57	37.66	54	-16.34	AVG
9608	55.06	1.78	56.84	74	-17.16	peak
9608	41.23	1.78	43.01	54	-10.99	AVG

Remark:
 Factor = Antenna Factor + Cable Loss – Pre-amplifier.
 No emission above 18GHz.

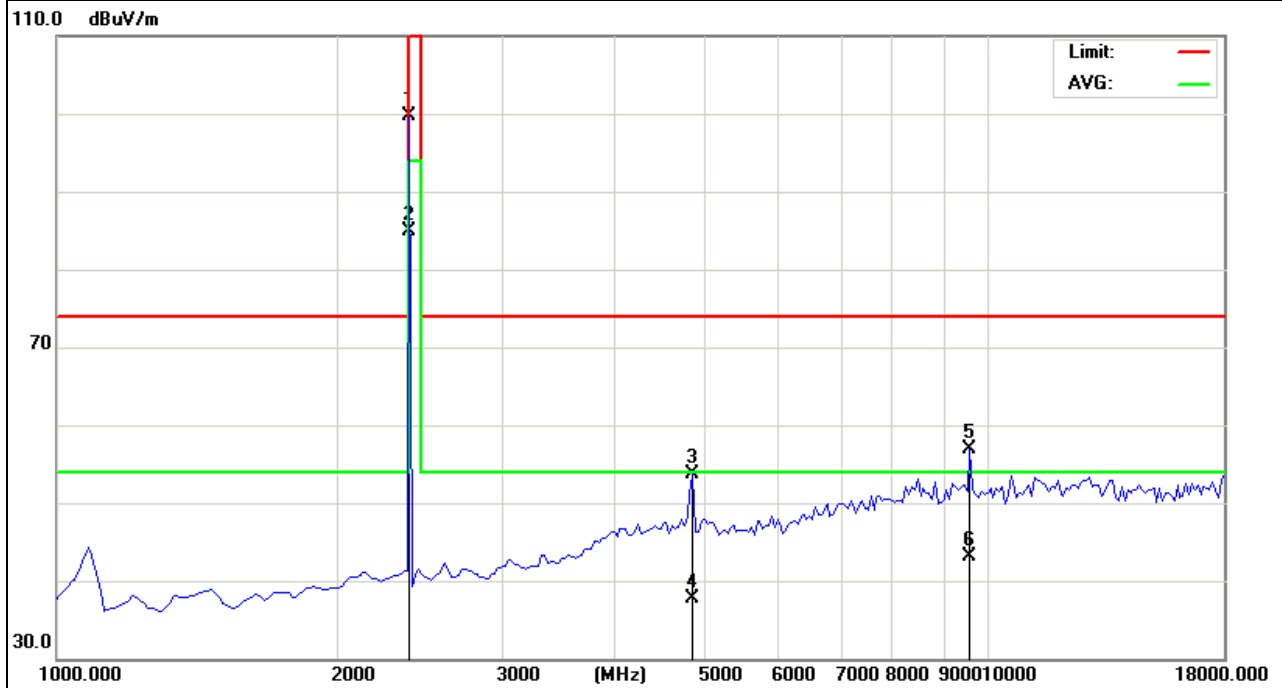



EUT :	Wireless Mouse	Model Name :	M01308-M
Temperature :	20 °C	Relative Humidity :	48%
Pressure :	1010 hPa	Test Voltage :	DC 3.0V
Test Mode :	TX /2402MHz	Polarization :	Vertical

Frequency (MHz)	Meter Reading (dBµV)	Factor (dB)	Emission Level (dBµV/m)	Limits (dBµV/m)	Margin (dB)	Detector Type
2402	114.81	-12.99	101.82	114.00	-12.18	peak
2402	97.87	-12.99	84.88	94	-9.12	AVG
4804	62.49	-3.59	58.9	74	-15.1	peak
4804	44.23	-3.59	40.64	54	-13.36	AVG
7206	53.96	-0.96	53	74	-21	peak

Remark:
 Factor = Antenna Factor + Cable Loss – Pre-amplifier.
 No emission above 18GHz.

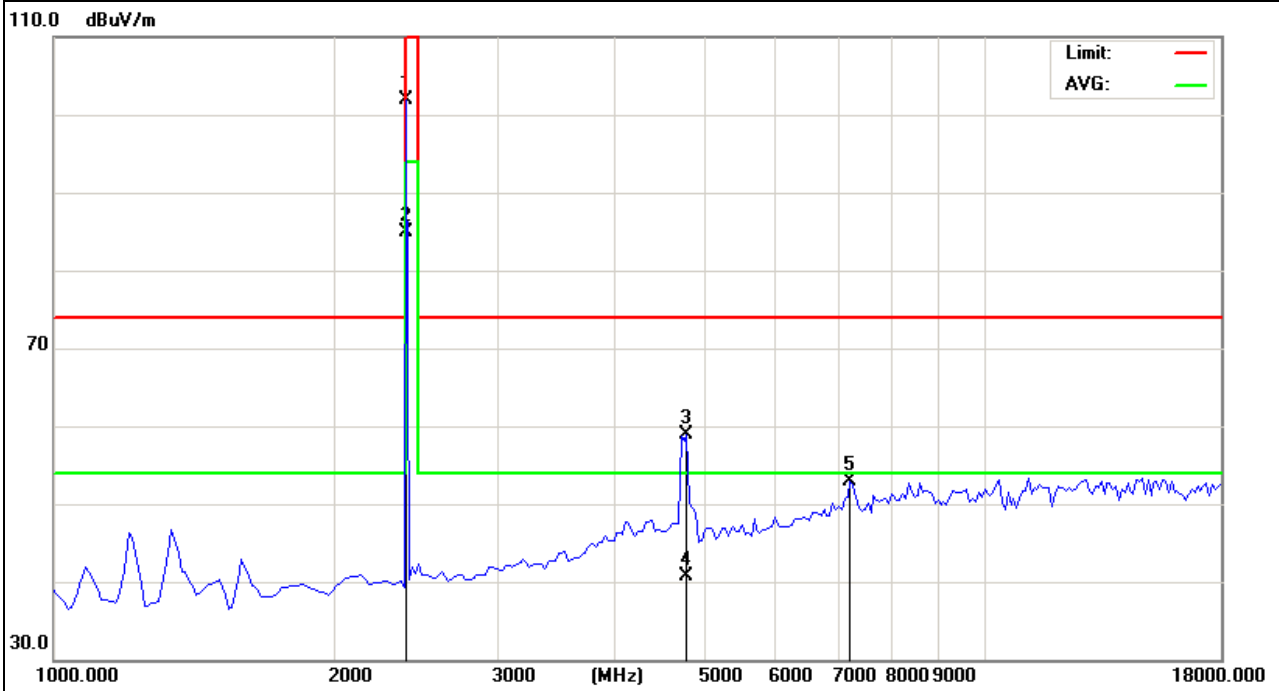

EUT :	Wireless Mouse	Model Name :	M01308-M
Temperature :	20 °C	Relative Humidity :	48%
Pressure :	1010 hPa	Test Voltage :	DC 3.0V
Test Mode :	TX /2441MHz	Polarization :	Horizontal

Frequency (MHz)	Meter Reading (dBµV)	Factor (dB)	Emission Level (dBµV/m)	Limits (dBµV/m)	Margin (dB)	Detector Type
2441	115.13	-12.93	102.2	114.0 0	-11.8	peak
2441	96.45	-12.93	83.52	94	-10.48	AVG
4882	65.25	-3.55	61.7	74	-12.3	peak
4882	43.21	-3.55	39.66	54	-14.34	AVG

Remark:
 Factor = Antenna Factor + Cable Loss – Pre-amplifier.
 No emission above 18GHz.

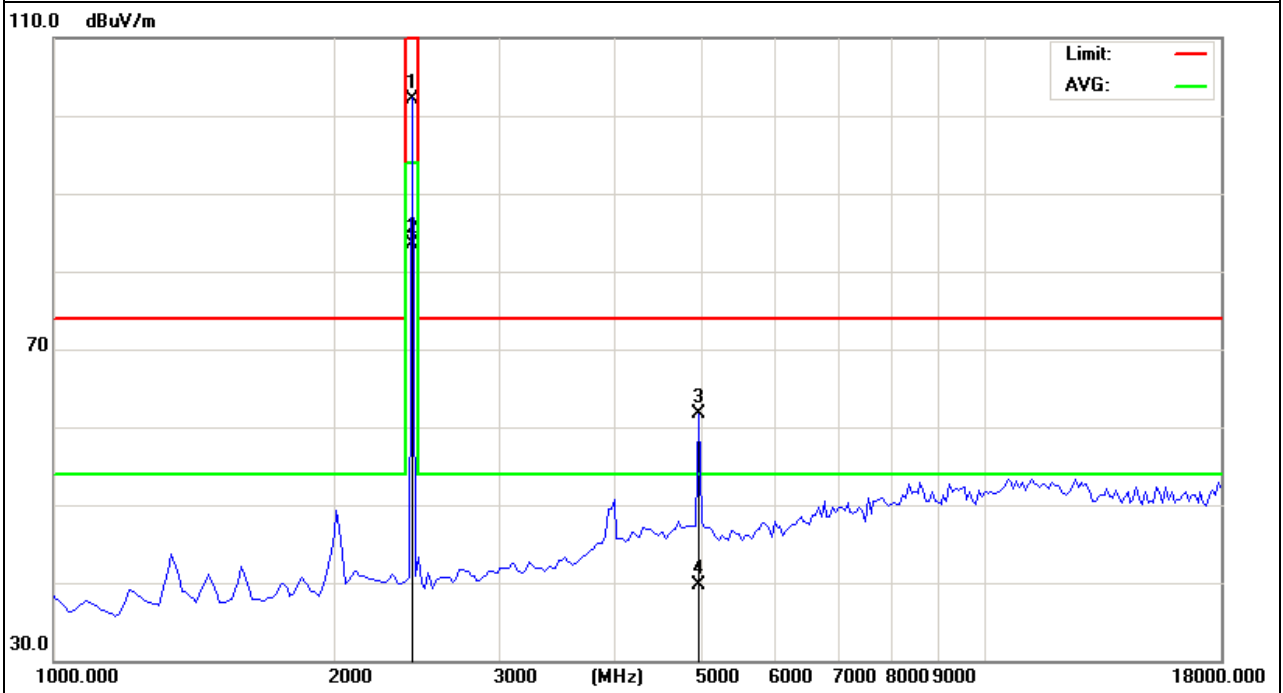

EUT :	Wireless Mouse	Model Name :	M01308-M
Temperature :	20 °C	Relative Humidity :	48%
Pressure :	1010 hPa	Test Voltage :	DC 3.0V
Test Mode :	TX /2441MHz	Polarization :	Vertical

Frequency (MHz)	Meter Reading (dBµV)	Factor (dB)	Emission Level (dBµV/m)	Limits (dBµV/m)	Margin (dB)	Detector Type
2441	114.13	-12.93	101.2	114.0 0	-12.8	peak
2441	97.08	-12.93	84.15	94	-9.85	AVG
4882	69.24	-3.55	65.69	74	-8.31	peak
4882	46.21	-3.55	42.66	54	-11.34	AVG

Remark:
 Factor = Antenna Factor + Cable Loss – Pre-amplifier.
 No emission above 18GHz.

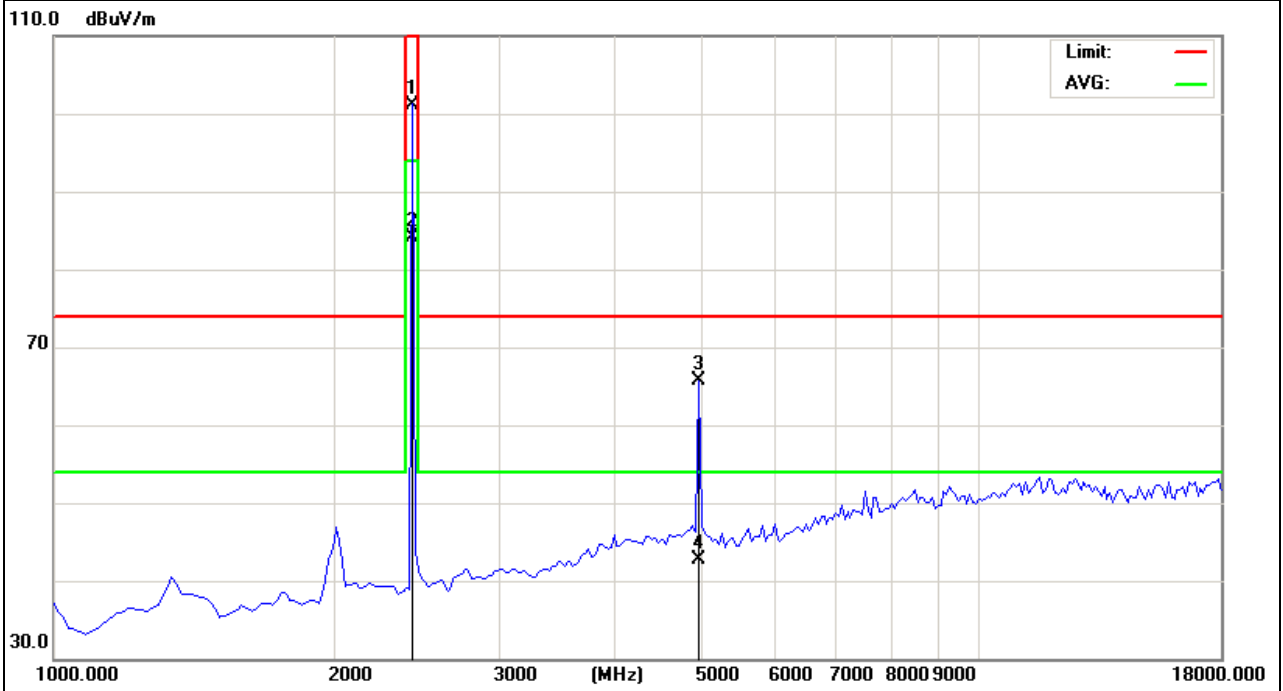



EUT :	Wireless Mouse	Model Name :	M01308-M
Temperature :	20 °C	Relative Humidity :	48%
Pressure :	1010 hPa	Test Voltage :	DC 3.0V
Test Mode :	TX /2480MHz	Polarization :	Horizontal

Frequency (MHz)	Meter Reading (dBµV)	Factor (dB)	Emission Level (dBµV/m)	Limits (dBµV/m)	Margin (dB)	Detector Type
2480	112.82	-12.92	99.9	114.0 0	-14.1	peak
2480	97.98	-12.92	85.06	94	-8.94	AVG
4960	69.42	-3.55	65.87	74	-8.13	peak
4960	50.28	-3.55	46.73	54	-7.27	AVG
7440	56.94	-0.68	56.26	74	-17.74	peak
7440	41.51	-0.68	40.83	54	-13.17	AVG

Remark:
 Factor = Antenna Factor + Cable Loss – Pre-amplifier.
 No emission above 18GHz.

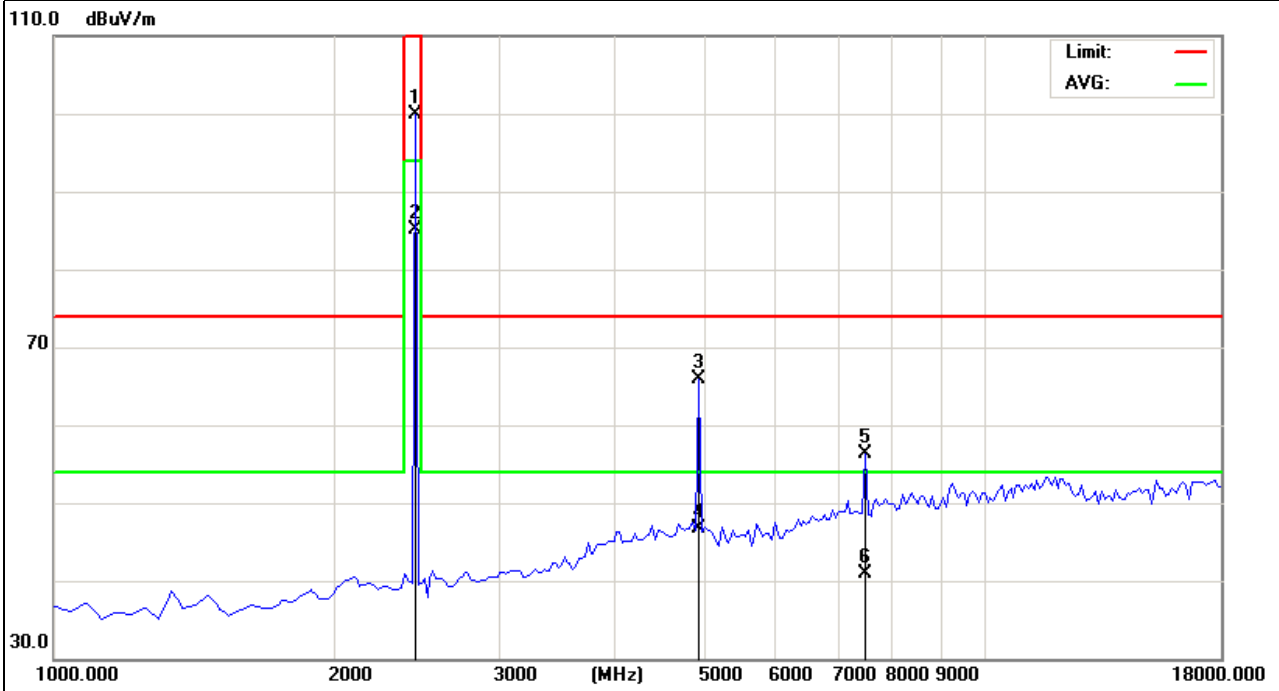



EUT :	Wireless Mouse	Model Name :	M01308-M
Temperature :	20 °C	Relative Humidity :	48%
Pressure :	1010 hPa	Test Voltage :	DC 3.0V
Test Mode :	TX /2480MHz	Polarization :	Vertical

Frequency (MHz)	Meter Reading (dBµV)	Factor (dB)	Emission Level (dBµV/m)	Limits (dBµV/m)	Margin (dB)	Detector Type
2480	114.12	-12.92	101.2	114.0 0	-12.8	peak
2480	96.76	-12.92	83.84	94	-10.16	AVG
4960	62.2	-3.8	58.4	74	-15.6	peak
4960	43.66	-3.8	39.86	54	-14.14	AVG

Remark:
 Factor = Antenna Factor + Cable Loss – Pre-amplifier.
 No emission above 18GHz.

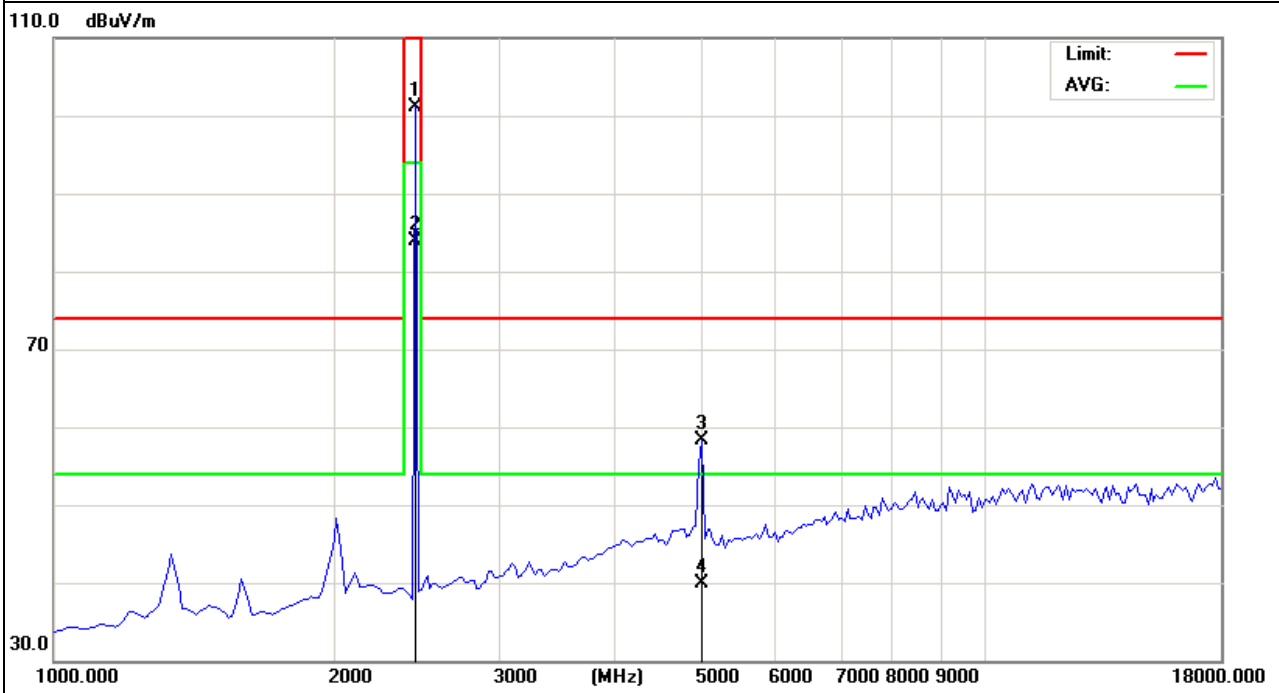

Band Edge Emission:

EUT :	Wireless Mouse	Model Name :	M01308-M
Temperature :	20 °C	Relative Humidity :	48%
Pressure :	1010 hPa	Test Voltage :	DC 3.0V
Test Mode :	TX /2402MHz	Polarization :	Vertical

Frequency (MHz)	Meter Reading (dBμV)	Factor (dB)	Emission Level (dBμV/m)	Limits (dBμV/m)	Margin (dB)	Detector Type
2399.28	65.51	-12.99	52.52	74	-21.48	peak
2400	66.9	-12.99	53.91	74	-20.09	peak

Remark:
Factor = Antenna Factor + Cable Loss – Pre-amplifier.

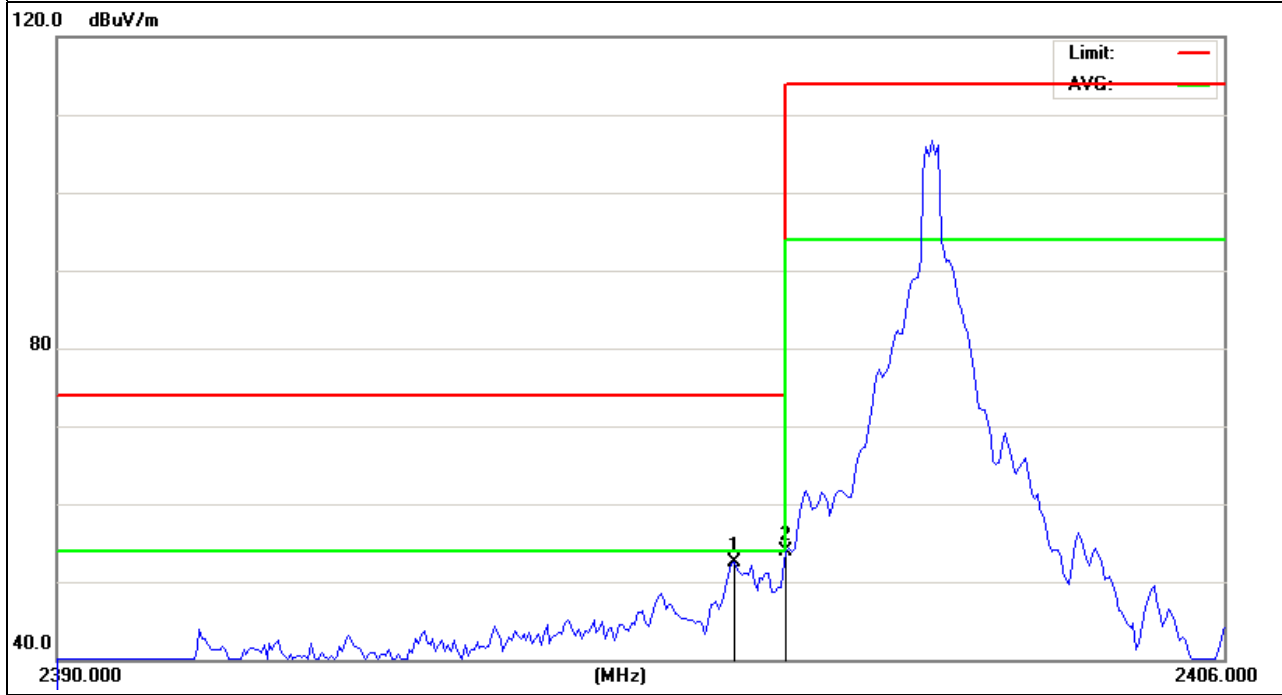

EUT :	Wireless Mouse	Model Name :	M01308-M
Temperature :	20 °C	Relative Humidity :	48%
Pressure :	1010 hPa	Test Voltage :	DC 3.0V
Test Mode :	TX /2402MHz	Polarization :	Horizontal

Frequency (MHz)	Meter Reading (dBµV)	Factor (dB)	Emission Level (dBµV/m)	Limits (dBµV/m)	Margin (dB)	Detector Type
2397.8	62.81	-13	49.81	74	-24.19	peak
2400.00	64.46	-12.99	51.47	74	-22.53	peak

Remark:
Factor = Antenna Factor + Cable Loss – Pre-amplifier.

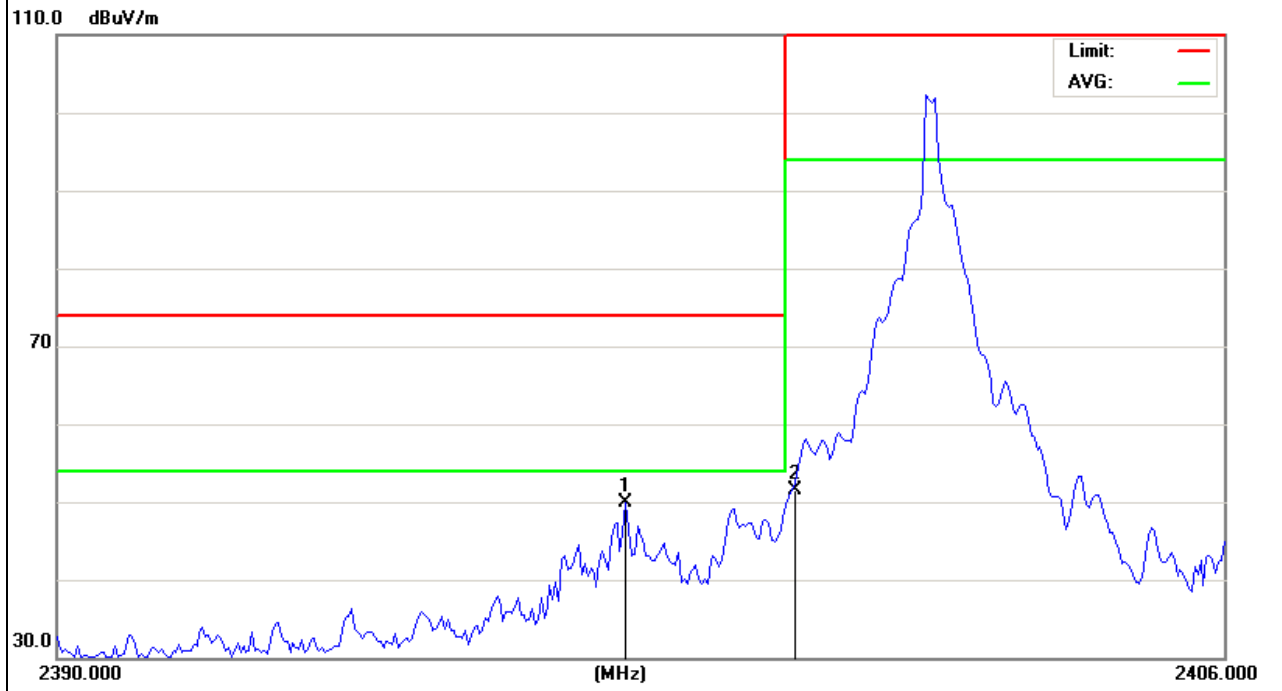

EUT :	Wireless Mouse	Model Name :	M01308-M
Temperature :	20 °C	Relative Humidity :	48%
Pressure :	1010 hPa	Test Voltage :	DC 3.0V
Test Mode :	TX /2480MHz	Polarization :	Vertical

Frequency (MHz)	Meter Reading (dBµV)	Factor (dB)	Emission Level (dBµV/m)	Limits (dBµV/m)	Margin (dB)	Detector Type
2483.5	45.74	-12.78	32.96	74	-41.04	peak
2484.215	52.76	-12.78	39.98	74	-34.02	peak

Remark:
Factor = Antenna Factor + Cable Loss – Pre-amplifier.

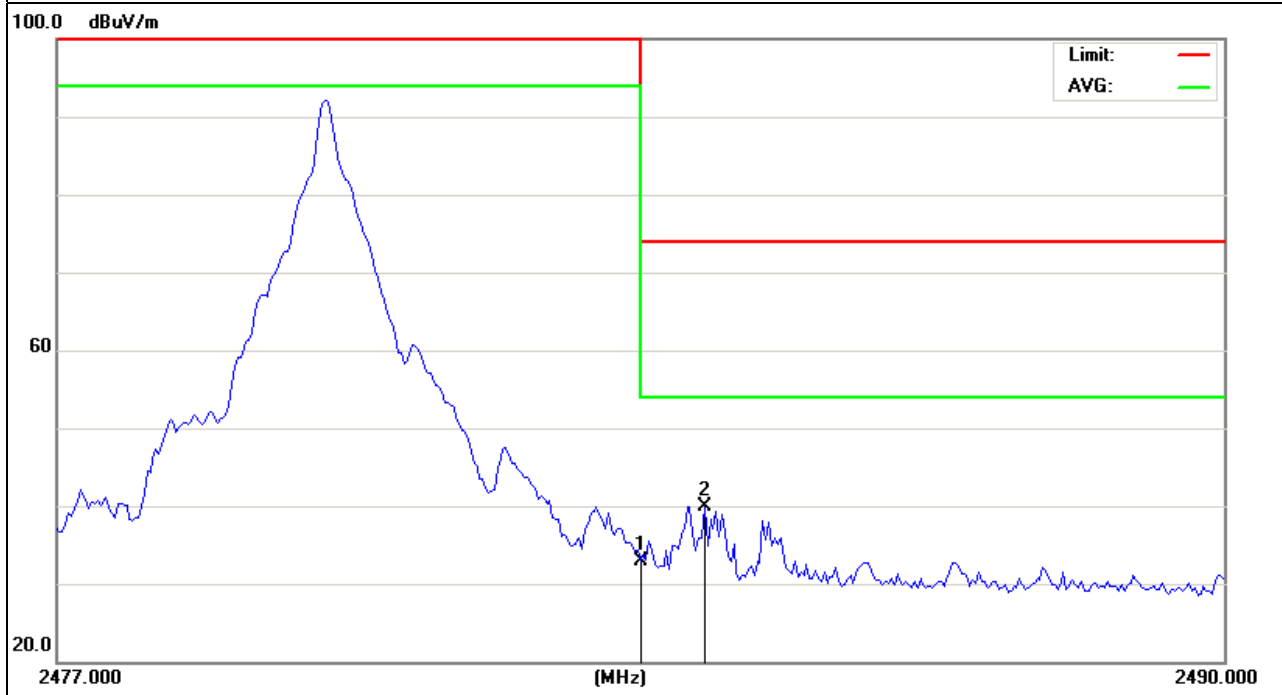

EUT :	Wireless Mouse	Model Name :	M01308-M
Temperature :	20 °C	Relative Humidity :	48%
Pressure :	1010 hPa	Test Voltage :	DC 3.0V
Test Mode :	TX /2480MHz	Polarization :	Horizontal

Frequency (MHz)	Meter Reading (dBµV)	Factor (dB)	Emission Level (dBµV/m)	Limits (dBµV/m)	Margin (dB)	Detector Type
2483.5	51.11	-12.78	38.33	74	-35.67	peak
2484.313	59.91	-12.78	47.13	74	-26.87	peak

Remark:
Factor = Antenna Factor + Cable Loss – Pre-amplifier.

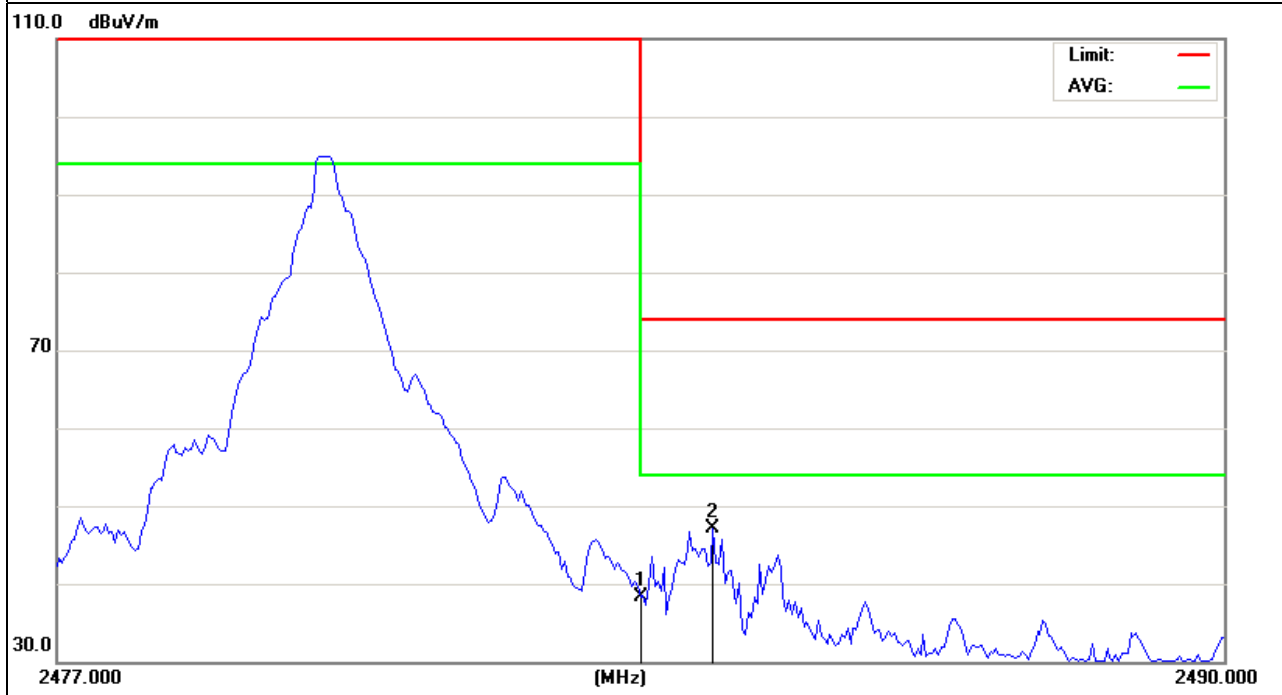

4. BANDWIDTH TEST

4.1 TEST PROCEDURE

- a. The EUT was directly connected to the spectrum analyzer and antenna output port as show in the block diagram below,
- b. Spectrum Setting : RBW= 100KHz, VBW \geq RBW, Sweep time = Auto.

4.2 DEVIATION FROM STANDARD

No deviation.

4.3 TEST SETUP



4.4 TEST RESULTS

EUT :	Wireless Mouse	Model Name :	M01308-M
Temperature :	26 °C	Relative Humidity :	53%
Pressure :	1020 hPa	Test Power :	DC 3.0V
Test Mode :	TX CH 1/40/79		

Test Channel	Frequency (MHz)	20 dBc Bandwidth (MHz)	99% Bandwidth (MHz)
CH01	2402	0.832	0.975
CH40	2441	0.937	1.151
CH79	2480	0.944	1.131

The Lowest Channel: 2402MHz

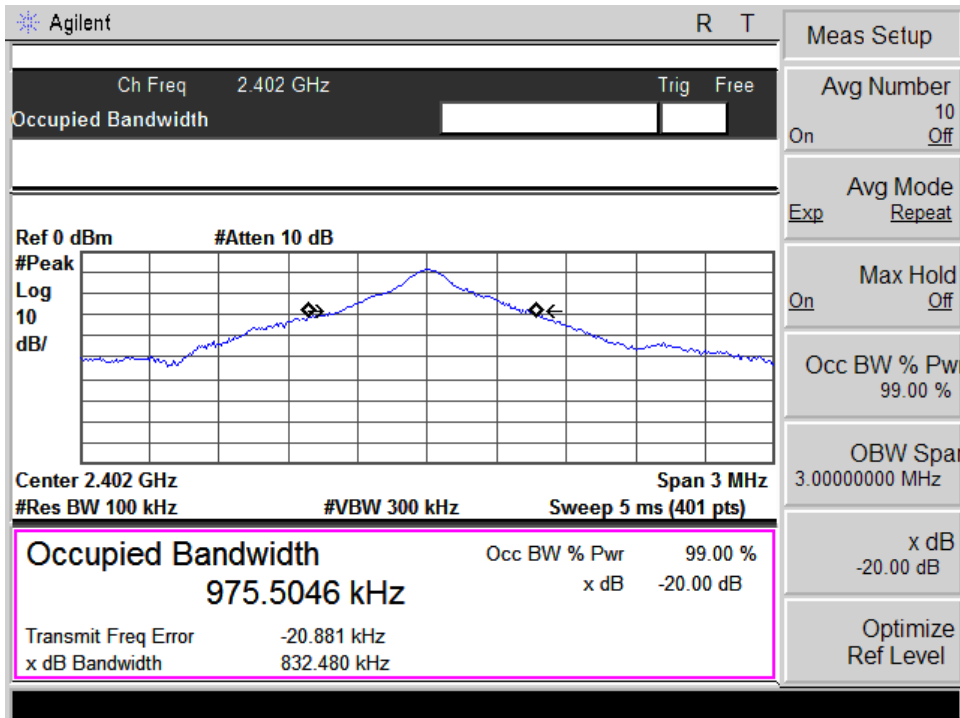

The Middle Channel: 2441MHz

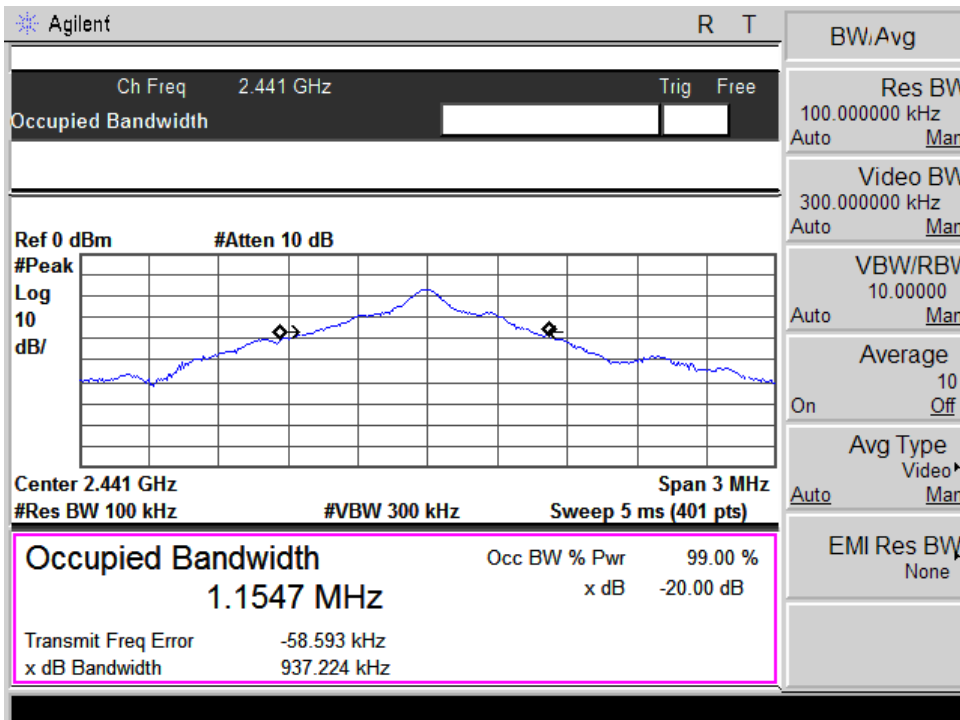



The High Channel:2480MHz

Agilent
R T

Ch Freq 2.48 GHz
Trig Free

Occupied Bandwidth

Ref 0 dBm
#Atten 10 dB

#Peak
Log
10
dB/

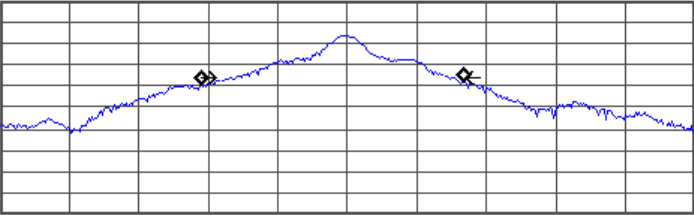

Center 2.48 GHz
Span 3 MHz

#Res BW 100 kHz
#VBW 300 kHz
Sweep 5 ms (401 pts)

Occupied Bandwidth	Occ BW % Pwr	99.00 %
	x dB	-20.00 dB
1.1373 MHz		
Transmit Freq Error	-64.592 kHz	
x dB Bandwidth	944.655 kHz	

Meas Setup	
Avg Number	10
On	Off
Avg Mode	
Exp	Repeat
Max Hold	
On	Off
Occ BW % Pwr	99.00 %
OBW Spar	3.00000000 MHz
x dB	-20.00 dB
Optimize Ref Level	

5. EUT TEST PHOTO

Radiated Measurement Photos



Conducted Measurement Photos

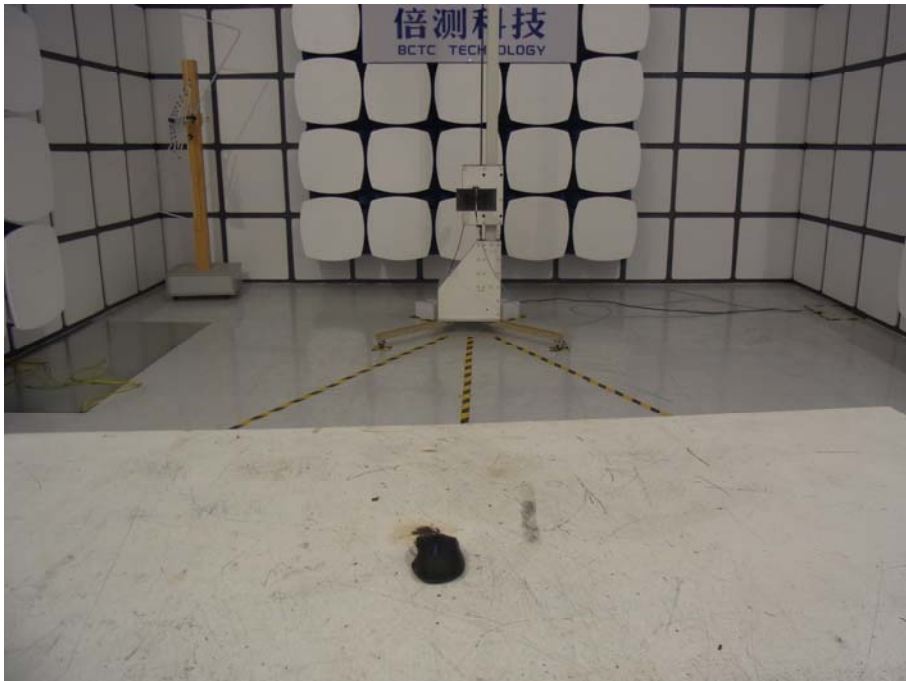

EUT PHOTO:









