



FCC TEST REPORT

REPORT NO.: RF120718D09A

MODEL NO.: M01186

FCC ID: GV3M01186

RECEIVED: Jul. 2, 2012

TESTED: Jul. 2 ~ 25, 2012

ISSUED: Dec. 6, 2012

APPLICANT: ACCO Brands, Inc.

ADDRESS: 333 Twin Dolphin Drive, 6th Floor, Redwood Shores, CA, 94065, U.S.A.

ISSUED BY: Bureau Veritas Consumer Products Services (H.K.) Ltd., Taoyuan Branch

LAB LOCATION: No. 47, 14th Ling, Chia Pau Vil., Lin Kou Dist., New Taipei City, Taiwan (R.O.C.)

This report should not be used by the client to claim product certification, approval, or endorsement by TAF or any government agencies.



This report is for your exclusive use. Any copying or replication of this report to or for any other person or entity, or use of our name or trademark, is permitted only with our prior written permission. This report sets forth our findings solely with respect to the test samples identified herein. The results set forth in this report are not indicative or representative of the quality or characteristics of the lot from which a test sample was taken or any similar or identical product unless specifically and expressly noted. Our report includes all of the tests requested by you and the results thereof based upon the information that you provided to us. You have 60 days from date of issuance of this report to notify us of any material error or omission caused by our negligence, provided, however, that such notice shall be in writing and shall specifically address the issue you wish to raise. A failure to raise such issue within the prescribed time shall constitute your unqualified acceptance of the completeness of this report, the tests conducted and the correctness of the report contents. Unless specific mention, the uncertainty of measurement has been explicitly taken into account to declare the compliance or non-compliance to the specification.



Table of Contents

RELEASE CONTROL RECORD	4
1. CERTIFICATION.....	5
2. SUMMARY OF TEST RESULTS	6
2.1 MEASUREMENT UNCERTAINTY	6
3. GENERAL INFORMATION	7
3.1 GENERAL DESCRIPTION OF EUT	7
3.2 DESCRIPTION OF TEST MODES	8
3.2.1 TEST MODE APPLICABILITY AND TESTED CHANNEL DETAIL.....	9
3.3 DESCRIPTION OF SUPPORT UNITS	11
3.3.1 CONFIGURATION OF SYSTEM UNDER TEST.....	11
3.4 GENERAL DESCRIPTION OF APPLIED STANDARDS.....	12
4. TEST TYPES AND RESULTS	13
4.1 CONDUCTED EMISSION MEASUREMENT.....	13
4.1.1 LIMITS OF CONDUCTED EMISSION MEASUREMENT	13
4.1.2 TEST INSTRUMENTS.....	13
4.1.3 TEST PROCEDURES	14
4.1.4 DEVIATION FROM TEST STANDARD.....	14
4.1.5 TEST SETUP.....	15
4.1.6 EUT OPERATING CONDITIONS	15
4.1.7 TEST RESULTS	16
4.2 RADIATED EMISSION AND BANDEDGE MEASUREMENT	18
4.2.1 LIMITS OF RADIATED EMISSION AND BANDEDGE MEASUREMENT	18
4.2.2 TEST INSTRUMENTS.....	19
4.2.3 TEST PROCEDURES	20
4.2.4 DEVIATION FROM TEST STANDARD.....	20
4.2.5 TEST SETUP.....	21
4.2.6 EUT OPERATING CONDITIONS	21
4.2.7 TEST RESULTS	22
4.3 NUMBER OF HOPPING FREQUENCY USED.....	26
4.3.1 LIMIT OF HOPPING FREQUENCY USED	26
4.3.2 TEST SETUP.....	26
4.3.3 TEST INSTRUMENTS.....	26
4.3.4 TEST PROCEDURES	26
4.3.5 DEVIATION FROM TEST STANDARD.....	26
4.3.6 TEST RESULTS	26
4.4 DWELL TIME ON EACH CHANNEL.....	28
4.4.1 LIMIT OF DWELL TIME USED	28
4.4.2 TEST SETUP.....	28
4.4.3 TEST INSTRUMENTS.....	28
4.4.4 TEST PROCEDURES	28
4.4.5 DEVIATION FROM TEST STANDARD.....	28
4.4.6 TEST RESULTS	29



A D T

4.5	CHANNEL BANDWIDTH	31
4.5.1	LIMITS OF CHANNEL BANDWIDTH.....	31
4.5.2	TEST SETUP	31
4.5.3	TEST INSTRUMENTS.....	31
4.5.4	TEST PROCEDURE.....	31
4.5.5	DEVIATION FROM TEST STANDARD.....	31
4.5.6	EUT OPERATING CONDITION.....	31
4.5.7	TEST RESULTS	32
4.6	HOPPING CHANNEL SEPARATION.....	33
4.6.1	LIMIT OF HOPPING CHANNEL SEPARATION.....	33
4.6.2	TEST SETUP.....	33
4.6.3	TEST INSTRUMENTS.....	33
4.6.4	TEST PROCEDURES	33
4.6.5	DEVIATION FROM TEST STANDARD.....	33
4.6.6	TEST RESULTS	34
4.7	MAXIMUM OUTPUT POWER	35
4.7.1	LIMITS OF MAXIMUM OUTPUT POWER MEASUREMENT	35
4.7.2	TEST SETUP.....	35
4.7.3	TEST INSTRUMENTS.....	35
4.7.4	TEST PROCEDURES	35
4.7.5	DEVIATION FROM TEST STANDARD.....	35
4.7.6	EUT OPERATING CONDITION.....	35
4.7.7	TEST RESULTS	36
4.8	CONDUCTED OUT OF BAND EMISSION MEASUREMENT	37
4.8.1	LIMITS OF CONDUCTED OUT OF BAND EMISSION MEASUREMENT	37
4.8.2	TEST INSTRUMENTS.....	37
4.8.3	TEST PROCEDURE.....	37
4.8.4	DEVIATION FROM TEST STANDARD.....	37
4.8.5	EUT OPERATING CONDITION.....	37
4.8.6	TEST RESULTS	37
5.	PHOTOGRAPHS OF THE TEST CONFIGURATION	39
6.	INFORMATION ON THE TESTING LABORATORIES.....	40
7.	APPENDIX A - MODIFICATIONS RECORDERS FOR ENGINEERING CHANGES TO THE EUT BY THE LAB.....	41



A D T

RELEASE CONTROL RECORD

ISSUE NO.	REASON FOR CHANGE	DATE ISSUED
RF120718D09A	Original release	Dec. 6, 2012



1. CERTIFICATION

PRODUCT: Bluetooth Keyboard
MODEL NO.: M01186
BRAND: Kensington
APPLICANT: ACCO Brands, Inc.
TESTED: Jul. 2 ~ 25, 2012
TEST SAMPLE: ENGINEERING SAMPLE
STANDARDS: **FCC Part 15, Subpart C (Section 15.247)**
ANSI C63.10-2009

The above equipment has been tested by **Bureau Veritas Consumer Products Services (H.K.) Ltd., Taoyuan Branch**, and found compliance with the requirement of the above standards. The test record, data evaluation & Equipment Under Test (EUT) configurations represented herein are true and accurate accounts of the measurements of the sample's EMC characteristics under the conditions specified in this report.

PREPARED BY : Annie Chang , **DATE:** Dec. 6, 2012
(Annie Chang / Supervisor)

APPROVED BY : Ken Liu , **DATE:** Dec. 6, 2012
(Ken Liu / Manager)

2. SUMMARY OF TEST RESULTS

The EUT has been tested according to the following specifications:

APPLIED STANDARD: FCC Part 15, Subpart C			
STANDARD SECTION	TEST TYPE AND LIMIT	RESULT	REMARK
15.207	AC Power Conducted Emission	PASS	Meet the requirement of limit. Minimum passing margin is -11.37dB at 0.52891MHz.
15.247(a)(1) (iii)	Number of Hopping Frequency Used	PASS	Meet the requirement of limit.
15.247(a)(1) (iii)	Dwell Time on Each Channel	PASS	Meet the requirement of limit.
15.247(a)(1)	1. Hopping Channel Separation 2. Spectrum Bandwidth of a Frequency Hopping Sequence Spread Spectrum System	PASS	Meet the requirement of limit.
15.247(b)	Maximum Peak Output Power	PASS	Meet the requirement of limit.
15.247(d)	Transmitter Radiated Emissions	PASS	Meet the requirement of limit. Minimum passing margin is -8.1dB at 2390.00MHz.
15.247(d)	Band Edge Measurement	PASS	Meet the requirement of limit.
15.203	Antenna Requirement	PASS	No antenna connector is used.

NOTE: If The Frequency Hopping System operating in 2400-2483.5MHz band and the output power less than 125mW. The hopping channel carrier frequencies separated by a minimum of 25kHz or two-thirds of the 20dB bandwidth of hopping channel whichever is greater.

2.1 MEASUREMENT UNCERTAINTY

Where relevant, the following measurement uncertainty levels have been estimated for tests performed on the EUT as specified in CISPR 16-4-2:

Measurement	Frequency	Uncertainty
Conducted emissions	150kHz ~ 30MHz	2.41 dB
Radiated emissions	30MHz ~ 1GHz	3.78 dB
	Above 1GHz	3.36 dB

This uncertainty represents an expanded uncertainty expressed at approximately the 95% confidence level using a coverage factor of k=2.

3. GENERAL INFORMATION

3.1 GENERAL DESCRIPTION OF EUT

EUT	Bluetooth Keyboard
MODEL NO.	M01186
POWER SUPPLY	3.7Vdc (from battery) or 5Vdc (from host equipment)
MODULATION TYPE	GFSK
MODULATION TECHNOLOGY	FHSS
TRANSFER RATE	723.2Kbps
OPERATING FREQUENCY	2402 ~ 2480MHz
NUMBER OF CHANNEL	79
MAX. OUTPUT POWER	0.6mW
ANTENNA TYPE	Printed antenna with -0.56dBi gain
ANTENNA CONNECTOR	NA
I/O PORTS	USB port
DATA CABLE	Shielded USB cable (1.5m)
ACCESSORY DEVICES	NA

NOTE:

1. The EUT is a Bluetooth keyboard with USB interface.
2. USB cable is for battery charging only. The EUT will not initiate communication with PC through this cable.
3. The EUT was pre-tested with the following modes:
 - ✧ Operating Mode (EUT stand-alone)
 - ✧ Operating + Charging Mode (via USB cable)

The worst emission level was found when the EUT tested under **Operating + Charging Mode (via USB cable)**, therefore, only its test data was recorded in this report.

4. The above EUT information is declared by manufacturer and for more detailed features description, please refer to the manufacturer's specifications or User's Manual.



3.2 DESCRIPTION OF TEST MODES

79 channels are provided to this EUT:

CHANNEL	FREQ. (MHz)	CHANNEL	FREQ. (MHz)	CHANNEL	FREQ. (MHz)	CHANNEL	FREQ. (MHz)
0	2402	20	2422	40	2442	60	2462
1	2403	21	2423	41	2443	61	2463
2	2404	22	2424	42	2444	62	2464
3	2405	23	2425	43	2445	63	2465
4	2406	24	2426	44	2446	64	2466
5	2407	25	2427	45	2447	65	2467
6	2408	26	2428	46	2448	66	2468
7	2409	27	2429	47	2449	67	2469
8	2410	28	2430	48	2450	68	2470
9	2411	29	2431	49	2451	69	2471
10	2412	30	2432	50	2452	70	2472
11	2413	31	2433	51	2453	71	2473
12	2414	32	2434	52	2454	72	2474
13	2415	33	2435	53	2455	73	2475
14	2416	34	2436	54	2456	74	2476
15	2417	35	2437	55	2457	75	2477
16	2418	36	2438	56	2458	76	2478
17	2419	37	2439	57	2459	77	2479
18	2420	38	2440	58	2460	78	2480
19	2421	39	2441	59	2461		



3.2.1 TEST MODE APPLICABILITY AND TESTED CHANNEL DETAIL

EUT CONFIGURE MODE	APPLICABLE TO				DESCRIPTION
	PLC	RE≥1G	RE<1G	APCM	
-	√	√	√	√	Operating + Charging (EUT with Notebook)

Where **PLC**: Power Line Conducted Emission **RE≥1G**: Radiated Emission above 1GHz
RE<1G: Radiated Emission below 1GHz **APCM**: Antenna Port Conducted Measurement

POWER LINE CONDUCTED EMISSION TEST:

- Pre-Scan has been conducted to determine the worst-case mode from all possible combinations between available modulations, antenna ports (if EUT with antenna diversity architecture) and packet types.
- Following channel(s) was (were) selected for the final test as listed below.

EUT CONFIGURE MODE	AVAILABLE CHANNEL	TESTED CHANNEL	MODULATION TECHNOLOGY	MODULATION TYPE	PACKET TYPE
-	0 to 78	0	FHSS	GFSK	DH5

RADIATED EMISSION TEST (ABOVE 1 GHz):

- Pre-Scan has been conducted to determine the worst-case mode from all possible combinations between available modulations, antenna ports (if EUT with antenna diversity architecture) and packet type.
- Following channel(s) was (were) selected for the final test as listed below.

EUT CONFIGURE MODE	AVAILABLE CHANNEL	TESTED CHANNEL	MODULATION TECHNOLOGY	MODULATION TYPE	PACKET TYPE
-	0 to 78	0, 39, 78	FHSS	GFSK	DH5

RADIATED EMISSION TEST (BELOW 1 GHz):

- Pre-Scan has been conducted to determine the worst-case mode from all possible combinations between available modulations, antenna ports (if EUT with antenna diversity architecture) and packet type.
- Following channel(s) was (were) selected for the final test as listed below.

EUT CONFIGURE MODE	AVAILABLE CHANNEL	TESTED CHANNEL	MODULATION TECHNOLOGY	MODULATION TYPE	PACKET TYPE
-	0 to 78	0	FHSS	GFSK	DH5



BANDEDGE MEASUREMENT:

- Pre-Scan has been conducted to determine the worst-case mode from all possible combinations between available modulations, antenna ports (if EUT with antenna diversity architecture), and packet types.
- Following channel(s) was (were) selected for the final test as listed below.

EUT CONFIGURE MODE	AVAILABLE CHANNEL	TESTED CHANNEL	MODULATION TECHNOLOGY	MODULATION TYPE	PACKET TYPE
-	0 to 78	0, 78	FHSS	GFSK	DH5

ANTENNA PORT CONDUCTED MEASUREMENT:

- This item includes all test value of each mode, but only includes spectrum plot of worst value of each mode.
- Pre-Scan has been conducted to determine the worst-case mode from all possible combinations between available modulations, antenna ports (if EUT with antenna diversity architecture), and packet types.
- Following channel(s) was (were) selected for the final test as listed below.

EUT CONFIGURE MODE	AVAILABLE CHANNEL	TESTED CHANNEL	MODULATION TECHNOLOGY	MODULATION TYPE	PACKET TYPE
-	0 to 78	0, 39, 78	FHSS	GFSK	DH5

TEST CONDITION:

APPLICABLE TO	ENVIRONMENTAL CONDITIONS	INPUT POWER	TESTED BY
PLC	28deg. C, 67% RH	120Vac, 60Hz (System)	Jun Wu
RE≥1G	26deg. C, 82% RH	120Vac, 60Hz (System)	Antony Lee
RE<1G	26deg. C, 82% RH	120Vac, 60Hz (System)	Antony Lee
APCM	25deg. C, 70% RH	120Vac, 60Hz (System)	Jun Wu

3.3 DESCRIPTION OF SUPPORT UNITS

The EUT has been tested as an independent unit together with other necessary accessories or support units. The following support units or accessories were used to form a representative test configuration during the tests.

NO.	PRODUCT	BRAND	MODEL NO.	SERIAL NO.	FCC ID
1	NOTEBOOK COMPUTER	DELL	PP27L	8SNZ12S	FCC DoC Approved

NO.	SIGNAL CABLE DESCRIPTION OF THE ABOVE SUPPORT UNITS
1	N/A

NOTE: All power cords of the above support units are non shielded (1.8m).

3.3.1 CONFIGURATION OF SYSTEM UNDER TEST

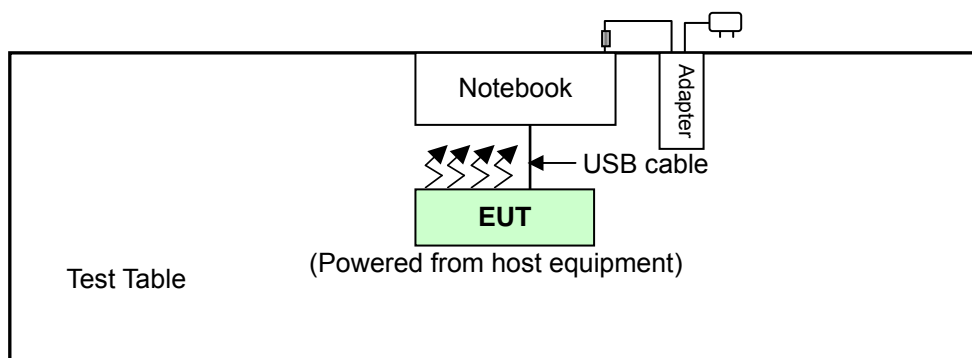



3.4 GENERAL DESCRIPTION OF APPLIED STANDARDS

The EUT is a RF Product. According to the specifications of the manufacturer, it must comply with the requirements of the following standards:

FCC Part 15, Subpart C. (15.247)

ANSI C63.10-2009

All test items have been performed and recorded as per the above standards.

4. TEST TYPES AND RESULTS

4.1 CONDUCTED EMISSION MEASUREMENT

4.1.1 LIMITS OF CONDUCTED EMISSION MEASUREMENT

FREQUENCY OF EMISSION (MHz)	CONDUCTED LIMIT (dB μ V)	
	Quasi-peak	Average
0.15 ~ 0.5	66 to 56	56 to 46
0.5 ~ 5	56	46
5 ~ 30	60	50

- NOTE:** 1. The lower limit shall apply at the transition frequencies.
 2. The limit decreases in line with the logarithm of the frequency in the range of 0.15 to 0.50MHz.

4.1.2 TEST INSTRUMENTS

DESCRIPTION & MANUFACTURER	MODEL NO.	SERIAL NO.	CALIBRATED DATE	CALIBRATED UNTIL
ROHDE & SCHWARZ Test Receiver	ESCS 30	100276	Jan. 04, 2012	Jan. 03, 2013
ROHDE & SCHWARZ Artificial Mains Network (for EUT)	ESH3-Z5	100219	Nov. 24, 2011	Nov. 23, 2012
LISN With Adapter (for EUT)	AD10	C10Ada-001	Nov. 24, 2011	Nov. 23, 2012
ROHDE & SCHWARZ Artificial Mains Network (for peripherals)	ESH3-Z5	100218	Dec. 08, 2011	Dec. 07, 2012
Software	ADT_Cond_V7.3.7	NA	NA	NA
Software	ADT_ISN_V7.3.7	NA	NA	NA
RF cable (JYEBAO)	5D-FB	Cable-C10.01	Feb. 20, 2012	Feb. 19, 2013
SUHNER Terminator (For ROHDE & SCHWARZ LISN)	65BNC-5001	E1-010773	Feb. 22, 2012	Feb. 21, 2013

- NOTE:** 1. The calibration interval of the above test instruments is 12 months and the calibrations are traceable to NML/ROC and NIST/USA.
 2. The test was performed in Shielded Room No. 10.
 3. The VCCI Site Registration No. C-1852.

4.1.3 TEST PROCEDURES

- a. The EUT was placed 0.4 meters from the conducting wall of the shielded room with EUT being connected to the power mains through a line impedance stabilization network (LISN). Other support units were connected to the power mains through another LISN. The two LISNs provide 50 ohm/ 50uH of coupling impedance for the measuring instrument.
- b. Both lines of the power mains connected to the EUT were checked for maximum conducted interference.
- c. The frequency range from 150kHz to 30MHz was searched. Emission levels under (Limit - 20dB) was not recorded.

NOTE: All modes of operation were investigated and the worst-case emissions are reported.

4.1.4 DEVIATION FROM TEST STANDARD

No deviation.

4.1.5 TEST SETUP

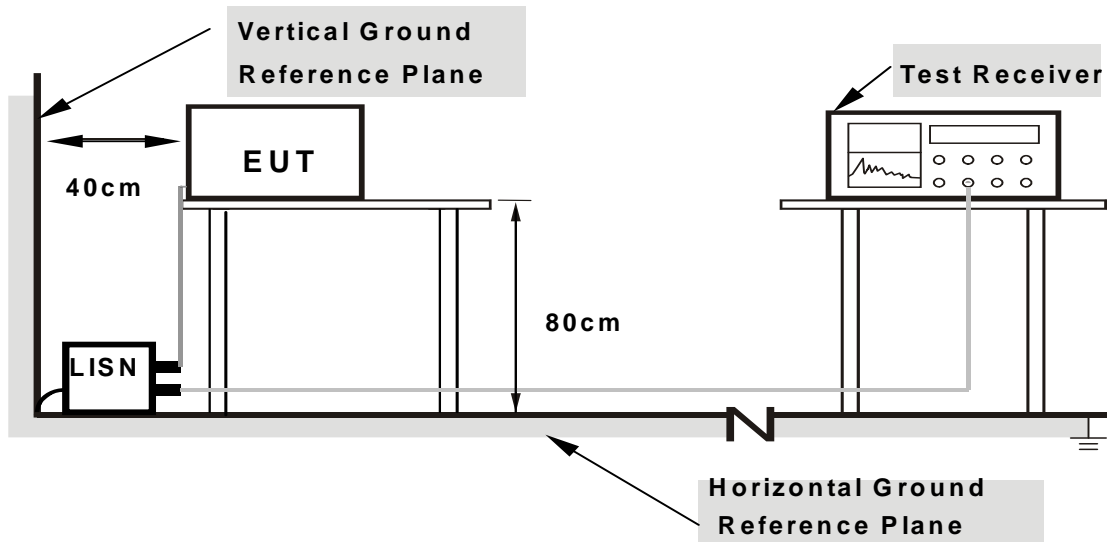

- Note:**
1. Support units were connected to second LISN.
 2. Both of LISNs (AMN) are 80 cm from EUT and at least 80 from other units and other metal planes

For the actual test configuration, please refer to the attached file (Test Setup Photo).

4.1.6 EUT OPERATING CONDITIONS

- a. Turn on the power of all equipment.
- b. Notebook ran a test program (provided by manufacture) to enable EUT under transmitting condition at specific channel continuously.
- c. Set the EUT under transmitting and charging condition.

4.1.7 TEST RESULTS

CONDUCTED WORST-CASE DATA

PHASE	Line 1	6dB BANDWIDTH	9kHz
CHANNEL	0		

No	Freq. [MHz]	Corr. Factor (dB)	Reading Value [dB (uV)]		Emission Level [dB (uV)]		Limit [dB (uV)]		Margin (dB)	
			Q.P.	AV.	Q.P.	AV.	Q.P.	AV.	Q.P.	AV.
1	0.23203	0.16	42.60	-	42.76	-	62.38	52.38	-19.62	-
2	0.46250	0.19	40.20	-	40.39	-	56.65	46.65	-16.25	-
3	0.52891	0.20	43.21	-	43.41	-	56.00	46.00	-12.59	-
4	0.68906	0.21	36.59	-	36.80	-	56.00	46.00	-19.20	-
5	12.16797	0.85	27.32	-	28.17	-	60.00	50.00	-31.83	-
6	17.84375	1.16	31.05	-	32.21	-	60.00	50.00	-27.79	-

REMARKS:

1. Q.P. and AV. are abbreviations of quasi-peak and average individually.
2. "-": The Quasi-peak reading value also meets average limit and measurement with the average detector is unnecessary.
3. The emission levels of other frequencies were very low against the limit.
4. Margin value = Emission level - Limit value
5. Correction factor = Insertion loss + Cable loss
6. Emission Level = Correction Factor + Reading Value.

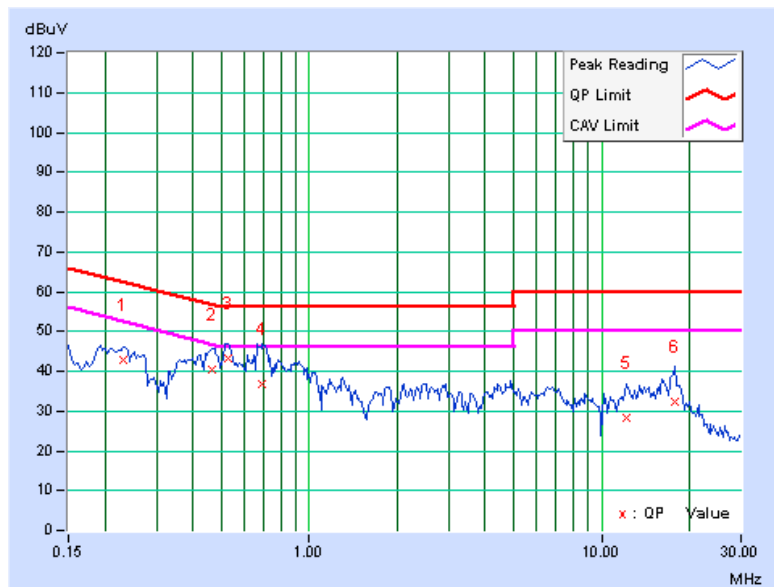



A D T

PHASE	Line 2	6dB BANDWIDTH	9kHz
CHANNEL	0		

No	Freq. [MHz]	Corr. Factor (dB)	Reading Value		Emission Level		Limit		Margin	
			[dB (uV)]		[dB (uV)]		[dB (uV)]		(dB)	
			Q.P.	AV.	Q.P.	AV.	Q.P.	AV.	Q.P.	AV.
1	0.35703	0.18	41.00	-	41.18	-	58.80	48.80	-17.62	-
2	0.46250	0.19	40.99	-	41.18	-	56.65	46.65	-15.46	-
3	0.52891	0.20	44.43	-	44.63	-	56.00	46.00	-11.37	-
4	0.66563	0.21	35.88	-	36.09	-	56.00	46.00	-19.91	-
5	11.70703	0.67	25.14	-	25.81	-	60.00	50.00	-34.19	-
6	17.86719	0.87	28.91	-	29.78	-	60.00	50.00	-30.22	-

REMARKS:

1. Q.P. and AV. are abbreviations of quasi-peak and average individually.
2. "-": The Quasi-peak reading value also meets average limit and measurement with the average detector is unnecessary.
3. The emission levels of other frequencies were very low against the limit.
4. Margin value = Emission level - Limit value
5. Correction factor = Insertion loss + Cable loss
6. Emission Level = Correction Factor + Reading Value.

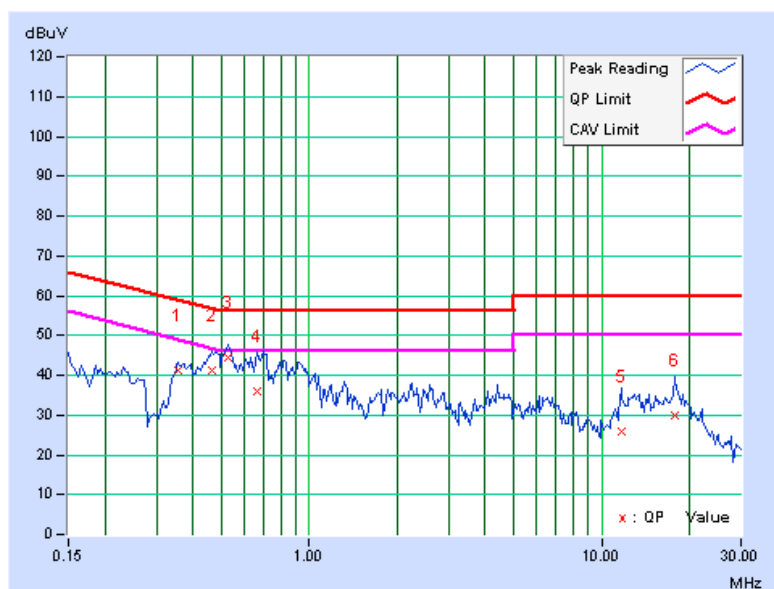

4.2 RADIATED EMISSION AND BANDEDGE MEASUREMENT

4.2.1 LIMITS OF RADIATED EMISSION AND BANDEDGE MEASUREMENT

Radiated emissions which fall in the restricted bands must comply with the radiated emission limits specified as below table. Other emissions shall be at least 20dB below the highest level of the desired power:

FREQUENCIES (MHz)	FIELD STRENGTH (microvolts/meter)	MEASUREMENT DISTANCE (meters)
0.009 ~ 0.490	2400/F(kHz)	300
0.490 ~ 1.705	24000/F(kHz)	30
1.705 ~ 30.0	30	30
30 ~ 88	100	3
88 ~ 216	150	3
216 ~ 960	200	3
Above 960	500	3

NOTE:

1. The lower limit shall apply at the transition frequencies.
2. Emission level (dBuV/m) = 20 log Emission level (uV/m).
3. For frequencies above 1000MHz, the field strength limits are based on average detector, however, the peak field strength of any emission shall not exceed the maximum permitted average limits, specified above by more than 20dB under any condition of modulation.



A D T

4.2.2 TEST INSTRUMENTS

DESCRIPTION & MANUFACTURER	MODEL NO.	SERIAL NO.	CALIBRATED DATE	CALIBRATED UNTIL
HP Preamplifier	8447D	2432A03504	Feb. 29, 2012	Feb. 28, 2013
HP Preamplifier	8449B	3008A01201	Feb. 29, 2012	Feb. 28, 2013
Agilent Spectrum Analyzer	E4446A	MY46180403	Jun. 13, 2012	Jun. 12, 2013
ROHDE & SCHWARZ Test Receiver	ESCS 30	838251/021	Oct. 14, 2011	Oct. 13, 2012
Schwarzbeck Antenna	VULB 9168	137	Apr. 03, 2012	Apr. 02, 2013
Schwarzbeck Antenna	VHBA 9123	480	May 22, 2012	May 21, 2013
ADT. Turn Table	TT100	0306	NA	NA
ADT. Tower	AT100	0306	NA	NA
Software	ADT_Radiated_V 7.6.15.9.2	NA	NA	NA
SUHNER RF cable	SF102	CABLE-CH6	Aug. 19, 2011	Aug. 18, 2012
Schwarzbeck Horn Antenna	BBHA 9120-D1	D130	May 18, 2012	May 17, 2013
Highpass filter Wainwright Instruments	WHK 3.1/18G-10SS	SN 8	NA	NA
ROHDE & SCHWARZ Spectrum Analyzer	FSP 40	100036	May 09, 2012	May 08, 2013
Anritsu Power Sensor	MA2411B	0738404	Apr. 28, 2012	Apr. 27, 2013
Anritsu Power Meter	ML2495A	0842014	Apr. 28, 2012	Apr. 27, 2013

- NOTE:** 1. The calibration interval of the above test instruments is 12 months. And the calibrations are traceable to NML/ROC and NIST/USA.
2. The horn antenna and HP preamplifier (model: 8449B) are used only for the measurement of emission frequency above 1GHz if tested.
3. The test was performed in Chamber No. 6.
4. The Industry Canada Reference No. IC 7450E-6.
5. The FCC Site Registration No. is 447212.

4.2.3 TEST PROCEDURES

- a. The EUT was placed on the top of a rotating table 0.8 meters above the ground at a 3 meter semi-anechoic chamber. The table was rotated 360 degrees to determine the position of the highest radiation.
- b. The EUT was set 3 meters away from the interference-receiving antenna, which was mounted on the top of a variable-height antenna tower.
- c. The height of antenna is varied from one meter to four meters above the ground to determine the maximum value of the field strength. Both horizontal and vertical polarizations of the antenna are set to make the measurement.
- d. For each suspected emission, the EUT was arranged to its worst case and then the antenna was tuned to heights from 1 meter to 4 meters and the rotatable table was turned from 0 degrees to 360 degrees to find the maximum reading.
- e. The test-receiver system was set to Peak Detect Function and Specified Bandwidth with Maximum Hold Mode.
- f. If the emission level of the EUT in peak mode was lower than the limit specified, then testing could be stopped and the peak values of the EUT would be reported. Otherwise the emissions would be re-tested one by one using peak, quasi-peak or average method as specified and then reported in a data sheet.

NOTE:

1. The resolution bandwidth and video bandwidth of test receiver/spectrum analyzer is 120kHz for Quasi-peak detection at frequency below 1GHz.
2. The resolution bandwidth of test receiver/spectrum analyzer is 1 MHz and video bandwidth is 3MHz for Peak detection at frequency above 1GHz.
3. All modes of operation were investigated and the worst-case emissions are reported.

4.2.4 DEVIATION FROM TEST STANDARD

No deviation.

4.2.5 TEST SETUP

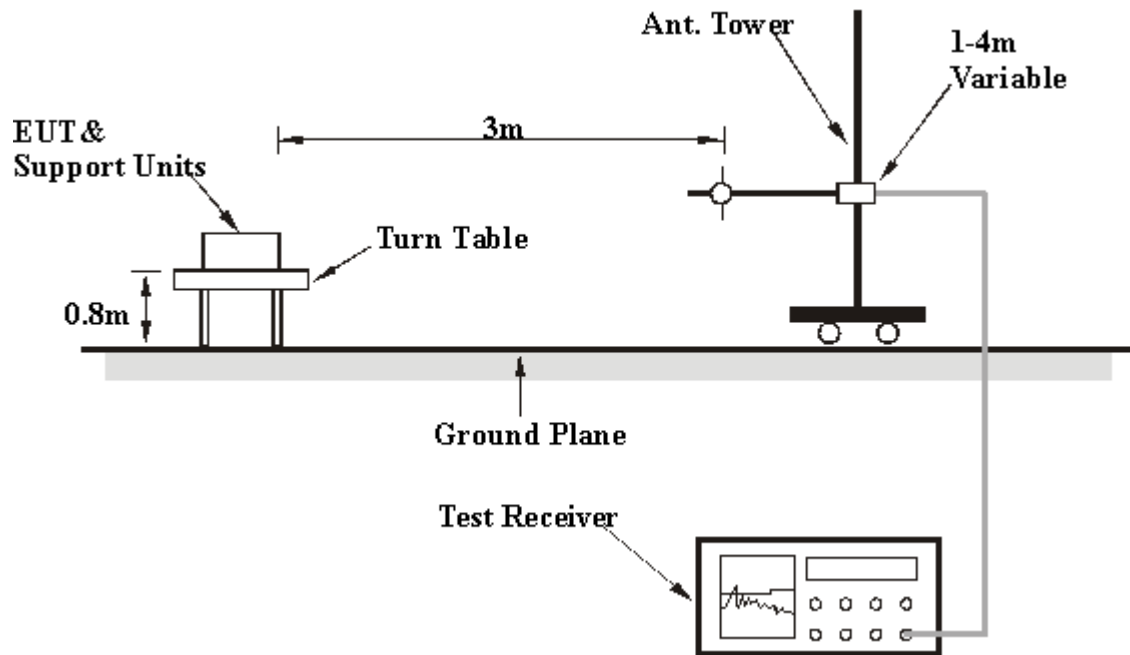

For the actual test configuration, please refer to the attached file (Test Setup Photo).

4.2.6 EUT OPERATING CONDITIONS

Same as item 4.1.6.



A D T

4.2.7 TEST RESULTS

EUT TEST CONDITION		MEASUREMENT DETAIL	
CHANNEL	Channel 0	FREQUENCY RANGE	1 ~ 25GHz
INPUT POWER (SYSTEM)	120Vac, 60Hz	DETECTOR FUNCTION	Peak (PK) Average (AV)
ENVIRONMENTAL CONDITIONS	26deg. C, 82%RH	TESTED BY	Antony Lee

ANTENNA POLARITY & TEST DISTANCE: HORIZONTAL AT 3 M								
NO.	FREQ. (MHz)	EMISSION LEVEL (dBuV/m)	LIMIT (dBuV/m)	MARGIN (dB)	ANTENNA HEIGHT (m)	TABLE ANGLE (Degree)	RAW VALUE (dBuV)	CORRECTION FACTOR (dB/m)
1	2390.00	56.5 PK	74.0	-17.6	1.00 H	265	26.21	30.24
2	2390.00	45.9 AV	54.0	-8.1	1.00 H	265	15.68	30.24
3	#2400.00	38.2 PK	77.2	-39.0	1.02 H	203	7.88	30.29
4	#2400.00	8.1 AV	47.1	-39.0	1.02 H	203	-22.22	30.29
5	*2402.00	97.2 PK			1.02 H	203	66.87	30.30
6	*2402.00	67.1 AV			1.02 H	203	36.77	30.30
7	4804.00	45.5 PK	74.0	-28.5	1.01 H	37	8.95	36.59
8	4804.00	15.4 AV	54.0	-38.6	1.01 H	37	-21.15	36.59
ANTENNA POLARITY & TEST DISTANCE: VERTICAL AT 3 M								
NO.	FREQ. (MHz)	EMISSION LEVEL (dBuV/m)	LIMIT (dBuV/m)	MARGIN (dB)	ANTENNA HEIGHT (m)	TABLE ANGLE (Degree)	RAW VALUE (dBuV)	CORRECTION FACTOR (dB/m)
1	2390.00	55.5 PK	74.0	-18.5	1.05 V	293	25.23	30.24
2	2390.00	43.4 AV	54.0	-10.6	1.05 V	293	13.15	30.24
3	#2400.00	34.2 PK	73.2	-39.0	1.04 V	294	3.88	30.29
4	#2400.00	4.1 AV	43.1	-39.0	1.04 V	294	-26.22	30.29
5	*2402.00	93.2 PK			1.04 V	294	62.87	30.30
6	*2402.00	63.1 AV			1.04 V	294	32.77	30.30
7	4804.00	44.2 PK	74.0	-29.8	1.00 V	266	7.65	36.59
8	4804.00	14.1 AV	54.0	-39.9	1.00 V	266	-22.45	36.59

REMARKS:

1. Emission level (dBuV/m) = Raw Value (dBuV) + Correction Factor (dB/m).
2. Correction Factor (dB/m) = Antenna Factor (dB/m) + Cable Factor (dB).
3. The other emission levels were very low against the limit.
4. Margin value = Emission level – Limit value.
5. “ * “: Fundamental frequency.
6. The DH5 packet was the worse case duty cycle for a transmit dwell time on a channel, based upon bluetooth theory the transmitter is on 0.625 * 5 per 296.25 ms per channel. Therefore, the duty cycle correlation factor be equal to: $20\log(3.125 / 100) = -30.1$ dB.
7. Average value = peak reading + $20\log(\text{duty cycle})$.
8. "#": The radiated frequency is out the restricted band.



A D T

EUT TEST CONDITION		MEASUREMENT DETAIL	
CHANNEL	Channel 39	FREQUENCY RANGE	1 ~ 25GHz
INPUT POWER (SYSTEM)	120Vac, 60Hz	DETECTOR FUNCTION	Peak (PK) Average (AV)
ENVIRONMENTAL CONDITIONS	26deg. C, 82%RH	TESTED BY	Antony Lee

ANTENNA POLARITY & TEST DISTANCE: HORIZONTAL AT 3 M								
NO.	FREQ. (MHz)	EMISSION LEVEL (dBuV/m)	LIMIT (dBuV/m)	MARGIN (dB)	ANTENNA HEIGHT (m)	TABLE ANGLE (Degree)	RAW VALUE (dBuV)	CORRECTION FACTOR (dB/m)
1	*2441.00	96.6 PK			1.00 H	202	66.14	30.43
2	*2441.00	66.5 AV			1.00 H	202	36.04	30.43
3	4882.00	46.4 PK	74.0	-27.7	1.00 H	33	9.56	36.79
4	4882.00	16.3 AV	54.0	-37.8	1.00 H	33	-20.54	36.79
ANTENNA POLARITY & TEST DISTANCE: VERTICAL AT 3 M								
NO.	FREQ. (MHz)	EMISSION LEVEL (dBuV/m)	LIMIT (dBuV/m)	MARGIN (dB)	ANTENNA HEIGHT (m)	TABLE ANGLE (Degree)	RAW VALUE (dBuV)	CORRECTION FACTOR (dB/m)
1	*2441.00	91.8 PK			1.05 V	272	61.37	30.43
2	*2441.00	61.7 AV			1.05 V	272	31.27	30.43
3	4882.00	44.6 PK	74.0	-29.4	1.00 V	274	7.85	36.79
4	4882.00	14.5 AV	54.0	-39.5	1.00 V	274	-22.25	36.79

REMARKS:

1. Emission level (dBuV/m) = Raw Value (dBuV) + Correction Factor (dB/m).
2. Correction Factor (dB/m) = Antenna Factor (dB/m) + Cable Factor (dB).
3. The other emission levels were very low against the limit.
4. Margin value = Emission level – Limit value.
5. “ * “: Fundamental frequency.
6. The DH5 packet was the worse case duty cycle for a transmit dwell time on a channel, based upon bluetooth theory the transmitter is on 0.625 * 5 per 296.25 ms per channel. Therefore, the duty cycle correlation factor be equal to: $20\log(3.125 / 100) = -30.1$ dB.
7. Average value = peak reading + $20\log(\text{duty cycle})$.



EUT TEST CONDITION		MEASUREMENT DETAIL	
CHANNEL	Channel 78	FREQUENCY RANGE	1 ~ 25GHz
INPUT POWER (SYSTEM)	120Vac, 60Hz	DETECTOR FUNCTION	Peak (PK) Average (AV)
ENVIRONMENTAL CONDITIONS	26deg. C, 82%RH	TESTED BY	Antony Lee

ANTENNA POLARITY & TEST DISTANCE: HORIZONTAL AT 3 M

NO.	FREQ. (MHz)	EMISSION LEVEL (dBuV/m)	LIMIT (dBuV/m)	MARGIN (dB)	ANTENNA HEIGHT (m)	TABLE ANGLE (Degree)	RAW VALUE (dBuV)	CORRECTION FACTOR (dB/m)
1	*2480.00	94.3 PK			1.00 H	205	63.75	30.56
2	*2480.00	64.2 AV			1.00 H	205	33.65	30.56
3	2483.50	32.9 PK	74.0	-41.1	1.00 H	205	2.34	30.57
4	2483.50	2.8 AV	54.0	-51.2	1.00 H	205	-27.76	30.57
5	4960.00	46.0 PK	74.0	-28.0	1.00 H	263	9.05	36.99
6	4960.00	15.9 AV	54.0	-38.1	1.00 H	263	-21.05	36.99

ANTENNA POLARITY & TEST DISTANCE: VERTICAL AT 3 M

NO.	FREQ. (MHz)	EMISSION LEVEL (dBuV/m)	LIMIT (dBuV/m)	MARGIN (dB)	ANTENNA HEIGHT (m)	TABLE ANGLE (Degree)	RAW VALUE (dBuV)	CORRECTION FACTOR (dB/m)
1	*2480.00	92.0 PK			1.00 V	80	61.45	30.56
2	*2480.00	61.9 AV			1.00 V	80	31.35	30.56
3	2483.50	30.6 PK	74.0	-43.4	1.00 V	80	0.04	30.57
4	2483.50	0.5 AV	54.0	-53.5	1.00 V	80	-30.06	30.57
5	4960.00	47.7 PK	74.0	-26.3	1.00 V	144	10.74	36.99
6	4960.00	17.6 AV	54.0	-36.4	1.00 V	144	-19.36	36.99

REMARKS:

1. Emission level (dBuV/m) = Raw Value (dBuV) + Correction Factor (dB/m).
2. Correction Factor (dB/m) = Antenna Factor (dB/m) + Cable Factor (dB).
3. The other emission levels were very low against the limit.
4. Margin value = Emission level – Limit value.
5. “ * “: Fundamental frequency.
6. The DH5 packet was the worse case duty cycle for a transmit dwell time on a channel, based upon bluetooth theory the transmitter is on 0.625 * 5 per 296.25 ms per channel. Therefore, the duty cycle correlation factor be equal to: $20\log(3.125 / 100) = -30.1$ dB.
7. Average value = peak reading + $20\log(\text{duty cycle})$.



A D T

BELOW 1GHz WORST-CASE DATA

EUT TEST CONDITION		MEASUREMENT DETAIL	
CHANNEL	Channel 0	FREQUENCY RANGE	Below 1000MHz
INPUT POWER (SYSTEM)	120Vac, 60Hz	DETECTOR FUNCTION	Quasi-Peak
ENVIRONMENTAL CONDITIONS	26deg. C, 82%RH	TESTED BY	Antony Lee

ANTENNA POLARITY & TEST DISTANCE: HORIZONTAL AT 3 M

NO.	FREQ. (MHz)	EMISSION LEVEL (dBuV/m)	LIMIT (dBuV/m)	MARGIN (dB)	ANTENNA HEIGHT (m)	TABLE ANGLE (Degree)	RAW VALUE (dBuV)	CORRECTION FACTOR (dB/m)
1	99.52	30.6 QP	43.5	-12.9	1.14 H	172	21.19	9.39
2	144.78	29.3 QP	43.5	-14.2	1.39 H	357	15.29	14.02
3	165.80	30.3 QP	43.5	-13.2	1.82 H	20	16.54	13.74
4	266.03	28.7 QP	46.0	-17.4	1.06 H	317	14.38	14.27
5	299.98	29.4 QP	46.0	-16.6	1.55 H	11	13.82	15.62
6	799.53	28.8 QP	46.0	-17.2	1.35 H	10	2.31	26.50

ANTENNA POLARITY & TEST DISTANCE: VERTICAL AT 3 M

NO.	FREQ. (MHz)	EMISSION LEVEL (dBuV/m)	LIMIT (dBuV/m)	MARGIN (dB)	ANTENNA HEIGHT (m)	TABLE ANGLE (Degree)	RAW VALUE (dBuV)	CORRECTION FACTOR (dB/m)
1	99.52	25.6 QP	43.5	-17.9	1.08 V	268	16.20	9.39
2	144.78	25.7 QP	43.5	-17.8	1.36 V	264	11.71	14.02
3	434.17	26.0 QP	46.0	-20.0	1.55 V	105	6.74	19.28
4	527.93	27.2 QP	46.0	-18.8	1.49 V	315	5.52	21.70
5	697.68	26.3 QP	46.0	-19.7	1.38 V	184	1.69	24.58
6	833.48	27.2 QP	46.0	-18.8	1.05 V	347	0.20	27.03

REMARKS:

1. Emission level (dBuV/m) = Raw Value (dBuV) + Correction Factor (dB/m).
2. Correction Factor (dB/m) = Antenna Factor (dB/m) + Cable Factor (dB).
3. The other emission levels were very low against the limit.
4. Margin value = Emission level – Limit value.

4.3 NUMBER OF HOPPING FREQUENCY USED

4.3.1 LIMIT OF HOPPING FREQUENCY USED

At least 15 channels frequencies, and should be equally spaced.

4.3.2 TEST SETUP

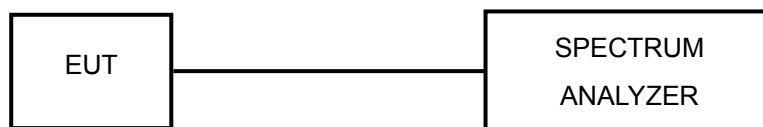

4.3.3 TEST INSTRUMENTS

Refer to section 4.2.2 to get information of above instrument.

4.3.4 TEST PROCEDURES

- a. Check the calibration of the measuring instrument (SA) using either an internal calibrator or a known signal from an external generator.
- b. Turn on the EUT and connect its antenna terminal to measurement via a low loss cable. Then set it to any one measured frequency within its operating range and make sure the instrument is operated in its linear range.
- c. Set the SA on MaxHold Mode, and then keep the EUT in hopping mode. Record all the signals from each channel until each one has been recorded.
- d. Set the SA on View mode and then plot the result on SA screen.
- e. Repeat above procedures until all frequencies measured were complete.

4.3.5 DEVIATION FROM TEST STANDARD

No deviation.

4.3.6 TEST RESULTS

There are 79 hopping frequencies in the hopping mode. Please refer to next two pages for the test result. On the plots, it shows that the hopping frequencies are equally spaced.



A D T

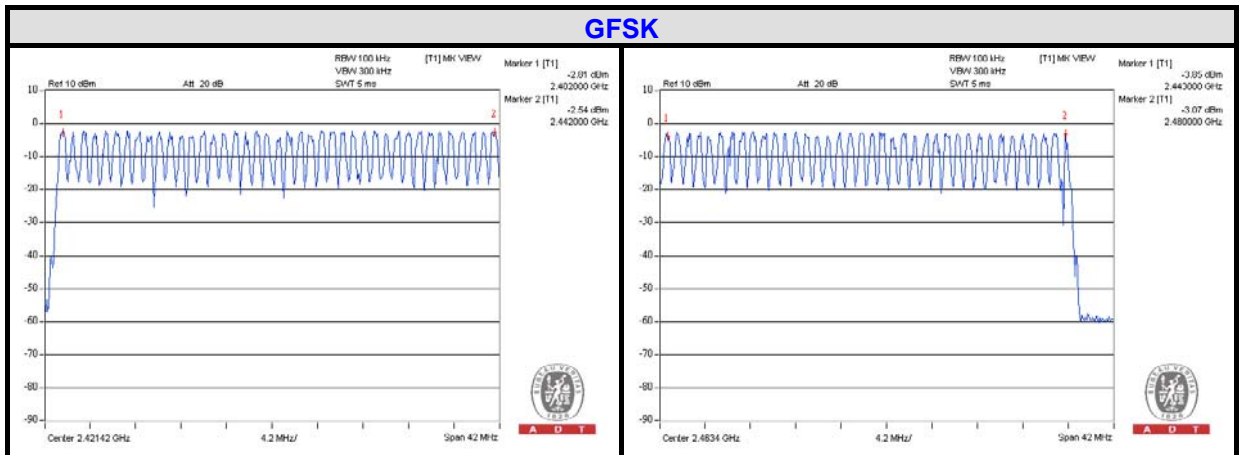

4.4 DWELL TIME ON EACH CHANNEL

4.4.1 LIMIT OF DWELL TIME USED

The average time of occupancy on any channel shall not be greater than 0.4 seconds within a period of 0.4 seconds multiplied by the number of hopping channels employed.

4.4.2 TEST SETUP

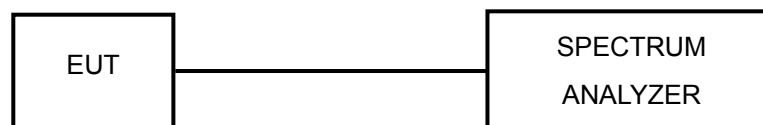

4.4.3 TEST INSTRUMENTS

Refer to section 4.2.2 to get information of above instrument.

4.4.4 TEST PROCEDURES

- a. Check the calibration of the measuring instrument (SA) using either an internal calibrator or a known signal from an external generator.
- b. Turn on the EUT and connect its antenna terminal to measurement via a low loss cable. Then set it to any one measured frequency within its operating range and make sure the instrument is operated in its linear range.
- c. Adjust the center frequency of SA on any frequency be measured and set SA to zero span mode. And then, set RBW and VBW of spectrum analyzer to proper value.
- d. Measure the time duration of one transmission on the measured frequency. And then plot the result with time difference of this time duration.
- e. Repeat above procedures until all different time-slot modes have been completed.

4.4.5 DEVIATION FROM TEST STANDARD

No deviation.

4.4.6 TEST RESULTS

Mode	Number of transmission in a 31.6 (79Hopping*0.4)	Length of transmission time (msec)	Result (msec)	Limit (msec)
DH1	50 (times / 5 sec) * 6.32 = 316.00times	0.48	151.6800	400
DH3	25 (times / 5 sec) * 6.32 = 158.00 times	1.74	274.9200	400
DH5	16 (times / 5 sec) * 6.32 = 101.12 times	3.04	307.4048	400

NOTE: Test plots of the transmitting time slot are shown on next page.



A D T

DH1

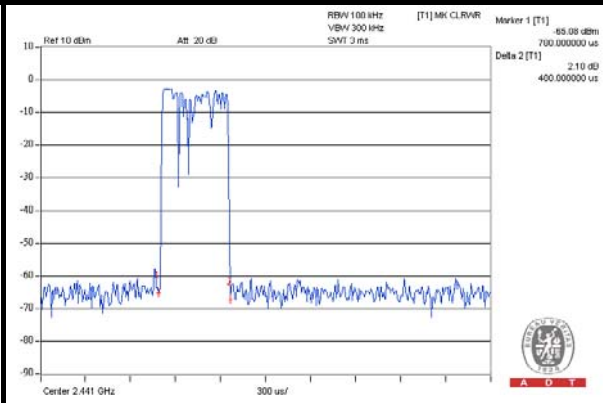
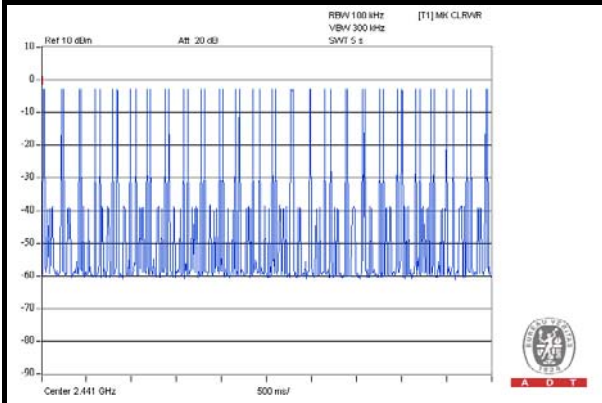

DH3

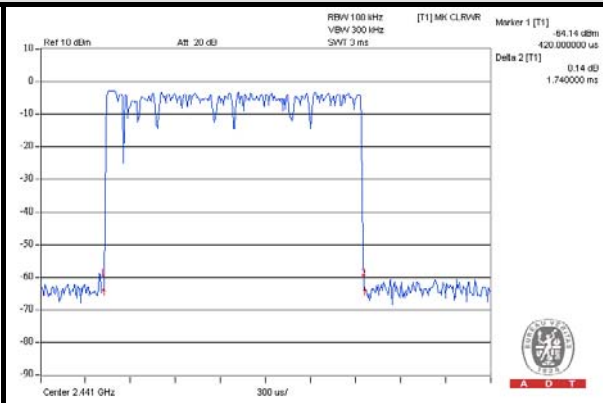
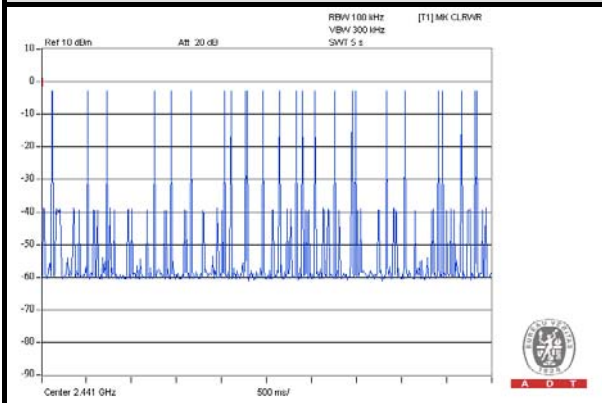

DH5

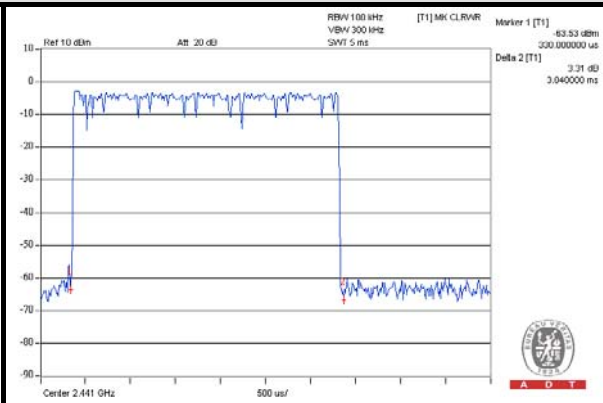
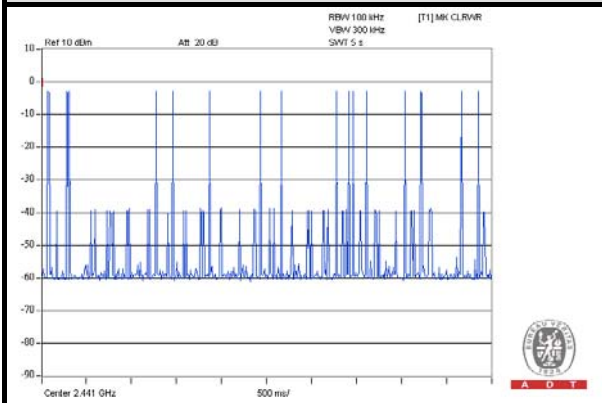

4.5 CHANNEL BANDWIDTH

4.5.1 LIMITS OF CHANNEL BANDWIDTH

For frequency hopping system operating in the 2400-2483.5MHz, If the 20dB bandwidth of hopping channel is greater than 25kHz, two-thirds 20dB bandwidth of hopping channel shall be a minimum limit for the hopping channel separation.

4.5.2 TEST SETUP

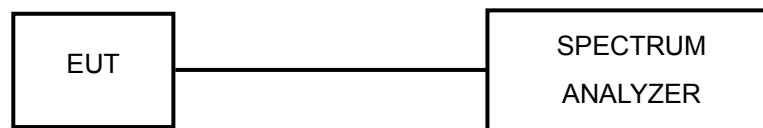

4.5.3 TEST INSTRUMENTS

Refer to section 4.2.2 to get information of above instrument.

4.5.4 TEST PROCEDURE

- a. Check the calibration of the measuring instrument using either an internal calibrator or a known signal from an external generator.
- b. Turn on the EUT and connect it to measurement instrument. Then set it to any one convenient frequency within its operating range. Set a reference level on the measuring instrument equal to the highest peak value.
- c. Measure the frequency difference of two frequencies that were attenuated 20dB from the reference level. Record the frequency difference as the emission bandwidth.
- d. Repeat above procedures until all frequencies measured were complete.

4.5.5 DEVIATION FROM TEST STANDARD

No deviation.

4.5.6 EUT OPERATING CONDITION

The software provided by client enabled the EUT to transmit and receive data at lowest, middle and highest channel frequencies individually.



A D T

4.5.7 TEST RESULTS

CHANNEL	FREQUENCY (MHz)	20dB BANDWIDTH (MHz)
0	2402	1.12
39	2441	1.04
78	2480	1.04

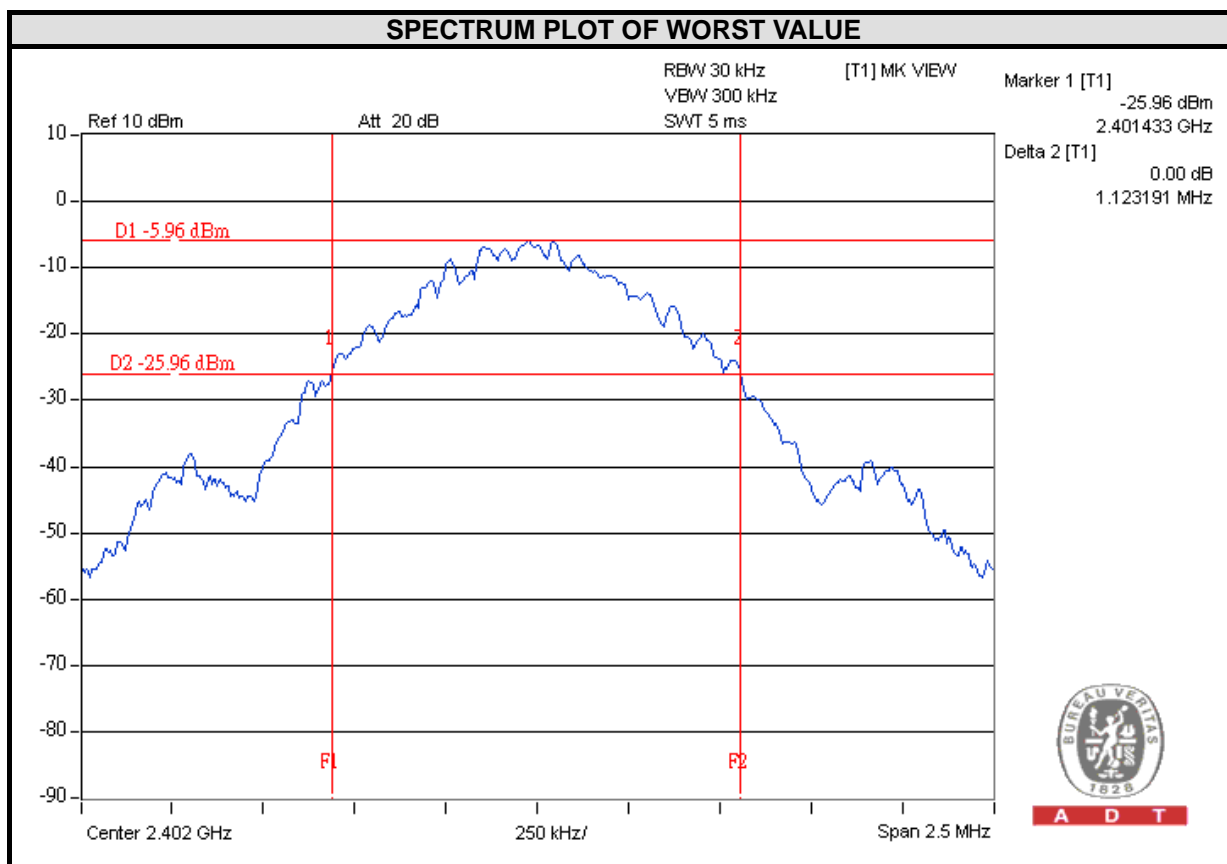

A D T

4.6 HOPPING CHANNEL SEPARATION

4.6.1 LIMIT OF HOPPING CHANNEL SEPARATION

At least 25kHz or two-third of 20dB hopping channel bandwidth (whichever is greater).

4.6.2 TEST SETUP

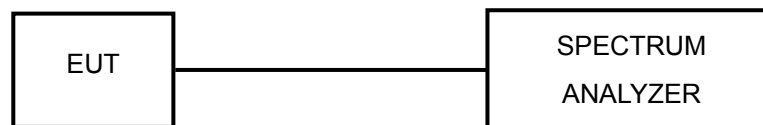

4.6.3 TEST INSTRUMENTS

Refer to section 4.2.2 to get information of above instrument.

4.6.4 TEST PROCEDURES

- a. Check the calibration of the measuring instrument using either an internal calibrator or a known signal from an external generator.
- b. Turn on the EUT and connect it to measurement instrument. Then set it to any one convenient frequency within its operating range.
- c. By using the MaxHold function record the separation of two adjacent channels.
- d. Measure the frequency difference of these two adjacent channels by SA MARK function. And then plot the result on SA screen.
- e. Repeat above procedures until all frequencies measured were complete.

4.6.5 DEVIATION FROM TEST STANDARD

No deviation.

4.7 MAXIMUM OUTPUT POWER

4.7.1 LIMITS OF MAXIMUM OUTPUT POWER MEASUREMENT

The Maximum Output Power Measurement is 125mW.

4.7.2 TEST SETUP

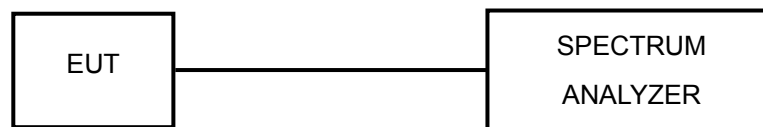

4.7.3 TEST INSTRUMENTS

Refer to section 4.2.2 to get information of above instrument.

4.7.4 TEST PROCEDURES

- a. Check the calibration of the measuring instrument using either an internal calibrator or a known signal from an external generator.
- b. Turn on the EUT and connect it to measurement instrument. Then set it to any one convenient frequency within its operating range. Set a reference level on the measuring instrument equal to the highest peak value.
- c. The center frequency of the spectrum analyzer is set to the fundamental frequency and using 3MHz RBW and 10 MHz VBW.
- d. Measure the captured power within the band and recording the plot.
- e. Repeat above procedures until all frequencies required were complete.

4.7.5 DEVIATION FROM TEST STANDARD

No deviation.

4.7.6 EUT OPERATING CONDITION

The software provided by client enabled the EUT to transmit and receive data at lowest, middle and highest channel frequencies individually.

4.7.7 TEST RESULTS

CHANNEL	FREQUENCY (MHz)	OUTPUT POWER (dBm)	OUTPUT POWER (mW)	POWER LIMIT (mW)	PASS / FAIL
0	2402	-2.2	0.6	125	PASS
39	2441	-2.2	0.6	125	PASS
78	2480	-2.8	0.5	125	PASS

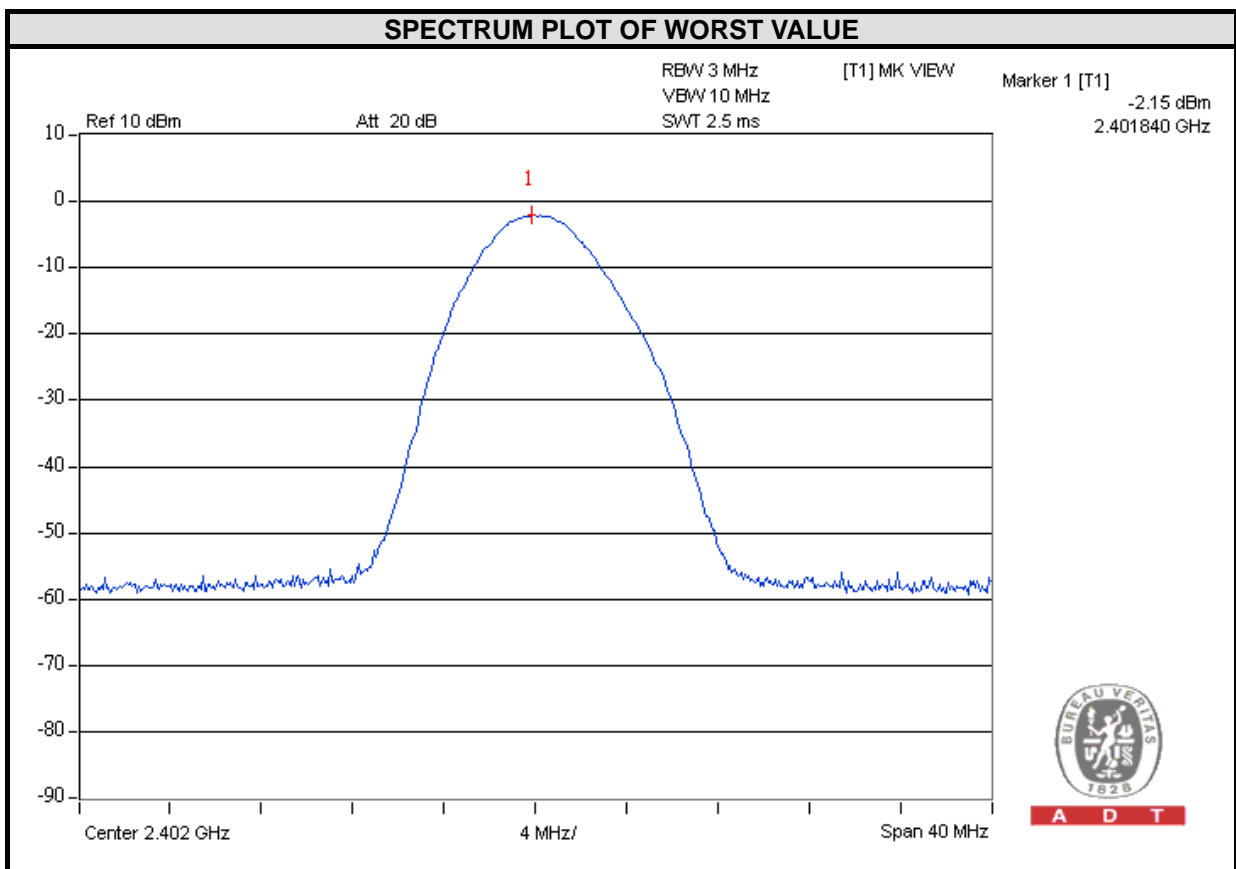

4.8 CONDUCTED OUT OF BAND EMISSION MEASUREMENT

4.8.1 LIMITS OF CONDUCTED OUT OF BAND EMISSION MEASUREMENT

Below -20dB of the highest emission level of operating band (in 100KHz RBW).

4.8.2 TEST INSTRUMENTS

Refer to section 4.2.2 to get information of above instrument.

4.8.3 TEST PROCEDURE

The transmitter output was connected to the spectrum analyzer via a low loss cable. Set both RBW and VBW of spectrum analyzer to 100 kHz & 300 kHz with suitable frequency span including 100 MHz bandwidth from band edge. The band edges was measured and recorded.

4.8.4 DEVIATION FROM TEST STANDARD

No deviation.

4.8.5 EUT OPERATING CONDITION

The software provided by client enabled the EUT to transmit and receive data at lowest, middle and highest channel frequencies individually.

4.8.6 TEST RESULTS

The spectrum plots are attached on the following images. D1 line indicates the highest level, D2 line indicates the 20dB offset below D1. It shows compliance with the requirement.



A D T

Hopping disabled_ Low Channel

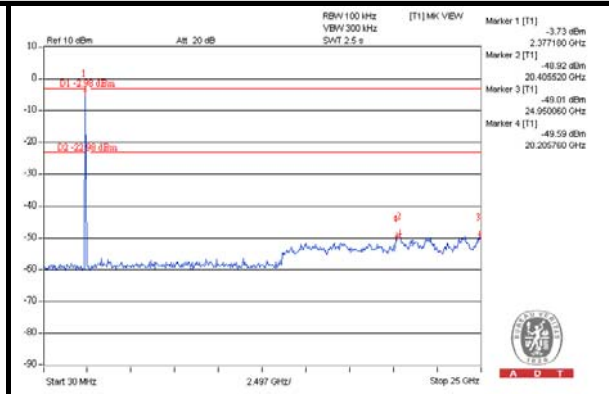
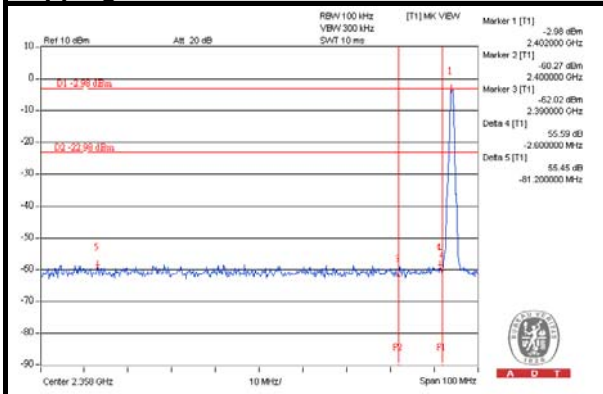

Hopping disabled_ High Channel

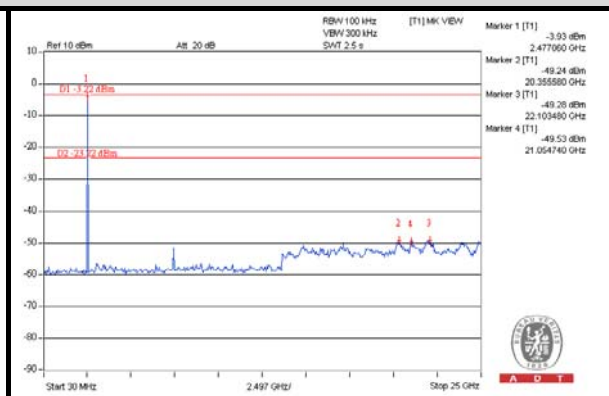
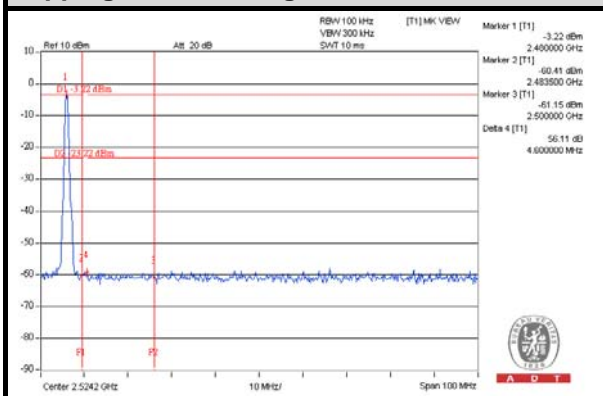

Hopping enabled_ Low Channel

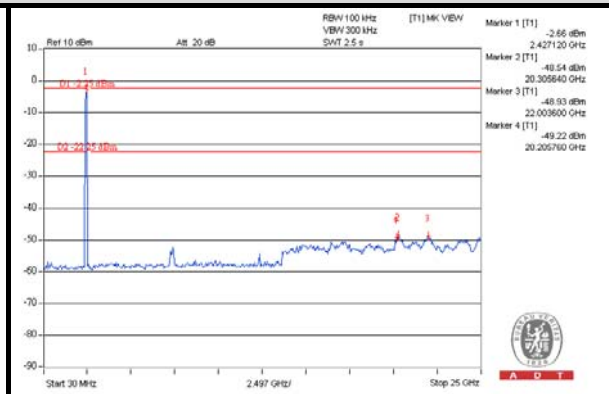
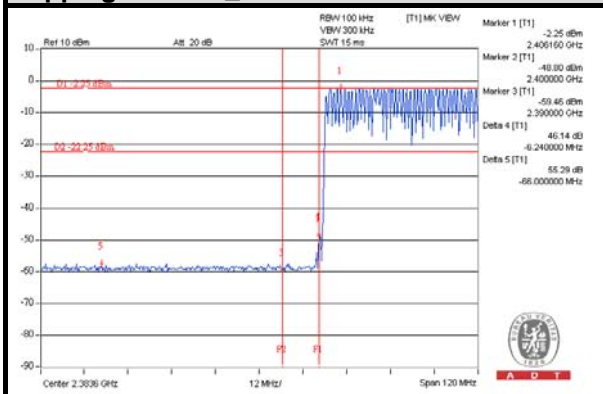

Hopping enabled_ High Channel

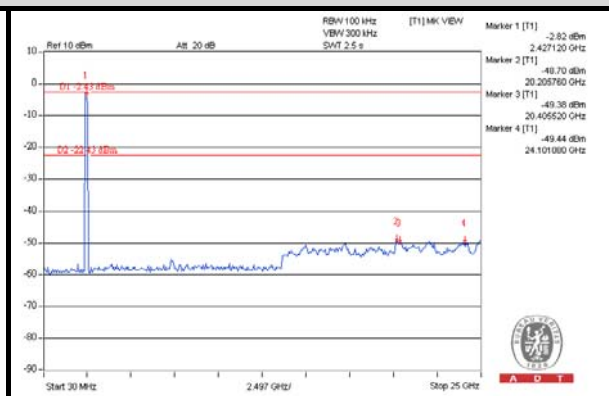
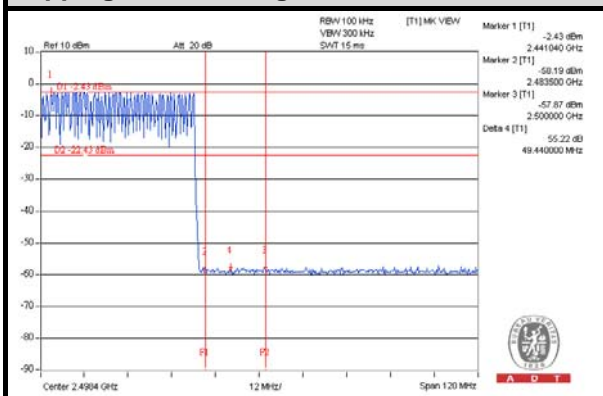

5. PHOTOGRAPHS OF THE TEST CONFIGURATION

Please refer to the attached file (Test Setup Photo).



6. INFORMATION ON THE TESTING LABORATORIES

We, Bureau Veritas Consumer Products Services (H.K.) Ltd., Taoyuan Branch, were founded in 1988 to provide our best service in EMC, Radio, Telecom and Safety consultation. Our laboratories are accredited and approved according to ISO/IEC 17025.

If you have any comments, please feel free to contact us at the following:

Linko EMC/RF Lab:

Tel: 886-2-26052180

Fax: 886-2-26051924

Hsin Chu EMC/RF Lab:

Tel: 886-3-5935343

Fax: 886-3-5935342

Hwa Ya EMC/RF/Safety Telecom Lab:

Tel: 886-3-3183232

Fax: 886-3-3270892

Email: service.adt@tw.bureauveritas.com

Web Site: www.bureauveritas-adt.com

The address and road map of all our labs can be found in our web site also.



7. APPENDIX A - MODIFICATIONS RECORDERS FOR ENGINEERING CHANGES TO THE EUT BY THE LAB

No modifications were made to the EUT by the lab during the test.

--- END ---