

FCC RADIO TEST REPORT

Report Reference No. : NTEK-2011NT09071103E

Compiled by (+ signature) : Jim He



Approved by (+ signature) : Bovey Yang

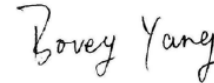

Applicant's name : Kensington Computer Products Group

Address : 333 Twin Dolphin Drive, Redwood shore, CA

Manufacture's Name : Dongguan Togran Electronics Co.,Ltd

Address : 262 Shidan Rd., 3rd Industrial Area, Juzhou, Shijie, Dongguan, Guangdong

Test specification:

Standard : FCC Part15.249, RSS-210 Issue 8

Test procedure : ANSI C63.4-2003, RSS-Gen Issue 3

Test item description

Product name : Pro Fit™ Wireless Media Keyboard

FCC ID : GV3 M01140-K

IC : 6128A- M01140K

Trademark :  Kensington®

Model and/or type reference : M01140-K

Rating(s) : DC 3V

Testing Laboratory information:

Testing Laboratory Name : NTEK Testing Technology Co., Ltd

Address : 1/F, Building E, Fenda Science Park, Sanwei Community, Xixiang Street, Bao ' an District, Shenzhen P.R. China.

This device described above has been tested by NTEK Testing Technology Co., Ltd, and the test results show that the equipment under test (EUT) is in compliance with the FCC requirements. And it is applicable only to the tested sample identified in the report.

This report shall not be reproduced except in full, without the written approval of NTEK Testing Technology Co., Ltd, this document may be altered or revised by NTEK Testing Technology Co., Ltd, personal only, and shall be noted in the revision of the documen

Testing

Date of receipt of test item : 01 Sep. 2011

Date (s) of performance of tests : 01 Sep. 2011 ~06 Sep. 2011

Date of Issue..... : 06 Sep. 2011

Test Result..... : **Pass**

Table of Contents	Page
1 . SUMMARY OF TEST RESULTS	3
1.1 MEASUREMENT UNCERTAINTY	4
2 . GENERAL INFORMATION	5
2.1 GENERAL DESCRIPTION OF EUT	5
2.2 DESCRIPTION OF TEST MODES	7
2.3 BLOCK DIGRAM SHOWING THE CONFIGURATION OF SYSTEM TESTED	8
2.4 DESCRIPTION OF SUPPORT UNITS(CONDUCTED MODE)	9
3 . TEST RESULT	11
3.1 ANTENNA REQUIREMENT	11
3.1.1 STANDARD REQUIREMENT	11
3.1.2 EUT ANTENNA	11
3.2 COND UCTED EMISSION MEASUREMENT	12
3.2.1 POWER LINE CONDUCTED EMISSION LIMITS	12
3.2.2 TEST PROCEDURE	13
3.2.3 DEVIATION FROM TEST STANDARD	13
3.2.4 TEST SETUP	13
3.2.5 TEST RESULT	13
3.3 RADIATED EMISSION MEASUREMENT	14
3.3.1 RADIATED EMISSION LIMITS	14
3.3.2 TEST PROCEDURE	15
3.3.3 DEVIATION FROM TEST STANDARD	15
3.3.4 TEST SETUP	16
3.3.5 TEST RESULTS (BLOW 30MHZ)	17
3.3.6 TEST RESULTS (BETWEEN 30 – 1000 MHZ)	17
3.3.7 TEST RESULTS (ABOVE 1000 MHZ)	21
4 . BANDWIDTH TEST	27
4.1 TEST PROCEDURE	27
4.2 DEVIATION FROM STANDARD	27
4.3 TEST SETUP	27
4.4 TEST RESULTS	28
5 . EUT TEST PHOTO	30

1. SUMMARY OF TEST RESULTS

Test procedures according to the technical standards:

FCC Part15, Subpart C (15.249) & RSS-Gen Issue 3 & RSS-210 Issue 8			
Standard Section	Test Item	Judgment	Remark
15.207	Conducted Emission	N/A	Note(1)
15.203	Antenna Requirement	Pass	
15.249	Radiated Spurious Emission	Pass	
15.249	Occupied Bandwidth	Pass	

NOTE:

(1) " N/A" denotes test is not applicable in this Test Report.

1.1 MEASUREMENT UNCERTAINTY

The reported uncertainty of measurement $y \pm U$, where expanded uncertainty U is based on a standard uncertainty multiplied by a coverage factor of $k=2$, providing a level of confidence of approximately **95 %**.

No.	Item	Uncertainty
1	Conducted Emission Test	$\pm 1.38\text{dB}$
2	Radiated Emission Test	$\pm 3.17\text{dB}$
3	RF power,conducted	$\pm 0.16\text{dB}$
4	Spurious emissions,conducted	$\pm 0.21\text{dB}$
5	All emissions,radiated(<1G)	$\pm 4.68\text{dB}$
6	All emissions,radiated(>1G)	$\pm 4.89\text{dB}$

2. GENERAL INFORMATION

2.1 GENERAL DESCRIPTION OF EUT

Equipment	Pro Fit™ Wireless Media Keyboard	
Trade Name	 Kensington	
Model Name	M01140-K	
OEM Brand/Model Name	N/A	
Model Difference	N/A	
Product Description	The EUT is a Pro Fit™ Wireless Media Keyboard	
	Operation Frequency:	2403~2478 MHz
	Modulation Type:	GFSK
	Antenna Designation:	Printed ANT
	Antenna Gain(Peak)	1.5 dBi
Channel List	Please refer to the Note 2.	
Power Source	DC Voltage supplied from 2* lithium size Battery	
Power Rating	DC 3V	
Connecting I/O Port(s)	Please refer to the User's Manual	
Products Covered	N/A	
EUT Modification(s)	N/A	

Note:

1. For a more detailed features description, please refer to the manufacturer's specifications or the User's Manual.

2.

Channel List							
Channel	Frequency (MHz)	Channel	Frequency (MHz)	Channel	Frequency (MHz)	Channel	Frequency (MHz)
01	2403	20	2478				
02	2407						
03	...						
04	...						
05	...						

3.

Table for Filed Antenna

Ant	Brand	Model Name	Antenna Type	Connector	Gain (dBi)	NOTE
1	N/A	N/A	Printed Antenna	NA	1.5	Antenna

2.2 DESCRIPTION OF TEST MODES

To investigate the maximum EMI emission characteristics generates from EUT, the test system was pre-scanning tested base on the consideration of following EUT operation mode or test configuration mode which possible have effect on EMI emission level. Each of these EUT operation mode(s) or test configuration mode(s) mentioned above was evaluated respectively.

Pretest Mode	Description
Mode 1	Low CH
Mode 2	Mid CH
Mode 3	High CH

For Conducted Emission	
Final Test Mode	Description
-	"N/A" denotes test is not applicable in this Test Report

For Radiated Emission	
Final Test Mode	Description
Mode 1	Low CH
Mode 2	Mid CH
Mode 3	High CH

Note:

- (1) The measurements are performed at the highest, middle, lowest available channels.
- (2) The EUT use new battery.

2.3 BLOCK DIGRAM SHOWING THE CONFIGURATION OF SYSTEM TESTED

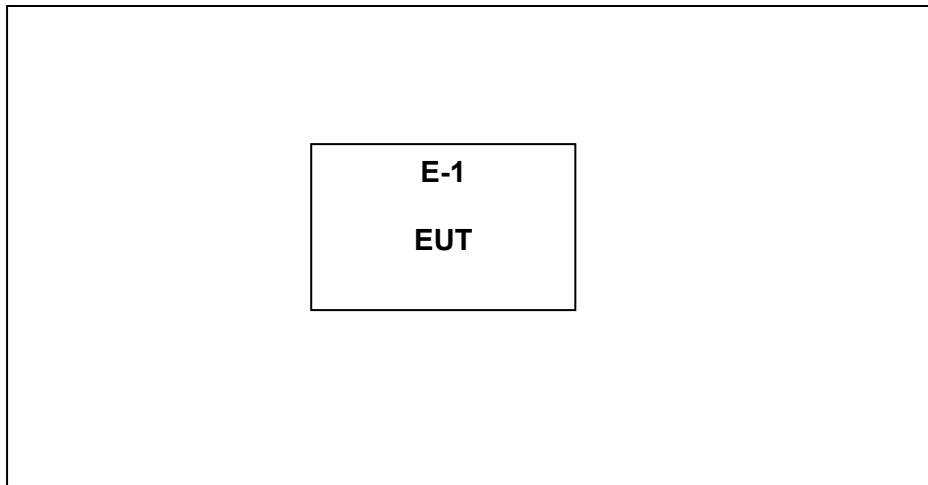

2.4 DESCRIPTION OF SUPPORT UNITS(CONDUCTED MODE)

The EUT has been tested as an independent unit together with other necessary accessories or support units. The following support units or accessories were used to form a representative test configuration during the tests.

Item	Equipment	Mfr/Brand	Model/Type No.	FCC ID	Series No.	Note
E-1	Pro Fit™ Wireless Media Keyboard	 Kensington®	M01140-K	GV3 M01140-K	N/A	EUT

Item	Shielded Type	Ferrite Core	Length	Note

Note:

- (1) The support equipment was authorized by Declaration of Confirmation.
- (2) For detachable type I/O cable should be specified the length in cm in 『Length』 column.

2.4.1 EQUIPMENTS LIST FOR ALL TEST ITEMS

Radiation Test Equipment:					
No	Test Equipment	Manufacturer	Model No	Serial No	Cal. Due Date dd-mm-yy
1	Spectrum Analyzer	Agilent	E4407B	160400005	2012-4-24
2	Test Receiver	R&S	ESPI7	101318	2012-4-24
3	Bilog Antenna	TESEQ	CBL6111D	31216	2012-4-24
4	50Ω Coaxial Switch	Anritsu	MP59B	620026441 6	2012-4-24
5	Spectrum Analyzer	ADVANTEST	R3182	150900201	2012-4-24
6	Low Noise Pre Amplifier	Tsj	MLA-0120-A02-34	2648A0473 8	2012-4-24
7	Broadband Horn Antenna	SCHWARZBEC K	BBHA9120D	451	2012-4-24
8	Loop Antenna	ARA	PLA-1030/B	1029	2012-3-19

Conduction Test equipment					
No	Test Equipment	Manufacturer	Model No	Serial No	Cal. Due Date dd-mm-yy
1**	Test Receiver	R&S	ESCI	101160	2012-4-24
2	LISN	R&S	ENV216	101313	2012-4-24
3	LISN	Kyoritsu	KNW-407	8-1789-3	2012-4-24
4**	50Ω Coaxial Switch	Anritsu	MP59B	620026441 7	2012-4-24
5	Passive Voltage Probe	R&S	ESH2-Z3	100196	2012-4-24
6	Absorbing clamp	R&S	MDS-21	100423	2012-4-24

3. TEST RESULT

3.1 ANTENNA REQUIREMENT

3.1.1 STANDARD REQUIREMENT

15.203 requirement: For intentional device, according to 15.203: an intentional radiator shall be designed to ensure that no antenna other than that furnished by the responsible party shall be used with the device.

3.1.2 EUT ANTENNA

The EUT antenna is integral Antenna. It comply with the standard requirement.

3.2 CONDUCTED EMISSION MEASUREMENT

3.2.1 POWER LINE CONDUCTED EMISSION Limits (Frequency Range 150KHz-30MHz)

FREQUENCY (MHz)	Class A (dBuV)		Class B (dBuV)		Standard
	Quasi-peak	Average	Quasi-peak	Average	
0.15 -0.5			66 - 56 *	56 - 46 *	CISPR
0.50 -5.0			56.00	46.00	CISPR
5.0 -30.0			60.00	50.00	CISPR

0.15 -0.5			66 - 56 *	56 - 46 *	LP002.
0.50 -5.0			56.00	46.00	LP002.
5.0 -30.0			60.00	50.00	LP002.

Note:

- (1) The tighter limit applies at the band edges.
- (2) The limit of " * " marked band means the limitation decreases linearly with the logarithm of the frequency in the range.

The following table is the setting of the receiver

Receiver Parameters	Setting
Attenuation	10 dB
Start Frequency	0.15 MHz
Stop Frequency	30 MHz
IF Bandwidth	9 kHz

3.2.2 TEST PROCEDURE

- a. The EUT was placed 0.4 meters from the horizontal ground plane with EUT being connected to the power mains through a line impedance stabilization network (LISN). All other support equipments powered from additional LISN(s). The LISN provide 50 Ohm/ 50uH of coupling impedance for the measuring instrument.
- b. Interconnecting cables that hang closer than 40 cm to the ground plane shall be folded back and forth in the center forming a bundle 30 to 40 cm long.
- c. I/O cables that are not connected to a peripheral shall be bundled in the center. The end of the cable may be terminated, if required, using the correct terminating impedance. The overall length shall not exceed 1 m.
- d. LISN at least 80 cm from nearest part of EUT chassis.
- e. For the actual test configuration, please refer to the related Item –EUT Test Photos.

3.2.3 DEVIATION FROM TEST STANDARD

No deviation

3.2.4 TEST SETUP

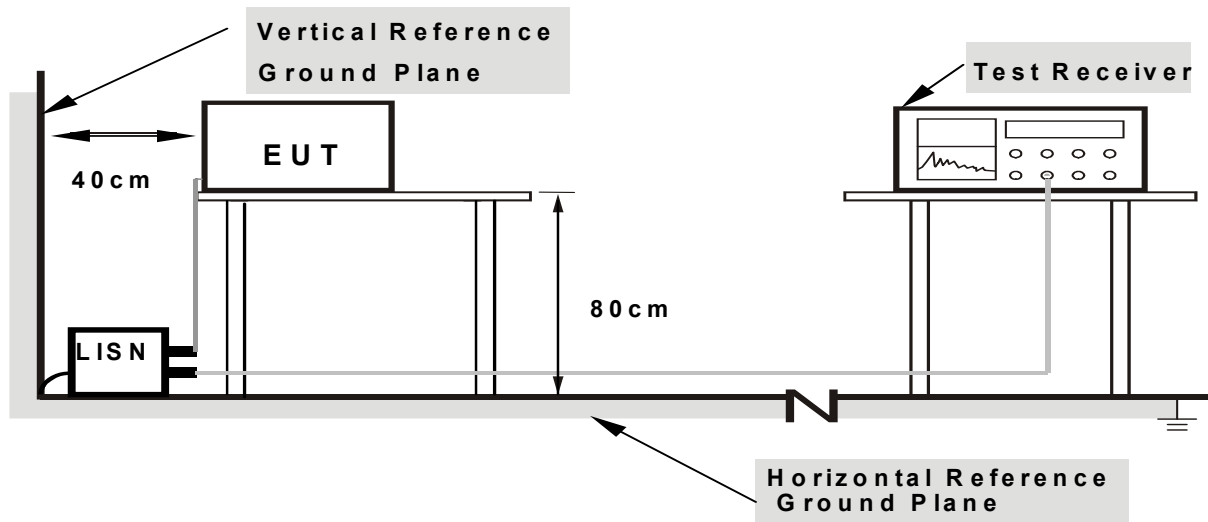

- Note:**
- 1. Support units were connected to second LISN.
 - 2. Both of LISNs (AMN) are 80 cm from EUT and at least 80 from other units and other metal planes

3.2.5 TEST RESULT

Cause the EUT only employ battery power for operation and which do not operate from the AC power lines or contain provisions for operation while connected to the AC power lines. Measurements to demonstrate compliance with the conducted limits are not required for devices

3.3 RADIATED EMISSION MEASUREMENT

3.3.1 Radiated Emission Limits (FCC 15.209)

Frequencies (MHz)	Field Strength (microrvolts/meter)	Measurement Distance (meters)
0.009~0.490	2400/F(KHz)	300
0.490~1.705	24000/F(KHz)	30
1.705~30.0	30	30
30~88	100	3
88~216	150	3
216~960	200	3
Above 960	500	3

Note:

- (1) The tighter limit applies at the band edges.
- (2) Emission level (dBuV/m)=20log Emission level (uV/m).

LIMITS OF RADIATED EMISSION MEASUREMENT (FCC 15.249)

Frequency of Emission (MHz)	Field Strength of fundamental ((millivolts /meter)	Field Strength of Harmonics (microvolts/meter)
2400 - 2483.5	50	500

Notes:

- (1) Emissions radiated outside of the specified frequency bands, except for harmonics, shall be attenuated by at least 50 dB below the level of the fundamental or to the general radiated emission limits in Section 15.209, whichever is the lesser attenuation.

Spectrum Parameter	Setting
Attenuation	Auto
Start Frequency	1000 MHz
Stop Frequency	10th carrier harmonic
RB / VB (emission in restricted band)	1MHz / 1MHz for Peak

Receiver Parameter	Setting
Attenuation	Auto
Start ~ Stop Frequency	9kHz~150kHz / RB 200Hz for QP
Start ~ Stop Frequency	150kHz~30MHz / RB 9kHz for QP
Start ~ Stop Frequency	30MHz~1000MHz / RB 120kHz for QP

3.3.2 TEST PROCEDURE

- a. The measuring distance of at 3 m shall be used for measurements at frequency up to 1GHz. For frequencies above 1GHz, any suitable measuring distance may be used.
- b. The EUT was placed on the top of a rotating table 0.8 meters above the ground at a 3m meter open area test site. The table was rotated 360 degrees to determine the position of the highest radiation.
- c. The height of the equipment or of the substitution antenna shall be 0.8 m; the height of the test antenna shall vary between 1 m to 4 m. Both horizontal and vertical polarizations of the antenna are set to make the measurement. performed pretest to three orthogonal axis.
- d. The initial step in collecting conducted emission data is a spectrum analyzer peak detector mode pre-scanning the measurement frequency range. Significant peaks are then marked and then Quasi Peak detector mode re-measured.
- e. If the Peak Mode measured value compliance with and lower than Quasi Peak Mode Limit, the EUT shall be deemed to meet QP Limits and then no additional QP Mode measurement performed.
- f. For the actual test configuration, please refer to the related Item –EUT Test Photos.

3.3.3 DEVIATION FROM TEST STANDARD

No deviation

3.3.4 TEST SETUP

(A) Radiated Emission Test Set-Up, Frequency Below 1000MHz

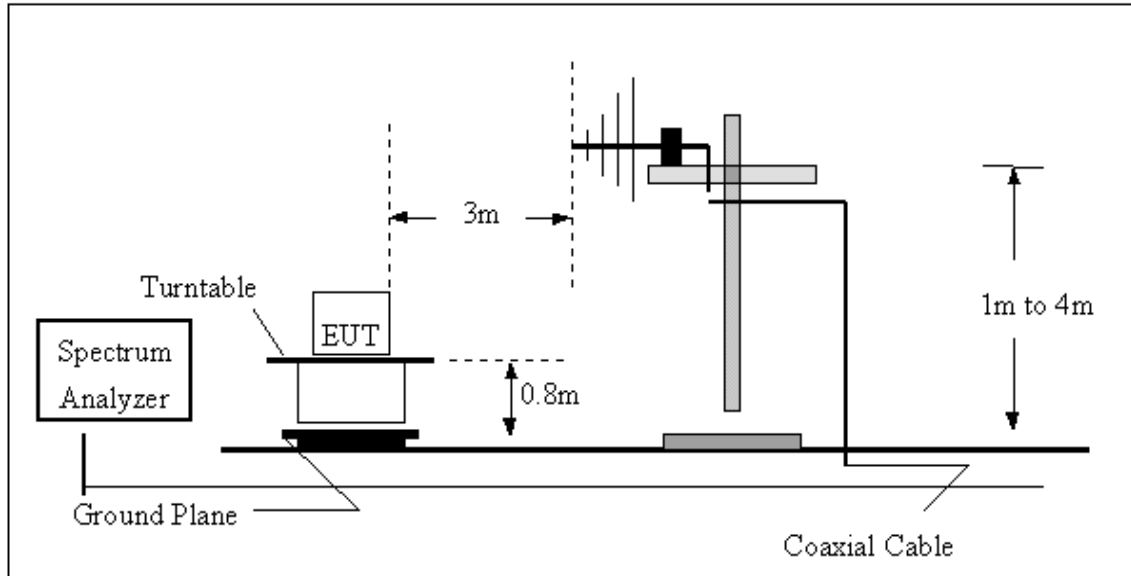

(B) Radiated Emission Test Set-Up Frequency Above 1 GHz

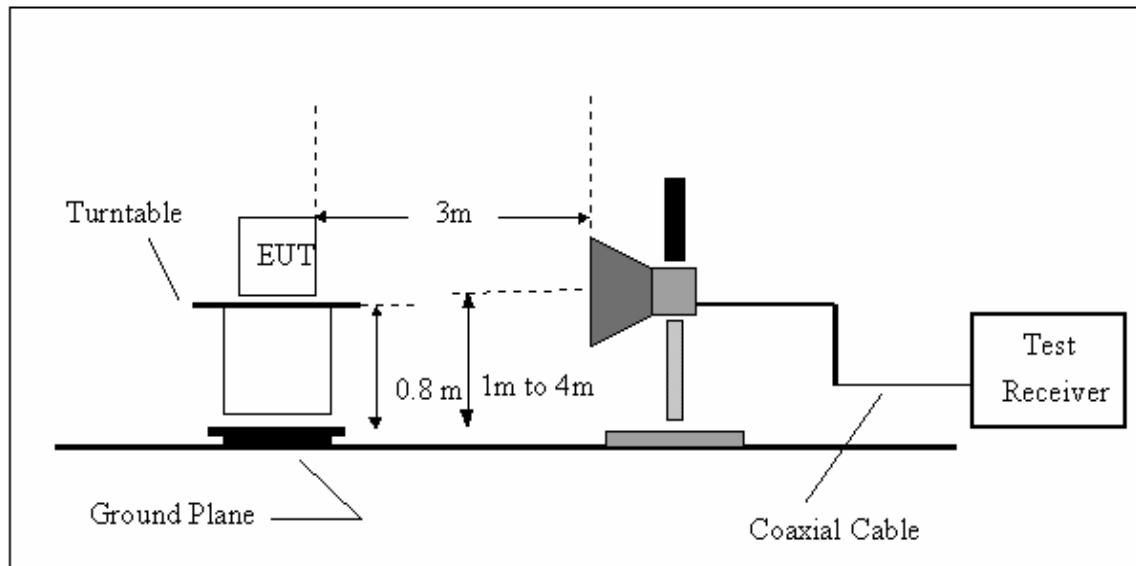

3.3.5 TEST RESULTS (BLOW 30MHz)

not detected blow 30MHz.

3.3.6 TEST RESULTS (BETWEEN 30 – 1000 MHz)

EUT :	Pro Fit™ Wireless Media Keyboard	Model Name :	M01140-K
Temperature :	24 °C	Relative Humidity :	54%
Pressure :	1010 hPa	Test Date :	2011-09-04
Test Mode :	RX	Polarization :	Horizontal
Test Power :	DC 3V		

Frequency (MHz)	Meter Reading (dBμV)	Factor (dB)	Emission Level (dBμV/m)	Limits (dBμV/m)	Margin (dB)	Detector Type
33.95	17.03	16.23	33.26	40	-6.74	QP
320.16	24.38	14.73	39.11	46	-6.89	QP
690.35	18.51	22.05	40.56	46	-5.44	QP

Remark:

1. Factor = Antenna Factor + Cable Loss – Pre-amplifier.

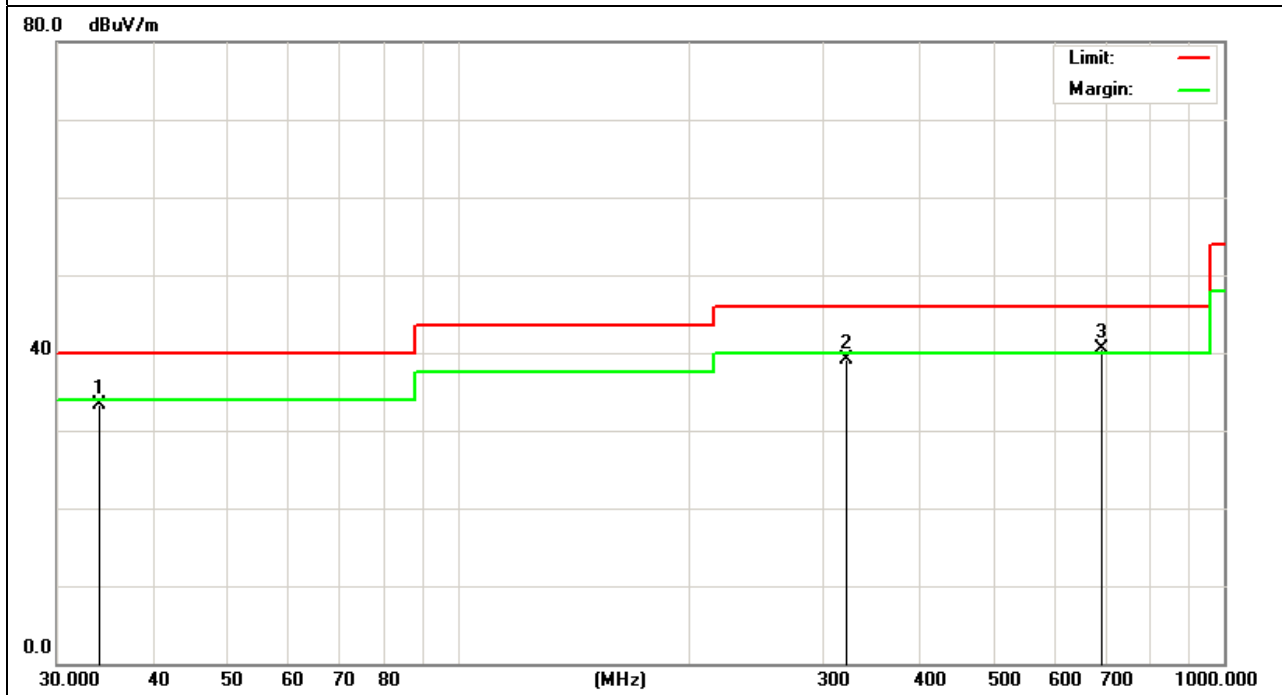

EUT :	Pro Fit™ Wireless Media Keyboard	Model Name :	M01140-K
Temperature :	24 °C	Relative Humidity :	54%
Pressure :	1010 hPa	Test Date :	2011-09-04
Test Mode :	RX	Polarization :	Vertical
Test Power :	DC 3V		

Frequency (MHz)	Meter Reading (dBμV)	Factor (dB)	Emission Level (dBμV/m)	Limits (dBμV/m)	Margin (dB)	Detector Type
35.69	14.91	15.35	30.26	40	-9.74	QP
400.95	19.94	17.24	37.18	46	-8.82	QP
700.63	15.01	22.1	37.11	46	-8.89	QP

Remark:

1. Factor = Antenna Factor + Cable Loss – Pre-amplifier.

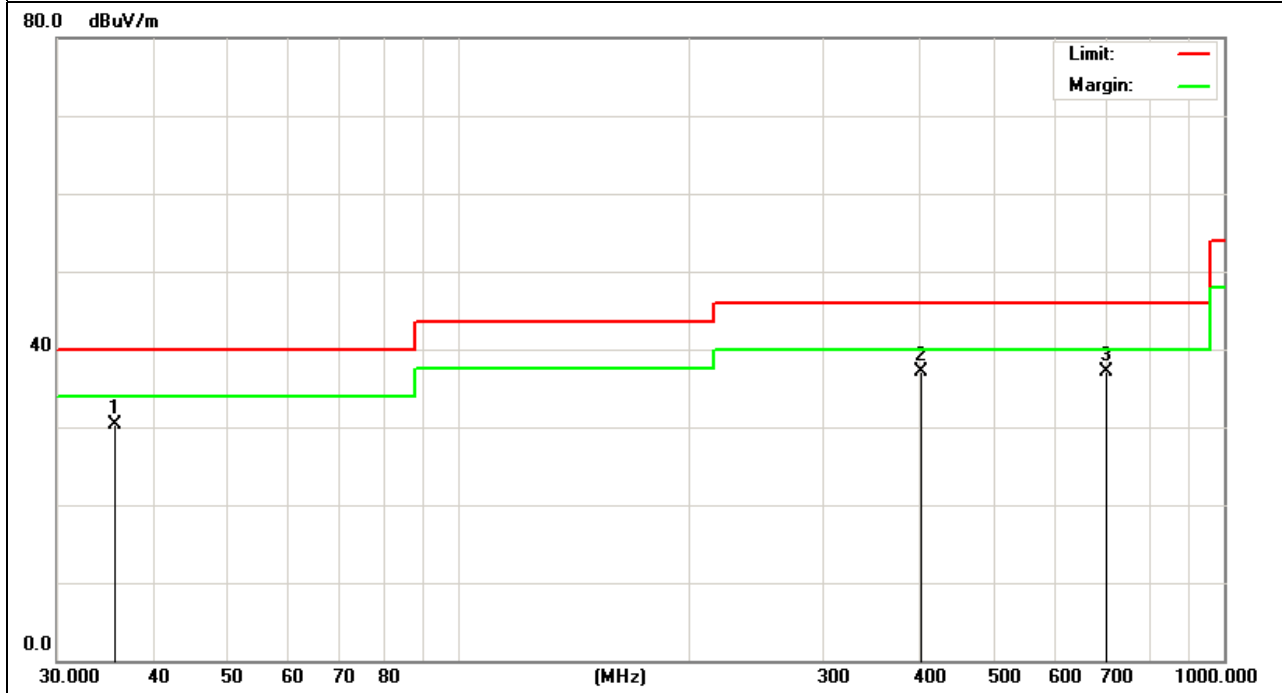

EUT :	Pro Fit™ Wireless Media Keyboard	Model Name :	M01140-K
Temperature :	24 °C	Relative Humidity :	54%
Pressure :	1010 hPa	Test Date :	2011-09-04
Test Mode :	TX	Polarization :	Horizontal
Test Power :	DC 3V		

Frequency (MHz)	Meter Reading (dBμV)	Factor (dB)	Emission Level (dBμV/m)	Limits (dBμV/m)	Margin (dB)	Detector Type
33.71	15.59	16.36	31.95	40	-8.05	QP
280.96	22.58	13.4	35.98	46	-10.02	QP
960.32	8.19	27.69	35.88	54	-18.12	QP

Remark:

1. Factor = Antenna Factor + Cable Loss – Pre-amplifier.

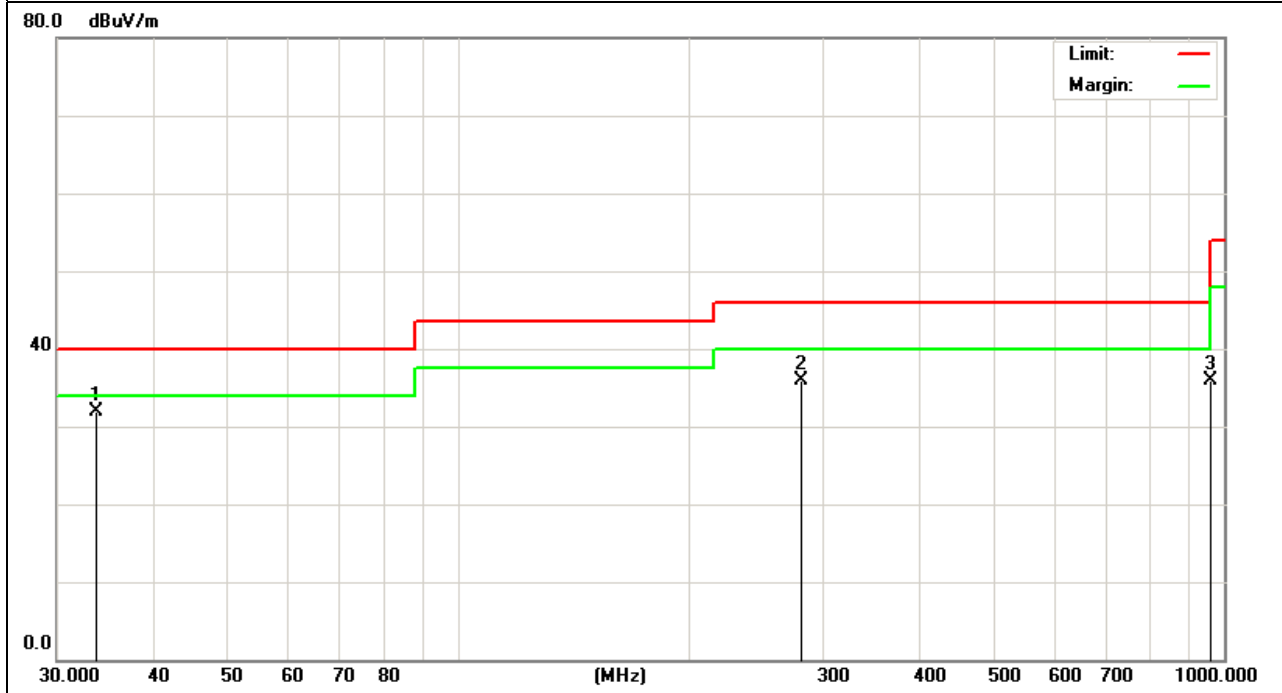

EUT :	Pro Fit™ Wireless Media Keyboard	Model Name :	M01140-K
Temperature :	24 °C	Relative Humidity :	54%
Pressure :	1010 hPa	Test Date :	2011-09-04
Test Mode :	TX	Polarization :	Vertical
Test Power :	DC 3V		

Frequency (MHz)	Meter Reading (dBµV)	Factor (dB)	Emission Level (dBµV/m)	Limits (dBµV/m)	Margin (dB)	Detector Type
65.48	25.8	5.38	31.18	40	-8.82	QP
410.3599	18.61	17.68	36.29	46	-9.71	QP
860.91	12.73	25.46	38.19	46	-7.81	QP

Remark:

- Factor = Antenna Factor + Cable Loss – Pre-amplifier.

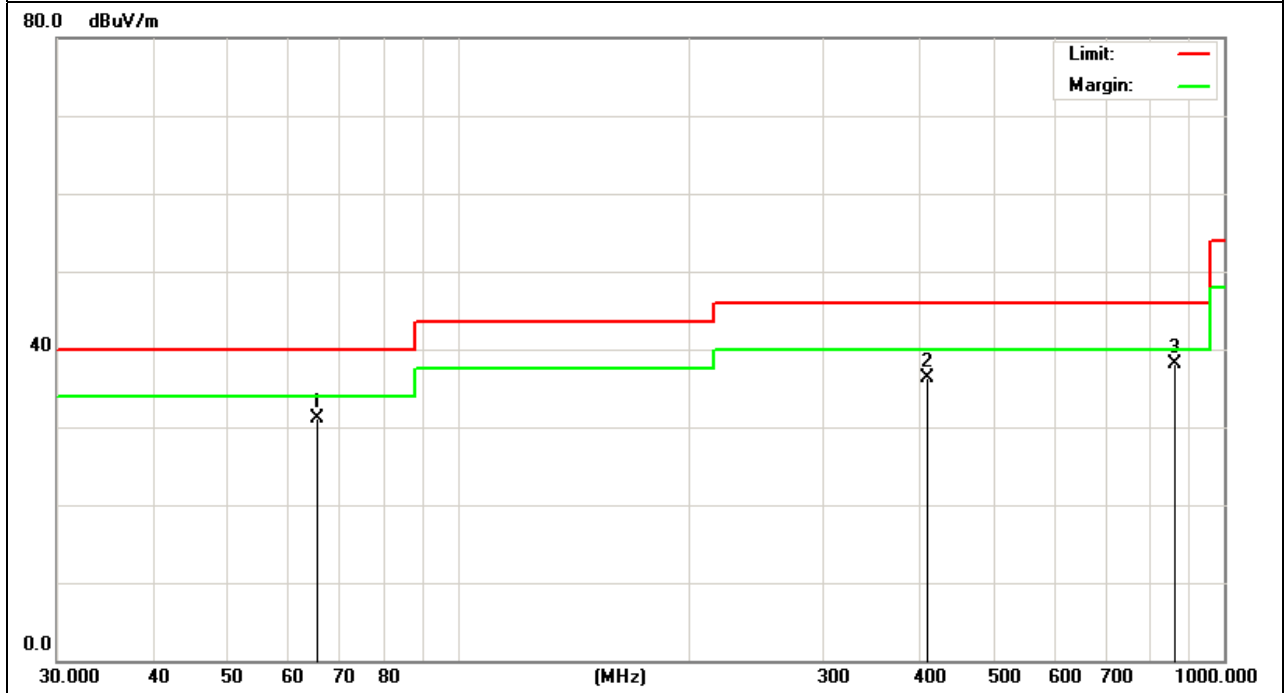

3.3.7 TEST RESULTS (ABOVE 1000 MHZ)

EUT :	Pro Fit™ Wireless Media Keyboard	Model Name :	M01140-K
Temperature :	24 °C	Relative Humidity :	54%
Pressure :	1010 hPa	Test Date :	2011-09-04
Test Mode :	TX 2403MHz	Polarization :	Horizontal
Test Power :	DC 3V		

Frequency (MHz)	Meter Reading (dBµV)	Factor (dB)	Emission Level (dBµV/m)	Limits (dBµV/m)	Margin (dB)	Detector Type
2400	61.09	-9.97	51.12	74	-22.88	peak
2400	58.12	-9.97	48.15	54	-5.85	AVG
2403.11	100.75	-9.97	90.78	114.00	-23.22	peak
2403.11	90.13	-9.97	80.16	94	-13.84	AVG
4806.22	54.72	2.54	57.26	74	-16.74	peak
4806.22	47.63	2.54	50.17	54	-3.83	AVG
7209.22	51.14	4.6	55.74	74	-18.26	peak
7209.22	43.66	4.6	48.26	54	-5.74	AVG

Remark:

- Factor = Antenna Factor + Cable Loss – Pre-amplifier.
- No emission detected above 18GHz.

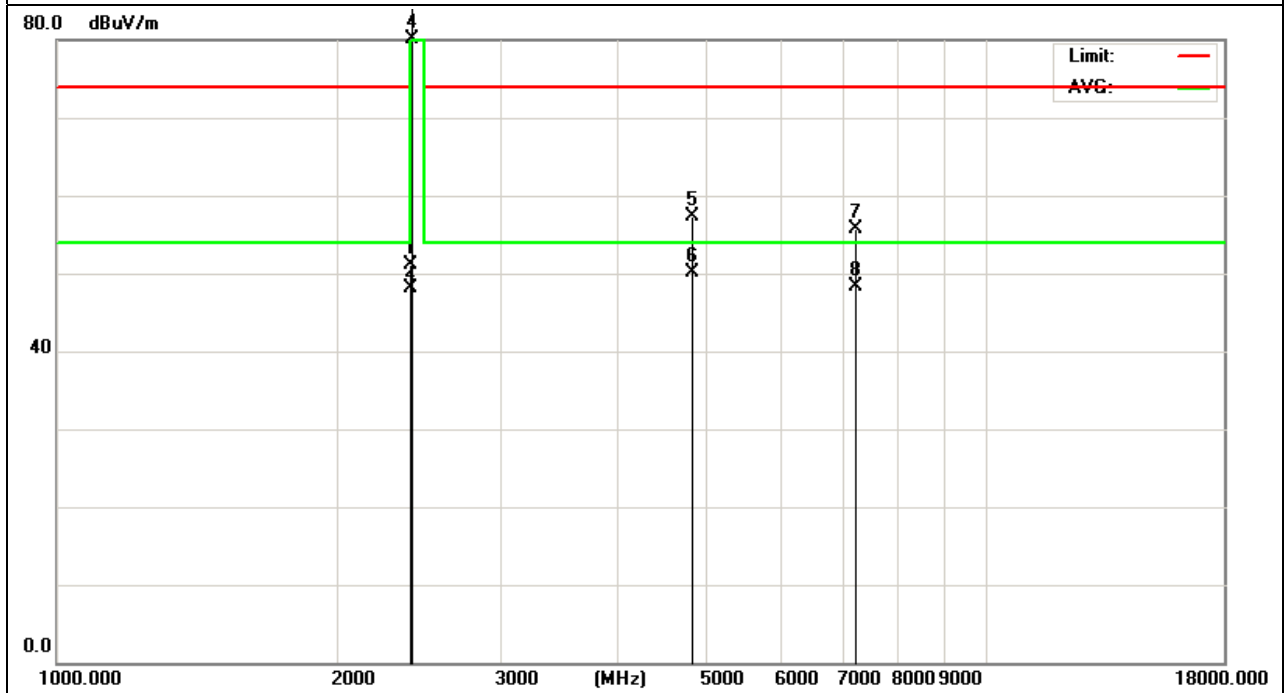

EUT :	Pro Fit™ Wireless Media Keyboard	Model Name :	M01140-K
Temperature :	24 °C	Relative Humidity :	54%
Pressure :	1010 hPa	Test Date :	2011-09-04
Test Mode :	TX 2403MHz	Polarization :	Vertical
Test Power :	DC 3V		

Frequency (MHz)	Meter Reading (dBμV)	Factor (dB)	Emission Level (dBμV/m)	Limits (dBμV/m)	Margin (dB)	Detector Type
2400	65.62	-9.97	55.65	74	-18.35	peak
2400	54.82	-9.97	44.85	54	-9.15	AVG
2403.11	101.81	-9.97	91.84	114.00	-22.16	peak
2403.11	94.59	-9.97	84.62	94	-9.38	AVG
4806.22	53.11	2.54	55.65	74	-18.35	peak
4806.22	47.09	2.54	49.63	54	-4.37	AVG
7209.22	51.96	4.6	56.56	74	-17.44	peak
7209.22	44.05	4.6	48.65	54	-5.35	AVG

Remark:

- Factor = Antenna Factor + Cable Loss – Pre-amplifier.
- No emission detected above 18GHz.

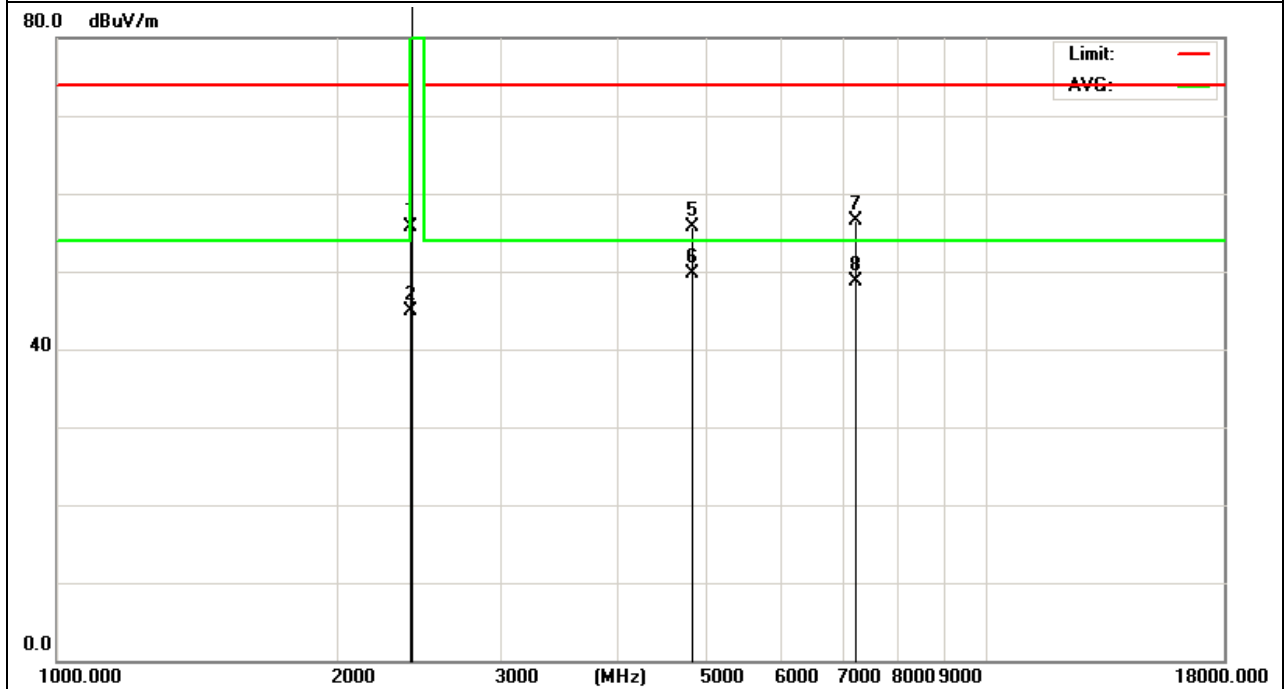

EUT :	Pro Fit™ Wireless Media Keyboard	Model Name :	M01140-K
Temperature :	24 °C	Relative Humidity :	54%
Pressure :	1010 hPa	Test Date :	2011-09-04
Test Mode :	TX 2453MHz	Polarization :	Horizontal
Test Power :	DC 3V		

Frequency (MHz)	Meter Reading (dBμV)	Factor (dB)	Emission Level (dBμV/m)	Limits (dBμV/m)	Margin (dB)	Detector Type
2453	98.74	-9.89	88.85	114.00	-25.15	peak
2453	89.55	-9.89	79.66	94	-14.34	AVG
4906	53.72	2.54	56.26	74	-17.74	peak
4906	47.41	2.54	49.95	54	-4.05	AVG
7335	46.88	4.96	51.84	74	-22.16	peak
7335	39.99	4.96	44.95	54	-9.05	AVG

Remark:

- Factor = Antenna Factor + Cable Loss – Pre-amplifier.
- No emission detected above 18GHz.

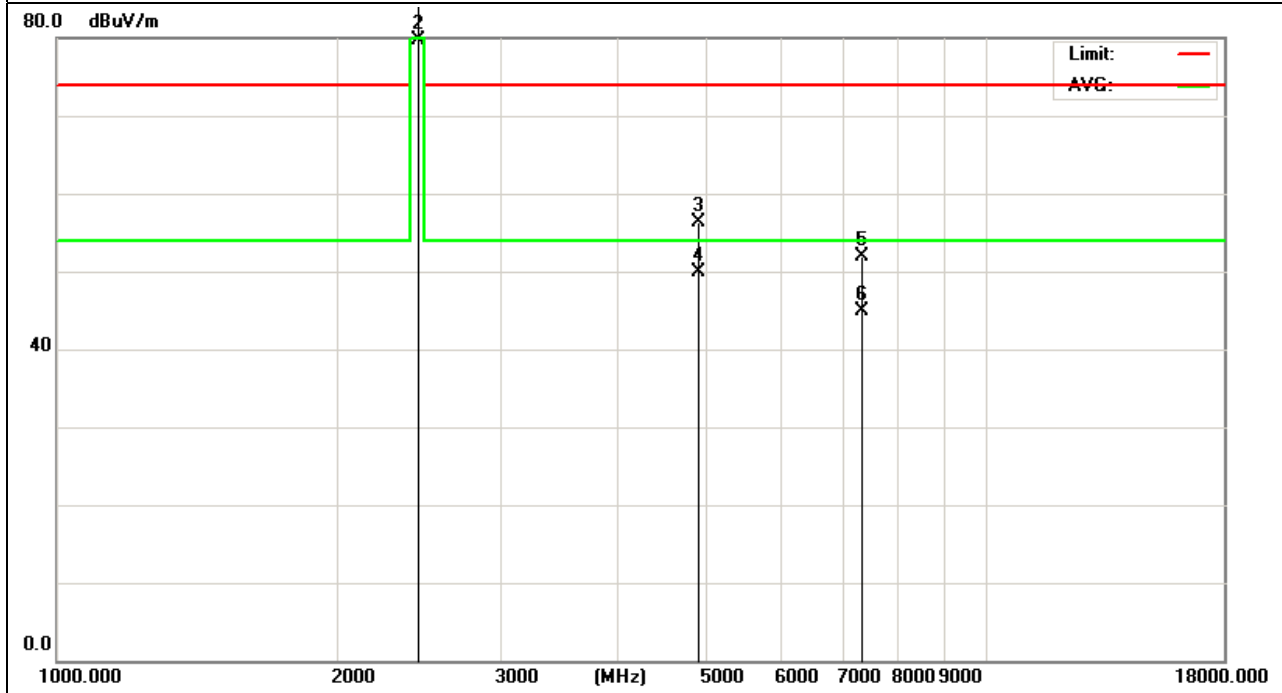

EUT :	Pro Fit™ Wireless Media Keyboard	Model Name :	M01140-K
Temperature :	24 °C	Relative Humidity :	54%
Pressure :	1010 hPa	Test Date :	2011-09-04
Test Mode :	TX 2453MHz	Polarization :	Vertical
Test Power :	DC 3V		

Frequency (MHz)	Meter Reading (dBµV)	Factor (dB)	Emission Level (dBµV/m)	Limits (dBµV/m)	Margin (dB)	Detector Type
2453	101.75	-9.89	91.86	114.0 0	-22.14	peak
2453	92.68	-9.89	82.79	94	-11.21	AVG
4906	56.4	2.54	58.94	74	-15.06	peak
4906	46.62	2.54	49.16	54	-4.84	AVG
7335	51.23	4.96	56.19	74	-17.81	peak
7335	44.2	4.96	49.16	54	-4.84	AVG

Remark:

- Factor = Antenna Factor + Cable Loss – Pre-amplifier.
- No emission detected above 18GHz.

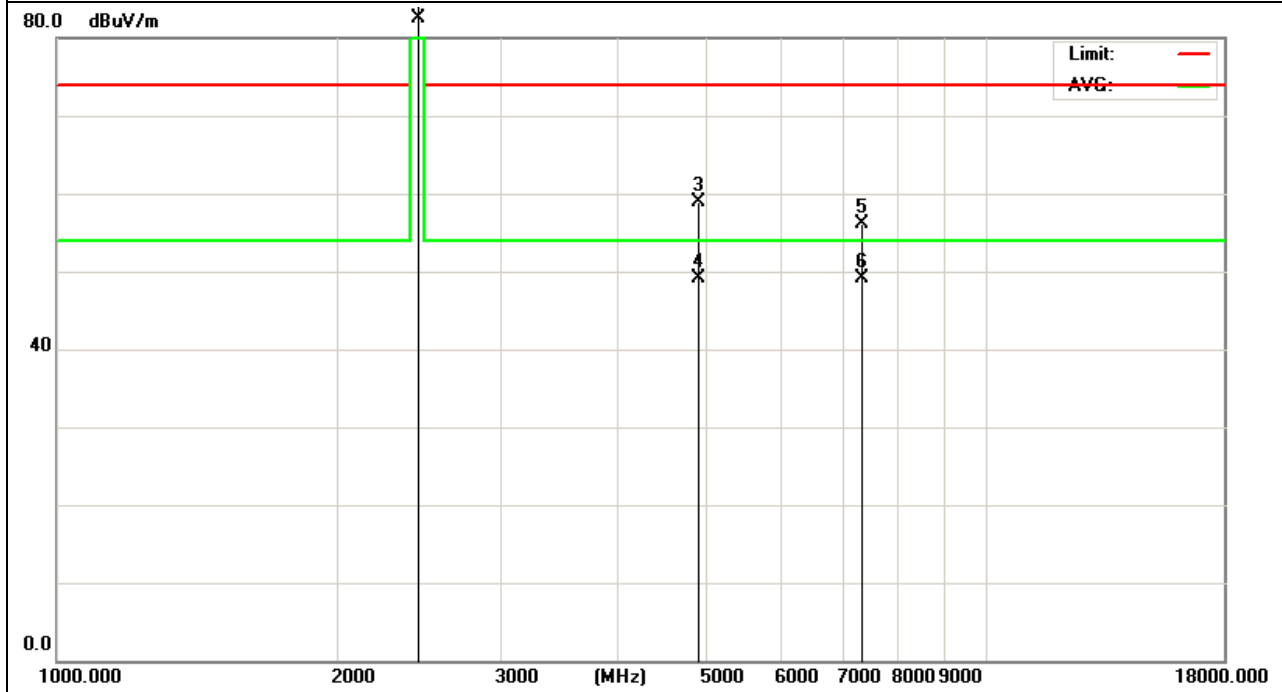

EUT :	Pro Fit™ Wireless Media Keyboard	Model Name :	M01140-K
Temperature :	24 °C	Relative Humidity :	54%
Pressure :	1010 hPa	Test Date :	2011-09-04
Test Mode :	TX 2478MHz	Polarization :	Horizontal
Test Power :	DC 3V		

Frequency (MHz)	Meter Reading (dBμV)	Factor (dB)	Emission Level (dBμV/m)	Limits (dBμV/m)	Margin (dB)	Detector Type
2478	101.61	-9.77	91.84	114.0 0	-22.16	peak
2478	90.51	-9.77	80.74	94	-13.26	AVG
2483.5	64.37	-9.75	54.62	74	-19.38	peak
2483.5	50.49	-9.75	40.74	54	-13.26	AVG
4956	49.85	2.76	52.61	74	-21.39	peak
4956	43.98	2.76	46.74	54	-7.26	AVG
7434	51.96	5.2	57.16	74	-16.84	peak
7434	37.41	5.2	42.61	54	-11.39	AVG

Remark:

- Factor = Antenna Factor + Cable Loss – Pre-amplifier.
- No emission detected above 18GHz.

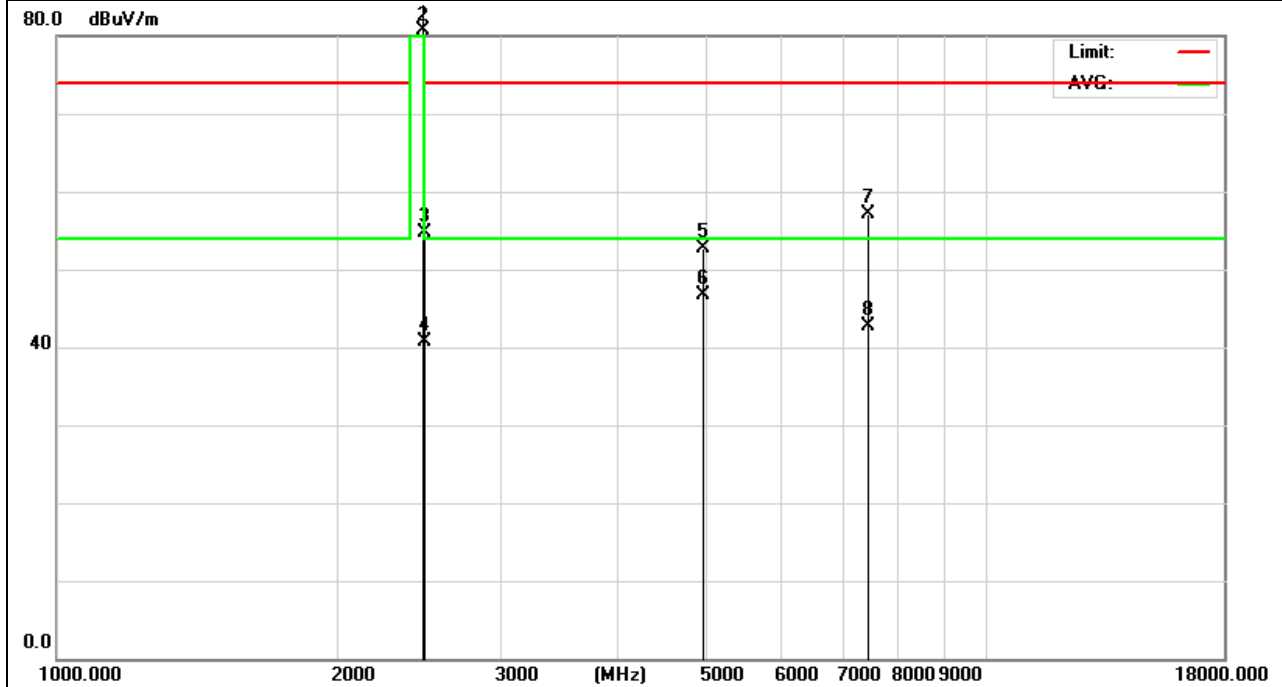

EUT :	Pro Fit™ Wireless Media Keyboard	Model Name :	M01140-K
Temperature :	24 °C	Relative Humidity :	54%
Pressure :	1010 hPa	Test Date :	2011-09-04
Test Mode :	TX 2478MHz	Polarization :	Vertical
Test Power :	DC 3V		

Frequency (MHz)	Meter Reading (dBµV)	Factor (dB)	Emission Level (dBµV/m)	Limits (dBµV/m)	Margin (dB)	Detector Type
2478	102.39	-9.77	92.62	114.00	-21.38	peak
2478	90.95	-9.77	81.18	94	-12.82	AVG
2483.5	63.73	-9.75	53.98	74	-20.02	peak
2483.5	51.01	-9.75	41.26	54	-12.74	AVG
4956	51.02	2.76	53.78	74	-20.22	peak
4956	41.86	2.76	44.62	54	-9.38	AVG
7434	46.49	5.2	51.69	74	-22.31	peak
7434	36.75	5.2	41.95	54	-12.05	AVG

Remark:

- Factor = Antenna Factor + Cable Loss – Pre-amplifier.
- No emission detected above 18GHz.

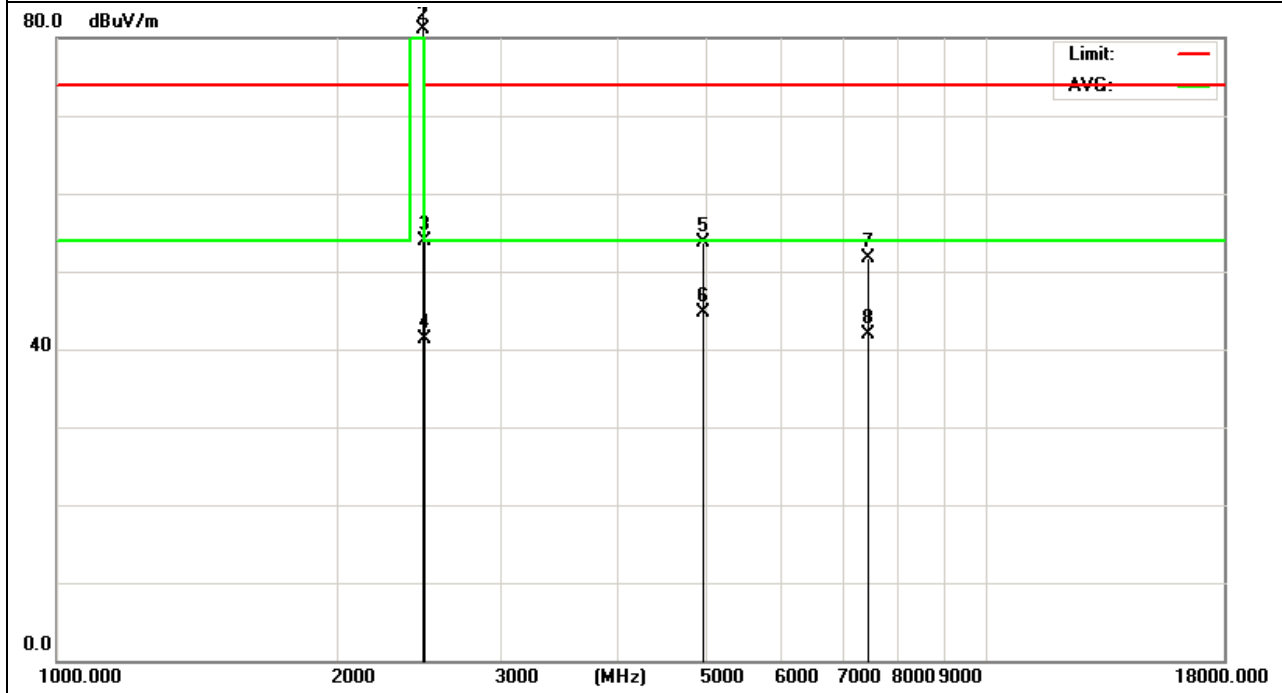

4. BANDWIDTH TEST

4.1 TEST PROCEDURE

- a. The EUT was directly connected to the spectrum analyzer and antenna output port as show in the block diagram below,
- b. Spectrum Setting : RBW= 100KHz, VBW \geq RBW, Sweep time = Auto.

4.2 DEVIATION FROM STANDARD

No deviation.

4.3 TEST SETUP

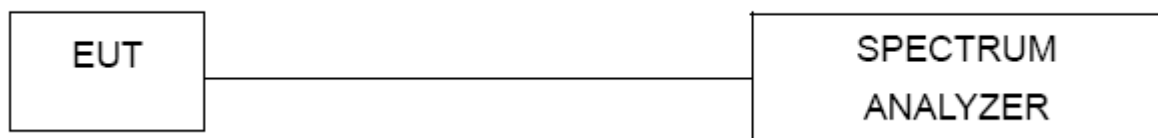

4.4 TEST RESULTS

EUT :	Pro Fit™ Wireless Media Keyboard	Model Name :	M01140-K
Temperature :	26 °C	Relative Humidity :	53%
Pressure :	1020 hPa	Test Power :	DC 3V
Test Mode :	TX		

Test Channel	Frequency (MHz)	20 dBc Bandwidth (kHz)	99% Bandwidth (kHz)
CH01	2403	434.80	427.20
CH011	2453	400.17	395.62
CH05	2478	413.51	446.83

The Lowest Channel:2403MHz

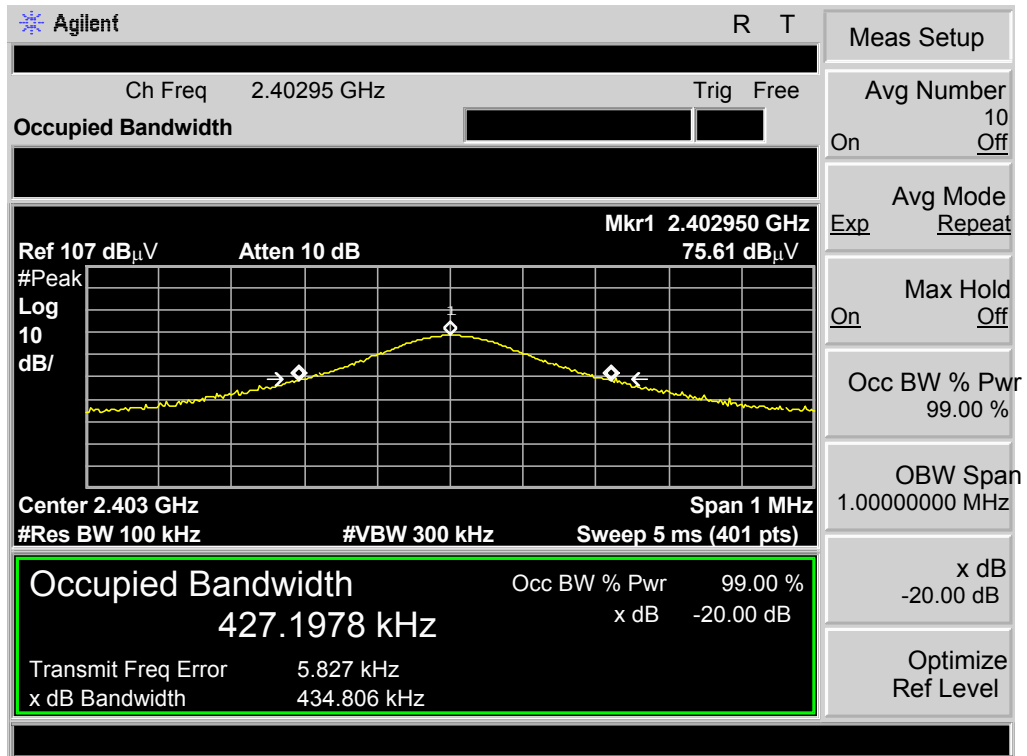

The Middle Channel:2453MHz

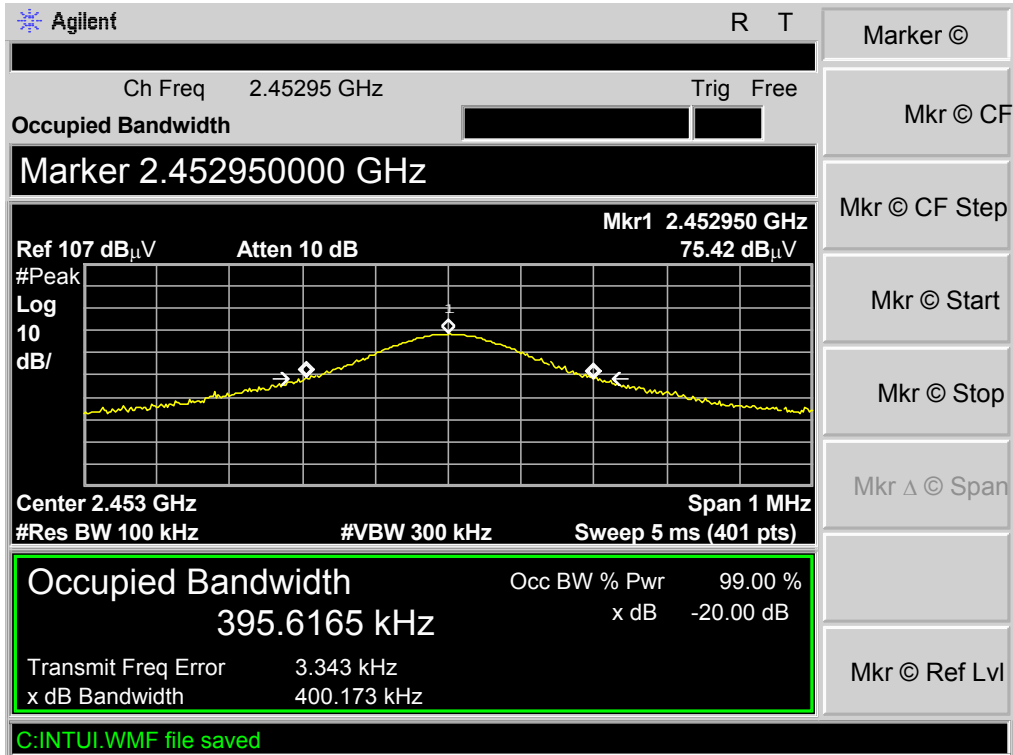

The High Channel:2478MHz

