

FCC RADIO TEST REPORT

Report Reference No. : NTEK-2011NT0622557E

Compiled by (+ signature) : Jim He



Approved by (+ signature) : Bovey Yang

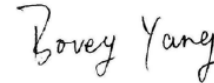

Applicant's name : Kensington Computer Products Group

Address : 333 Twin Dolphin Drive, Redwood shore, CA

Manufacture's Name : Dongguan Togran Electronics Co.,Ltd

Address : 262 Shidan Rd., 3rd Industrial Area, Juzhou, Shijie, Dongguan, Guangdong

Test specification:

Standard : FCC Part15.249, RSS-210 Issue 8

Test procedure : ANSI C63.4-2003, RSS-Gen Issue 3

Test item description

Product name : Pro Fit™ Wireless Mid-Size Mouse

FCC ID : GV3 M01137-M

IC : 6128A- M01137M

Trademark :  Kensington®

Model and/or type reference : M01137-M

Rating(s) : DC 3V

Testing Laboratory information:

Testing Laboratory Name : NTEK Testing Technology Co., Ltd

Address : 1/F, Building E, Fenda Science Park, Sanwei Community, Xixiang Street, Bao ' an District, Shenzhen P.R. China.

This device described above has been tested by NTEK Testing Technology Co., Ltd, and the test results show that the equipment under test (EUT) is in compliance with the FCC requirements. And it is applicable only to the tested sample identified in the report.

This report shall not be reproduced except in full, without the written approval of NTEK Testing Technology Co., Ltd, this document may be altered or revised by NTEK Testing Technology Co., Ltd, personal only, and shall be noted in the revision of the documen

Testing

Date of receipt of test item : 17 June. 2011

Date (s) of performance of tests : 18 June. 2011 ~25 June. 2011

Date of Issue..... : 25 June. 2011

Test Result..... : **Pass**

Table of Contents	Page
1 . SUMMARY OF TEST RESULTS	3
1.1 MEASUREMENT UNCERTAINTY	4
2 . GENERAL INFORMATION	5
2.1 GENERAL DESCRIPTION OF EUT	5
2.2 DESCRIPTION OF TEST MODES	7
2.3 BLOCK DIGRAM SHOWING THE CONFIGURATION OF SYSTEM TESTED	8
2.4 DESCRIPTION OF SUPPORT UNITS(CONDUCTED MODE)	9
3 . TEST RESULT	11
3.1 ANTENNA REQUIREMENT	11
3.1.1 STANDARD REQUIREMENT	11
3.1.2 EUT ANTENNA	11
3.2 CONDUCTED EMISSION MEASUREMENT	12
3.2.1 POWER LINE CONDUCTED EMISSION LIMITS	12
3.2.2 TEST PROCEDURE	13
3.2.3 DEVIATION FROM TEST STANDARD	13
3.2.4 TEST SETUP	13
3.2.5 TEST RESULT	13
3.3 RADIATED EMISSION MEASUREMENT	14
3.3.1 RADIATED EMISSION LIMITS	14
3.3.2 TEST PROCEDURE	15
3.3.3 DEVIATION FROM TEST STANDARD	15
3.3.4 TEST SETUP	16
3.3.5 TEST RESULTS (BLOW 30MHZ)	17
3.3.6 TEST RESULTS (BETWEEN 30 – 1000 MHZ)	17
3.3.7 TEST RESULTS (ABOVE 1000 MHZ)	21
4 . BANDWIDTH TEST	27
4.1 TEST PROCEDURE	27
4.2 DEVIATION FROM STANDARD	27
4.3 TEST SETUP	27
4.4 TEST RESULTS	28
5 . EUT TEST PHOTO	32
6 . APPENDIX-Photographs of EUT Constructional Details	

1. SUMMARY OF TEST RESULTS

Test procedures according to the technical standards:

FCC Part15, Subpart C (15.249) & RSS-Gen Issue 3 & RSS-210 Issue 8			
Standard Section	Test Item	Judgment	Remark
15.207	Conducted Emission	N/A	Note(1)
15.203	Antenna Requirement	Pass	
15.249	Radiated Spurious Emission	Pass	
15.249	Occupied Bandwidth	Pass	

NOTE:

(1) "N/A" denotes test is not applicable in this Test Report.

1.1 MEASUREMENT UNCERTAINTY

The reported uncertainty of measurement $y \pm U$, where expanded uncertainty U is based on a standard uncertainty multiplied by a coverage factor of $k=2$, providing a level of confidence of approximately 95 %.

No.	Item	Uncertainty
1	Conducted Emission Test	$\pm 1.38\text{dB}$
2	Radiated Emission Test	$\pm 3.17\text{dB}$
3	RF power,conducted	$\pm 0.16\text{dB}$
4	Spurious emissions,conducted	$\pm 0.21\text{dB}$
5	All emissions,radiated(<1G)	$\pm 4.68\text{dB}$
6	All emissions,radiated(>1G)	$\pm 4.89\text{dB}$

2. GENERAL INFORMATION

2.1 GENERAL DESCRIPTION OF EUT

Equipment	Pro Fit™ Wireless Mid-Size Mouse	
Trade Name	 Kensington	
Model Name	M01137-M	
OEM Brand/Model Name	N/A	
Model Difference	N/A	
Product Description	The EUT is a Pro Fit™ Wireless Mid-Size Mouse	
	Operation Frequency:	2403~2478 MHz
	Modulation Type:	GFSK
	Antenna Designation:	Printed ANT
	Antenna Gain(Peak)	1.0 dBi
Channel List	Please refer to the Note 2.	
Power Source	DC Voltage supplied from 2* lithium size Battery	
Power Rating	DC 3V	
Connecting I/O Port(s)	Please refer to the User's Manual	
Products Covered	N/A	
EUT Modification(s)	N/A	

Note:

1. For a more detailed features description, please refer to the manufacturer's specifications or the User's Manual.

2.

Channel List							
Channel	Frequency (MHz)	Channel	Frequency (MHz)	Channel	Frequency (MHz)	Channel	Frequency (MHz)
01	2403	06	2474	11	2445	16	2456
02	2404	07	2475	12	2436	17	2466
03	2405	08	2476	13	2413	18	2464
04	2406	09	2453	14	2424	19	2465
05	2478	10	2444	15	2415	20	2416

3.

Table for Filed Antenna

Ant	Brand	Model Name	Antenna Type	Connector	Gain (dBi)	NOTE
1	N/A	N/A	Printed Antenna	NA	1.0	Antenna

2.2 DESCRIPTION OF TEST MODES

To investigate the maximum EMI emission characteristics generates from EUT, the test system was pre-scanning tested base on the consideration of following EUT operation mode or test configuration mode which possible have effect on EMI emission level. Each of these EUT operation mode(s) or test configuration mode(s) mentioned above was evaluated respectively.

Pretest Mode	Description
Mode 1	CH1
Mode 2	CH11
Mode 3	CH5

For Conducted Emission	
Final Test Mode	Description
-	"N/A" denotes test is not applicable in this Test Report

For Radiated Emission	
Final Test Mode	Description
Mode 1	CH1
Mode 2	CH11
Mode 3	CH5

Note:

- (1) The measurements are performed at the highest, middle, lowest available channels.
- (2) The EUT use new battery.

2.3 BLOCK DIGRAM SHOWING THE CONFIGURATION OF SYSTEM TESTED

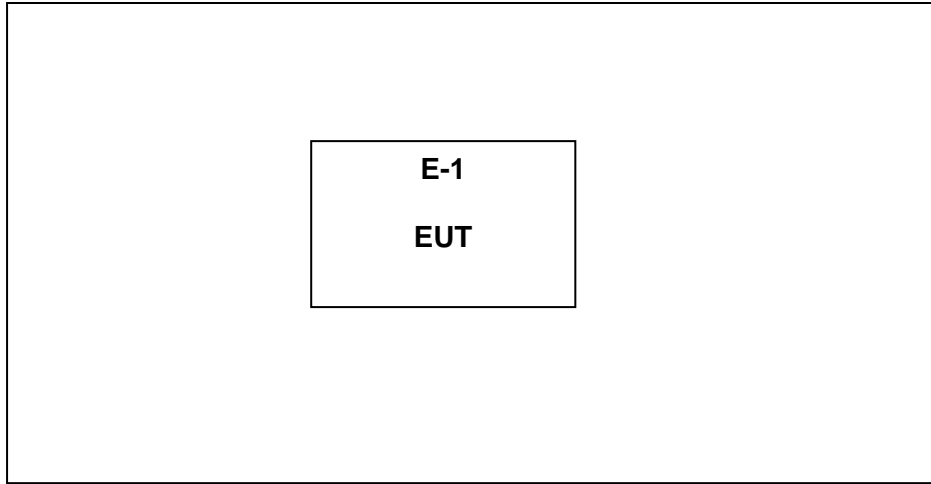

2.4 DESCRIPTION OF SUPPORT UNITS(CONDUCTED MODE)

The EUT has been tested as an independent unit together with other necessary accessories or support units. The following support units or accessories were used to form a representative test configuration during the tests.

Item	Equipment	Mfr/Brand	Model/Type No.	FCC ID	Series No.	Note
E-1	Pro Fit™ Wireless Mid-Size Mouse	 Kensington®	M01137-M	GV3 M01137-M	N/A	EUT

Item	Shielded Type	Ferrite Core	Length	Note

Note:

- (1) The support equipment was authorized by Declaration of Confirmation.
- (2) For detachable type I/O cable should be specified the length in cm in 『Length』 column.

2.4.1 EQUIPMENTS LIST FOR ALL TEST ITEMS

Radiation Test Equipment:					
No	Test Equipment	Manufacturer	Model No	Serial No	Cal. Due Date dd-mm-yy
1	Spectrum Analyzer	Agilent	E4407B	160400005	2012-4-24
2	Test Receiver	R&S	ESPI7	101318	2012-4-24
3	Bilog Antenna	TESEQ	CBL6111D	31216	2012-4-24
4	50Ω Coaxial Switch	Anritsu	MP59B	620026441 6	2012-4-24
5	Spectrum Analyzer	ADVANTEST	R3182	150900201	2012-4-24
6	Low Noise Pre Amplifier	Tsj	MLA-0120-A02-34	2648A0473 8	2012-4-24
7	Broadband Horn Antenna	SCHWARZBEC K	BBHA9120D	451	2012-4-24
8	Loop Antenna	ARA	PLA-1030/B	1029	2012-3-19

Conduction Test equipment					
No	Test Equipment	Manufacturer	Model No	Serial No	Cal. Due Date dd-mm-yy
1**	Test Receiver	R&S	ESCI	101160	2012-4-24
2	LISN	R&S	ENV216	101313	2012-4-24
3	LISN	Kyoritsu	KNW-407	8-1789-3	2012-4-24
4**	50Ω Coaxial Switch	Anritsu	MP59B	620026441 7	2012-4-24
5	Passive Voltage Probe	R&S	ESH2-Z3	100196	2012-4-24
6	Absorbing clamp	R&S	MDS-21	100423	2012-4-24

3. TEST RESULT

3.1 ANTENNA REQUIREMENT

3.1.1 STANDARD REQUIREMENT

15.203 requirement: For intentional device, according to 15.203: an intentional radiator shall be designed to ensure that no antenna other than that furnished by the responsible party shall be used with the device.

3.1.2 EUT ANTENNA

The EUT antenna is integral Antenna. It comply with the standard requirement.

3.2 CONDUCTED EMISSION MEASUREMENT

3.2.1 POWER LINE CONDUCTED EMISSION Limits (Frequency Range 150KHz-30MHz)

FREQUENCY (MHz)	Class A (dBuV)		Class B (dBuV)		Standard
	Quasi-peak	Average	Quasi-peak	Average	
0.15 -0.5			66 - 56 *	56 - 46 *	CISPR
0.50 -5.0			56.00	46.00	CISPR
5.0 -30.0			60.00	50.00	CISPR

0.15 -0.5			66 - 56 *	56 - 46 *	LP002.
0.50 -5.0			56.00	46.00	LP002.
5.0 -30.0			60.00	50.00	LP002.

Note:

- (1) The tighter limit applies at the band edges.
- (2) The limit of " * " marked band means the limitation decreases linearly with the logarithm of the frequency in the range.

The following table is the setting of the receiver

Receiver Parameters	Setting
Attenuation	10 dB
Start Frequency	0.15 MHz
Stop Frequency	30 MHz
IF Bandwidth	9 kHz

3.2.2 TEST PROCEDURE

- a. The EUT was placed 0.4 meters from the horizontal ground plane with EUT being connected to the power mains through a line impedance stabilization network (LISN). All other support equipments powered from additional LISN(s). The LISN provide 50 Ohm/ 50uH of coupling impedance for the measuring instrument.
- b. Interconnecting cables that hang closer than 40 cm to the ground plane shall be folded back and forth in the center forming a bundle 30 to 40 cm long.
- c. I/O cables that are not connected to a peripheral shall be bundled in the center. The end of the cable may be terminated, if required, using the correct terminating impedance. The overall length shall not exceed 1 m.
- d. LISN at least 80 cm from nearest part of EUT chassis.
- e. For the actual test configuration, please refer to the related Item –EUT Test Photos.

3.2.3 DEVIATION FROM TEST STANDARD

No deviation

3.2.4 TEST SETUP

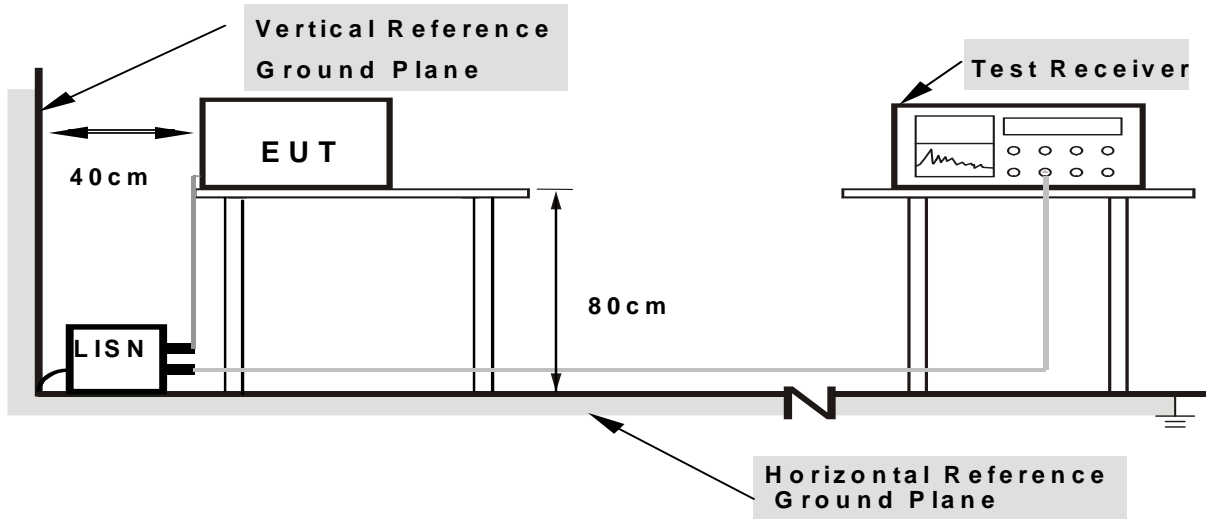

- Note: 1. Support units were connected to second LISN.**
2. Both of LISNs (AMN) are 80 cm from EUT and at least 80 cm from other units and other metal planes

3.2.5 TEST RESULT

Cause the EUT only employ battery power for operation and which do not operate from the AC power lines or contain provisions for operation while connected to the AC power lines. Measurements to demonstrate compliance with the conducted limits are not required for devices

3.3 RADIATED EMISSION MEASUREMENT

3.3.1 Radiated Emission Limits (FCC 15.209)

Frequencies (MHz)	Field Strength (microrvolts/meter)	Measurement Distance (meters)
0.009~0.490	2400/F(KHz)	300
0.490~1.705	24000/F(KHz)	30
1.705~30.0	30	30
30~88	100	3
88~216	150	3
216~960	200	3
Above 960	500	3

Note:

- (1) The tighter limit applies at the band edges.
- (2) Emission level (dBuV/m)=20log Emission level (uV/m).

LIMITS OF RADIATED EMISSION MEASUREMENT (FCC 15.249)

Frequency of Emission (MHz)	Field Strength of fundamental ((millivolts /meter)	Field Strength of Harmonics (microvolts/meter)
2400 - 2483.5	50	500

Notes:

- (1) Emissions radiated outside of the specified frequency bands, except for harmonics, shall be attenuated by at least 50 dB below the level of the fundamental or to the general radiated emission limits in Section 15.209, whichever is the lesser attenuation.

Spectrum Parameter	Setting
Attenuation	Auto
Start Frequency	1000 MHz
Stop Frequency	10th carrier harmonic
RB / VB (emission in restricted band)	1MHz / 1MHz for Peak

Receiver Parameter	Setting
Attenuation	Auto
Start ~ Stop Frequency	9kHz~150kHz / RB 200Hz for QP
Start ~ Stop Frequency	150kHz~30MHz / RB 9kHz for QP
Start ~ Stop Frequency	30MHz~1000MHz / RB 120kHz for QP

3.3.2 TEST PROCEDURE

- a. The measuring distance of at 3 m shall be used for measurements at frequency up to 1GHz. For frequencies above 1GHz, any suitable measuring distance may be used.
- b. The EUT was placed on the top of a rotating table 0.8 meters above the ground at a 3m meter open area test site. The table was rotated 360 degrees to determine the position of the highest radiation.
- c. The height of the equipment or of the substitution antenna shall be 0.8 m; the height of the test antenna shall vary between 1 m to 4 m. Both horizontal and vertical polarizations of the antenna are set to make the measurement. performed pretest to three orthogonal axis.
- d. The initial step in collecting conducted emission data is a spectrum analyzer peak detector mode pre-scanning the measurement frequency range. Significant peaks are then marked and then Quasi Peak detector mode re-measured.
- e. If the Peak Mode measured value compliance with and lower than Quasi Peak Mode Limit, the EUT shall be deemed to meet QP Limits and then no additional QP Mode measurement performed.
- f. For the actual test configuration, please refer to the related Item –EUT Test Photos.

3.3.3 DEVIATION FROM TEST STANDARD

No deviation

3.3.4 TEST SETUP

(A) Radiated Emission Test Set-Up, Frequency Below 1000MHz

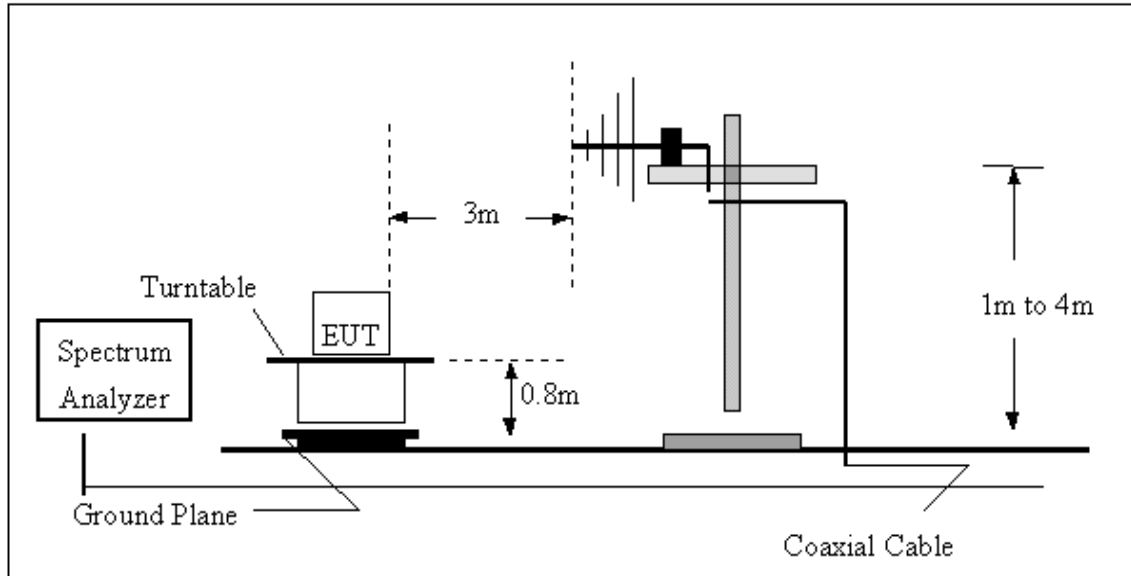

(B) Radiated Emission Test Set-Up Frequency Above 1 GHz

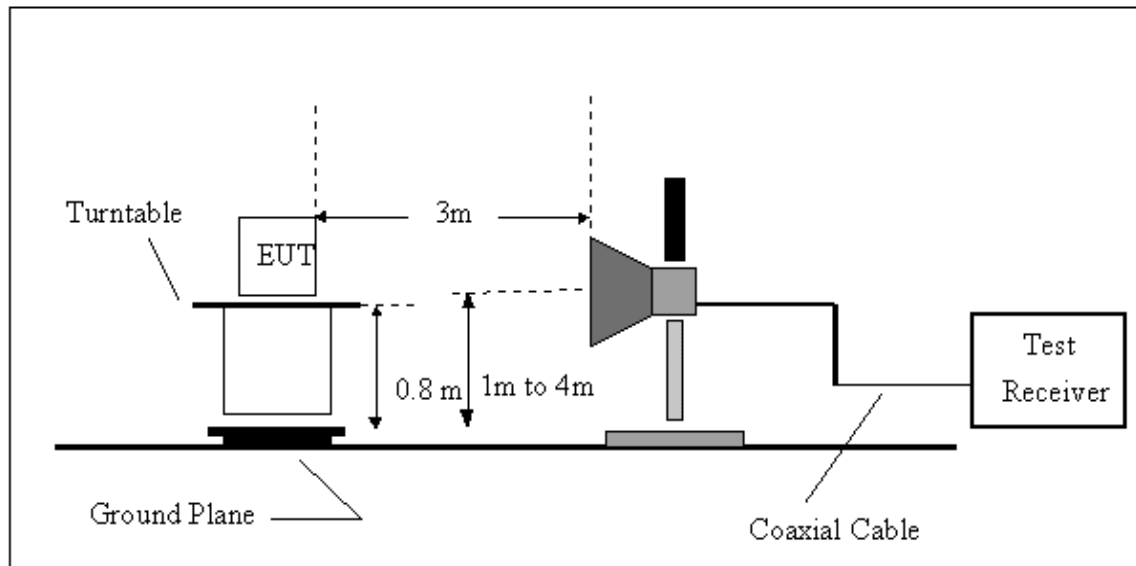

3.3.5 TEST RESULTS (BLOW 30MHz)

not detected blow 30MHz.

3.3.6 TEST RESULTS (BETWEEN 30 – 1000 MHZ)

EUT :	Pro Fit™ Wireless Mid-Size Mouse	Model Name :	M01137-M
Temperature :	24 °C	Relative Humidity :	54%
Pressure :	1010 hPa	Test Date :	2011-6-18
Test Mode :	RX	Polarization :	Horizontal
Test Power :	DC 3V		

Frequency (MHz)	Meter Reading (dBμV)	Factor (dB)	Emission Level (dBμV/m)	Limits (dBμV/m)	Margin (dB)	Detector Type
105.45	38.09	-14.71	23.38	40.00	-16.62	Quasi-Peak
147.25	35.42	-11.15	24.27	40.00	-15.73	Quasi-Peak
300.57	33.94	-10.24	23.70	47.00	-23.30	Quasi-Peak
364.26	31.95	-8.45	23.50	47.00	-23.50	Quasi-Peak
660.57	21.81	-1.61	20.20	47.00	-26.80	Quasi-Peak
957.53	30.81	2.47	33.28	47.00	-13.72	Quasi-Peak

Remark:

1. Factor = Antenna Factor + Cable Loss – Pre-amplifier.

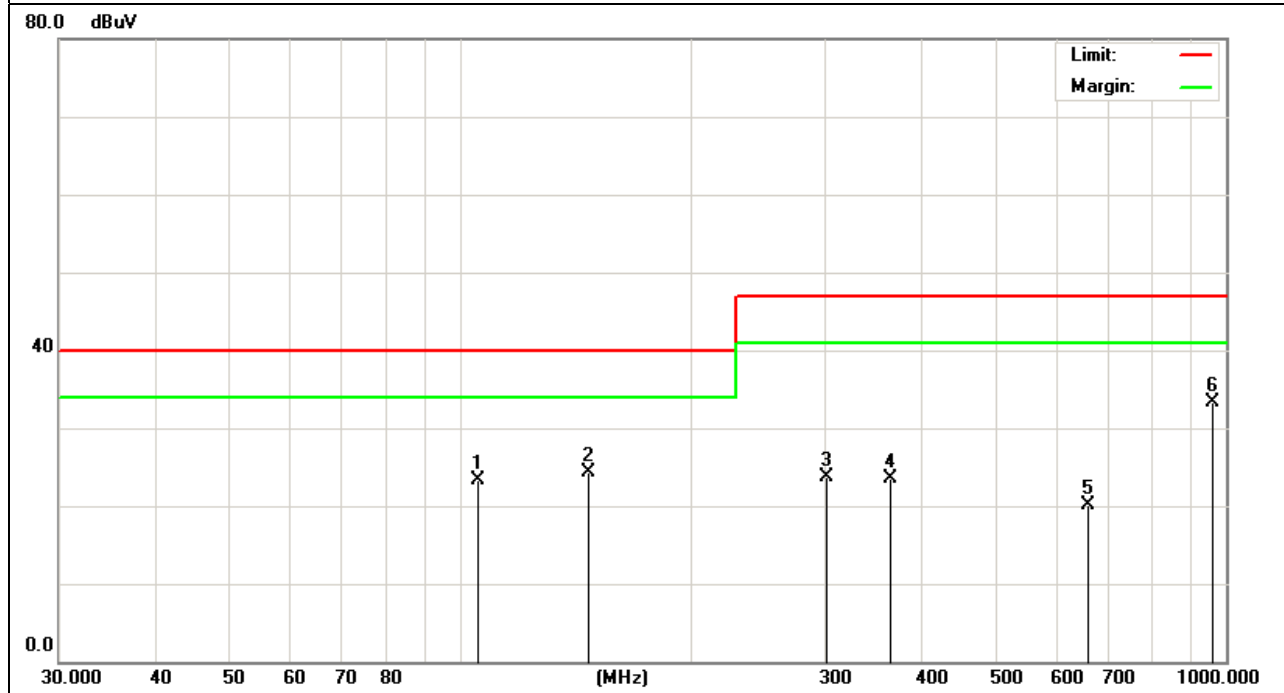

EUT :	Pro Fit™ Wireless Mid-Size Mouse	Model Name :	M01137-M
Temperature :	24 °C	Relative Humidity :	54%
Pressure :	1010 hPa	Test Date :	2011-6-18
Test Mode :	RX	Polarization :	Vertical
Test Power :	DC 3V		

Frequency (MHz)	Meter Reading (dBµV)	Factor (dB)	Emission Level (dBµV/m)	Limits (dBµV/m)	Margin (dB)	Detector Type
105.68	38.06	-14.68	23.38	43.50	-20.12	Quasi-Peak
145.78	35.52	-11.25	24.27	43.50	-19.23	Quasi-Peak
355.88	32.41	-8.71	23.70	46.00	-22.30	Quasi-Peak
400.59	24.85	-7.35	17.50	46.00	-28.50	Quasi-Peak
572.61	23.51	-3.31	20.20	46.00	-25.80	Quasi-Peak
945.44	30.98	2.30	33.28	46.00	-12.72	Quasi-Peak

Remark:

1. Factor = Antenna Factor + Cable Loss – Pre-amplifier.

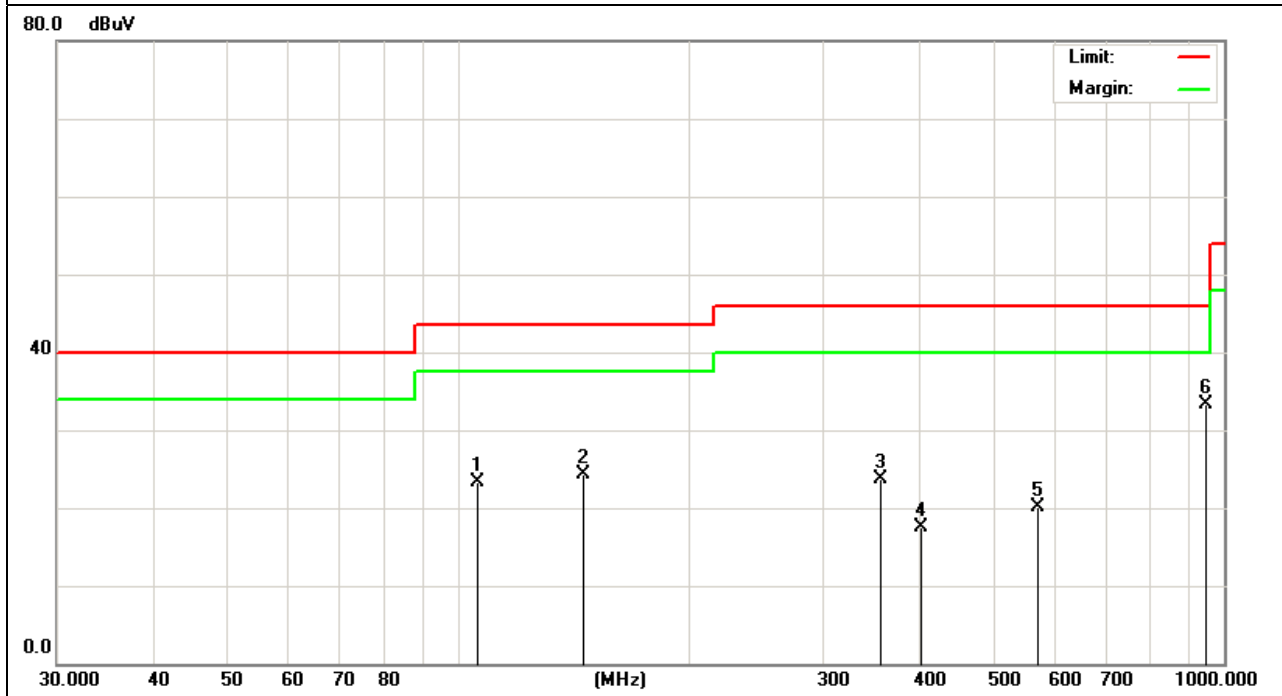

EUT :	Pro Fit™ Wireless Mid-Size Mouse	Model Name :	M01137-M
Temperature :	24 °C	Relative Humidity :	54%
Pressure :	1010 hPa	Test Date :	2011-6-18
Test Mode :	TX	Polarization :	Horizontal
Test Power :	DC 3V		

Frequency (MHz)	Meter Reading (dBµV)	Factor (dB)	Emission Level (dBµV/m)	Limits (dBµV/m)	Margin (dB)	Detector Type
110.4578	23.02	11.44	34.46	43.5	-9.04	Quasi-Peak
230.2564	22.47	10.42	32.89	46	-13.11	Quasi-Peak
359.0231	25.12	15.54	40.66	46	-5.34	Quasi-Peak
653.02	17.25	21.75	39	46	-7	Quasi-Peak
110.4578	23.02	11.44	34.46	43.5	-9.04	Quasi-Peak
230.2564	22.47	10.42	32.89	46	-13.11	Quasi-Peak

Remark:

- Factor = Antenna Factor + Cable Loss – Pre-amplifier.

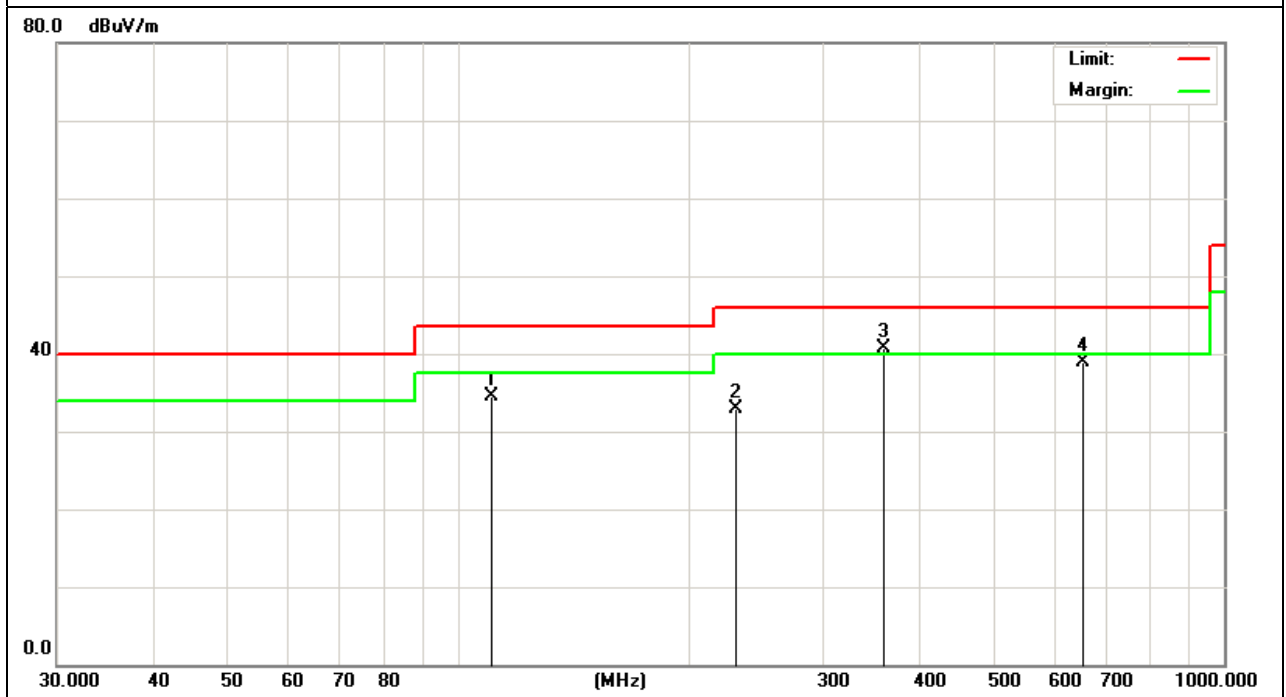

EUT :	Pro Fit™ Wireless Mid-Size Mouse	Model Name :	M01137-M
Temperature :	24 °C	Relative Humidity :	54%
Pressure :	1010 hPa	Test Date :	2011-6-18
Test Mode :	TX	Polarization :	Vertical
Test Power :	DC 3V		

Frequency (MHz)	Meter Reading (dBμV)	Factor (dB)	Emission Level (dBμV/m)	Limits (dBμV/m)	Margin (dB)	Detector Type
45.4879	19.3	10.35	29.65	40	-10.35	Quasi-Peak
102.6134	22.86	10.79	33.65	43.5	-9.85	Quasi-Peak
305.14	20.03	14.58	34.61	46	-11.39	Quasi-Peak
510.6412	22.48	19.42	41.9	46	-4.1	Quasi-Peak
45.4879	19.3	10.35	29.65	40	-10.35	Quasi-Peak
102.6134	22.86	10.79	33.65	43.5	-9.85	Quasi-Peak

Remark:

- Factor = Antenna Factor + Cable Loss – Pre-amplifier.

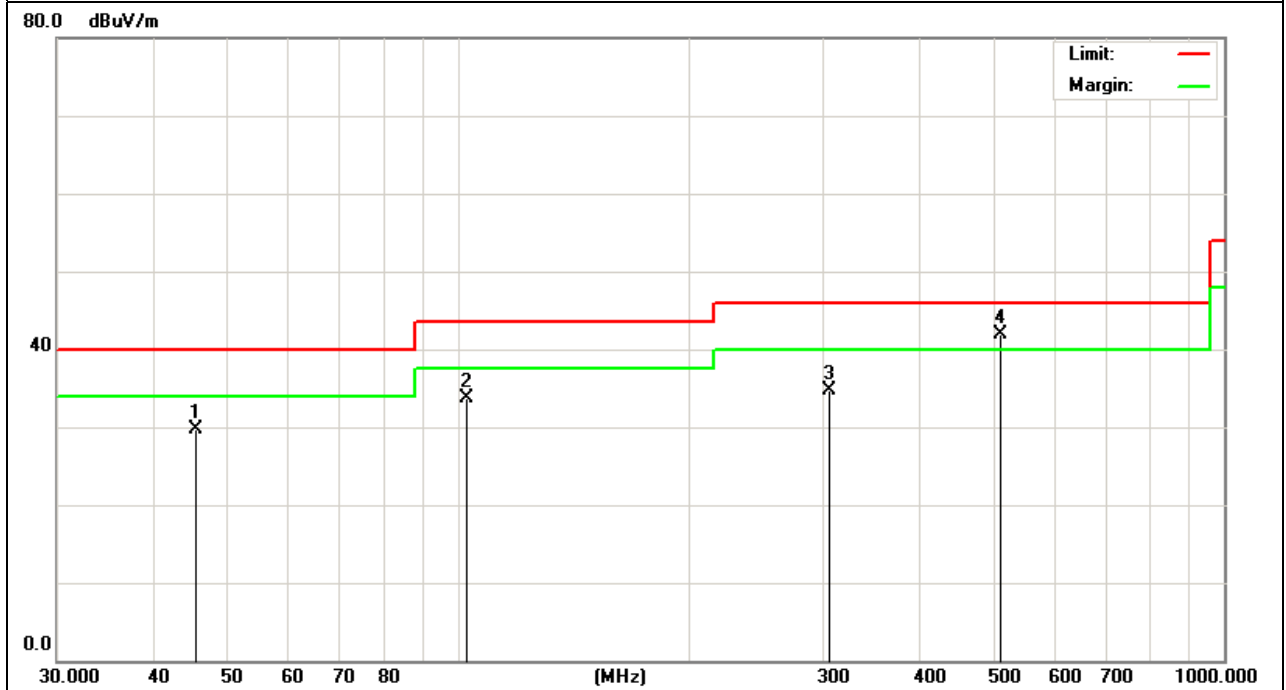

3.3.7 TEST RESULTS (ABOVE 1000 MHZ)

EUT :	Pro Fit™ Wireless Mid-Size Mouse	Model Name :	M01137-M
Temperature :	24 °C	Relative Humidity :	54%
Pressure :	1010 hPa	Test Date :	2011-6-18
Test Mode :	TX 2403MHz	Polarization :	Horizontal
Test Power :	DC 3V		

Frequency (MHz)	Meter Reading (dBµV)	Factor (dB)	Emission Level (dBµV/m)	Limits (dBµV/m)	Margin (dB)	Detector Type
2400.00	54.12	-1.79	52.33	74.00	-21.67	peak
2400.00	42.87	-1.79	41.08	54.00	-12.92	AVG
2403.00	90.63	-1.77	88.86	114.00	-25.14	peak
2403.00	86.31	-1.77	84.54	94.00	-9.46	AVG
4810.00	45.86	4.12	49.98	74.00	-24.02	peak
4810.00	38.62	4.12	42.74	54.00	-11.26	AVG
7215.00	28.59	11.64	40.23	74.00	-33.77	peak
7215.00	23.51	11.64	35.15	54.00	-18.85	AVG

Remark:

1. Factor = Antenna Factor + Cable Loss – Pre-amplifier.

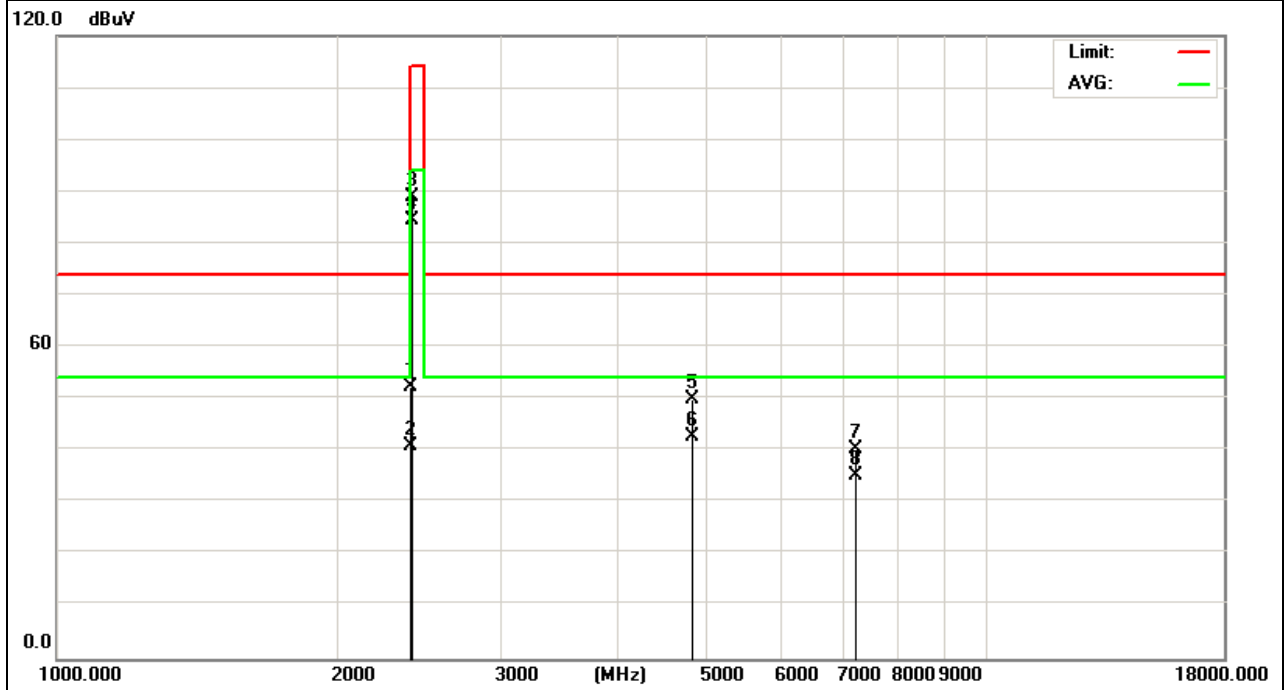

EUT :	Pro Fit™ Wireless Mid-Size Mouse	Model Name :	M01137-M
Temperature :	24 °C	Relative Humidity :	54%
Pressure :	1010 hPa	Test Date :	2011-6-18
Test Mode :	TX 2405MHz	Polarization :	Vertical
Test Power :	DC 3V		

Frequency (MHz)	Meter Reading (dBμV)	Factor (dB)	Emission Level (dBμV/m)	Limits (dBμV/m)	Margin (dB)	Detector Type
2400.00	51.93	-1.79	50.14	74.00	-23.86	peak
2400.00	41.18	-1.79	39.39	54.00	-14.61	AVG
2403.00	86.41	-1.77	84.64	114.00	-29.36	peak
2403.00	83.54	-1.77	81.77	94.00	-12.23	AVG
4810.00	49.08	4.12	53.20	74.00	-20.80	peak
4810.00	39.99	4.12	44.11	54.00	-9.89	AVG
7215.00	34.10	11.64	45.74	74.00	-28.26	peak
7215.00	28.59	11.64	40.23	54.00	-13.77	AVG

Remark:

1. Factor = Antenna Factor + Cable Loss – Pre-amplifier.

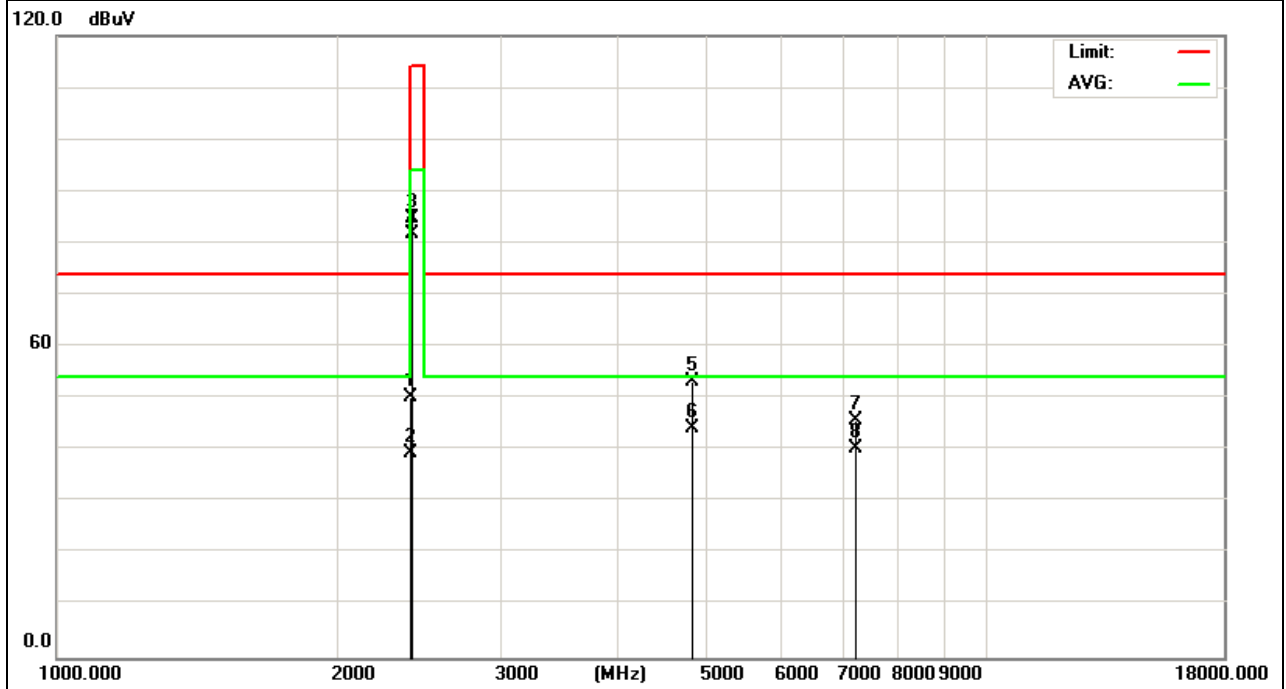

EUT :	Pro Fit™ Wireless Mid-Size Mouse	Model Name :	M01137-M
Temperature :	24 °C	Relative Humidity :	54%
Pressure :	1010 hPa	Test Date :	2011-6-18
Test Mode :	TX 2445MHz	Polarization :	Horizontal
Test Power :	DC 3V		

Frequency (MHz)	Meter Reading (dBμV)	Factor (dB)	Emission Level (dBμV/m)	Limits (dBμV/m)	Margin (dB)	Detector Type
2445.00	88.50	-1.70	86.80	114.0 0	-27.20	peak
2445.00	86.12	-1.70	84.42	94.00	-9.58	AVG
4890.00	47.03	4.25	51.28	74.00	-22.72	peak
4890.00	42.97	4.25	47.22	54.00	-6.78	AVG
7335.00	33.26	11.95	45.21	74.00	-28.79	peak
7335.00	28.29	11.95	40.24	54.00	-13.76	AVG

Remark:

1. Factor = Antenna Factor + Cable Loss – Pre-amplifier.

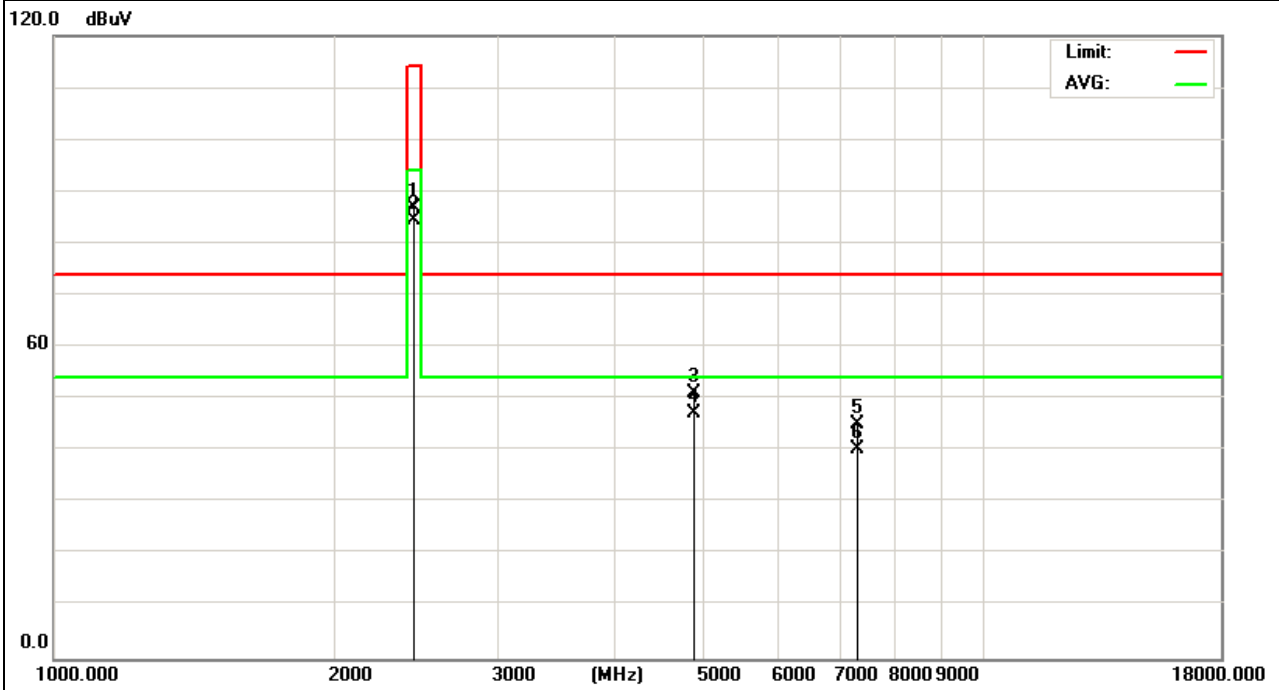

EUT :	Pro Fit™ Wireless Mid-Size Mouse	Model Name :	M01137-M
Temperature :	24 °C	Relative Humidity :	54%
Pressure :	1010 hPa	Test Date :	2011-6-18
Test Mode :	TX 2445MHz	Polarization :	Vertical
Test Power :	DC 3V		

Frequency (MHz)	Meter Reading (dBμV)	Factor (dB)	Emission Level (dBμV/m)	Limits (dBμV/m)	Margin (dB)	Detector Type
2445.00	85.92	-1.70	84.22	114.0 0	-29.78	peak
2445.00	83.44	-1.70	81.74	94.00	-12.26	AVG
4890.00	48.95	4.25	53.20	74.00	-20.80	peak
4890.00	43.23	4.25	47.48	54.00	-6.52	AVG
7335.00	35.17	11.95	47.12	74.00	-26.88	peak
7335.00	28.50	11.95	40.45	54.00	-13.55	AVG

Remark:

- Factor = Antenna Factor + Cable Loss – Pre-amplifier.

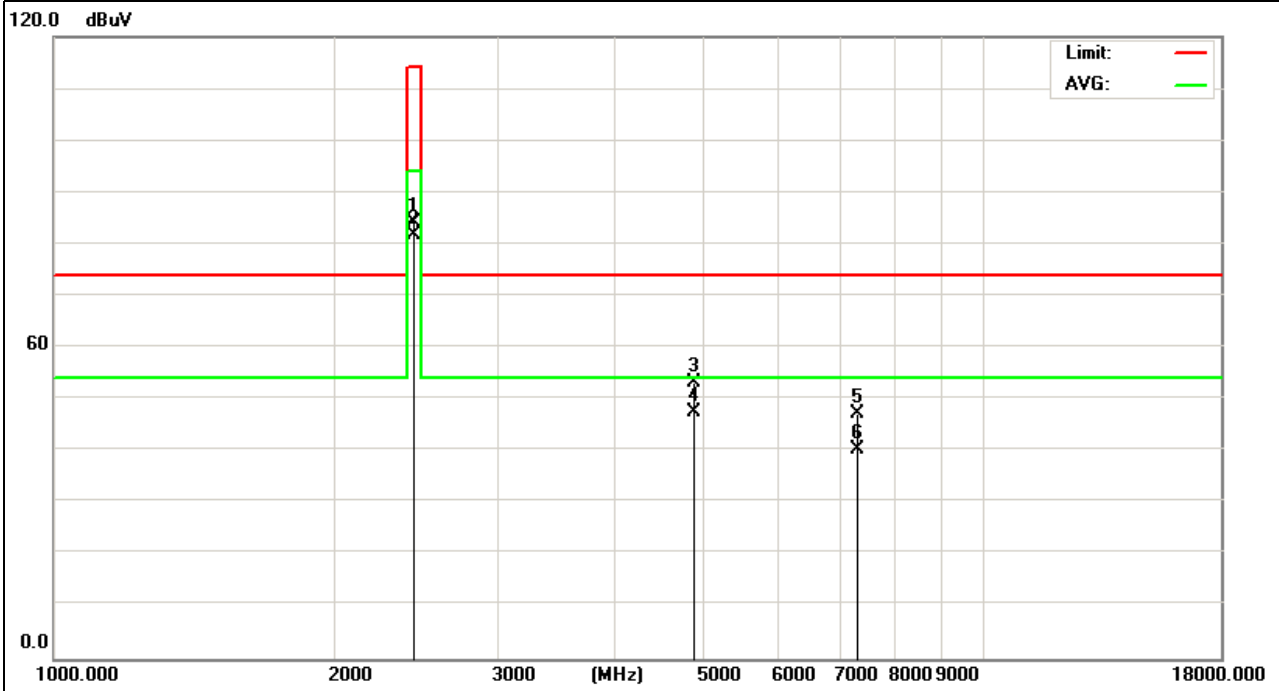

EUT :	Pro Fit™ Wireless Mid-Size Mouse	Model Name :	M01137-M
Temperature :	24 °C	Relative Humidity :	54%
Pressure :	1010 hPa	Test Date :	2011-6-18
Test Mode :	TX 2478MHz	Polarization :	Horizontal
Test Power :	DC 3V		

Frequency (MHz)	Meter Reading (dBμV)	Factor (dB)	Emission Level (dBμV/m)	Limits (dBμV/m)	Margin (dB)	Detector Type
2478.00	88.70	-1.59	87.11	114.0 0	-26.89	peak
2478.00	87.16	-1.59	85.57	94.00	-8.43	AVG
2483.50	46.15	-1.58	44.57	74.00	-29.43	peak
2483.50	41.79	-1.58	40.21	54.00	-13.79	AVG
4880.00	48.95	4.25	53.20	74.00	-20.80	peak
4880.00	43.62	4.25	47.87	54.00	-6.13	AVG
7320.00	35.60	11.95	47.55	74.00	-26.45	peak
7320.00	30.62	11.95	42.57	54.00	-11.43	AVG

Remark:

1. Factor = Antenna Factor + Cable Loss – Pre-amplifier.

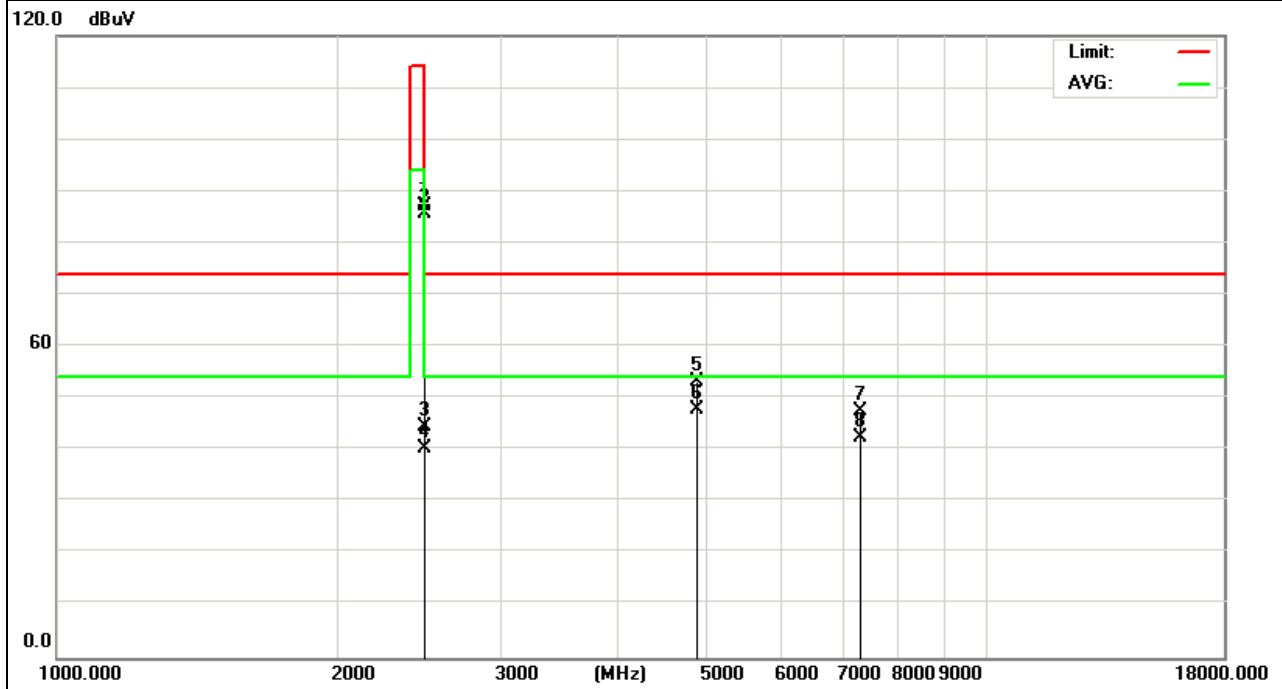

EUT :	Pro Fit™ Wireless Mid-Size Mouse	Model Name :	M01137-M
Temperature :	24 °C	Relative Humidity :	54%
Pressure :	1010 hPa	Test Date :	2011-6-18
Test Mode :	TX 2478MHz	Polarization :	Vertical
Test Power :	DC 3V		

Frequency (MHz)	Meter Reading (dBμV)	Factor (dB)	Emission Level (dBμV/m)	Limits (dBμV/m)	Margin (dB)	Detector Type
2478.00	92.05	-1.59	90.46	114.0 0	-23.54	peak
2478.00	88.72	-1.59	87.13	94.00	-6.87	AVG
2483.50	46.81	-1.58	45.23	74.00	-28.77	peak
2483.50	42.32	-1.58	40.74	54.00	-13.26	AVG
4880.00	50.11	4.25	54.36	74.00	-19.64	peak
4880.00	46.49	4.25	50.74	54.00	-3.26	AVG

Remark:

- Factor = Antenna Factor + Cable Loss – Pre-amplifier.

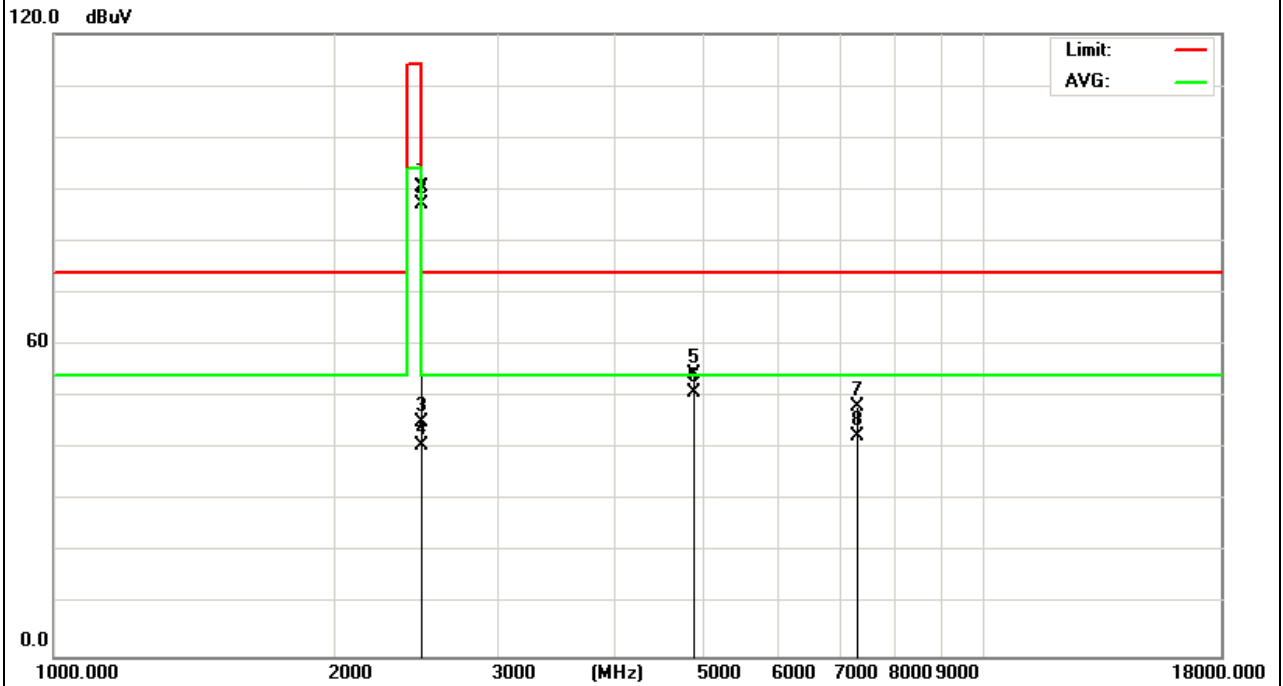

4. BANDWIDTH TEST

4.1 TEST PROCEDURE

- a. The EUT was directly connected to the spectrum analyzer and antenna output port as show in the block diagram below,
- b. Spectrum Setting : RBW= 100KHz, VBW \geq RBW, Sweep time = Auto.

4.2 DEVIATION FROM STANDARD

No deviation.

4.3 TEST SETUP



4.4 TEST RESULTS

EUT :	Pro Fit™ Wireless Mid-Size Mouse	Model Name :	M01137-M
Temperature :	26 °C	Relative Humidity :	53%
Pressure :	1020 hPa	Test Power :	DC 3V
Test Mode :	TX CH 1/11/5		

Test Channel	Frequency (MHz)	20 dBc Bandwidth (MHz)	99% Bandwidth (MHz)
CH01	2405	1.14	1.21
CH011	2445	1.02	1.02
CH05	2478	0.95	1.22

The Lowest Channel:2405MHz



Ref 100 dBµV *Att 20 dB SWT 5 ms

*RBW 100 kHz Marker 1 [T1] 85.44 dBµV
 *VBW 300 kHz

1 PK
VIEW

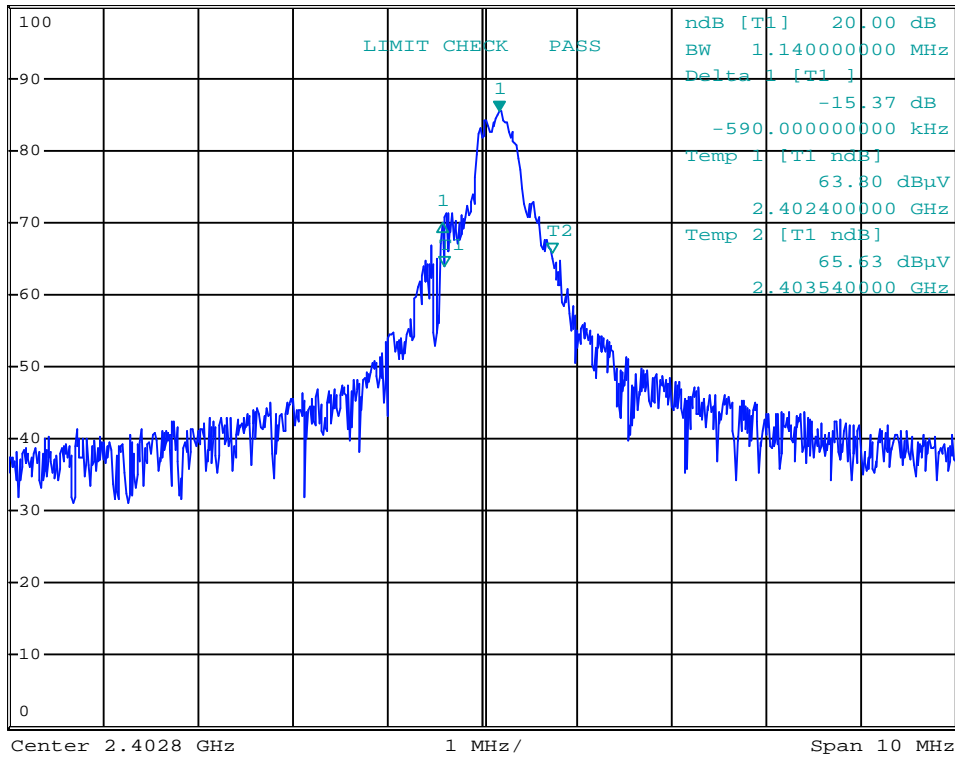

Date: 23.JUN.2011 16:30:56



Ref 100 dBµV *Att 20 dB SWT 5 ms

*RBW 100 kHz Marker 1 [T1] 85.44 dBµV
 *VBW 300 kHz

1 PK
VIEW

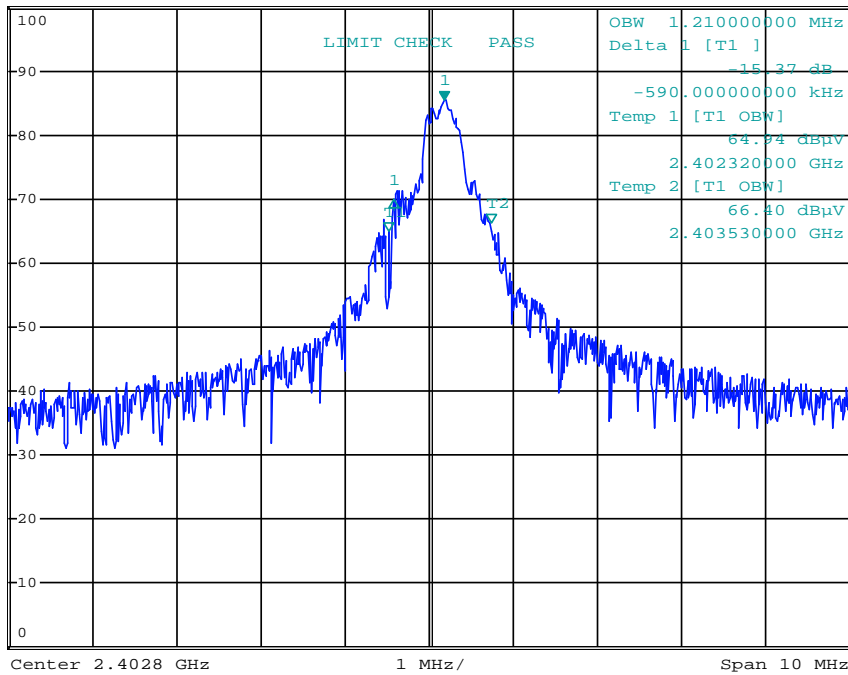

Date: 23.JUN.2011 16:30:33

The Middle Channel:2445MHz

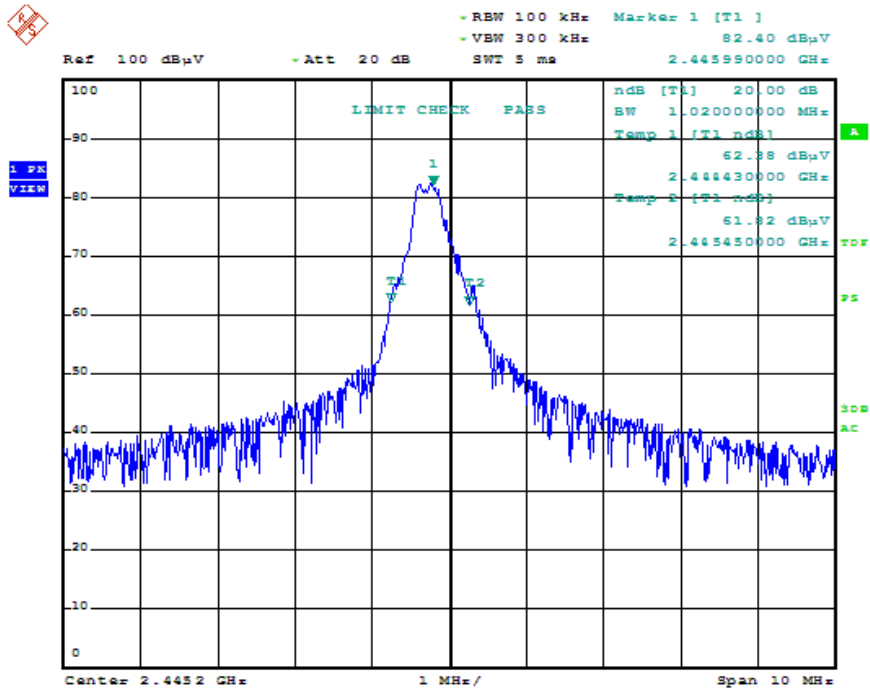

Date: 23.JUN.2011 16:34:16

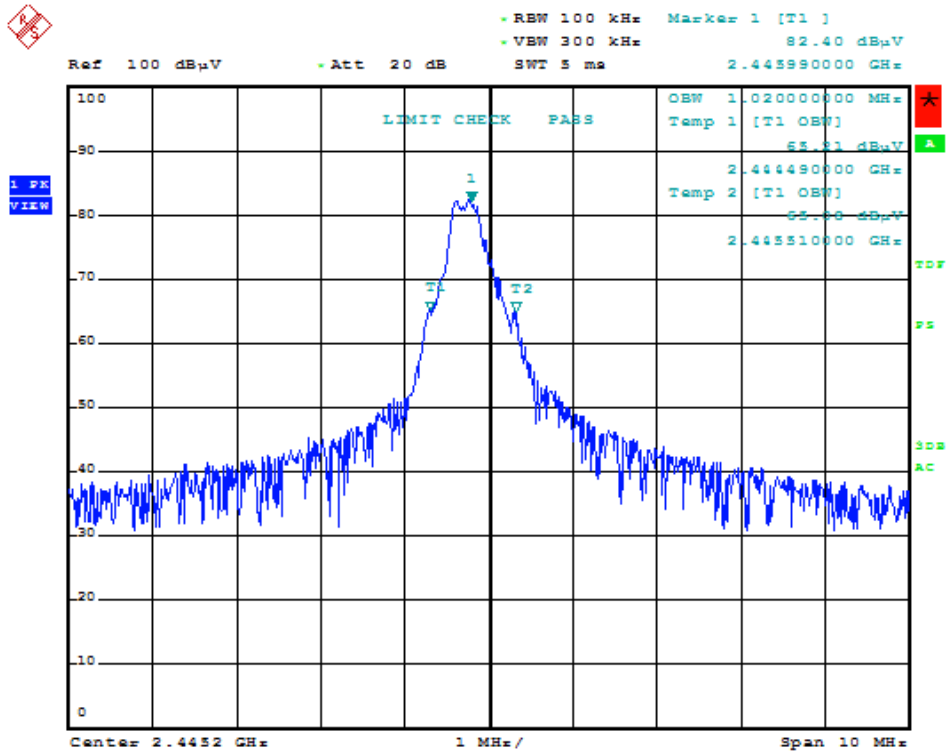

Date: 23.JUN.2011 16:34:38

The Middle Channel:2478MHz

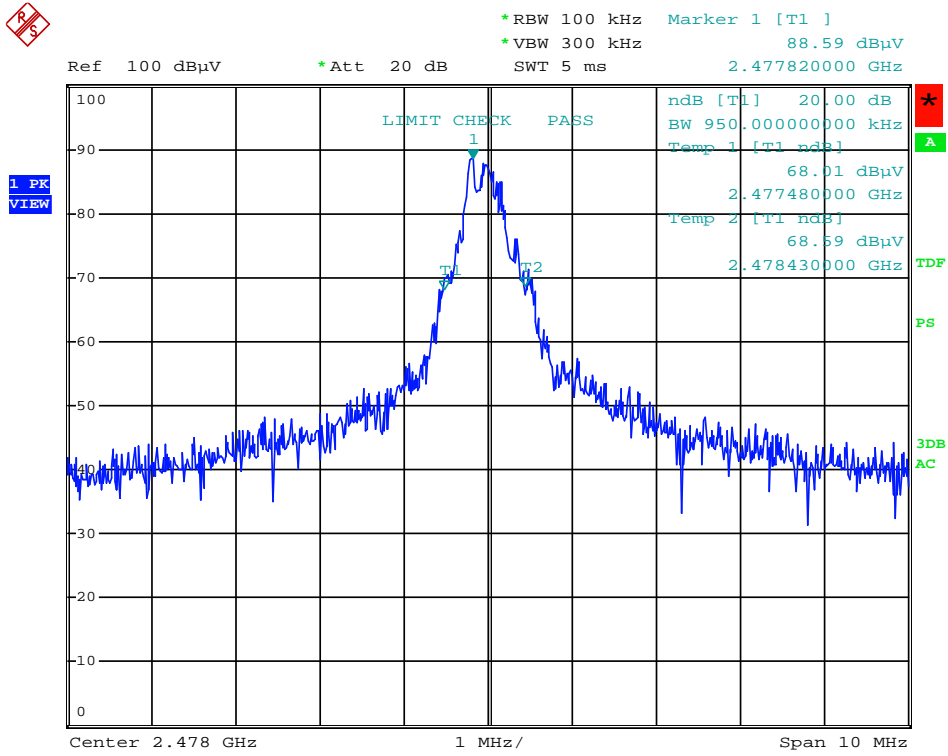

Date: 23.JUN.2011 16:37:20

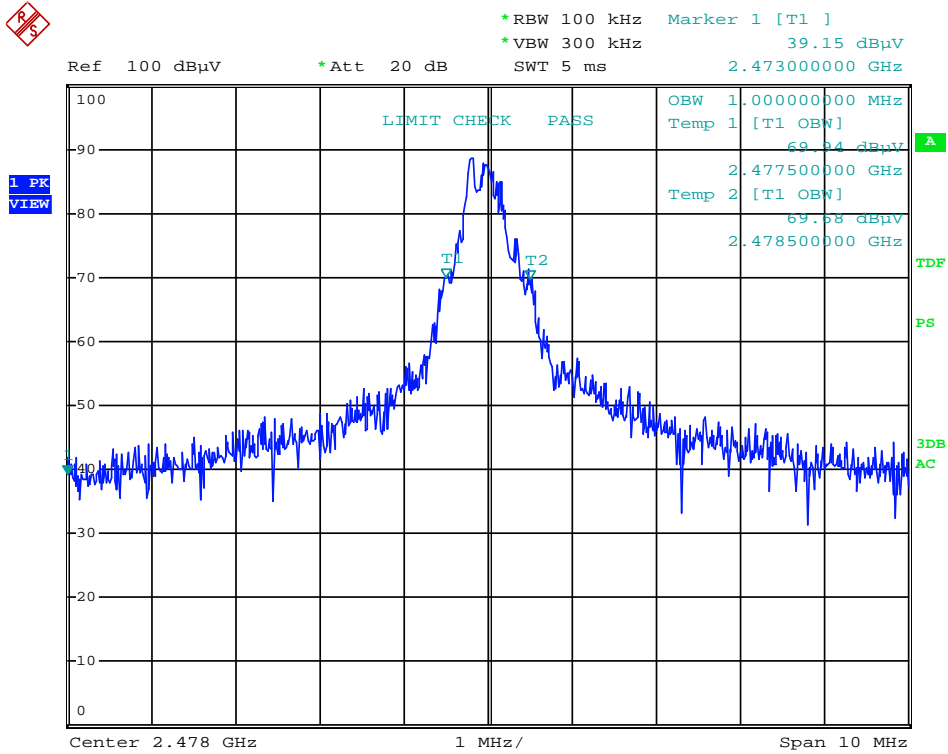

Date: 23.JUN.2011 16:36:52