



FCC Radio TEST Report

FCC ID: GV3M01132-D

This report concerns (check one): Original Grant Class II Change

Issued Date : Jan. 10, 2010
Project No. : 1012C160
Equipment : 2.4GHz wireless receiver
Model Name : M01132-D
Applicant : ACCO Brands, Inc
Address : 333 Twin Dolphin Drive, Sixth Floor, Redwood Shores, CA 94065, USA
Manufacturer : Sysgration(Shenzhen) Ltd.
Address : Egongling Village. Pinghu Town. Longgang Dist. Shenzhen City. China.

Tested by:

Neutron Engineering Inc. EMC Laboratory

Date of Receipt: Dec. 29, 2010

Date of Test:

Dec. 29, 2010 ~ Jan. 07, 2011

Testing Engineer : Ivan Cao
(Ivan Cao)
Technical Manager : Leo Hung
(Leo Hung)
Authorized Signatory : Steven Lu
(Steven Lu)

Neutron Engineering Inc.

No.3, Jinshagang 1st Road, ShiXia, Dalang
Town, Dong Guan, China.
TEL : (0769) 8318-3000 FAX : (0769) 8319-6000



Declaration

Neutron represents to the client that testing is done in accordance with standard procedures as applicable and that test instruments used has been calibrated with the standards traceable to National Measurement Laboratory (**NML**) of **R.O.C.**, or National Institute of Standards and Technology (**NIST**) of **U.S.A.**

Neutron's reports apply only to the specific samples tested under conditions. It is manufacture's responsibility to ensure that additional production units of this model are manufactured with the identical electrical and mechanical components. **Neutron** shall have no liability for any declarations, inferences or generalizations drawn by the client or others from **Neutron** issued reports.

Neutron's reports must not be used by the client to claim product endorsement by the authorities or any agency of the Government.

This report is the confidential property of the client. As a mutual protection to the clients, the public and **Neutron-self**, extracts from the test report shall not be reproduced except in full with **Neutron's** authorized written approval.

Neutron's laboratory quality assurance procedures are in compliance with the **ISO Guide 17025** requirements, and accredited by the conformity assessment authorities listed in this test report.

Limitation

For the use of the authority's logo is limited unless the Test Standard(s)/Scope(s)/Item(s) mentioned in this test report is (are) included in the conformity assessment authorities acceptance respective.



| Table of Contents | Page |
|---|-------------|
| 1 . CERTIFICATION | 5 |
| 2 . SUMMARY OF TEST RESULTS | 6 |
| 2.1 TEST FACILITY | 7 |
| 2.2 MEASUREMENT UNCERTAINTY | 7 |
| 3 . GENERAL INFORMATION | 8 |
| 3.1 GENERAL DESCRIPTION OF EUT | 8 |
| 3.2 DESCRIPTION OF TEST MODES | 10 |
| 3.3 BLOCK DIGRAM SHOWING THE CONFIGURATION OF SYSTEM TESTED | 11 |
| 3.4 DESCRIPTION OF SUPPORT UNITS | 12 |
| 4 . EMC EMISSION TEST | 13 |
| 4.1 CONDUCTED EMISSION MEASUREMENT | 13 |
| 4.1.1 POWER LINE CONDUCTED EMISSION LIMITS | 13 |
| 4.1.2 MEASUREMENT INSTRUMENTS LIST | 13 |
| 4.1.3 TEST PROCEDURE | 14 |
| 4.1.4 DEVIATION FROM TEST STANDARD | 14 |
| 4.1.5 TEST SETUP | 14 |
| 4.1.6 EUT OPERATING CONDITIONS | 14 |
| 4.1.7 TEST RESULTS | 15 |
| 4.2 RADIATED EMISSION MEASUREMENT | 17 |
| 4.2.1 RADIATED EMISSION LIMITS | 17 |
| 4.2.2 MEASUREMENT INSTRUMENTS LIST | 18 |
| 4.2.3 TEST PROCEDURE | 20 |
| 4.2.4 DEVIATION FROM TEST STANDARD | 20 |
| 4.2.5 TEST SETUP | 21 |
| 4.2.6 EUT OPERATING CONDITIONS | 21 |
| 4.2.7 TEST RESULTS (BETWEEN 30 – 1000 MHz) | 22 |
| 4.2.8 TEST RESULTS (ABOVE 1000 MHz) | 24 |
| 4.2.9 TEST RESULTS (2400 – 2483.5 MHz) | 36 |
| 5 . BANDWIDTH TEST | 37 |
| 5.1 MEASUREMENT INSTRUMENTS LIST | 37 |
| 5.2 TEST PROCEDURE | 37 |
| 5.3 DEVIATION FROM STANDARD | 37 |
| 5.4 TEST SETUP | 37 |
| 5.5 EUT OPERATION CONDITIONS | 37 |
| 5.6 TEST RESULTS | 38 |
| 6 . ANTENNA CONDUCTED SPURIOUS EMISSION | 40 |



| Table of Contents | Page |
|------------------------------------|-------------|
| 6.1 APPLIED PROCEDURES / LIMIT | 40 |
| 6.1.1 MEASUREMENT INSTRUMENTS LIST | 40 |
| 6.1.2 TEST PROCEDURE | 40 |
| 6.1.3 DEVIATION FROM STANDARD | 40 |
| 6.1.4 TEST SETUP | 40 |
| 6.1.5 EUT OPERATION CONDITIONS | 40 |
| 6.1.6 TEST RESULTS | 41 |
| 7 . EUT TEST PHOTO | 46 |



1. CERTIFICATION

Equipment : 2.4GHz wireless receiver

Brand Name : Kensington

Model Name : M01132-D

Applicant : ACCO Brands, Inc

Factory : Sysgration(Shenzhen) Ltd.

Address : Egongling Village. Pinghu Town. Longgang Dist. Shenzhen City. China.

Date of Test : Dec. 29, 2010 ~ Jan. 07, 2011

Test Item : ENGINEERING SAMPLE

Standards : FCC Part15, Subpart C(15.249)/ ANSI C63.4 : 2003

The above equipment has been tested and found compliance with the requirement of the relative standards by Neutron Engineering Inc. EMC Laboratory.

The test data, data evaluation, and equipment configuration contained in our test report (Ref No. NEI-FCCP-1-1012C160) were obtained utilizing the test procedures, test instruments, test sites that has been accredited by the Authority of NVLAP and TAF according to the ISO-17025 quality assessment standard and technical standard(s).



2. SUMMARY OF TEST RESULTS

Test procedures according to the technical standards:

| FCC Part15, Subpart C (15.249) | | | |
|--------------------------------|----------------------------|----------|--------|
| Standard Section | Test Item | Judgment | Remark |
| 15.207 | Conducted Emission | PASS | |
| 15.209 | Radiated Emission | PASS | |
| 15.249 | Radiated Spurious Emission | PASS | |

NOTE:

(1) "N/A" denotes test is not applicable in this Test Report



2.1 TEST FACILITY

The test facilities used to collect the test data in this report is **DG-C02/DG-CB03** at the location of No.3, Jinshagang 1st Road, ShiXia, Dalang Town, Dong Guan, China.523792
 Neutron's test firm number is 319330

2.2 MEASUREMENT UNCERTAINTY

Where relevant, the following measurement uncertainty levels have been estimated for tests performed on the EUT as specified in CISPR 16-4-2:

The reported uncertainty of measurement $y \pm U$, where expanded uncertainty **U** is based on a standard uncertainty multiplied by a coverage factor of **k=2**, providing a level of confidence of approximately **95 %**.

A. Conducted Measurement :

| Test Site | Method | Measurement Frequency Range | U , (dB) | NOTE |
|-----------|--------|-----------------------------|----------|------|
| DG-C02 | CISPR | 150 KHz ~ 30MHz | 1.94 | |

B. Radiated Measurement :

| Test Site | Method | Measurement Frequency Range | Ant. H / V | U , (dB) | NOTE |
|-----------|--------|-----------------------------|------------|----------|------|
| DG-CB03 | CISPR | 30MHz ~ 200MHz | V | 2.48 | |
| | | 30MHz ~ 200MHz | H | 2.16 | |
| | | 200MHz ~ 1,000MHz | V | 2.50 | |
| | | 200MHz ~ 1,000MHz | H | 2.66 | |



3. GENERAL INFORMATION

3.1 GENERAL DESCRIPTION OF EUT

| | | |
|--|--|--------------------------------|
| Equipment | 2.4GHz wireless receiver | |
| Brand Name | Kensington | |
| Model Name. | M01132-D | |
| OEM Brand/Model Name | N/A | |
| Model Difference | N/A | |
| Product Description | The EUT is a 2.4GHz wireless receiver. | |
| | Product Type | Low Power Communication Device |
| | Operation Frequency: | 2418~2463 MHz |
| | Modulation Type: | GFSK |
| | Date rate: | 1Mbps |
| | Number Of Channel | 16CH .Please see note 2. |
| | Antenna Designation: | Printed antenna |
| | Antenna Gain(Peak) | 2.12 dBi |
| | Output Power: | 63.85dBuV/m (AV Max.) |
| Based on the application, features, or specification exhibited in User's Manual, the EUT is considered as an ITE/Computing Device. More details of EUT technical specification. Please refer to the User's Manual. | | |
| Power Source | DC Voltage supplied from Host System | |
| Power Rating | I/P AC 120V/60Hz O/P DC 5V | |
| Connecting I/O Port(s) | Please refer to the User's Manual | |
| Products Covered | N/A | |

Note:

1. For a more detailed features description, please refer to the manufacturer's specifications or the User's Manual.



2.

| Frequency Band | Channel No. | Frequency |
|----------------|-------------|-----------|
| 2400~2483.5MHz | 1 | 2418 MHz |
| | 2 | 2421 MHz |
| | 3 | 2424 MHz |
| | 4 | 2427 MHz |
| | 5 | 2430 MHz |
| | 6 | 2433 MHz |
| | 7 | 2436 MHz |
| | 8 | 2439 MHz |
| | 9 | 2442 MHz |
| | 10 | 2445 MHz |
| | 11 | 2448 MHz |
| | 12 | 2451 MHz |
| | 13 | 2454 MHz |
| | 14 | 2457 MHz |
| | 15 | 2460 MHz |
| | 16 | 2463 MHz |

3. Table for Filed Antenna

| Ant. | Brand | Model Name | Antenna Type | Connector | Gain (dBi) |
|------|-------|------------|-----------------|-----------|------------|
| 1 | N/A | N/A | Printed Antenna | N/A | 2.12 |



3.2 DESCRIPTION OF TEST MODES

To investigate the maximum EMI emission characteristics generated from EUT, the test system was pre-scanning tested based on the consideration of following EUT operation mode or test configuration mode which possible have effect on EMI emission level. Each of these EUT operation mode(s) or test configuration mode(s) mentioned above was evaluated respectively.

| Pretest Mode | Description |
|--------------|---------------------|
| Mode 1 | CH Lower - 2418MHz |
| Mode 2 | CH Middle - 2442MHz |
| Mode 3 | CH Highest -2463MHz |
| Mode 4 | Normal Link |

| For Conducted Test | |
|--------------------|-------------|
| Final Test Mode | Description |
| Mode 4 | Normal Link |

| For Radiated Test | |
|-------------------|---------------------|
| Final Test Mode | Description |
| Mode 1 | CH Lower - 2418MHz |
| Mode 2 | CH Middle - 2442MHz |
| Mode 3 | CH Highest -2463MHz |



3.3 BLOCK DIGRAM SHOWING THE CONFIGURATION OF SYSTEM TESTED

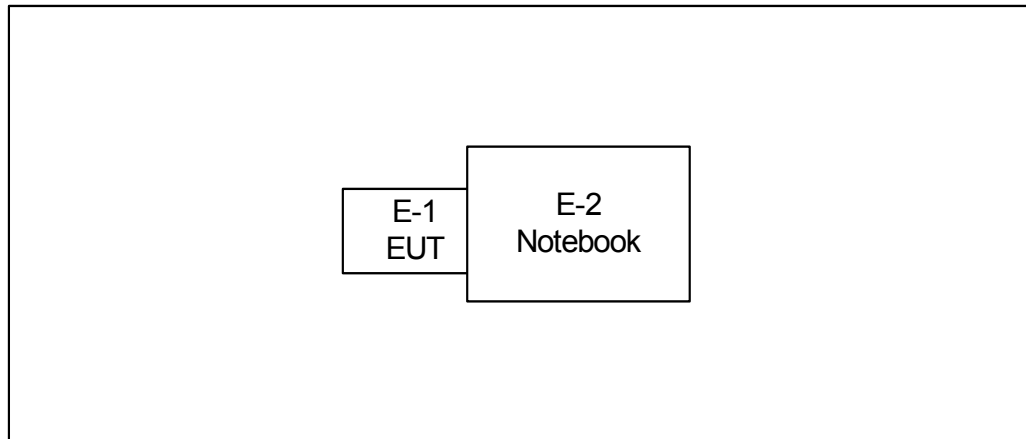



3.4 DESCRIPTION OF SUPPORT UNITS

The EUT has been tested as an independent unit together with other necessary accessories or support units. The following support units or accessories were used to form a representative test configuration during the tests.

| Item | Equipment | Mfr/Brand | Model/Type No. | FCC ID | Series No. | Note |
|------|--------------------------|------------|----------------|-------------|------------|------|
| E-1 | 2.4GHz wireless receiver | Kensington | M01132-D | GV3M01132-D | N/A | EUT |
| E-2 | Notebook | Dell | INSPIRON.1420 | N/A | N/A | |
| | | | | | | |
| | | | | | | |
| | | | | | | |
| | | | | | | |

| Item | Shielded Type | Ferrite Core | Length | Note |
|------|---------------|--------------|--------|------|
| | | | | |
| | | | | |
| | | | | |
| | | | | |
| | | | | |

Note:

- (1) The support equipment was authorized by Declaration of Confirmation.
- (2) For detachable type I/O cable should be specified the length in m in 『Length』 column.



4. EMC EMISSION TEST

4.1 CONDUCTED EMISSION MEASUREMENT

4.1.1 POWER LINE CONDUCTED EMISSION LIMITS (Frequency Range 150KHz-30MHz)

| FREQUENCY (MHz) | Class A (dBuV) | | Class B (dBuV) | | Standard |
|-----------------|----------------|---------|----------------|-----------|----------|
| | Quasi-peak | Average | Quasi-peak | Average | |
| 0.15 -0.5 | 79.00 | 66.00 | 66 - 56 * | 56 - 46 * | CISPR |
| 0.50 -5.0 | 73.00 | 60.00 | 56.00 | 46.00 | CISPR |
| 5.0 -30.0 | 73.00 | 60.00 | 60.00 | 50.00 | CISPR |

| | | | | | |
|-----------|-------|-------|-----------|-----------|-----|
| 0.15 -0.5 | 79.00 | 66.00 | 66 - 56 * | 56 - 46 * | FCC |
| 0.50 -5.0 | 73.00 | 60.00 | 56.00 | 46.00 | FCC |
| 5.0 -30.0 | 73.00 | 60.00 | 60.00 | 50.00 | FCC |

Note:

- (1) The tighter limit applies at the band edges.
- (2) The limit of " * " marked band means the limitation decreases linearly with the logarithm of the frequency in the range.

4.1.2 MEASUREMENT INSTRUMENTS LIST

| Item | Kind of Equipment | Manufacturer | Type No. | Serial No. | Calibrated until |
|------|-------------------|--------------|-----------|------------|------------------|
| 1 | LISN | EMCO | 3816/2 | 00052765 | May.26.2011 |
| 2 | LISN | Rolf Heine | NNB-2-16Z | 99044 | May.26.2011 |
| 3 | 50Ω Terminator | SHX | TF2-3G-A | 08122901 | May.26.2011 |
| 4 | Transient Limiter | Agilent | 11947A | 3107A03668 | May.26.2011 |
| 5 | Test Cable | N/A | C-06_C03 | N/A | Nov.15.2011 |
| 6 | EMI TEST RECEIVER | R&S | ESCS30 | 8333641017 | May.26.2011 |

Remark: " N/A" denotes No Model Name. , Serial No. or No Calibration specified.

The following table is the setting of the receiver

| Receiver Parameters | Setting |
|---------------------|----------|
| Attenuation | 10 dB |
| Start Frequency | 0.15 MHz |
| Stop Frequency | 30 MHz |
| IF Bandwidth | 9 kHz |

4.1.3 TEST PROCEDURE

- a. The EUT was placed 0.8 meters from the horizontal ground plane with EUT being connected to the power mains through a line impedance stabilization network (LISN). All other support equipments powered from additional LISN(s). The LISN provide 50 Ohm/ 50uH of coupling impedance for the measuring instrument.
- b. Interconnecting cables that hang closer than 40 cm to the ground plane shall be folded back and forth in the center forming a bundle 30 to 40 cm long.
- c. I/O cables that are not connected to a peripheral shall be bundled in the center. The end of the cable may be terminated, if required, using the correct terminating impedance. The overall length shall not exceed 1 m.
- d. LISN at least 80 cm from nearest part of EUT chassis.
- e. For the actual test configuration, please refer to the related Item –EUT Test Photos.

4.1.4 DEVIATION FROM TEST STANDARD

No deviation

4.1.5 TEST SETUP

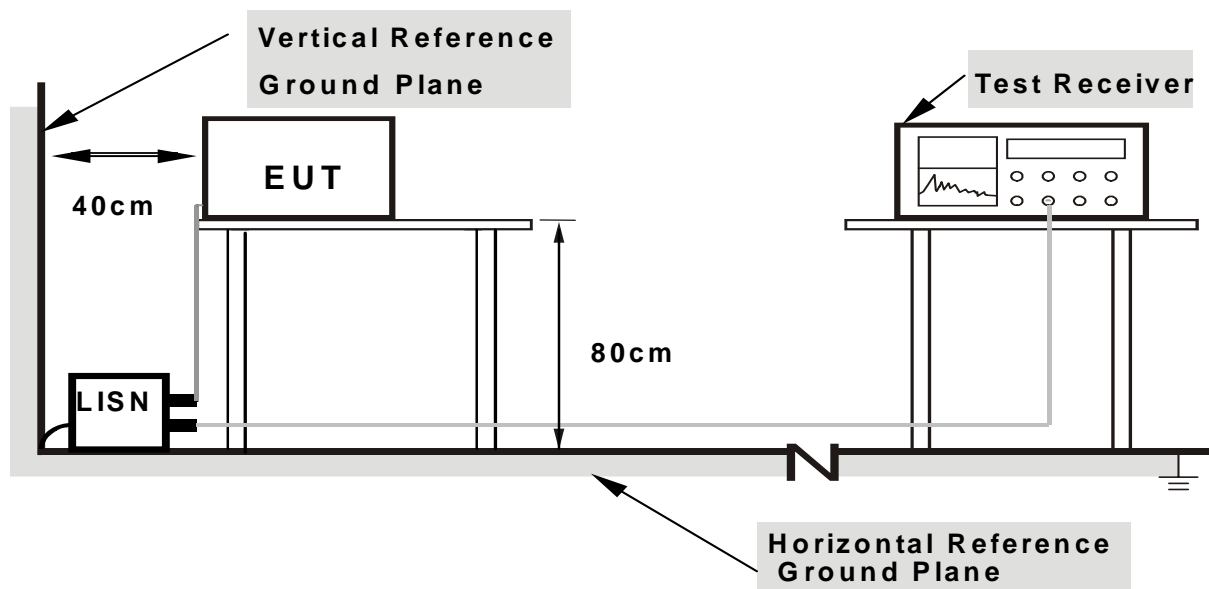

- Note: 1. Support units were connected to second LISN.**
2. Both of LISNs (AMN) are 80 cm from EUT and at least 80 from other units and other metal planes

4.1.6 EUT OPERATING CONDITIONS

The EUT was configured for testing in a typical fashion (as a customer would normally use it). The EUT has been programmed to continuously transmit during test. This operating condition was tested and used to collect the included data.

The EUT was programmed to be in continuously transmitting mode.



4.1.7 TEST RESULTS

| | | | |
|---------------|--------------------------|---------------------|------------|
| EUT : | 2.4GHz wireless receiver | Model Name : | M01132-D |
| Temperature : | 23°C | Relative Humidity : | 51 % |
| Pressure : | 1001 hPa | Test Power : | AC 120V/60 |
| Test Mode : | Normal Link | | |

| Freq. (MHz) | Terminal L/N | Measured(dBuV) | | Limits(dBuV) | | Margin (dB) | Note |
|-------------|--------------|----------------|---------|--------------|---------|-------------|------|
| | | QP-Mode | AV-Mode | QP-Mode | AV-Mode | | |
| 0.15 | Line | 41.26 | * | 66.00 | 56.00 | -24.74 | (QP) |
| 0.17 | Line | 43.63 | * | 65.16 | 55.16 | -21.53 | (QP) |
| 0.19 | Line | 42.66 | * | 64.04 | 54.04 | -21.38 | (QP) |
| 0.25 | Line | 38.77 | * | 61.60 | 51.60 | -22.83 | (QP) |
| 2.58 | Line | 36.94 | * | 56.00 | 46.00 | -19.06 | (QP) |
| 14.65 | Line | 41.56 | * | 60.00 | 50.00 | -18.44 | (QP) |

Remark

- (1) All readings are QP Mode value unless otherwise stated AVG in column of 'Note'. If the QP Mode Measured value compliance with the QP Limits and lower than AVG Limits, the EUT shall be deemed to meet both QP & AVG Limits and then only QP Mode was measured, but AVG Mode didn't perform. In this case, a "*" marked in AVG Mode column of Interference Voltage Measured.
- (2) Measuring frequency range from 150KHz to 30MHz.

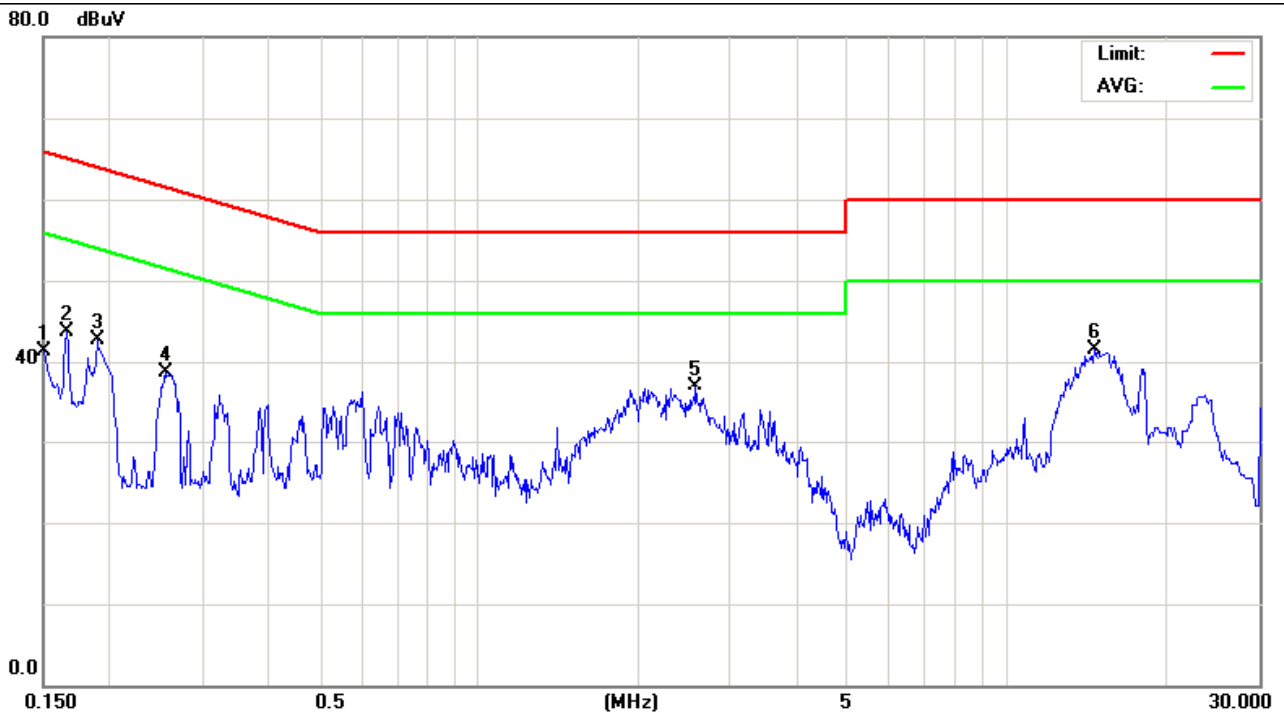



| | | | |
|---------------|--------------------------|---------------------|------------|
| EUT : | 2.4GHz wireless receiver | Model Name : | M01132-D |
| Temperature : | 23°C | Relative Humidity : | 51 % |
| Pressure : | 1001 hPa | Test Power : | AC 120V/60 |
| Test Mode : | Normal Link | | |

| Freq. (MHz) | Terminal L/N | Measured(dBuV) | | Limits(dBuV) | | Margin (dB) | Note |
|-------------|--------------|----------------|---------|--------------|---------|-------------|------|
| | | QP-Mode | AV-Mode | QP-Mode | AV-Mode | | |
| 0.15 | Line | 40.99 | * | 66.00 | 56.00 | -25.01 | (QP) |
| 0.19 | Line | 40.54 | * | 63.98 | 53.98 | -23.44 | (QP) |
| 0.24 | Line | 37.13 | * | 62.03 | 52.03 | -24.90 | (QP) |
| 0.25 | Line | 39.20 | * | 61.63 | 51.63 | -22.43 | (QP) |
| 16.49 | Line | 40.19 | * | 60.00 | 50.00 | -19.81 | (QP) |
| 19.12 | Line | 39.55 | * | 60.00 | 50.00 | -20.45 | (QP) |

Remark

- (1) All readings are QP Mode value unless otherwise stated AVG in column of 'Note'. If the QP Mode Measured value compliance with the QP Limits and lower than AVG Limits, the EUT shall be deemed to meet both QP & AVG Limits and then only QP Mode was measured, but AVG Mode didn't perform. In this case, a "*" marked in AVG Mode column of Interference Voltage Measured.
- (2) Measuring frequency range from 150KHz to 30MHz.

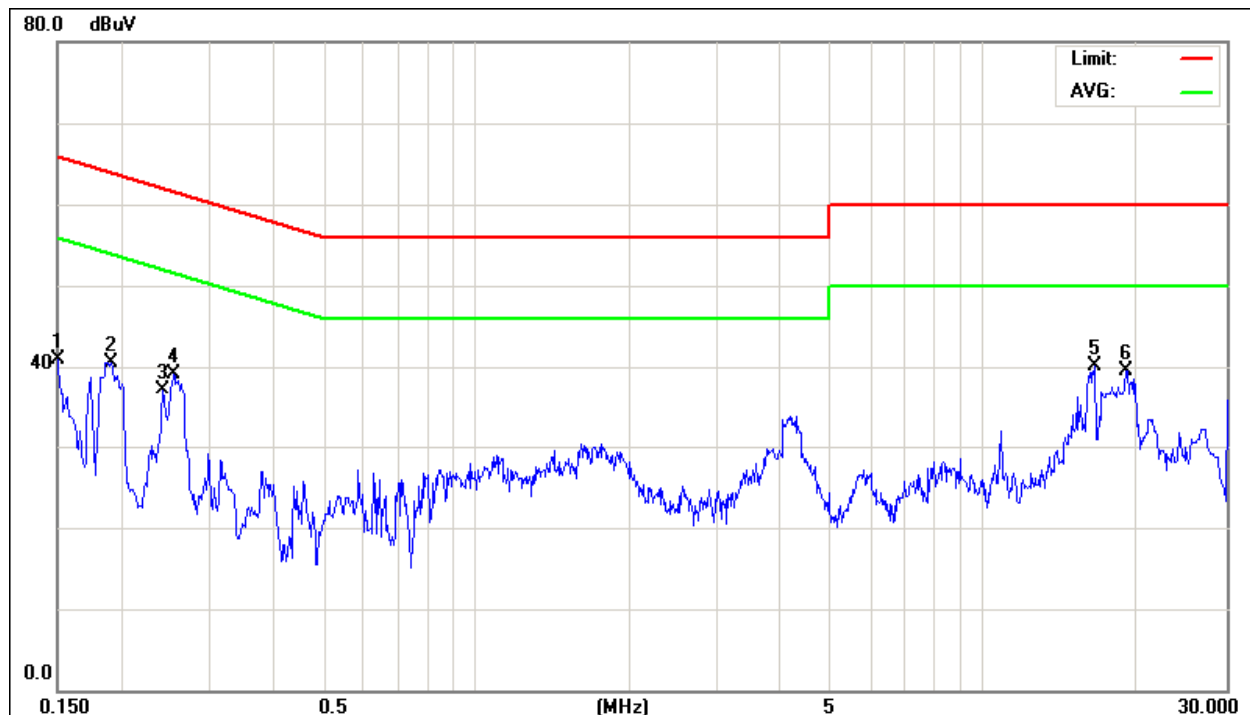



4.2 RADIATED EMISSION MEASUREMENT

4.2.1 RADIATED EMISSION LIMITS (FCC 15.209)

| Frequencies (MHz) | Field Strength (micorvolts/meter) | Measurement Distance (meters) |
|------------------------------|--|--|
| 0.009~0.490 | 2400/F(KHz) | 300 |
| 0.490~1.705 | 24000/F(KHz) | 30 |
| 1.705~30.0 | 30 | 30 |
| 30~88 | 100 | 3 |
| 88~216 | 150 | 3 |
| 216~960 | 200 | 3 |
| Above 960 | 500 | 3 |

Harmonic emissions limits comply with below 54 dBuV/m at 3m. Other emissions radiated outside of the specified frequency bands, except for harmonics, shall be attenuated by at least 50 dB below the level of the fundamental or comply with the radiated emissions limits specified in section 15.209(a) limit in the table below has to be followed.

Note:

- (1) The tighter limit applies at the band edges.
- (2) Emission level (dBuV/m)=20log Emission level (uV/m).

LIMITS OF RADIATED EMISSION MEASUREMENT (FCC 15.209)

| FREQUENCY (MHz) | (dBuV/m) (at 3m) | |
|------------------------|-------------------------|----------------|
| | PEAK | AVERAGE |
| Above 1000 | 74 | 54 |

Notes:

- (1) The limit for radiated test was performed according to FCC PART 15C.
- (2) The tighter limit applies at the band edges.
- (3) Emission level (dBuV/m)=20log Emission level (uV/m).

LIMITS OF RADIATED EMISSION MEASUREMENT (FCC Part 15.249)

| FCC Part15 (15.249) , Subpart C | |
|---|----------------------------------|
| Limit | Frequency Range (MHz) |
| Field strength of fundamental 50000 μV/m (94 dBμV/m) @ 3 m | 2400-2483.5 |
| Field strength of harmonics 500 μV/m (54 dBμV/m) @ 3 m | Above 2483.5 |



4.2.2 MEASUREMENT INSTRUMENTS LIST

| Item | Kind of Equipment | Manufacturer | Type No. | Serial No. | Calibrated until |
|------|-------------------------|--------------|-------------|------------|------------------|
| 1 | Triple Loop Antenna | R&S | HFH2-Z2 | 830749/020 | May.27.2011 |
| 2 | Bi-log Antenna | Schwarbeck | VULB9160 | 9160-3232 | May.26.2011 |
| 3 | Horn Antenna | ETS | 3115 | 00075789 | May.12.2011 |
| 4 | Broad-Band Horn Antenna | Schwarzbeck | BBHA 9170 | 9170340 | Dec.15.2011 |
| 5 | Amplifier | HP | 8447D | 2944A09673 | May.26.2011 |
| 6 | Amplifier | Agilent | 8449B | 3008A02274 | May.26.2011 |
| 7 | Amplifier | EMC | EMC2654045 | 980039 | Aug.12.2011 |
| 8 | Test Receiver | R&S | ESCI | 100895 | May.26.2011 |
| 9 | Spectrum Analyzer | R&S | FSP 40 | 100185 | Nov.26.2011 |
| 10 | Test Cable | N/A | C-01_CB03 | N/A | Jul.05.2011 |
| 11 | Test Cable | HUBER+SUHNER | SUCOFLEX_8m | 313794/4 | Apr.12.2011 |
| 12 | Controller | CT | SC100 | N/A | N/A |

Remark: " N/A" denotes No Model Name. / Serial No. and No Calibration specified.

| Spectrum Parameter | Setting |
|---------------------------------------|--|
| Attenuation | Auto |
| Start Frequency | 1000 MHz |
| Stop Frequency | 10th carrier harmonic |
| RB / VB (emission in restricted band) | 1 MHz / 1 MHz for Peak, Average=PK-dycty cycle |

| Receiver Parameter | Setting |
|------------------------|----------------------------------|
| Attenuation | Auto |
| Start ~ Stop Frequency | 9kHz~150kHz / RB 200Hz for QP |
| Start ~ Stop Frequency | 150kHz~30MHz / RB 9kHz for QP |
| Start ~ Stop Frequency | 30MHz~1000MHz / RB 120kHz for QP |



Neutron Engineering Inc.

DUTY CYCLE: TX 2418MHz (1Mbps)

Dwell time=ON/ON+OFF

ON: 0.32msec

ON+OFF: (total time):10.6msec

Dwell time: 3.02%

AV=PK+20 log(Dwell time)

AV=PK-30.4

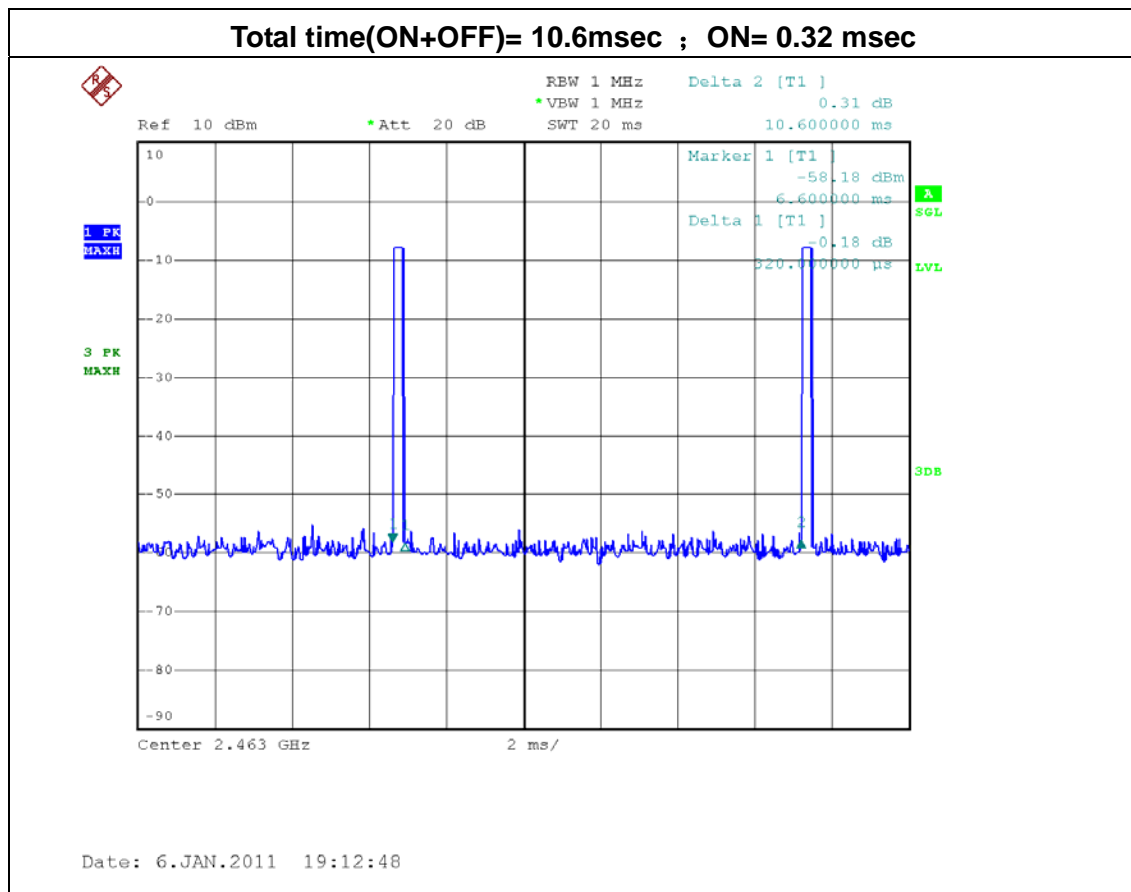



4.2.3 TEST PROCEDURE

- a. The measuring distance of at 3 m shall be used for measurements at frequency up to 1GHz. For frequencies above 1GHz, any suitable measuring distance may be used.
- b. The EUT was placed on the top of a rotating table 0.8 meters above the ground at a 3m meter semi-anechoic chamber. The table was rotated 360 degrees to determine the position of the highest radiation.
- c. The height of the equipment or of the substitution antenna shall be 0.8 m; the height of the test antenna shall vary between 1 m to 4 m. Both horizontal and vertical polarizations of the antenna are set to make the measurement.
- d. The initial step in collecting conducted emission data is a spectrum analyzer peak detector mode pre-scanning the measurement frequency range. Significant peaks are then marked and then Quasi Peak detector mode re-measured.
- e. If the Peak Mode measured value compliance with and lower than Quasi Peak Mode Limit, the EUT shall be deemed to meet QP Limits and then no additional QP Mode measurement performed.
- f. For the actual test configuration, please refer to the related Item –EUT Test Photos.

4.2.4 DEVIATION FROM TEST STANDARD

No deviation

4.2.5 TEST SETUP

(A) Radiated Emission Test Set-Up Frequency Below 1 GHz

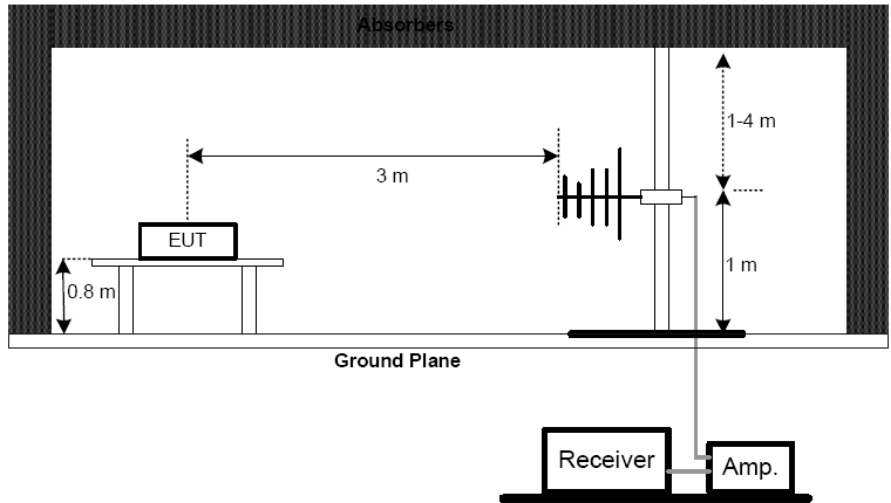

(B) Radiated Emission Test Set-Up Frequency Above 1 GHz

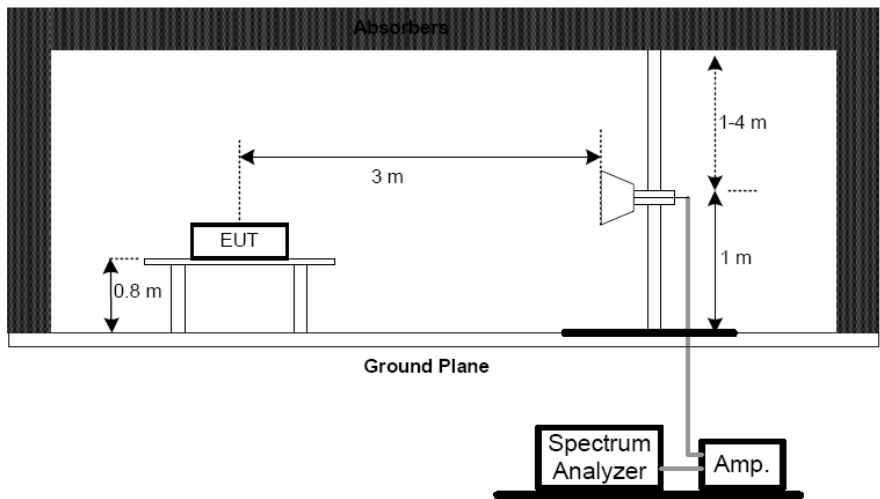

4.2.6 EUT OPERATING CONDITIONS

The EUT tested system was configured as the statements of 4.1.6 Unless otherwise a special operating condition is specified in the follows during the testing.



4.2.7 TEST RESULTS (BETWEEN 30 – 1000 MHz)

| | | | |
|---------------|--------------------------|---------------------|--------------|
| EUT : | 2.4GHz wireless receiver | Model Name. : | M01132-D |
| Temperature : | 23°C | Relative Humidity : | 58 % |
| Pressure : | 1001 hPa | Test Power : | AC 120V/60Hz |
| Test Mode : | TX 2418MHz | | |

| Freq. (MHz) | Ant. H/V | Reading(RA) (dBuV) | Corr.Factor(CF) (dB) | Measured(FS) (dBuV/m) | Limits(QP) (dBuV/m) | Margin (dB) | Note |
|-------------|----------|--------------------|----------------------|-----------------------|---------------------|-------------|------|
| 43.28 | V | 50.32 | -16.79 | 33.53 | 40.00 | - 6.47 | |
| 82.49 | V | 51.85 | -23.46 | 28.39 | 40.00 | - 11.61 | |
| 209.62 | V | 56.76 | -20.92 | 35.84 | 43.50 | - 7.66 | |
| 341.52 | V | 51.09 | -15.26 | 35.83 | 46.00 | - 10.17 | |
| 407.61 | V | 46.25 | -12.10 | 34.15 | 46.00 | - 11.85 | |
| 496.74 | V | 47.17 | -10.55 | 36.62 | 46.00 | - 9.38 | |

Remark :

- (1) All readings are Peak unless otherwise stated QP in column of 『Note』 . Peak denotes that the Peak reading compliance with the QP Limits and then QP Mode measurement didn't perform ◦
- (2) Measuring frequency range from 30MHz to 1000MHz or the 10th harmonic of highest fundamental frequency ◦ “F” denotes fundamental frequency; “ H” denotes spurious frequency. “E” denotes band edge frequency.
- (3) Radiated emissions measured in frequency range from 30 MHz to 1000 MHz were made with an instrument using Peak detector mode or QP detector mode of the emission ◦
- (4) Data of measurement within this frequency range shown “ - ” in the table above means the reading of emissions are attenuated more than 20dB below the permissible limits or the field strength is too small to be measured.

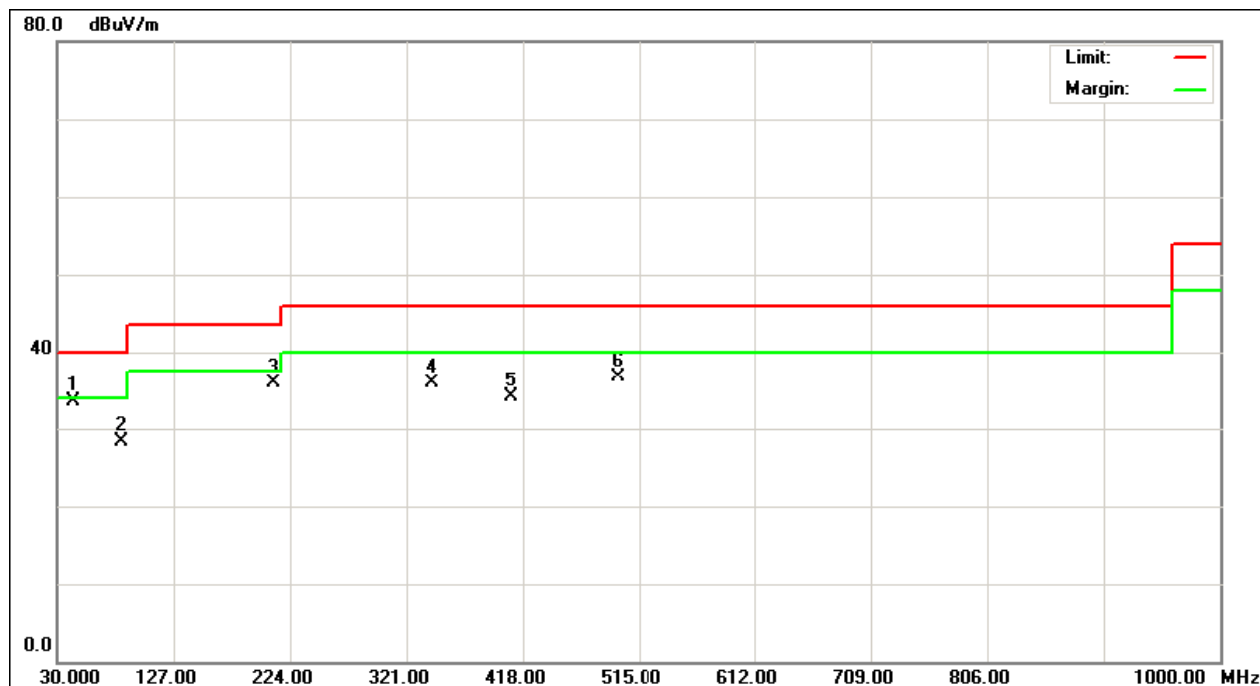



| | | | |
|---------------|--------------------------|---------------------|--------------|
| EUT : | 2.4GHz wireless receiver | Model Name. : | M01132-D |
| Temperature : | 23°C | Relative Humidity : | 58 % |
| Pressure : | 1001 hPa | Test Power : | AC 120V/60Hz |
| Test Mode : | TX 2418MHz | | |

| Freq. (MHz) | Ant. H/V | Reading(RA) (dBuV) | Corr.Factor(CF) (dB) | Measured(FS) (dBuV/m) | Limits(QP) (dBuV/m) | Margin (dB) | Note |
|-------------|----------|--------------------|----------------------|-----------------------|---------------------|-------------|------|
| 51.36 | H | 57.08 | -25.87 | 31.21 | 40.00 | - 8.79 | |
| 116.42 | H | 56.28 | -22.64 | 33.64 | 43.50 | - 9.86 | |
| 216.03 | H | 54.91 | -20.35 | 34.56 | 46.00 | - 11.44 | |
| 243.64 | H | 49.18 | -17.09 | 32.09 | 46.00 | - 13.91 | |
| 331.53 | H | 53.30 | -15.24 | 38.06 | 46.00 | - 7.94 | |
| 401.65 | H | 45.24 | -12.10 | 33.14 | 46.00 | - 12.86 | |

Remark :

- (1) All readings are Peak unless otherwise stated QP in column of 『Note』 . Peak denotes that the Peak reading compliance with the QP Limits and then QP Mode measurement didn't perform ◦
- (2) Measuring frequency range from 30MHz to 1000MHz or the 10th harmonic of highest fundamental frequency ◦ “F” denotes fundamental frequency; “ H” denotes spurious frequency. “E” denotes band edge frequency.
- (3) Radiated emissions measured in frequency range from 30 MHz to 1000 MHz were made with an instrument using Peak detector mode or QP detector mode of the emission ◦
- (4) Data of measurement within this frequency range shown “ - ” in the table above means the reading of emissions are attenuated more than 20dB below the permissible limits or the field strength is too small to be measured.

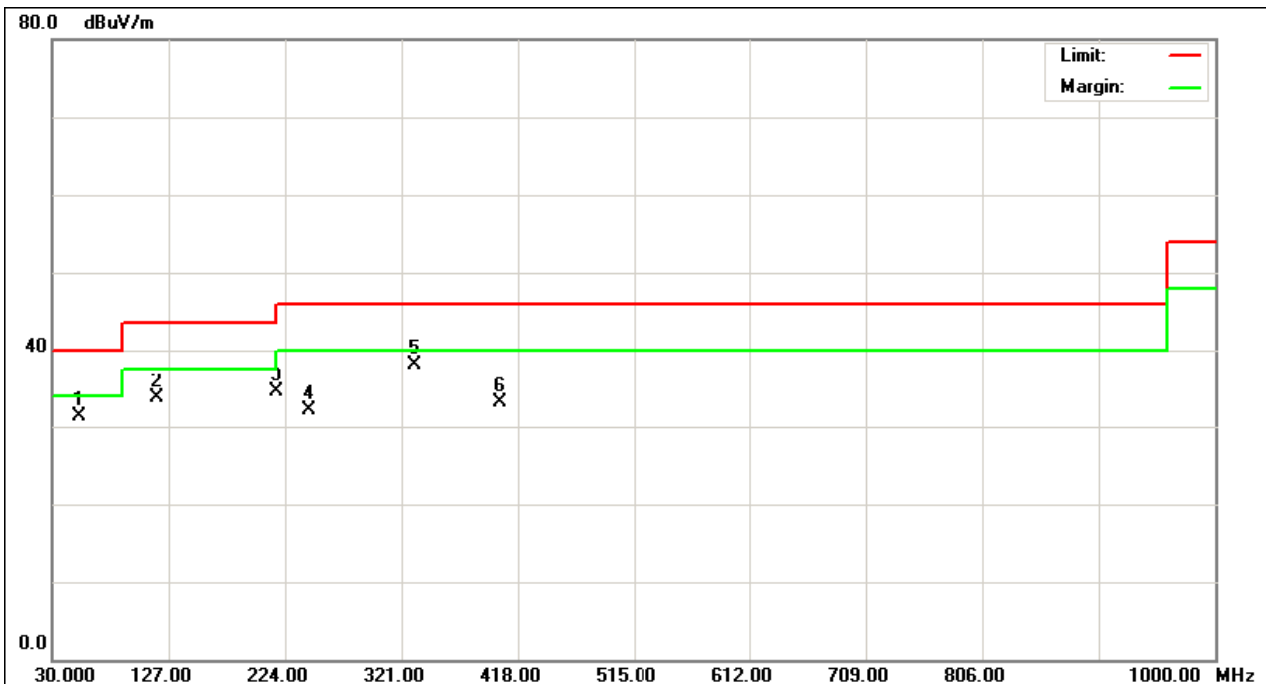



4.2.8 TEST RESULTS (ABOVE 1000 MHz)

| | | | |
|---------------|--------------------------|---------------------|--------------|
| EUT : | 2.4GHz wireless receiver | Model Name. : | M01132-D |
| Temperature : | 23°C | Relative Humidity : | 58 % |
| Pressure : | 1001 hPa | Test Power : | AC 120V/60Hz |
| Test Mode : | TX 2418MHz | | |

| Freq. (MHz) | Ant.Pol. H/V | Reading | | Ant./CF CF(dB) | Act. | | Limit | | Note |
|----------------|-----------------|----------------|--------------|-------------------|------------------|----------------|------------------|----------------|------------|
| | | Peak (dBuV) | AV (dBuV) | | Peak (dBuV/m) | AV (dBuV/m) | Peak (dBuV/m) | AV (dBuV/m) | |
| 2390.00 | V | 23.34 | -12.94 | 31.54 | 54.88 | 18.60 | 74.00 | 54.00 | X/E |
| 2417.80 | V | 59.55 | 29.13 | 31.58 | 91.13 | 60.73 | 114.00 | 94.00 | X/F |
| 4836.27 | V | 48.62 | 18.22 | 6.03 | 54.65 | 24.25 | 74.00 | 54.00 | X/H |

Remark :

- (1) All readings are Peak unless otherwise stated QP in column of 『Note』 . Peak denotes that the Peak reading compliance with the QP Limits and then QP Mode measurement didn't perform ◦
- (2) Measuring frequency range from 30MHz to 1000MHz or the 10th harmonic of highest fundamental frequency ◦ “F” denotes fundamental frequency; “H” denotes spurious frequency. “E” denotes band edge frequency. (This judgment method includes the Band Edge Requirement.)
- (3) Radiated emissions measured in frequency range above 1000MHz were made with an instrument using Peak detector mode and AV detector mode of the emission ◦
- (4) Data of measurement within this frequency range shown “ * ” in the table above means the reading of emissions are attenuated more than 20dB below the permissible limits or the field strength is too small to be measured.
- (5) A preamp and high pass filter were used for this test in order to provide sufficient measurement sensitivity.
- (6) EUT Orthogonal Axis :
“X” - denotes Laid on Table ; ”Y” - denotes Vertical Stand ; ”Z” - denotes Side Stand
- (7) During the measurements above 1 GHz it is taken care of that the EUT is always within the 3 dB cone of radiation BW of the used antenna
- (8) The average value of fundamental frequency is:
Average = Peak value + 20log(Duty cycle) ◦ Final AV=PK-30.4



Orthogonal Axis : X
TX 2418MHz (Above 1000 MHz, Vertical)

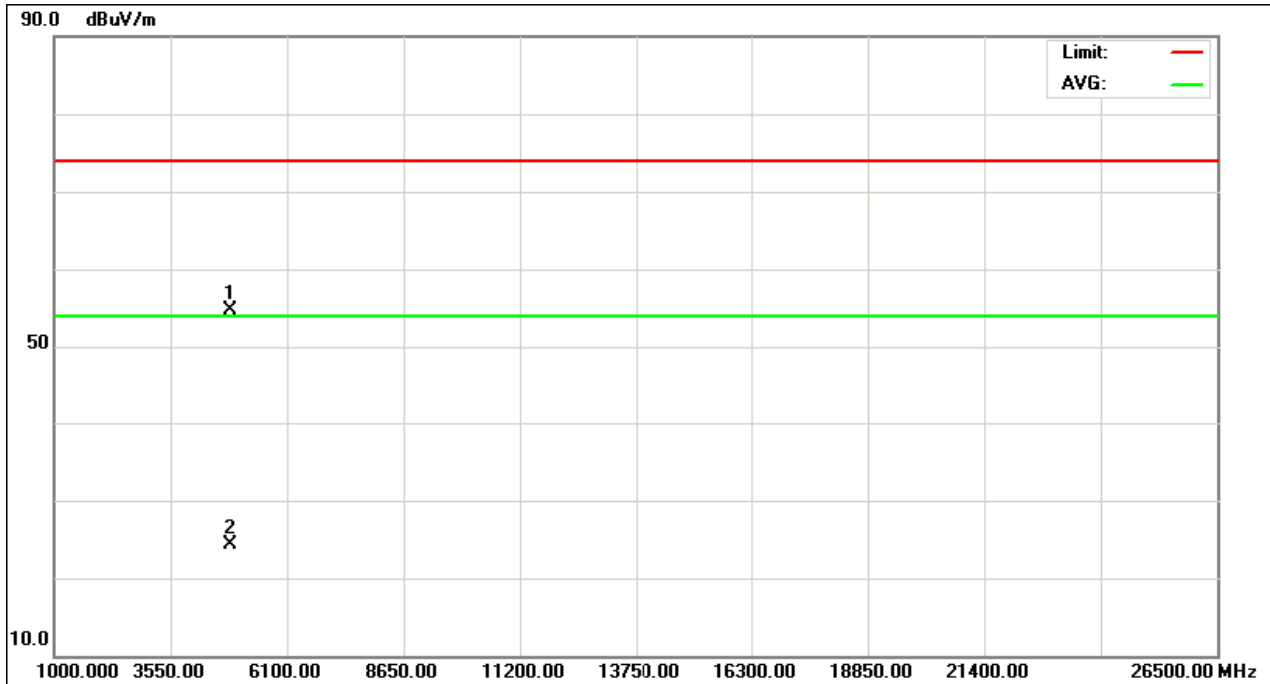
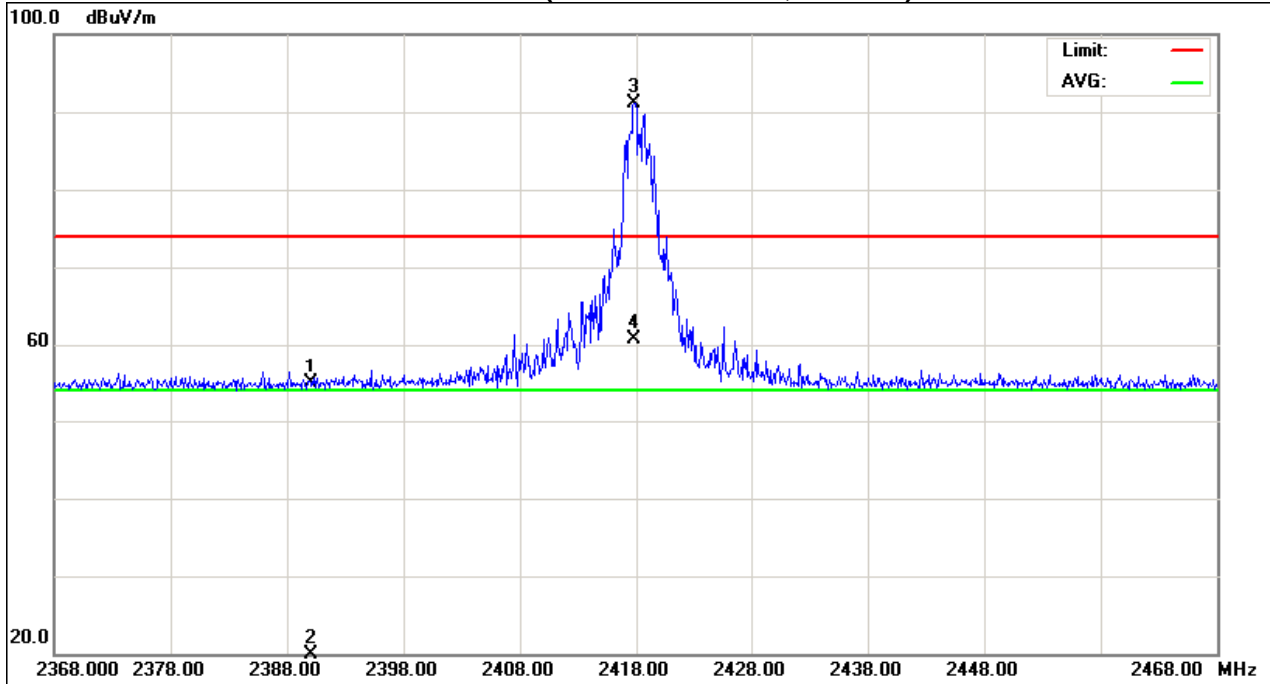



| | | | |
|---------------|--------------------------|---------------------|--------------|
| EUT : | 2.4GHz wireless receiver | Model Name. : | M01132-D |
| Temperature : | 23°C | Relative Humidity : | 58 % |
| Pressure : | 1001 hPa | Test Power : | AC 120V/60Hz |
| Test Mode : | TX 2418MHz | | |

| Freq. (MHz) | Ant.Pol. H/V | Reading | | Ant./CF CF(dB) | Act. | | Limit | | Note |
|----------------|-----------------|----------------|--------------|-------------------|------------------|----------------|------------------|----------------|------------|
| | | Peak (dBuV) | AV (dBuV) | | Peak (dBuV/m) | AV (dBuV/m) | Peak (dBuV/m) | AV (dBuV/m) | |
| 2390.00 | H | 23.55 | -13.15 | 31.54 | 55.09 | 18.39 | 74.00 | 54.00 | X/E |
| 2418.70 | H | 61.09 | 30.69 | 31.58 | 92.67 | 62.27 | 114.00 | 94.00 | X/F |
| 4836.27 | H | 50.37 | 19.97 | 6.03 | 56.40 | 26.00 | 74.00 | 54.00 | X/H |

Remark :

- (1) All readings are Peak unless otherwise stated QP in column of 『Note』 . Peak denotes that the Peak reading compliance with the QP Limits and then QP Mode measurement didn't perform ◦
- (2) Measuring frequency range from 30MHz to 1000MHz or the 10th harmonic of highest fundamental frequency ◦ "F" denotes fundamental frequency; "H" denotes spurious frequency. "E" denotes band edge frequency. (This judgment method includes the Band Edge Requirement.)
- (3) Radiated emissions measured in frequency range above 1000MHz were made with an instrument using Peak detector mode and AV detector mode of the emission ◦
- (4) Data of measurement within this frequency range shown " * " in the table above means the reading of emissions are attenuated more than 20dB below the permissible limits or the field strength is too small to be measured.
- (5) A preamp and high pass filter were used for this test in order to provide sufficient measurement sensitivity.
- (6) EUT Orthogonal Axis :
"X" - denotes Laid on Table ; "Y" - denotes Vertical Stand ; "Z" - denotes Side Stand
- (7) During the measurements above 1 GHz it is taken care of that the EUT is always within the 3 dB cone of radiation BW of the used antenna
- (8) The average value of fundamental frequency is:
Average = Peak value + 20log(Duty cycle) ◦ Final AV=PK-30.4



Orthogonal Axis : X
TX 2418MHz (Above 1000 MHz, Horizontal)

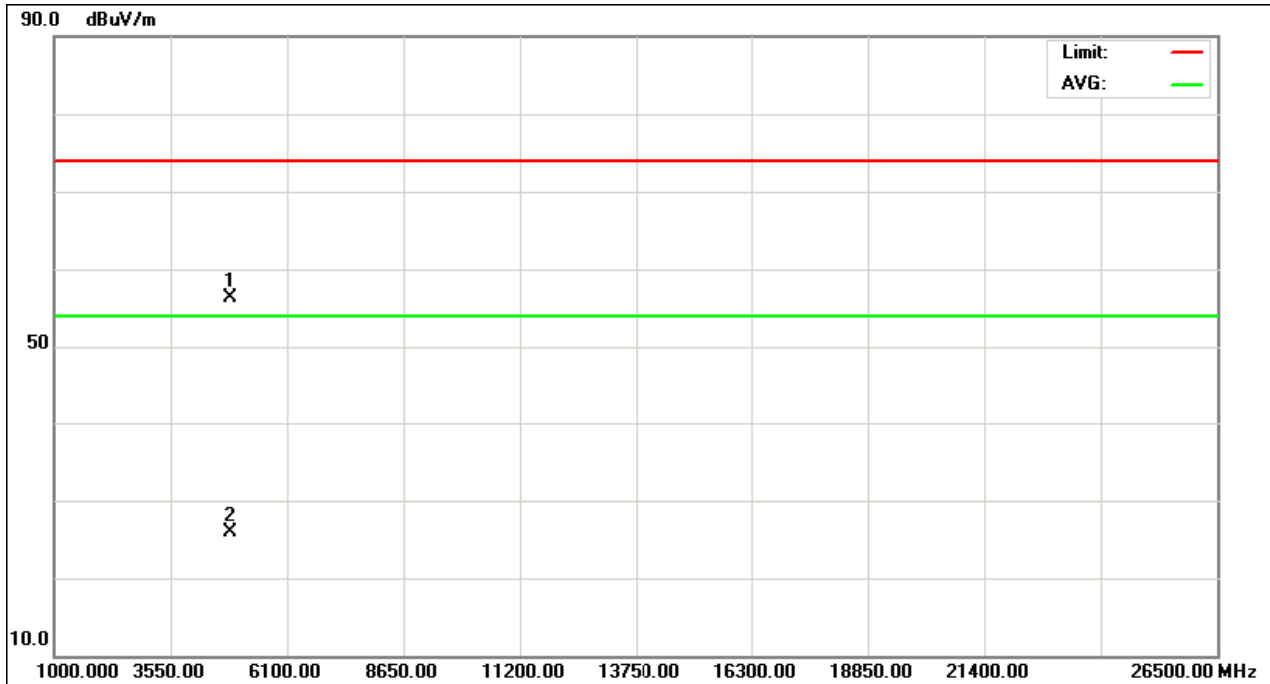
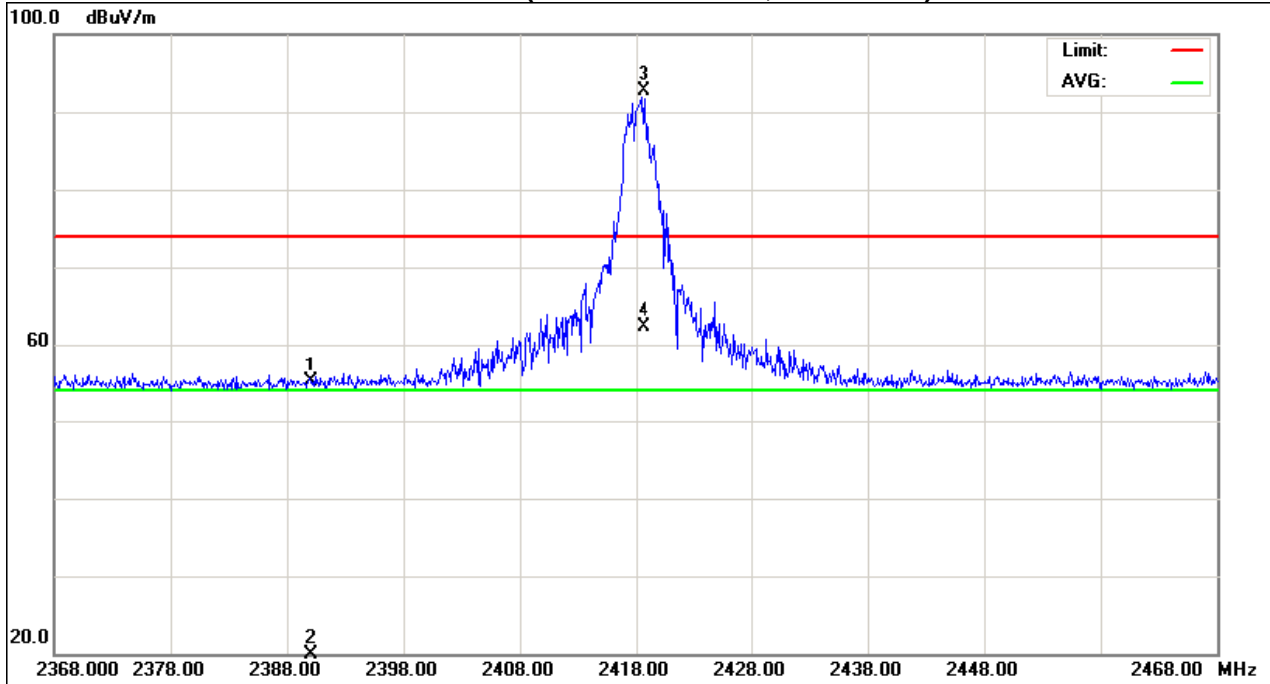



| | | | |
|---------------|--------------------------|---------------------|--------------|
| EUT : | 2.4GHz wireless receiver | Model Name. : | M01132-D |
| Temperature : | 23°C | Relative Humidity : | 58 % |
| Pressure : | 1001 hPa | Test Power : | AC 120V/60Hz |
| Test Mode : | TX 2442MHz | | |

| Freq. (MHz) | Ant. Pol. H/V | Reading | | Ant./CF CF(dB) | Act. | | Limit | | Note |
|----------------|------------------|----------------|--------------|-------------------|------------------|----------------|------------------|----------------|------------|
| | | Peak (dBuV) | AV (dBuV) | | Peak (dBuV/m) | AV (dBuV/m) | Peak (dBuV/m) | AV (dBuV/m) | |
| 2441.70 | V | 58.52 | 28.12 | 31.63 | 90.15 | 59.75 | 114.00 | 94.00 | X/F |
| 4883.96 | V | 49.61 | 19.21 | 6.18 | 55.79 | 25.39 | 74.00 | 54.00 | X/H |

Remark :

- (1) All readings are Peak unless otherwise stated QP in column of 『Note』 . Peak denotes that the Peak reading compliance with the QP Limits and then QP Mode measurement didn't perform ◦
- (2) Measuring frequency range from 30MHz to 1000MHz or the 10th harmonic of highest fundamental frequency ◦ "F" denotes fundamental frequency; "H" denotes spurious frequency. "E" denotes band edge frequency. (This judgment method includes the Band Edge Requirement.)
- (3) Radiated emissions measured in frequency range above 1000MHz were made with an instrument using Peak detector mode and AV detector mode of the emission ◦
- (4) Data of measurement within this frequency range shown " * " in the table above means the reading of emissions are attenuated more than 20dB below the permissible limits or the field strength is too small to be measured.
- (5) A preamp and high pass filter were used for this test in order to provide sufficient measurement sensitivity.
- (6) EUT Orthogonal Axis :
"X" - denotes Laid on Table ; "Y" - denotes Vertical Stand ; "Z" - denotes Side Stand
- (7) During the measurements above 1 GHz it is taken care of that the EUT is always within the 3 dB cone of radiation BW of the used antenna
- (8) The average value of fundamental frequency is:
Average = Peak value + 20log(Duty cycle) ◦ Final AV=PK-30.4



Orthogonal Axis : X
TX 2442 MHz (Above 1000 MHz, Vertical)

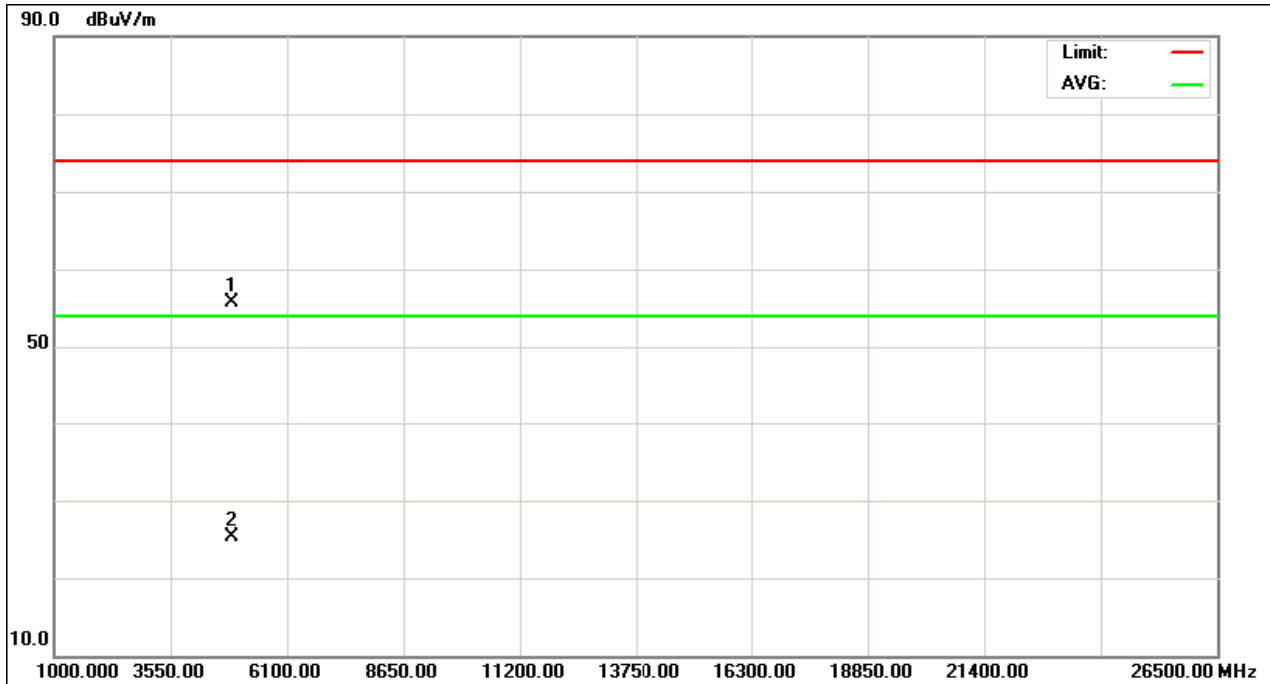
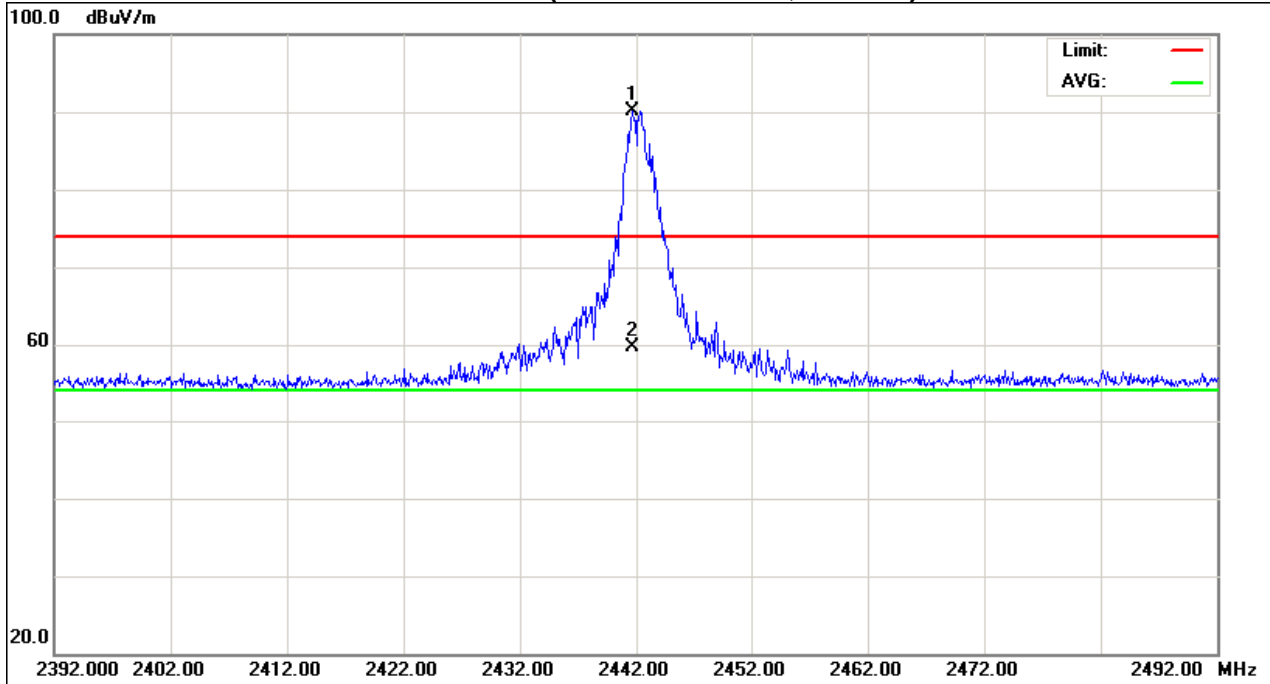



| | | | |
|---------------|--------------------------|---------------------|--------------|
| EUT : | 2.4GHz wireless receiver | Model Name. : | M01132-D |
| Temperature : | 23°C | Relative Humidity : | 58 % |
| Pressure : | 1001 hPa | Test Power : | AC 120V/60Hz |
| Test Mode : | TX 2442MHz | | |

| Freq. (MHz) | Ant.Pol. H/V | Reading | | Ant./CF CF(dB) | Act. | | Limit | | Note |
|----------------|-----------------|----------------|--------------|-------------------|------------------|----------------|------------------|----------------|------------|
| | | Peak (dBuV) | AV (dBuV) | | Peak (dBuV/m) | AV (dBuV/m) | Peak (dBuV/m) | AV (dBuV/m) | |
| 2442.30 | H | 61.09 | 0.69 | 31.63 | 92.72 | 62.32 | 114.00 | 94.00 | X/F |
| 4883.96 | H | 51.37 | 20.97 | 6.18 | 57.55 | 27.15 | 74.00 | 54.00 | X/H |

Remark :

- (1) All readings are Peak unless otherwise stated QP in column of 『Note』 . Peak denotes that the Peak reading compliance with the QP Limits and then QP Mode measurement didn't perform ◦
- (2) Measuring frequency range from 30MHz to 1000MHz or the 10th harmonic of highest fundamental frequency ◦ "F" denotes fundamental frequency; "H" denotes spurious frequency. "E" denotes band edge frequency. (This judgment method includes the Band Edge Requirement.)
- (3) Radiated emissions measured in frequency range above 1000MHz were made with an instrument using Peak detector mode and AV detector mode of the emission ◦
- (4) Data of measurement within this frequency range shown " * " in the table above means the reading of emissions are attenuated more than 20dB below the permissible limits or the field strength is too small to be measured.
- (5) A preamp and high pass filter were used for this test in order to provide sufficient measurement sensitivity.
- (6) EUT Orthogonal Axis :
"X" - denotes Laid on Table ; "Y" - denotes Vertical Stand ; "Z" - denotes Side Stand
- (7) During the measurements above 1 GHz it is taken care of that the EUT is always within the 3 dB cone of radiation BW of the used antenna
- (8) The average value of fundamental frequency is:
Average = Peak value + 20log(Duty cycle) ◦ Final AV=PK-30.4



Orthogonal Axis : X
TX 2442MHz (Above 1000 MHz, Horizontal)

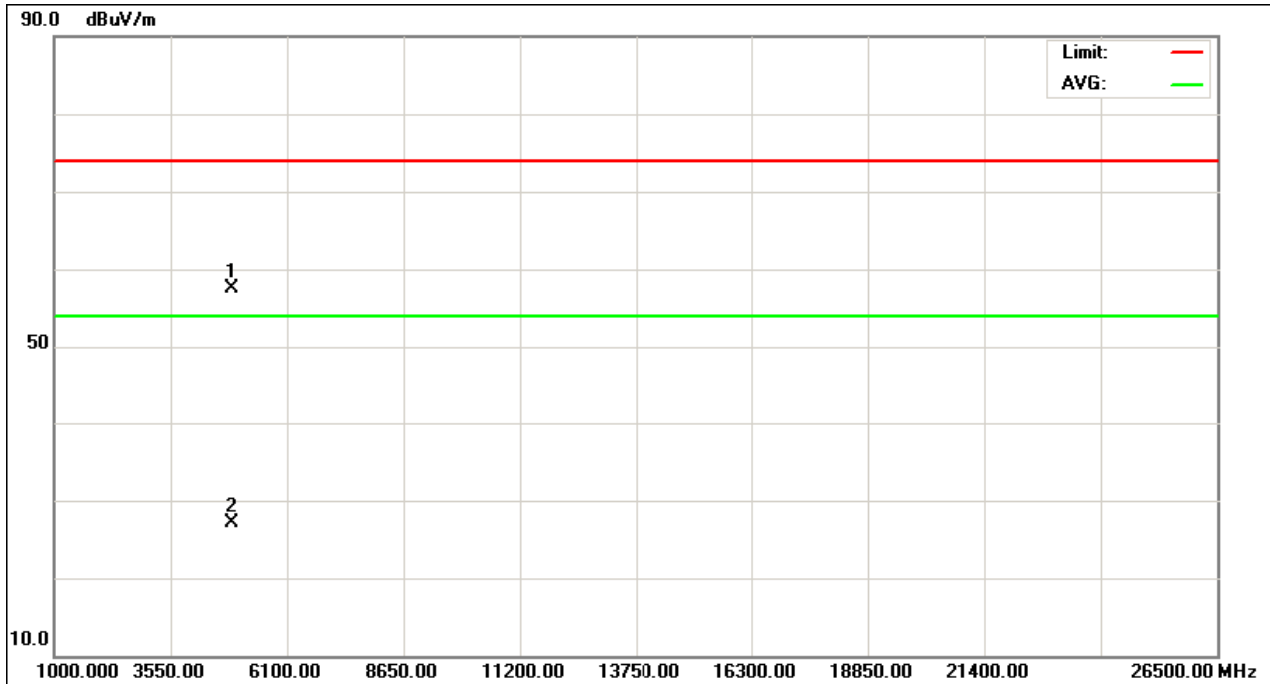
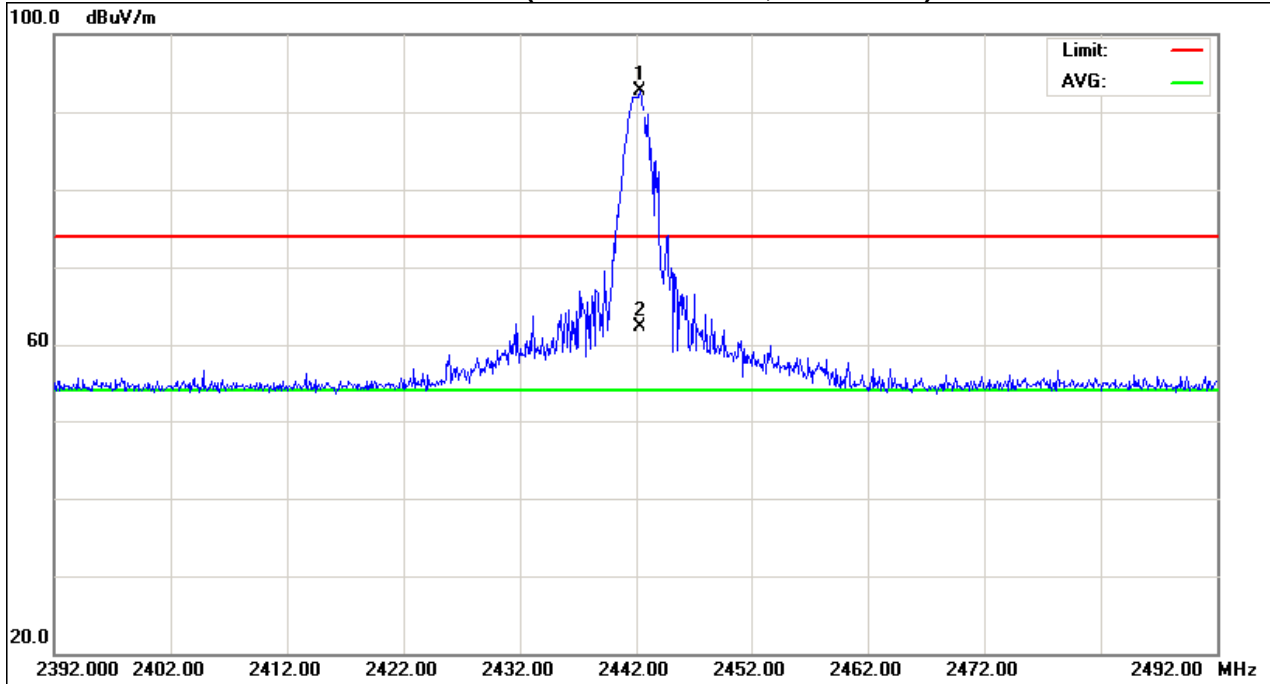



| | | | |
|---------------|--------------------------|---------------------|--------------|
| EUT : | 2.4GHz wireless receiver | Model Name. : | M01132-D |
| Temperature : | 23°C | Relative Humidity : | 58 % |
| Pressure : | 1001 hPa | Test Power : | AC 120V/60Hz |
| Test Mode : | TX 2463MHz | | |

| Freq. (MHz) | Ant.Pol. H/V | Reading | | Ant./CF CF(dB) | Act. | | Limit | | Note |
|----------------|-----------------|----------------|--------------|-------------------|------------------|----------------|------------------|----------------|------------|
| | | Peak (dBuV) | AV (dBuV) | | Peak (dBuV/m) | AV (dBuV/m) | Peak (dBuV/m) | AV (dBuV/m) | |
| 2463.50 | V | 60.42 | 30.02 | 31.66 | 92.08 | 61.68 | 114.00 | 94.00 | X/F |
| 2483.50 | V | 23.72 | -10.32 | 31.70 | 55.42 | 21.38 | 74.00 | 54.00 | X/E |
| 4925.83 | V | 49.18 | 18.78 | 6.30 | 55.48 | 25.08 | 74.00 | 54.00 | X/H |

Remark :

- (1) All readings are Peak unless otherwise stated QP in column of 『Note』 . Peak denotes that the Peak reading compliance with the QP Limits and then QP Mode measurement didn't perform ◦
- (2) Measuring frequency range from 30MHz to 1000MHz or the 10th harmonic of highest fundamental frequency ◦ "F" denotes fundamental frequency; "H" denotes spurious frequency. "E" denotes band edge frequency. (This judgment method includes the Band Edge Requirement.)
- (3) Radiated emissions measured in frequency range above 1000MHz were made with an instrument using Peak detector mode and AV detector mode of the emission ◦
- (4) Data of measurement within this frequency range shown " * " in the table above means the reading of emissions are attenuated more than 20dB below the permissible limits or the field strength is too small to be measured.
- (5) A preamp and high pass filter were used for this test in order to provide sufficient measurement sensitivity.
- (6) EUT Orthogonal Axis :
"X" - denotes Laid on Table ; "Y" - denotes Vertical Stand ; "Z" - denotes Side Stand
- (7) During the measurements above 1 GHz it is taken care of that the EUT is always within the 3 dB cone of radiation BW of the used antenna
- (8) The average value of fundamental frequency is:
Average = Peak value + 20log(Duty cycle) ◦ Final AV=PK-30.4



Orthogonal Axis : X
TX 2463MHz (Above 1000 MHz, Vertical)

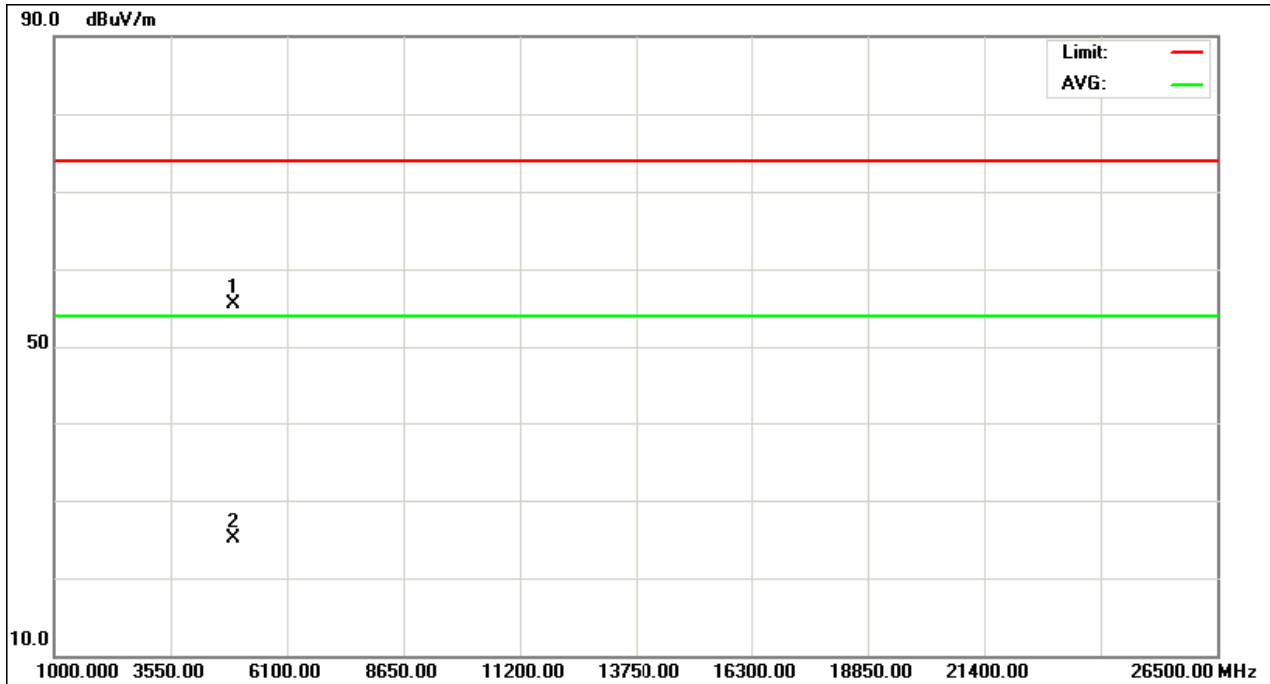
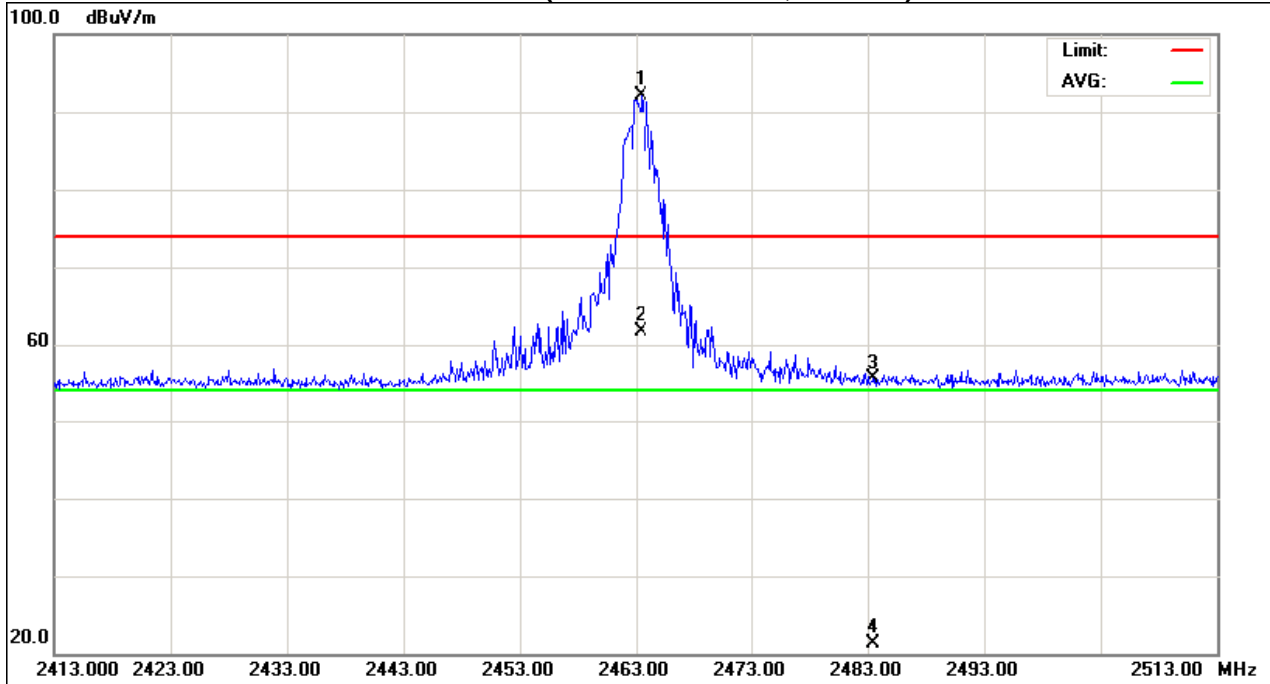



| | | | |
|---------------|--------------------------|---------------------|--------------|
| EUT : | 2.4GHz wireless receiver | Model Name. : | M01132-D |
| Temperature : | 23°C | Relative Humidity : | 58 % |
| Pressure : | 1001 hPa | Test Power : | AC 120V/60Hz |
| Test Mode : | TX 2463MHz | | |

| Freq. (MHz) | Ant.Pol. H/V | Reading | | Ant./CF CF(dB) | Act. | | Limit | | Note |
|----------------|-----------------|----------------|--------------|-------------------|------------------|----------------|------------------|----------------|------------|
| | | Peak (dBuV) | AV (dBuV) | | Peak (dBuV/m) | AV (dBuV/m) | Peak (dBuV/m) | AV (dBuV/m) | |
| 2463.00 | H | 62.59 | 32.19 | 31.66 | 94.25 | 63.85 | 114.00 | 94.00 | X/F |
| 2483.50 | H | 23.28 | -12.88 | 31.70 | 54.98 | 18.82 | 74.00 | 54.00 | X/E |
| 4925.89 | H | 50.96 | 20.56 | 6.30 | 57.26 | 28.86 | 74.00 | 54.00 | X/H |

Remark :

- (1) All readings are Peak unless otherwise stated QP in column of 『Note』 . Peak denotes that the Peak reading compliance with the QP Limits and then QP Mode measurement didn't perform ◦
- (2) Measuring frequency range from 30MHz to 1000MHz or the 10th harmonic of highest fundamental frequency ◦ "F" denotes fundamental frequency; "H" denotes spurious frequency. "E" denotes band edge frequency. (This judgment method includes the Band Edge Requirement.)
- (3) Radiated emissions measured in frequency range above 1000MHz were made with an instrument using Peak detector mode and AV detector mode of the emission ◦
- (4) Data of measurement within this frequency range shown " * " in the table above means the reading of emissions are attenuated more than 20dB below the permissible limits or the field strength is too small to be measured.
- (5) A preamp and high pass filter were used for this test in order to provide sufficient measurement sensitivity.
- (6) EUT Orthogonal Axis :
"X" - denotes Laid on Table ; "Y" - denotes Vertical Stand ; "Z" - denotes Side Stand
- (7) During the measurements above 1 GHz it is taken care of that the EUT is always within the 3 dB cone of radiation BW of the used antenna
- (8) The average value of fundamental frequency is:
Average = Peak value + 20log(Duty cycle) ◦ Final AV=PK-30.4



Orthogonal Axis : X
TX 2463MHz (Above 1000 MHz, Horizontal)

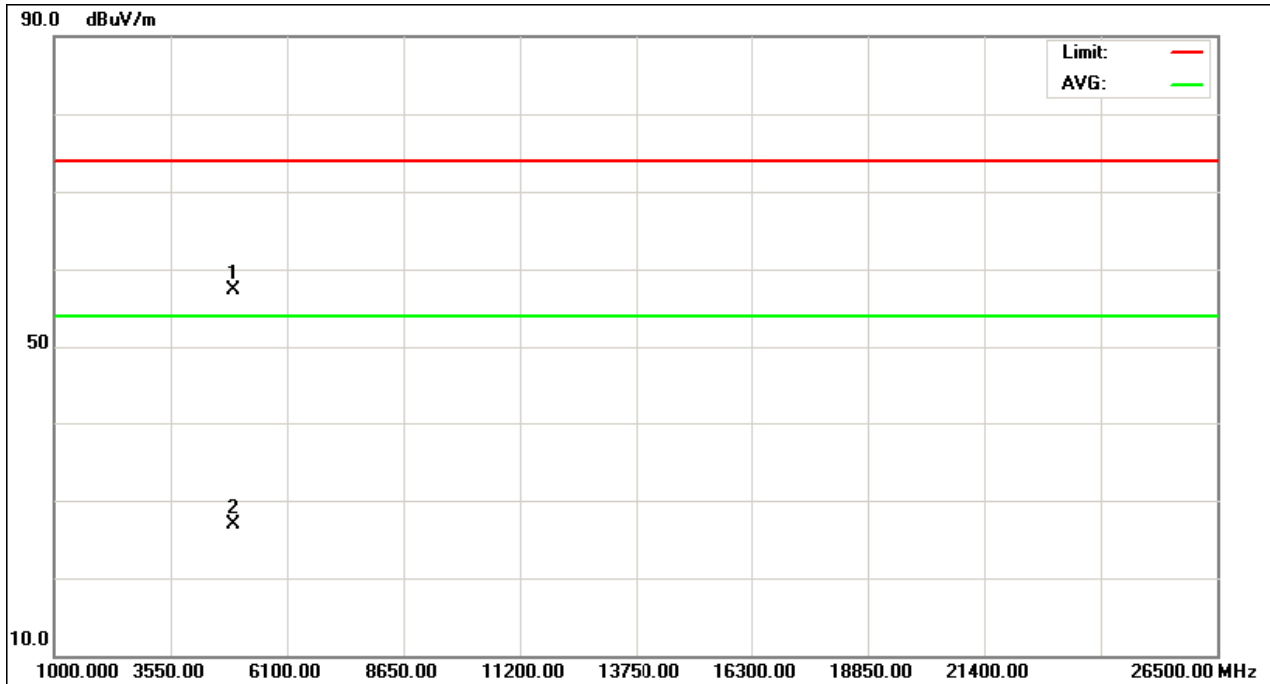
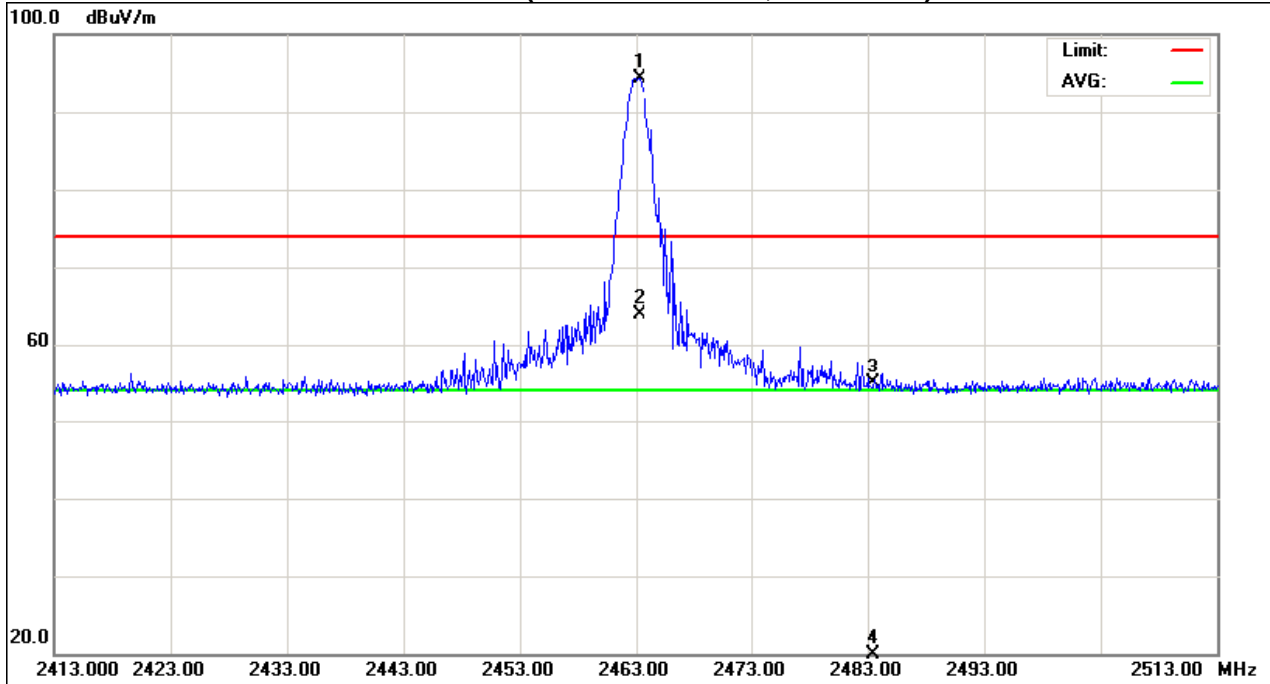



4.2.9 TEST RESULTS (2400 – 2483.5 MHz)

| | | | |
|---------------|-------------------------------|---------------------|--------------|
| EUT : | 2.4GHz wireless receiver | Model Name. : | M01132-D |
| Temperature : | 23°C | Relative Humidity : | 58 % |
| Pressure : | 1001 hPa | Test Power : | AC 120V/60Hz |
| Test Mode : | TX CH 2418MHz/2442MHz/2463MHz | | |

| Freq. (MHz) | Ant. Pol. (H/V) | Peak | | Ant./CL/ CF(dB) | AV | | Peak | | AV | | NOTE |
|----------------|--------------------|-------------------|--------|--------------------|-----------------------|----------|---------------------|----------|------|--|------|
| | | Reading (dBuV) | (dBuV) | | Actual FS (dBuV/m) | (dBuV/m) | Limit3m (dBuV/m) | (dBuV/m) | | | |
| 2417.80 | V | 59.55 | 29.15 | 31.58 | 91.13 | 60.73 | 114.00 | 94.00 | CH01 | | |
| 2418.70 | H | 61.09 | 30.69 | 31.58 | 92.67 | 62.27 | 114.00 | 94.00 | CH01 | | |
| 2441.70 | V | 58.52 | 28.12 | 31.63 | 90.15 | 59.75 | 114.00 | 94.00 | CH09 | | |
| 2442.30 | H | 61.09 | 30.69 | 31.63 | 92.72 | 62.32 | 114.00 | 94.00 | CH09 | | |
| 2463.50 | V | 60.42 | 30.02 | 31.66 | 92.08 | 61.68 | 114.00 | 94.00 | CH16 | | |
| 2463.30 | H | 62.59 | 32.19 | 31.66 | 94.25 | 63.85 | 114.00 | 94.00 | CH16 | | |

Remark :

- (1) All readings are Peak unless otherwise stated QP in column of 『Note』 . Peak denotes that the Peak reading compliance with the QP Limits and then QP Mode measurement didn't perform ◦
- (2) Radiated emissions measured in frequency range above 1000MHz were made with an instrument using Peak detector mode and AV detector mode of the emission ◦
- (3) Data of measurement within this frequency range shown “ * ” in the table above means the reading of emissions are attenuated more than 20dB below the permissible limits or the field strength is too small to be measured.
- (4) EUT Orthogonal Axis :
 “X” - denotes Laid on Table ; “Y” - denotes Vertical Stand ; “Z” - denotes Side Stand
- (5) The average value of fundamental frequency is:
 Average = Peak value + 20log(Duty cycle) ◦ Final AV=PK-30.4



5. BANDWIDTH TEST

5.1 MEASUREMENT INSTRUMENTS LIST

| Item | Kind of Equipment | Manufacturer | Type No. | Serial No. | Calibrated until |
|------|-------------------|--------------|----------|------------|------------------|
| 1 | Spectrum Analyzer | R&S | FSP 40 | 100185 | Nov.26.2011 |

Remark: " N/A" denotes No Model Name. , Serial No. or No Calibration specified.

5.2 TEST PROCEDURE

- a. The EUT was directly connected to the spectrum analyzer and antenna output port as show in the block diagram below,
- b. Spectrum Setting : RBW= 100KHz, VBW=100KHz, Sweep time = 20 ms.

5.3 DEVIATION FROM STANDARD

No deviation.

5.4 TEST SETUP

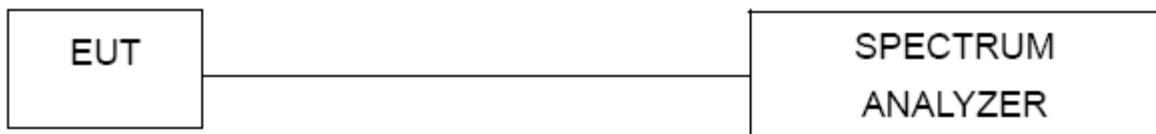

5.5 EUT OPERATION CONDITIONS

The EUT tested system was configured as the statements of 4.1.6 Unless otherwise a special operating condition is specified in the follows during the testing.



5.6 TEST RESULTS

| | | | |
|---------------|--------------------------|---------------------|--------------|
| EUT : | 2.4GHz wireless receiver | Model Name. : | M01132-D |
| Temperature : | 20°C | Relative Humidity : | 58 % |
| Pressure : | 1001 hPa | Test Power : | AC 120V/60Hz |
| Test Mode : | TX CH 01/09/16 | | |

| Test Channel | Frequency (MHz) | 20 dBc Bandwidth (MHz) |
|--------------|-----------------|------------------------|
| CH01 | 2418 | 1.2670 |
| CH09 | 2442 | 1.3070 |
| CH16 | 2463 | 1.3070 |

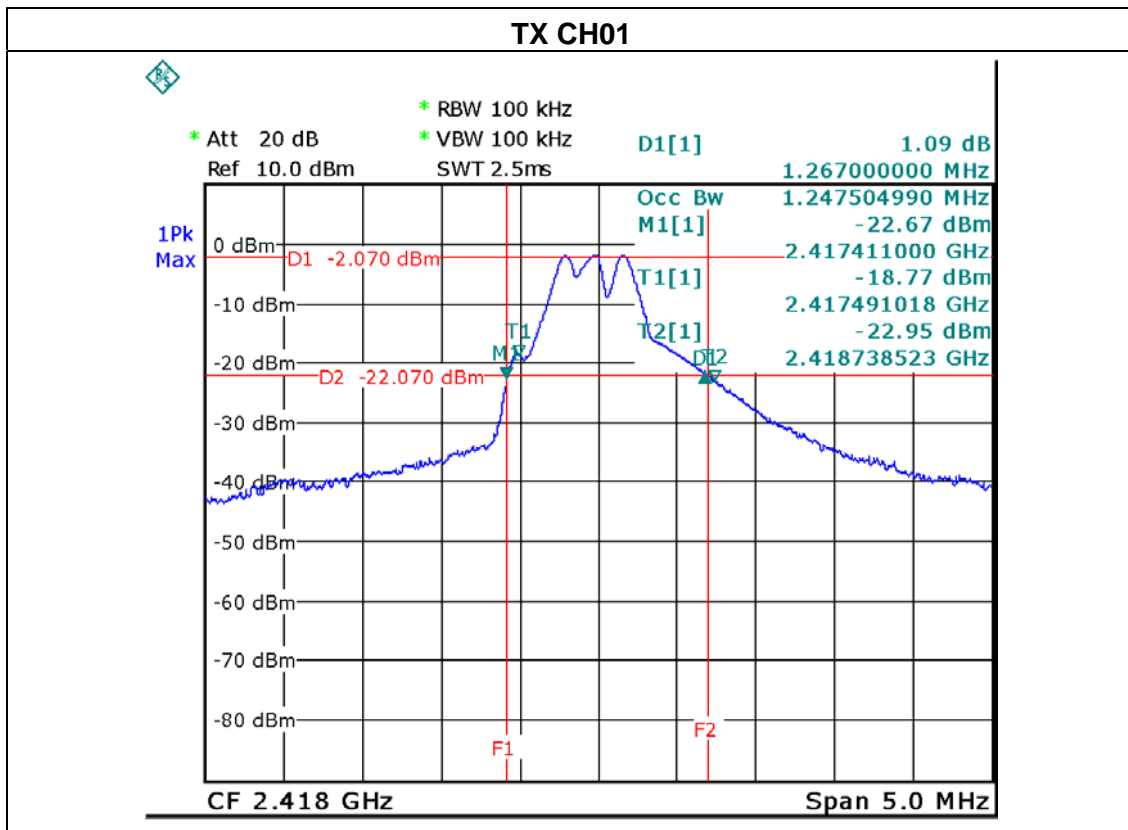

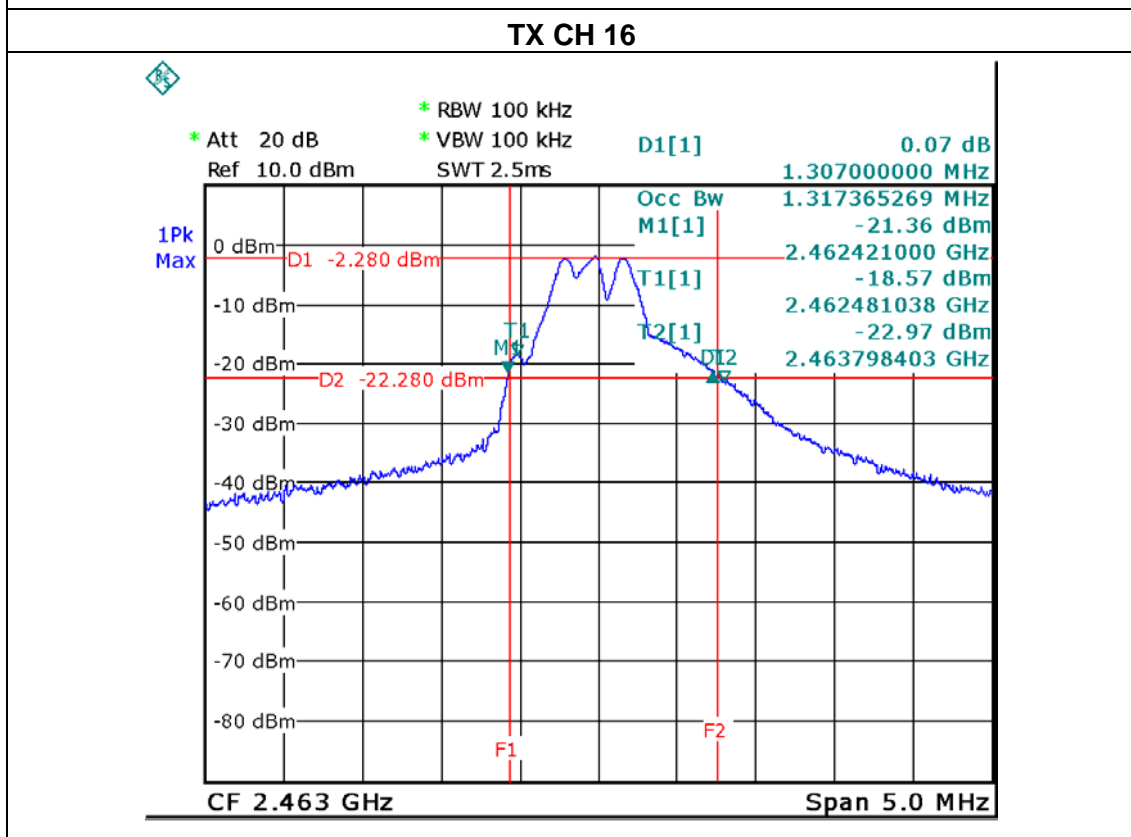
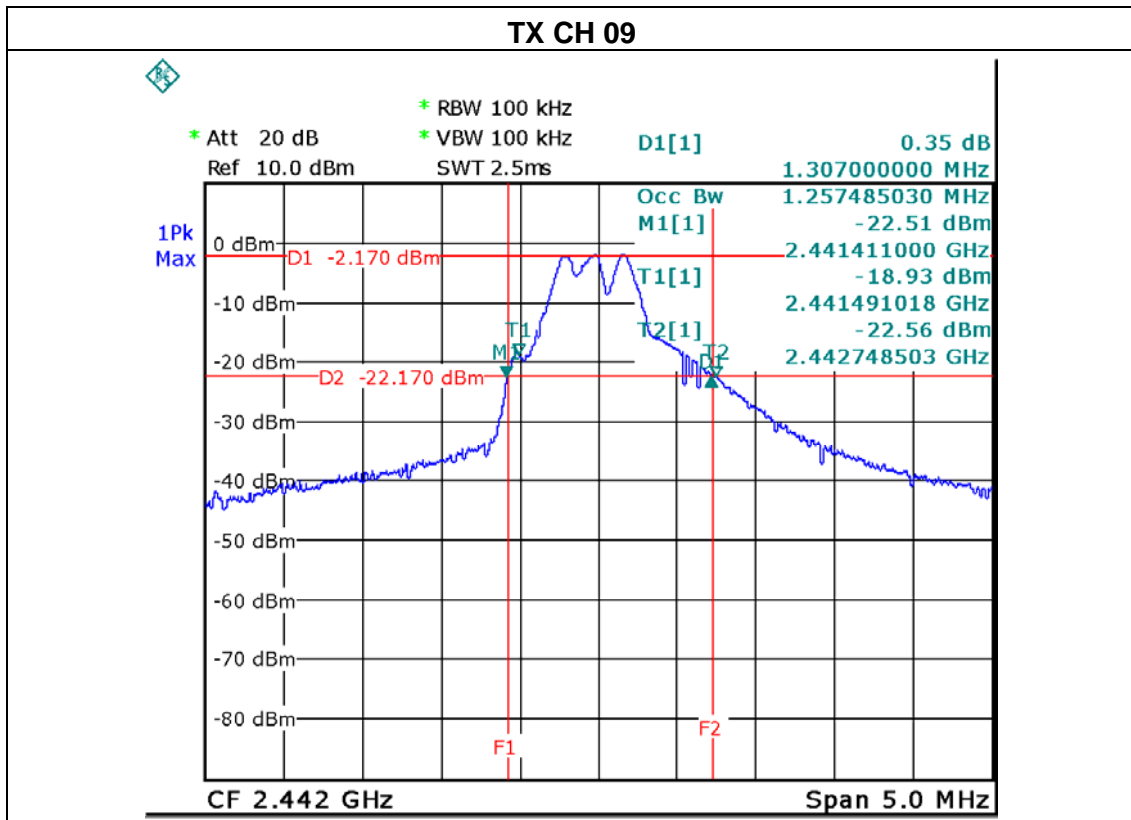



6. ANTENNA CONDUCTED SPURIOUS EMISSION

6.1 APPLIED PROCEDURES / LIMIT

20dBc in any 100 kHz bandwidth outside the operating frequency band. In case the emission fall within the restricted band specified on 15.205(a), then the 15.209(a) limit in the table below has to be followed.

| Frequencies (MHz) | Field Strength (micorvolts/meter) | Measurement Distance (meters) |
|--------------------------|--|--------------------------------------|
| 0.009~0.490 | 2400/F(KHz) | 300 |
| 0.490~1.705 | 24000/F(KHz) | 30 |
| 1.705~30.0 | 30 | 30 |
| 30~88 | 100 | 3 |
| 88~216 | 150 | 3 |
| 216~960 | 200 | 3 |
| Above 960 | 500 | 3 |

6.1.1 MEASUREMENT INSTRUMENTS LIST

| Item | Kind of Equipment | Manufacturer | Type No. | Serial No. | Calibrated until |
|-------------|--------------------------|---------------------|-----------------|-------------------|-------------------------|
| 1 | Spectrum Analyzer | R&S | FSP 40 | 100185 | Nov.26.2011 |

Remark: " N/A" denotes No Model Name. , Serial No. or No Calibration specified.

6.1.2 TEST PROCEDURE

- a. The EUT was directly connected to the spectrum analyzer and antenna output port as show in the block diagram below,
- b. Spectrum Setting : RBW= 100KHz, VBW=100KHz, Sweep time = 10 ms.

6.1.3 DEVIATION FROM STANDARD

No deviation.

6.1.4 TEST SETUP



6.1.5 EUT OPERATION CONDITIONS

The EUT tested system was configured as the statements of 4.1.6 Unless otherwise a special operating condition is specified in the follows during the testing.



6.1.6 TEST RESULTS

| | | | |
|---------------|--------------------------|---------------------|--------------|
| EUT : | 2.4GHz wireless receiver | Model Name. : | M01132-D |
| Temperature : | 20°C | Relative Humidity : | 58 % |
| Pressure : | 1001 hPa | Test Power : | AC 120V/60Hz |
| Test Mode : | TX CH01, CH09, CH16 | | |

| Channel of Worst Data: CH16 | | | |
|---|------------|--|------------|
| The max. radio frequency power in any 100kHz bandwidth outside the frequency band | | The max. radio frequency power in any 100 kHz bandwidth within the frequency band. | |
| FREQUENCY(MHz) | POWER(dBm) | FREQUENCY(MHz) | POWER(dBm) |
| 2338.20 | -58.93 | 2489.80 | -56.27 |

Result

In any 100kHz bandwidth outside the frequency band, the radio frequency power is at least 50dB below that in the 100kHz bandwidth within the band that contains the highest level of the desired power.

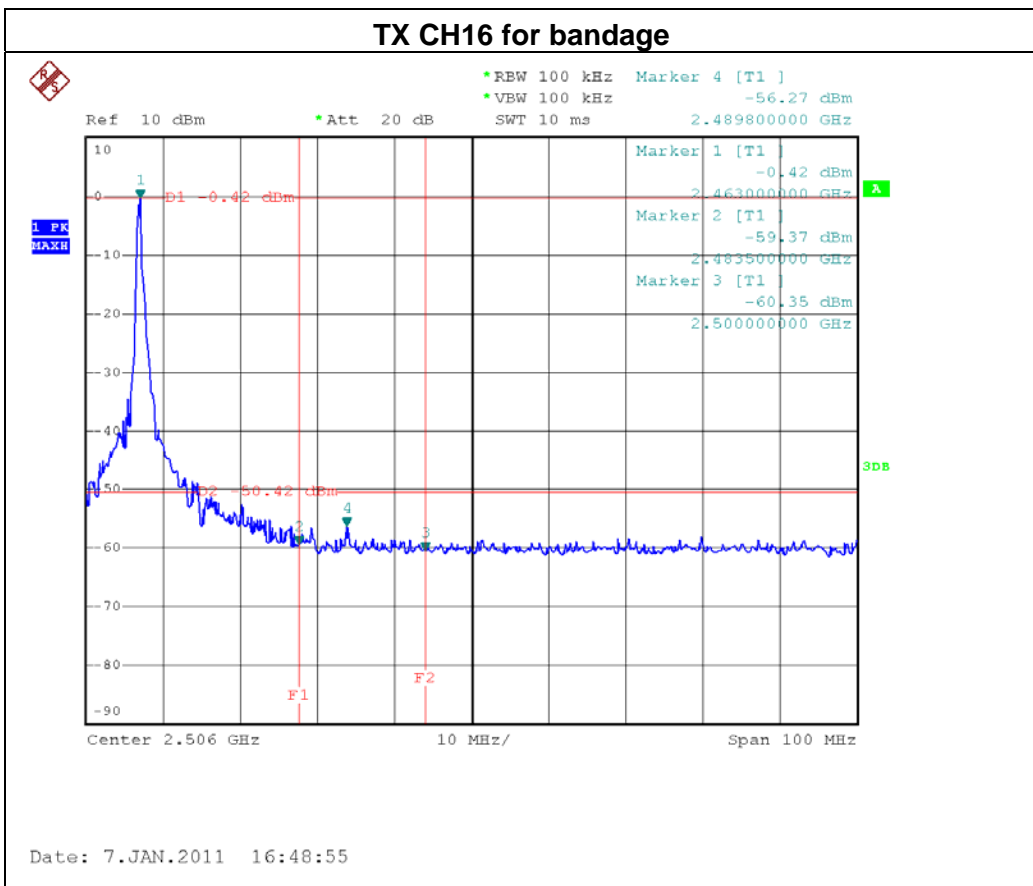
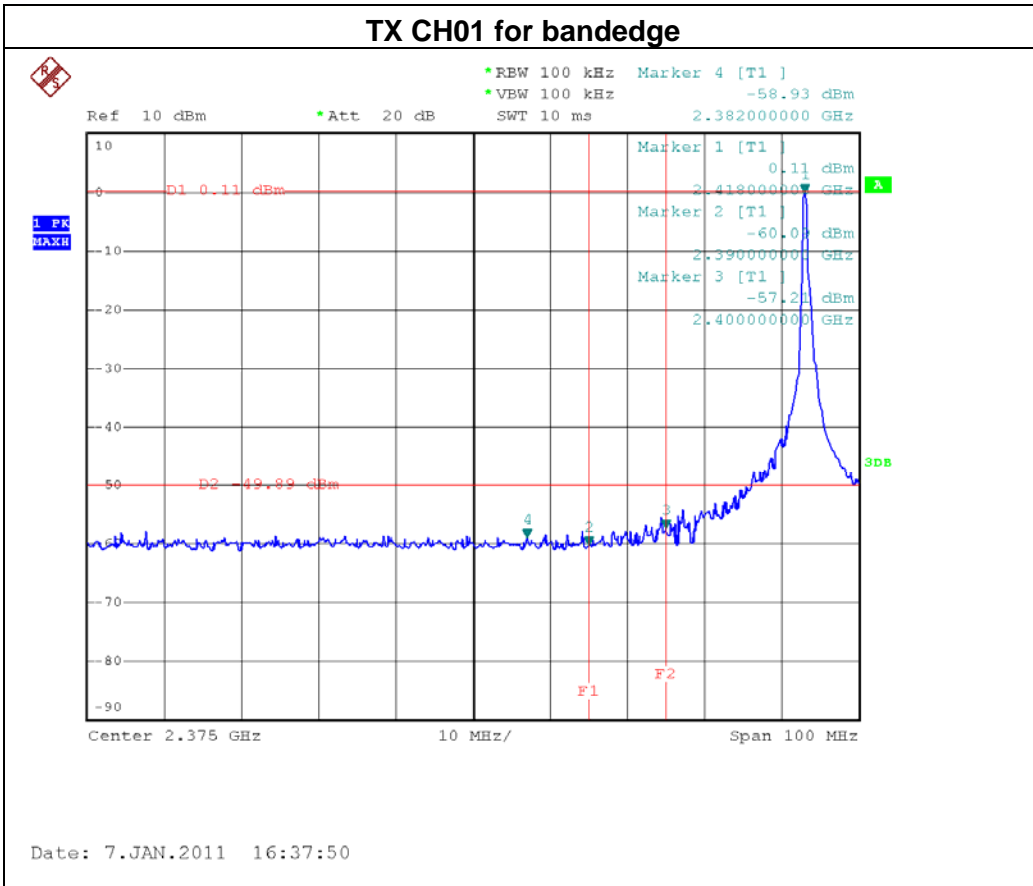

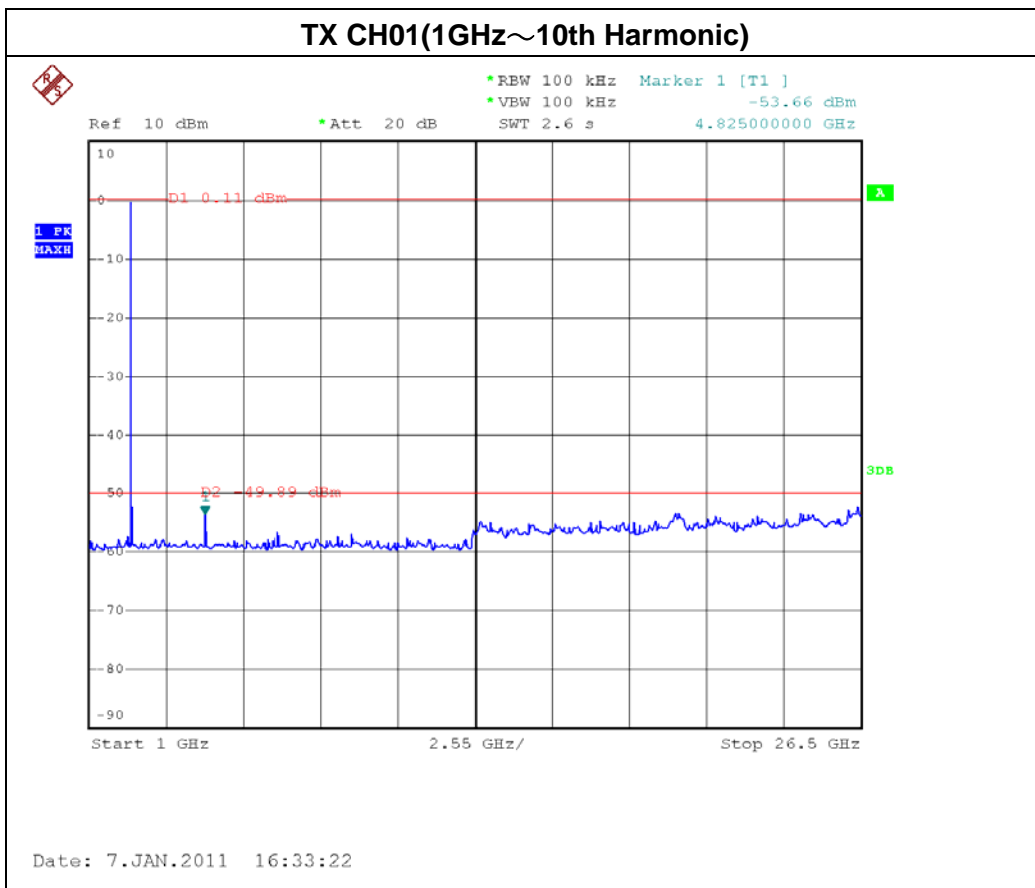
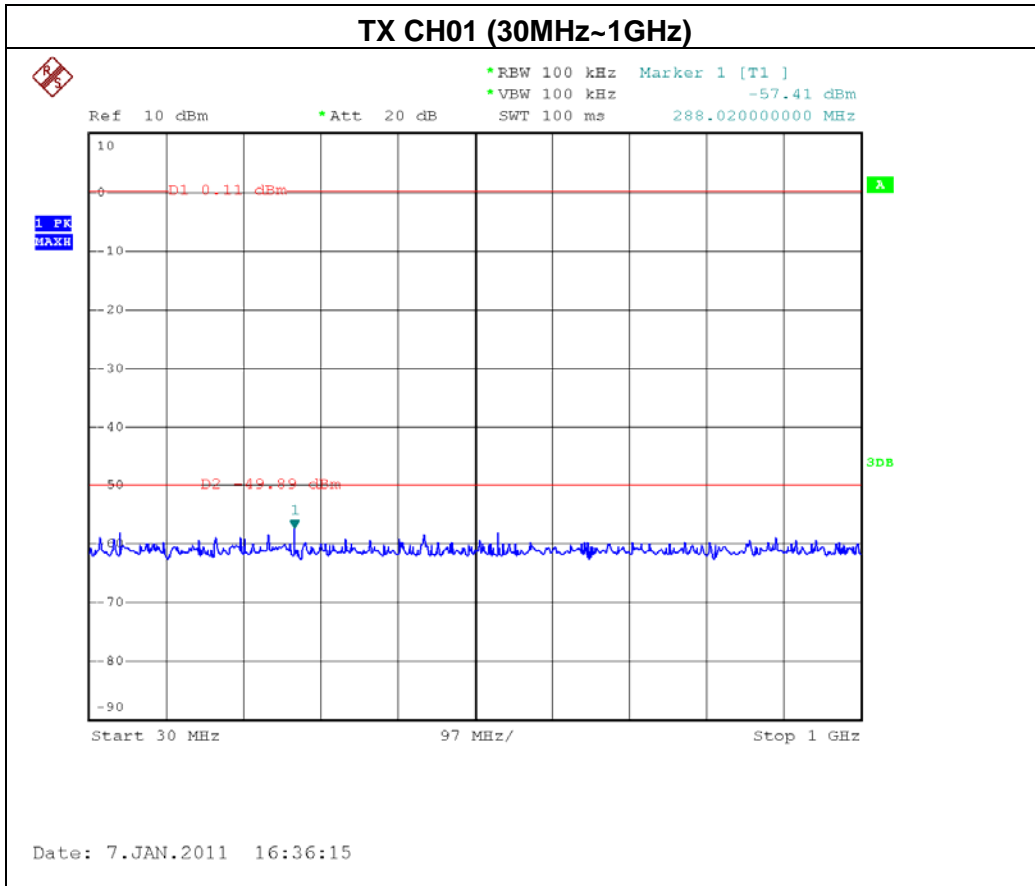

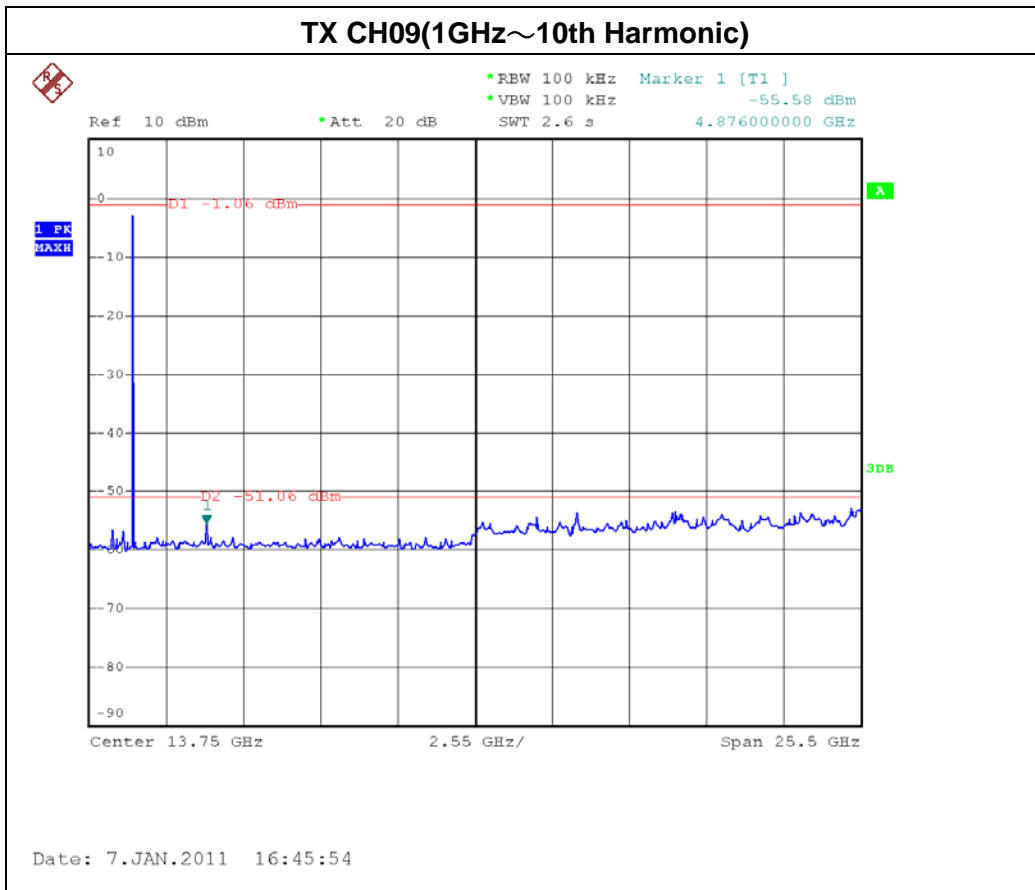
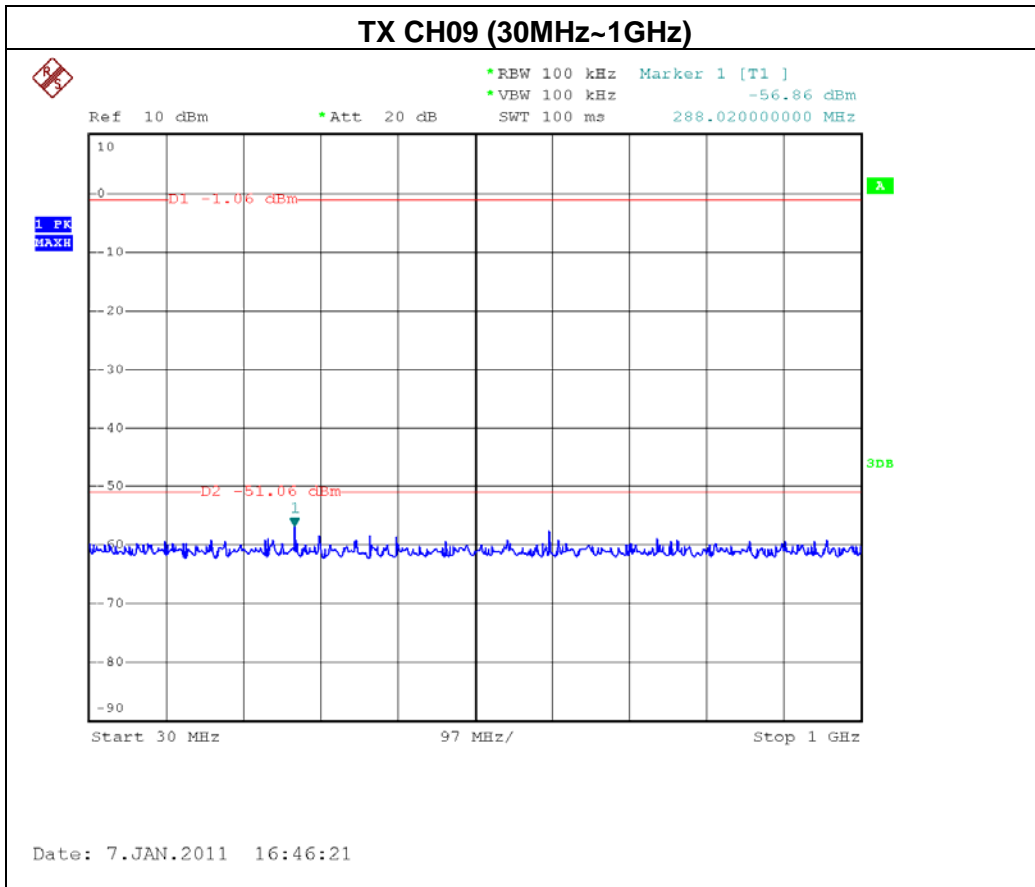

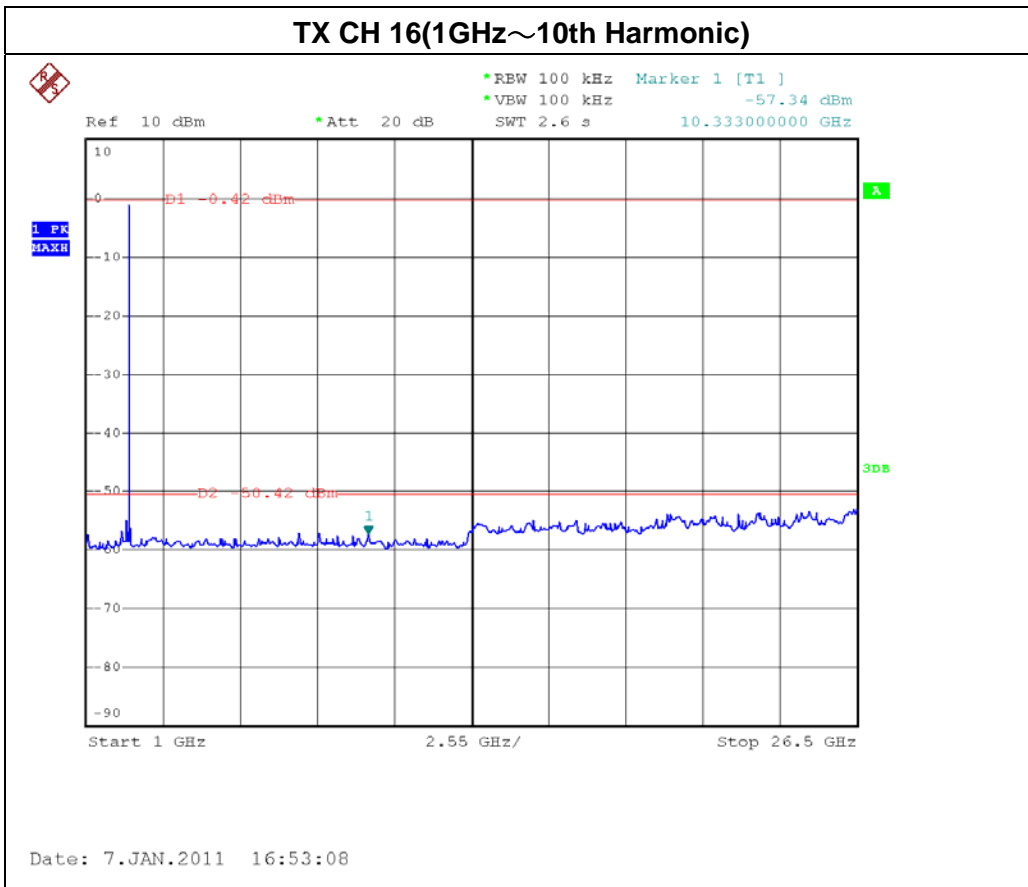
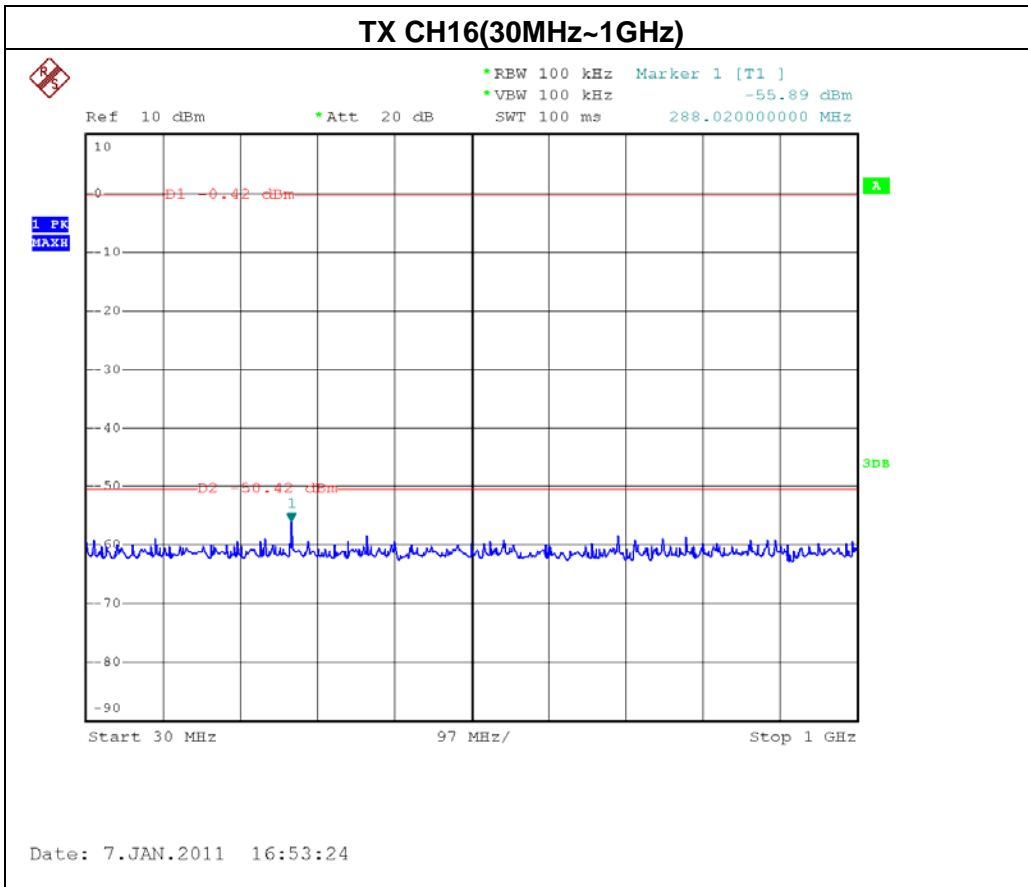



7. EUT TEST PHOTO

Conducted Measurement Photos





Radiated Measurement Photos

