



FCC TEST REPORT

REPORT NO. : RF980623L11

MODEL NO. : M01048-D

RECEIVED : Jun. 23, 2009

TESTED : Jun. 25, 2009

ISSUED : Jul. 02, 2009

APPLICANT : ACCO Brands, Inc.

ADDRESS : 333 Twin Dolphin Drive, 6th Floor, Redwood Shores, CA 94065, USA

ISSUED BY : Bureau Veritas Consumer Products Services (H.K.) Ltd., Taoyuan Branch

LAB ADDRESS : No. 47, 14th Ling, Chia Pau Tsuen, Lin Kou Hsiang, Taipei Hsien 244, Taiwan, R.O.C.

TEST LOCATION : No. 19, Hwa Ya 2nd Rd, Wen Hwa Tsuen, Kwei Shan Hsiang, Taoyuan Hsien 333, Taiwan, R.O.C.

This test report consists of 28 pages in total. It may be duplicated completely for legal use with the approval of the applicant. It should not be reproduced except in full, without the written approval of our laboratory. The client should not use it to claim product endorsement by TAF or any government agency. The test results in the report only apply to the tested sample.



Table of Contents

1.	CERTIFICATION	3
2.	SUMMARY OF TEST RESULTS	4
2.1	MEASUREMENT UNCERTAINTY	4
3.	GENERAL INFORMATION.....	5
3.1	GENERAL DESCRIPTION OF EUT	5
3.2	DESCRIPTION OF TEST MODES.....	6
3.2.1	CONFIGURATION OF SYSTEM UNDER TEST	6
3.2.2	TEST MODE APPLICABILITY AND TESTED CHANNEL DETAIL.....	7
3.3	GENERAL DESCRIPTION OF APPLIED STANDARDS	8
3.4	DESCRIPTION OF SUPPORT UNITS	8
4.	TEST TYPES AND RESULTS	9
4.1	RADIATED EMISSION MEASUREMENT	9
4.1.1	LIMITS OF RADIATED EMISSION MEASUREMENT.....	9
4.1.2	TEST INSTRUMENTS	10
4.1.3	TEST PROCEDURES	11
4.1.4	DEVIATION FROM TEST STANDARD	11
4.1.5	TEST SETUP	12
4.1.6	EUT OPERATING CONDITIONS	12
4.1.7	TEST RESULTS	13
4.2	CONDUCTED EMISSION MEASUREMENT	18
4.2.1	LIMITS OF CONDUCTED EMISSION MEASUREMENT.....	18
4.2.2	TEST INSTRUMENTS	18
4.2.3	TEST PROCEDURES	19
4.2.4	DEVIATION FROM TEST STANDARD	19
4.2.5	TEST SETUP	20
4.2.6	EUT OPERATING CONDITIONS	20
4.2.7	TEST RESULTS	21
4.3	BAND EDGES MEASUREMENT	23
4.3.1	LIMITS OF BAND EDGES MEASUREMENT	23
4.3.2	TEST INSTRUMENTS	23
4.3.3	TEST PROCEDURE	23
4.3.4	DEVIATION FROM TEST STANDARD	23
4.3.5	EUT OPERATING CONDITION	23
4.3.6	TEST RESULTS	23
5.	PHOTOGRAPHS OF THE TEST CONFIGURATION.....	26
6.	INFORMATION ON THE TESTING LABORATORIES	27
7.	APPENDIX A - MODIFICATIONS RECORDERS FOR ENGINEERING CHANGES TO THE EUT BY THE LAB.....	28



1. CERTIFICATION

PRODUCT: Pro Fit™ 2.4GHz Wireless Desktop Set
MODEL NO.: M01048-D
BRAND: Kensington
APPLICANT: ACCO Brands, Inc.
TESTED: Jun. 25, 2009
TEST SAMPLE: ENGINEERING SAMPLE
STANDARDS: **FCC Part 15, Subpart C (Section 15.249)**
ANSI C63.4-2003

The above equipment (model: M01048-D) have been tested by **Bureau Veritas Consumer Products Services (H.K.) Ltd., Taoyuan Branch**, and found compliance with the requirement of the above standards. The test record, data evaluation & Equipment Under Test (EUT) configurations represented herein are true and accurate accounts of the measurements of the sample's EMC characteristics under the conditions specified in this report.

PREPARED BY :  , **DATE:** Jul. 02, 2009
Andrea Hsia / Specialist

TECHNICAL ACCEPTANCE :  , **DATE:** Jul. 02, 2009
Responsible for RF Long Chen / Senior Engineer

APPROVED BY :  , **DATE:** Jul. 02, 2009
Gary Chang / Assistant Manager

2. SUMMARY OF TEST RESULTS

The EUT has been tested according to the following specifications:

APPLIED STANDARD: FCC Part 15, Subpart C (Section 15.249)			
STANDARD PARAGRAPH	TEST TYPE	RESULT	REMARK
15.207	Conducted Emission Test	PASS	Meet the requirement of limit. Minimum passing margin is -18.13dB at 0.209MHz.
15.209 15.249 15.249 (d)	Radiated Emission Test Band Edge Measurement Limit: 50dB less than the peak value of fundamental frequency or meet radiated emission limit in section 15.209	PASS	Meet the requirement of limit. Minimum passing margin is -7.54dB at 109.62MHz.

2.1 MEASUREMENT UNCERTAINTY

Where relevant, the following measurement uncertainty levels have been estimated for tests performed on the EUT as specified in CISPR 16-4-2:

MEASUREMENT	FREQUENCY	UNCERTAINTY
Conducted emissions	150kHz~30MHz	2.44 dB
Radiated emissions	30MHz ~ 200MHz	2.93 dB
	200MHz ~1000MHz	2.95 dB
	1GHz ~ 18GHz	2.26 dB
	18GHz ~ 40GHz	1.94 dB

This uncertainty represents an expanded uncertainty expressed at approximately the 95% confidence level using a coverage factor of k=2.

3. GENERAL INFORMATION

3.1 GENERAL DESCRIPTION OF EUT

PRODUCT	Pro Fit™ 2.4GHz Wireless Desktop Set
MODEL NO.	M01048-D
FCC ID	GV3M01048-D
POWER SUPPLY	5.0Vdc from host equipment
MODULATION TYPE	GFSK
OPERATING FREQUENCY	2403 - 2480 MHz
NUMBER OF CHANNEL	78
ANTENNA TYPE	Printed antenna
DATA CABLE	NA
I/O PORT	USB
ACCESSORY DEVICE	NA

NOTE:

1. A set of the EUT include Mouse, Keyboard and Dongle. This report covers Dongle only. The Keyboard is covered in another test report which report no.: RF980623L03 and the Mouse is covered in another test report which report no.: RF980623L09.
2. The above EUT information was declared by manufacturer and for more detailed features description, please refer to the manufacturer's specifications or User's Manual.

3.2 DESCRIPTION OF TEST MODES

78 channels are provided to this EUT.

Channel	Freq. (MHz)	Channel	Freq. (MHz)	Channel	Freq. (MHz)
1	2403	27	2429	53	2455
2	2404	28	2430	54	2456
3	2405	29	2431	55	2457
4	2406	30	2432	56	2458
5	2407	31	2433	57	2459
6	2408	32	2434	58	2460
7	2409	33	2435	59	2461
8	2410	34	2436	60	2462
9	2411	35	2437	61	2463
10	2412	36	2438	62	2464
11	2413	37	2439	63	2465
12	2414	38	2440	64	2466
13	2415	39	2441	65	2467
14	2416	40	2442	66	2468
15	2417	41	2443	67	2469
16	2418	42	2444	68	2470
17	2419	43	2445	69	2471
18	2420	44	2446	70	2472
19	2421	45	2447	71	2473
20	2422	46	2448	72	2474
21	2423	47	2449	73	2475
22	2424	48	2450	74	2476
23	2425	49	2451	75	2477
24	2426	50	2452	76	2478
25	2427	51	2453	77	2479
26	2428	52	2454	78	2480

3.2.1 CONFIGURATION OF SYSTEM UNDER TEST

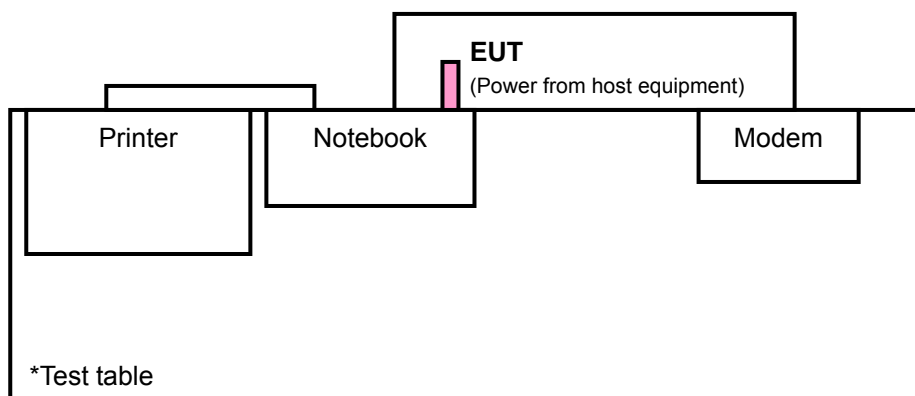

3.2.2 TEST MODE APPLICABILITY AND TESTED CHANNEL DETAIL

EUT CONFIGURE MODE	APPLICABLE TO				DESCRIPTION
	RE \geq 1G	RE<1G	PLC	BM	
-	√	√	√	√	-

Where **RE \geq 1G**: Radiated Emission above 1GHz

RE<1G: Radiated Emission below 1GHz

PLC: Power Line Conducted Emission

BM: Bandedge Measurement

RADIATED EMISSION TEST (ABOVE 1 GHz):

- Pre-Scan has been conducted to determine the worst-case mode from all possible combinations between available modulations and antenna ports (if EUT with antenna diversity architecture).
- Following channel(s) was (were) selected for the final test as listed below.

AVAILABLE CHANNEL	TESTED CHANNEL	MODULATION TYPE
1 to 78	1, 38, 78	GFSK

RADIATED EMISSION TEST (BELOW 1 GHz):

- Pre-Scan has been conducted to determine the worst-case mode from all possible combinations between available modulations and antenna ports (if EUT with antenna diversity architecture).
- Following channel(s) was (were) selected for the final test as listed below.

AVAILABLE CHANNEL	TESTED CHANNEL	MODULATION TYPE
1 to 78	38	GFSK

POWER LINE CONDUCTED EMISSION TEST:

- Pre-Scan has been conducted to determine the worst-case mode from all possible combinations between available modulations and antenna ports (if EUT with antenna diversity architecture).
- Following channel(s) was (were) selected for the final test as listed below.

AVAILABLE CHANNEL	TESTED CHANNEL	MODULATION TYPE
1 to 78	38	GFSK

BANDEDGE MEASUREMENT:

- Pre-Scan has been conducted to determine the worst-case mode from all possible combinations between available modulations and antenna ports (if EUT with antenna diversity architecture).
- Following channel(s) was (were) selected for the final test as listed below.

AVAILABLE CHANNEL	TESTED CHANNEL	MODULATION TYPE
1 to 78	1, 78	GFSK

3.3 GENERAL DESCRIPTION OF APPLIED STANDARDS

The EUT is a RF Product. According to the specifications of the manufacturer, it must comply with the requirements of the following standards:

FCC Part 15, Subpart C (Section 15.249)

ANSI C63.4-2003

All test items have been performed and recorded as per the above standards.

NOTE: The EUT is also considered as a kind of computer peripheral, because the connection to computer is necessary for typical use. It has been verified to comply with the requirements of FCC Part 15, Subpart B, Class B (DoC). The test report has been issued separately.

3.4 DESCRIPTION OF SUPPORT UNITS

The EUT has been tested as an independent unit together with other necessary accessories or support units. The following support units or accessories were used to form a representative test configuration during the tests.

NO.	PRODUCT	BRAND	MODEL NO.	SERIAL NO.	FCC ID
1	NOTEBOOK COMPUTER	DELL	PP05L	16484462992	E2K24CLNS
2	MODEM	ACEEX	1414V/3	0401008253	IFAXDM1414
3	PRINTER	EPSON	LQ-300+	DCGY046016	FCC DoC Approved

NO.	SIGNAL CABLE DESCRIPTION OF THE ABOVE SUPPORT UNITS
1	NA
2	1.2m braid shielded wire, DB25 & DB9 connector, w/o core.
3	1.8m braid shielded wire, DB25 connector, w/o core.

NOTE: All power cords of the above support units are non-shielded (1.8m).

4. TEST TYPES AND RESULTS

4.1 RADIATED EMISSION MEASUREMENT

4.1.1 LIMITS OF RADIATED EMISSION MEASUREMENT

Emissions radiated outside of the specified bands, shall be according to the general radiated limits in 15.209, 15.249 as following:

15.209 Limit		
Frequencies (MHz)	Field strength (microvolts/meter)	Measurement distance (meters)
0.009 ~ 0.490	2400/F(kHz)	300
0.490 ~ 1.705	24000/F(kHz)	30
1.705 ~ 30.0	30	30
30 ~ 88	100	3
88 ~ 216	150	3
216 ~ 960	200	3
Above 960	500	3
15.249 Limit		
Fundamental Frequency	Field Strength of Fundamental (millivolts/meter)	Field Strength of Harmonics (microvolts/meter)
902 ~ 928 MHz	50	500
2400 ~ 2483.5 MHz	50	500
5725 ~ 5875 MHz	50	500
24 ~ 24.25 GHz	250	2500

NOTE:

1. The lower limit shall apply at the transition frequencies.
2. Emission level (dBuV/m) = 20 log Emission level (uV/m).
3. As shown in 15.35(b), for frequencies above 1000MHz, the field strength limits are based on average detector, however, the peak field strength of any emission shall not exceed the maximum permitted average limits, specified above by more than 20dB under any condition of modulation.

4.1.2 TEST INSTRUMENTS

DESCRIPTION & MANUFACTURER	MODEL NO.	SERIAL NO.	DATE OF CALIBRATION	DUE DATE OF CALIBRATION
Test Receiver ROHDE & SCHWARZ	ESIB7	100212	May 25, 2009	May 24, 2010
Spectrum Analyzer ROHDE & SCHWARZ	FSP40	100269	Aug. 08, 2008	Aug. 07, 2009
BILOG Antenna SCHWARZBECK	VULB9168	9168-156	Apr. 30, 2009	Apr. 29, 2010
HORN Antenna SCHWARZBECK	BBHA 9120 D	9120D-563	Aug. 06, 2008	Aug. 05, 2009
Loop Antenna	HFH2-Z2	100070	Jan. 14, 2008	Jan. 13, 2010
HORN Antenna SCHWARZBECK	BBHA 9170	BBHA9170242	Jan. 06, 2009	Jan. 05, 2010
Preamplifier Agilent	8449B	3008A01911	Sep. 10, 2008	Sep. 09, 2009
Preamplifier Agilent	8447D	2944A10638	Dec. 26, 2008	Dec. 25, 2009
RF signal cable HUBER+SUHNNER	SUCOFLEX 104	218190/4 231241/4	May 13, 2009	May 12, 2010
RF signal cable Worken	8D-FB	Cable-HYCH9-01	Aug. 09, 2008	Aug. 08, 2009
Software	ADT_Radiated_ V7.6.15.9.2	NA	NA	NA
Antenna Tower EMCO	2070/2080	512.835.4684	NA	NA
Turn Table EMCO	2087-2.03	NA	NA	NA
Antenna Tower & Turn Table Controller EMCO	2090	NA	NA	NA

- NOTE:**
1. The calibration interval of the above test instruments is 12 months and the calibrations are traceable to NML/ROC and NIST/USA.
 2. The test was performed in HwaYa Chamber 9.
 3. The horn antenna and HP preamplifier (model: 8449B) are used only for the measurement of emission frequency above 1GHz if tested.
 4. The FCC Site Registration No. is 460141.
 5. The IC Site Registration No. is IC 7450F-4.

4.1.3 TEST PROCEDURES

- a. The EUT was placed on the top of a rotating table 0.8 meters above the ground at a 3 meter semi-anechoic chamber. The table was rotated 360 degrees to determine the position of the highest radiation.
- b. The EUT was set 3 meters away from the interference-receiving antenna, which was mounted on the top of a variable-height antenna tower.
- c. The antenna is a broadband antenna, and its height is varied from one meter to four meters above the ground to determine the maximum value of the field strength. Both horizontal and vertical polarizations of the antenna are set to make the measurement.
- d. For each suspected emission, the EUT was arranged to its worst case and then the antenna was tuned to heights from 1 meter to 4 meters and the rotatable table was turned from 0 degrees to 360 degrees to find the maximum reading.
- e. The test-receiver system was set to Peak Detect Function and Specified Bandwidth with Maximum Hold Mode.
- f. If the emission level of the EUT in peak mode was lower than the limit specified, then testing could be stopped and the peak values of the EUT would be reported. Otherwise the emissions would be re-tested one by one using peak, quasi-peak or average method as specified and then reported in a data sheet.

NOTE:

1. The resolution bandwidth and video bandwidth of test receiver/spectrum analyzer is 120kHz for Quasi-peak detection at frequency below 1GHz.
2. The resolution bandwidth of test receiver/spectrum analyzer is 1 MHz and video bandwidth is 3MHz for Peak detection at frequency above 1GHz.
3. All modes of operation were investigated and the worst-case emissions are reported.

4.1.4 DEVIATION FROM TEST STANDARD

No deviation.

4.1.5 TEST SETUP

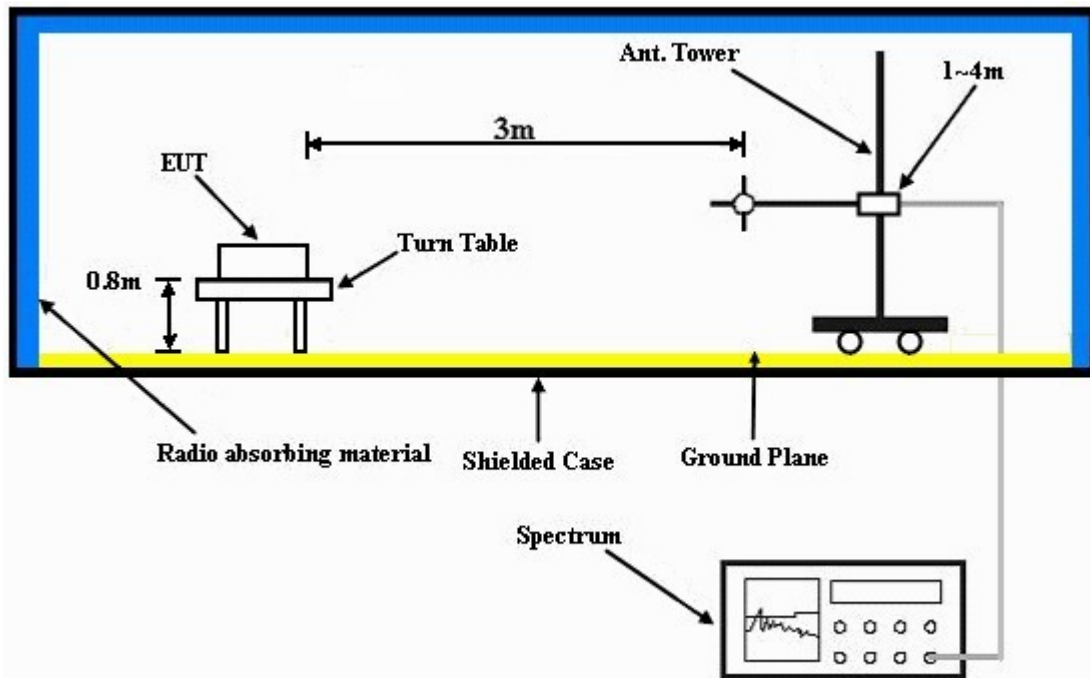

For the actual test configuration, please refer to the attached file (Test Setup Photo).

4.1.6 EUT OPERATING CONDITIONS

- a. Connected EUT with notebook system and placed on a testing table.
- b. Set the transmitter part of EUT under transmission condition continuously at specific channel frequency.
- c. The necessary accessories enable the EUT in full functions.

4.1.7 TEST RESULTS

ABOVE 1GHz DATA

EUT TEST CONDITION		MEASUREMENT DETAIL	
CHANNEL	Channel 1	FREQUENCY RANGE	1 ~ 25GHz
INPUT POWER (SYSTEM)	120Vac, 60 Hz	DETECTOR FUNCTION	Peak (PK) Average (AV)
ENVIRONMENTAL CONDITIONS	23deg. C, 70%RH 1000 hPa	TESTED BY	Kevin Liang

ANTENNA POLARITY & TEST DISTANCE: HORIZONTAL AT 3 M								
NO.	FREQ. (MHz)	EMISSION LEVEL (dBuV/m)	LIMIT (dBuV/m)	MARGIN (dB)	ANTENNA HEIGHT (m)	TABLE ANGLE (Degree)	RAW VALUE (dBuV)	CORRECTION FACTOR (dB/m)
1	2390.00	52.21 PK	74.00	-21.79	1.10 H	30	19.99	32.22
2	2390.00	7.54 AV	54.00	-46.46	1.10 H	30	-24.68	32.22
3	*2403.00	89.21 PK	114.00	-24.79	1.10 H	30	56.94	32.27
4	*2403.00	44.54 AV	94.00	-49.46	1.10 H	30	12.27	32.27
5	4806.00	60.96 PK	74.00	-13.04	1.15 H	188	22.66	38.30
6	4806.00	16.29 AV	54.00	-37.71	1.15 H	188	-22.01	38.30
ANTENNA POLARITY & TEST DISTANCE: VERTICAL AT 3 M								
NO.	FREQ. (MHz)	EMISSION LEVEL (dBuV/m)	LIMIT (dBuV/m)	MARGIN (dB)	ANTENNA HEIGHT (m)	TABLE ANGLE (Degree)	RAW VALUE (dBuV)	CORRECTION FACTOR (dB/m)
1	2390.00	48.87 PK	74.00	-25.13	1.32 V	344	16.65	32.22
2	2390.00	4.20 AV	54.00	-49.80	1.32 V	344	-28.02	32.22
3	*2403.00	85.87 PK	114.00	-28.13	1.32 V	344	53.60	32.27
4	*2403.00	41.20 AV	94.00	-52.80	1.32 V	344	8.93	32.27
5	4806.00	53.77 PK	74.00	-20.23	1.29 V	5	15.47	38.30
6	4806.00	9.10 AV	54.00	-44.90	1.29 V	5	-29.20	38.30

- REMARKS:**
1. Emission level (dBuV/m) = Raw Value (dBuV) + Correction Factor (dB/m).
 2. Correction Factor (dB/m) = Antenna Factor (dB/m) + Cable Factor (dB).
 3. The other emission levels were very low against the limit.
 4. Margin value = Emission level – Limit value.
 5. “ * ” : Fundamental frequency
 6. The average value of fundamental frequency is: Average = Peak value + 20log(Duty cycle) Where the duty factor is calculated from following formula:
 $20 \log (\text{Duty cycle}) = 20 \log (0.292 \text{ ms} / 100 \text{ ms}) = -44.67 \text{ dB}$

Please see page 16 for plotted duty.



EUT TEST CONDITION		MEASUREMENT DETAIL	
CHANNEL	Channel 38	FREQUENCY RANGE	1 ~ 25GHz
INPUT POWER (SYSTEM)	120Vac, 60 Hz	DETECTOR FUNCTION	Peak (PK) Average (AV)
ENVIRONMENTAL CONDITIONS	23deg. C, 70%RH 1000 hPa	TESTED BY	Kevin Liang

ANTENNA POLARITY & TEST DISTANCE: HORIZONTAL AT 3 M								
NO.	FREQ. (MHz)	EMISSION LEVEL (dBuV/m)	LIMIT (dBuV/m)	MARGIN (dB)	ANTENNA HEIGHT (m)	TABLE ANGLE (Degree)	RAW VALUE (dBuV)	CORRECTION FACTOR (dB/m)
1	*2440.00	90.54 PK	114.00	-23.46	1.06 H	40	58.14	32.40
2	*2440.00	45.87 AV	94.00	-48.13	1.06 H	40	13.47	32.40
3	4880.00	61.30 PK	74.00	-12.70	1.05 H	189	22.89	38.42
4	4880.00	16.63 AV	54.00	-37.37	1.05 H	189	-21.78	38.42

ANTENNA POLARITY & TEST DISTANCE: VERTICAL AT 3 M								
NO.	FREQ. (MHz)	EMISSION LEVEL (dBuV/m)	LIMIT (dBuV/m)	MARGIN (dB)	ANTENNA HEIGHT (m)	TABLE ANGLE (Degree)	RAW VALUE (dBuV)	CORRECTION FACTOR (dB/m)
1	*2440.00	87.30 PK	114.00	-26.70	1.28 V	6	54.90	32.40
2	*2440.00	42.63 AV	94.00	-51.37	1.28 V	6	10.23	32.40
3	4880.00	55.48 PK	74.00	-18.52	1.17 V	5	17.07	38.42
4	4880.00	10.81 AV	54.00	-43.19	1.17 V	5	-27.60	38.42

- REMARKS:**
1. Emission level (dBuV/m) = Raw Value (dBuV) + Correction Factor (dB/m).
 2. Correction Factor (dB/m) = Antenna Factor (dB/m) + Cable Factor (dB).
 3. The other emission levels were very low against the limit.
 4. Margin value = Emission level – Limit value.
 5. “ * “ : Fundamental frequency
 6. The average value of fundamental frequency is: Average = Peak value + 20log(Duty cycle) Where the duty factor is calculated from following formula:
 $20 \log (\text{Duty cycle}) = 20 \log (0.292 \text{ ms} / 100 \text{ ms}) = -44.67 \text{ dB}$

Please see page 16 for plotted duty.

EUT TEST CONDITION		MEASUREMENT DETAIL	
CHANNEL	Channel 78	FREQUENCY RANGE	1 ~ 25GHz
INPUT POWER (SYSTEM)	120Vac, 60 Hz	DETECTOR FUNCTION	Peak (PK) Average (AV)
ENVIRONMENTAL CONDITIONS	23deg. C, 70%RH 1000 hPa	TESTED BY	Kevin Liang

ANTENNA POLARITY & TEST DISTANCE: HORIZONTAL AT 3 M								
NO.	FREQ. (MHz)	EMISSION LEVEL (dBuV/m)	LIMIT (dBuV/m)	MARGIN (dB)	ANTENNA HEIGHT (m)	TABLE ANGLE (Degree)	RAW VALUE (dBuV)	CORRECTION FACTOR (dB/m)
1	*2480.00	90.75 PK	114.00	-23.25	1.06 H	41	58.20	32.55
2	*2480.00	46.08 AV	94.00	-47.92	1.06 H	41	13.53	32.55
3	2483.50	54.80 PK	74.00	-19.20	1.06 H	41	22.24	32.56
4	2483.50	10.13 AV	54.00	-43.87	1.06 H	41	-22.43	32.56
5	4960.00	60.03 PK	74.00	-13.97	1.00 H	190	21.42	38.61
6	4960.00	15.36 AV	54.00	-38.64	1.00 H	190	-23.25	38.61
ANTENNA POLARITY & TEST DISTANCE: VERTICAL AT 3 M								
NO.	FREQ. (MHz)	EMISSION LEVEL (dBuV/m)	LIMIT (dBuV/m)	MARGIN (dB)	ANTENNA HEIGHT (m)	TABLE ANGLE (Degree)	RAW VALUE (dBuV)	CORRECTION FACTOR (dB/m)
1	*2480.00	87.69 PK	114.00	-26.31	1.24 V	6	55.14	32.55
2	*2480.00	43.02 AV	94.00	-50.98	1.24 V	6	10.47	32.55
3	2483.50	51.74 PK	74.00	-22.26	1.24 V	6	19.18	32.56
4	2483.50	7.07 AV	54.00	-46.93	1.24 V	6	-25.49	32.56
5	4960.00	52.47 PK	74.00	-21.53	1.27 V	3	13.86	38.61
6	4960.00	7.80 AV	54.00	-46.20	1.27 V	3	-30.81	38.61

- REMARKS:**
1. Emission level (dBuV/m) = Raw Value (dBuV) + Correction Factor (dB/m).
 2. Correction Factor (dB/m) = Antenna Factor (dB/m) + Cable Factor (dB).
 3. The other emission levels were very low against the limit.
 4. Margin value = Emission level – Limit value.
 5. “ * “ : Fundamental frequency
 6. The average value of fundamental frequency is: Average = Peak value + 20log(Duty cycle) Where the duty factor is calculated from following formula:
 $20 \log (\text{Duty cycle}) = 20 \log (0.292 \text{ ms} / 100 \text{ ms}) = -44.67 \text{ dB}$

Please see page 16 for plotted duty.

BELOW 1GHz WORST-CASE DATA

EUT TEST CONDITION		MEASUREMENT DETAIL	
CHANNEL	Channel 38	FREQUENCY RANGE	Below 1000MHz
INPUT POWER (SYSTEM)	120Vac, 60 Hz	DETECTOR FUNCTION	Quasi-Peak
ENVIRONMENTAL CONDITIONS	24deg. C, 64%RH 999 hPa	TESTED BY	Brad Wu

ANTENNA POLARITY & TEST DISTANCE: HORIZONTAL AT 3 M								
NO.	FREQ. (MHz)	EMISSION LEVEL (dBuV/m)	LIMIT (dBuV/m)	MARGIN (dB)	ANTENNA HEIGHT (m)	TABLE ANGLE (Degree)	RAW VALUE (dBuV)	CORRECTION FACTOR (dB/m)
1	109.62	27.50 QP	43.50	-16.00	1.50 H	280	16.04	11.47
2	162.11	31.63 QP	43.50	-11.87	1.25 H	112	17.44	14.19
3	442.09	30.14 QP	46.00	-15.86	2.00 H	10	11.04	19.10
4	533.47	35.37 QP	46.00	-10.63	1.50 H	265	14.24	21.13
5	667.63	29.58 QP	46.00	-16.42	1.25 H	1	5.35	24.23
6	735.68	29.94 QP	46.00	-16.06	1.25 H	346	4.58	25.36

ANTENNA POLARITY & TEST DISTANCE: VERTICAL AT 3 M								
NO.	FREQ. (MHz)	EMISSION LEVEL (dBuV/m)	LIMIT (dBuV/m)	MARGIN (dB)	ANTENNA HEIGHT (m)	TABLE ANGLE (Degree)	RAW VALUE (dBuV)	CORRECTION FACTOR (dB/m)
1	109.62	35.96 QP	43.50	-7.54	1.00 V	37	24.49	11.47
2	158.22	35.31 QP	43.50	-8.19	1.00 V	169	21.04	14.27
3	399.31	32.25 QP	46.00	-13.75	1.25 V	181	14.23	18.02
4	533.47	29.73 QP	46.00	-16.27	1.25 V	163	8.60	21.13
5	702.62	28.07 QP	46.00	-17.93	1.25 V	148	3.01	25.06
6	887.33	31.56 QP	46.00	-14.44	1.25 V	40	3.90	27.66

- REMARKS:**
1. Emission level (dBuV/m) = Raw Value (dBuV) + Correction Factor (dB/m).
 2. Correction Factor (dB/m) = Antenna Factor (dB/m) + Cable Factor (dB).
 3. The other emission levels were very low against the limit.
 4. Margin value = Emission level – Limit value.

4.2 CONDUCTED EMISSION MEASUREMENT

4.2.1 LIMITS OF CONDUCTED EMISSION MEASUREMENT

FREQUENCY OF EMISSION (MHz)	CONDUCTED LIMIT (dB μ V)	
	Quasi-peak	Average
0.15 ~ 0.5	66 to 56	56 to 46
0.5 ~ 5	56	46
5 ~ 30	60	50

- NOTE:**
1. The lower limit shall apply at the transition frequencies.
 2. The limit decreases in line with the logarithm of the frequency in the range of 0.15 to 0.50 MHz.
 3. All emanations from a class A/B digital device or system, including any network of conductors and apparatus connected thereto, shall not exceed the level of field strengths specified above.

4.2.2 TEST INSTRUMENTS

DESCRIPTION & MANUFACTURER	MODEL NO.	SERIAL NO.	DATE OF CALIBRATION	DUE DATE OF CALIBRATION
Test Receiver ROHDE & SCHWARZ	ESCS30	100291	Nov. 19, 2008	Nov. 18, 2009
RF signal cable Woken	5D-FB	Cable-HYC01-01	Dec. 31, 2008	Dec. 30, 2009
LISN SCHWARZBECK	NNBL 8226-2	8226-142	Jun. 03, 2009	Jun. 02, 2010
LISN ROHDE & SCHWARZ	ESH2-Z5	100104	Dec. 04, 2008	Dec. 03, 2009
Software ADT	ADT_Cond_ V7.3.7	NA	NA	NA

- NOTE:**
1. The calibration interval of the above test instruments is 12 months and the calibrations are traceable to NML/ROC and NIST/USA.
 2. The test was performed in HwaYa Shielded Room 1.
 3. The VCCI Site Registration No. is C-2040.

4.2.3 TEST PROCEDURES

- a. The EUT was placed 0.4 meters from the conducting wall of the shielded room with EUT being connected to the power mains through a line impedance stabilization network (LISN). Other support units were connected to the power mains through another LISN. The two LISNs provide 50 ohm/ 50uH of coupling impedance for the measuring instrument.
- b. Both lines of the power mains connected to the EUT were checked for maximum conducted interference.
- c. The frequency range from 150kHz to 30MHz was searched. Emission levels under (Limit - 20dB) was not recorded.

NOTE: All modes of operation were investigated and the worst-case emissions are reported.

4.2.4 DEVIATION FROM TEST STANDARD

No deviation.

4.2.5 TEST SETUP

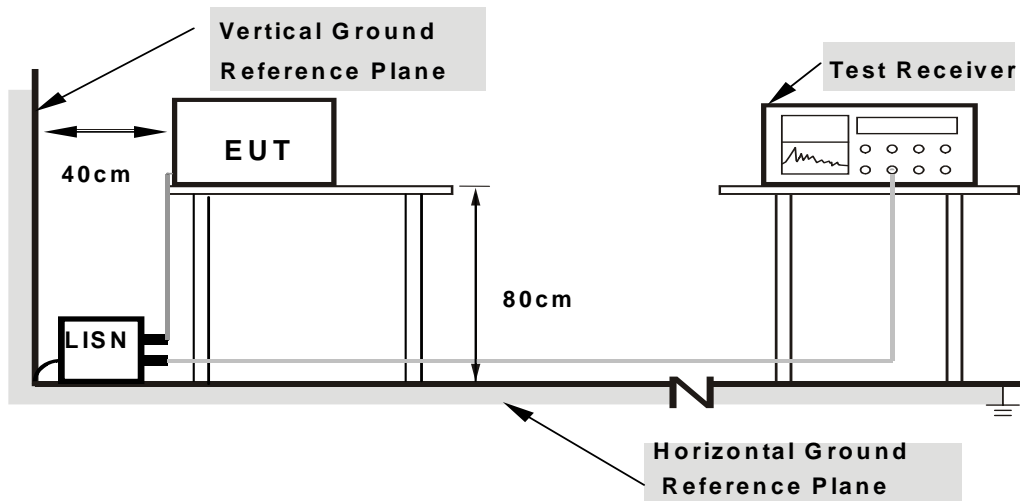

- Note:**
1. Support units were connected to second LISN.
 2. Both of LISNs (AMN) are 80 cm from EUT and at least 80 from other units and other metal planes

For the actual test configuration, please refer to the attached file (Test Setup Photo).

4.2.6 EUT OPERATING CONDITIONS

Same as 4.1.6.

4.2.7 TEST RESULTS

CONDUCTED WORST-CASE DATA

EUT TEST CONDITION		MEASUREMENT DETAIL	
CHANNEL	Channel 38	PHASE	Line 1
MODULATION TYPE	GFSK	INPUT POWER	120Vac, 60Hz
ENVIRONMENTAL CONDITIONS	25deg. C, 65%RH, 1018hPa	6dB BANDWIDTH	9kHz
TESTED BY	Mark Liao		

No	Freq. [MHz]	Corr. Factor [dB]	Reading Value [dB (uV)]		Emission Level [dB (uV)]		Limit [dB (uV)]		Margin (dB)	
			Q.P.	AV.	Q.P.	AV.	Q.P.	AV.	Q.P.	AV.
			1	0.197	0.13	44.74	-	44.87	-	63.74
2	0.244	0.13	37.18	-	37.31	-	61.97	51.97	-24.66	-
3	0.314	0.14	32.87	-	33.01	-	59.86	49.86	-26.86	-
4	0.634	0.16	28.19	-	28.35	-	56.00	46.00	-27.65	-
5	2.211	0.24	26.87	-	27.11	-	56.00	46.00	-28.89	-
6	10.938	0.71	33.65	-	34.36	-	60.00	50.00	-25.64	-

- REMARKS:**
1. Q.P. and AV. are abbreviations of quasi-peak and average individually.
 2. "-": The Quasi-peak reading value also meets average limit and measurement with the average detector is unnecessary.
 3. The emission levels of other frequencies were very low against the limit.
 4. Margin value = Emission level - Limit value
 5. Correction factor = Insertion loss + Cable loss
 6. Emission Level = Correction Factor + Reading Value.

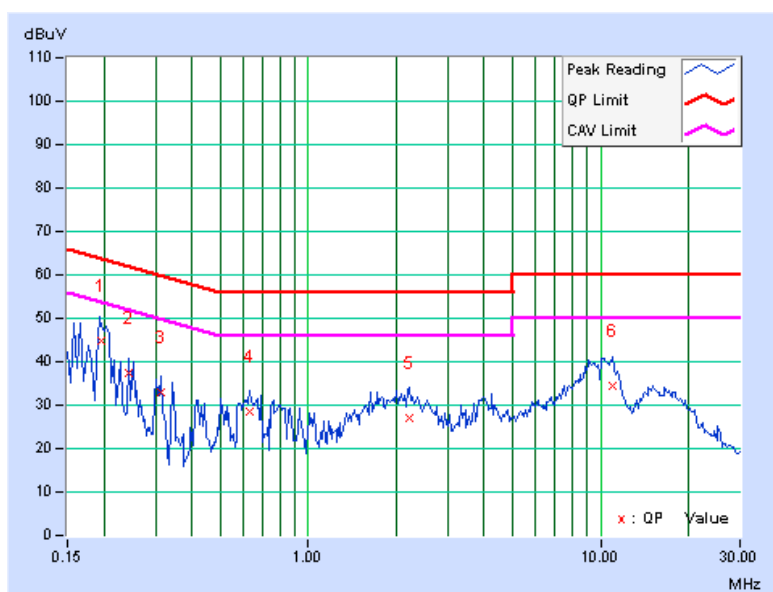

EUT TEST CONDITION		MEASUREMENT DETAIL	
CHANNEL	Channel 38	PHASE	Line 2
MODULATION TYPE	GFSK	INPUT POWER	120Vac, 60Hz
ENVIRONMENTAL CONDITIONS	25deg. C, 65%RH, 1018hPa	6dB BANDWIDTH	9kHz
TESTED BY	Mark Liao		

No	Freq.	Corr.	Reading Value		Emission Level		Limit		Margin	
	[MHz]	Factor (dB)	[dB (uV)]		[dB (uV)]		[dB (uV)]		(dB)	
			Q.P.	AV.	Q.P.	AV.	Q.P.	AV.	Q.P.	AV.
1	0.209	0.15	44.98	-	45.13	-	63.26	53.26	-18.13	-
2	0.236	0.15	36.21	-	36.36	-	62.24	52.24	-25.88	-
3	0.310	0.16	32.75	-	32.91	-	59.97	49.97	-27.06	-
4	0.689	0.18	31.26	-	31.44	-	56.00	46.00	-24.56	-
5	2.133	0.26	25.85	-	26.11	-	56.00	46.00	-29.89	-
6	9.418	0.63	34.92	-	35.55	-	60.00	50.00	-24.45	-

- REMARKS:**
1. Q.P. and AV. are abbreviations of quasi-peak and average individually.
 2. "-": The Quasi-peak reading value also meets average limit and measurement with the average detector is unnecessary.
 3. The emission levels of other frequencies were very low against the limit.
 4. Margin value = Emission level - Limit value
 5. Correction factor = Insertion loss + Cable loss
 6. Emission Level = Correction Factor + Reading Value.

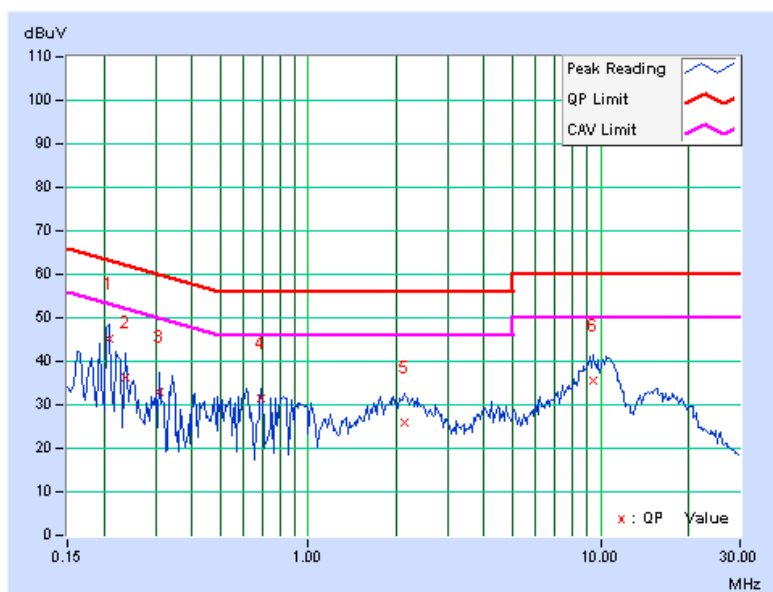

4.3 BAND EDGES MEASUREMENT

4.3.1 LIMITS OF BAND EDGES MEASUREMENT

Below –50dB of the highest emission level of operating band (in 100kHz Resolution Bandwidth).

4.3.2 TEST INSTRUMENTS

DESCRIPTION & MANUFACTURER	MODEL NO.	SERIAL NO.	DATE OF CALIBRATION	DUE DATE OF CALIBRATION
R&S SPECTRUM ANALYZER	FSP40	100040	Jul. 04, 2008	Jul. 03, 2009

NOTE: The calibration interval of the above test instruments is 12 months and the calibrations are traceable to NML/ROC and NIST/USA.

4.3.3 TEST PROCEDURE

The transmitter output was connected to the spectrum analyzer via a low loss cable. Set both RBW and VBW of spectrum analyzer to 100 kHz and 300 kHz with suitable frequency span including 100 MHz bandwidth from band edge. The band edges was measured and recorded.

The spectrum plots are attached on the following pages.

4.3.4 DEVIATION FROM TEST STANDARD

No deviation.

4.3.5 EUT OPERATING CONDITION

The software provided by client to enable the EUT under transmission condition continuously at lowest, middle and highest channel frequencies individually.

4.3.6 TEST RESULTS

The spectrum plots are attached on the following 4 images. D1 line indicates the highest level, and D2 line indicates the 50dB offset below D1. It shows compliance with the requirement in part 15.249 (d).



A D T

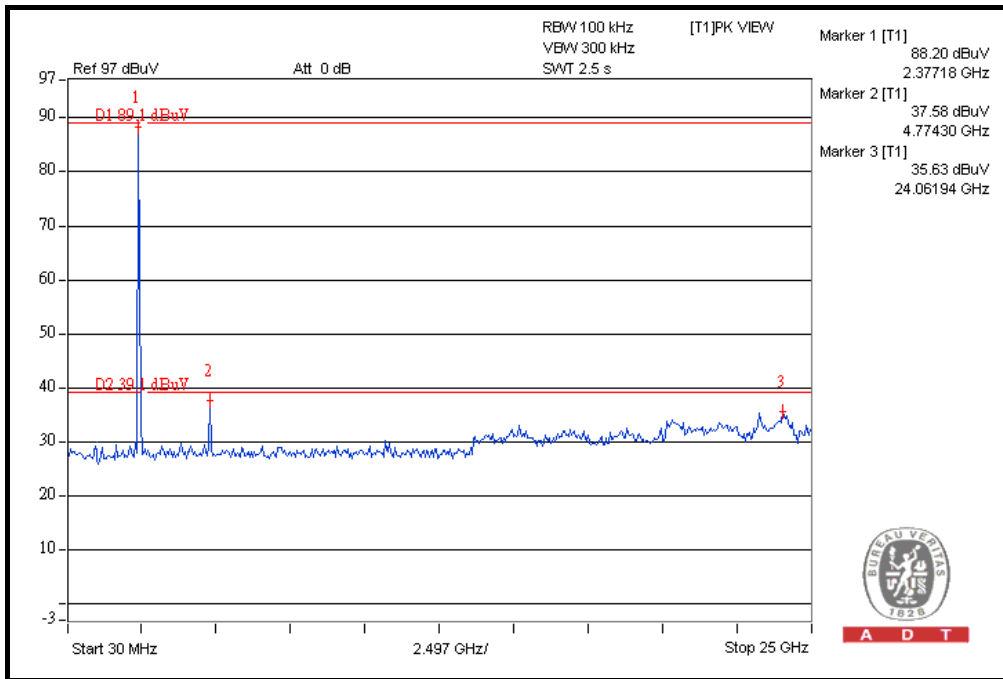
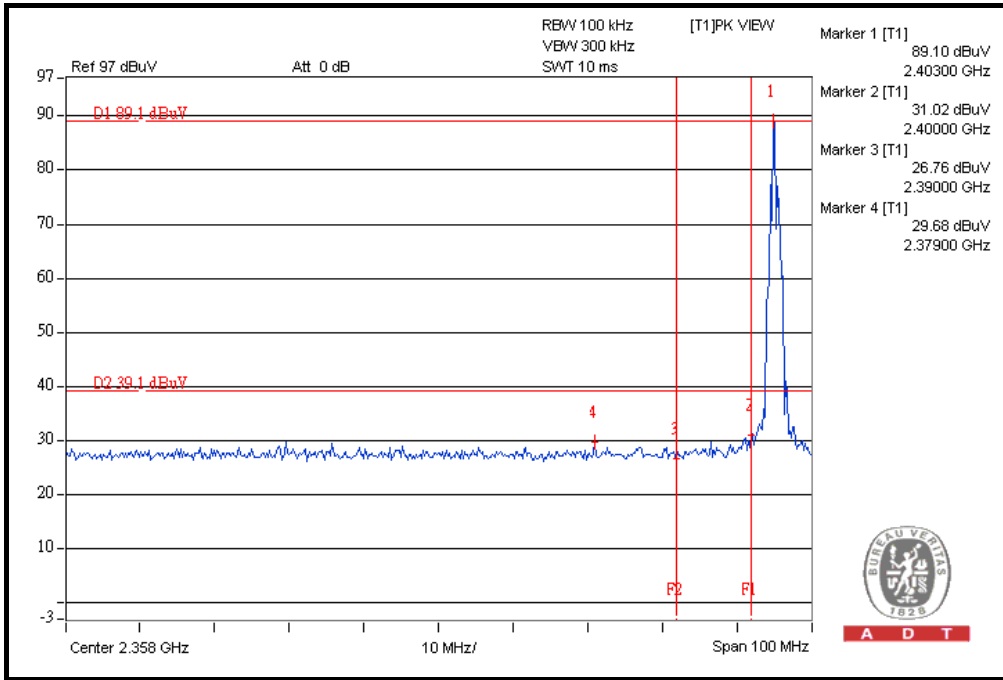



A D T

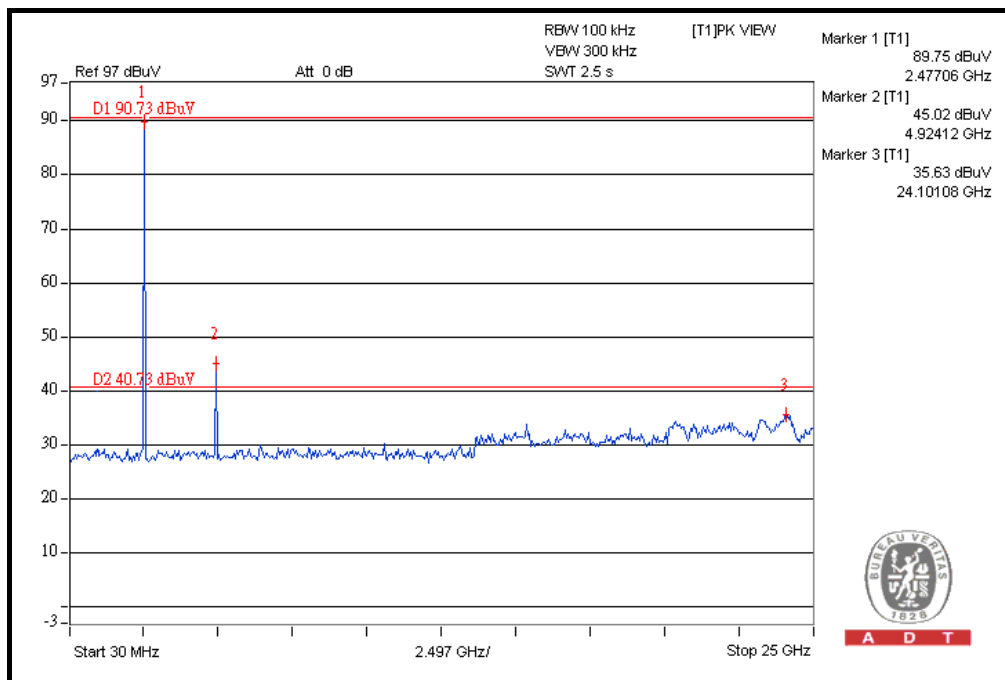
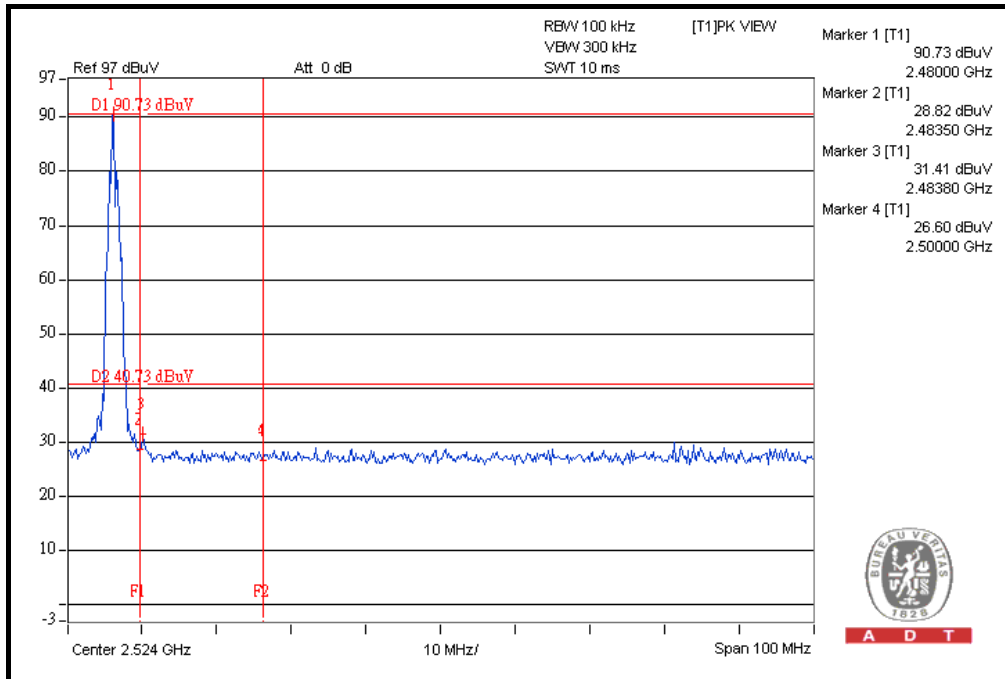



5. PHOTOGRAPHS OF THE TEST CONFIGURATION

Please refer to the attached file (Test Setup Photo).



6. INFORMATION ON THE TESTING LABORATORIES

We, Bureau Veritas Consumer Products Services (H.K.) Ltd., Taoyuan Branch, were founded in 1988 to provide our best service in EMC, Radio, Telecom and Safety consultation. Our laboratories are accredited and approved by the following approval agencies according to ISO/IEC 17025.

USA	FCC, NVLAP
Germany	TUV Rheinland
Japan	VCCI
Norway	NEMKO
Canada	INDUSTRY CANADA, CSA
R.O.C.	TAF, BSMI, NCC
Netherlands	Telefication
Singapore	GOST-ASIA(MOU)
Russia	CERTIS(MOU)

Copies of accreditation certificates of our laboratories obtained from approval agencies can be downloaded from our web site: www.adt.com.tw/index.5/phtml. If you have any comments, please feel free to contact us at the following:

Linko EMC/RF Lab
Tel: 886-2-26052180
Fax: 886-2-26051924

Hsin Chu EMC/RF Lab
Tel: 886-3-5935343
Fax: 886-3-5935342

Hwa Ya EMC/RF/Safety Telecom Lab
Tel: 886-3-3183232
Fax: 886-3-3185050

Web Site: www.adt.com.tw

The address and road map of all our labs can be found in our web site also

7. APPENDIX A - MODIFICATIONS RECORDERS FOR ENGINEERING CHANGES TO THE EUT BY THE LAB

No any modifications are made to the EUT by the lab during the test.

--- END ---