

FCC Radio TEST Report

FCC ID: GV3M01006-D

This report concerns (check one) : Original Grant Class I Change

Issued Date : Jul. 12, 2007

Project No. : 0707C040

Equipment : Receiver

Model No. : M01006-D

A p p l i c a n t : ACCO Brands.Inc.

A d d r e s s : No.1 333 Twin Dolphin Drive sixth Floor
Redwood Shores CA 94065, USA

Tested by:

Neutron Engineering Inc. EMC Laboratory

Date of Test:

Jul. 07, 2007 ~ Jul. 12, 2007

Testing Engineer : _____
(Jeff Yang)

Technical Manager : _____
(Steven Lu)

Authorized Signatory : _____
(Andy Chiu)

NEUTRON ENGINEERING INC.

No. 132-1, Lane 329, Sec. 2, Palain Rd.,
Shijr City, Taipei, Taiwan
TEL : (02) 2646-5426 FAX : (02) 2646-6815



Declaration

Neutron represents to the client that testing is done in accordance with standard procedures as applicable and that test instruments used has been calibrated with the standards traceable to National Measurement Laboratory (**NML**) of **R.O.C.**, or National Institute of Standards and Technology (**NIST**) of **U.S.A.**

Neutron's reports apply only to the specific samples tested under conditions. It is manufacture's responsibility to ensure that additional production units of this model are manufactured with the identical electrical and mechanical components. **Neutron** shall have no liability for any declarations, inferences or generalizations drawn by the client or others from **Neutron** issued reports.

Neutron's reports must not be used by the client to claim product endorsement by the authorities or any agency of the Government.

This report is the confidential property of the client. As a mutual protection to the clients, the public and **Neutron-self**, extracts from the test report shall not be reproduced except in full with **Neutron's** authorized written approval.

Neutron's laboratory quality assurance procedures are in compliance with the **ISO Guide 17025** requirements, and accredited by the conformity assessment authorities listed in this test report.

Limitation

For the use of the authority's logo is limited unless the Test Standard(s)/Scope(s)/Item(s) mentioned in this test report is (are) included in the conformity assessment authorities acceptance respective.

Table of Contents	Page
1 . CERTIFICATION	4
2 . SUMMARY OF TEST RESULTS	5
2.1 TEST FACILITY	6
2.2 MEASUREMENT UNCERTAINTY	6
3 . GENERAL INFORMATION	7
3.1 GENERAL DESCRIPTION OF EUT	7
3.2 DESCRIPTION OF TEST MODES	8
3.3 BLOCK DIGRAM SHOWING THE CONFIGURATION OF SYSTEM TESTED	9
3.4 DESCRIPTION OF SUPPORT UNITS	10
4 . EMC EMISSION TEST	11
4.1 CONDUCTED EMISSION MEASUREMENT	11
4.1.1 POWER LINE CONDUCTED EMISSION LIMITS	11
4.1.2 MEASUREMENT INSTRUMENTS LIST	11
4.1.3 TEST PROCEDURE	12
4.1.4 DEVIATION FROM TEST STANDARD	12
4.1.5 TEST SETUP	12
4.1.6 EUT OPERATING CONDITIONS	13
4.1.7 TEST RESULTS	14
4.2 RADIATED EMISSION MEASUREMENT	16
4.2.1 RADIATED EMISSION LIMITS	16
4.2.2 MEASUREMENT INSTRUMENTS LIST	17
4.2.3 TEST PROCEDURE	17
4.2.4 DEVIATION FROM TEST STANDARD	17
4.2.5 TEST SETUP	18
4.2.6 EUT OPERATING CONDITIONS	18
4.2.7 TEST RESULTS (Between 30 – 1000 MHz)	19
4.2.8 TEST RESULTS (Above 1000 MHz)	21
4.2.9 TEST RESULTS (2400 – 2483.5 MHz)	33
4.2.10 TEST RESULTS (Restricted Bands Requirements)	34
5 . EUT TEST PHOTO	39
Conducted Measurement Photos	39

1. CERTIFICATION

Equipment : Receiver
Trade Name : Kensington
Model No. : M01006-D
Applicant : ACCO Brands.Inc..
Date of Test : Jul. 07, 2007 ~ Jul. 12, 2007
Test Item : ENGINEERING SAMPLE
Standards : FCC Part15, Subpart C(15.249) / RSS-210: 2004/ ANCI C63.4 : 2003

The above equipment has been tested and found compliance with the requirement of the relative standards by Neutron Engineering Inc. EMC Laboratory.

The test data, data evaluation, and equipment configuration contained in our test report (Ref No. NEI-FCCP-1-0707C040) were obtained utilizing the test procedures, test instruments, test sites that has been accredited by the Authority of NVLAP and CNLA according to the ISO-17025 quality assessment standard and technical standard(s).

2. SUMMARY OF TEST RESULTS

Test procedures according to the technical standards:

FCC Part15, Subpart C			
Standard Section	Test Item	Judgment	Remark
15.207	Conducted Emission	PASS	
15.249	Radiated Spurious Emission	PASS	

NOTE:

(1) "N/A" denotes test is not applicable in this Test Report

2.1 TEST FACILITY

The test facilities used to collect the test data in this report is **C01/OS02** at the location of No.132-1, Lane 329, Sec. 2, Palain Road, Shijr City, Taipei, Taiwan.
Neutron's test firm number is 95335

2.2 MEASUREMENT UNCERTAINTY

The reported uncertainty of measurement $y \pm U$, where expended uncertainty **U** is based on a standard uncertainty multiplied by a coverage factor of **k=2**, providing a level of confidence of approximately **95 %**.

A. Conducted Measurement :

Test Site	Method	Measurement Frequency Range	U , (dB)	NOTE
C01	ANSI	150 KHz ~ 30MHz	1.94	

B. Radiated Measurement :

Test Site	Method	Measurement Frequency Range	Ant. H / V	U , (dB)	NOTE
OS-01	ANSI	30MHz ~ 200MHz	V	3.82	
		30MHz ~ 200MHz	H	3.60	
		200MHz ~ 1,000MHz	V	3.86	
		200MHz ~ 1,000MHz	H	3.94	
OS-02	ANSI	30MHz ~ 200MHz	V	2.48	
		30MHz ~ 200MHz	H	2.16	
		200MHz ~ 1,000MHz	V	2.50	
		200MHz ~ 1,000MHz	H	2.66	

3. GENERAL INFORMATION

3.1 GENERAL DESCRIPTION OF EUT

Equipment	Receiver	
Trade Name	Kensington	
Model No.	M01006-D	
OEM Brand/Model No.	N/A	
Model Difference	N/A	
Product Description	The EUT is a Receiver.	
	Product Type	Low Power Communication Device
	Operation Frequency:	2402~2480 MHz
	Modulation Type:	FSK
	Number Of Channel	16 CH
	Antenna Designation:	Integra
	Antenna Gain(Peak)	3.6 dBi
	Output Power:	86.14 dBuv/m (AV Max.)
Based on the application, features, or specification exhibited in User's Manual, the EUT is considered as an ITE/Computing Device. More details of EUT technical specification, please refer to the User's Manual.		
Channel List	Please refer to the Note 2.	
Power Source	From PC system	
Power Rating	DC 5.0V	
Connecting I/O Port(s)	Please refer to the User's Manual	

Note:

- For a more detailed features description, please refer to the manufacturer's specifications or the User's Manual.
-

Channel List							
Channel	Frequency (MHz)	Channel	Frequency (MHz)	Channel	Frequency (MHz)	Channel	Frequency (MHz)
01	2402	05	2425	09	2448	13	2471
02	2405	06	2428	10	2451	14	2474
03	2408	07	2431	11	2454	15	2477
04	2411	08	2434	12	2457	16	2480

3. Table for Filed Antenna

Ant.	Brand	Model Name	Antenna Type	Connector	Gain (dBi)
1	-	-	Printed Antenna	N/A	3.6

3.2 DESCRIPTION OF TEST MODES

To investigate the maximum EMI emission characteristics generates from EUT, the test system was pre-scanning tested base on the consideration of following EUT operation mode or test configuration mode which possible have effect on EMI emission level. Each of these EUT operation mode(s) or test configuration mode(s) mentioned above was evaluated respectively.

Pretest Test Mode	Description
Mode 1	CH Lower - 2402MHz
Mode 2	CH Middle - 2448MHz
Mode 3	CH Highest -2480MHz

For Conducted / Radiated Test	
Final Test Mode	Description
Mode 1	CH Lower - 2402MHz
Mode 2	CH Middle - 2448MHz
Mode 3	CH Highest -2480MHz

3.3 BLOCK DIGRAM SHOWING THE CONFIGURATION OF SYSTEM TESTED

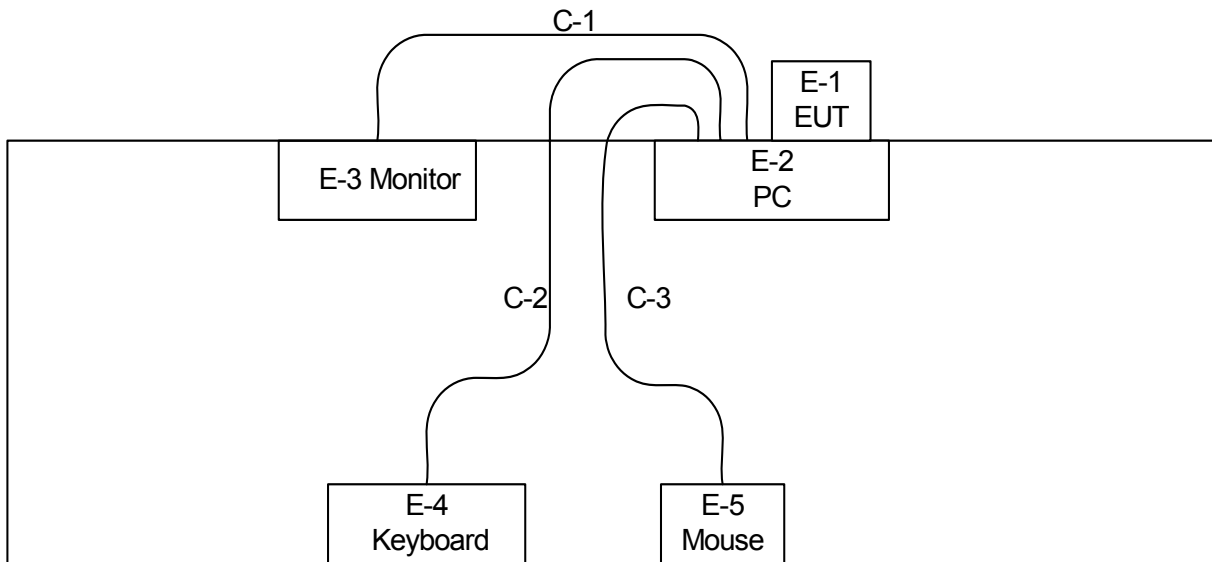

C-1 VGA Cable
C-2 USB Cable
C-3 USB Cable

3.4 DESCRIPTION OF SUPPORT UNITS

The EUT has been tested as an independent unit together with other necessary accessories or support units. The following support units or accessories were used to form a representative test configuration during the tests.

Item	Equipment	Mfr/Brand	Model/Type No.	FCC ID	Series No.	Note
E-1	Receiver	Kensington	M01006-D	GV3M01006-D	N/A	EUT
E-2	Keyboard	Dell	M-SAW34	DOC	N/A	
E-3	Mouse	Dell	M-UVDEL1	DOC	LNA44366861	
E-4	PC	HP	xw8200	DOC	SGH50402C3	
E-5	Monitor	DELL	N/A	N/A	N/A	

Item	Shielded Type	Ferrite Core	Length	Note
C-1	YES	YES	1.8M	
C-2	YES	NO	1.8M	
C-3	YES	NO	1.5M	

Note:

- (1) The support equipment was authorized by Declaration of Confirmation.
- (2) For detachable type I/O cable should be specified the length in cm in 『Length』 column.

4. EMC EMISSION TEST

4.1 CONDUCTED EMISSION MEASUREMENT

4.1.1 POWER LINE CONDUCTED EMISSION LIMITS (Frequency Range 150KHz-30MHz)

FREQUENCY (MHz)	Class A (dBuV)		Class B (dBuV)		Standard
	Quasi-peak	Average	Quasi-peak	Average	
0.15 -0.5	79.00	66.00	66 - 56 *	56 - 46 *	CISPR
0.50 -5.0	73.00	60.00	56.00	46.00	CISPR
5.0 -30.0	73.00	60.00	60.00	50.00	CISPR

0.15 -0.5	79.00	66.00	66 - 56 *	56 - 46 *	FCC
0.50 -5.0	73.00	60.00	56.00	46.00	FCC
5.0 -30.0	73.00	60.00	60.00	50.00	FCC

Note:

- (1) The tighter limit applies at the band edges.
- (2) The limit of " * " marked band means the limitation decreases linearly with the logarithm of the frequency in the range.

4.1.2 MEASUREMENT INSTRUMENTS LIST

Item	Kind of Equipment	Manufacturer	Type No.	Serial No.	Calibrated until
1	LISN	Rolf Heine	NNB-2/16Z	98053	Dec. 18, 2007
2	4L-V-LISN	Rolf Heine	NNB-4/63TL	02/10040	Mar. 05, 2008
3	Pulse Limiter	Electro-Metrics	EM-7600	112644	Nov. 28, 2007
4	50Ω Terminator	N/A	N/A	N/A	Apr.10, 2008
5	Test Cable	N/A	C01	N/A	Nov. 28, 2007
6	EMI Test Receiver	R&S	ESCI	100082	Jan. 31, 2008

Remark: " N/A" denotes No Model No. , Serial No. or No Calibration specified.

The following table is the setting of the receiver

Receiver Parameters	Setting
Attenuation	10 dB
Start Frequency	0.15 MHz
Stop Frequency	30 MHz
IF Bandwidth	9 kHz

4.1.3 TEST PROCEDURE

- a. The EUT was placed 0.4 meters from the horizontal ground plane with EUT being connected to the power mains through a line impedance stabilization network (LISN). All other support equipments powered from additional LISN(s). The LISN provide 50 Ohm/ 50uH of coupling impedance for the measuring instrument.
- b. Interconnecting cables that hang closer than 40 cm to the ground plane shall be folded back and forth in the center forming a bundle 30 to 40 cm long.
- c. I/O cables that are not connected to a peripheral shall be bundled in the center. The end of the cable may be terminated, if required, using the correct terminating impedance. The overall length shall not exceed 1 m.
- d. LISN at least 80 cm from nearest part of EUT chassis.
- e. For the actual test configuration, please refer to the related Item –EUT Test Photos.

4.1.4 DEVIATION FROM TEST STANDARD

No deviation

4.1.5 TEST SETUP

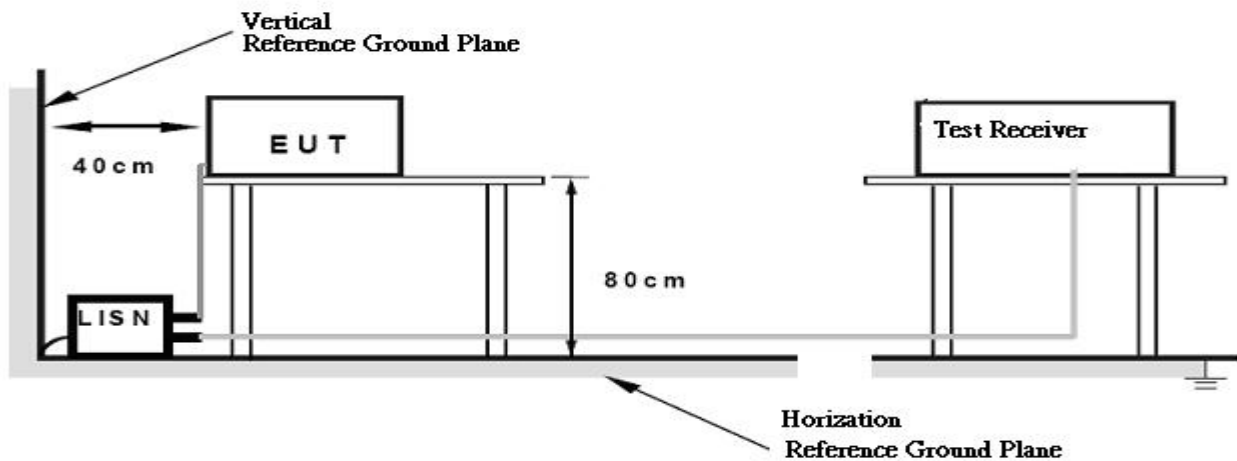

4.1.6 EUT OPERATING CONDITIONS

The EUT was configured for testing in a typical fashion (as a customer would normally use it). The EUT has been programmed to continuously transmit during test. This operating condition was tested and used to collect the included data.

4.1.7 TEST RESULTS

EUT :	Receiver	Model No. :	M01006-D
Temperature :	28 °C	Relative Humidity :	42 %
Pressure :	1008 hPa	Test Power :	AC 120V/60Hz
Test Mode :	Normal Link		

Freq. (MHz)	Terminal L/N	Measured(dBuV)		Limits(dBuV)		Margin (dB)	Note
		QP-Mode	AV-Mode	QP-Mode	AV-Mode		
0.19	Line	43.03	*	64.04	54.04	-21.01	(QP)
0.68	Line	36.72	*	56.00	46.00	-19.28	(QP)
3.12	Line	42.64	*	56.00	46.00	-13.36	(QP)
6.07	Line	51.11	*	60.00	50.00	-8.89	(QP)
6.07	Line	*	46.32	60.00	50.00	-3.68	(AV)
11.49	Line	52.86	*	60.00	50.00	-7.14	(QP)
11.49	Line	*	47.45	60.00	50.00	-2.55	(AV)
24.02	Line	45.77	*	60.00	50.00	-14.23	(QP)

Remark

- (1) All readings are QP Mode value unless otherwise stated AVG in column of Note. If the QP Mode Measured value compliance with the QP Limits and lower than AVG Limits, the EUT shall be deemed to meet both QP & AVG Limits and then only QP Mode was measured, but AVG Mode didn't perform. In this case, a "*" marked in AVG Mode column of Interference Voltage Measured.
- (2) Measuring frequency range from 150KHz to 30MHz.

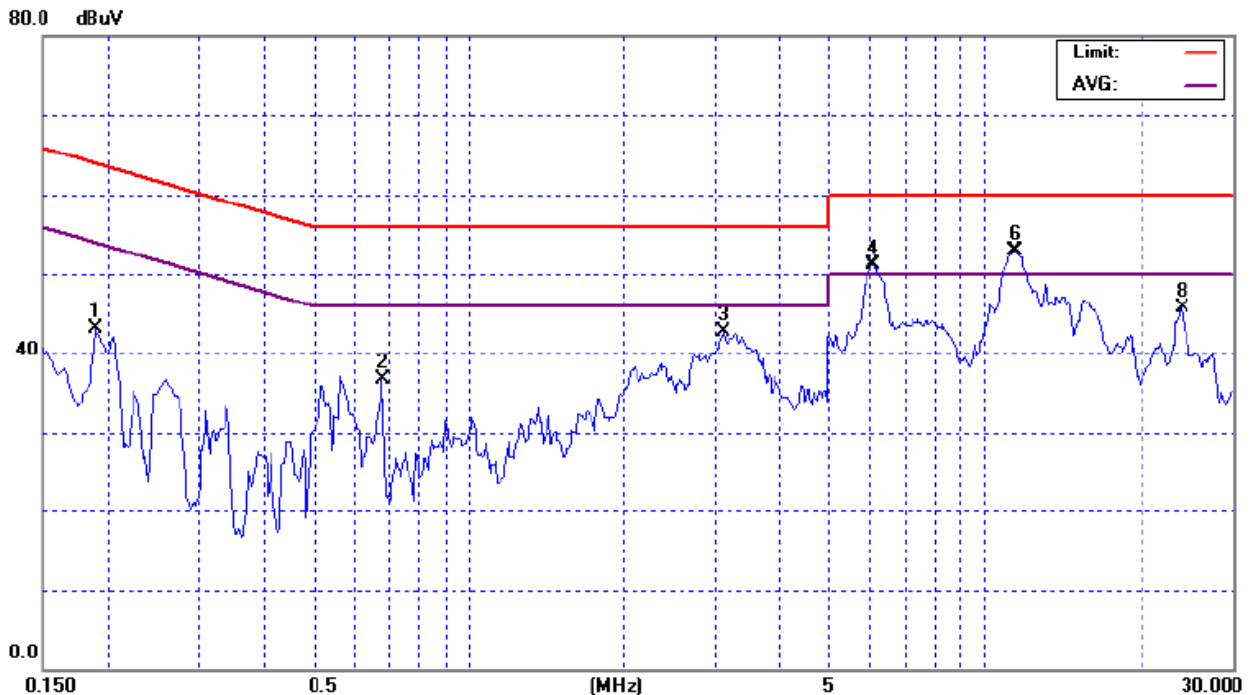

EUT :	Receiver	Model No. :	M01006-D
Temperature :	28 °C	Relative Humidity :	42 %
Pressure :	1008 hPa	Test Power :	AC 120V/60Hz
Test Mode :	Normal Link		

Freq. (MHz)	Terminal L/N	Measured(dBuV)		Limits(dBuV)		Margin (dB)	Note
		QP-Mode	AV-Mode	QP-Mode	AV-Mode		
0.26	Neutral	35.91	*	61.34	51.34	-25.43	(QP)
0.68	Neutral	36.55	*	56.00	46.00	-19.45	(QP)
3.25	Neutral	42.44	*	56.00	46.00	-13.56	(QP)
6.16	Neutral	49.30	*	60.00	50.00	-10.70	(QP)
11.34	Neutral	52.83	*	60.00	50.00	-7.17	(QP)
11.34	Neutral	*	36.53	60.00	50.00	-13.47	(AV)
24.01	Neutral	47.70	*	60.00	50.00	-12.30	(QP)

Remark

- (1) All readings are QP Mode value unless otherwise stated AVG in column of Note. If the QP Mode Measured value compliance with the QP Limits and lower than AVG Limits, the EUT shall be deemed to meet both QP & AVG Limits and then only QP Mode was measured, but AVG Mode didn't perform. In this case, a " * " marked in AVG Mode column of Interference Voltage Measured.
- (2) Measuring frequency range from 150KHz to 30MHz.

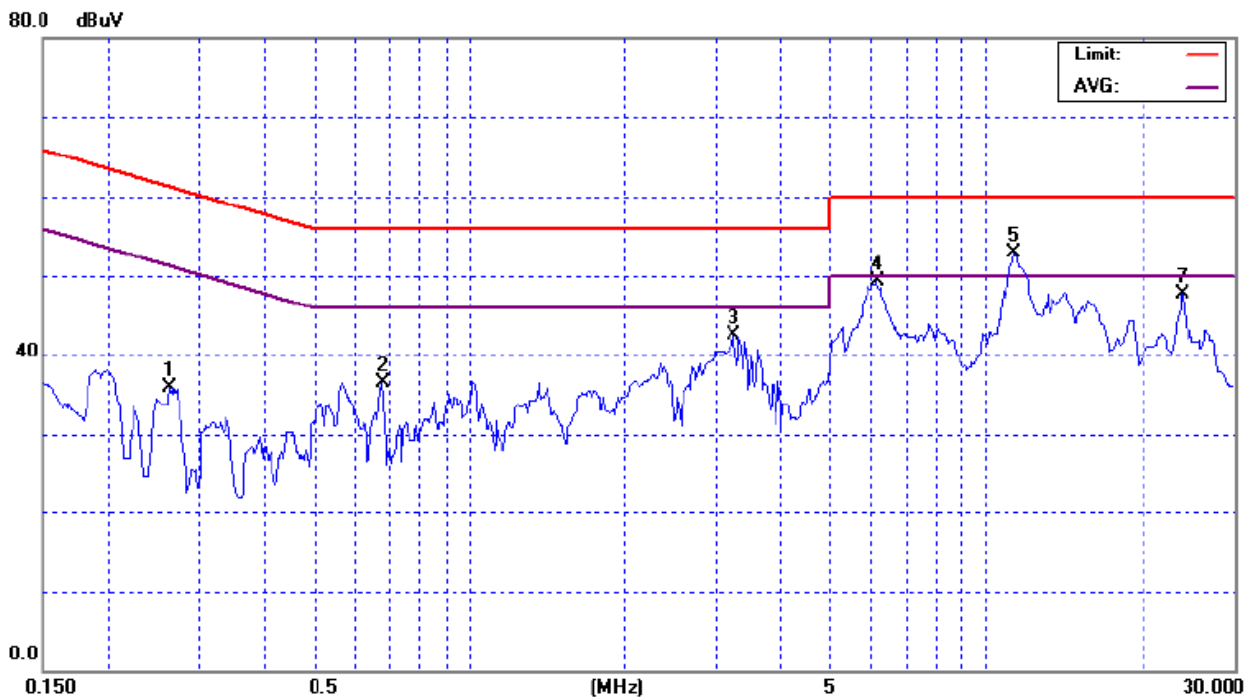

4.2 RADIATED EMISSION MEASUREMENT

4.2.1 RADIATED EMISSION LIMITS (FCC 15.209)

requencies (MHz)	Field Strength (micorvolts/meter)	Measurement Distance (meters)
0.009~0.490	2400/F(KHz)	300
0.490~1.705	24000/F(KHz)	30
1.705~30.0	30	30
30~88	100	3
88~216	150	3
216~960	200	3
Above 960	500	3

Harmonic emissions limits comply with below 54 dBuV/m at 3m. Other emissions radiated outside of the specified frequency bands, except for harmonics, shall be attenuated by at least 50 dB below the level of the fundamental or comply with the radiated emissions limits specified in section 15.209(a) limit in the table below has to be followed.

Note:

- (1) The tighter limit applies at the band edges.
- (2) Emission level (dBuV/m)=20log Emission level (uV/m).

LIMITS OF RADIATED EMISSION MEASUREMENT (FCC 15.209)

FREQUENCY (MHz)	Class A (dBuV/m) (at 3m)		Class B (dBuV/m) (at 3m)	
	PEAK	AVERAGE	PEAK	AVERAGE
Above 1000	80	60	74	54

Notes:

- (1) The limit for radiated test was performed according to FCC PART 15B.
- (2) The tighter limit applies at the band edges.
- (3) Emission level (dBuV/m)=20log Emission level (uV/m).

LIMITS OF RADIATED EMISSION MEASUREMENT (FCC Part 15.249)

FCC Part15 (15.249) , Subpart C	
Limit	Frequency Range (MHz)
Field strength of fundamental 50000 μ V/m (94 dB μ V/m) @ 3 m	2400-2483.5
Field strength of harmonics 500 μ V/m (54 dB μ V/m) @ 3 m	Above 2483.5

4.2.2 MEASUREMENT INSTRUMENTS LIST

Item	Kind of Equipment	Manufacturer	Type No.	Serial No.	Calibrated until
1	Log-Bicon Antenna	Schwarzbeck	VULB 9160	3058	Nov. 28, 2007
2	Test Cable	N/A	10M_OS02	N/A	Nov. 28, 2007
3	Test Cable	N/A	OS02-1/-2/-3	N/A	Nov. 28, 2007
4	Pre-Amplifier	Anritsu	MH648A	M09961	Nov. 28, 2007
5	EMI Test Receiver	R&S	ESCI	100082	Jan. 31, 2008
6	Antenna Mast	Chance Most	CMTB-1.5	N/A	N/A
7	Turn Table	Chance Most	CMTB-1.5	N/A	N/A
8	Spectrum Analyzer	R&S	FSP_40	100129	Jan. 08, 2008
9	Horn Antenna	Schwarzbeck	BBHA9120D	9120D-325	Oct. 25, 2007
10	Horn Antenna	Schwarzbeck	BBHA9170	9170187	Oct. 25, 2007
11	Microwave Pre_amplifier	Agilent	8449B	3008A01714	Mar. 10, 2008
12	Microflex Cable	United Microwave	57793	1m	Mar. 10, 2008
13	Microflex Cable	United Microwave	A30A30-500 6	10M	Jul. 07, 2008

Remark: " N/A" denotes No Model No. / Serial No. and No Calibration specified.

4.2.3 TEST PROCEDURE

- a. The measuring distance of at 3 m shall be used for measurements at frequency up to 1GHz. For frequencies above 1GHz, any suitable measuring distance may be used.
- b. The EUT was placed on the top of a rotating table 0.8 meters above the ground at a 3m meter open area test site. The table was rotated 360 degrees to determine the position of the highest radiation.
- c. The height of the equipment or of the substitution antenna shall be 0.8 m; the height of the test antenna shall vary between 1 m to 4 m. Both horizontal and vertical polarizations of the antenna are set to make the measurement.
- d. The initial step in collecting conducted emission data is a spectrum analyzer peak detector mode pre-scanning the measurement frequency range. Significant peaks are then marked and then Quasi Peak detector mode re-measured.
- e. If the Peak Mode measured value compliance with and lower than Quasi Peak Mode Limit, the EUT shall be deemed to meet QP Limits and then no additional QP Mode measurement performed.
- f. For the actual test configuration, please refer to the related Item –EUT Test Photos.

4.2.4 DEVIATION FROM TEST STANDARD

No deviation

4.2.5 TEST SETUP

(A) Radiated Emission Test Set-Up, Frequency Below 1000MHz

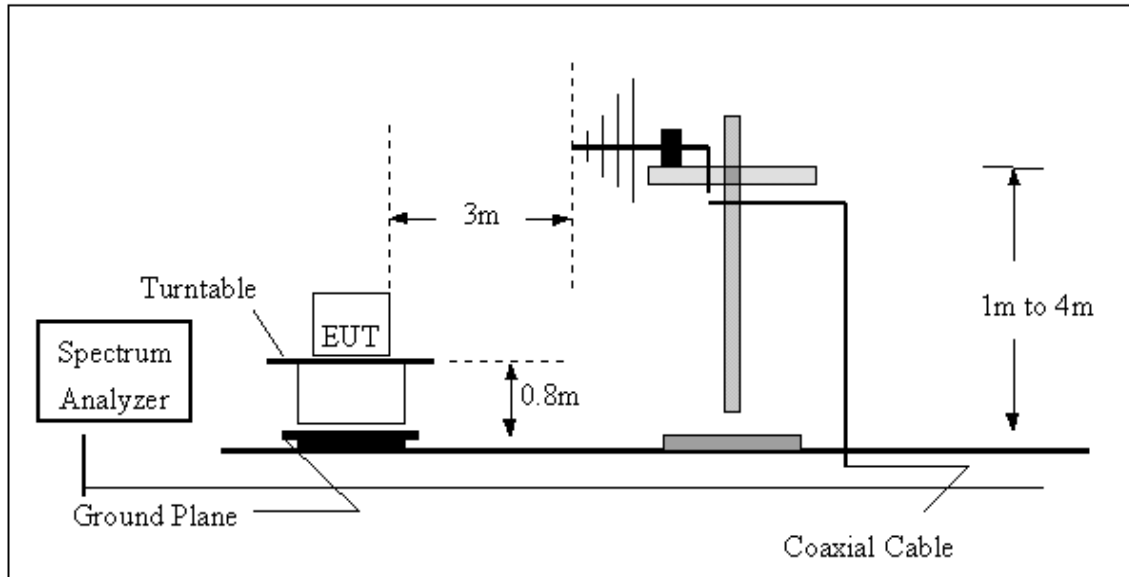

(B) Radiated Emission Test Set-Up Frequency Above 1 GHz

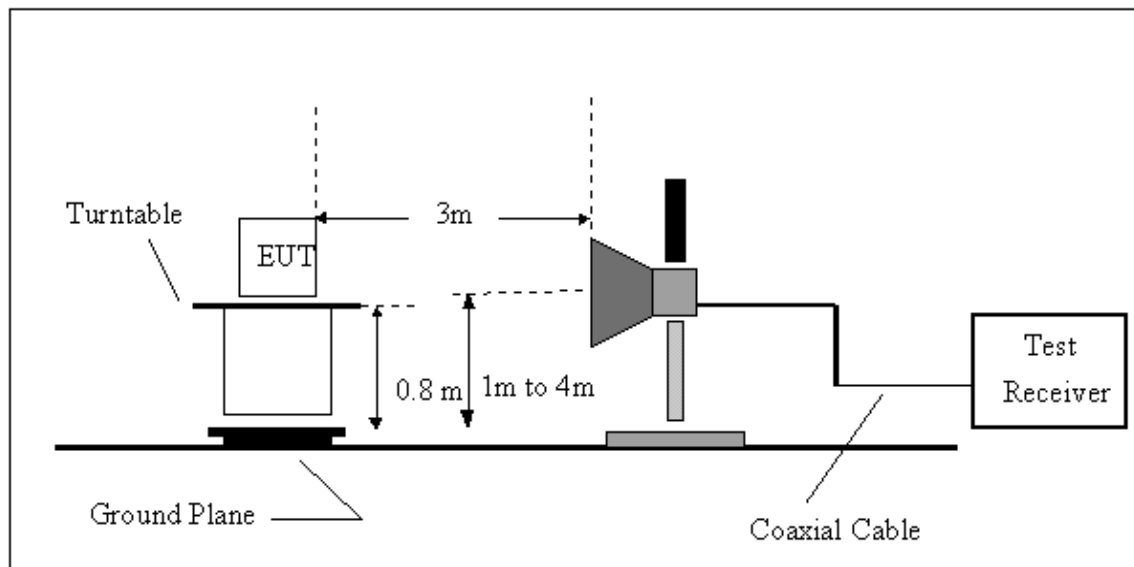

4.2.6 EUT OPERATING CONDITIONS

The EUT tested system was configured as the statements of 4.1.6 Unless otherwise a special operating condition is specified in the follows during the testing.

4.2.7 TEST RESULTS (Between 30 – 1000 MHz)

EUT :	Receiver	Model No. :	M01006-D
Temperature :	25 °C	Relative Humidity :	60 %
Pressure :	1010 hPa	Test Power :	AC 120V/60Hz
Test Mode :	TX mode CH 09-2448MHz		

Freq. (MHz)	Ant. H/V	Reading(RA) (dBuV)	Corr.Factor(CF) (dB)	Measured(FS) (dBuV/m)	Limits(QP) (dBuV/m)	Margin (dB)	Note
74.62	V	44.29	-24.64	19.65	40.00	- 20.35	
97.90	V	40.96	-23.17	17.79	43.50	- 25.71	
214.30	V	42.21	-20.09	22.12	43.50	- 21.38	
402.48	V	32.94	-14.55	18.39	46.00	- 27.61	
654.68	V	29.84	-9.85	19.99	46.00	- 26.01	
897.18	V	40.96	-6.36	34.60	46.00	- 11.40	

Remark :

- (1) All readings are Peak unless otherwise stated QP in column of 『Note』 . Peak denotes that the Peak reading compliance with the QP Limits and then QP Mode measurement didn't perform .
- (2) Measuring frequency range from 30MHz to 1000MHz or the 10th harmonic of highest fundamental frequency . “F” denotes fundamental frequency; “ H” denotes spurious frequency. “E” denotes band edge frequency.
- (3) Radiated emissions measured in frequency range from 30 MHz to 1000 MHz were made with an instrument using Peak detector mode or QP detector mode of the emission .
- (4) Data of measurement within this frequency range shown “ - ” in the table above means the reading of emissions are attenuated more than 20dB below the permissible limits or the field strength is too small to be measured.

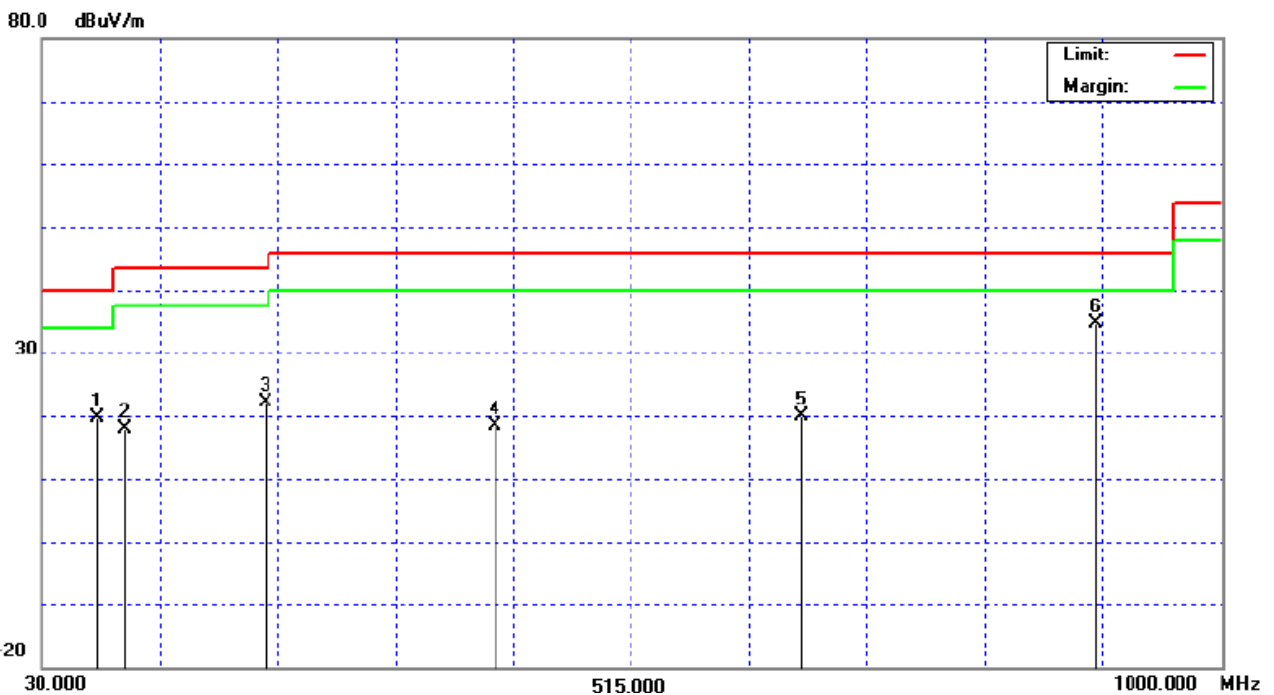

EUT :	Receiver	Model No. :	M01006-D
Temperature :	25 °C	Relative Humidity :	60 %
Pressure :	1010 hPa	Test Power :	AC 120V/60Hz
Test Mode :	TX mode CH 09-2448MHz		

Freq. (MHz)	Ant. H/V	Reading(RA) (dBuV)	Corr.Factor(CF) (dB)	Measured(FS) (dBuV/m)	Limits(QP) (dBuV/m)	Margin (dB)	Note
97.90	H	39.16	-23.17	15.99	43.50	- 27.51	
214.30	H	39.10	-20.09	19.01	43.50	- 24.49	
299.66	H	33.08	-17.85	15.23	46.00	- 30.77	
641.10	H	33.08	-9.87	23.21	46.00	- 22.79	
724.52	H	37.05	-8.83	28.22	46.00	- 17.78	
899.12	H	31.93	-6.34	25.59	46.00	- 20.41	

Remark :

- (1) All readings are Peak unless otherwise stated QP in column of 『Note』 . Peak denotes that the Peak reading compliance with the QP Limits and then QP Mode measurement didn't perform .
- (2) Measuring frequency range from 30MHz to 1000MHz or the 10th harmonic of highest fundamental frequency . "F" denotes fundamental frequency; " H" denotes spurious frequency. "E" denotes band edge frequency.
- (3) Radiated emissions measured in frequency range from 30 MHz to 1000 MHz were made with an instrument using Peak detector mode or QP detector mode of the emission .
- (4) Data of measurement within this frequency range shown " - " in the table above means the reading of emissions are attenuated more than 20dB below the permissible limits or the field strength is too small to be measured.

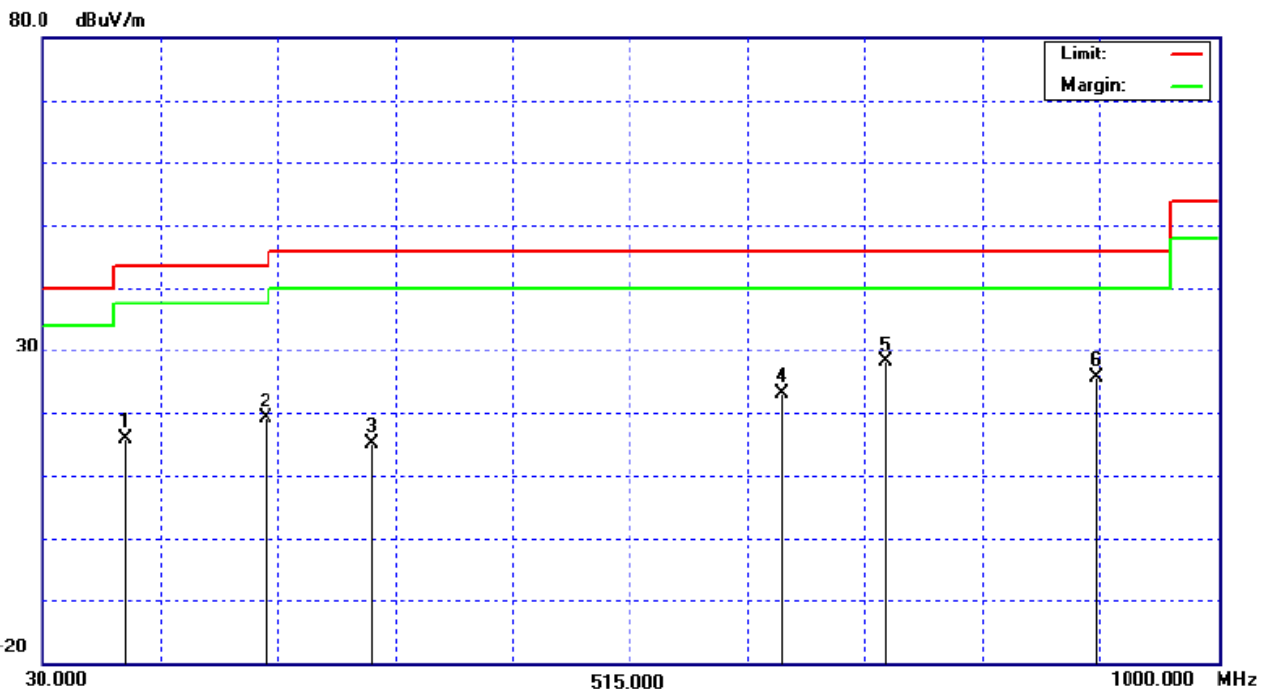

4.2.8 TEST RESULTS (Above 1000 MHz)

EUT :	Receiver	Model No. :	M01006-D
Temperature :	25 °C	Relative Humidity :	60 %
Pressure :	1010 hPa	Test Power :	AC 120V/60Hz
Test Mode :	TX CH 01-2402MHz		

Freq. (MHz)	Ant.Pol. H/V	Reading		Ant./CF CF(dB)	Act.		Limit		Note
		Peak (dBuV)	AV (dBuV)		Peak (dBuV/m)	AV (dBuV/m)	Peak (dBuV/m)	AV (dBuV/m)	
2390.00	V	30.76	19.41	32.05	62.81	51.46	74.00	54.00	X/E
2402.16	V	53.53	52.95	32.09	85.62	85.04	114.00	94.00	X/F
4804.24	V	49.89	47.52	3.51	53.40	51.03	74.00	54.00	X/H
7206.40	V	46.99	43.07	8.23	55.22	51.30	74.00	54.00	X/H

Remark :

- (1) All readings are Peak unless otherwise stated QP in column of 『Note』 . Peak denotes that the Peak reading compliance with the QP Limits and then QP Mode measurement didn't perform .
- (2) Measuring frequency range from 30MHz to 1000MHz or the 10th harmonic of highest fundamental frequency . "F" denotes fundamental frequency; "H" denotes spurious frequency. "E" denotes band edge frequency. (This judgment method includes the Band Edge Requirement.)
- (3) Radiated emissions measured in frequency range above 1000MHz were made with an instrument using Peak detector mode and AV detector mode of the emission .
- (4) Data of measurement within this frequency range shown " * " in the table above means the reading of emissions are attenuated more than 20dB below the permissible limits or the field strength is too small to be measured.
- (5) A preamp and high pass filter were used for this test in order to provide sufficient measurement sensitivity.
- (6) EUT Orthogonal Axes :
 "X" - denotes Laid on Table ; "Y" - denotes Vertical Stand ; "Z" - denotes Side Stand

Orthogonal Axes : X
TX CH 01 (Above 1000 MHz, Vertical)

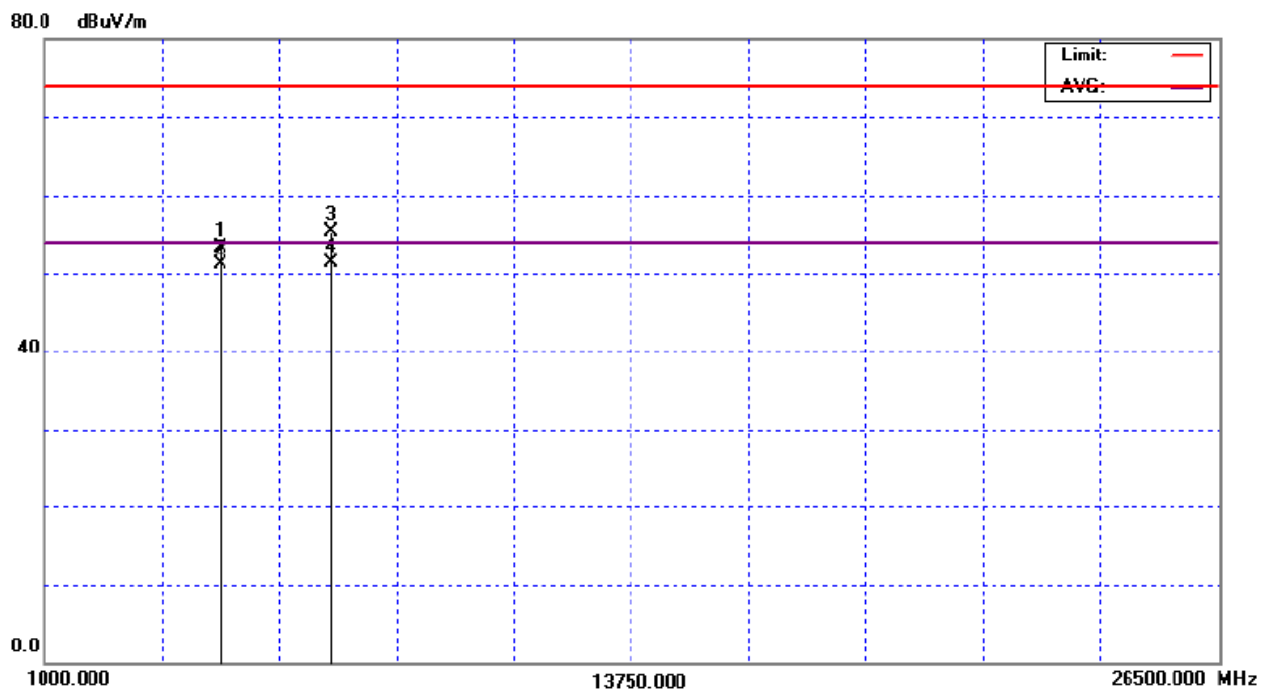
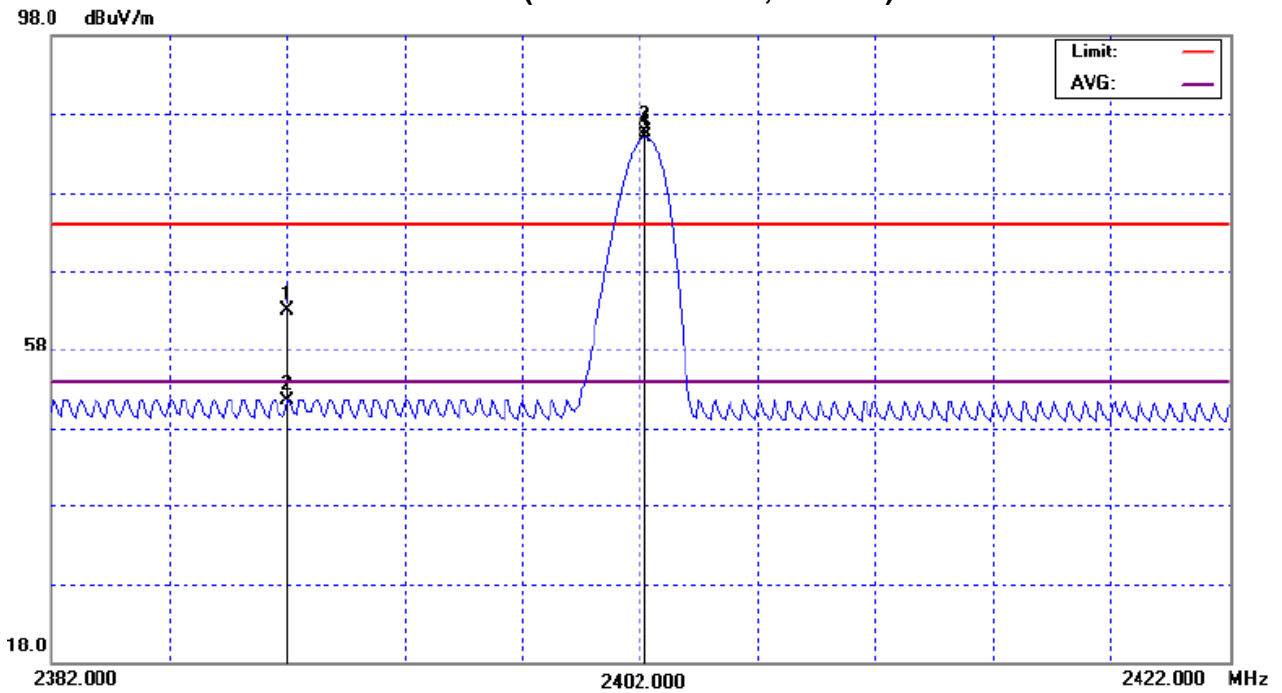

EUT :	Receiver	Model No. :	M01006-D
Temperature :	25 °C	Relative Humidity :	60 %
Pressure :	1010 hPa	Test Power :	AC 120V/60Hz
Test Mode :	TX CH 01-2402MHz		

Freq. (MHz)	Ant.Pol. H/V	Reading		Ant./CF CF(dB)	Act.		Limit		Note
		Peak (dBuV)	AV (dBuV)		Peak (dBuV/m)	AV (dBuV/m)	Peak (dBuV/m)	AV (dBuV/m)	
2390.00	H	25.23	19.35	32.05	57.28	51.40	74.00	54.00	X/E
2402.16	H	51.78	51.05	32.09	83.87	83.14	114.00	94.00	X/F
4804.32	H	52.16	50.29	3.51	55.67	53.80	74.00	54.00	X/H
7206.48	H	47.53	44.47	8.23	55.76	52.70	74.00	54.00	X/H

Remark :

- (1) All readings are Peak unless otherwise stated QP in column of 『Note』. Peak denotes that the Peak reading compliance with the QP Limits and then QP Mode measurement didn't perform.
- (2) Measuring frequency range from 30MHz to 1000MHz or the 10th harmonic of highest fundamental frequency. "F" denotes fundamental frequency; "H" denotes spurious frequency. "E" denotes band edge frequency. (This judgment method includes the Band Edge Requirement.)
- (3) Radiated emissions measured in frequency range above 1000MHz were made with an instrument using Peak detector mode and AV detector mode of the emission.
- (4) Data of measurement within this frequency range shown " * " in the table above means the reading of emissions are attenuated more than 20dB below the permissible limits or the field strength is too small to be measured.
- (5) A preamp and high pass filter were used for this test in order to provide sufficient measurement sensitivity.
- (6) EUT Orthogonal Axes :
 "X" - denotes Laid on Table ; "Y" - denotes Vertical Stand ; "Z" - denotes Side Stand

Orthogonal Axes : X
TX CH 01 (Above 1000 MHz, Horizontal)

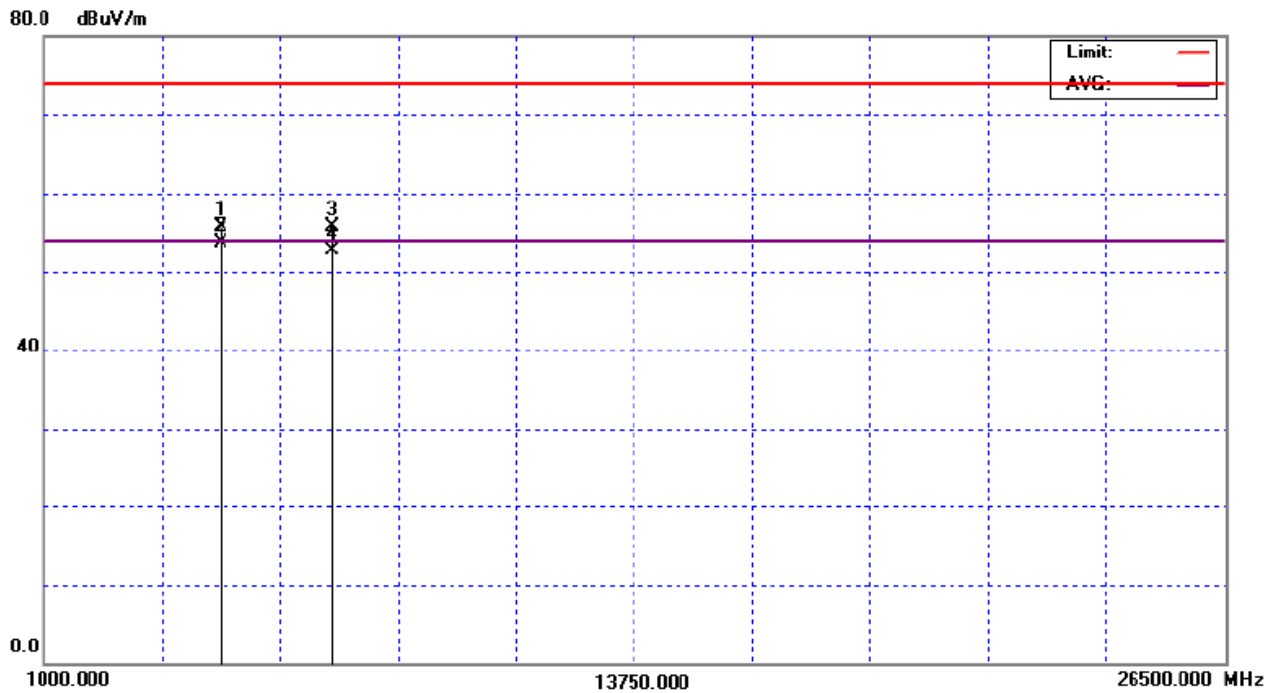
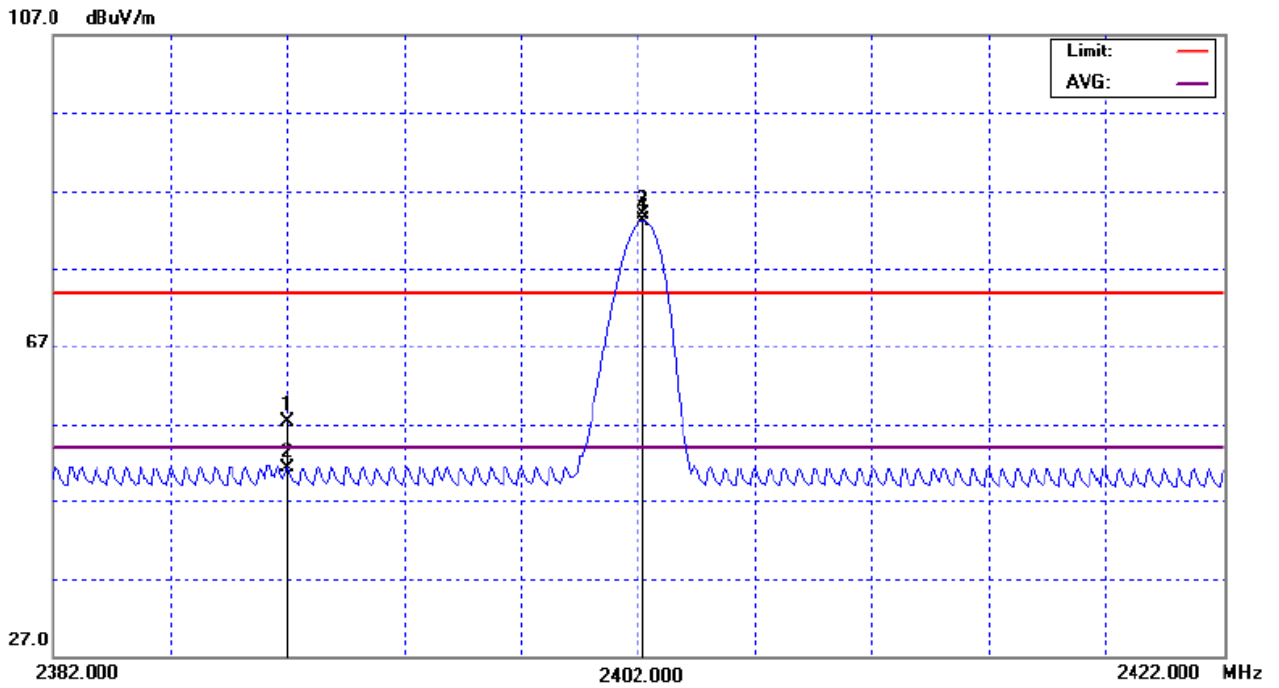

EUT :	Receiver	Model No. :	M01006-D
Temperature :	25 °C	Relative Humidity :	60 %
Pressure :	1010 hPa	Test Power :	AC 120V/60Hz
Test Mode :	TX CH 09-2448MHz		

Freq. (MHz)	Ant.Pol. H/V	Reading		Ant./CF CF(dB)	Act.		Limit		Note
		Peak (dBuV)	AV (dBuV)		Peak (dBuV/m)	AV (dBuV/m)	Peak (dBuV/m)	AV (dBuV/m)	
2448.16	V	48.82	47.84	32.23	81.05	80.07	114.00	94.00	X/F
4896.32	V	50.89	47.98	3.79	54.68	51.77	74.00	54.00	X/H
7344.32	V	50.51	45.14	8.78	59.29	53.92	74.00	54.00	X/H

Remark :

- (1) All readings are Peak unless otherwise stated QP in column of 『Note』 . Peak denotes that the Peak reading compliance with the QP Limits and then QP Mode measurement didn't perform .
- (2) Measuring frequency range from 30MHz to 1000MHz or the 10th harmonic of highest fundamental frequency .“F” denotes fundamental frequency; “H” denotes spurious frequency. “E” denotes band edge frequency. (This judgment method includes the Band Edge Requirement.)
- (3) Radiated emissions measured in frequency range above 1000MHz were made with an instrument using Peak detector mode and AV detector mode of the emission .
- (4) Data of measurement within this frequency range shown “ * ” in the table above means the reading of emissions are attenuated more than 20dB below the permissible limits or the field strength is too small to be measured.
- (5) A preamp and high pass filter were used for this test in order to provide sufficient measurement sensitivity.
- (6) EUT Orthogonal Axes :
 “X” - denotes Laid on Table ; “Y” - denotes Vertical Stand ; “Z” - denotes Side Stand

Orthogonal Axes : X
TX CH09 (Above 1000 MHz, Vertical)

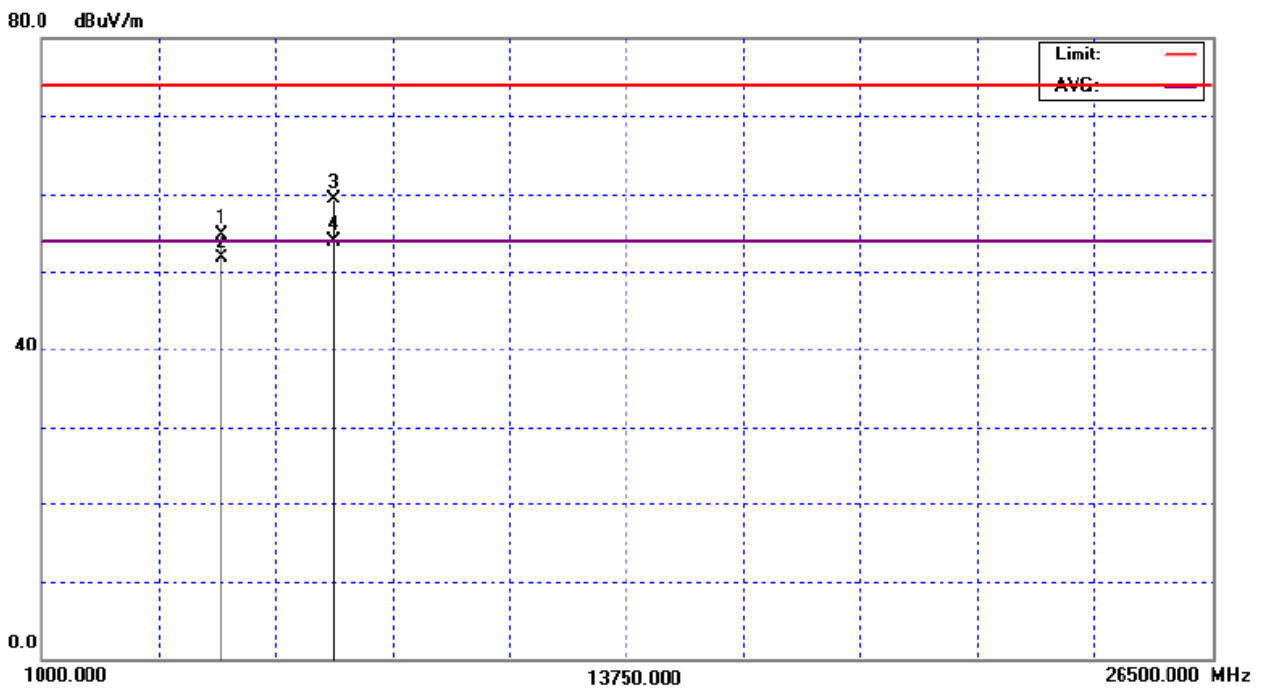
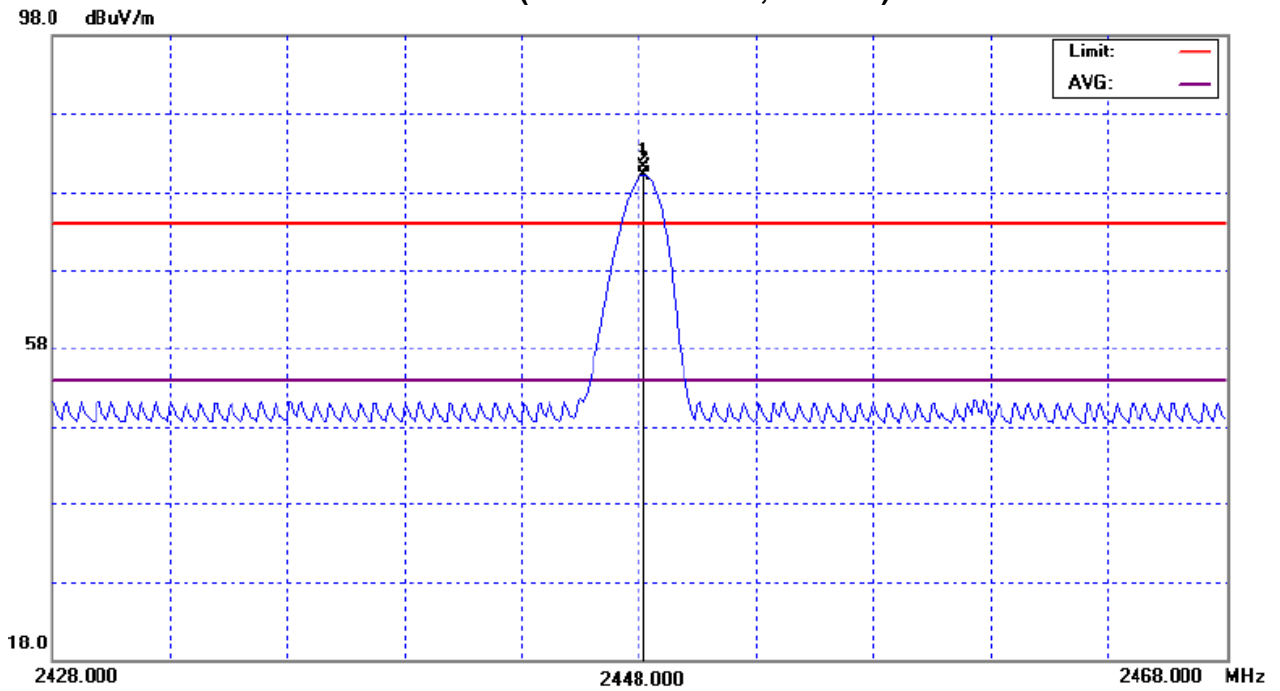

EUT :	Receiver	Model No. :	M01006-D
Temperature :	25 °C	Relative Humidity :	60 %
Pressure :	1010 hPa	Test Power :	AC 120V/60Hz
Test Mode :	TX CH 09-2448MHz		

Freq. (MHz)	Ant.Pol. H/V	Reading		Ant./CF CF(dB)	Act.		Limit		Note
		Peak (dBuV)	AV (dBuV)		Peak (dBuV/m)	AV (dBuV/m)	Peak (dBuV/m)	AV (dBuV/m)	
2448.16	H	54.59	53.91	32.23	86.82	86.14	114.00	94.00	X/F
4896.24	H	52.28	50.06	3.79	56.07	53.85	74.00	54.00	X/H
7344.40	H	50.21	46.80	8.78	58.99	55.58	74.00	54.00	X/H

Remark :

- (1) All readings are Peak unless otherwise stated QP in column of 『Note』 . Peak denotes that the Peak reading compliance with the QP Limits and then QP Mode measurement didn't perform .
- (2) Measuring frequency range from 30MHz to 1000MHz or the 10th harmonic of highest fundamental frequency . "F" denotes fundamental frequency; "H" denotes spurious frequency. "E" denotes band edge frequency. (This judgment method includes the Band Edge Requirement.)
- (3) Radiated emissions measured in frequency range above 1000MHz were made with an instrument using Peak detector mode and AV detector mode of the emission .
- (4) Data of measurement within this frequency range shown " * " in the table above means the reading of emissions are attenuated more than 20dB below the permissible limits or the field strength is too small to be measured.
- (5) A preamp and high pass filter were used for this test in order to provide sufficient measurement sensitivity.
- (6) EUT Orthogonal Axes :
 "X" - denotes Laid on Table ; "Y" - denotes Vertical Stand ; "Z" - denotes Side Stand

Orthogonal Axes : X
TX CH 09 (Above 1000 MHz, Horizontal)

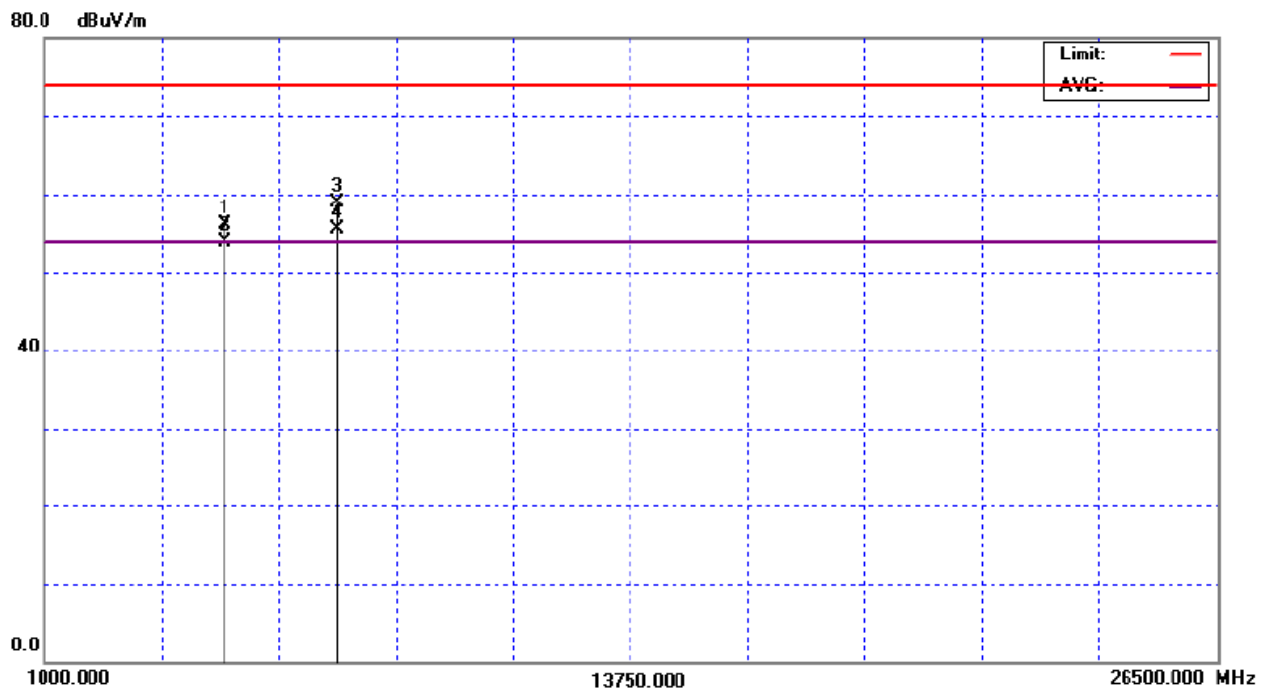
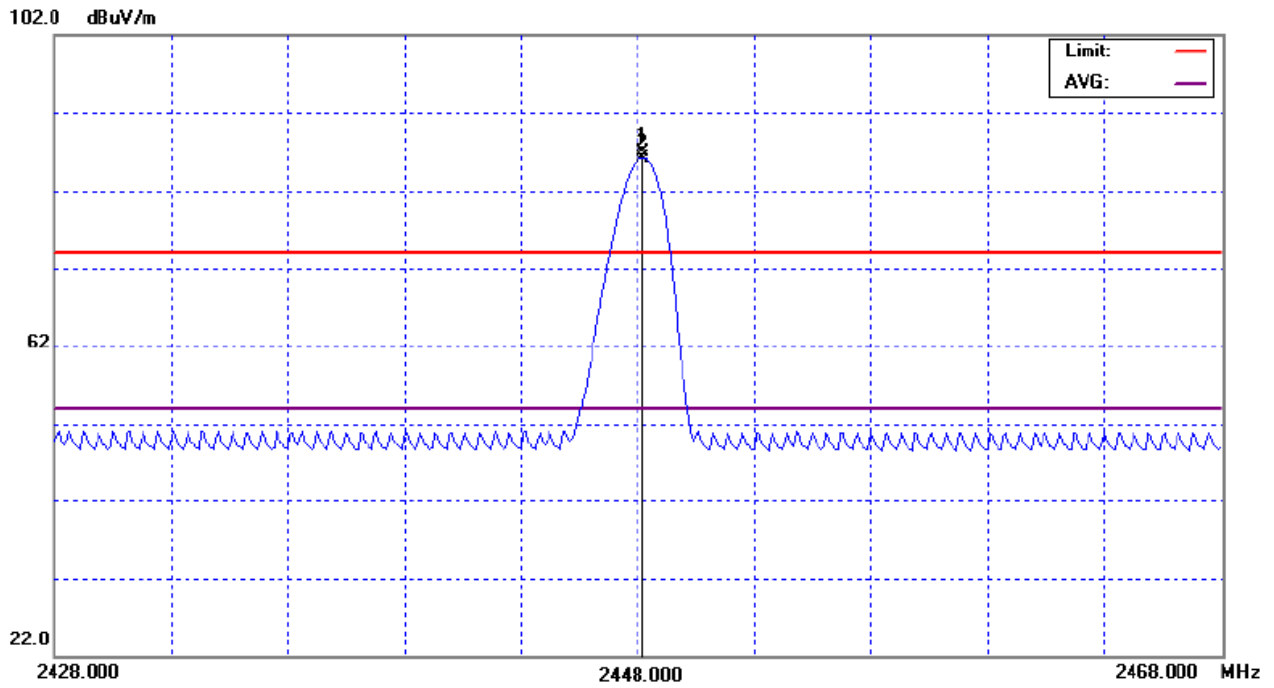

EUT :	Receiver	Model No. :	M01006-D
Temperature :	25 °C	Relative Humidity :	60 %
Pressure :	1010 hPa	Test Power :	AC 120V/60Hz
Test Mode :	TX CH 16-2480MHz		

Freq. (MHz)	Ant.Pol. H/V	Reading		Ant./CF CF(dB)	Act.		Limit		Note
		Peak (dBuV)	AV (dBuV)		Peak (dBuV/m)	AV (dBuV/m)	Peak (dBuV/m)	AV (dBuV/m)	
2480.16	V	52.61	51.67	32.34	84.95	84.01	114.00	94.00	X/F
2483.52	V	26.51	16.48	32.35	58.86	48.83	74.00	54.00	X/E
4960.32	V	52.04	49.22	3.98	56.02	53.20	74.00	54.00	X/H
7440.32	V	45.38	39.91	9.16	54.54	49.07	74.00	54.00	X/H

Remark :

- (1) All readings are Peak unless otherwise stated QP in column of 『Note』 . Peak denotes that the Peak reading compliance with the QP Limits and then QP Mode measurement didn't perform ◦
- (2) Measuring frequency range from 30MHz to 1000MHz or the 10th harmonic of highest fundamental frequency ◦ "F" denotes fundamental frequency; "H" denotes spurious frequency. "E" denotes band edge frequency. (This judgment method includes the Band Edge Requirement.)
- (3) Radiated emissions measured in frequency range above 1000MHz were made with an instrument using Peak detector mode and AV detector mode of the emission ◦
- (4) Data of measurement within this frequency range shown " * " in the table above means the reading of emissions are attenuated more than 20dB below the permissible limits or the field strength is too small to be measured.
- (5) A preamp and high pass filter were used for this test in order to provide sufficient measurement sensitivity.
- (6) EUT Orthogonal Axes :
 "X" - denotes Laid on Table ; "Y" - denotes Vertical Stand ; "Z" - denotes Side Stand

Orthogonal Axes : X
TX CH 16 (Above 1000 MHz, Vertical)

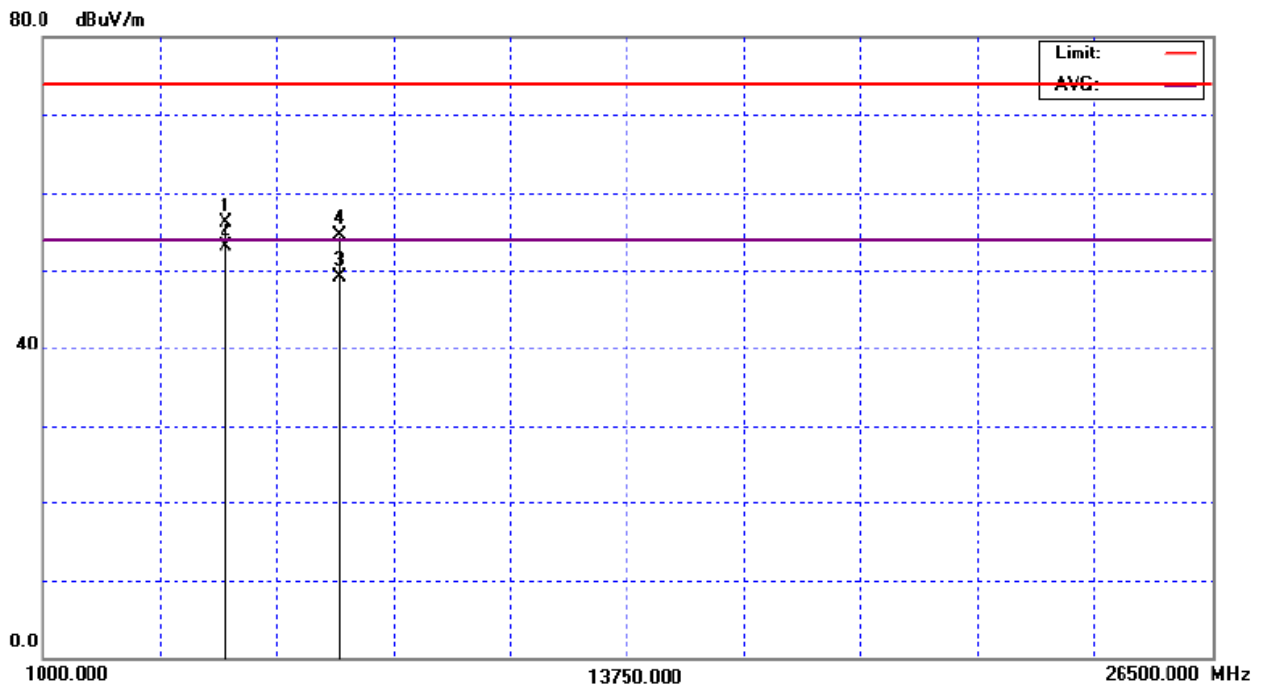
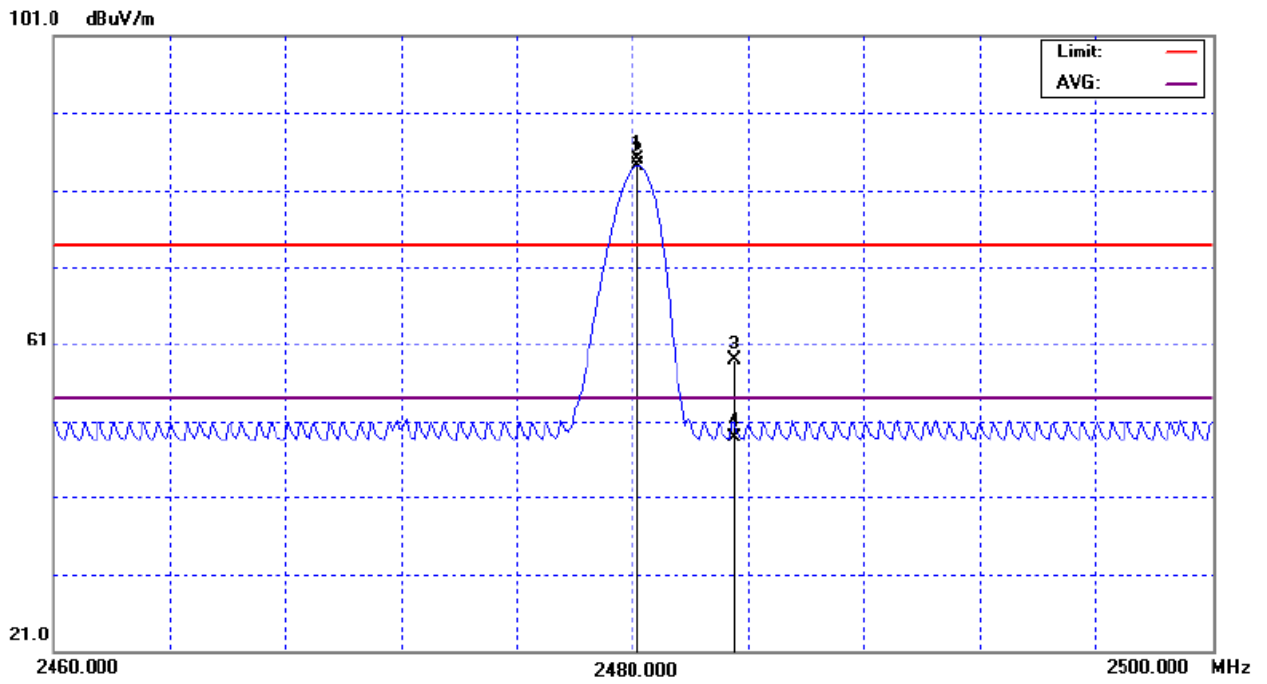

EUT :	Receiver	Model No. :	M01006-D
Temperature :	25 °C	Relative Humidity :	60 %
Pressure :	1010 hPa	Test Power :	AC 120V/60Hz
Test Mode :	TX CH 16-2480MHz		

Freq. (MHz)	Ant.Pol. H/V	Reading		Ant./CF CF(dB)	Act.		Limit		Note
		Peak (dBuV)	AV (dBuV)		Peak (dBuV/m)	AV (dBuV/m)	Peak (dBuV/m)	AV (dBuV/m)	
2480.16	H	54.55	53.60	32.34	86.89	85.94	114.00	94.00	X/F
2483.52	H	29.91	16.56	32.35	62.26	48.91	74.00	54.00	X/E
1240.08	H	47.77	41.66	-8.35	39.42	33.31	74.00	54.00	
4960.32	H	50.53	47.70	3.98	54.51	51.68	74.00	54.00	X/H
7440.48	H	45.92	43.39	9.16	55.08	52.55	74.00	54.00	X/H

Remark :

- (1) All readings are Peak unless otherwise stated QP in column of 『Note』 . Peak denotes that the Peak reading compliance with the QP Limits and then QP Mode measurement didn't perform .
- (2) Measuring frequency range from 30MHz to 1000MHz or the 10th harmonic of highest fundamental frequency .“F” denotes fundamental frequency; “H” denotes spurious frequency. “E” denotes band edge frequency. (This judgment method includes the Band Edge Requirement.)
- (3) Radiated emissions measured in frequency range above 1000MHz were made with an instrument using Peak detector mode and AV detector mode of the emission .
- (4) Data of measurement within this frequency range shown “ * ” in the table above means the reading of emissions are attenuated more than 20dB below the permissible limits or the field strength is too small to be measured.
- (5) A preamp and high pass filter were used for this test in order to provide sufficient measurement sensitivity.
- (6) EUT Orthogonal Axes :
“X” - denotes Laid on Table ; “Y” - denotes Vertical Stand ; “Z” - denotes Side Stand

Orthogonal Axes : X
TX CH 16 (Above 1000 MHz, Horizontal)

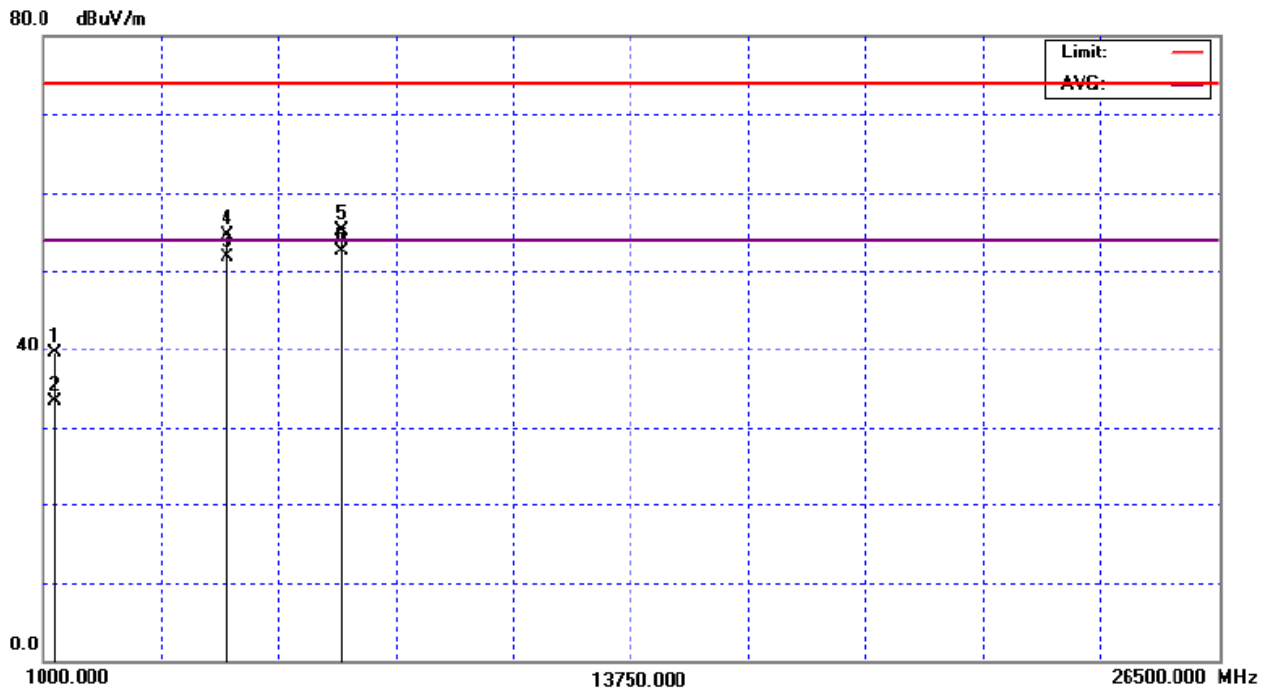
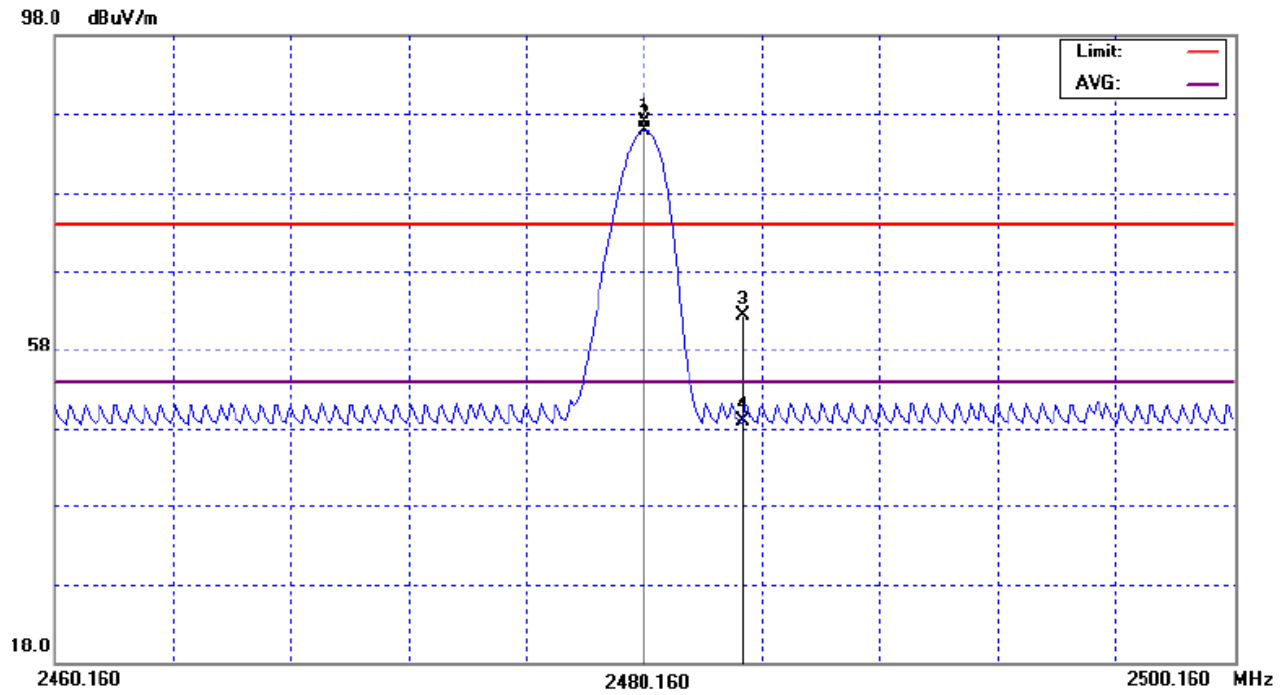

4.2.9 TEST RESULTS (2400 – 2483.5 MHz)

EUT :	Receiver	Model No. :	M01006-D
Temperature :	25 °C	Relative Humidity :	60 %
Pressure :	1009 hPa	Test Power :	AC 120V/60Hz
Test Mode :	TX CH 2402MHz/2448MHz/2480MHz		

Freq. (MHz)	Ant.Pol. (H/V)	Peak		Ant./CL/ CF(dB)	AV		Peak		AV		NOTE
		Reading (dBuV)	(dBuV)		Actual FS (dBuV/m)	(dBuV/m)	Limit3m (dBuV/m)	(dBuV/m)			
2402.2	V	53.53	52.95	32.09	85.62	85.04	114.00	94.00	CH01		
2402.2	H	51.78	51.05	32.09	83.87	83.14	114.00	94.00	CH01		
2448.2	V	48.82	47.84	32.23	81.05	80.07	114.00	94.00	CH08		
2448.2	H	54.59	53.91	32.23	86.82	86.14	114.00	94.00	CH08		
2480.2	V	52.61	51.67	32.34	84.95	84.01	114.00	94.00	CH16		
2480.2	H	54.55	53.60	32.34	86.89	85.94	114.00	94.00	CH16		

Remark :

- (1) All readings are Peak unless otherwise stated QP in column of 『Note 』 . Peak denotes that the Peak reading compliance with the QP Limits and then QP Mode measurement didn't perform .
- (2) Radiated emissions measured in frequency range above 1000MHz were made with an instrument using Peak detector mode and AV detector mode of the emission .
- (3) Data of measurement within this frequency range shown “ * ” in the table above means the reading of emissions are attenuated more than 20dB below the permissible limits or the field strength is too small to be measured.
- (4) EUT Orthogonal Axes :
“X” - denotes Laid on Table ; “Y” - denotes Vertical Stand ; “Z” - denotes Side Stand

4.2.10 TEST RESULTS (Restricted Bands Requirements)

EUT :	Receiver	Model No. :	M01006-D
Temperature :	25 °C	Relative Humidity :	60 %
Pressure :	1009 hPa	Test Power :	AC 120V/60Hz
Test Mode :	TX CH 01/16 (Vertical)		
Note :	<p>The emission of the carrier radiated field strength is measured for Receiver (Peak and AV) as following:</p> <ol style="list-style-type: none"> 1. The transmitter was then configured with the worst case antenna and setup to transmit at the lowest channel (CH01). Then the field strength was measured at 2310-2390 MHz. 2. The transmitter was configured with the worst case antenna and setup to transmit at the highest channel (CH16). Then the field strength was measured at 2483.5-2500 MHz. 		

Freq. (MHz)	Ant.Pol. H/V	Reading		Ant./CF CF(dB)	Act.		Limit		Note
		Peak (dBuV)	AV (dBuV)		Peak (dBuV/m)	AV (dBuV/m)	Peak (dBuV/m)	AV (dBuV/m)	
2390.00	V	30.76	19.41	32.05	62.81	51.46	74.00	54.00	CH01
2483.52	V	26.51	16.48	32.35	58.86	48.83	74.00	54.00	CH16

Remark :

- (1) Radiated emissions measured in frequency range above 1000MHz were made with an instrument using Peak detector mode and AV detector mode of the emission .
- (2) EUT Orthogonal Axes :
 "X" - denotes Laid on Table ; "Y" - denotes Vertical Stand ; "Z" - denotes Side Stand

TX CH 01 (Restricted Bands Requirements, Vertical)

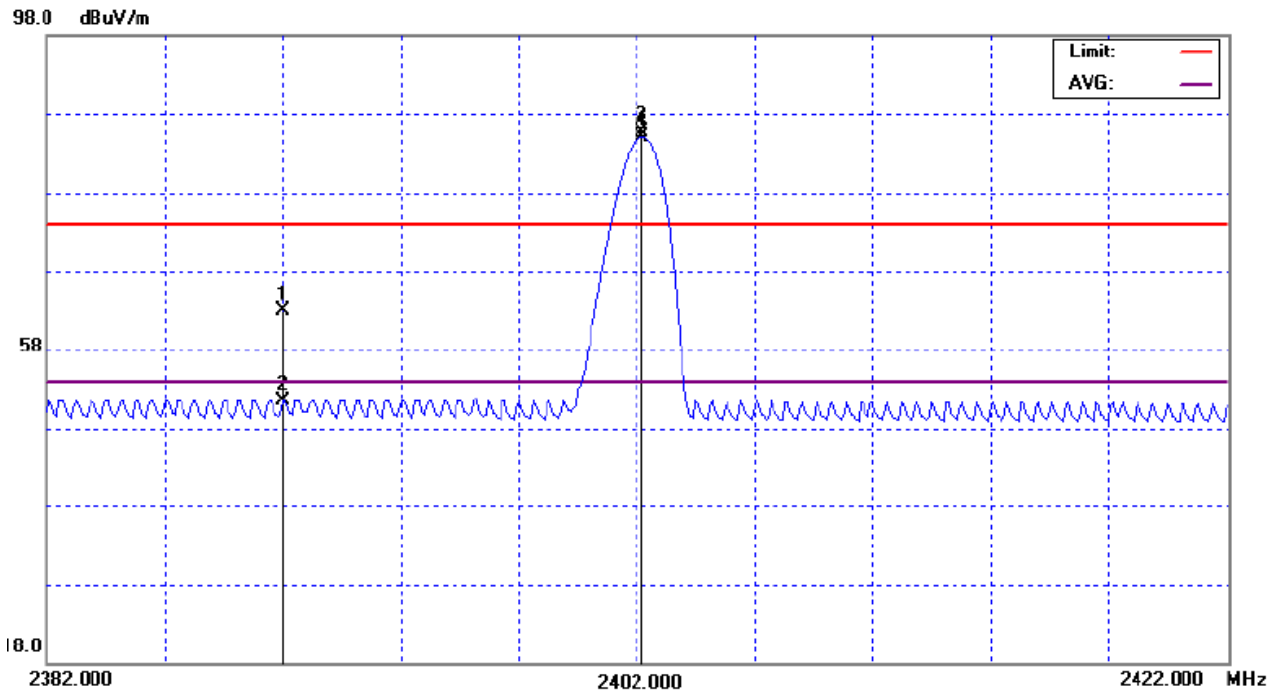

TX CH 16 (Restricted Bands Requirements, Vertical)

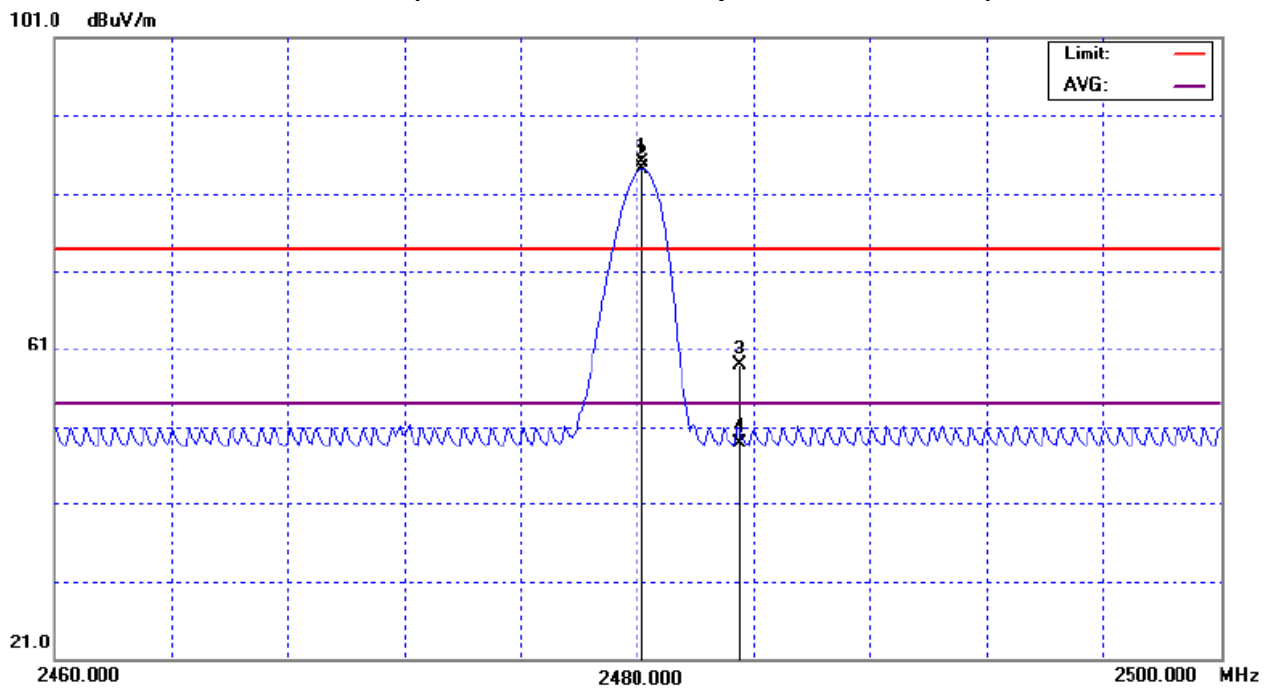

EUT :	Receiver	Model No. :	M01006-D
Temperature :	25 °C	Relative Humidity :	60 %
Pressure :	1009 hPa	Test Power :	AC 120V/60Hz
Test Mode :	TX CH CH 1/16(Horizontal)		
Note :	<p>The emission of the carrier radiated field strength is measured for Receiver (Peak and AV) as following:</p> <ol style="list-style-type: none"> 1. The transmitter was then configured with the worst case antenna and setup to transmit at the lowest channel (CH01). Then the field strength was measured at 2310-2390 MHz. 2. The transmitter was configured with the worst case antenna and setup to transmit at the highest channel (CH16). Then the field strength was measured at 2483.5-2500 MHz. 		

Freq. (MHz)	Ant.Pol. H/V	Reading		Ant./CF CF(dB)	Act.		Limit		Note
		Peak (dBuV)	AV (dBuV)		Peak (dBuV/m)	AV (dBuV/m)	Peak (dBuV/m)	AV (dBuV/m)	
2390.00	H	25.23	19.35	32.05	57.28	51.40	74.00	54.00	CH01
2483.52	H	29.91	16.56	32.35	62.26	48.91	74.00	54.00	CH16

Remark :

- (1) Radiated emissions measured in frequency range above 1000MHz were made with an instrument using Peak detector mode and AV detector mode of the emission .
- (2) EUT Orthogonal Axes :
 "X" - denotes Laid on Table ; "Y" - denotes Vertical Stand ; "Z" - denotes Side Stand

TX CH 01 (Restricted Bands Requirements, Horizontal)

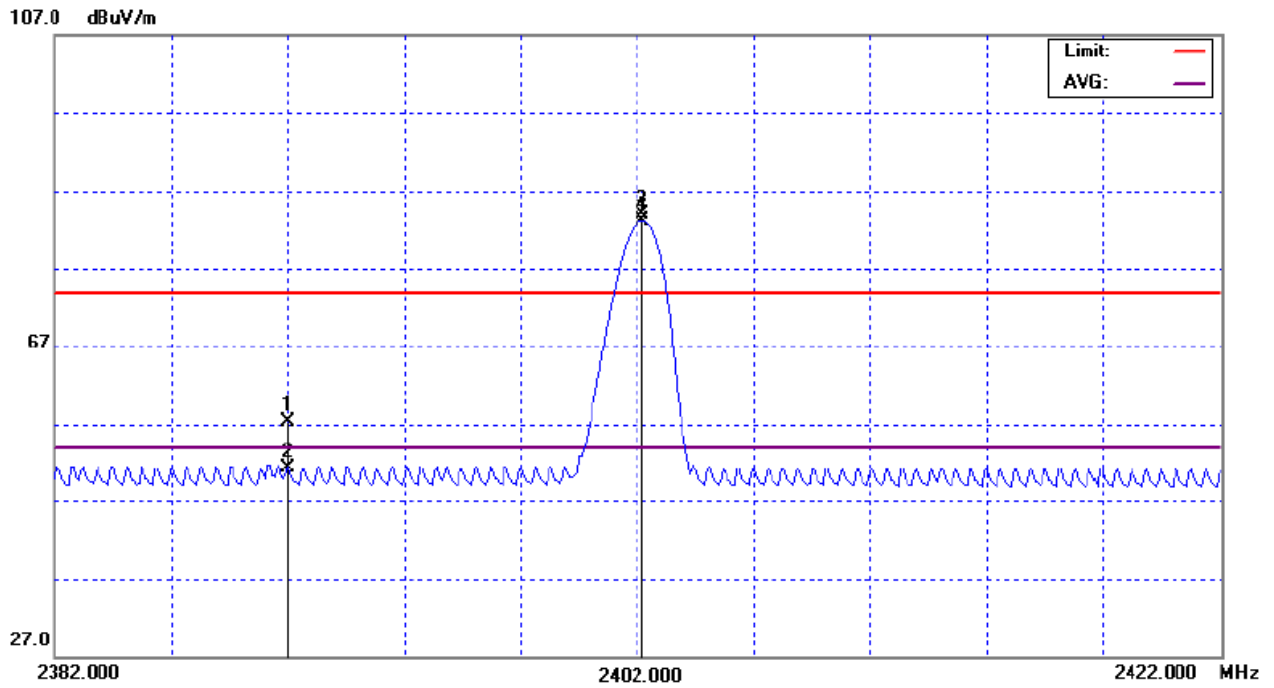

TX CH 16 (Restricted Bands Requirements, Horizontal)

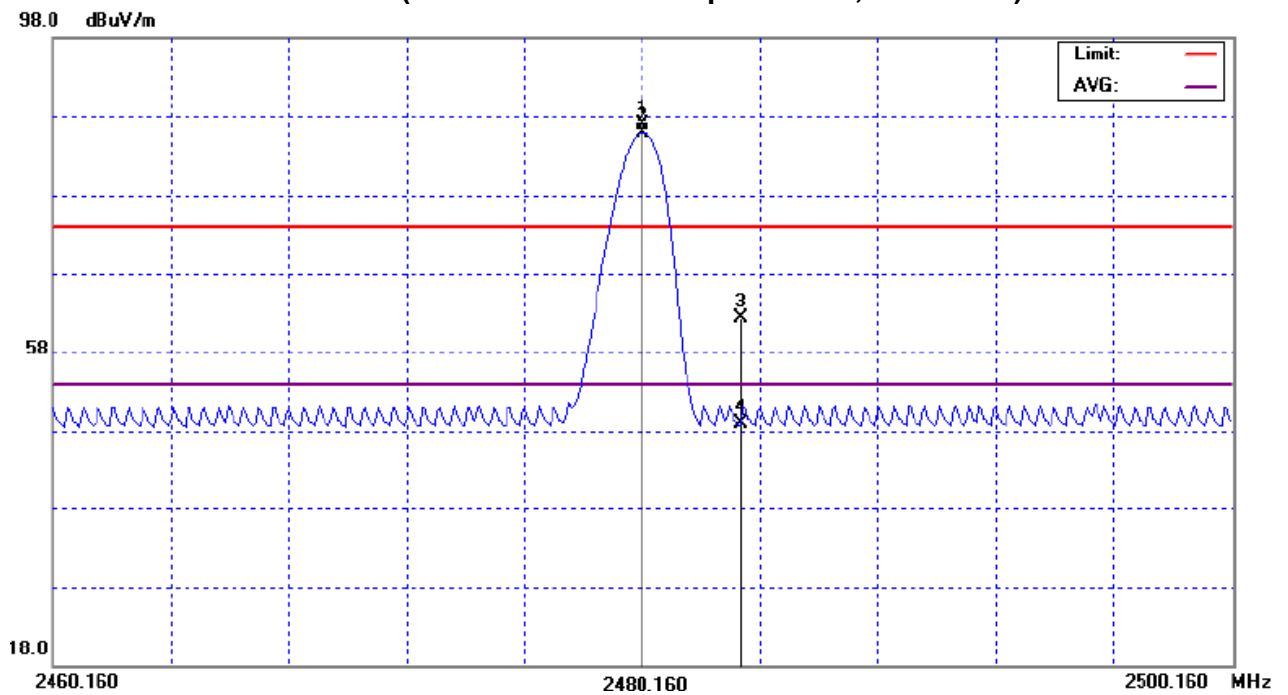

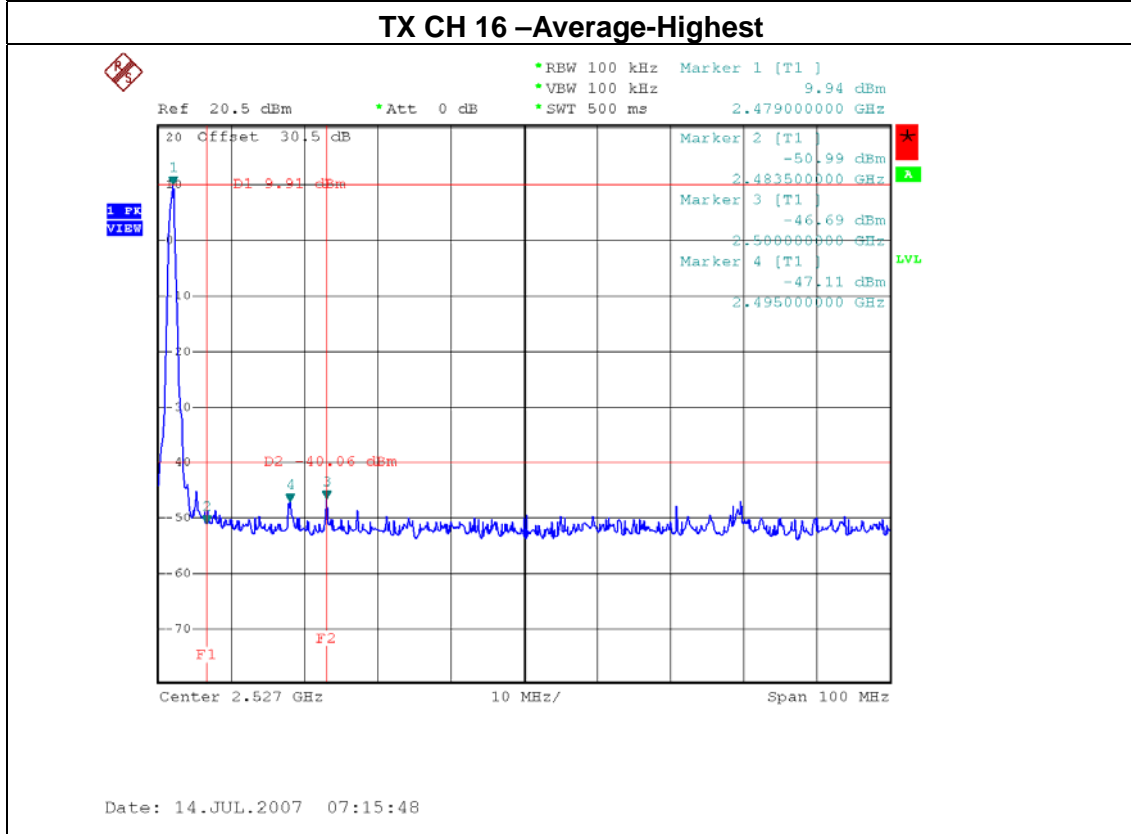
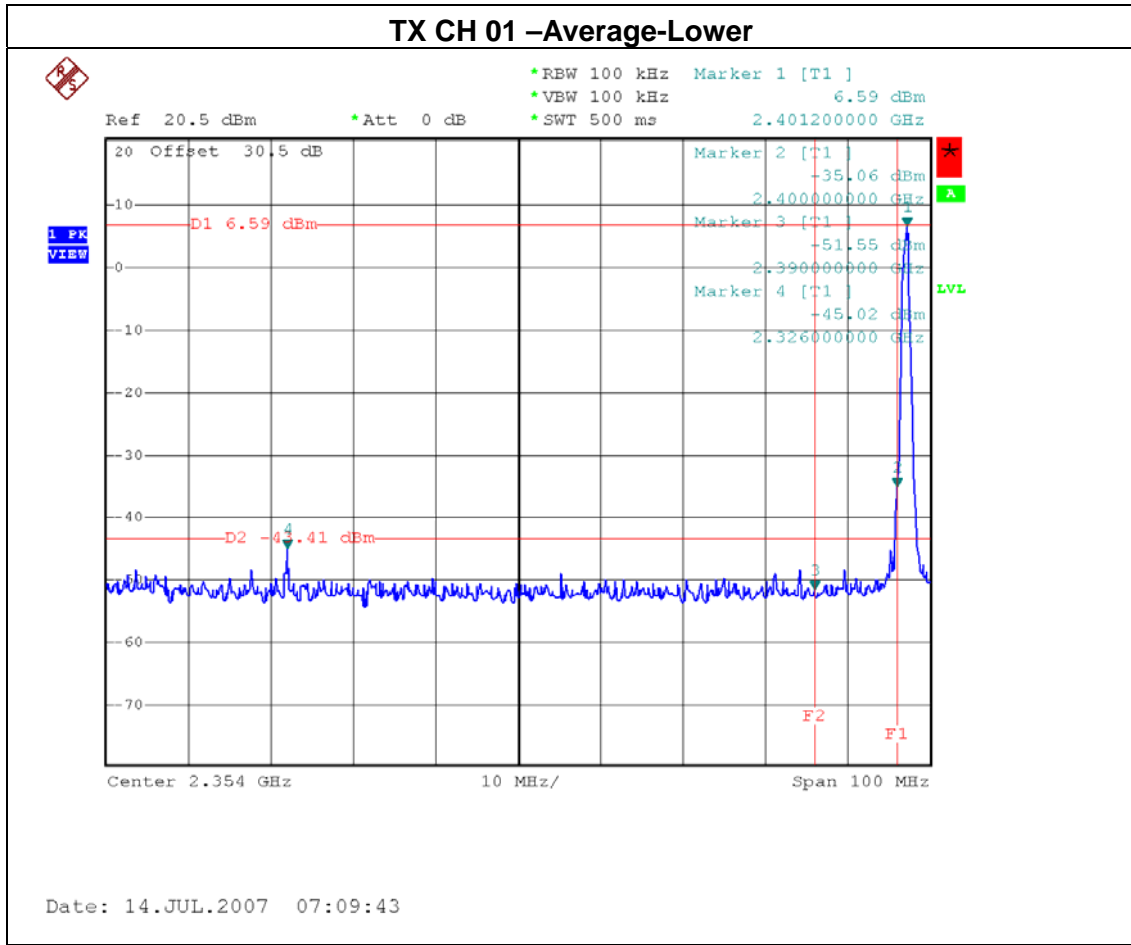

5. EUT TEST PHOTO

**Conducted Measurement Photos
Normal Link**



**Radiated Measurement Photos
TX sample**

