



FCC TEST REPORT

REPORT NO.: RF960514A08B

MODEL NO.: M01004-D

RECEIVED: May 21, 2007

TESTED: May 24 ~ 28, 2007

ISSUED: Aug. 13, 2007

APPLICANT: ACCO Brands, Inc.

ADDRESS: 333 Twin Dolphin Drive, 6th Floor, Redwood Shores, CA, 94065, U.S.A.

ISSUED BY: Advance Data Technology Corporation

LAB LOCATION: No. 47, 14th Ling, Chia Pau Tsuen, Lin Kou Hsiang 244, Taipei Hsien, Taiwan, R.O.C.

This test report consists of 31 pages in total. It may be duplicated completely for legal use with the approval of the applicant. It should not be reproduced except in full, without the written approval of our laboratory. The client should not use it to claim product endorsement by TAF, A2LA or any government agencies. The test results in the report only apply to the tested sample.



Table of Contents

1.	CERTIFICATION.....	3
2.	SUMMARY OF TEST RESULTS.....	4
2.1	MEASUREMENT UNCERTAINTY.....	4
3.	GENERAL INFORMATION	5
3.1	GENERAL DESCRIPTION OF EUT	5
3.2	DESCRIPTION OF TEST MODES	6
3.2.1	CONFIGURATION OF SYSTEM UNDER TEST	6
3.2.2	TEST MODE APPLICABILITY AND TESTED CHANNEL DETAIL:	7
3.3	GENERAL DESCRIPTION OF APPLIED STANDARDS	8
3.4	DESCRIPTION OF SUPPORT UNITS	8
4.	TEST TYPES AND RESULTS.....	9
4.1	CONDUCTED EMISSION MEASUREMENT	9
4.1.1	LIMITS OF CONDUCTED EMISSION MEASUREMENT.....	9
4.1.2	TEST INSTRUMENTS	9
4.1.3	TEST PROCEDURES	10
4.1.4	DEVIATION FROM TEST STANDARD	10
4.1.5	TEST SETUP	10
4.1.6	EUT OPERATING CONDITIONS	11
4.1.7	TEST RESULTS.....	12
4.2	RADIATED EMISSION Measurement	18
4.2.1	LIMITS OF RADIATED EMISSION MEASUREMENT.....	18
4.2.2	TEST INSTRUMENTS	19
4.2.3	TEST PROCEDURES.....	20
4.2.4	DEVIATION FROM TEST STANDARD	20
4.2.5	TEST SETUP	21
4.2.6	EUT OPERATING CONDITIONS	21
4.2.7	TEST RESULTS.....	22
4.3	BAND EDGES MEASUREMENT	26
4.3.1	LIMITS OF BAND EDGES MEASUREMENT.....	26
4.3.2	TEST INSTRUMENTS	26
4.3.3	TEST PROCEDURE	26
4.3.4	DEVIATION FROM TEST STANDARD	26
4.3.5	EUT OPERATING CONDITION	26
4.3.6	TEST RESULTS.....	26
5.	PHOTOGRAPHS OF THE TEST CONFIGURATION.....	29
6.	INFORMATION ON THE TESTING LABORATORIES	30
7.	APPENDIX A – MODIFICATIONS RECORDERS FOR ENGINEERING CHANGES TO THE EUT BY THE LAB.....	31



1. CERTIFICATION

PRODUCT: Kensington® SlimBlade™ Media Mouse Set
BRAND NAME: Kensington
MODEL NO.: M01004-D
APPLICANT: ACCO Brands, Inc.
TESTED: May 24 ~ 28, 2007
TEST SAMPLE: ENGINEERING SAMPLE
STANDARDS: FCC Part 15, Subpart C (Section 15.249),
ANSI C63.4-2003

The above equipment has been tested by **Advance Data Technology Corporation**, and found compliance with the requirement of the above standards. The test record, data evaluation & Equipment Under Test (EUT) configurations represented herein are true and accurate accounts of the measurements of the sample's EMC characteristics under the conditions specified in this report.

PREPARED BY : Celia Chen , **DATE:** Aug. 13, 2007
(Celia Chen / Specialist)

TECHNICAL ACCEPTANCE : Jamison Chan , **DATE:** Aug. 13, 2007
Responsible for RF (Jamison Chan / Senior Engineer)

APPROVED BY : Ken Liu , **DATE:** Aug. 13, 2007
(Ken Liu / Deputy Manager)

2. SUMMARY OF TEST RESULTS

The EUT has been tested according to the following specifications:

APPLIED STANDARD: FCC Part 15, Subpart C (Section 15.249)			
STANDARD PARAGRAPH	TEST TYPE	RESULT	REMARK
15.207	Conducted Emission Test	PASS	Minimum passing margin is -13.64dB at 0.154MHz
15.209 15.249 15.249 (d)	Radiated Emission Test Band Edge Measurement Limit: 50dB less than the peak value of fundamental frequency or meet radiated emission limit in section 12.209	PASS	Minimum passing margin is -1.67dB at 4876.000MHz

2.1 MEASUREMENT UNCERTAINTY

Where relevant, the following measurement uncertainty levels have been estimated for tests performed on the EUT as specified in CISPR 16-4-2:

This uncertainty represents an expanded uncertainty expressed at approximately the 95% confidence level using a coverage factor of $k=2$.

Measurement	Uncertainty
Conducted emissions	2.44 dB
Radiated emissions	3.75 dB

3. GENERAL INFORMATION

3.1 GENERAL DESCRIPTION OF EUT

EUT	Kensington® SlimBlade™ Media Mouse Set
MODEL NO.	M01004-D
FCC ID	GV3M01004-D
POWER SUPPLY	5Vdc from host equipment
MODULATION TYPE	GFSK
FREQUENCY RANGE	2402MHz ~ 2474MHz
NUMBER OF CHANNEL	13
ANTENNA TYPE	Printed antenna with -1.12dBi gain
DATA CABLE	N/A
I/O PORTS	USB port
ASSOCIATED DEVICES	N/A

NOTE:

1. The EUT is a Kensington® SlimBlade™ Media Mouse Set, which is a transceiver.
2. The above EUT information was declared by the manufacturer and for more detailed features description, please refer to the manufacturer's specifications or User's Manual.

3.2 DESCRIPTION OF TEST MODES

Thirteen channels are provided to this EUT.

Channel	Freq. (MHz)	Channel	Freq. (MHz)
1	2402	8	2444
2	2408	9	2450
3	2414	10	2456
4	2420	11	2462
5	2426	12	2468
6	2432	13	2474
7	2438		

3.2.1 CONFIGURATION OF SYSTEM UNDER TEST

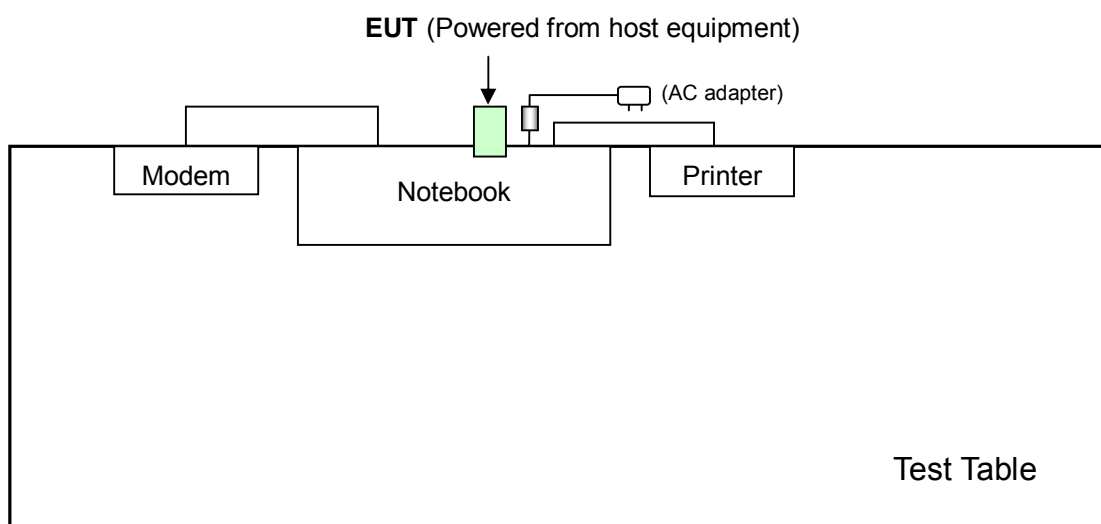

3.2.2 TEST MODE APPLICABILITY AND TESTED CHANNEL DETAIL:

EUT configure mode	Applicable to				Description
	PLC	RE<1G	RE≥1G	APCM	
-	√	√	√	√	-

Where PLC: Power Line Conducted Emission RE<1G RE: Radiated Emission below 1GHz
 RE≥1G: Radiated Emission above 1GHz APCM: Antenna Port Conducted Measurement

POWER LINE CONDUCTED EMISSION TEST:

- Following channel(s) was (were) selected for the final test as listed below.

AVAILABLE CHANNEL	TESTED CHANNEL	RADIO TECHNOLOGY	MODULATION TYPE
1 to 13	1, 7, 13	DSSS	GFSK

RADIATED EMISSION TEST (BELOW 1 GHz):

- Pre-Scan has been conducted to determine the worst-case mode from all possible combinations between available modulations, data rates and antenna ports (if EUT with antenna diversity architecture).
- Following channel(s) was (were) selected for the final test as listed below.

AVAILABLE CHANNEL	TESTED CHANNEL	RADIO TECHNOLOGY	MODULATION TYPE
1 to 13	1	DSSS	GFSK

RADIATED EMISSION TEST (ABOVE 1 GHz):

- Pre-Scan has been conducted to determine the worst-case mode from all possible combinations between available modulations, data rates and antenna ports (if EUT with antenna diversity architecture).
- Following channel(s) was (were) selected for the final test as listed below.

AVAILABLE CHANNEL	TESTED CHANNEL	RADIO TECHNOLOGY	MODULATION TYPE
1 to 13	1, 7, 13	DSSS	GFSK

BANDEDGE MEASUREMENT:

- Pre-Scan has been conducted to determine the worst-case mode from all possible combinations between available modulations, data rates and antenna ports (if EUT with antenna diversity architecture).
- Following channel(s) was (were) selected for the final test as listed below.

AVAILABLE CHANNEL	TESTED CHANNEL	RADIO TECHNOLOGY	MODULATION TYPE
1 to 13	1, 13	DSSS	GFSK



3.3 GENERAL DESCRIPTION OF APPLIED STANDARDS

The EUT is a RF product. According to the specifications of the manufacturer, it must comply with the requirements of the following standards:

FCC Part 15, Subpart C. (15.249)

ANSI C63.4-2003

All test items have been performed and recorded as per the above standards.

3.4 DESCRIPTION OF SUPPORT UNITS

The EUT has been tested as an independent unit together with other necessary accessories or support units. The following support units or accessories were used to form a representative test configuration during the tests.

NO.	PRODUCT	BRAND	MODEL NO.	SERIAL NO.	FCC ID
1	PRINTER	EPSON	LQ-300+	DCGY017054	FCC DoC Approved
2	MODEM	ACEEX	1414	980020520	IFAXDM1414
3	NOTEBOOK COMPUTER	DELL	PP05L	20375526736	FCC DoC Approved

NO.	SIGNAL CABLE DESCRIPTION OF THE ABOVE SUPPORT UNITS
1	1.8m braid shielded wire, terminated with DB25 and Centronics connector via metallic frame, w/o core
2	1.2 m braid shielded wire, terminated with DB25 and DB9 connector via metallic frame, w/o core.
3	N/A

NOTE: All power cords of the above support units are non shielded (1.8m).

4. TEST TYPES AND RESULTS

4.1 CONDUCTED EMISSION MEASUREMENT

4.1.1 LIMITS OF CONDUCTED EMISSION MEASUREMENT

FREQUENCY OF EMISSION (MHz)	CONDUCTED LIMIT (dB μ V)	
	Quasi-peak	Average
0.15-0.5	66 to 56	56 to 46
0.5-5	56	46
5-30	60	50

NOTE:

1. The lower limit shall apply at the transition frequencies.
2. All emanations from a class A/B digital device or system, including any network of conductors and apparatus connected thereto, shall not exceed the level of field strengths specified above.

4.1.2 TEST INSTRUMENTS

DESCRIPTION & MANUFACTURER	MODEL NO.	SERIAL NO.	CALIBRATED UNTIL
ROHDE & SCHWARZ Test Receiver	ESCS 30	838251/021	Nov. 23, 2007
ROHDE & SCHWARZ Artificial Mains Network (for EUT)	ESH3-Z5	100218	Nov. 21, 2007
LISN With Adapter (for EUT)	AD10	C10Ada-001	Nov. 21, 2007
ROHDE & SCHWARZ Artificial Mains Network (for peripherals)	ESH3-Z5	100219	Nov. 07, 2007
ROHDE & SCHWARZ Artificial Mains Network (for peripherals)	ESH3-Z5	100220	Oct. 26, 2007
Software	ADT_Cond_V7.3.2	NA	NA
Software	ADT_ISN_V7.3.2	NA	NA
RF cable (JYEBAO)	5D-FB	Cable-C10.01	Mar. 01, 2008
SUHNTER Terminator (For ROHDE & SCHWARZ LISN)	65BNC-5001	E1-010773	Feb. 11, 2008

- NOTE:**
1. The calibration interval of the above test instruments is 12 months and the calibrations are traceable to NML/ROC and NIST/USA.
 2. The test was performed in ADT Shielded Room No. 10.
 3. The VCCI Site Registration No. C-1852.

4.1.3 TEST PROCEDURES

- a. The EUT was placed 0.4 meters from the conducting wall of the shielded room with EUT being connected to the power mains through a line impedance stabilization network (LISN). Other support units were connected to the power mains through another LISN. The two LISNs provide 50 ohm/ 50uH of coupling impedance for the measuring instrument.
- b. Both lines of the power mains connected to the EUT were checked for maximum conducted interference.
- c. The frequency range from 150kHz to 30MHz was searched. Emission levels under Limit - 20dB was not recorded.

4.1.4 DEVIATION FROM TEST STANDARD

No deviation.

4.1.5 TEST SETUP

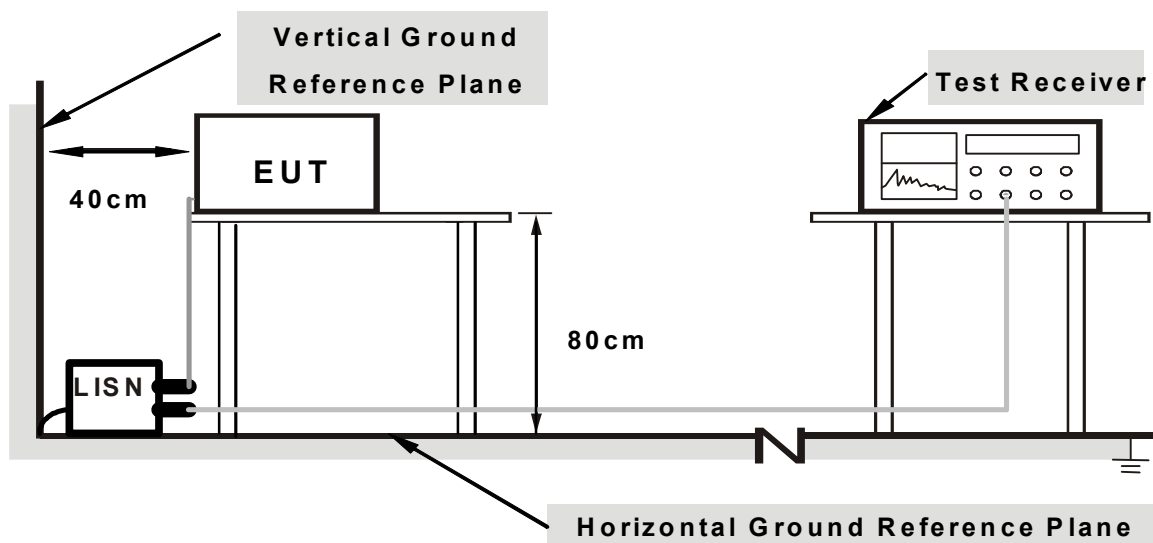

- Note:**
1. Support units were connected to second LISN.
 2. Both of LISNs (AMN) are 80 cm from EUT and at least 80 from other units and other metal planes

For the actual test configuration, please refer to the related item – Photographs of the Test Configuration.

4.1.6 EUT OPERATING CONDITIONS

- a. Connected the EUT to a notebook placed on a testing table.
- b. The notebook ran a test program (provided by manufacturer) to enable EUT under transmission/receiving condition continuously at specific channel frequency.
- c. The notebook sent "H" messages to its screen.
- d. The notebook sent messages to printer and the printer prints them out
- e. The notebook sent messages to modem.
- f. Repeated c ~ f.

4.1.7 TEST RESULTS

CONDUCTED WORST CASE DATA

MODULATION TYPE	GFSK	CHANNEL	1
INPUT POWER (SYSTEM)	120Vac, 60 Hz	6dB BANDWIDTH	9 kHz
ENVIRONMENTAL CONDITIONS	25deg. C, 70%RH, 994hPa	PHASE	Line 1
TESTED BY	Jun Wu		

No	Freq. [MHz]	Corr. Factor (dB)	Reading Value [dB (uV)]		Emission Level [dB (uV)]		Limit [dB (uV)]		Margin (dB)	
			Q.P.	AV.	Q.P.	AV.	Q.P.	AV.	Q.P.	AV.
1	0.158	0.20	51.59	-	51.79	-	65.58	55.58	-13.79	-
2	0.216	0.20	48.44	-	48.64	-	62.96	52.96	-14.32	-
3	1.793	0.40	29.34	-	29.74	-	56.00	46.00	-26.26	-
4	3.773	0.49	22.93	-	23.42	-	56.00	46.00	-32.58	-
5	11.395	0.81	28.77	-	29.58	-	60.00	50.00	-30.42	-
6	18.828	1.33	24.24	-	25.57	-	60.00	50.00	-34.43	-

- REMARKS:**
1. Q.P. and AV. are abbreviations of quasi-peak and average individually.
 2. "-": The Quasi-peak reading value also meets average limit and measurement with the average detector is unnecessary.
 3. The emission levels of other frequencies were very low against the limit.
 4. Margin value = Emission level - Limit value
 5. Correction factor = Insertion loss + Cable loss
 6. Emission Level = Correction Factor + Reading Value.

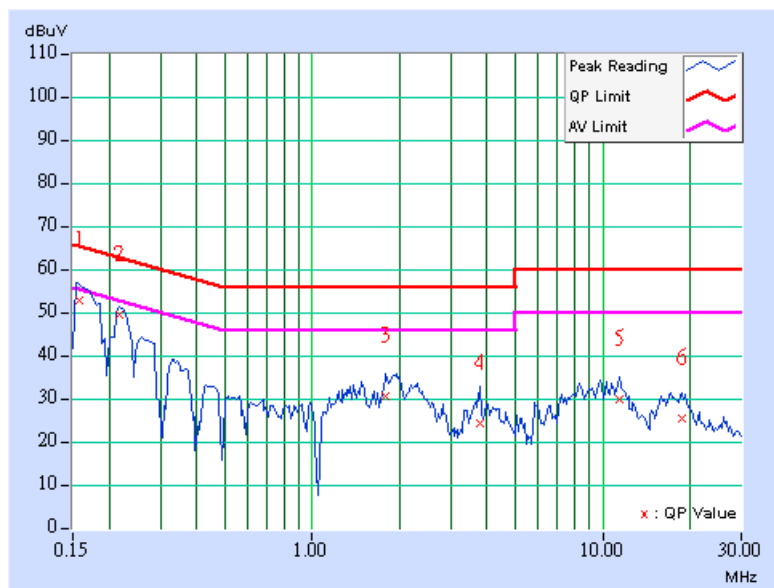

MODULATION TYPE	GFSK	CHANNEL	1
INPUT POWER (SYSTEM)	120Vac, 60 Hz	6dB BANDWIDTH	9 kHz
ENVIRONMENTAL CONDITIONS	25deg. C, 70%RH, 994hPa	PHASE	Line 2
TESTED BY	Jun Wu		

No	Freq. [MHz]	Corr. Factor (dB)	Reading Value		Emission Level		Limit		Margin	
			[dB (uV)]		[dB (uV)]		[dB (uV)]		(dB)	
			Q.P.	AV.	Q.P.	AV.	Q.P.	AV.	Q.P.	AV.
1	0.150	0.20	51.13	-	51.33	-	66.00	56.00	-14.67	-
2	0.189	0.20	41.96	-	42.16	-	64.08	54.08	-21.92	-
3	1.883	0.30	30.05	-	30.35	-	56.00	46.00	-25.65	-
4	4.004	0.40	24.28	-	24.68	-	56.00	46.00	-31.32	-
5	10.555	0.53	29.62	-	30.15	-	60.00	50.00	-29.85	-
6	17.105	0.88	24.78	-	25.66	-	60.00	50.00	-34.34	-

- REMARKS:**
1. Q.P. and AV. are abbreviations of quasi-peak and average individually.
 2. "-": The Quasi-peak reading value also meets average limit and measurement with the average detector is unnecessary.
 3. The emission levels of other frequencies were very low against the limit.
 4. Margin value = Emission level - Limit value
 5. Correction factor = Insertion loss + Cable loss
 6. Emission Level = Correction Factor + Reading Value.

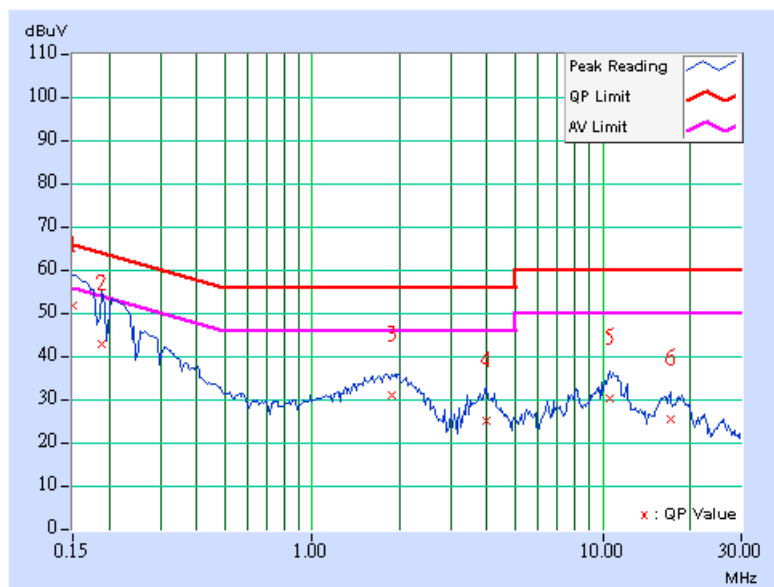

MODULATION TYPE	GFSK	CHANNEL	7
INPUT POWER (SYSTEM)	120Vac, 60 Hz	6dB BANDWIDTH	9 kHz
ENVIRONMENTAL CONDITIONS	25deg. C, 70%RH, 994hPa	PHASE	Line 1
TESTED BY	Jun Wu		

No	Freq. [MHz]	Corr. Factor (dB)	Reading Value		Emission Level		Limit		Margin	
			[dB (uV)]		[dB (uV)]		[dB (uV)]		(dB)	
			Q.P.	AV.	Q.P.	AV.	Q.P.	AV.	Q.P.	AV.
1	0.154	0.20	51.95	-	52.15	-	65.79	55.79	-13.64	-
2	0.218	0.20	48.74	-	48.94	-	62.90	52.90	-13.96	-
3	1.887	0.40	30.12	-	30.52	-	56.00	46.00	-25.48	-
4	3.779	0.49	22.91	-	23.40	-	56.00	46.00	-32.60	-
5	11.395	0.81	28.97	-	29.78	-	60.00	50.00	-30.22	-
6	18.823	1.33	24.51	-	25.84	-	60.00	50.00	-34.16	-

- REMARKS:**
1. Q.P. and AV. are abbreviations of quasi-peak and average individually.
 2. "-": The Quasi-peak reading value also meets average limit and measurement with the average detector is unnecessary.
 3. The emission levels of other frequencies were very low against the limit.
 4. Margin value = Emission level - Limit value
 5. Correction factor = Insertion loss + Cable loss
 6. Emission Level = Correction Factor + Reading Value.

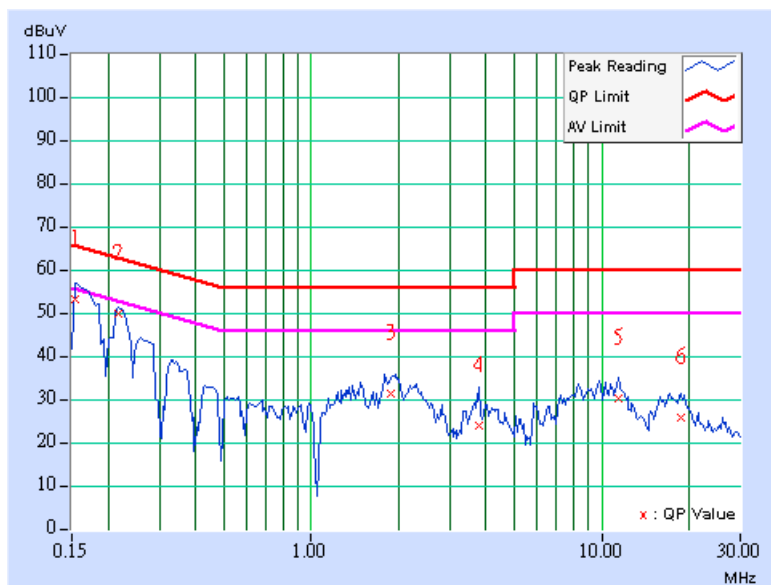

MODULATION TYPE	GFSK	CHANNEL	7
INPUT POWER (SYSTEM)	120Vac, 60 Hz	6dB BANDWIDTH	9 kHz
ENVIRONMENTAL CONDITIONS	25deg. C, 70%RH, 994hPa	PHASE	Line 2
TESTED BY	Jun Wu		

No	Freq. [MHz]	Corr. Factor (dB)	Reading Value		Emission Level		Limit		Margin	
			[dB (uV)]		[dB (uV)]		[dB (uV)]		(dB)	
			Q.P.	AV.	Q.P.	AV.	Q.P.	AV.	Q.P.	AV.
1	0.154	0.20	50.76	-	50.96	-	65.79	55.79	-14.83	-
2	0.209	0.20	47.30	-	47.50	-	63.26	53.26	-15.76	-
3	1.957	0.30	29.34	-	29.64	-	56.00	46.00	-26.36	-
4	3.848	0.39	25.20	-	25.59	-	56.00	46.00	-30.41	-
5	10.922	0.56	30.73	-	31.29	-	60.00	50.00	-28.71	-
6	16.004	0.84	25.13	-	25.97	-	60.00	50.00	-34.03	-

- REMARKS:**
1. Q.P. and AV. are abbreviations of quasi-peak and average individually.
 2. "-": The Quasi-peak reading value also meets average limit and measurement with the average detector is unnecessary.
 3. The emission levels of other frequencies were very low against the limit.
 4. Margin value = Emission level - Limit value
 5. Correction factor = Insertion loss + Cable loss
 6. Emission Level = Correction Factor + Reading Value.

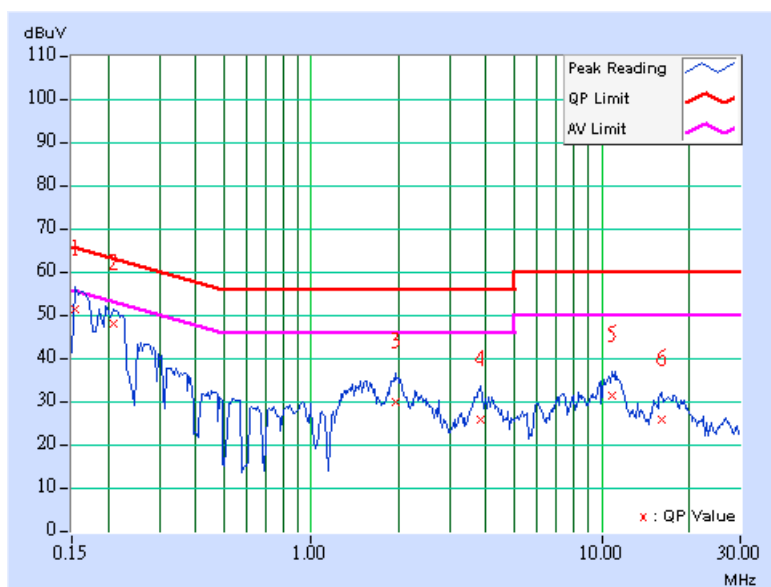

MODULATION TYPE	GFSK	CHANNEL	13
INPUT POWER (SYSTEM)	120Vac, 60 Hz	6dB BANDWIDTH	9 kHz
ENVIRONMENTAL CONDITIONS	25deg. C, 70%RH, 994hPa	PHASE	Line 1
TESTED BY	Jun Wu		

No	Freq. [MHz]	Corr. Factor (dB)	Reading Value		Emission Level		Limit		Margin	
			[dB (uV)]		[dB (uV)]		[dB (uV)]		(dB)	
			Q.P.	AV.	Q.P.	AV.	Q.P.	AV.	Q.P.	AV.
1	0.150	0.20	49.44	-	49.64	-	66.00	56.00	-16.36	-
2	0.185	0.20	39.00	-	39.20	-	64.25	54.25	-25.05	-
3	1.973	0.40	28.19	-	28.59	-	56.00	46.00	-27.41	-
4	4.035	0.50	21.95	-	22.45	-	56.00	46.00	-33.55	-
5	10.898	0.77	30.12	-	30.89	-	60.00	50.00	-29.11	-
6	17.379	1.24	26.03	-	27.27	-	60.00	50.00	-32.73	-

- REMARKS:**
1. Q.P. and AV. are abbreviations of quasi-peak and average individually.
 2. "-": The Quasi-peak reading value also meets average limit and measurement with the average detector is unnecessary.
 3. The emission levels of other frequencies were very low against the limit.
 4. Margin value = Emission level - Limit value
 5. Correction factor = Insertion loss + Cable loss
 6. Emission Level = Correction Factor + Reading Value.

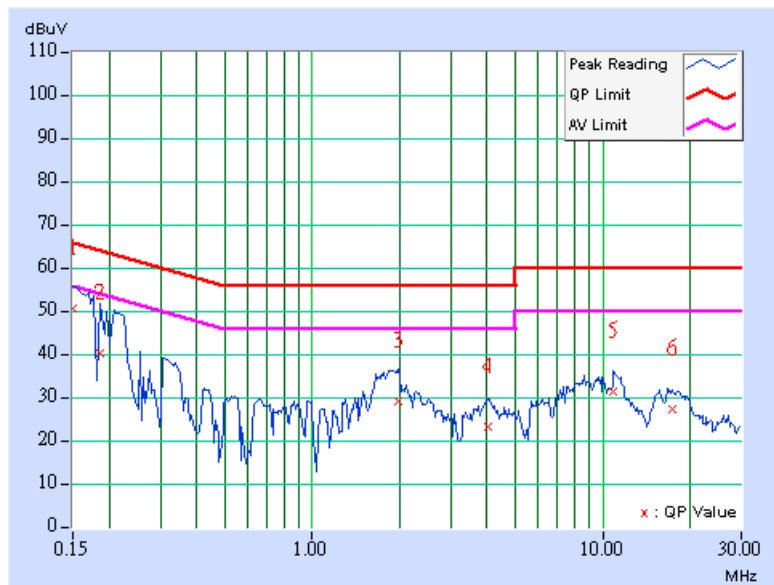

MODULATION TYPE	GFSK	CHANNEL	13
INPUT POWER (SYSTEM)	120Vac, 60 Hz	6dB BANDWIDTH	9 kHz
ENVIRONMENTAL CONDITIONS	25deg. C, 70%RH, 994hPa	PHASE	Line 2
TESTED BY	Jun Wu		

No	Freq. [MHz]	Corr. Factor (dB)	Reading Value		Emission Level		Limit		Margin	
			[dB (uV)]		[dB (uV)]		[dB (uV)]		(dB)	
			Q.P.	AV.	Q.P.	AV.	Q.P.	AV.	Q.P.	AV.
1	0.154	0.20	50.54	-	50.74	-	65.77	55.77	-15.03	-
2	0.213	0.20	47.02	-	47.22	-	63.08	53.08	-15.86	-
3	1.959	0.30	29.72	-	30.02	-	56.00	46.00	-25.98	-
4	3.844	0.39	24.67	-	25.06	-	56.00	46.00	-30.94	-
5	10.923	0.56	30.85	-	31.41	-	60.00	50.00	-28.59	-
6	16.004	0.84	25.21	-	26.05	-	60.00	50.00	-33.95	-

- REMARKS:**
1. Q.P. and AV. are abbreviations of quasi-peak and average individually.
 2. "-": The Quasi-peak reading value also meets average limit and measurement with the average detector is unnecessary.
 3. The emission levels of other frequencies were very low against the limit.
 4. Margin value = Emission level - Limit value
 5. Correction factor = Insertion loss + Cable loss
 6. Emission Level = Correction Factor + Reading Value.

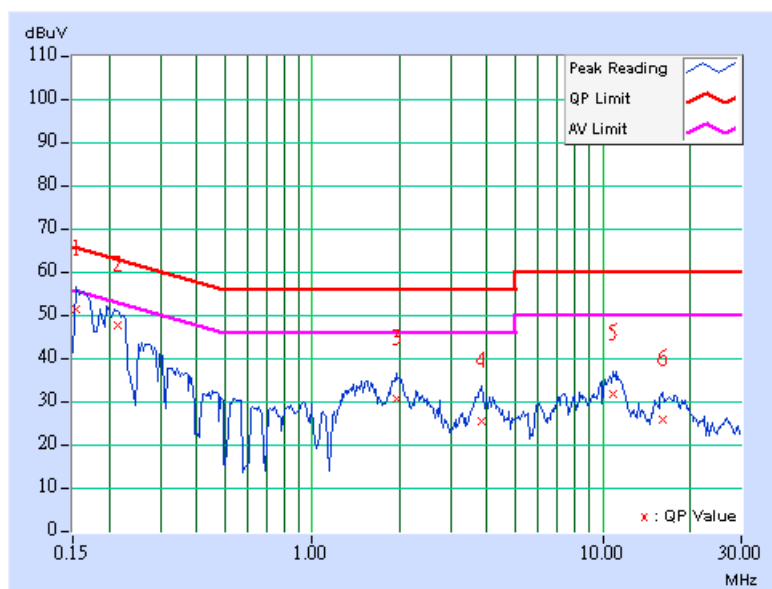

4.2 RADIATED EMISSION MEASUREMENT

4.2.1 LIMITS OF RADIATED EMISSION MEASUREMENT

Emissions radiated outside of the specified bands, shall be according to the general radiated limits in 15.209 as following:

Frequencies (MHz)	Field strength (microvolts/meter)	Measurement distance (meters)
0.009-0.490	2400/F(kHz)	300
0.490-1.705	24000/F(kHz)	30
1.705-30.0	30	30
30-88	100	3
88-216	150	3
216-960	200	3
Above 960	500	3

NOTE:

1. The lower limit shall apply at the transition frequencies.
2. Emission level (dBuV/m) = 20 log Emission level (uV/m).
3. As shown in 15.35(b), for frequencies above 1000MHz, the field strength limits are based on average detector, however, the peak field strength of any emission shall not exceed the maximum permitted average limits, specified above by more than 20dB under any condition of modulation.



4.2.2 TEST INSTRUMENTS

DESCRIPTION & MANUFACTURER	MODEL NO.	SERIAL NO.	CALIBRATED UNTIL
HP Preamplifier	8447D	2432A03504	May 09, 2008
HP Preamplifier	8449B	3008A01924	Sep. 05, 2007
HP Preamplifier	8449B	3008A01638	Sep. 17, 2007
ROHDE & SCHWARZ TEST RECEIVER	ESI7	836697/012	Oct. 24, 2007
Schwarzbeck Antenna	VULB 9168	137	Oct. 01, 2007
Schwarzbeck Antenna	VHBA 9123	480	Apr. 18, 2008
EMCO Horn Antenna	3115	6714	Oct. 24, 2007
EMCO Horn Antenna	3115	9312-4192	Apr. 19, 2008
ADT. Turn Table	TT100	0306	NA
ADT. Tower	AT100	0306	NA
Software	ADT_Radiated_V 7.6.15	NA	NA
SUHNER RF cable	SF104-26.5	CABLE-CH6-17m-01	Dec. 11, 2007
ROHDE & SCHWARZ Spectrum Analyzer	FSP 40	100036	Mar. 13, 2008

- NOTE:**
1. The calibration interval of the above test instruments is 12 months. And the calibrations are traceable to NML/ROC and NIST/USA.
 2. The horn antenna and HP preamplifier (model: 8449B) are used only for the measurement of emission frequency above 1GHz if tested.
 3. The test was performed in ADT Chamber No. 6.
 4. The Industry Canada Reference No. IC 3789-6.

4.2.3 TEST PROCEDURES

- a. The EUT was placed on the top of a rotating table 0.8 meters above the ground at a 3 meter semi- anechoic chamber. The table was rotated 360 degrees to determine the position of the highest radiation.
- b. The EUT was set 3 meters away from the interference-receiving antenna, which was mounted on the top of a variable-height antenna tower.
- c. The antenna is a broadband antenna, and its height is varied from one meter to four meters above the ground to determine the maximum value of the field strength. Both horizontal and vertical polarizations of the antenna are set to make the measurement.
- d. For each suspected emission, the EUT was arranged to its worst case and then the antenna was tuned to heights from 1 meter to 4 meters and the rotatable table was turned from 0 degrees to 360 degrees to find the maximum reading.
- e. The test-receiver system was set to Peak Detect Function and Specified Bandwidth with Maximum Hold Mode.
- f. If the emission level of the EUT in peak mode was lower than the limit specified, then testing could be stopped and the peak values of the EUT would be reported. Otherwise the emissions would be re-tested one by one using peak, quasi-peak method or average method as specified and then reported in data sheet.

NOTE:

1. The resolution bandwidth of test receiver/spectrum analyzer is 120kHz for Quasi-peak detection at frequency below 1GHz.
2. The resolution bandwidth is 1MHz and video bandwidth of test receiver/spectrum analyzer is 3MHz for Peak detection at frequency above 1GHz. The resolution bandwidth of test receiver/spectrum analyzer is 1 MHz for Average detection (AV) at frequency above 1GHz.
3. The resolution bandwidth of test receiver/spectrum analyzer is 1 MHz and the video bandwidth is 10 Hz for Average detection (AV) at frequency above 1GHz.

4.2.4 DEVIATION FROM TEST STANDARD

No deviation

4.2.5 TEST SETUP

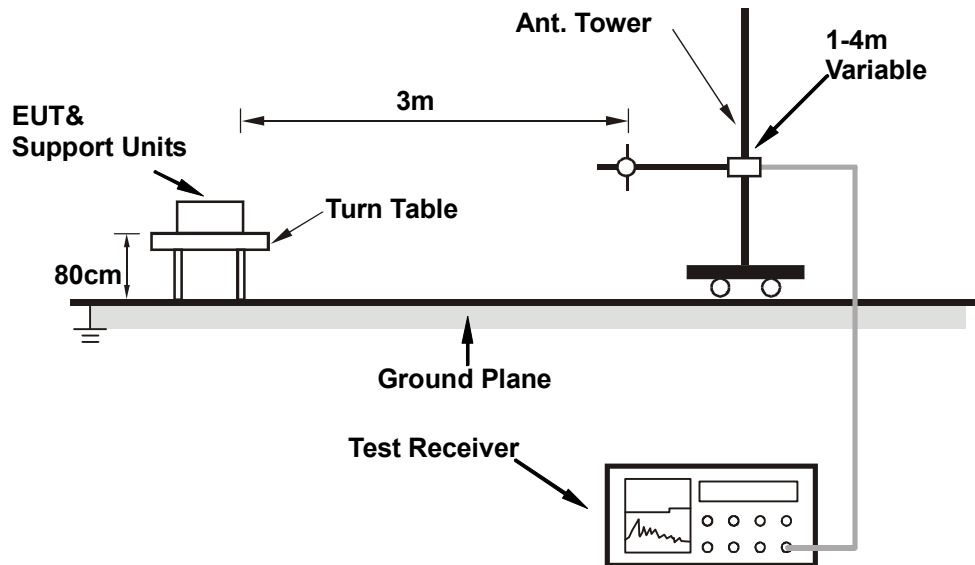

For the actual test configuration, please refer to the related item – Photographs of the Test Configuration.

4.2.6 EUT OPERATING CONDITIONS

Set the EUT under transmission condition continuously at specific channel frequency.

4.2.7 TEST RESULTS

RADIATED WORST CASE DATA: BELOW 1GHZ

MODULATION TYPE	GFSK	CHANNEL	1
INPUT POWER (SYSTEM)	120Vac, 60 Hz	FREQUENCY RANGE	Below 1000MHz
ENVIRONMENTAL CONDITIONS	25deg. C, 69%RH, 998Pa	DETECTOR FUNCTION	Quasi-Peak
TESTED BY	Jamison Chan		

ANTENNA POLARITY & TEST DISTANCE: HORIZONTAL AT 3 M

No.	Freq. (MHz)	Emission Level (dBuV/m)	Limit (dBuV/m)	Margin (dB)	Antenna Height (m)	Table Angle (Degree)	Raw Value (dBuV)	Correction Factor (dB/m)
1	43.607	30.56 QP	40.00	-9.44	1.87 H	223	15.20	15.36
2	134.970	29.23 QP	43.50	-14.27	2.09 H	256	15.86	13.37
3	168.016	28.67 QP	43.50	-14.83	1.66 H	10	15.11	13.56
4	304.088	31.87 QP	46.00	-14.13	1.74 H	133	15.12	16.75
5	521.804	32.90 QP	46.00	-13.10	2.19 H	115	10.16	22.74
6	867.816	31.60 QP	46.00	-14.40	2.11 H	115	2.55	29.05

ANTENNA POLARITY & TEST DISTANCE: VERTICAL AT 3 M

No.	Freq. (MHz)	Emission Level (dBuV/m)	Limit (dBuV/m)	Margin (dB)	Antenna Height (m)	Table Angle (Degree)	Raw Value (dBuV)	Correction Factor (dB/m)
1	45.551	24.37 QP	40.00	-15.63	1.00 V	10	8.80	15.57
2	74.709	28.79 QP	40.00	-11.21	1.00 V	136	16.69	12.10
3	113.587	29.40 QP	43.50	-14.10	1.00 V	187	18.57	10.83
4	138.858	31.11 QP	43.50	-12.39	1.00 V	217	17.20	13.90
5	162.184	31.92 QP	43.50	-11.58	1.00 V	271	18.00	13.92
6	521.804	30.84 QP	46.00	-15.16	1.00 V	220	8.10	22.74

- REMARKS:**
1. Emission level(dBuV/m)=Raw Value(dBuV) + Correction Factor(dB/m)
 2. Correction Factor(dB/m) = Antenna Factor (dB/m) + Cable Factor (dB)
 3. The other emission levels were very low against the limit.
 4. Margin value = Emission level – Limit value.

RADIATED WORST CASE DATA: ABOVE 1GHz

MODULATION TYPE	GFSK	CHANNEL	1
INPUT POWER (SYSTEM)	120Vac, 60 Hz	FREQUENCY RANGE	1 ~ 25GHz
ENVIRONMENTAL CONDITIONS	25deg. C, 69%RH, 998Pa	DETECTOR FUNCTION	Peak(PK) Average (AV)
TESTED BY	Jamison Chan		

ANTENNA POLARITY & TEST DISTANCE: HORIZONTAL AT 3 M

No.	Freq. (MHz)	Emission Level (dBuV/m)	Limit (dBuV/m)	Margin (dB)	Antenna Height (m)	Table Angle (Degree)	Raw Value (dBuV)	Correction Factor (dB/m)
1	2390.000	58.00 PK	74.00	-16.00	1.02 H	45	23.58	34.42
2	2390.000	45.30 AV	54.00	-8.70	1.02 H	45	10.88	34.42
3	*2402.000	91.05 PK	114.00	-22.95	1.02 H	45	56.61	34.44
4	*2402.000	89.82 AV	94.00	-4.18	1.02 H	45	55.38	34.44
5	4804.000	52.50 PK	74.00	-21.50	1.00 H	354	11.10	41.39
6	4804.000	46.40 AV	54.00	-7.60	1.00 H	354	5.00	41.39

ANTENNA POLARITY & TEST DISTANCE: VERTICAL AT 3 M

No.	Freq. (MHz)	Emission Level (dBuV/m)	Limit (dBuV/m)	Margin (dB)	Antenna Height (m)	Table Angle (Degree)	Raw Value (dBuV)	Correction Factor (dB/m)
1	2390.000	57.06 PK	74.00	-16.94	1.03 V	205	22.64	34.42
2	2390.000	45.27 AV	54.00	-8.73	1.03 V	205	10.85	34.42
3	*2402.000	89.11 PK	114.00	-24.89	1.03 V	205	54.67	34.44
4	*2402.000	87.90 AV	94.00	-6.10	1.03 V	205	53.46	34.44
5	4804.000	51.25 PK	74.00	-22.75	1.00 V	29	9.85	41.39
6	4804.000	41.62 AV	54.00	-12.38	1.00 V	29	0.22	41.39

- REMARKS:**
1. Emission level(dBuV/m)=Raw Value(dBuV) + Correction Factor(dB/m)
 2. Correction Factor(dB/m) = Antenna Factor (dB/m) + Cable Factor (dB)
 3. The other emission levels were very low against the limit.
 4. Margin value = Emission level – Limit value.
 5. “ * “ : Fundamental frequency

MODULATION TYPE	GFSK	CHANNEL	7
INPUT POWER (SYSTEM)	120Vac, 60 Hz	FREQUENCY RANGE	1 ~ 25GHz
ENVIRONMENTAL CONDITIONS	25deg. C, 69%RH, 998Pa	DETECTOR FUNCTION	Peak(PK) Average (AV)
TESTED BY	Jamison Chan		

ANTENNA POLARITY & TEST DISTANCE: HORIZONTAL AT 3 M

No.	Freq. (MHz)	Emission Level (dBuV/m)	Limit (dBuV/m)	Margin (dB)	Antenna Height (m)	Table Angle (Degree)	Raw Value (dBuV)	Correction Factor (dB/m)
1	*2438.000	92.12 PK	114.00	-21.88	1.03 H	64	57.60	34.52
2	*2438.000	91.00 AV	94.00	-3.00	1.03 H	64	56.48	34.52
3	4876.000	57.09 PK	74.00	-16.91	1.00 H	345	15.51	41.58
4	4876.000	52.33 AV	54.00	-1.67	1.00 H	345	10.75	41.58

ANTENNA POLARITY & TEST DISTANCE: VERTICAL AT 3 M

No.	Freq. (MHz)	Emission Level (dBuV/m)	Limit (dBuV/m)	Margin (dB)	Antenna Height (m)	Table Angle (Degree)	Raw Value (dBuV)	Correction Factor (dB/m)
1	*2438.000	90.35 PK	114.00	-23.65	1.00 V	207	55.83	34.52
2	*2438.000	88.79 AV	94.00	-5.21	1.00 V	207	54.27	34.52
3	4876.000	54.09 PK	74.00	-19.91	1.00 V	35	12.51	41.58
4	4876.000	47.84 AV	54.00	-6.16	1.00 V	35	6.26	41.58

- REMARKS:**
1. Emission level(dBuV/m)=Raw Value(dBuV) + Correction Factor(dB/m)
 2. Correction Factor(dB/m) = Antenna Factor (dB/m) + Cable Factor (dB)
 3. The other emission levels were very low against the limit.
 4. Margin value = Emission level – Limit value.
 5. “ * “ : Fundamental frequency

MODULATION TYPE	GFSK	CHANNEL	13
INPUT POWER (SYSTEM)	120Vac, 60 Hz	FREQUENCY RANGE	1 ~ 25GHz
ENVIRONMENTAL CONDITIONS	25deg. C, 69%RH, 998Pa	DETECTOR FUNCTION	Peak(PK) Average (AV)
TESTED BY	Jamison Chan		

ANTENNA POLARITY & TEST DISTANCE: HORIZONTAL AT 3 M

No.	Freq. (MHz)	Emission Level (dBuV/m)	Limit (dBuV/m)	Margin (dB)	Antenna Height (m)	Table Angle (Degree)	Raw Value (dBuV)	Correction Factor (dB/m)
1	*2474.000	92.60 PK	114.00	-21.40	1.00 H	62	58.01	34.59
2	*2474.000	91.54 AV	94.00	-2.46	1.00 H	62	56.95	34.59
3	2483.500	59.27 PK	74.00	-14.73	1.00 H	62	24.66	34.61
4	2483.500	45.55 AV	54.00	-8.45	1.00 H	62	10.94	34.61
5	4948.000	55.89 PK	74.00	-18.11	1.00 H	345	14.13	41.77
6	4948.000	51.07 AV	54.00	-2.93	1.00 H	345	9.31	41.77

ANTENNA POLARITY & TEST DISTANCE: VERTICAL AT 3 M

No.	Freq. (MHz)	Emission Level (dBuV/m)	Limit (dBuV/m)	Margin (dB)	Antenna Height (m)	Table Angle (Degree)	Raw Value (dBuV)	Correction Factor (dB/m)
1	*2474.000	90.26 PK	114.00	-23.74	1.00 V	208	55.67	34.59
2	*2474.000	89.03 AV	94.00	-4.97	1.00 V	208	54.44	34.59
3	2483.500	58.00 PK	74.00	-16.00	1.00 V	208	23.39	34.61
4	2483.500	45.59 AV	54.00	-8.41	1.00 V	208	10.98	34.61
5	4948.000	53.04 PK	74.00	-20.96	1.00 V	37	11.28	41.77
6	4948.000	46.29 AV	54.00	-7.71	1.00 V	37	4.53	41.77

- REMARKS:**
1. Emission level(dBuV/m)=Raw Value(dBuV) + Correction Factor(dB/m)
 2. Correction Factor(dB/m) = Antenna Factor (dB/m) + Cable Factor (dB)
 3. The other emission levels were very low against the limit.
 4. Margin value = Emission level – Limit value.
 5. “ * “ : Fundamental frequency

4.3 BAND EDGES MEASUREMENT

4.3.1 LIMITS OF BAND EDGES MEASUREMENT

Below –50dB of the highest emission level of operating band (in 100kHz Resolution Bandwidth).

4.3.2 TEST INSTRUMENTS

Description & Manufacturer	Model No.	Serial No.	Calibrated Until
SPECTRUM ANALYZER	FSP 40	100036	Mar. 13, 2008

NOTE: The calibration interval of the above test instruments is 12 months and the calibrations are traceable to NML/ROC and NIST/USA.

4.3.3 TEST PROCEDURE

The transmitter output was connected to the spectrum analyzer via a low loss cable. Set both RBW and VBW of spectrum analyzer to 100 kHz and 100 kHz with suitable frequency span including 100 MHz bandwidth from band edge. The band edges was measured and recorded.

The spectrum plots are attached on the following pages.

4.3.4 DEVIATION FROM TEST STANDARD

No deviation

4.3.5 EUT OPERATING CONDITION

Same as Item 4.2.6

4.3.6 TEST RESULTS

The spectrum plots are attached on the following 4 images. D1 line indicates the highest level, and D2 line indicates the 50dB offset below D1. It shows compliance with the requirement in part 15.249(d).

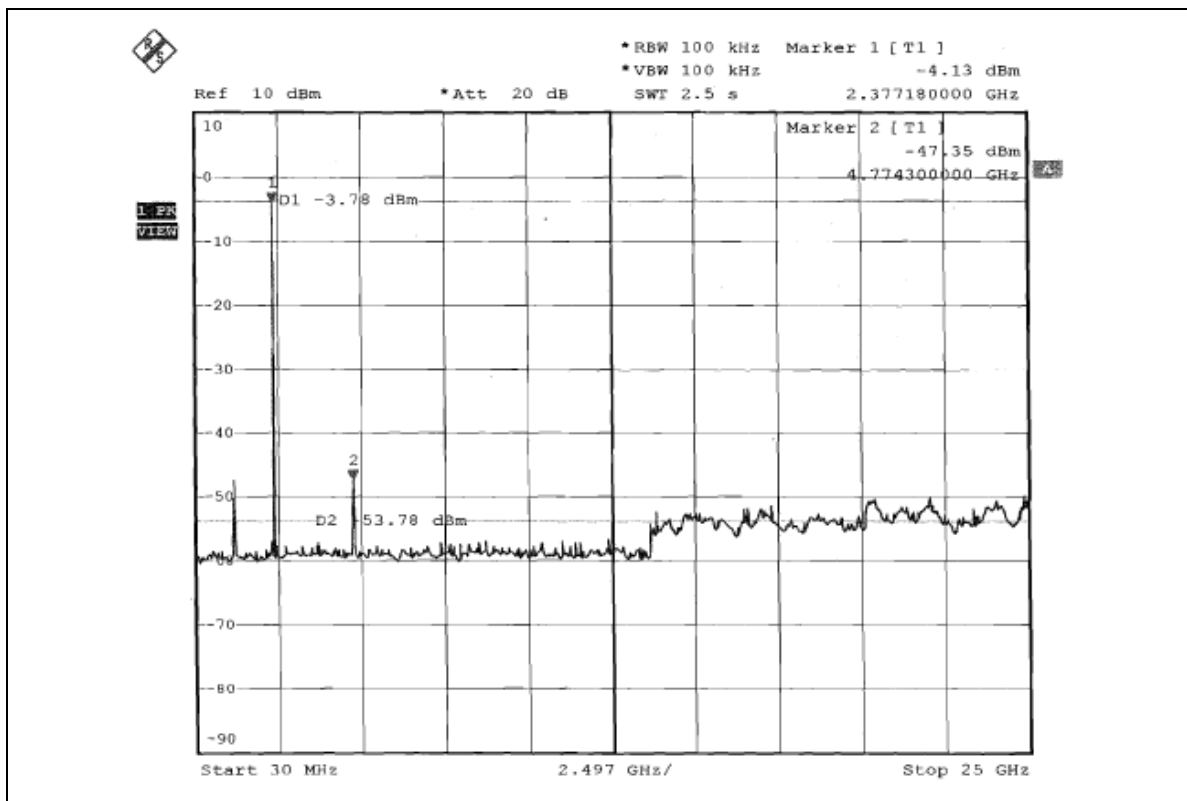
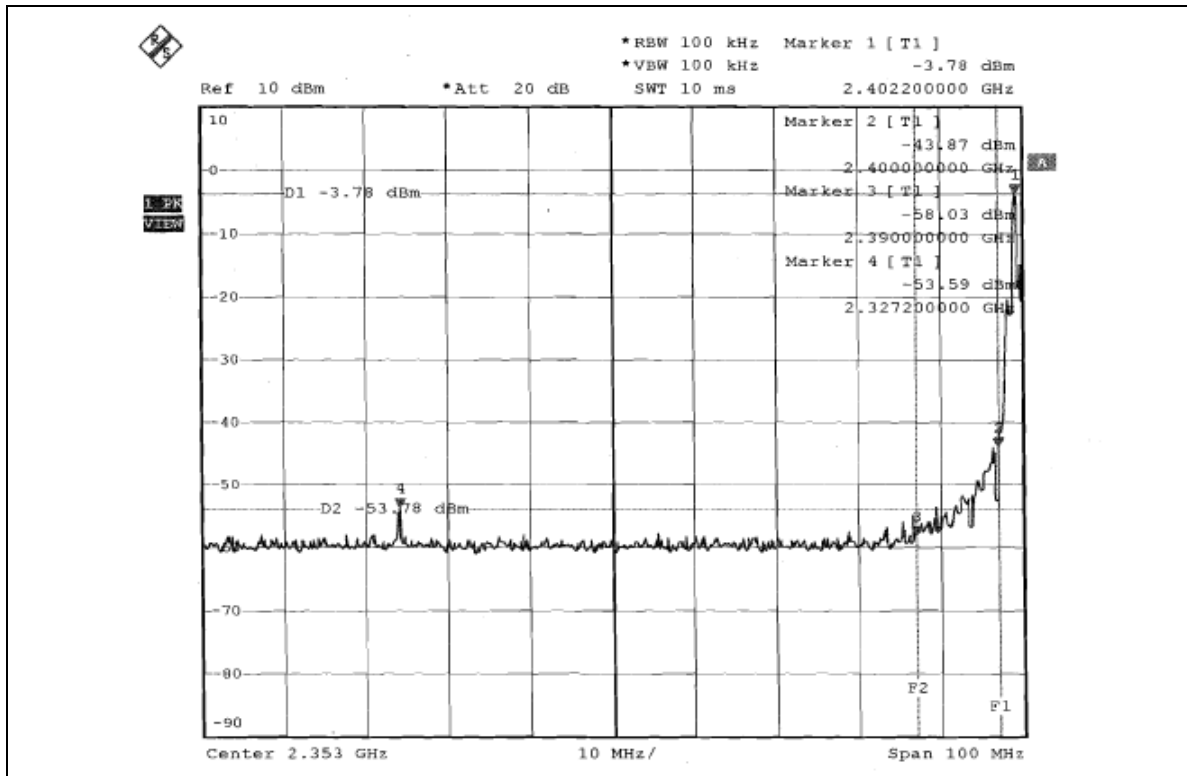

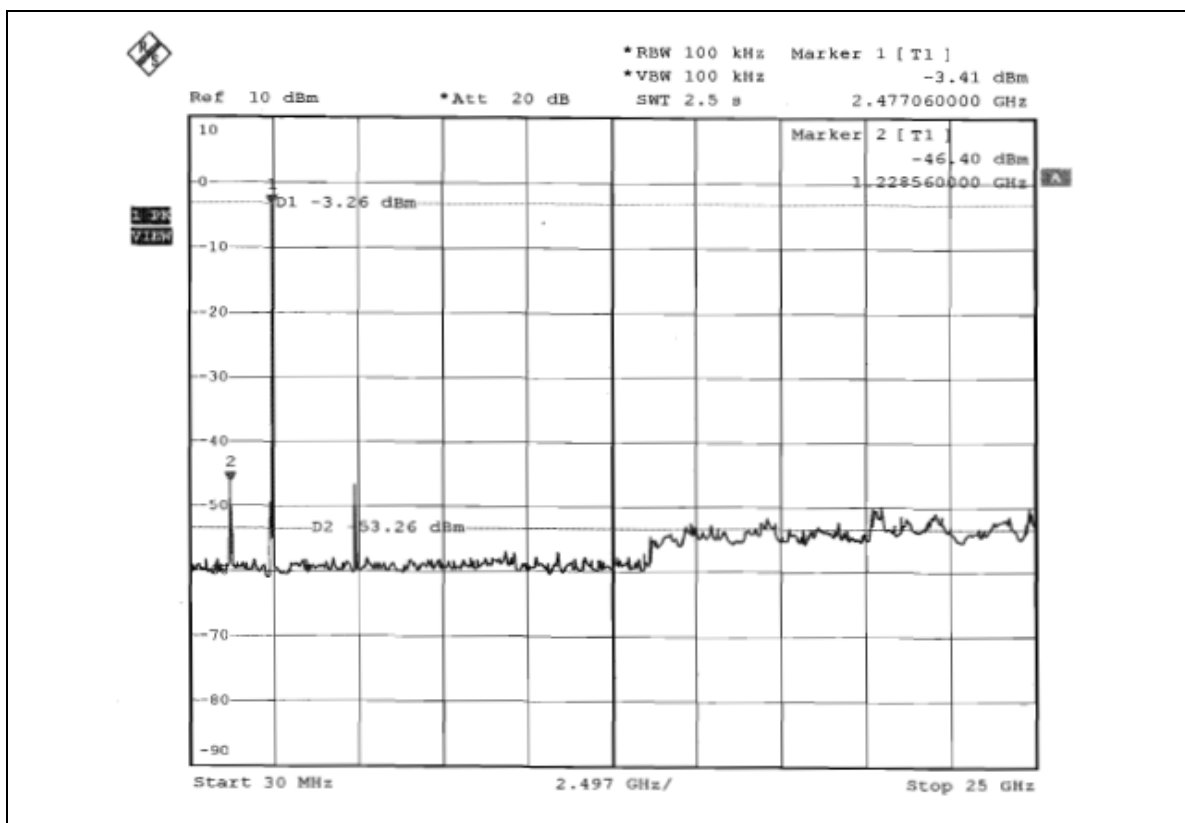
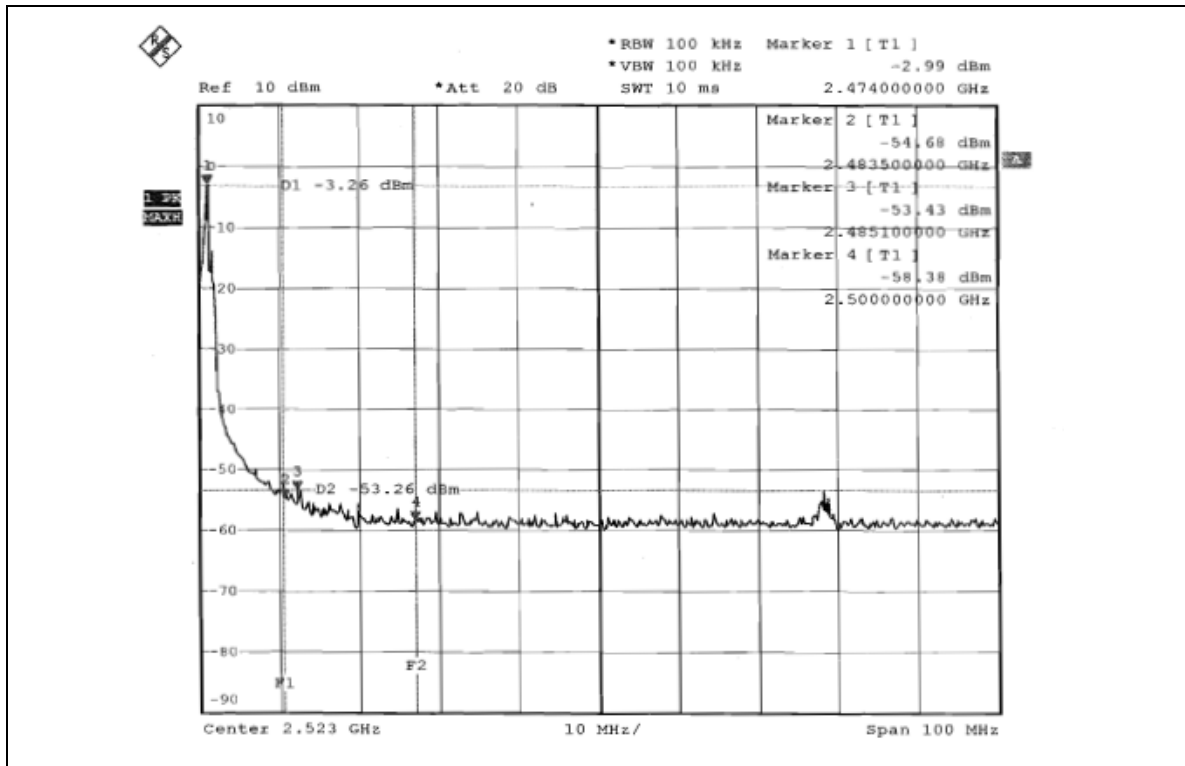



5. PHOTOGRAPHS OF THE TEST CONFIGURATION

Please refer to the attached file (Test Setup Photo).



6. INFORMATION ON THE TESTING LABORATORIES

We, ADT Corp., were founded in 1988 to provide our best service in EMC, Radio, Telecom and Safety consultation. Our laboratories are accredited and approved by the following approval agencies according to ISO/IEC 17025.

USA	FCC, UL, A2LA
Germany	TUV Rheinland
Japan	VCCI
Norway	NEMKO
Canada	INDUSTRY CANADA, CSA
R.O.C.	TAF, BSMI, NCC
Netherlands	Telefication
Singapore	PSB, GOST-ASIA(MOU)
Russia	CERTIS(MOU)

Copies of accreditation certificates of our laboratories obtained from approval agencies can be downloaded from our web site:

www.adt.com.tw/index.5/phtml. If you have any comments, please feel free to contact us at the following:

Linko EMC/RF Lab:

Tel: 886-2-26052180
Fax: 886-2-26051924

Hsin Chu EMC/RF Lab:

Tel: 886-3-5935343
Fax: 886-3-5935342

Hwa Ya EMC/RF/Safety Telecom Lab:

Tel: 886-3-3183232
Fax: 886-3-3185050

Web Site: www.adt.com.tw

The address and road map of all our labs can be found in our web site also



7.APPENDIX A – MODIFICATIONS RECORDERS FOR ENGINEERING CHANGES TO THE EUT BY THE LAB

No any modifications are made to the EUT by the lab during the test.