



### FCC- TEST REPORT

Report Number : **68.910.22.0004.01** Date of Issue: 2022-03-10

Model : Z-6000, Z-7000

Product Type : Air Purifier

Applicant : ACCO Brands, Inc.

Address : 4 Corporate Drive Lake Zurich Illinois United States 60047

Manufacturer : ACCO Brands, Inc.

Address : 4 Corporate Drive Lake Zurich Illinois United States 60047

Test Result :  **Positive**     **Negative**

Total pages including Appendices : 27

Any use for advertising purposes must be granted in writing. This technical report may only be quoted in full. This report is the result of a single examination of the object in question and is not generally applicable evaluation of the quality of other products in regular production. For further details, please see testing and certification regulation chapter A-3.4.



# 1 Table of Contents

1 Table of Contents .....	2
2 Details about the Test Laboratory .....	3
3 Description of the Equipment Under Test .....	4
4 Summary of Test Standards .....	5
5 Summary of Test Results .....	6
6 General Remarks .....	7
7 Test setups .....	8
8 Technical Requirement .....	9
8.1 Conducted Emission .....	9
8.2 Field strength of emissions and Restricted bands .....	14
8.3 Out of Band Emissions .....	19
8.4 20dB Bandwidth & 99% Occupied Bandwidth .....	22
9 Test equipment lists .....	26
10 System Measurement Uncertainty .....	27



## 2 Details about the Test Laboratory

### Details about the Test Laboratory

#### Test Site 1

Company name: TÜV SÜD Certification and Testing (China) Co., Ltd. Shenzhen Branch  
Building 12&13, Zhiheng Wisdomland Business Park,  
Nantou Checkpoint Road 2, Nanshan District,  
Shenzhen City, 518052,  
P. R. China

FCC Registration Number: 514049

Telephone: 86 755 8828 6998  
Fax: 86 755 8828 5299



### 3 Description of the Equipment Under Test

#### Description of the Equipment Under Test

Product: Air Purifier

Model no: Z-6000, Z-7000

FCC ID: GV3-21Z7000

Options and accessories: NIL

Ratings: 100-127V~, 50/60Hz, 2.0A

RF Transmission Frequency: 2402-2480MHz

Antenna Type: PCB Antenna

Antenna Gain: 2.0dBi

Description of the EUT: The product is a Air Purifier that operated at 2.4GHz, The TX and RX range is 2402MHz, 2440MHz, 2480MHz

#### Auxiliary Equipment Used during Test:

DESCRIPTION	MANUFACTURER	RATINGS	MODEL NO.
---	---	---	---



## 4 Summary of Test Standards

Test Standards	
FCC Part 15 Subpart C 10-1-2020 Edition	PART 15 - RADIO FREQUENCY DEVICES Subpart C - Intentional Radiators

All the test methods were according to ANSI C63.10-2013.



## 5 Summary of Test Results

Technical Requirements				
FCC Part 15 Subpart C 15.249				
Test Condition	Test Site	Test Result		
		Pass	Fail	N/A
15.207 Conducted emission AC power port	Site 1	<input checked="" type="checkbox"/>	<input type="checkbox"/>	<input type="checkbox"/>
§15.205(a), §15.209(a), §15.249(a), §15.249(c) & Field strength of emissions and Restricted bands	Site 1	<input checked="" type="checkbox"/>	<input type="checkbox"/>	<input type="checkbox"/>
§15.249(d) Out of band emissions	Site 1	<input checked="" type="checkbox"/>	<input type="checkbox"/>	<input type="checkbox"/>
FCC §15.215(c) 20dB bandwidth & 99% Occupied Bandwidth	Site 1	<input checked="" type="checkbox"/>	<input type="checkbox"/>	<input type="checkbox"/>
§15.203 Antenna requirement	See note 1	<input checked="" type="checkbox"/>	<input type="checkbox"/>	<input type="checkbox"/>

Remark 1: N/A- Not Applicable;

Note 1: The EUT used an integral PCB antenna, which gain is 2.0dBi. According to §15.203, it is considered sufficiently to comply with the provisions of this section.



## 6 General Remarks

### Remarks

This submittal(s) (test report) is intended for FCC ID: GV3-21Z7000 complies with Section 15.207, 15.205, 15.209, 15.249 of the FCC Part 15, Subpart C Rules.

Two models are identical except quantity for UV LED and enclosure size, so all the EMC requirements were applied on Z-7000 test and another models are deemed to fulfil the relevant EMC requirements without further testing.

### SUMMARY:

All tests according to the regulations cited on page 5 were

n - Performed

o - **Not** Performed

The Equipment Under Test

n - **Fulfills** the general approval requirements.

o - **Does not** fulfill the general approval requirements.

Sample Received Date: 2021-12-15

Testing Start Date: 2021-12-15

Testing End Date: 2022-03-08

- TÜV SÜD Certification and Testing (China) Co., Ltd. Shenzhen Branch -

Reviewed by:

Prepared by:

Tested by:

John Zhi  
Project Manager

Mark Chen  
Project Engineer



Carry Cai  
Test Engineer

## 7 Test setups

### 7.1 AC Power Line Conducted Emission test setups

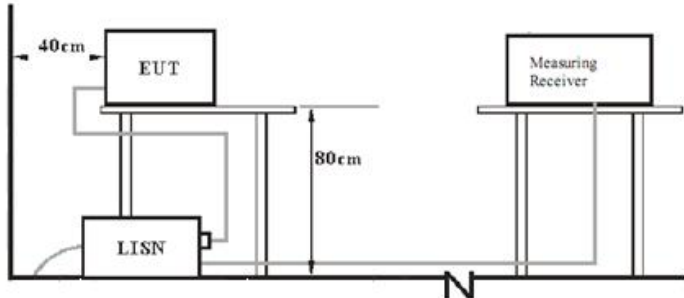

### 7.2 Radiated test setups

#### Below 1GHz

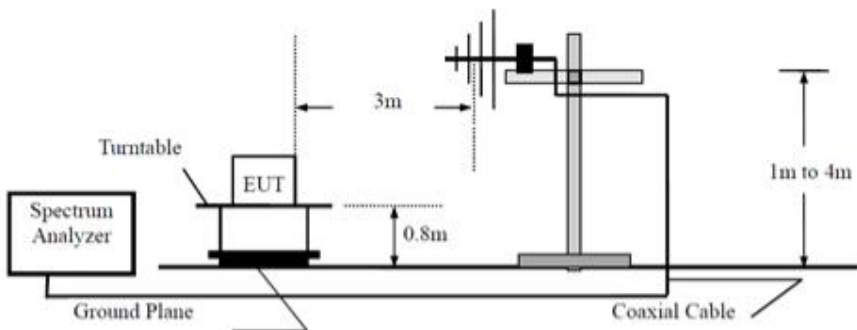

#### Above 1GHz

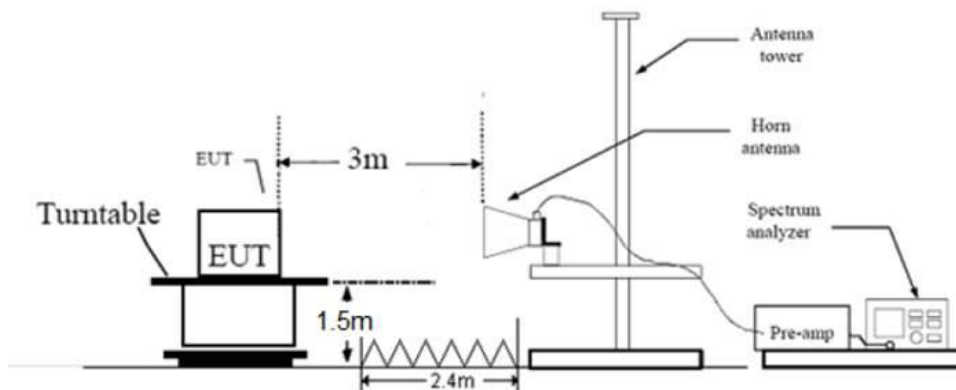



## 8 Technical Requirement

### 8.1 Conducted Emission

#### Test Method

1. The EUT was placed on a table, which is 0.8m above ground plane
2. The power line of the EUT is connected to the AC mains through a Artificial Mains Network (A.M.N.).
3. Maximum procedure was performed to ensure EUT compliance
4. A EMI test receiver is used to test the emissions from both sides of AC line

#### Limit

Frequency MHz	QP Limit dB $\mu$ V	AV Limit dB $\mu$ V
0.150-0.500	66-56*	56-46*
0.500-5	56	46
5-30	60	50

\*Decreasing linearly with logarithm of the frequency.



### Conducted Emission

Product Type : Air Purifier  
 M/N : Z-6000  
 Operating Condition : Normal working with transmitting  
 Test specification : Live  
 Comment : AC 120V/60Hz

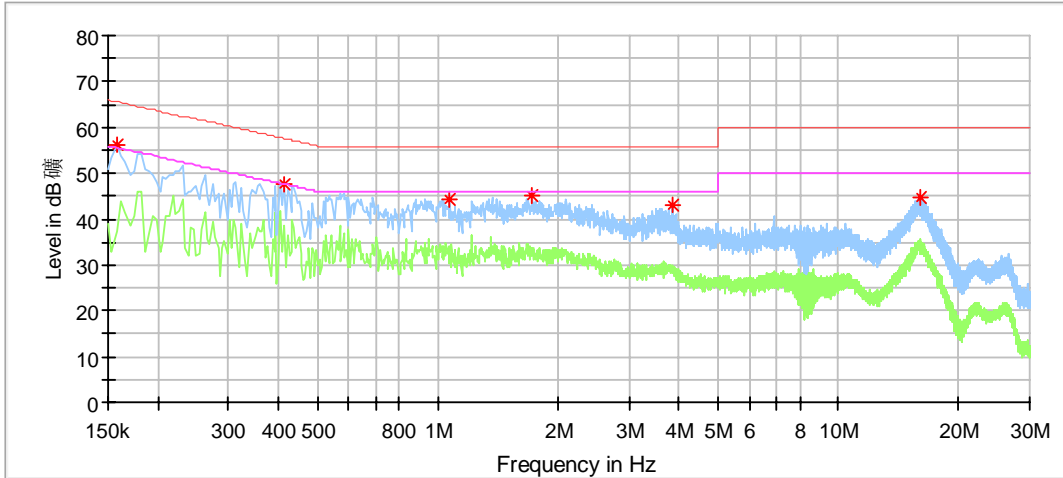

### Critical Freqs

Frequency (MHz)	MaxPeak (dBµV)	Average (dBµV)	Limit (dBµV)	Margin (dB)	Line	Corr. (dB/m)
0.158000	56.31	---	65.57	9.26	L1	9.25
0.414000	47.60	---	57.57	9.97	L1	9.21
1.074000	44.46	---	56.00	11.54	L1	9.20
1.726000	45.07	---	56.00	10.93	L1	9.22
3.846000	43.21	---	56.00	12.79	L1	9.27
16.066000	44.54	---	60.00	15.46	L1	9.40

Remark:

Level=Reading Level + Correction Factor

Correction Factor=Cable Loss + LISN Factor

(The Reading Level is recorded by software which is not shown in the sheet)



### Conducted Emission

Product Type : Air Purifier  
 M/N : Z-6000  
 Operating Condition : Normal working with transmitting  
 Test specification : Neutral  
 Comment : AC 120V/60Hz

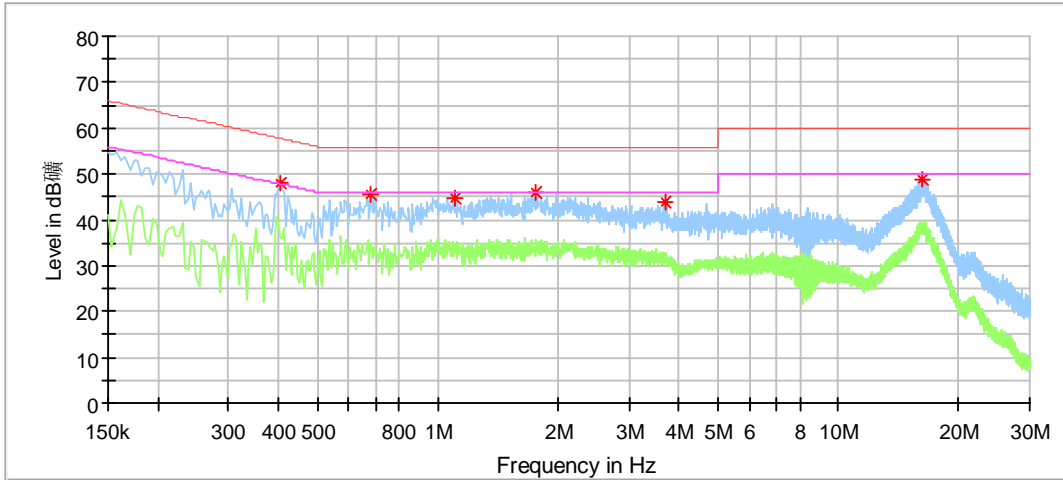

### Critical Freqs

Frequency (MHz)	MaxPeak (dBµV)	Average (dBµV)	Limit (dBµV)	Margin (dB)	Line	Corr. (dB/m)
0.406000	48.18	---	57.73	9.55	N	9.38
0.682000	45.48	---	56.00	10.52	N	9.39
1.106000	44.63	---	56.00	11.37	N	9.40
1.758000	45.79	---	56.00	10.21	N	9.41
3.682000	43.87	---	56.00	12.13	N	9.46
16.206000	48.82	---	60.00	11.18	N	9.65

Remark:

Level=Reading Level + Correction Factor

Correction Factor=Cable Loss + LISN Factor

(The Reading Level is recorded by software which is not shown in the sheet)

## Conducted Emission

Product Type : Air Purifier  
 M/N : Z-7000  
 Operating Condition : Normal working with transmitting  
 Test specification : Live  
 Comment : AC 120V/60Hz

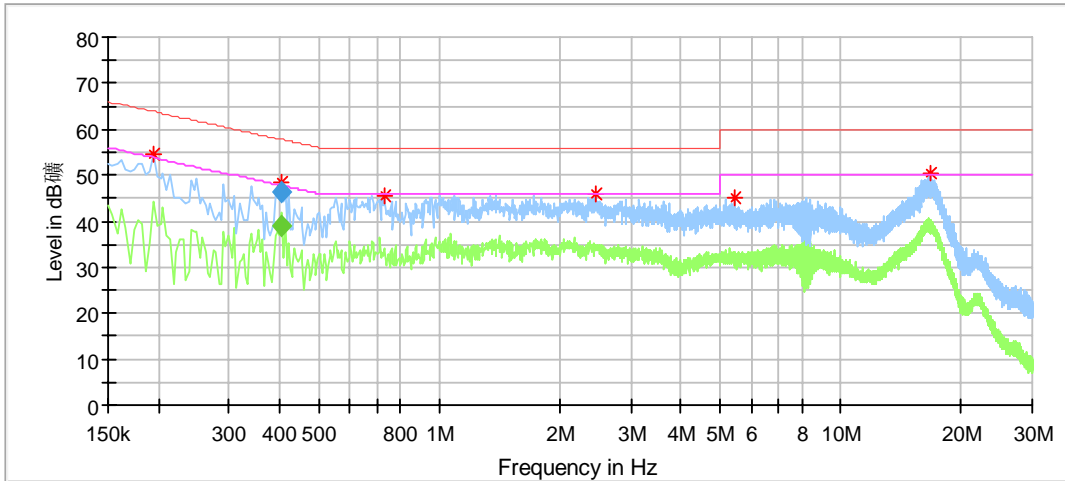

### Critical Freqs

Frequency (MHz)	MaxPeak (dBµV)	Average (dBµV)	Limit (dBµV)	Margin (dB)	Line	Corr. (dB/m)
0.194000	54.37	---	63.86	9.49	N	9.40
0.405500	48.37	---	57.73	9.36	N	9.38
0.730000	45.40	---	56.00	10.60	N	9.39
2.450000	46.05	---	56.00	9.95	N	9.43
5.438000	45.32	---	60.00	14.68	N	9.51
16.686000	50.56	---	60.00	9.44	N	9.66

### Final Result

Frequency (MHz)	QuasiPeak (dBµV)	Average (dBµV)	Limit (dBµV)	Margin (dB)	Line	Corr. (dB/m)
0.405500	---	38.93	47.74	8.81	N	9.38
0.405500	46.34	---	57.74	11.40	N	9.38

Remark:

Level=Reading Level + Correction Factor

Correction Factor=Cable Loss + LISN Factor

(The Reading Level is recorded by software which is not shown in the sheet)



### Conducted Emission

Product Type : Air Purifier  
 M/N : Z-7000  
 Operating Condition : Normal working with transmitting  
 Test specification : Neutral  
 Comment : AC 120V/60Hz

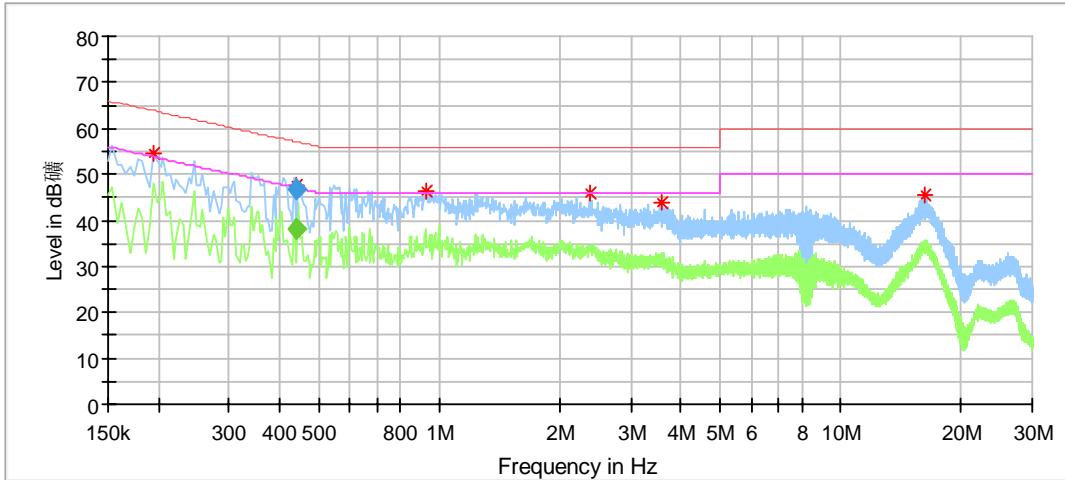

### Critical\_Freqs

Frequency (MHz)	MaxPeak (dBµV)	Average (dBµV)	Limit (dBµV)	Margin (dB)	Line	Corr. (dB/m)
0.194000	54.59	---	63.86	9.28	L1	9.24
0.441500	47.64	---	56.95	9.31	L1	9.20
0.934000	46.19	---	56.00	9.81	L1	9.20
2.366000	45.84	---	56.00	10.16	L1	9.24
3.594000	43.70	---	56.00	12.30	L1	9.27
16.266000	45.74	---	60.00	14.26	L1	9.40

### Final Result

Frequency (MHz)	QuasiPeak (dBµV)	Average (dBµV)	Limit (dBµV)	Margin (dB)	Line	Corr. (dB/m)
0.441500	---	38.27	47.03	8.77	L1	9.20
0.441500	46.81	---	57.03	10.23	L1	9.20

Remark:

Level=Reading Level + Correction Factor

Correction Factor=Cable Loss + LISN Factor

(The Reading Level is recorded by software which is not shown in the sheet)

## 8.2 Field strength of emissions and Restricted bands

### Test Method

- 1: The EUT was placed on a turn table which is 1.5m above ground plane for above 1GHz and 0.8m above ground for below 1GHz at 3-meter chamber room for test. The table was rotated 360 degrees to determine the position of the highest radiation.
- 2: The EUT was set 3 meters away from the interference – receiving antenna, which was mounted on the top of a variable – height antenna tower.
- 3: The height of antenna is varied from one meter to four meters above the ground to determine the maximum value of the field strength. Both horizontal and vertical polarizations of the antenna are set to make the measurement.
- 4: For each suspected emission, the EUT was arranged to its worst case and then the antenna was tuned to heights from 1 meter to 4 meters and the rotatable table was turned from 0 degrees to 360 degrees to find the maximum reading.
- 5: Use the following spectrum analyzer settings According to C63.10:

#### For Above 1GHz

Span = wide enough to capture the peak level of the in-band emission and all spurious  
RBW = 1MHz, VBW $\geq$ RBW for peak measurement and VBW = 10Hz for average measurement, Sweep = auto, Detector function = peak, Trace = max hold.

#### For Below 1GHz

Use the following spectrum analyzer settings:

Span = wide enough to capture the peak level of the in-band emission and all spurious  
RBW = 100 KHz, VBW $\geq$ RBW for peak measurement, Sweep = auto, Detector function = peak, Trace = max hold.

### Note:

- 1: The resolution bandwidth and video bandwidth of test receiver/spectrum analyzer is 120 KHz for Quasi-peak detection (QP) at frequency below 1GHz.
- 2: The resolution bandwidth of test receiver/spectrum analyzer is 1MHz and the video bandwidth is 3MHz for peak detection (PK) at frequency above 1GHz.
- 3: The resolution bandwidth of test receiver/spectrum analyzer is 1MHz and the video bandwidth is 3MHz for RMS Average ((duty cycle < 98%) for Average detection (AV) at frequency above 1GHz, then the measurement results was added to a correction factor (20log (1/duty cycle)).
- 4: The resolution bandwidth of test receiver/spectrum analyzer is 1MHz and the video bandwidth is 10Hz (duty cycle > 98%) for Average detection (AV) at frequency above 1GHz.



**Field strength of emissions and Restricted bands**

**Limits**

According to §15.249 (a) the field strength of emissions from intentional radiators operated within these frequency bands shall comply with the following:

Fundamental frequency	Field strength of fundamental (millivolts/meter)	Field strength of harmonics (microvolts/meter)
902–928 MHz	50	500
2400–2483.5 MHz	50	500
5725–5875 MHz	50	500
24.0–24.25 GHz	250	2500

According to §15.249 (c), Field strength limits are specified at a distance of 3 meters. According to §15.249 (d), Emissions radiated outside of the specified frequency bands, except for harmonics, shall be attenuated by at least 50 dB below the level of the fundamental or to the general radiated emission limits in §15.209, whichever is the lesser attenuation.

Frequency MHz	Field Strength uV/m	Field Strength dBµV/m	Detector
30-88	100	40	QP
88-216	150	43.5	QP
216-960	200	46	QP
960-1000	500	54	QP
Above 1000	500	54	AV
Above 1000	5000	74	PK

## Field strength of emissions and Restricted bands

According to C63.10, if the peak (or quasi-peak) measured value complies with the average limit, it is unnecessary to perform an average measurement, so AV emission value did not show in below table if the peak value complies with average limit.

### Fundamental test result as below:

#### Low channel 2402MHz Test Result

Radiated Emission							
Value	Emissions Frequency MHz	E-Field Polarity	Reading Level dB $\mu$ V/m	Limit dB $\mu$ V/m	Margin dBm	Correct factor (dB/m)	Result
PK	2402	H	79.25	114.00	34.75	-3.14	Pass
AV	2402	H	67.38	94.00	26.62	-3.14	Pass
PK	2402	V	77.91	114.00	36.09	-3.14	Pass
AV	2402	V	66.04	94.00	27.96	-3.14	Pass

#### Middle channel 2440MHz Test Result

Radiated Emission							
Value	Emissions Frequency MHz	E-Field Polarity	Reading Level dB $\mu$ V/m	Limit dB $\mu$ V/m	Margin dBm	Correct factor (dB/m)	Result
PK	2440	H	77.75	114.00	36.25	-3.01	Pass
AV	2440	H	65.88	94.00	28.12	-3.01	Pass
PK	2440	V	78.01	114.00	35.99	-3.01	Pass
AV	2440	V	66.14	94.00	27.86	-3.01	Pass

#### High channel 2480MHz Test Result

Radiated Emission							
Value	Emissions Frequency MHz	E-Field Polarity	Reading Level dB $\mu$ V/m	Limit dB $\mu$ V/m	Margin dBm	Correct factor (dB/m)	Result
PK	2480	H	78.33	114.00	35.67	-2.76	Pass
AV	2480	H	66.46	94.00	27.54	-2.76	Pass
PK	2480	V	77.56	114.00	36.44	-2.76	Pass
AV	2480	V	65.69	94.00	28.31	-2.76	Pass



**Transmitting spurious emission test result as below:**  
Low channel 2402MHz Test Result

Frequency Band	Frequency	Emission Level	Polarization	Limit	Detector	Margin	Correct factor (dB/m)	Result
	MHz	dB $\mu$ V/m		dB $\mu$ V/m		dB $\mu$ V/m		
30-1000MHz	883.923	36.03	H	46	QP	9.97	31.41	Pass
	39.053	36.90	V	46	QP	3.10	19.17	Pass
1000-25000MHz	2748.095	46.3	H	74	PK	27.77	-2.27	Pass
	--	--	H	54	AV	--	--	Pass
	13776	45.43	V	74	PK	28.57	12.12	Pass
	--	--	V	54	AV	--	--	Pass

Middle channel 2440MHz Test Result

Frequency Band	Frequency	Emission Level	Polarization	Limit	Detector	Margin	Correct factor (dB/m)	Result
	MHz	dB $\mu$ V/m		dB $\mu$ V/m		dB $\mu$ V/m		
30-1000MHz	--	--	H	43.5	QP	--	--	Pass
	--	--	H	46	QP	--	--	Pass
1000-25000MHz	9844.5	43.91	H	74	PK	30.09	11.54	Pass
	--	--	H	54	AV	--	--	Pass
	10800.5	44.06	V	74	PK	29.94	10.66	Pass
	--	--	V	54	AV	--	--	Pass

High channel 2480MHz Test Result

Frequency Band	Frequency	Emission Level	Polarization	Limit	Detector	Margin	Correct factor (dB/m)	Result
	MHz	dB $\mu$ V/m		dB $\mu$ V/m		dB $\mu$ V/m		
30-1000MHz	--	--	H	43.5	QP	--	--	Pass
	--	--	H	46	QP	--	--	Pass
1000-25000MHz	6896.5	41.23	H	74	PK	32.77	7.13	Pass
	--	--	H	54	AV	--	--	Pass
	9898.5	42.73	V	74	PK	31.27	11.21	Pass
	--	--	V	54	AV	--	--	Pass



Duty cycle=0.1594 × 16/10=0.25504  
 Peak to average duty cycle correction factor =20log(duty cycle)=-11.87

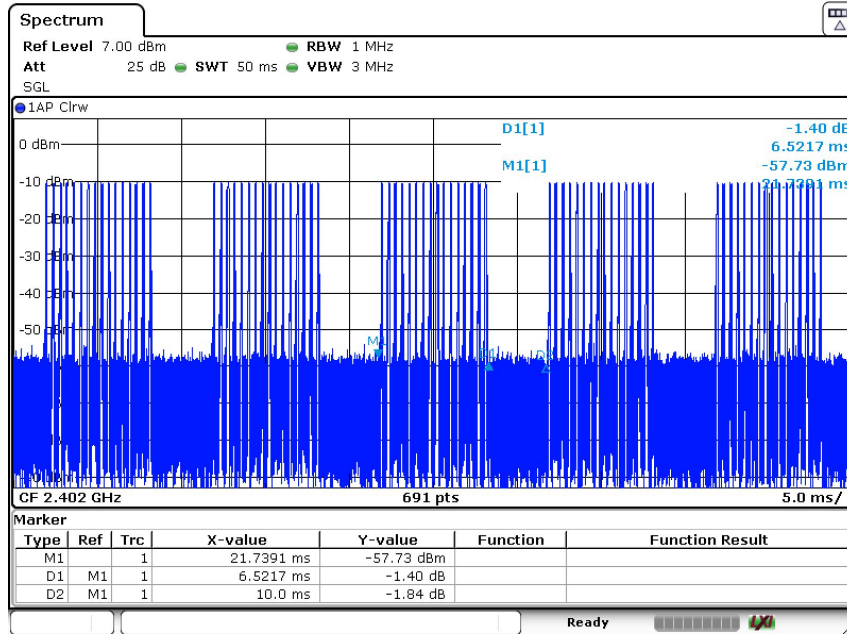

Date: 8.MAR.2022 16:02:39

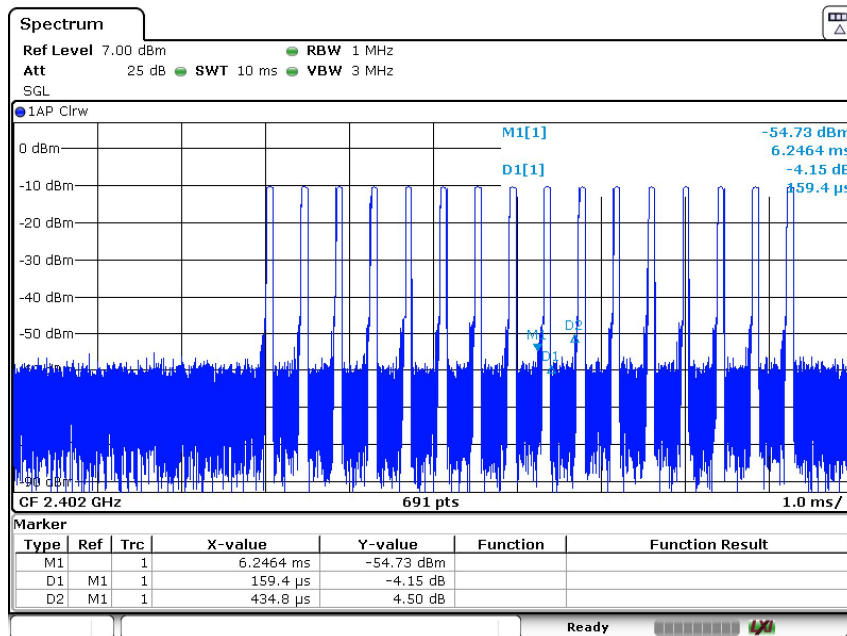

Date: 8.MAR.2022 16:03:30

Remark:

- (1) Data of measurement within this frequency range shown "--" in the table above means the reading of emissions are the noise floor or attenuated more than 10dB below the permissible limits or the field strength is too small to be measured.
- (2) Corrected Amplitude= Read level + Corrector factor  
 Above 1GHz: Corrector factor = Antenna Factor + Cable Loss- Pre-amplifier  
 Below 1GHz: Corrector factor = Antenna Factor + Cable Loss  
 (The Reading Level is recorded by software which is not shown in the sheet)
- (3) AV Emission = Average Reading Level + Correction Factor (for duty cycle≥98%)



## 8.3 Out of Band Emissions

### Test Method

- 1 Use the following spectrum analyzer settings:  
Span = wide enough to capture the peak level of the in-band emission and all spurious  
RBW = 100 kHz, VBW $\geq$ RBW, Sweep = auto, Detector function = peak, Trace = max hold.
- 2 Allow the trace to stabilize, use the peak and delta measurement to record the result.
- 3 The level displayed must comply with the limit specified in this Section.

### Limits

According to §15.249(d) Emissions radiated outside of the specified frequency bands, except for harmonics, shall be attenuated by at least 50 dB below the level of the fundamental or to the general radiated emission limits in §15.209, whichever is the lesser attenuation.



## Out of Band Emissions

2402MHz

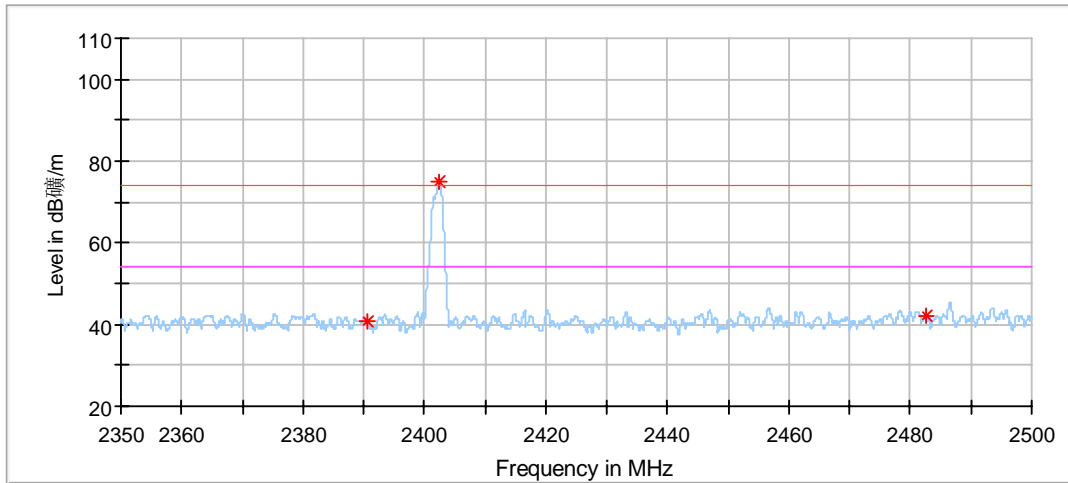

### Critical Freqs

Frequency (MHz)	MaxPeak (dBµV/m)	Limit (dBµV/m)	Margin (dB)	Height (cm)	Pol	Azimuth (deg)	Corr. (dB/m)
2390.642857	40.72	74.00	33.28	150.0	H	326.0	-3.12
2402.464286	74.98	74.00	-0.98	150.0	H	27.0	-3.14
2482.714286	42.19	74.00	31.81	150.0	H	11.0	-2.76

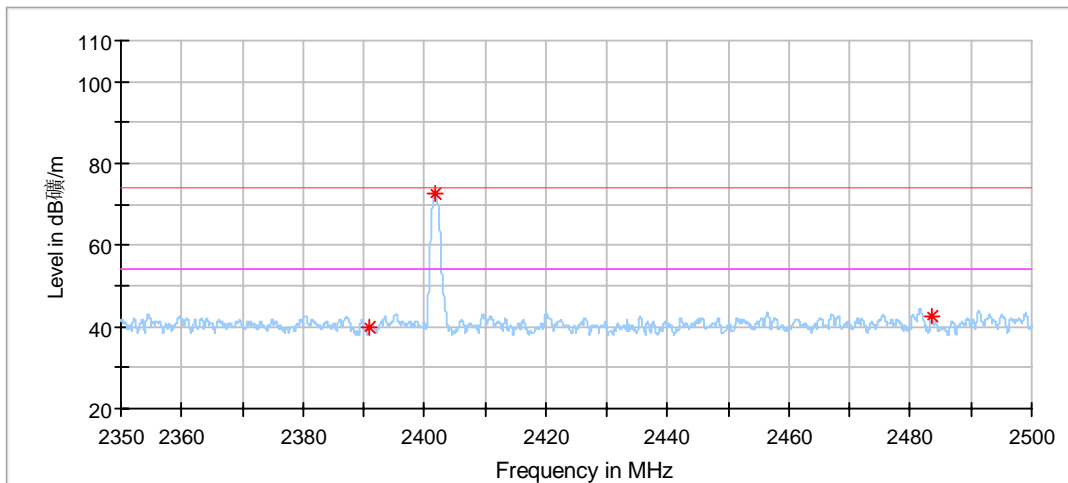

### Critical Freqs

Frequency (MHz)	MaxPeak (dBµV/m)	Limit (dBµV/m)	Margin (dB)	Height (cm)	Pol	Azimuth (deg)	Corr. (dB/m)
2391.000000	39.90	74.00	34.10	150.0	V	355.0	-3.12
2401.892857	72.74	74.00	1.26	150.0	V	320.0	-3.14
2483.428571	42.55	74.00	31.45	150.0	V	154.0	-2.76



2480MHz

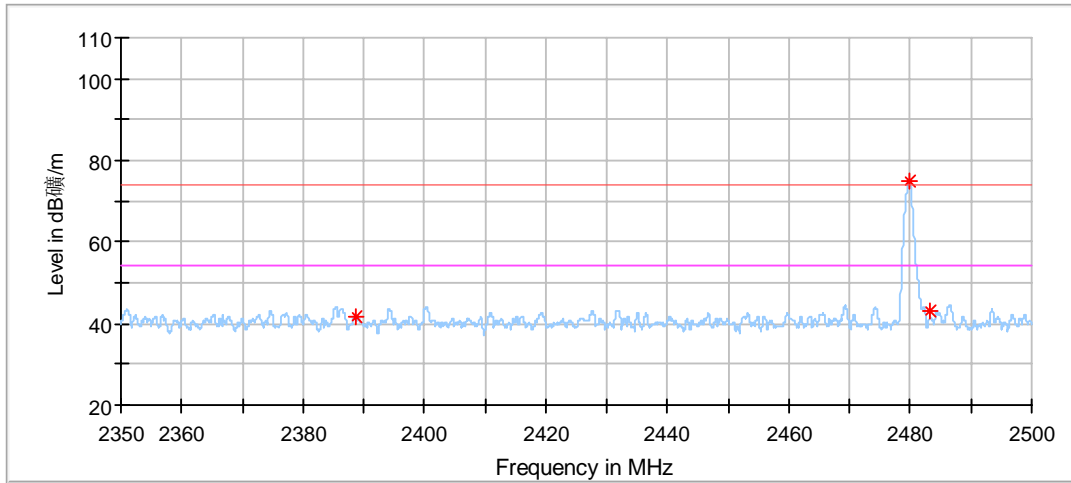

**Critical Freqs**

Frequency (MHz)	MaxPeak (dBµV/m)	Limit (dBµV/m)	Margin (dB)	Height (cm)	Pol	Azimuth (deg)	Corr. (dB/m)
2388.642857	41.66	74.00	32.34	150.0	H	220.0	-3.11
2479.785714	75.07	74.00	-1.07	150.0	H	16.0	-2.76
2483.321429	42.86	74.00	31.14	150.0	H	270.0	-2.76

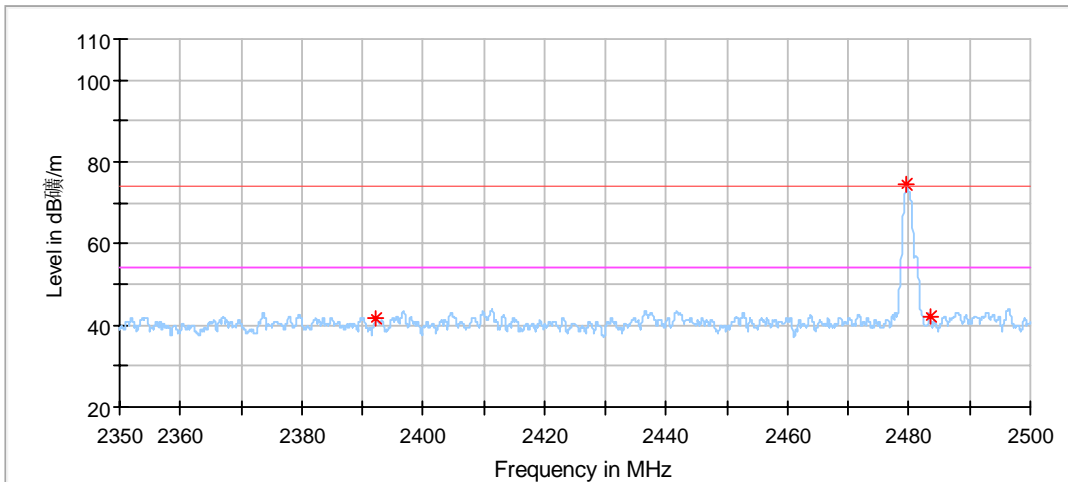

**Critical\_Freqs**

Frequency (MHz)	MaxPeak (dBµV/m)	Limit (dBµV/m)	Margin (dB)	Height (cm)	Pol	Azimuth (deg)	Corr. (dB/m)
2392.250000	41.51	74.00	32.49	150.0	V	27.0	-3.12
2479.678571	74.52	74.00	-0.52	150.0	V	63.0	-2.76
2483.500000	42.36	74.00	31.64	150.0	V	168.0	-2.76

## 8.4 20dB Bandwidth & 99% Occupied Bandwidth

### Test Method

1. Check the calibration of the measuring instrument using either an internal calibrator or a known signal from an external generator.
2. Position the EUT without connection to spectrum analyser. Turn on the EUT and connect it to measurement instrument. Then set it to any one convenient frequency within its operating range. Set a reference level on the measuring instrument equal to the highest peak value.
3. Measure the frequency difference of two frequencies that were attenuated 20dB from the reference level. Record the frequency difference as the emission bandwidth.

### Limits:

According to 15.215 (c) Intentional radiators operating under the alternative provisions to the general emission limits, as contained in §§ 15.217 through 15.257 and in Subpart E of this part, must be designed to ensure that the 20 dB bandwidth of the emission, or whatever bandwidth may otherwise be specified in the specific rule section under which the equipment operates, is contained within the frequency band designated in the rule section under which the equipment is operated. The requirement to contain the designated bandwidth of the emission within the specified frequency band includes the effects from frequency sweeping, frequency hopping and other modulation techniques that may be employed as well as the frequency stability of the transmitter over expected variations in temperature and supply voltage. If a frequency stability is not specified in the regulations, it is recommended that the fundamental emission be kept within at least the central 80% of the permitted band in order to minimize the possibility of out-of-band operation.



### 20dB Bandwidth & 99% Occupied Bandwidth

Frequency	20dB Bandwidth	99% Bandwidth	Limit
MHz	MHz	MHz	MHz
2402	5.152	3.748	--

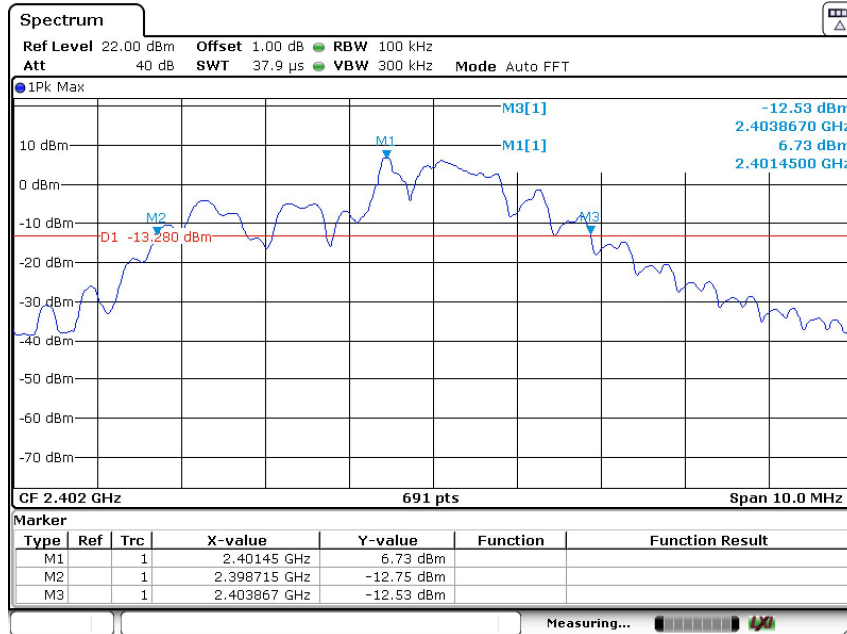

Date: 6 JAN 2022 15:46:38

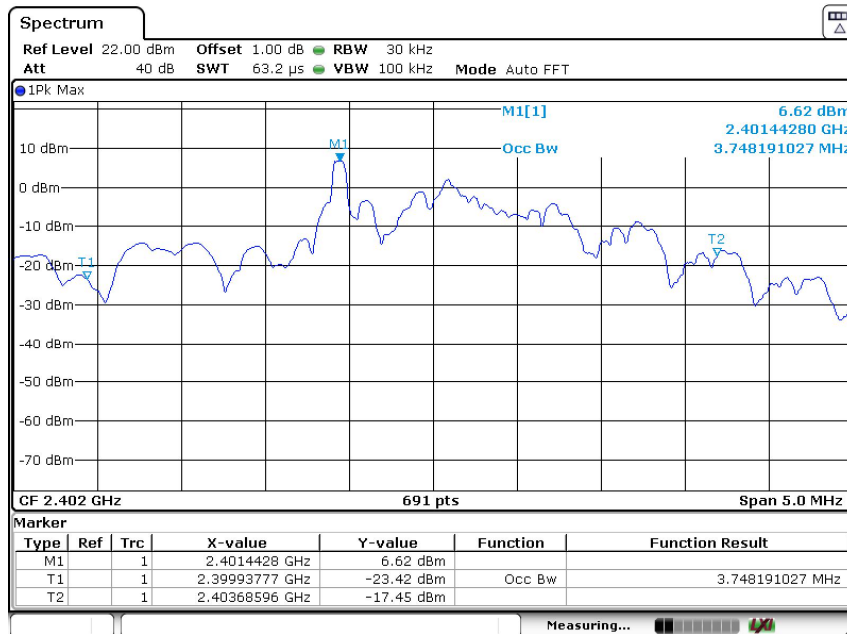

Date: 6 JAN 2022 15:44:11

2405MHz



### 20dB Bandwidth & 99% Occupied Bandwidth

Frequency MHz	20dB Bandwidth MHz	99% Bandwidth MHz	Limit MHz
2440	3.1187	2.4747	--

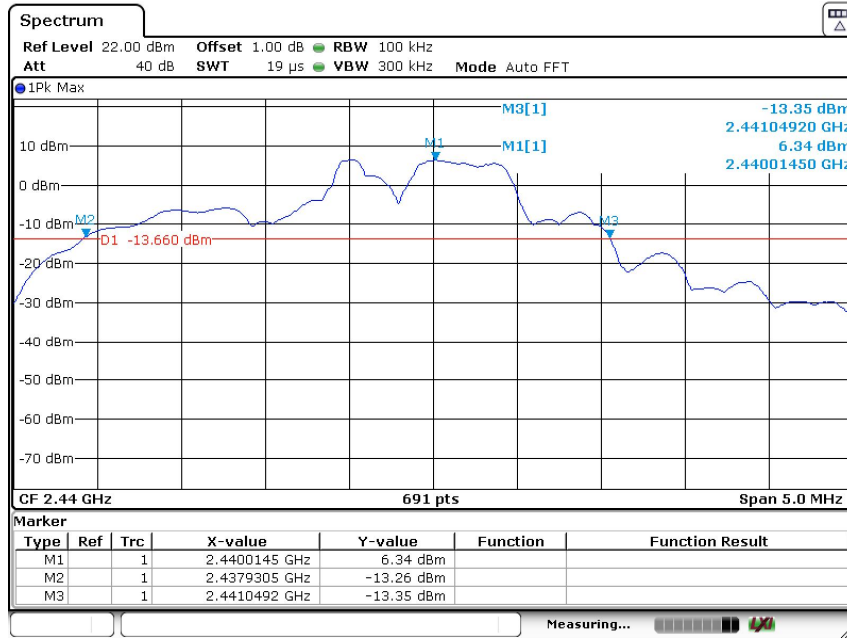

Date: 6 JAN 2022 15:32:50

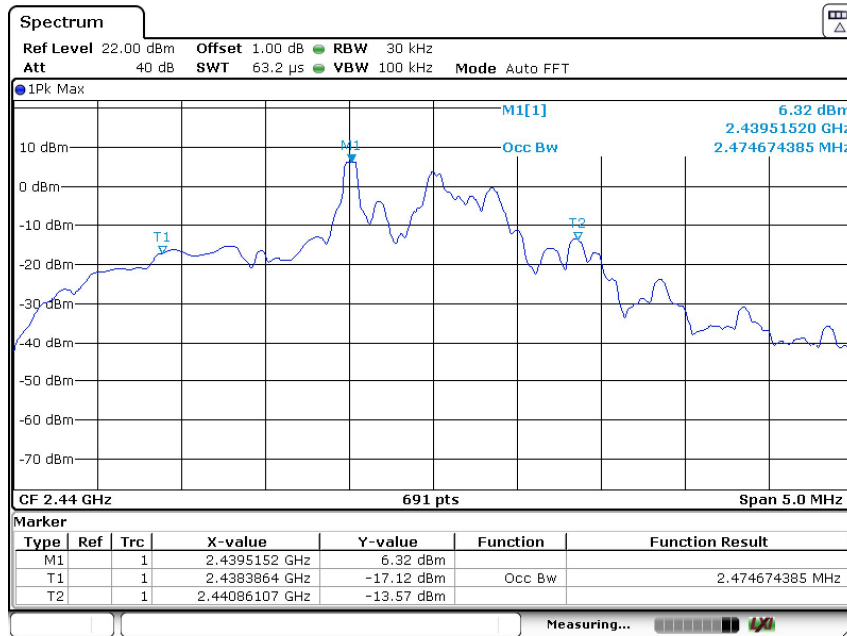

Date: 6 JAN 2022 15:39:38

2440MHz





**20dB Bandwidth & 99% Occupied Bandwidth**

Frequency	20dB Bandwidth	99% Bandwidth	Limit
MHz	MHz	MHz	MHz
2480	2.1491	1.534	--

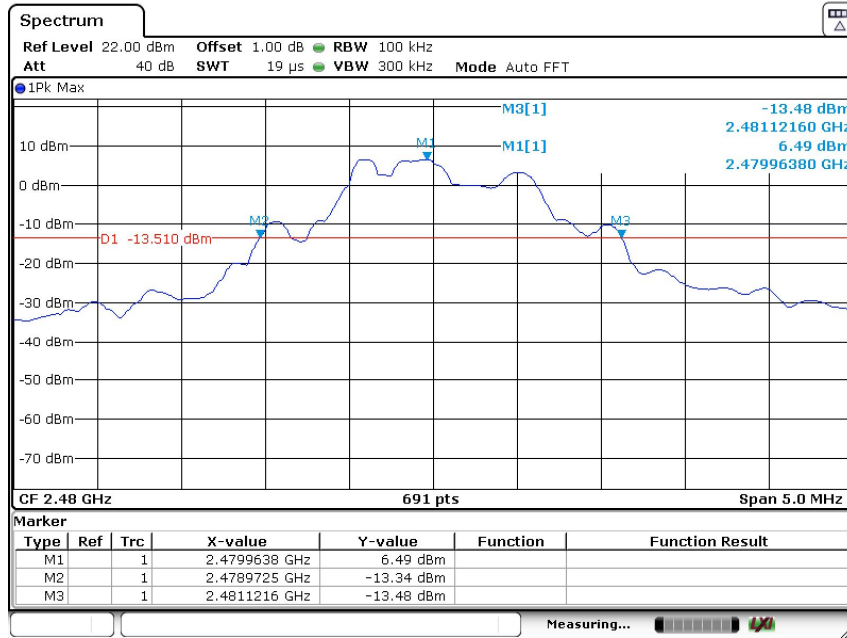

Date: 6 JAN 2022 15:33:52

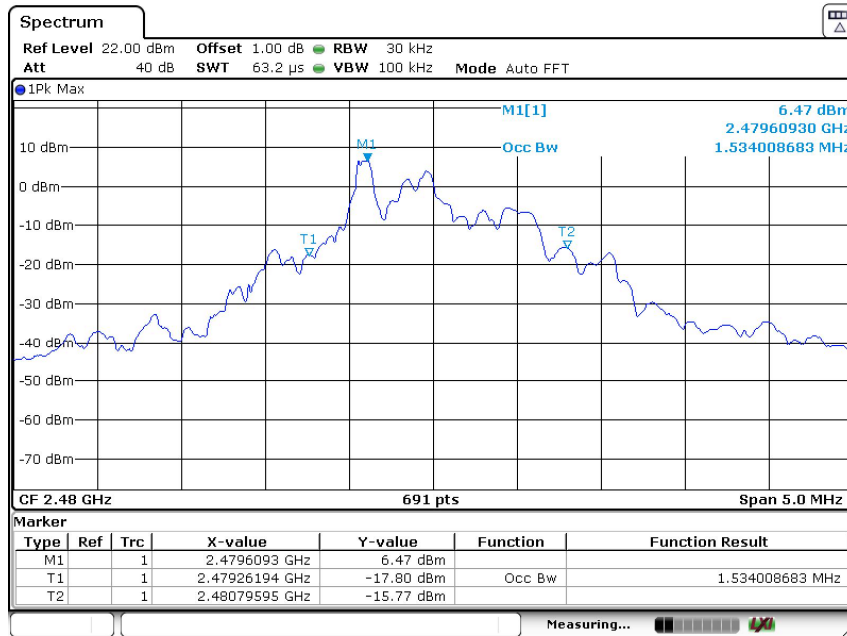

Date: 6 JAN 2022 15:36:04

2480MHz



## 9 Test equipment lists

### Conducted Emission 2# Test

DESCRIPTION	MANUFACTURER	MODEL NO.	EQUIPMENT ID	SERIAL NO.	CAL INTERVAL (YEAR)	CAL. DUE DATE
EMI Test Receiver	Rohde & Schwarz	ESR 3	68-4-74-19-002	102590	1	2022-6-4
LISN	Rohde & Schwarz	ENV216	68-4-87-19-001	102472	1	2022-6-5
Attenuator	Shanghai Huaxiang	TS2-26-3	68-4-81-16-003	080928189	1	2022-6-3
Test software	Rohde & Schwarz	EMC32	68-4-90-19-005-A01	Version10.35.02	N/A	N/A
Shielding Room	TDK	CSR #2	68-4-90-19-005	----	3	2022-11-07

### Radiated Emission Test 1# Test

DESCRIPTION	MANUFACTURER	MODEL NO.	EQUIPMENT ID	SERIAL NO.	CAL INTERVAL (YEAR)	CAL. DUE DATE
EMI Test Receiver	Rohde & Schwarz	ESR 7	68-4-74-19-001	102176	1	2022-6-4
Trilog Super Broadband Test Antenna	Schwarzbeck	VULB 9163	68-4-80-14-002	707	1	2022-7-23
Pre-amplifier	Rohde & Schwarz	SCU 18	68-4-29-14-001	102230	1	2022-6-6
Attenuator	Mini-circuits	UNAT-6+	68-4-81-21-001	15542	1	2022-8-23
3m Semi-anechoic chamber	TDK	SAC-3 #1	68-4-90-14-001	----	2	2023-5-28
Test software	Rohde & Schwarz	EMC32	68-4-90-14-001-A10	Version10.35.02	N/A	N/A

### Radiated Emission 2# Test

DESCRIPTION	MANUFACTURER	MODEL NO.	EQUIPMENT ID	SERIAL NO.	CAL INTERVAL (YEAR)	CAL. DUE DATE
EMI Test Receiver	Rohde & Schwarz	ESR 26	68-4-74-14-002	101269	1	2022-6-4
Wave Guide Antenna	ETS	3117	68-4-80-19-001	00218954	1	2022-5-24
Pre-amplifier	Rohde & Schwarz	SCU 18F	68-4-29-19-001	100745	1	2022-10-10
Pre-amplifier	Rohde & Schwarz	SCU 18F	68-4-29-19-002	100746	1	2022-10-10
Sideband Horn Antenna	Q-PAR	QWH-SL-18-40-K-SG	68-4-80-14-008	12827	1	2022-7-21
Pre-amplifier	Rohde & Schwarz	SCU 40A	68-4-29-14-002	100432	1	2022-7-27
Attenuator	Mini-circuits	UNAT-6+	68-4-81-21-002	15542	1	2022-8-23
3m Semi-anechoic chamber	TDK	SAC-3 #2	68-4-90-19-006	----	2	2023-5-28
Test software	Rohde & Schwarz	EMC32	68-4-90-19-006-A01	Version10.35.02	N/A	N/A



## 10 System Measurement Uncertainty

For a 95% confidence level, the measurement expanded uncertainties for defined systems, in accordance with the recommendations of ISO 17025 were:

System Measurement Uncertainty	
Test Items	Extended Uncertainty
Uncertainty for Conducted Emission 150kHz-30MHz (for test using AMN ENV432 or ENV4200)	3.64dB
Uncertainty for Radiated Emission in 3m chamber 30MHz-1000MHz	Horizontal: 4.63dB; Vertical: 4.61dB;
Uncertainty for Radiated Spurious Emission 1000MHz-3000MHz	Horizontal: 4.81dB; Vertical: 4.89dB;
Uncertainty for Radiated Spurious Emission 3000MHz-18000MHz	Horizontal: 4.65dB; Vertical: 4.63dB;
Uncertainty for Radiated Spurious Emission 18000MHz-40000MHz	Horizontal: 4.51dB; Vertical: 4.50dB;