

Rhein Tech Laboratories
360 Herndon Parkway
Suite 1400
Herndon, VA 20170
<http://www.rheintech.com>

Client: Paxar Americas, Inc.
FCC: Part 15.247
Industry Canada: RSS-210
FCC ID: GU6RFIDALN1
Model : ALR-9932-A

APPENDIX I: MANUAL

Please refer to the following pages.

Quick Reference

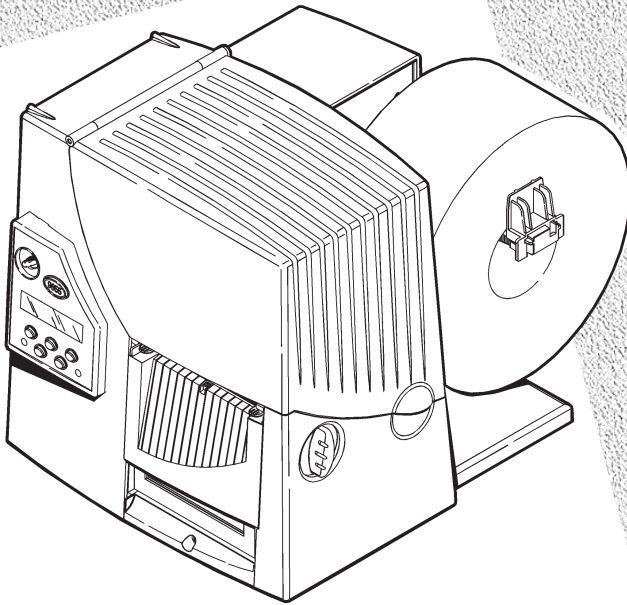

Ship From:
Dayton, Ohio



Ship From:
Dayton, Ohio



Ship From:
Dayton, Ohio

Monarch[®]
9855[™] RFID
Printer

BETA

PAXAR

Each product and program carries a respective written warranty, the only warranty on which the customer can rely. Paxar reserves the right to make changes in the product, the programs, and their availability at any time and without notice. Although Paxar has made every effort to provide complete and accurate information in this manual, Paxar shall not be liable for any omissions or inaccuracies. Any update will be incorporated in a later edition of this manual.

©2004 Paxar Americas, Inc. All rights reserved. No part of this publication may be reproduced, transmitted, stored in a retrieval system, or translated into any language in any form by any means, without the prior written permission of Paxar Americas, Inc.

WARNING

This equipment has been tested and found to comply with the limits for a Class A digital device, pursuant to Part 15 of the FCC Rules. These limits are designed to provide reasonable protection against harmful interference when the equipment is operated in a commercial environment. This equipment generates, uses, and can radiate radio frequency energy and, if not installed and used in accordance with the instruction manual, may cause harmful interference to radio communications. Operation of this equipment in a residential area is likely to cause harmful interference in which case the user will be required to correct the interference at his own expense.

CANADIAN D.O.C. WARNING

This digital apparatus does not exceed the Class A limits for radio noise emissions from digital apparatus set out in the Radio Interference Regulations of the Canadian Department of Communications.

Le présent appareil numérique n'émet pas de bruits radioélectriques dépassant les limites applicables aux appareils numériques de la classe A prescrites dans le Règlement sur le brouillage radioélectrique édicté par le ministère des Communications du Canada.

Regulatory Compliance

Paxar RF products are designed to be compliant with the rules and regulations in the locations into which they are sold and will be labeled as required. The majority of Paxar RF devices are type approved and do not require the user to obtain license or authorization before using the equipment. Any changes or modifications to Paxar equipment not expressly approved by Paxar could void the user authority to operate the equipment.

FCC RF Exposure Guidelines

To comply with FCC exposure requirements, antennas that are mounted externally at remote locations or operating near users at stand-alone desktop of similar configurations must operate with a minimum separation distance of 20 cm from all persons.

Declaration of Conformity for RF Exposure:

The radio module has been evaluated under FCC Bulletin OET 65C and found compliant to the requirements as set forth in CFR 47 Sections 2.1091, 2.1093, and 15.247 (b) (4) addressing RF Exposure from radio frequency devices.

Radio Frequency Interference Requirements

This device complies with Part 15 of the FCC Rules. Operation is subject to the following two conditions: 1) this device may not cause harmful interference, and 2) this device must accept any interference that may cause undesired operations.

CAUTION:

The Part 15 radio device operates on a non-interference basis with other devices operating at this frequency when using the listed antenna.

Collocation Statement:

This device must not be collocated with any other antenna or transmitters.

Radio Frequency Interference Requirements - Canada

This device complies with RSS 210 of Industry Canada. Operation is subject to the following two conditions: (1) this device may not cause harmful interference and (2) this device must accept any interference received, including interference that may cause undesired operation.

This Class A digital apparatus meets the requirements of the Canadian Interference-Causing Equipment Regulations.

Cet appareil numérique de la Classe A respecte toutes les exigences du Règlement sur le Matériel Brouilleur du Canada.

Trademarks

Monarch® is a registered trademark of Paxar Americas, Inc.

9855 is a trademark of Paxar Americas, Inc.

Paxar® is a trademark of Paxar Corporation.

Paxar Americas, Inc.
170 Monarch Lane
Miamisburg, OH 45342

Visit **www.paxar.com** for sales, service, supplies, information, and telephone numbers for our locations throughout the world.

TOLL FREE:

1-800-543-6650 (U.S.A.)

1-800-363-7525 (Canada)

This *Quick Reference* contains supply loading and general care and maintenance procedures. For more detailed information, the *Operator's Handbook* is on the optional *Tabletops Documentation CD-ROM* or can be downloaded from our Web site. Check the Web site for the latest release/addendum information.

Connecting the Cables

The power supply automatically switches between 115V or 230V. There are no operator settings required.

1. Plug the power cable into the socket. Plug the other end of the cable into a grounded electrical outlet.
2. Connect the communication cable into the appropriate port. Secure the cable with the connecting screws (serial) or spring clips (parallel).

If you are communicating with the host through the serial port, make sure the printer's communication values match those at the host. The factory default values are 9600 Baud, 8 bit data frame, 1 stop bit, no parity, and DTR flow control. Set the communication values on the printer to match those at the host.

The printer also has a USB (Universal Serial Bus) Version 1.1 communications port.

Drivers are available on our Web site for a variety of operating systems.

3. Turn on the printer. Press (I) to turn on and (O) to turn off the printer.

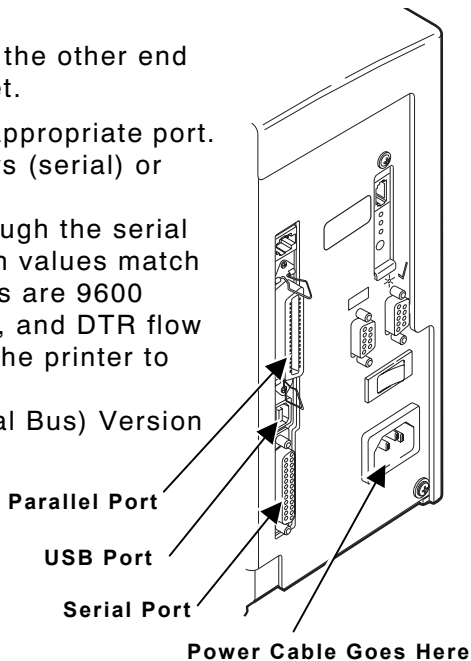

Using the Control Panel

The control panel has a two-line LCD display, 2 status lights, and five buttons. The control panel displays error codes/messages, and allows you to setup/configure the printer.

Power: The printer shows a steady green light when it is on.

Fault: The printer shows a steady amber light when it is out of labels or ribbon, or when you have a supply jam.

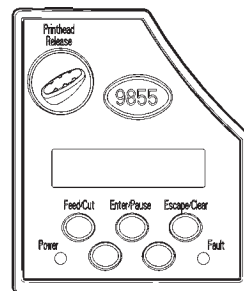

- Feed/Cut:** Prints a label in the on-demand mode, feeds a blank label if there is no print job, prints a label with error information that is useful to your System Administrator if an error is displayed, cuts the supply when pressed and held for two seconds if a knife is installed.
- Enter/Pause:** Pauses the current print job or resumes a paused print job. Selects the displayed menu item.
- Escape/Clear:** When an error is present, clears the error. When a job (batch) is printing, cancels the print job (batch). Enters the offline menu mode or returns the display to the next higher menu.
- ← Displays the previous menu item.
- Displays the next menu item.
- ← and → Prints a test label when you press the buttons at the same time. Hold for one second and release.

Loading Labels or Tags

1. Open the cover.
2. Unlock the printhead by turning the retaining latch.
3. Lift printhead assembly using the printhead tab until the assembly locks into place.

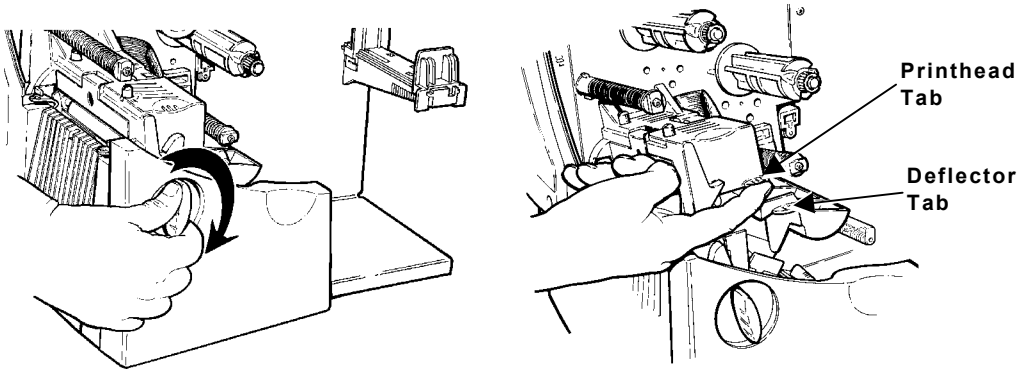

4. Place the roll of supply on the supply holder. For labels, the supply unrolls from the top or the bottom. For tags, make sure the supply unrolls from the bottom, because tag rolls are wound face in. **Do not pick up the printer by the supply holder.**

5. Adjust the supply holder guides so the sides barely touch the roll. Make sure the supply roll turns freely. **If you are using fan-fold supplies**, place the supply stack behind the printer, label side facing up.

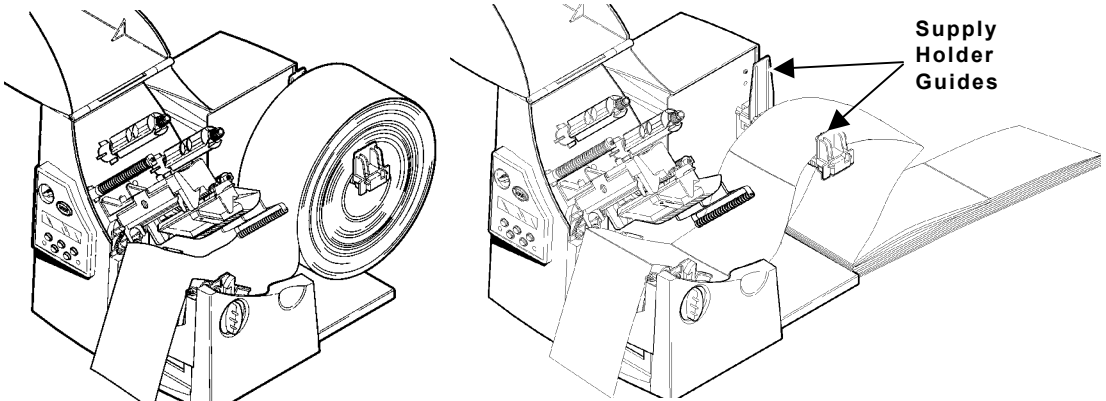

6. Push down on the supply lever to unlock the supply guides.
7. Lay the label strip across the supply guide so that a few inches extend past the front of the printer. Tuck the supply under the nibs and in between the die cut sensor.

For fan-fold supplies, lay the label strip over the supply holder and across the supply guide so that a few inches extend past the front of the printer. Tuck the supply under the nibs and in between the die cut sensor.

For tag supplies using the optional knife, feed the supply through the knife. Make sure at least 0.5 inches of supply is past the knife.

8. Adjust the supply guides so they touch the supply. Push up on the supply lever to lock the supply guides into place.

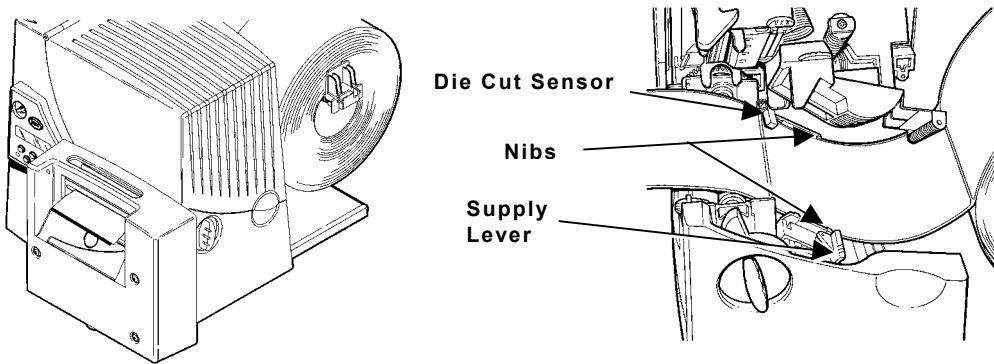

9. Hold the printhead assembly by the printhead tab while pressing down on the printhead release.

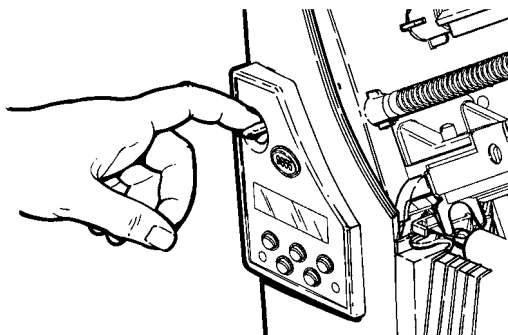

10. Close the printhead by pressing down on the thumb well until you hear it click into place.

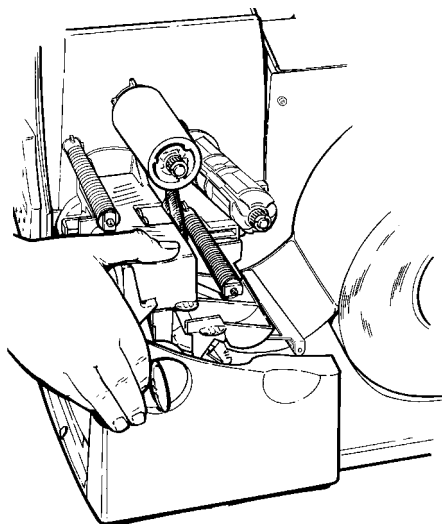

11. Close the cover.
12. Press **Feed/Cut** to position the supply under the printhead.

Loading Labels for the Optional Peel Mode

Peel mode must be purchased separately. In peel mode, the printer separates the backing paper from the label. The next label is not printed until the completed one is removed from the printer. Make sure the printer is configured for on-demand mode and the correct supply type. The minimum feed length is 1.5 inches for peel mode. Hold the leading edge of peeled labels when printing on stock longer than six inches. You must use non-perforated supplies for peel mode. Follow the steps for loading supplies from the previous section. Then, follow these steps after you close the printhead.

1. Remove the labels from the first 10 inches of the backing paper.
2. Press down on the exit cover tabs to open the exit cover on the front of the printer.

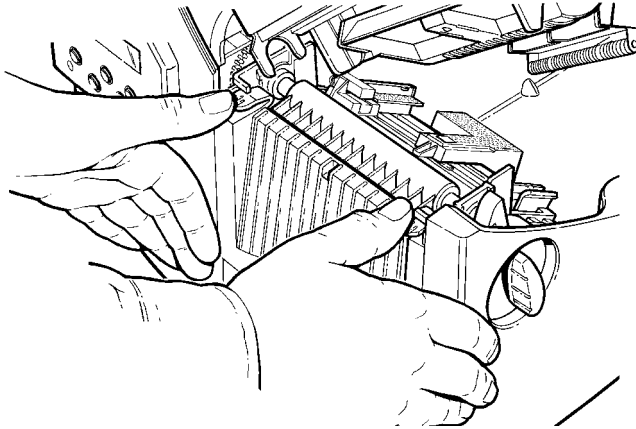

3. Feed the backing paper over the peel bar.

4. Feed the backing paper through the lower opening of the exit cover. Close the exit cover. Pull down on the backing paper to remove any slack.

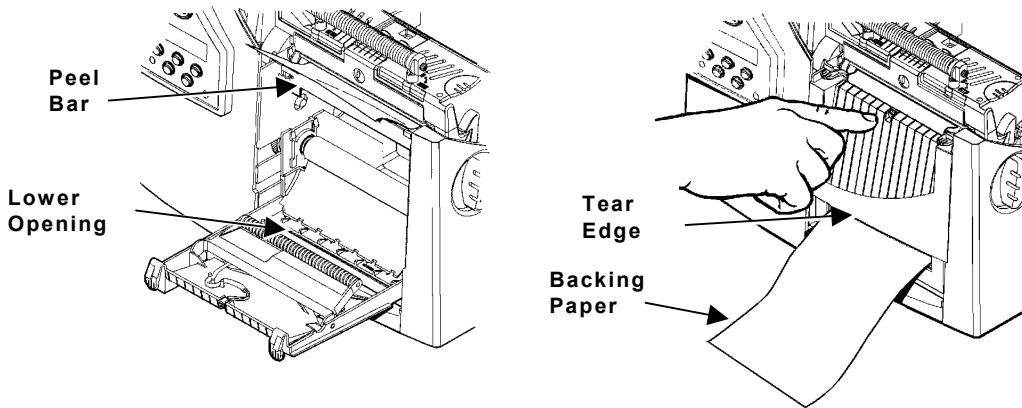

When removing the backing paper, pull up across the saw-toothed tear edge. Make sure the backing paper tears at the edge.

5. Close the printer's cover.
6. Press **Feed/Cut** to position the supply under the printhead.

To load and use linerless or string tag supplies, refer to the *Operator's Handbook*.

Adjusting the Wide/Narrow Knobs

You may need to adjust the two wide/narrow knobs according to the width of your supply. For supply that is more than two inches, adjust the knobs to the wide setting. For supply that is two inches or less, adjust the knobs to the narrow setting. For linerless supply, use the narrow setting (knobs are up). For string tag supplies, use the wide setting (knobs are down).

You must adjust both of the knobs to the same position.

If you experience ribbon smudging in cold, dry environments, adjust the wide/narrow knobs to the wide setting.

For wide supplies, push down and turn the wide/narrow knobs clockwise with a screwdriver.

For narrow supplies, turn the wide/narrow knobs counter-clockwise with a screwdriver until it pops back up.

The adjustment is shown in the wide position.

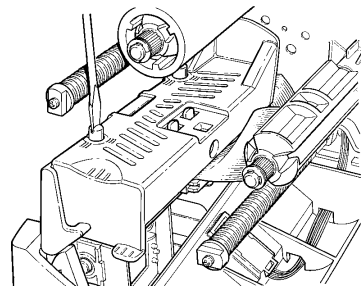

Loading Ribbon

1. Open the cover.
2. Unlock the printhead by turning the retaining latch.
3. Lift printhead assembly using the printhead tab until the assembly locks into place.
4. Push the deflector tab down.
5. Slide the extra ribbon core on the take-up reel as far as it will go with the "This End Out" writing facing out. Use your empty ribbon core as the take-up core. The take-up core only fits on the take-up reel one way.
6. Remove the new ribbon from the package. Do not wrinkle or crush the new ribbon.
7. Slide the ribbon onto the back reel as far as it will go. The ribbon roll only fits on the reel one way. Carefully unwind a few inches of ribbon from the bottom of the roll.
8. Carefully feed the ribbon under both ribbon rollers and printhead.
9. Align the ribbon and make sure it is straight and centered throughout the path.
10. Tape the ribbon to the take-up core. Do not tape the ribbon to the take-up reel.
11. Rotate the take-up core until the leader is past the printhead.
12. Remove any slack in the ribbon by turning the take-up reel clockwise.
13. Hold the printhead assembly by the printhead tab while pressing down on the printhead release.

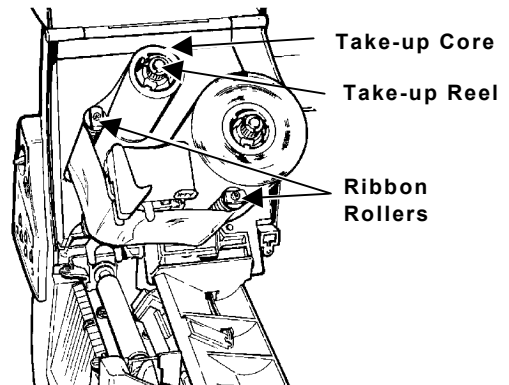
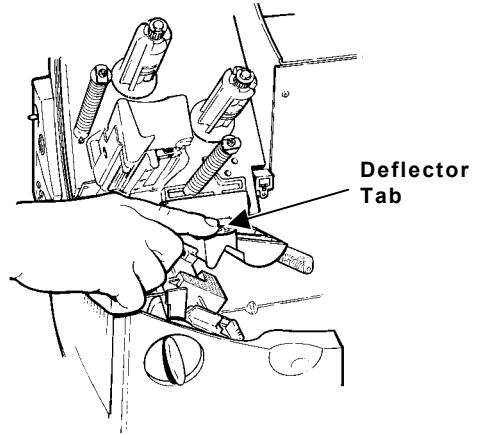

14. Close the printhead by pressing down on the thumb well until you hear it click into place. Close the cover.

Printing

Before you print, make sure the printer is connected and ready to receive data.

1. Turn on the printer. Your printer is ready to receive and print batches when you see

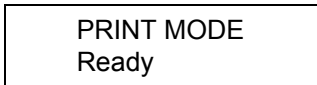

2. Download a format and a batch. Refer to the optional *Packet Reference Manual* for information on downloading print jobs.
3. The printer prints a strip of labels.
4. Remove the printed labels. If the printer will be unused for extended periods of time, we recommend leaving the printhead unlatched.

Universal Serial Bus (USB) Information

This printer has a USB Version 1.1 communications port. Drivers are available for a variety of operating systems. These drivers provide a Virtual Communications Port (VCP), which looks like a normal serial port (for example, COM1-4). After installing the drivers, change the communications port to the one allocated by the VCP driver. For these drivers, go to our Web site (www.servisource1.com).

Clearing Jams

When you are printing and a jam occurs, the **Fault** light on the printer's front panel blinks.

1. Turn off the printer and open the cover and printhead assembly.
2. If necessary, remove the label roll and ribbon.
3. Remove the jammed labels and reload the label roll.
4. Close the printhead assembly and turn on the printer.
5. Press **Feed/Cut** to position the supply under the printhead.

Cleaning

CAUTION: Do not use sharp objects to clean the printhead or touch the printhead. This may damage the printhead and require a service charge.

NOTE: You **must** clean the printhead as described below to maintain printhead life.

The rate and frequency at which you print determines how often you must clean the printer. You may need to clean the printhead, sensor, and platen roller:

- ◆ if there is any adhesive build-up in the supply path.
- ◆ after printing approximately 3 rolls of thermal transfer/thermal direct/linerless supplies or after each ribbon.
- ◆ daily if your printer is in an excessively dirty, hot, or humid environment.
- ◆ if you frequently receive supply error codes or when you see voids or streaking in the print as shown.

1. Turn off the printer and open the cover and printhead assembly.
2. Remove the label roll and ribbon (when cleaning the printhead).
3. Press down on the exit cover tabs to open the exit cover on the front of the printer.



Voids



Streaks

4. Clean the platen roller when you see significant adhesive build-up or a label is wrapped around the platen roller. Use a dry, soft-bristle brush, such as a toothbrush, to clean either the standard (black) or linerless (red/orange textured) platen roller.

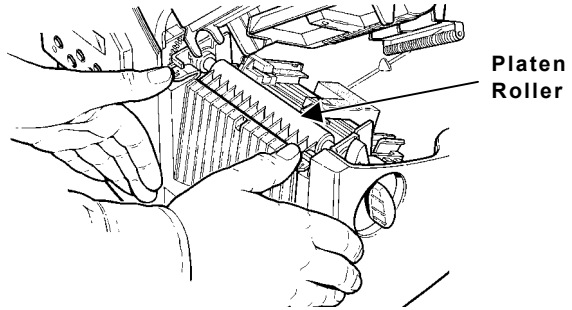

If the brush does not remove all the adhesive

- ◆ use isopropyl alcohol ONLY on the standard (black) platen roller. Moisten a cotton swab with isopropyl alcohol and run the cotton swab across the platen roller. Turn the platen roller with your finger to make sure the platen roller is clean all the way around. After cleaning, feed several inches of supply through without printing to remove any remaining isopropyl alcohol.
- ◆ call Service to clean the linerless (red/orange textured) platen roller.

NOTE: DO NOT use alcohol or solvents on linerless (red/orange textured) platen rollers.

5. Rub the cotton swab moistened with isopropyl alcohol across the peel bar and remove any build-up.
6. Moisten another cotton swab with isopropyl alcohol. Rub the cotton swab across the printhead and remove any build-up. You may need to use a printhead CLEAN-STRIP if the printhead is extremely dirty or you see streaks on the supply.

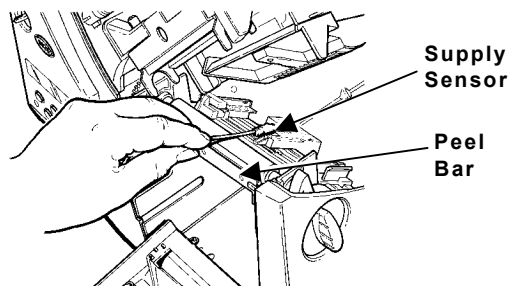
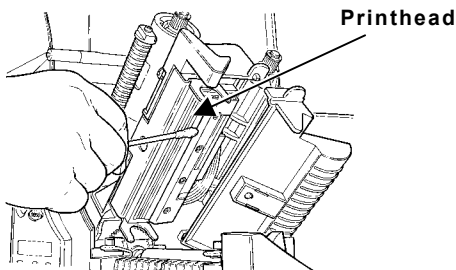

7. Rub the cotton swab across the supply sensor and die cut sensor and remove any build-up.
8. Clean the build-up in the supply path.

9. Let the printer dry before you reload supplies.
10. Close the exit cover by pushing firmly on it. Both latches will click into place.
11. Close the cover and printhead assembly.
12. Turn on the printer and press **Feed/Cut** to position the supply under the printhead. Resend your format, batch, and check digit packets.

Troubleshooting

This section provides solutions to minor printing problems.

Problem	Action
Error message appears during startup	Turn off the printer, wait fifteen seconds and then turn on the printer. Call Technical Support if the error message reappears.
Does not print.	Check supply. Check ribbon. Send a corrected format and batch packet.
Does not feed.	Set wide/narrow knobs correctly.
Partially printed data.	Clean the printhead. Send a corrected format packet.
Printing shadows or smears.	Clean the printhead. Change supply. Check ribbon.
Light Printing.	Change supply. Adjust the print contrast. Check wide/narrow knobs. Check ribbon.
Heavy Printing.	Clean the printhead. Change supply. Adjust the print contrast. Check wide/narrow knobs. Check ribbon.

Problem	Action
Voids in printing.	Clean the printhead. Change supply type. Check ribbon.
Serial bar codes do not scan.	Leave printhead unlatched when not in use. Use a print speed of 2.5 IPS. Adjust the print contrast.
Backing paper is wrapped around platen or peel roller.	Carefully remove the backing paper. Make sure the backing paper tears at the saw-toothed tear edge when using backfeed and peel mode.
Blank labels print or 750 series errors.	Clean supply sensors.

Common Errors

Error Description/Action

- 002** Name must be **1** to **8** characters inside quotes.
- 005** Supply width is invalid.
- 018** Code page selection defined in the field is invalid.
- 025** Data length is too long.
- 101** Format referenced by batch not in memory.
- 400** Invalid character following {.
- 403** Field separator was not found.
- 409** Printer memory is full. Delete unnecessary formats or graphics from memory.
- 410** Parity mismatch.
- 411** Framing error (baud rate mismatch).
- 412** Flow control mismatch.
- 413** Online receive buffer is full. Check for a flow control problem.
- 611** Font, bar code, or density in the batch does not fit the format.
- 612** The data in this line of the batch is either missing or does not match the format.
- 613** Reference point off supply.

- 614** Portion of field off supply or there may be an invalid character in the packet.
- 703** The printer sensed a calibration of different-sized black marks. Make sure the correct supply type is loaded.
- 704** Printer has not sensed a supply mark when expected or is out of supplies. Press **Escape/Clear** and try to continue printing. Change supply.
- 751** Printer did not sense a black mark when expected. Press **Escape/Clear** and try to continue printing. Change supply.
- 752** Printer sensed a mark in the wrong place.
- 753** Printer sensed a mark that is too long.
- 754** Check for a ribbon jam or remove any slack in the ribbon by turning the take-up reel clockwise. Load a new ribbon.
- 755** Printhead is open. Close the printhead.
- 756** Load supplies.
- 757** Load supplies (supply length mismatch). Press **Feed/Cut**.
- 758** Either the supply is not seen, the on-demand sensor is broken, or a label was removed too quickly. Check for a label jam or reload supplies.
- 763** Waiting to dispense label. Press **Feed/Cut**.
- 765** The printhead has less than 8 bad dots and can shift bar code fields to avoid bad dots. Press **Escape/Clear** to continue printing.
- 768** Printhead has more than 8 bad dots within the format area or is not connected. Connect printhead.

Printer Specifications

Height:	12.5 inches (318 mm)
Width:	12 inches (305 mm)
Depth:	13 inches (330 mm)
Weight:	21 lb. (9.5 kg)
Shipping Weight:	25 lb. (11.4 kg)
Power Source:	90-264 VAC with autoselect 50/60Hz
Printhead:	Thermal at 4 inches (1012 mm) wide 203 dpi (8.0 dots per mm) Optional 300 dpi (11.8 dots per mm)

Speed: 2.5, 4.0, 6.0, 8.0, and 10.0 ips (inches per second) (2.5 is default for serial bar codes). 12.0 ips printing is an option that must be purchased separately.

Maximum Print Area: 4.0 inches x 16.0 inches (102 mm x 406 mm) with 203 dpi
4.0 inches x 13.0 inches (102 mm x 330 mm) with 300 dpi

Operating Temperature

Direct: 40° F to 104° F (4°C to 40°C)

Transfer: 40°F to 95°F (4°C to 35°C)

Storage: 15°F to 120°F (-9°C to 49°C)

Humidity: 5% to 90% non-condensing

Supply Specifications

Linerless and string tag supplies are also available. For more detailed information, the *Operator's Handbook* is on the optional *Tabletops Documentation CD-ROM* or can be downloaded from our Web site.

Supply Types: Thermal Transfer or Direct

Supply Widths: 0.75 inches (19 mm) minimum
4.25 inches (108 mm) maximum

Supply Lengths: 0.32 inches (8 mm) minimum
17.5 inches (445 mm) maximum

Supply Thickness: 7 to 12 mils

Ribbon Specifications

Ribbon Widths: Use with Max. Supply Width

1.5 inches (38 mm) 1.3 inches (33 mm)

1.8 inches (46 mm) 1.5 inches (38 mm)

2.3 inches (58 mm) 2.0 inches (51 mm)

3.3 inches (84 mm) 3.0 inches (76 mm)

4.3 inches (110 mm) 4.0 inches (102 mm)

RF Specifications

The radio operates at the 915 Ghz range, frequency hopping.