



Engineering and Testing for EMC and Safety Compliance

CERTIFICATION APPLICATION REPORT  
FCC PART 15.247 CERTIFICATION

<b>Test Lab:</b> Rhein Tech Laboratories, Inc. Phone: 703-689-0368 360 Herndon Parkway Fax: 703-689-2056 Suite 1400 Web Site: <a href="http://www.rheintech.com">www.rheintech.com</a> Herndon, VA 20170 E-Mail: ATCBINFO@rheintech.com		<b>Applicant:</b> Paxar Americas, Inc. Phone: 937-865-2123 x2020 170 Monarch Lane Fax: 937-865-2048 Miamisburg, OH 45342 Email: jim.bacher@paxar.com Contact: James A. Bacher	
<b>FCC ID:</b>	GU6RFIDALN1	<b>GRANTEE FRN NUMBER:</b>	0003583150
<b>PLAT FORM:</b>	N/A	<b>RTL WORK ORDER NUMBER:</b>	2004117
<b>MODEL(S):</b>	Alien ALR-9932-A	<b>RTL QUOTE NUMBER:</b>	QRTL04-281
<b>DATE OF TEST REPORT:</b>	August 13, 2004		
<b>American National Standard Institute:</b>	ANSI C63.4: Methods of Measurement of Radio-Noise Emissions from Low-Voltage Electrical and Electronic Equipment in the Range of 9 kHz to 40 GHz		
<b>FCC Classification:</b>	DSS – Part 15 Spread Spectrum Transmitter Frequency Hopping		
<b>FCC Rule Part(s):</b>	Part 15.247: Operation within the bands 920-928 MHz, 2400-2483.5 MHz and 5725-5850 MHz Frequency Hopping System		
<b>Industry Canada Standard:</b>	RSS-210: Low Power License-Exempt Radio Communication Devices (All Frequency Bands)		
<b>Digital Interface Information</b>	Digital Interface was found to be compliant		
<b>Receiver Information</b>	Receiver was found to be compliant		
<b>Frequency Range (MHz)</b>	<b>Output Power* (W)</b>	<b>Frequency Tolerance</b>	<b>Emission Designator</b>
902.8-927.6	0.920	N/A	N/A

\* output power is maximum peak conducted

I, the undersigned, hereby declare that the equipment tested and referenced in this report conforms to the identified standard(s) as described in this test report.

Furthermore, there was no deviation from, additions to, or exclusions from the FCC Part 2, FCC Part 15, Industry Canada RSS-210, ANSI C63.4, ANSI/TIA/EIA603, and ANSI/TIA/EIA 603-1.

Signature: 

Date: August 13, 2004

Typed/Printed Name: Desmond A. Fraser

Position: President

*This report may not be reproduced, except in full, without written approval from Rhein Tech Laboratories, Inc.*

TABLE OF CONTENTS

<b>1</b>	<b>GENERAL INFORMATION .....</b>	<b>5</b>
1.1	SCOPE .....	5
1.2	TEST FACILITY .....	5
1.3	RELATED SUBMITTAL(S)/GRANT(S).....	5
1.4	MODIFICATIONS .....	5
<b>2</b>	<b>TEST INFORMATION.....</b>	<b>6</b>
2.1	TEST JUSTIFICATION .....	6
2.2	EXERCISING THE EUT.....	6
2.3	TEST RESULT SUMMARY .....	6
2.4	TEST SYSTEM DETAILS .....	7
2.5	CONFIGURATION OF TESTED SYSTEM.....	7
<b>3</b>	<b>COMPLIANCE WITH THE RESTRICTED BAND EDGE – FCC §15.205; IC RSS-210 §6.3 .....</b>	<b>8</b>
3.1	TEST PROCEDURE.....	8
3.2	BAND EDGE TEST EQUIPMENT.....	8
3.3	COMPLIANCE WITH THE RESTRICTED BAND EDGE TEST DATA .....	8
<b>4</b>	<b>CONDUCTED LIMITS – FCC §15.207; IC RSS-210 §6.6 AND 7.4.....</b>	<b>11</b>
4.1	CONDUCTED TEST DATA .....	11
<b>5</b>	<b>RADIATED EMISSION LIMITS; SPURIOUS AND HARMONICS – FCC §15.247; IC RSS-210 §6.3 .....</b>	<b>15</b>
5.1	RADIATED SPURIOUS EMISSION LIMITS TEST PROCEDURE.....	15
5.2	RADIATED SPURIOUS TEST EQUIPMENT .....	15
5.3	RADIATED EMISSIONS HARMONICS/SPURIOUS TEST DATA .....	16
<b>6</b>	<b>CARRIER FREQUENCY SEPARATION - §15.247 (A)(1).....</b>	<b>18</b>
<b>7</b>	<b>HOPPING CHARACTERISTICS – FCC §15.247 (A)(1)(I); IC RSS-210 §6.2.2(O) .....</b>	<b>19</b>
7.1	NUMBER OF HOPPING FREQUENCIES.....	19
7.2	20 DB BANDWIDTH TEST PROCEDURE – FCC §15.247 (A)(1)(I); IC RSS-210 §5.9.1.....	20
7.3	AVERAGE TIME OF OCCUPANCY .....	24
<b>8</b>	<b>PEAK OUTPUT POWER - FCC §15.247(B)(2); IC RSS-210 §6.2.2(O)(B).....</b>	<b>26</b>
8.1	POWER OUTPUT TEST PROCEDURE .....	26
8.2	POWER OUTPUT TEST EQUIPMENT .....	26
8.3	POWER OUTPUT TEST DATA .....	26
<b>9</b>	<b>ANTENNA CONDUCTED SPURIOUS EMISSIONS - §15.247(C); IC RSS-210 §6.2.2(O)(E1).....</b>	<b>27</b>
9.1	ANTENNA CONDUCTED SPURIOUS EMISSIONS TEST PROCEDURES .....	27
9.2	ANTENNA CONDUCTED SPURIOUS TEST EQUIPMENT .....	27
9.3	ANTENNA CONDUCTED SPURIOUS TEST DATA.....	28
9.4	ANTENNA CONDUCTED SPURIOUS EMISSIONS LOW CHANNEL.....	28
9.5	ANTENNA CONDUCTED SPURIOUS EMISSIONS MID CHANNEL.....	29
9.6	ANTENNA CONDUCTED SPURIOUS EMISSIONS HIGH CHANNEL.....	30
<b>10</b>	<b>CONCLUSION .....</b>	<b>31</b>

## FIGURE INDEX

FIGURE 1: WORST CASE CONFIGURATION OF SYSTEM UNDER TEST .....	7
---	---

## TABLE INDEX

TABLE 2-1:	TEST RESULT SUMMARY FOR FCC RULES AND REGULATIONS.....	6
TABLE 2-2:	EQUIPMENT UNDER TEST (EUT).....	7
TABLE 3-1:	BAND EDGE TEST EQUIPMENT .....	8
TABLE 4-1:	CONDUCTED TEST DATA; MODE RX, NEUTRAL SIDE (LINE 1) .....	11
TABLE 4-2:	CONDUCTED TEST DATA; MODE RX, HOT SIDE (LINE 2).....	11
TABLE 4-3:	CONDUCTED TEST DATA; MODE TX, 902.8 MHZ, NEUTRAL SIDE (LINE 1).....	12
TABLE 4-4:	CONDUCTED TEST DATA; MODE TX, 902.8 MHZ, HOT SIDE (LINE 2) .....	12
TABLE 4-5:	CONDUCTED TEST DATA; MODE TX, 915.2 MHZ, NEUTRAL SIDE (LINE 1).....	13
TABLE 4-6:	CONDUCTED TEST DATA; MODE TX, 915.2 MHZ, HOT SIDE (LINE 2) .....	13
TABLE 4-7:	CONDUCTED TEST DATA; MODE TX, 927.6 MHZ, NEUTRAL SIDE (LINE 1).....	14
TABLE 4-8:	CONDUCTED TEST DATA; MODE TX, 927.6 MHZ, HOT SIDE (LINE 2) .....	14
TABLE 5-1:	RADIATED SPURIOUS EMISSIONS TEST EQUIPMENT.....	15
TABLE 5-2:	RADIATED EMISSIONS HARMONICS/SPURIOUS (LOW CHANNEL; 902.8 MHZ) .....	16
TABLE 5-3:	RADIATED EMISSIONS HARMONICS/SPURIOUS (MID CHANNEL; 915.2 MHZ) .....	16
TABLE 5-4:	RADIATED EMISSIONS HARMONICS/SPURIOUS (HIGH CHANNEL; 927.6 MHZ).....	17
TABLE 7-1:	20 DB BANDWIDTH TEST EQUIPMENT .....	20
TABLE 7-2:	MODULATED BANDWIDTH TEST DATA .....	20
TABLE 8-1:	POWER OUTPUT TEST EQUIPMENT .....	26
TABLE 8-2:	POWER OUTPUT TEST DATA .....	26
TABLE 9-1:	ANTENNA CONDUCTED SPURIOUS TEST EQUIPMENT .....	27
TABLE 9-2:	ANTENNA CONDUCTED SPURIOUS EMISSIONS LOW CHANNEL .....	28
TABLE 9-3:	ANTENNA CONDUCTED SPURIOUS EMISSIONS MID CHANNEL .....	29
TABLE 9-4:	ANTENNA CONDUCTED SPURIOUS EMISSIONS HIGH CHANNEL .....	30

## PLOT INDEX

PLOT 3-1:	LOWER BAND EDGE: DELTA MEASUREMENT (902 MHZ).....	9
PLOT 3-2:	UPPER BAND EDGE: DELTA MEASUREMENT (928 MHZ) .....	10
PLOT 6-1:	CARRIER FREQUENCY SEPARATION.....	18
PLOT 7-1:	NUMBER OF HOPPING FREQUENCIES .....	19
PLOT 7-2:	20 DB BANDWIDTH LOW CHANNEL .....	21
PLOT 7-3:	20 DB BANDWIDTH MID CHANNEL.....	22
PLOT 7-4:	20 DB BANDWIDTH HIGH CHANNEL .....	23
PLOT 7-5:	TIME OF OCCUPANCY (DWELL TIME).....	24
PLOT 7-6:	TIME OF OCCUPANCY (DWELL TIME 10 SECOND SWEEP).....	25

## APPENDIX INDEX

---

APPENDIX A:	RF EXPOSURE COMPLIANCE .....	32
APPENDIX B:	ATTESTATION – DA 00-1407 MODULAR APPROVAL.....	33
APPENDIX C:	AGENCY AUTHORIZATION LETTER.....	34
APPENDIX D:	CONFIDENTIALITY REQUEST LETTER .....	35
APPENDIX E:	LABEL AND LABEL LOCATION .....	36
APPENDIX F:	PRODUCT DESCRIPTION .....	37
APPENDIX G:	SCHEMATICS .....	38
APPENDIX H:	BLOCK DIAGRAM.....	39
APPENDIX I:	MANUAL.....	40
APPENDIX J:	TEST PHOTOGRAPHS .....	41
APPENDIX K:	EXTERNAL PHOTOGRAPHS.....	47
APPENDIX L:	INTERNAL PHOTOGRAPHS.....	54

## PHOTOGRAPH INDEX

---

PHOTOGRAPH 1:	LABEL LOCATION .....	36
PHOTOGRAPH 2:	RADIATED EMISSIONS FRONT VIEW (3M).....	41
PHOTOGRAPH 3:	RADIATED EMISSIONS REAR VIEW (3M) .....	42
PHOTOGRAPH 4:	RADIATED EMISSIONS FRONT VIEW (10M).....	43
PHOTOGRAPH 5:	RADIATED EMISSIONS REAR VIEW (10M) .....	44
PHOTOGRAPH 6:	CONDUCTED EMISSIONS FRONT VIEW .....	45
PHOTOGRAPH 7:	CONDUCTED EMISSIONS REAR VIEW .....	46
PHOTOGRAPH 8:	RFID MODULE FRONT.....	47
PHOTOGRAPH 9:	RFID MODULE BACK.....	48
PHOTOGRAPH 10:	ANTENNA FRONT .....	49
PHOTOGRAPH 11:	ANTENNA BACK .....	50
PHOTOGRAPH 12:	ANTENNA WITH 9 DB ATTENUATOR .....	51
PHOTOGRAPH 13:	INLINE WITH ANTENNA SMA 9 DB ATTENUATOR .....	52
PHOTOGRAPH 14:	POWER SUPPLY .....	53
PHOTOGRAPH 15:	ALIEN RFID CARD SIDE 1 .....	54
PHOTOGRAPH 16:	ALIEN RFID CARD SIDE 2 .....	55

## **1 GENERAL INFORMATION**

### **1.1 SCOPE**

FCC Rules Part 15.247: Frequency Hopping, Direct Spread Spectrum and Hybrid Systems that are in operation within the bands of 902-928 MHz, 2400-2483.5 MHz and 5725-5850 MHz.

IC RSS-210 Section 6.2.2(o): Frequency Hopping, Direct Spread Spectrum and Hybrid Systems that are in operation within the bands of 902-928 MHz, 2400-2483.5 MHz and 5725-5850 MHz.

A direct sequence (DS) system is a spread spectrum (SS) system in which the carrier has been modulated by a high speed spreading code and an information data stream. The high-speed code sequence dominates the “modulating function” and is the direct cause of the wide spreading of the transmitted signal.

### **1.2 TEST FACILITY**

The open area test site and conducted measurement facility used to collect the radiated data is located at 360 Herndon Parkway, Suite 1400, Herndon, Virginia 20170. This site has been fully described in a report and approved by the Federal Communications Commission to perform AC line conducted and radiated emissions testing (ANSI C63.4 2001).

### **1.3 RELATED SUBMITTAL(S)/GRANT(S)**

This is an original application for **LIMITED MODULAR APPROVAL** certification for Paxar Americas, Inc., Model: Alien ALR-9932-A, FCC ID: GU6RFIDALN1. The IF and LO’s were investigated and tested.

### **1.4 MODIFICATIONS**

No modifications were made to the device to achieve the results listed in this report.

## 2 TEST INFORMATION

### 2.1 TEST JUSTIFICATION

The EUT was tested in all three orthogonal planes in order to determine worst-case emissions. Channels 902.8 MHz, 915.2 MHz, and 927.6 MHz were tested and investigated from 9 kHz to 24 GHz. Data for all three channels is presented in this report.

The EUT contains a dipole antenna which is to be mounted at the printer roller to program labels. The antenna transmits, receives, and is connected to the RFID internal antenna port.

### 2.2 EXERCISING THE EUT

The EUT was provided with software to stop hopping for transmit at one frequency during testing. The carrier was also checked to verify that information was being transmitted. There were no deviations from the test standard(s) and/or methods.

### 2.3 TEST RESULT SUMMARY

**TABLE 2-1: TEST RESULT SUMMARY FOR FCC RULES AND REGULATIONS**

STANDARD	TEST	PASS/FAIL OR N/A
FCC 15.205	Compliance with the Restricted Band Edge	Pass
FCC 15.207	Conducted Emissions	Pass
FCC 15.209	Radiated Emissions	Pass
FCC 15.247(a)(1)	Occupied Bandwidth	Pass
FCC 15.247(b)(2)	Power Output	Pass
FCC 15.247(c)	Antenna Conducted Spurious Emissions	Pass
FCC 15.247(a)(1)(i)	Hopping characteristics	Pass

## 2.4 TEST SYSTEM DETAILS

The RFID module was received March 8, 2004; the antenna was received July 23, 2004. The FCC Identifiers for all equipment, plus descriptions of all cables used in the tested system, are identified in Table 2-2.

**TABLE 2-2: EQUIPMENT UNDER TEST (EUT)**

PART	MANUFACTURER	MODEL	SERIAL NUMBER	FCC ID	CABLE DESCRIPTION	RTL BAR CODE
RFID Module	Alien Technology, Inc.	ALR-9932-A	ALR-9932-A-04-0001	GU6WJSX2000	0.35m unshielded I/O; 2.1m unshielded DC power	16078
Antenna with 9 dB Attenuator	Paxar/MCL	BW-S9W2	0311	N/A	0.4m shielded	16062
Power Supply	CUI, Inc.	EPA-201DA-06	DTS060330UDC-P5-SZ	N/A	1.8m unshielded	16066

## 2.5 CONFIGURATION OF TESTED SYSTEM

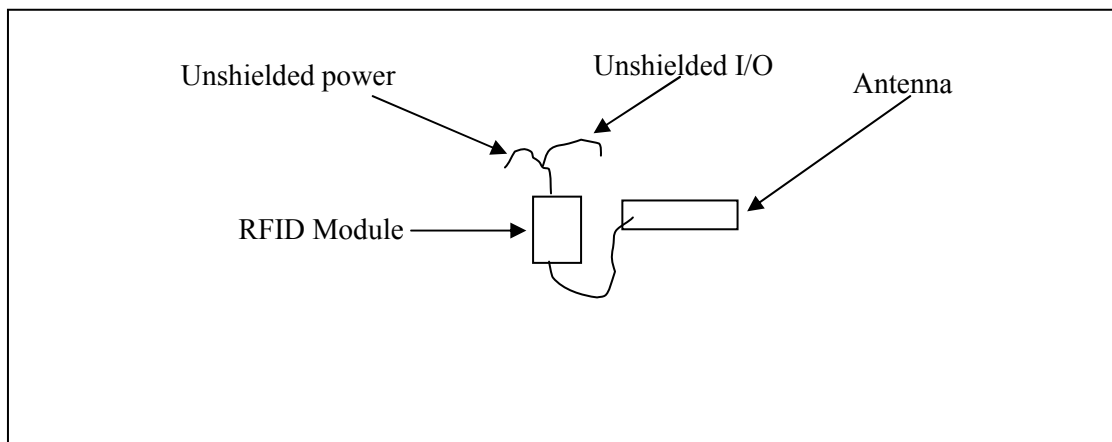

**FIGURE 1: WORST CASE CONFIGURATION OF SYSTEM UNDER TEST**

### 3 COMPLIANCE WITH THE RESTRICTED BAND EDGE – FCC §15.205; IC RSS-210 §6.3

#### 3.1 TEST PROCEDURE

Compliance with the band edges was performed using the FCC’s “Radiated Measurement at a Band Edge” guidance document.

#### 3.2 BAND EDGE TEST EQUIPMENT

**TABLE 3-1: BAND EDGE TEST EQUIPMENT**

RTL ASSET #	MANUFACTURER	MODEL	PART TYPE	SERIAL NUMBER	CALIBRATION DUE DATE
900931	Hewlett Packard	8566B	Spectrum Analyzer (100 Hz - 22 GHz)	3138A07771	6/23/05
901053	Schaffner Chase	CBL6112B	Bi-Log Antenna (20 MHz - 2 GHz)	2648	9/3/04
900811	Rhein Tech Labs	PR-1040	Amplifier	1003	2/13/05

#### 3.3 COMPLIANCE WITH THE RESTRICTED BAND EDGE TEST DATA

##### Calculation of Lower Band Edge

The level 100.6 dBuV/m is the Field Strength measurement, from which the delta measurement of 32.0 dB is subtracted (reference plots), which is equivalent to a level of 68.6 dBuV/m. This level has a margin of 12.0 dB below the limit of 80.6 dBuV/m (20 dBc)

Calculation:  $100.6 \text{ dBuV/m} - 32.0 \text{ dB} - 80.6 \text{ dBuV/m} = -12.0 \text{ dB}$

##### Calculation of Upper Band Edge

The level 101.2 dBuV/m is the Field Strength measurement, from which the delta measurement of 27.0 dB is subtracted (reference plots), which is equivalent to a level of 74.2 dBuV/m. This level has a margin of 7.0 dB below the limit of 81.2 dBuV/m (20 dBc)

Calculation:  $101.2 \text{ dBuV/m} - 27.0 \text{ dB} - 81.2 \text{ dBuV/m} = -7.0 \text{ dB}$



Frequency (MHz): 902.8  
Resolution Bandwidth (kHz): 30  
Video Bandwidth (kHz): 100  
Sweep Time (ms): 20

**PLOT 3-1: LOWER BAND EDGE: DELTA MEASUREMENT (902 MHz)**

Field strength (100 kHz RBW/300 kHz VBW) = 100.6 dBuV/m

Delta measurement: 32 dB

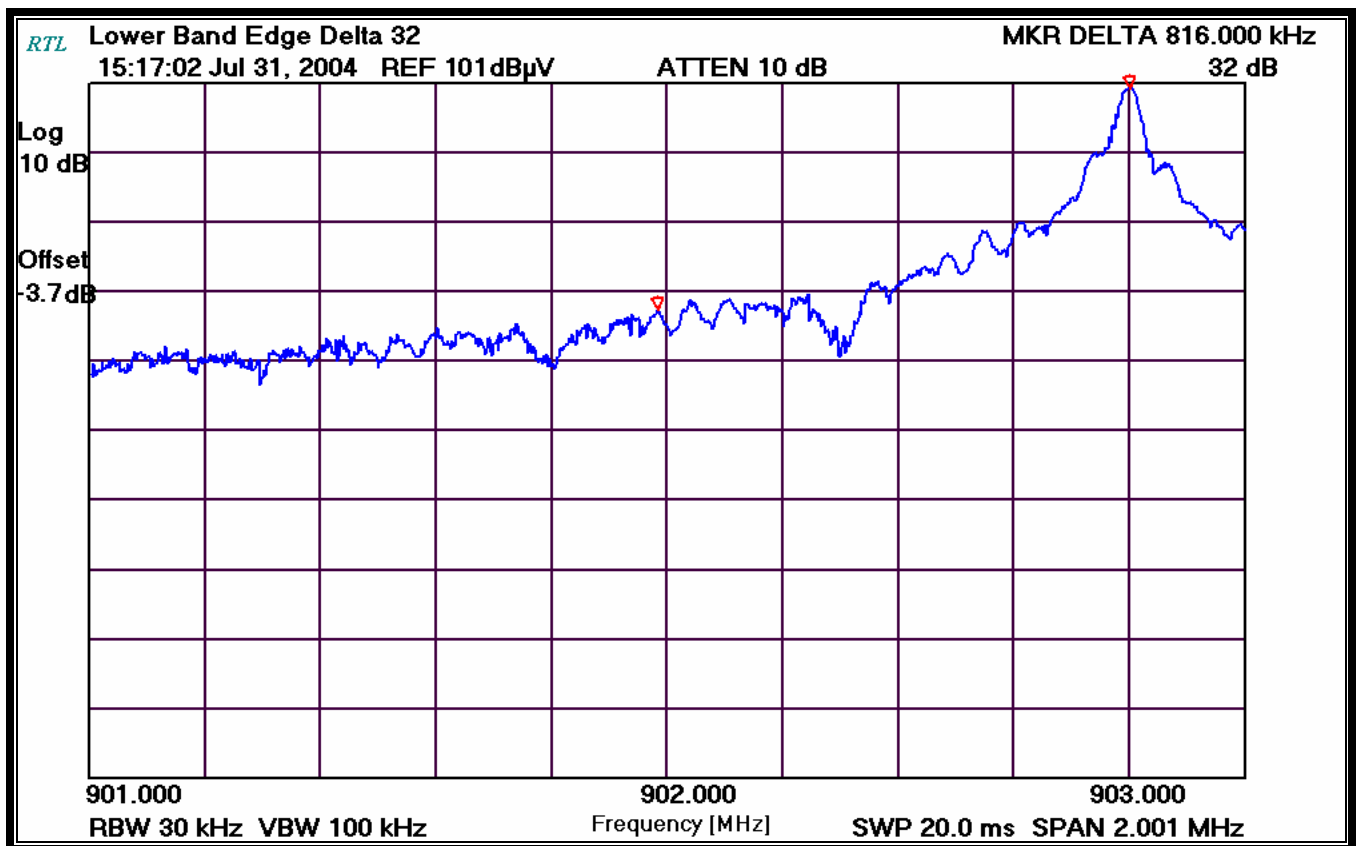

**TEST PERSONNEL:**

Daniel W. Baltzell  
EMC Test Engineer

Signature

July 31, 2004  
Date Of Test

Frequency (MHz): 927.6  
Resolution Bandwidth (kHz): 30  
Video Bandwidth (kHz): 100  
Sweep Time (ms): 20

**PLOT 3-2: UPPER BAND EDGE: DELTA MEASUREMENT (928 MHz)**

Field strength (100 kHz RBW/300 kHz VBW) = 101.2 dBuV/m

Delta measurement = 27.0 dB

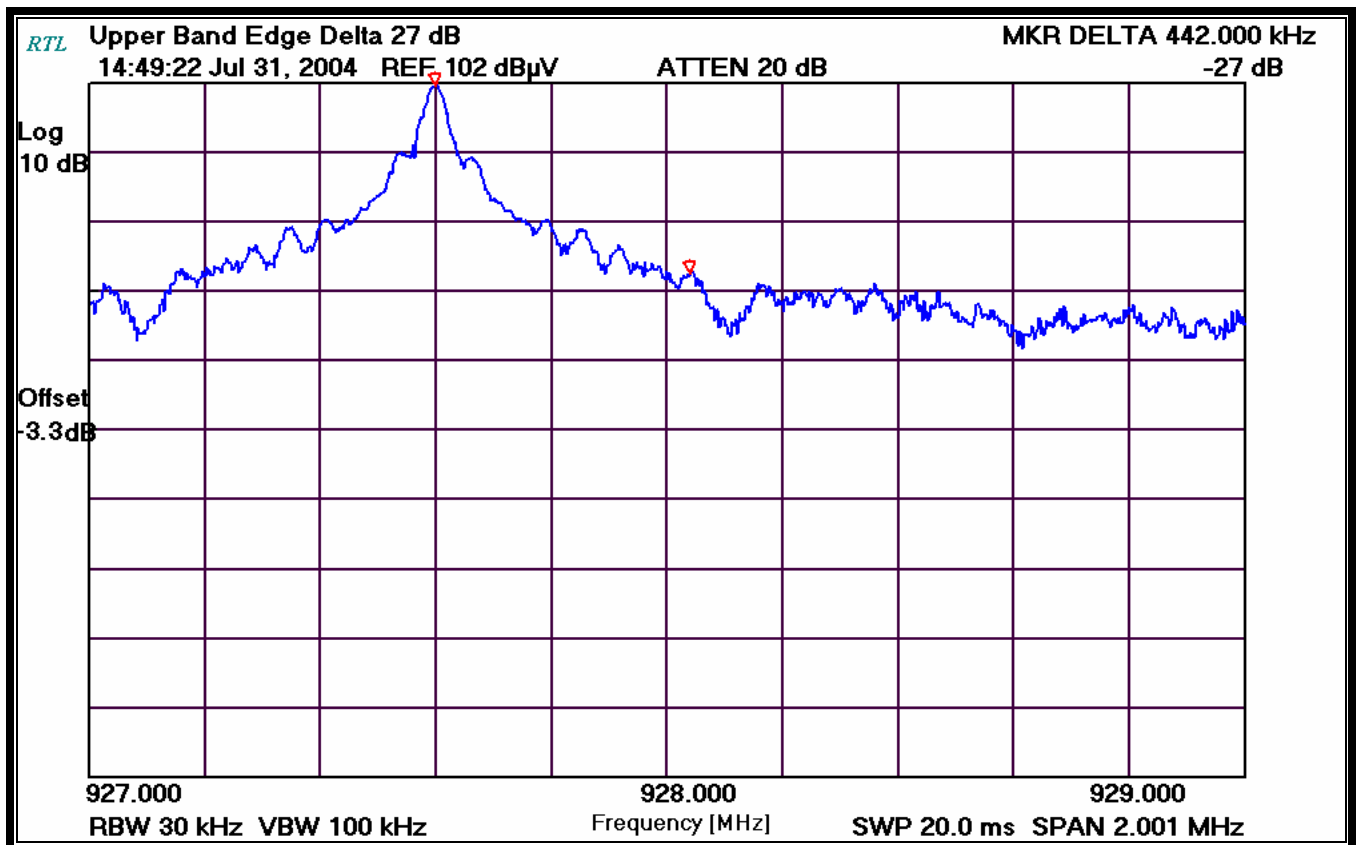

**TEST PERSONNEL:**

Daniel W. Baltzell  
EMC Test Engineer

Signature

July 31, 2004  
Date Of Test

#### 4 CONDUCTED LIMITS – FCC §15.207; IC RSS-210 §6.6 AND 7.4

##### 4.1 CONDUCTED TEST DATA

**TABLE 4-1: CONDUCTED TEST DATA; MODE RX, NEUTRAL SIDE (LINE 1)**

Temperature: 74°F Humidity: 43%										
Emission Frequency (MHz)	Test Detector	Analyzer Reading (dBuV)	Site Correction Factor (dB)	Emission Level (dBuV)	FCC QP Limit (dBuV)	FCC QP Margin (dBuV)	FCC AV Limit (dBuV)	FCC AV Margin (dBuV)	Pass/Fail	Comments
0.344	Pk	42.8	1.0	43.8	59.1	-15.3	49.1	-5.3	Pass	
0.426	Pk	42.5	0.9	43.4	57.3	-13.9	47.3	-3.9	Pass	
1.390	Pk	42.2	1.1	43.3	56.0	-12.7	46.0	-2.7	Pass	
2.710	Pk	37.8	1.5	39.3	56.0	-16.7	46.0	-6.7	Pass	
8.244	Qp	41.7	2.5	44.2	60.0	-15.8	50.0	-5.8	Pass	
8.244	Av	35.5	2.5	38.0	60.0	-22.0	50.0	-12.0	Pass	
26.680	Pk	37.3	4.3	41.6	60.0	-18.4	50.0	-8.4	Pass	

**TABLE 4-2: CONDUCTED TEST DATA; MODE RX, HOT SIDE (LINE 2)**

Temperature: 74°F Humidity: 43%										
Emission Frequency (MHz)	Test Detector	Analyzer Reading (dBuV)	Site Correction Factor (dB)	Emission Level (dBuV)	FCC QP Limit (dBuV)	FCC QP Margin (dBuV)	FCC AV Limit (dBuV)	FCC AV Margin (dBuV)	Pass/Fail	Comments
0.341	Pk	42.8	1.0	43.8	59.2	-15.4	49.2	-5.4	Pass	
0.426	Pk	42.1	0.9	43.0	57.3	-14.3	47.3	-4.3	Pass	
1.090	Pk	42.9	1.0	43.9	56.0	-12.1	46.0	-2.1	Pass	
2.710	Pk	40.1	1.5	41.6	56.0	-14.4	46.0	-4.4	Pass	
8.100	Qp	42.7	2.5	45.2	60.0	-14.8	50.0	-4.8	Pass	
8.100	Av	36.0	2.5	38.5	60.0	-21.5	50.0	-11.5	Pass	
24.030	Pk	35.9	4.2	40.1	60.0	-19.9	50.0	-9.9	Pass	
27.640	Pk	37.7	4.4	42.1	60.0	-17.9	50.0	-7.9	Pass	

**TABLE 4-3: CONDUCTED TEST DATA; MODE TX, 902.8 MHZ, NEUTRAL SIDE (LINE 1)**

Temperature: 74°F Humidity: 43%										
Emission Frequency (MHz)	Test Detector	Analyzer Reading (dBuV)	Site Correction Factor (dB)	Emission Level (dBuV)	FCC QP Limit (dBuV)	FCC QP Margin (dBuV)	FCC AV Limit (dBuV)	FCC AV Margin (dBuV)	Pass/Fail	Comments
0.167	Pk	47.5	1.9	49.4	65.1	-15.7	55.1	-5.7	Pass	
0.335	Pk	41.3	1.0	42.3	59.3	-17.0	49.3	-7.0	Pass	
0.845	Pk	38.7	0.9	39.6	56.0	-16.4	46.0	-6.4	Pass	
3.703	Qp	42.3	1.7	44.0	56.0	-12.0	46.0	-2.0	Pass	
3.708	Av	27.3	1.7	29.0	56.0	-27.0	46.0	-17.0	Pass	
8.250	Av	35.8	2.5	38.3	60.0	-21.7	50.0	-11.7	Pass	
8.250	Qp	42.3	2.5	44.8	60.0	-15.2	50.0	-5.2	Pass	
27.390	Pk	39.4	4.4	43.8	60.0	-16.2	50.0	-6.2	Pass	

**TABLE 4-4: CONDUCTED TEST DATA; MODE TX, 902.8 MHZ, HOT SIDE (LINE 2)**

Temperature: 74°F Humidity: 43%										
Emission Frequency (MHz)	Test Detector	Analyzer Reading (dBuV)	Site Correction Factor (dB)	Emission Level (dBuV)	FCC QP Limit (dBuV)	FCC QP Margin (dBuV)	FCC AV Limit (dBuV)	FCC AV Margin (dBuV)	Pass/Fail	Comments
0.167	Pk	46.7	1.9	48.6	65.1	-16.5	55.1	-6.5	Pass	
0.341	Pk	42.8	1.0	43.8	59.2	-15.4	49.2	-5.4	Pass	
0.847	Pk	41.0	0.8	41.8	56.0	-14.2	46.0	-4.2	Pass	
3.544	Qp	43.3	1.6	44.9	56.0	-11.1	46.0	-1.1	Pass	
3.547	Av	27.9	1.6	29.5	56.0	-26.5	46.0	-16.5	Pass	
7.890	Pk	46.0	2.5	48.5	60.0	-11.5	50.0	-1.5	Pass	
26.090	Pk	39.8	4.3	44.1	60.0	-15.9	50.0	-5.9	Pass	

**TABLE 4-5: CONDUCTED TEST DATA; MODE TX, 915.2 MHZ, NEUTRAL SIDE (LINE 1)**

Temperature: 74°F Humidity: 43%										
Emission Frequency (MHz)	Test Detector	Analyzer Reading (dBuV)	Site Correction Factor (dB)	Emission Level (dBuV)	FCC QP Limit (dBuV)	FCC QP Margin (dBuV)	FCC AV Limit (dBuV)	FCC AV Margin (dBuV)	Pass/Fail	Comments
0.168	Pk	48.7	1.9	50.6	65.1	-14.5	55.1	-4.5	Pass	
0.339	Pk	43.2	1.0	44.2	59.2	-15.0	49.2	-5.0	Pass	
0.499	Pk	36.1	0.9	37.0	56.0	-19.0	46.0	-9.0	Pass	
2.177	Qp	43.6	1.4	45.0	56.0	-11.0	46.0	-1.0	Pass	
2.186	Av	32.5	1.4	33.9	56.0	-22.1	46.0	-12.1	Pass	
8.390	Qp	41.6	2.5	44.1	60.0	-15.9	50.0	-5.9	Pass	
8.390	Av	37.0	2.5	39.5	60.0	-20.5	50.0	-10.5	Pass	
25.500	Pk	37.8	4.3	42.1	60.0	-17.9	50.0	-7.9	Pass	

**TABLE 4-6: CONDUCTED TEST DATA; MODE TX, 915.2 MHZ, HOT SIDE (LINE 2)**

Temperature: 74°F Humidity: 43%										
Emission Frequency (MHz)	Test Detector	Analyzer Reading (dBuV)	Site Correction Factor (dB)	Emission Level (dBuV)	FCC QP Limit (dBuV)	FCC QP Margin (dBuV)	FCC AV Limit (dBuV)	FCC AV Margin (dBuV)	Pass/Fail	Comments
0.165	Pk	47.9	1.9	49.8	65.2	-15.4	55.2	-5.4	Pass	
0.341	Pk	41.7	1.0	42.7	59.2	-16.5	49.2	-6.5	Pass	
0.839	Pk	37.5	0.8	38.3	56.0	-17.7	46.0	-7.7	Pass	
3.540	Qp	41.7	1.6	43.3	56.0	-12.7	46.0	-2.7	Pass	
3.540	Av	27.0	1.6	28.6	56.0	-27.4	46.0	-17.4	Pass	
8.390	Qp	41.5	2.5	44.0	60.0	-16.0	50.0	-6.0	Pass	
8.390	Av	35.8	2.5	38.3	60.0	-21.7	50.0	-11.7	Pass	
26.160	Pk	37.1	4.3	41.4	60.0	-18.6	50.0	-8.6	Pass	

**TABLE 4-7: CONDUCTED TEST DATA; MODE TX, 927.6 MHZ, NEUTRAL SIDE (LINE 1)**

Temperature: 74°F Humidity: 43%										
Emission Frequency (MHz)	Test Detector	Analyzer Reading (dBUV)	Site Correction Factor (dB)	Emission Level (dBUV)	FCC QP Limit (dBUV)	FCC QP Margin (dBUV)	FCC AV Limit (dBUV)	FCC AV Margin (dBUV)	Pass/Fail	Comments
0.163	Pk	50.8	1.9	52.7	65.3	-12.6	55.3	-2.6	Pass	
0.327	Pk	42.1	1.0	43.1	59.5	-16.4	49.5	-6.4	Pass	
0.497	Pk	35.7	0.9	36.6	56.0	-19.4	46.0	-9.4	Pass	
2.570	Pk	41.7	1.5	43.2	56.0	-12.8	46.0	-2.8	Pass	
3.670	Pk	44.2	1.7	45.9	56.0	-10.1	46.0	-0.1	Pass	
3.670	Av	35.9	1.7	37.6	56.0	-18.4	46.0	-8.4	Pass	
3.670	Qp	41.3	1.7	43.0	56.0	-13.0	46.0	-3.0	Pass	
8.244	Qp	42.0	2.5	44.5	60.0	-15.5	50.0	-5.5	Pass	
8.244	Av	35.9	2.5	38.4	60.0	-21.6	50.0	-11.6	Pass	
26.090	Pk	42.3	4.3	46.6	60.0	-13.4	50.0	-3.4	Pass	

**TABLE 4-8: CONDUCTED TEST DATA; MODE TX, 927.6 MHZ, HOT SIDE (LINE 2)**

Temperature: 74°F Humidity: 43%										
Emission Frequency (MHz)	Test Detector	Analyzer Reading (dBUV)	Site Correction Factor (dB)	Emission Level (dBUV)	FCC QP Limit (dBUV)	FCC QP Margin (dBUV)	FCC AV Limit (dBUV)	FCC AV Margin (dBUV)	Pass/Fail	Comments
0.168	Pk	48.9	1.9	50.8	65.1	-14.3	55.1	-4.3	Pass	
0.332	Pk	42.9	1.0	43.9	59.4	-15.5	49.4	-5.5	Pass	
0.498	Pk	36.7	0.9	37.6	56.0	-18.4	46.0	-8.4	Pass	
3.750	Pk	43.6	1.7	45.3	56.0	-10.7	46.0	-0.7	Pass	
3.750	Pk	43.6	1.7	45.3	56.0	-10.7	46.0	-0.7	Pass	
3.750	Av	-2.0	1.7	-0.3	56.0	-56.3	46.0	-46.3	Pass	
7.950	Qp	42.5	2.5	45.0	60.0	-15.0	50.0	-5.0	Pass	
7.950	Av	42.5	2.5	45.0	60.0	-15.0	50.0	-5.0	Pass	
24.030	Pk	37.0	4.2	41.2	60.0	-18.8	50.0	-8.8	Pass	

**TEST PERSONNEL:**

Daniel W. Baltzell  
 EMC Test Engineer



Signature

August 10, 2004  
 Date Of Test

## 5 RADIATED EMISSION LIMITS; SPURIOUS AND HARMONICS – FCC §15.247; IC RSS-210 §6.3

### 5.1 RADIATED SPURIOUS EMISSION LIMITS TEST PROCEDURE

Radiated Spurious Emissions applies to harmonics and spurious emissions that fall in the restricted and non-restricted bands. The restricted bands are listed in Part 15.205. The maximum permitted average field strength for the restricted band is listed in Part 15.209. The EUT was tested in the X-Y, X-Z and Y-Z orthogonal planes.

### 5.2 RADIATED SPURIOUS TEST EQUIPMENT

**TABLE 5-1: RADIATED SPURIOUS EMISSIONS TEST EQUIPMENT**

RTL ASSET #	MANUFACTURER	MODEL	PART TYPE	SERIAL NUMBER	CALIBRATION DUE DATE
900772	EMCO	3161-02	Horn Antenna (2 - 4 GHz)	9804-1044	5/20/07
900323	EMCO	3160-7	Horn Antennas (8.2 - 12.4 GHz)	9605-1054	5/20/07
900356	EMCO	3160-08	Horn Antennas (12.4 – 18 GHz)	9607-1044	5/20/07
900321	EMCO	3161-03	Horn Antenna (4.0 - 8.2 GHz)	9508-1020	5/20/07
901053	Schaffner & Chase	CBL6112B	Bilog Antenna (20 MHz - 2 GHz)	2648	9/3/04
900905	Rhein Tech Laboratories, Inc.	PR-1040	Pre Amplifier 40dB (10 MHz – 2 GHz)	1006	9/10/04
900325	EMCO	3160-9	Horn Antennas (18 - 26.5 GHz)	9605-1051	5/20/07
900814	Electro-Metrics	EM-6961 (RGA-60)	Double Ridged Guide Antenna (1 - 18 GHz)	2310	2/17/06
900889	Hewlett Packard	85685A	RF Preselector for HP 8566B or 8568B (20 Hz-2 GHz)	3146A01309	3/10/05
900905	Rhein Tech Labs	PR-1040	Amplifier	900905	3/5/05
900931	Hewlett Packard	8566B	Spectrum Analyzer (100 Hz - 22 GHz)	3138A07771	6/23/05
900930	Hewlett Packard	85662A	Spectrum Analyzer Display Section	3144A20839	6/23/05
900932	Hewlett Packard	8449B	Microwave Preamplifier, (1 - 26.5 GHz)	3008A00505	5/5/05
900969	Hewlett Packard	85650A	Quasi-Peak Adapter	2412A00414	6/23/05

### 5.3 RADIATED EMISSIONS HARMONICS/SPURIOUS TEST DATA

Operating Frequency (MHz): 902.8  
 Amplitude at 100kHz RBW (dBuV/m): 100.6  
 Limit (dBuV/m): 80.6

**TABLE 5-2: RADIATED EMISSIONS HARMONICS/SPURIOUS (LOW CHANNEL; 902.8 MHZ)**

Emission Frequency (MHz)	Analyzer Reading (Pk) (dBuV)	Analyzer Reading (Av) (dBuV)	Antenna Polarity (H/V)	Site Correction Factor (dB/m)	Emission Level (dBuV/m)	Limit (dBuV/m)	Margin (dB0)
1805.600	47.3	38.5	H	5.7	44.2	80.6	-39.8
2708.400	29.9	20.3	V	11.3	31.6	54.0	-22.4
3611.200	29.1	19.7	V	9.6	29.3	54.0	-24.7
4514.000	25.8	16.9	V	14.0	30.9	54.0	-23.1
5416.800	30.8	19.7	H	13.5	33.2	54.0	-20.8
6319.600	28.4	17.0	V	13.6	30.6	80.6	-50.0
7222.400	30.7	20.0	V	13.1	33.1	80.6	-47.5
8125.200	30.8	22.0	V	12.4	34.4	54.0	-19.6

PEAK: RES.=1 MHZ, VID= 1 MHZ; AVERAGE: RES.=1 MHZ, VID= 10HZ

Operating Frequency (MHz): 915.2  
 Amplitude at 100kHz RBW (dBuV/m): 101.2  
 Limit (dBuV/m): 81.2

**TABLE 5-3: RADIATED EMISSIONS HARMONICS/SPURIOUS (MID CHANNEL; 915.2 MHZ)**

Emission Frequency (MHz)	Analyzer Reading (Pk) (dBuV)	Analyzer Reading (Av) (dBuV)	Antenna Polarity (H/V)	Site Correction Factor (dB/m)	Emission Level (dBuV/m)	Limit (dBuV/m)	Margin (dB0)
1830.400	45.4	35.9	H	6.5	42.4	81.2	-38.8
2745.600	29.0	18.9	H	11.5	30.4	54.0	-23.6
3660.800	29.2	19.5	V	9.3	28.8	54.0	-25.2
4576.000	28.8	17.2	V	13.5	30.7	54.0	-23.3
5491.200	28.0	17.5	V	14.6	32.1	81.2	-49.1
6406.400	29.0	19.8	V	14.0	33.8	81.2	-47.4
7321.600	29.8	20.2	V	12.9	33.1	54.0	-20.9
8236.800	29.6	20.5	V	17.1	37.6	54.0	-16.4

PEAK: RES.=1 MHZ, VID= 1 MHZ; AVERAGE: RES.=1 MHZ, VID= 10HZ



**Operating Frequency (MHz):** 927.6  
**Amplitude at 100kHz RBW (dBuV/m):** 101.2  
**Limit (dBuV/m):** 81.2

**TABLE 5-4: RADIATED EMISSIONS HARMONICS/SPURIOUS (HIGH CHANNEL; 927.6 MHZ)**

Emission Frequency (MHz)	Analyzer Reading (Pk) (dBuV)	Analyzer Reading (Av) (dBuV)	Antenna Polarity (H/V)	Site Correction Factor (dB/m)	Emission Level (dBuV/m)	Limit (dBuV/m)	Margin (dB0)
1855.200	39.1	27.2	H	7.4	34.6	81.2	-46.6
2782.800	29.7	19.2	V	11.4	30.6	54.0	-23.4
3710.400	27.7	18.7	V	10.0	28.7	54.0	-25.3
4638.000	27.8	17.3	V	14.3	31.6	54.0	-22.4
5565.600	27.5	19.0	V	14.2	33.2	81.2	-48
8348.400	28.8	20.4	V	17.5	37.9	81.2	-69

PEAK: RES. =1 MHZ, VID= 1 MHZ; AVERAGE: RES. =1 MHZ, VID= 10HZ

**TEST PERSONNEL:**

Daniel W. Baltzell  
 EMC Test Engineer



Signature

July 31, 2004  
 Date Of Test

## 6 CARRIER FREQUENCY SEPARATION - §15.247 (A)(1)

Frequency Hopping systems shall have hopping channel carrier frequencies separated by a minimum of 25 kHz or the 20 dB bandwidth of the hopping channel, whichever is greater.

Measured frequency separation = 400 kHz

**PLOT 6-1: CARRIER FREQUENCY SEPARATION**

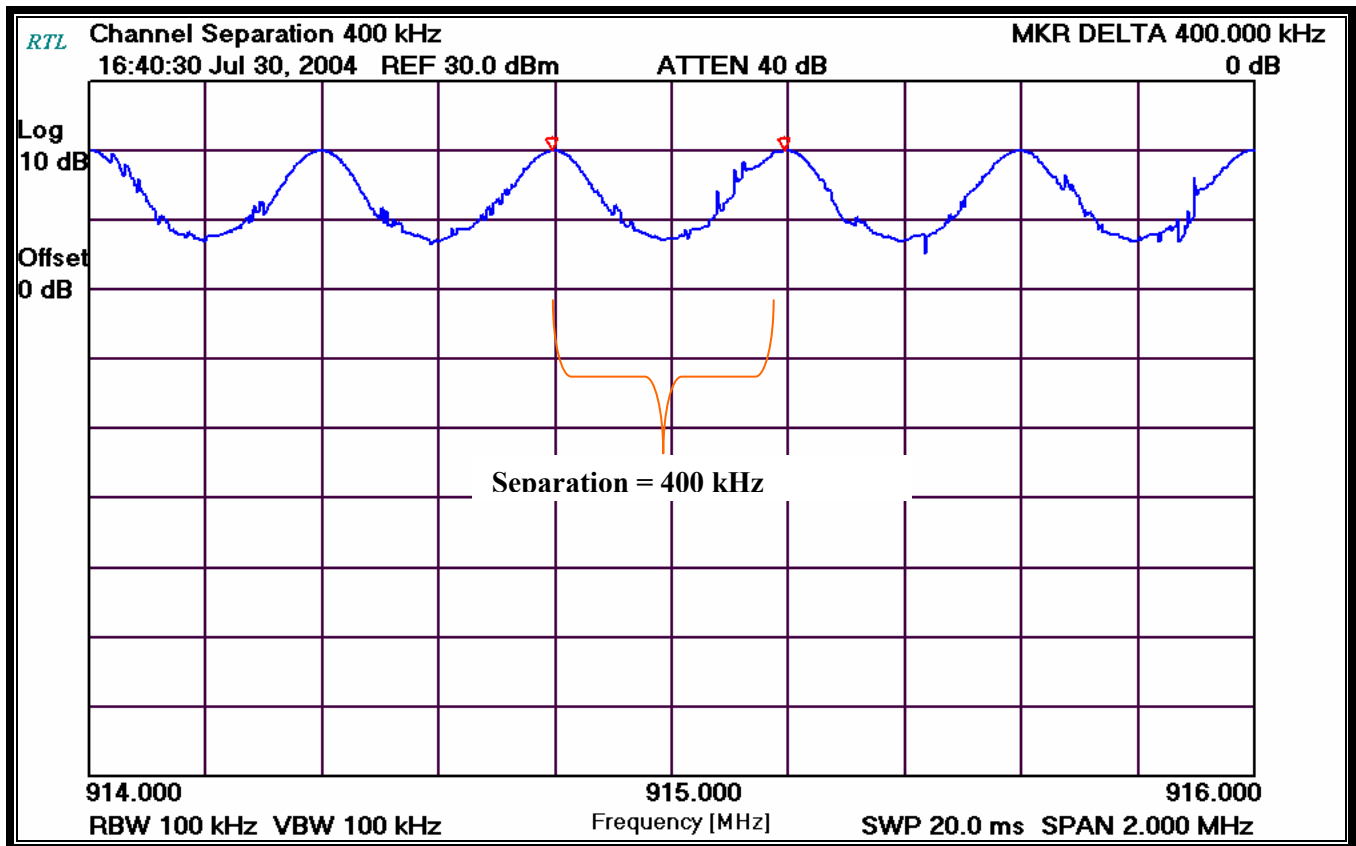

### TEST PERSONNEL:

Daniel W. Baltzell  
EMC Test Engineer

Signature

July 30, 2004  
Date Of Test

## 7 HOPPING CHARACTERISTICS – FCC §15.247 (A)(1)(I); IC RSS-210 §6.2.2(O)

### 7.1 NUMBER OF HOPPING FREQUENCIES

For frequency hopping systems operating in the 902-928 MHz band: if the 20 dB bandwidth of the hopping channel is less than 250 kHz, the system shall use at least 50 hopping frequencies and the average time of occupancy on any frequency shall not be greater than 0.4 seconds within a 20 second period; if the 20 dB bandwidth of the hopping channel is 250 kHz or greater, the system shall use at least 25 hopping frequencies and the average time of occupancy on any frequency shall not be greater than 0.4 seconds within a 10 second period. The maximum allowed 20 dB bandwidth of the hopping channel is 500 kHz.

Measured number of hopping frequencies = 63

**PLOT 7-1: NUMBER OF HOPPING FREQUENCIES**

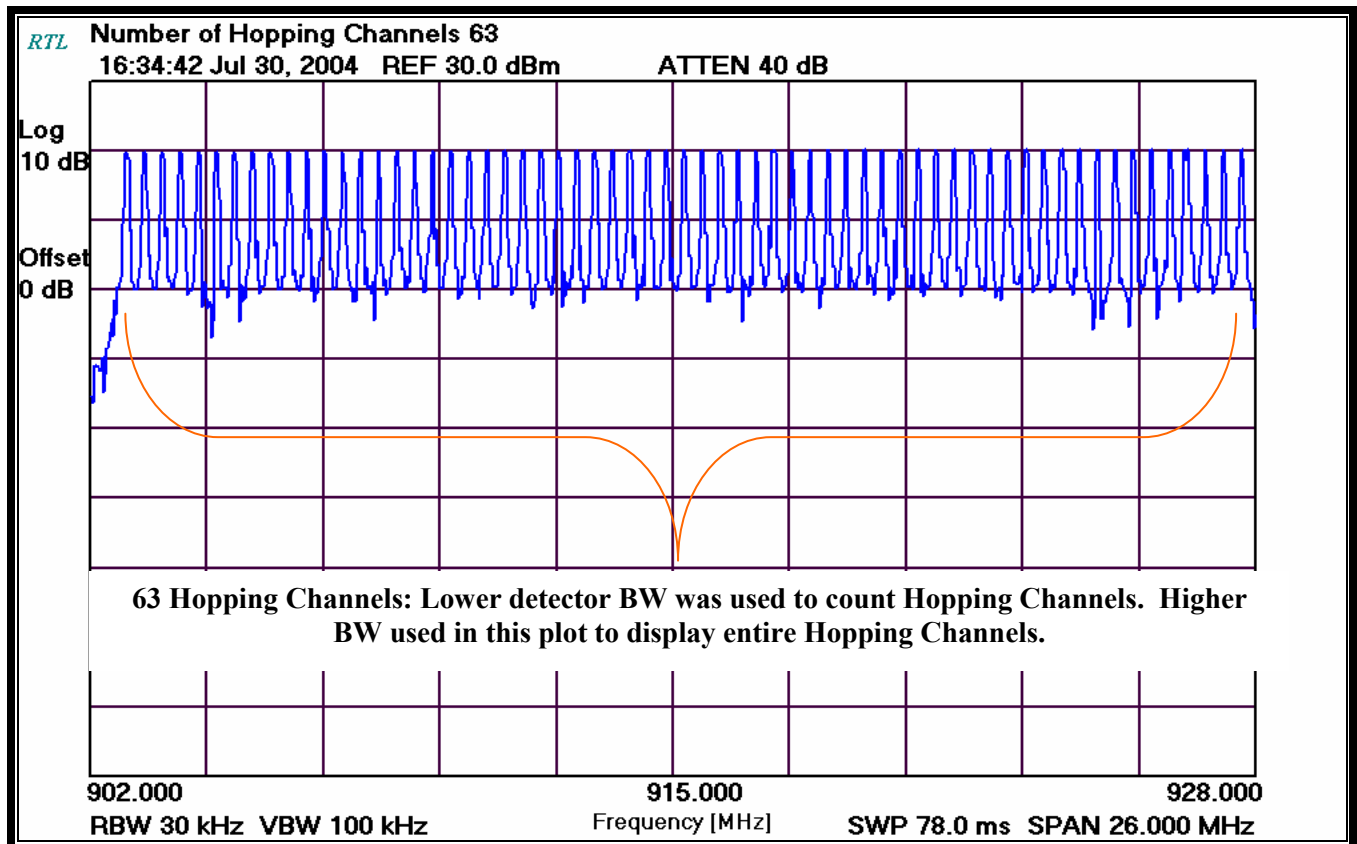

**TEST PERSONNEL:**

		
Daniel W. Baltzell	Signature	July 30, 2004
EMC Test Engineer		Date Of Test

**7.2 20 DB BANDWIDTH TEST PROCEDURE – FCC §15.247 (a)(1)(i); IC RSS-210 §5.9.1**

The minimum 20 dB bandwidths per RSS-210 were measured using a 50 Ω spectrum analyzer. The carrier was adjusted on the analyzer so that it was displayed entirely on the Spectrum Analyzer. The sweep time was set to auto and allowed through several sweeps with the max hold function used in peak detector mode. The resolution bandwidth was set to 30 kHz, and the video bandwidth set at 100 kHz. The minimum 20 dB bandwidths were measured using the spectrum analyzer delta marker set 20 dB down from the peak of the carrier. The table below contains the bandwidth measurement results.

**TABLE 7-1: 20 DB BANDWIDTH TEST EQUIPMENT**

RTL ASSET #	MANUFACTURER	MODEL	PART TYPE	SERIAL NUMBER	CALIBRATION DUE DATE
900931	Hewlett Packard	8566B	Spectrum Analyzer (100 Hz - 22 GHz)	3138A07771	6/23/05

**TABLE 7-2: MODULATED BANDWIDTH TEST DATA**

**Minimum 20 dB bandwidths**

Channel	20 dB Bandwidth (kHz)
Low; 902.8 MHz	395.0
Mid; 915.2 MHz	393.0
High; 927.6 MHz	394.0

**TEST PERSONNEL:**

Daniel W. Baltzell EMC Test Engineer	 Signature	July 31, 2004 Date Of Test
---	--	-------------------------------

### 20 dB Bandwidth Plots

Channel: Low  
Channel Frequency (MHz): 902.8  
Resolution Bandwidth (kHz): 30  
Video Bandwidth (kHz): 100  
Span (MHz): 1.0

PLOT 7-2: 20 DB BANDWIDTH LOW CHANNEL

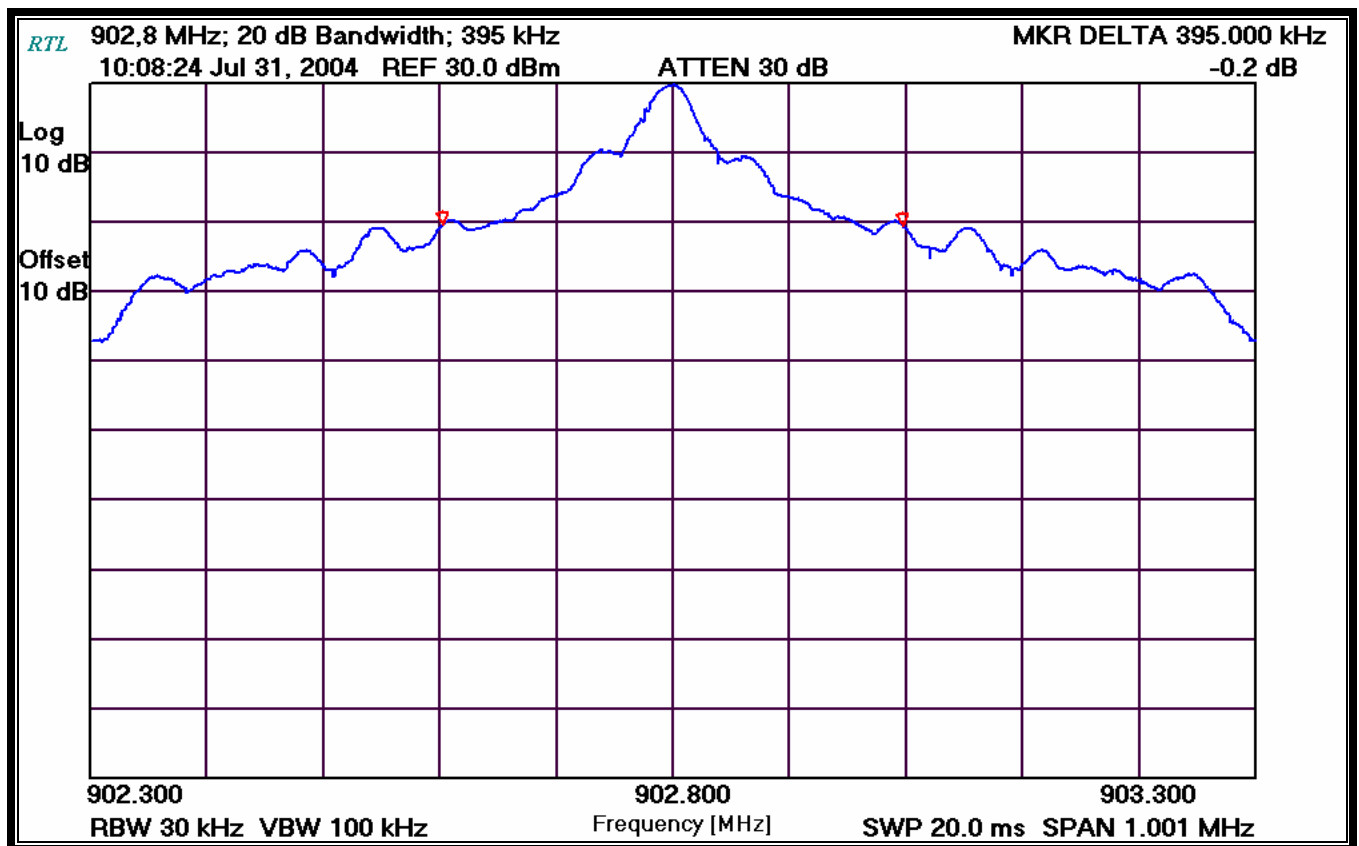

### TEST PERSONNEL:

Daniel W. Baltzell  
EMC Test Engineer

Signature

July 31, 2004  
Date Of Test

Channel: Mid  
Channel Frequency (MHz): 915.2  
Resolution Bandwidth (kHz): 30  
Video Bandwidth (kHz): 100  
Span (MHz): 1.0

PLOT 7-3: 20 DB BANDWIDTH MID CHANNEL

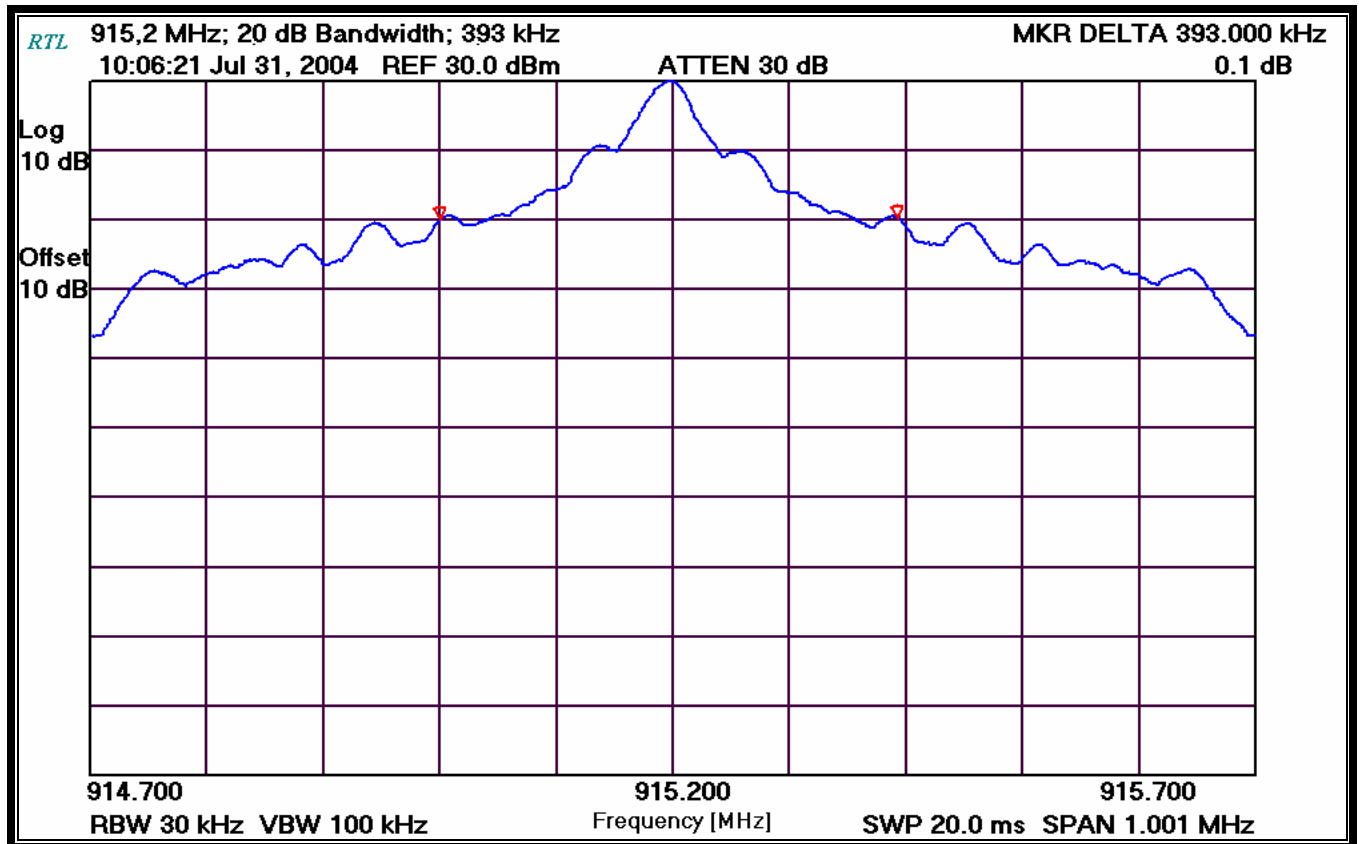

TEST PERSONNEL:

Daniel W. Baltzell  
EMC Test Engineer

Signature

July 31, 2004  
Date Of Test

Channel: High  
Channel Frequency (MHz): 927.6  
Resolution Bandwidth (kHz): 30  
Video Bandwidth (kHz): 100  
Span (MHz): 1.0

PLOT 7-4: 20 DB BANDWIDTH HIGH CHANNEL

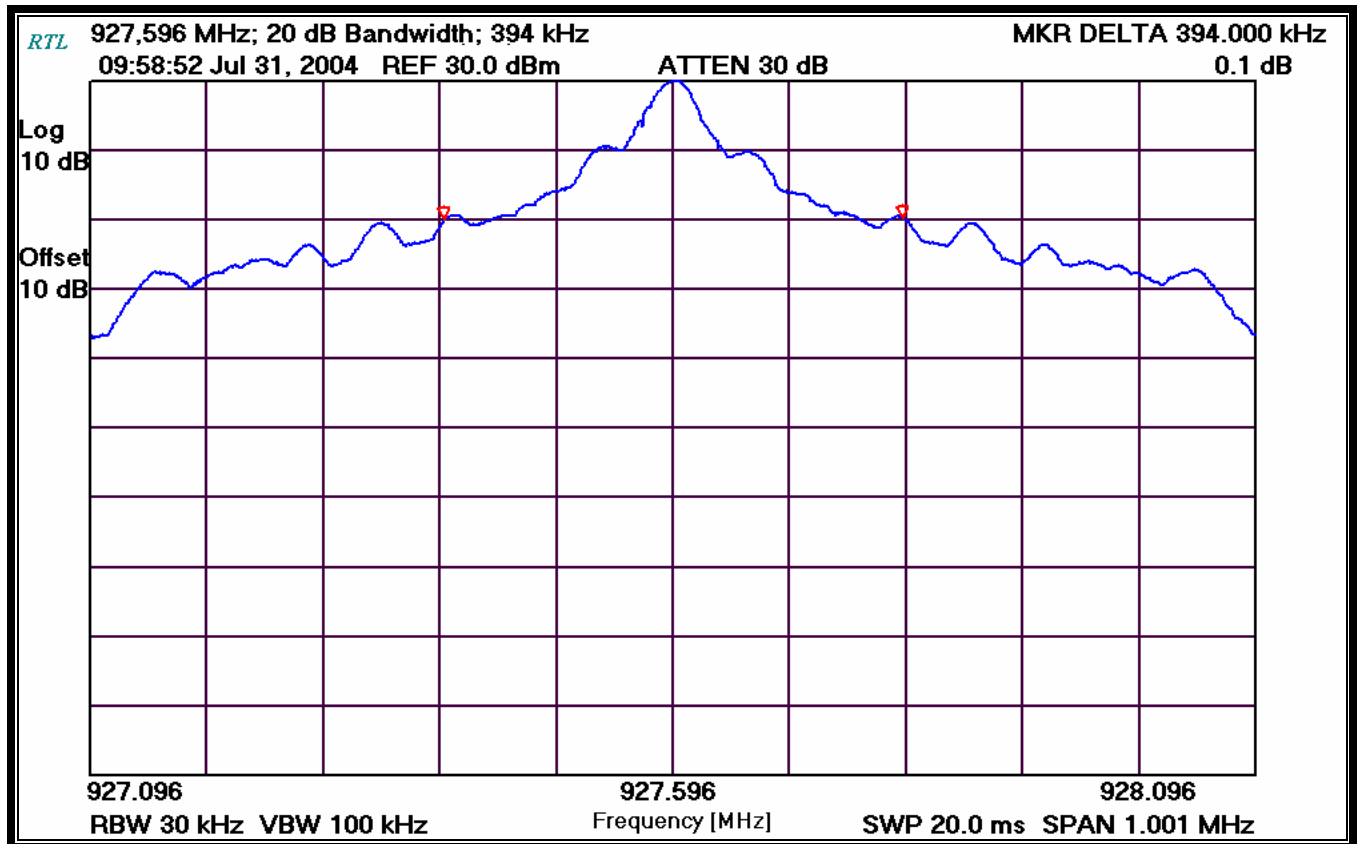

TEST PERSONNEL:

Daniel W. Baltzell  
EMC Test Engineer

Signature

July 31, 2004  
Date Of Test

### 7.3 AVERAGE TIME OF OCCUPANCY

The spectrum analyzer sweep was set to 0.5 seconds, with a zero span with a video trigger enabled to capture a pulse from the device under test. A marker delta was used to measure dwell time for this plot. The sweep was then set to single sweep for 60 seconds for the average time and the number of pulses counted to calculate the average time of occupancy as:

18 Pulses in 10 Seconds x Dwell Time Measured (7.58 milliseconds) = 136.4 ms Average Occupancy in 10 seconds.

The resultant occupancy of 0.136 s in a 10 second period is less than the limit of the time of occupancy of 0.4 seconds within a 10 second period.

**PLOT 7-5: TIME OF OCCUPANCY (DWEELL TIME)**

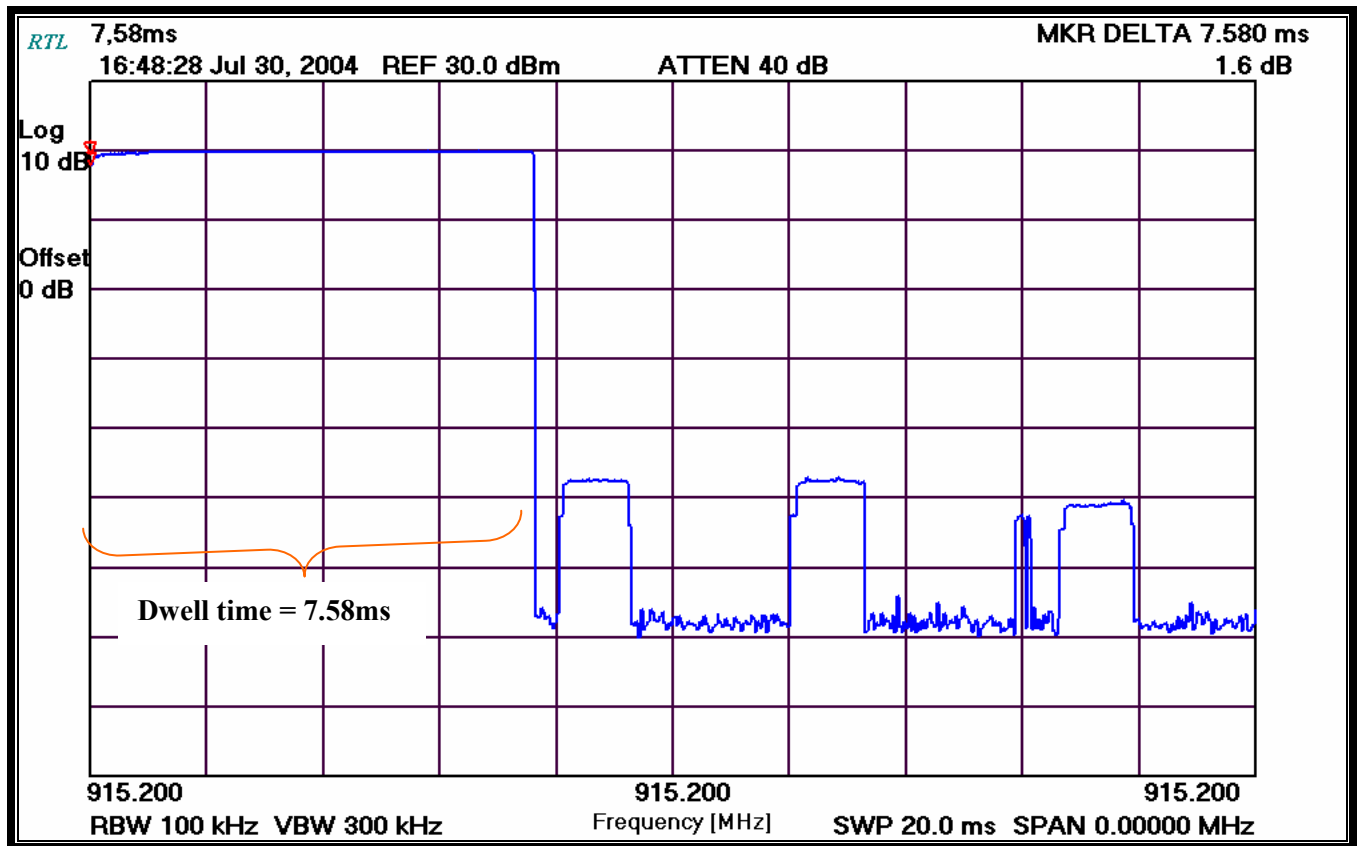

**TEST PERSONNEL:**

Daniel W. Baltzell  
 EMC Test Engineer

Signature

July 30, 2004  
 Date Of Test



**PLOT 7-6: TIME OF OCCUPANCY (DWELL TIME 10 SECOND SWEEP)**

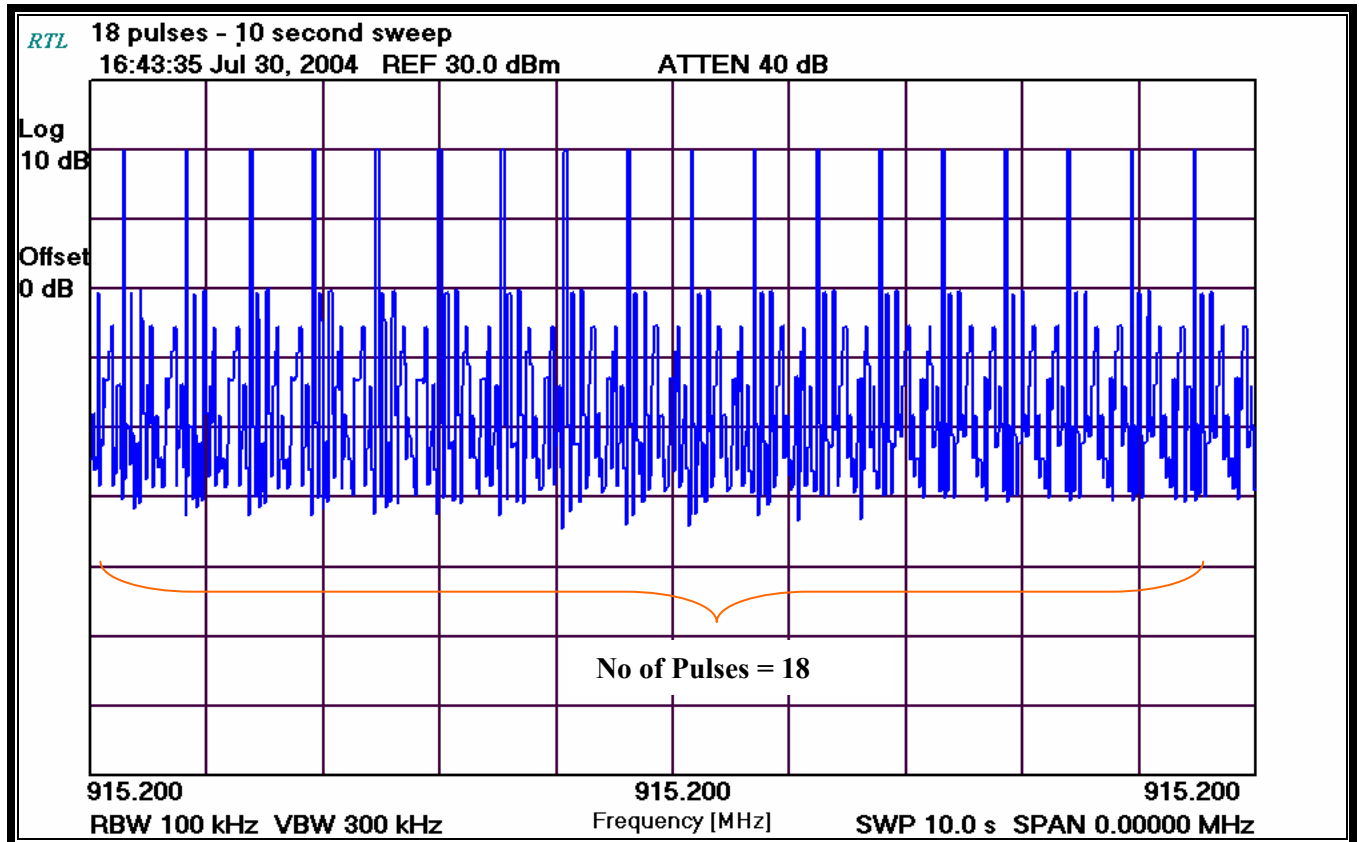

**TEST PERSONNEL:**

Daniel W. Baltzell  
EMC Test Engineer

Signature

July 30, 2004  
Date Of Test

## 8 PEAK OUTPUT POWER - FCC §15.247(B)(2); IC RSS-210 §6.2.2(O)(B)

### 8.1 POWER OUTPUT TEST PROCEDURE

For frequency hopping systems operating in the 902-928 MHz band: 1 watt for systems employing at least 50 hopping channels.

A conducted power measurement of the EUT was taken using an Agilent 4416A EPM-P Series Power Meter with a E9323A Peak and Average Power Sensor.

### 8.2 POWER OUTPUT TEST EQUIPMENT

**TABLE 8-1: POWER OUTPUT TEST EQUIPMENT**

RTL ASSET #	MANUFACTURER	MODEL	PART TYPE	SERIAL NUMBER	CALIBRATION DUE DATE
901186	Agilent Technologies	E9323A	Peak & Avg. Power Sensor (50 MHz - 6 GHz)	US40410380	7/30/05
901184	Agilent Technologies	E4416A	EPM-P Power Meter, Single Channel	GB41050573	7/30/05

### 8.3 POWER OUTPUT TEST DATA

**TABLE 8-2: POWER OUTPUT TEST DATA**

Frequency (MHz)	Channel	Peak Power Conducted Output (dBm)	Peak Power Conducted Output (mW)
Low; 902.8 MHz	Low	29.47	0.885
Mid; 915.2 MHz	Mid	29.60	0.912
High; 927.6 MHz	High	29.64	0.920

#### TEST PERSONNEL:

Daniel W. Baltzell  
 EMC Test Engineer



Signature

July 31, 2004  
 Date Of Test

## 9 ANTENNA CONDUCTED SPURIOUS EMISSIONS - §15.247(C); IC RSS-210 §6.2.2(O)(E1)

### 9.1 ANTENNA CONDUCTED SPURIOUS EMISSIONS TEST PROCEDURES

Antenna spurious emission per FCC 15.247(c) was measured from the EUT antenna port using a 50 Ω spectrum analyzer with the resolution bandwidth set at 100 kHz, and the video bandwidth set at 300 kHz. The modulated carrier was identified at 902.8 MHz for the low channel, 915.2 MHz for the mid channel and 927.6 MHz for the high channel. No other harmonics or spurs were found within 20 dB of the carrier level from 9kHz to the carrier 10<sup>th</sup> harmonic. The low, middle, and high channels were investigated and tested. See the Antenna Conducted Spurious Noise Table for the test results.

### 9.2 ANTENNA CONDUCTED SPURIOUS TEST EQUIPMENT

**TABLE 9-1: ANTENNA CONDUCTED SPURIOUS TEST EQUIPMENT**

RTL ASSET #	MANUFACTURER	MODEL	PART TYPE	SERIAL NUMBER	CALIBRATION DUE DATE
900931	Hewlett Packard	8566B	Spectrum Analyzer (100 Hz – 22 GHz)	3138A07771	6/23/05

**9.3 ANTENNA CONDUCTED SPURIOUS TEST DATA**

**9.4 ANTENNA CONDUCTED SPURIOUS EMISSIONS LOW CHANNEL**

**Operating Frequency (MHz):** 902.8  
**Channel:** Low  
**Measured Power Level (dBm):** 29.5  
**Limit (dBm):** 9.5

**TABLE 9-2: ANTENNA CONDUCTED SPURIOUS EMISSIONS LOW CHANNEL**

Frequency (MHz)	Measured Level (dBm)	Measured Level (dBc)	Limit (dBc)	Margin (dB)
789.996	-45.1	74.6	20	-54.6
891.900	-48.6	78.1	20	-58.1
1015.597	-47.4	76.9	20	-56.9
1805.600	-25.2	54.7	20	-34.7
2708.400	-67.4	96.9	20	-76.9
3611.200	-75.1	104.6	20	-84.6
4514.000	-83.5	113	20	-93
5416.800	-100.6	130.1	20	-110.1
6319.600	-70.4	99.9	20	-79.9
7222.400	-96.7	126.2	20	-106.2
8125.200	-103.2	132.7	20	-112.7
9028.000	-91.7	121.2	20	-101.2

**TEST PERSONNEL:**

Daniel W. Baltzell EMC Test Engineer	 Signature	July 31, 2004 Date Of Test
---	--	-------------------------------

## 9.5 ANTENNA CONDUCTED SPURIOUS EMISSIONS MID CHANNEL

Operating Frequency (MHz): 915.2  
 Channel: Mid  
 Measured Level at 100kHz (dBm): 29.6  
 Limit (dBm): 9.6

**TABLE 9-3: ANTENNA CONDUCTED SPURIOUS EMISSIONS MID CHANNEL**

Frequency (MHz)	Measured Level (dBm)	Measured Level (dBc)	Limit (dBc)	Margin (dB)
800.901	-70.7	100.3	20	-80.3
904.497	-63.9	93.5	20	-73.5
1029.591	-70.3	99.9	20	-79.9
1830.400	-28.8	58.4	20	-38.4
2745.600	-72.4	102	20	-82
3660.800	-74.4	104	20	-84
4576.000	-110.3	139.9	20	-119.9
5491.200	-103.5	133.1	20	-113.1
6406.400	-97.3	126.9	20	-106.9
7321.600	-106.8	136.4	20	-116.4
8236.800	-110.0	139.6	20	-119.6
9152.000	-98.0	127.6	20	-107.6

### TEST PERSONNEL:

Daniel W. Baltzell  
 EMC Test Engineer

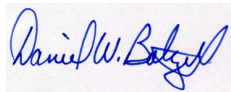

Signature

July 31, 2004  
 Date Of Test

## 9.6 ANTENNA CONDUCTED SPURIOUS EMISSIONS HIGH CHANNEL

Operating Frequency (MHz): 927.6  
 Channel: High  
 Measured Level at 100kHz (dBm): 29.6  
 Limit (dBm): 9.6

**TABLE 9-4: ANTENNA CONDUCTED SPURIOUS EMISSIONS HIGH CHANNEL**

Frequency (MHz)	Measured Level (dBm)	Measured Level (dBc)	Limit (dBc)	Margin (dB)
811.597	-67.2	96.8	20	-76.8
916.896	-64.3	93.9	20	-73.9
1043.595	-66.1	95.7	20	-75.7
1855.200	-22.4	52	20	-32
2782.800	-74.9	104.5	20	-84.5
3710.400	-95.1	124.7	20	-104.7
4638.000	-101.7	131.3	20	-111.3
5565.600	-90.1	119.7	20	-99.7
6493.200	-85.3	114.9	20	-94.9
7420.800	-100.3	129.9	20	-109.9
8348.400	-102.9	132.5	20	-112.5
9276.000	-108.2	137.8	20	-117.8

### TEST PERSONNEL:

Daniel W. Baltzell  
 EMC Test Engineer



Signature

July 31, 2004  
 Date Of Test

Rhein Tech Laboratories  
360 Herndon Parkway  
Suite 1400  
Herndon, VA 20170  
<http://www.rheintech.com>

Client: Paxar Americas, Inc.  
FCC: Part 15.247  
Industry Canada: RSS-210  
FCC ID: GU6RFIDALN1  
Model : ALR-9932-A

## **10 CONCLUSION**

The data in this measurement report shows that the Paxar Americas, Inc., Model: Alien ALR-9932-A, FCC ID: GU6RFIDALN1, complies with all the requirements of Parts 2 and 15 of the FCC Rules and Industry Canada RSS-210.