

EVERY DENNISON RETAIL INFORMATION SERVICES LLC

HOST PRINTER MODEL: 9906 WITH WIRELESS 802.11B/G AND UHF RFID MODULE

Model: 128921

May 10th 2011

Report No.: SL11031602-AVE-010_9906_FCC (WLAN) Rev1.0
(This report supersedes SL11031602-AVE-010_9906_FCC (WLAN))



Modifications made to the product : None

This Test Report is Issued Under the Authority of:

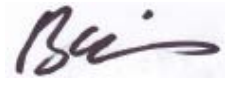
	
David Zhang Compliance Engineer	Leslie Bai Director of Certification

This test report may be reproduced in full only.
All Test Data Presented in this report is only applicable to presented Test sample.

EMC Test Report

To: FCC Part 15.247 & RSS 210 Issue 8: 2010

SIEMIC, INC.
Accessing global markets



Laboratory Introduction

SIEMIC, headquartered in the heart of Silicon Valley, with superior facilities in US and Asia, is one of the leading independent testing and certification facilities providing customers with one-stop shop services for Compliance Testing and Global Certifications.



In addition to [testing](#) and [certification](#), SIEMIC provides initial design reviews and [compliance management](#) through out a project. Our extensive experience with [China](#), [Asia Pacific](#), [North America](#), [European](#), and [international](#) compliance requirements, assures the fastest, most cost effective way to attain regulatory compliance for the [global markets](#).

Accreditations for Conformity Assessment

Country/Region	Accreditation Body	Scope
USA	FCC, A2LA	EMC , RF/Wireless , Telecom
Canada	IC, A2LA, NIST	EMC, RF/Wireless , Telecom
Taiwan	BSMI , NCC , NIST	EMC, RF, Telecom , Safety
Hong Kong	OFTA , NIST	RF/Wireless , Telecom
Australia	NATA, NIST	EMC, RF, Telecom , Safety
Korea	KCC/RRA, NIST	EMI, EMS, RF , Telecom, Safety
Japan	VCCI, JATE, TELEC, RFT	EMI, RF/Wireless, Telecom
Mexico	NOM, COFETEL, Caniety	Safety, EMC , RF/Wireless, Telecom
Europe	A2LA, NIST	EMC, RF, Telecom , Safety

Accreditations for Product Certifications

Country	Accreditation Body	Scope
USA	FCC TCB, NIST	EMC , RF , Telecom
Canada	IC FCB , NIST	EMC , RF , Telecom
Singapore	iDA, NIST	EMC , RF , Telecom
Japan	RCB, NIST	RF, Telecom



SIEMIC, INC.

Accessing global markets

Title: RF Test Report of Avery Dennison Retail Information Services LLC
Model : 128921
To FCC 15.247 2010 & RSS-210 Issue 8 : 2010

Serial# SL11031602-AVE-010_9906_FCC (WLAN) Rev1.0
Issue Date May 10th 2011
Page 3 of 55
www.siemic.com

This page has been left blank intentionally.



CONTENTS

1	EXECUTIVE SUMMARY & EUT INFORMATION	6
2	TECHNICAL DETAILS.....	7
3	MODIFICATION.....	8
4	TEST SUMMARY.....	9
5	MEASUREMENTS, EXAMINATION AND DERIVED RESULTS	10
	ANNEX A. TEST INSTRUMENT & METHOD	30
	ANNEX B EUT AND TEST SETUP PHOTOGRAPHS.....	34
	ANNEX C. TEST SETUP AND SUPPORTING EQUIPMENT.....	34
	ANNEX D USER MANUAL, BLOCK DIAGRAM, CIRCUIT DIAGRAM.....	38
	ANNEX E. SIEMIC ACCREDITATION CERTIFICATES	39



SIEMIC, INC.

Accessing global markets

Title: RF Test Report of Avery Dennison Retail Information Services LLC
Model : 128921
To: FCC 15.247 2010 & RSS-210 Issue 8 : 2010

Serial# SL11031602-AVE-010_9906_FCC (WLAN) Rev1.0
Issue Date May 10th 2011
Page 5 of 55
www.siemic.com

This page has been left blank intentionally.



1 Executive Summary & EUT information

The purpose of this test programmed was to demonstrate compliance of the FCC/IC approved Radio module FCC ID: GU6-SX10WGPM, with antenna HG2402RD-RSF installed inside HOST PRINTER MODEL: 9906 WITH WIRELESS 802.11B/G and UHF RFID MODULE, against the current Stipulated Standards. The complete system 9906 has demonstrated compliance with the FCC 15.247 2010 & RSS-210 Issue 8 : 2010.

Avery Dennison Retail Information Services LLC is the applicant and claimed manufacturer of this tested product. For the detailed description of this product, please refer to the HOST PRINTER MODEL: 9906 WITH WIRELESS 802.11B/G and UHF RFID MODULE User Manual submitted as another Exhibit to this application.

The equipment under test radio operating frequency is 2412 MHz – 2462 MHz.

The test has demonstrated that this unit complies with stipulated standards.

EUT Information

EUT Description	: Avery Dennison Retail Information Services LLC will use the 128921 radio module within Avery HOST PRINTER MODEL: 9906 WITH WIRELESS 802.11B/G and UHF RFID MODULE. The radio will be installed inside the product and will not be user accessible. 802.11b/g radios are designed to operate in the international ISM Band from 2.412 to 2.462 GHz.
Model No	: 128921
Serial No	: 10090069
Input Power	: 100 - 240 VAC, 60 - 50Hz , 1.0 - 0.5 A
Classification Per Stipulated Test Standard	: Spread Spectrum System / Device Class B Emission



2 TECHNICAL DETAILS

Purpose	Compliance testing of 802.11b/g radio module model 128921 with stipulated standard
Applicant / Client	Avery Dennison Retail Information Services LLC
Manufacturer	Avery Dennison Retail Information Services LLC 170 Monarch Lane Miamisburg, OH 45342 USA
Laboratory performing the tests	SIEMIC Laboratories
Test report reference number	SL11031602-AVE-010_9906_FCC (WLAN) Rev1.0
Date EUT received	Apr 26th 2011
Standard applied	See Page 9
Dates of test (from – to)	Apr 26th – May 10th 2011
No of Units:	1
Equipment Category:	DTS
Trade Name:	Monarch
Model Name:	128921
RF Operating Frequency (ies)	2412-2462MHz
Number of Channels:	11
Modulation:	CCK & OFDM
FCC ID:	GU6-SX10WGPM
IC ID:	1502A-SX10WGPM



SIEMIC, INC.

Accessing global markets

Title: RF Test Report of Avery Dennison Retail Information Services LLC
Model : 128921
To: FCC 15.247 2010 & RSS-210 Issue 8 : 2010

Serial# SL11031602-AVE-010_9906_FCC (WLAN) Rev1.0
Issue Date May 10th 2011
Page 8 of 55
www.siemic.com

3 MODIFICATION

NONE

4 TEST SUMMARY

The product was tested in accordance with the following specifications. All testing has been performed according to below product classification:

Spread Spectrum System / Device

Test Results Summary

Test Standard		Description	Pass / Fail
CFR 47 Part 15.247: 2010	RSS 210 Issue 7: 2007		
15.203		Antenna Requirement	Pass
15.205	RSS210(A8.5)	Restricted Band of Operation	Pass
15.207(a)	RSSGen(7.2.2)	Conducted Emissions Voltage	Pass
15.247(a)(1)	RSS210(A8.1)	Channel Separation	N/A
15.247(a)(1)	RSS210(A8.1)	Occupied Bandwidth	Pass (Original)
15.247(a)(2)	RSS210 (A8.2)	Bandwidth	Pass (Original)
15.247(a)(1)	RSS210(A8.1)	Number of Hopping Channels	N/A
15.247(a)(1)	RSS210(A8.1)	Time of Occupancy	N/A
15.247(b)	RSS210(A8.4)	Output Power	Pass (Original)
15.247(c)	RSS210(A8.4)	Antenna Gain > 6 dBi	N/A
15.247(d)	RSS210(A8.5)	Conducted Spurious Emissions	Pass (Original)
15.209; 15.247(d)	RSS210(A8.5)	Radiated Spurious Emissions	Pass
15.247(e)	RSS210(A8.3)	Power Spectral Density	Pass (Original)
15.247(f)	RSS210(A8.3)	Hybrid System Requirement	N/A
15.247(g)	RSS210(A8.1)	Hopping Capability	N/A
15.247(h)	RSS210(A8.1)	Hopping Coordination Requirement	N/A
15.247(i)	RSSGen(5.5)	RF Exposure requirement	Pass (Original)
	RSSGen(4.8)	Receiver Spurious Emissions	Pass (Original)

ANSI C63.4: 2003/ RSS-Gen Issue 3: 2010

PS: All measurement uncertainties are not taken into consideration for all presented test result.

5 MEASUREMENTS, EXAMINATION AND DERIVED RESULTS

5.1 Antenna Requirement

Requirement(s): 47 CFR §15.203

An intentional radiator shall be designed to ensure that no antenna other than that furnished by the responsible party shall be used with the device.

Antenna requirement must meet at least one of the following:

- a) Antenna must be permanently attached to the device.
- b) Antenna must use a unique type of connector to attach to the device.
- c) Device must be professionally installed. Installer shall be responsible for ensuring that the correct antenna is employed with the device.

The antenna connector is Omnidirectional "rubber-duck" type.. Antenna maximum gain is 2.2dBi for 2.400–2.500 GHz band.

Results: PASS

5.2 Conducted Emissions Voltage

Requirement:

Frequency of emission (MHz)	Conducted limit (dB μ V)	
	Quasi-peak	Average
0.15–0.5	66 to 56*	56 to 46*
0.5–5	56	46
5–30	60	50

*Decreases with the logarithm of the frequency.

Procedures:

- All possible modes of operation were investigated. Only the 6 worst case emissions measured, using the correct CISPR and Average detectors, are reported. All other emissions were relatively insignificant.
- A "-ve" margin indicates a PASS as it refers to the margin present below the limit line at the particular frequency.
- Conducted Emissions Measurement Uncertainty
All test measurements carried out are traceable to national standards. The uncertainty of the measurement at a confidence level of approximately 95% (in the case where distributions are normal), with a coverage factor of 2, in the range 9kHz – 30MHz (Average & Quasi-peak) is ± 3.5 dB.
- Environmental Conditions

Temperature	24°C
Relative Humidity	50%
Atmospheric Pressure	1019mbar

Test Date : Apr 26th to May 10th 2011
 Tested By :David Zhang

Results: Pass



SIEMIC, INC.

Accessing global markets

Title: RF Test Report of Avery Dennison Retail Information Services LLC
Model : 128921
To: FCC 15.247 2010 & RSS-210 Issue 8 : 2010

Serial# SL11031602-AVE-010_9906_FCC (WLAN) Rev1.0
Issue Date May 10th 2011
Page 12 of 55
www.siemic.com

Host: 9906 with 802.11b/g and RFID module (Knife option)

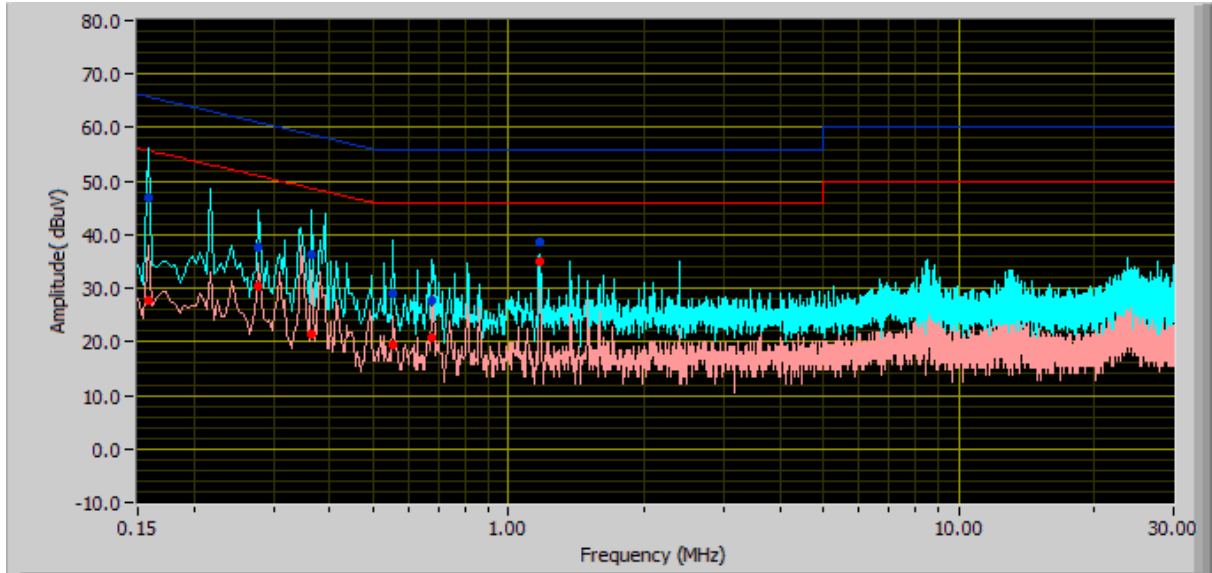

Quasi-Peak Limit

Average Limit

Phase Line Plot at 120Vac, 60Hz

Frequency (MHz)	QP Value (dB μ V)	Class B Limit (dB)	Pass / Fail	Margin (dB)	Avg Value (dB μ V)	Class B Limit (dB)	Pass / Fail	Margin (dB)	Line
0.16	46.76	65.75	PASS	-18.99	27.83	55.75	PASS	-27.92	Phase
0.37	36.30	58.64	PASS	-22.34	21.58	48.64	PASS	-27.06	Phase
0.28	37.58	60.97	PASS	-23.38	30.42	50.97	PASS	-20.54	Phase
0.55	29.06	56.00	PASS	-26.94	19.52	46.00	PASS	-26.48	Phase
1.17	38.50	56.00	PASS	-17.50	34.98	46.00	PASS	-11.02	Phase
0.67	27.65	56.00	PASS	-28.35	20.85	46.00	PASS	-25.15	Phase



SIEMIC, INC.

Accessing global markets

Title: RF Test Report of Avery Dennison Retail Information Services LLC
 To: Model : 128921
 FCC 15.247 2010 & RSS-210 Issue 8 : 2010

Serial# SL11031602-AVE-010_9906_FCC (WLAN) Rev1.0
 Issue Date May 10th 2011
 Page 13 of 55
 www.siemic.com

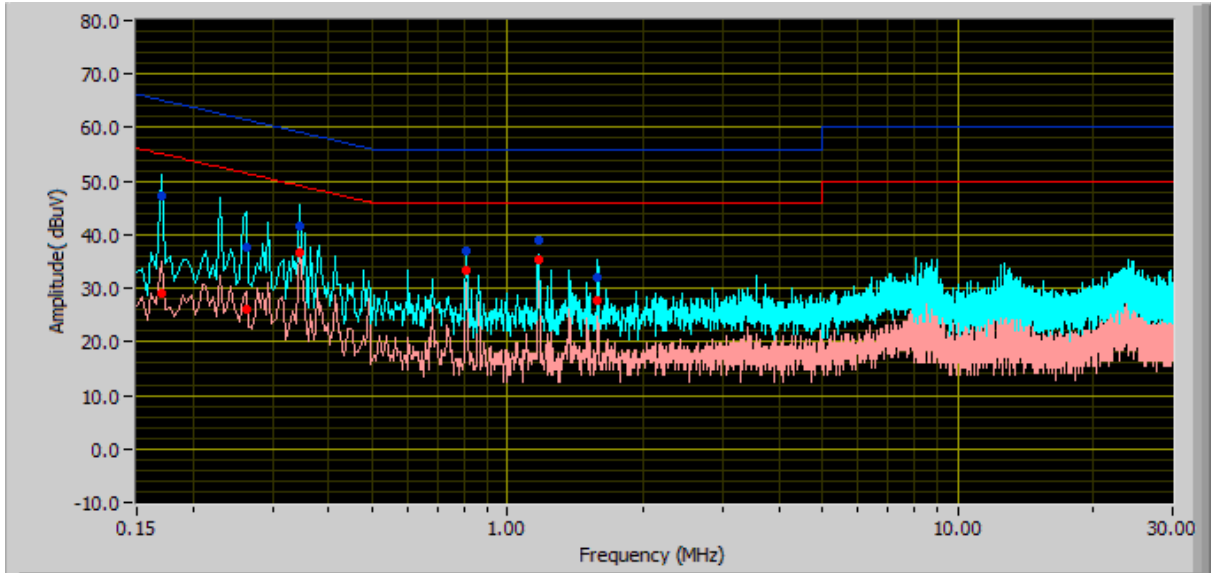

Quasi-Peak Limit

Average Limit

Neutral Line Plot at 120Vac, 60Hz

Frequency (MHz)	QP Value (dB μ V)	Class B Limit (dB)	Pass / Fail	Margin (dB)	Avg Value (dB μ V)	Class B Limit (dB)	Pass / Fail	Margin (dB)	Line
0.35	41.58	59.11	PASS	-17.53	36.65	49.11	PASS	-12.47	Neutral
0.17	47.08	65.13	PASS	-18.05	29.07	55.13	PASS	-26.06	Neutral
0.26	37.79	61.47	PASS	-23.68	25.97	51.47	PASS	-25.50	Neutral
1.17	38.97	56.00	PASS	-17.03	35.17	46.00	PASS	-10.83	Neutral
0.81	36.89	56.00	PASS	-19.11	33.32	46.00	PASS	-12.68	Neutral
1.59	31.88	56.00	PASS	-24.12	27.80	46.00	PASS	-18.20	Neutral



SIEMIC, INC.

Accessing global markets

Title: RF Test Report of Avery Dennison Retail Information Services LLC
To: Model : 128921
FCC 15.247 2010 & RSS-210 Issue 8 : 2010

Serial# SL11031602-AVE-010_9906_FCC (WLAN) Rev1.0
Issue Date May 10th 2011
Page 14 of 55
www.siemac.com

9906 with 802.11b/g and RFID module (Rewinder option)

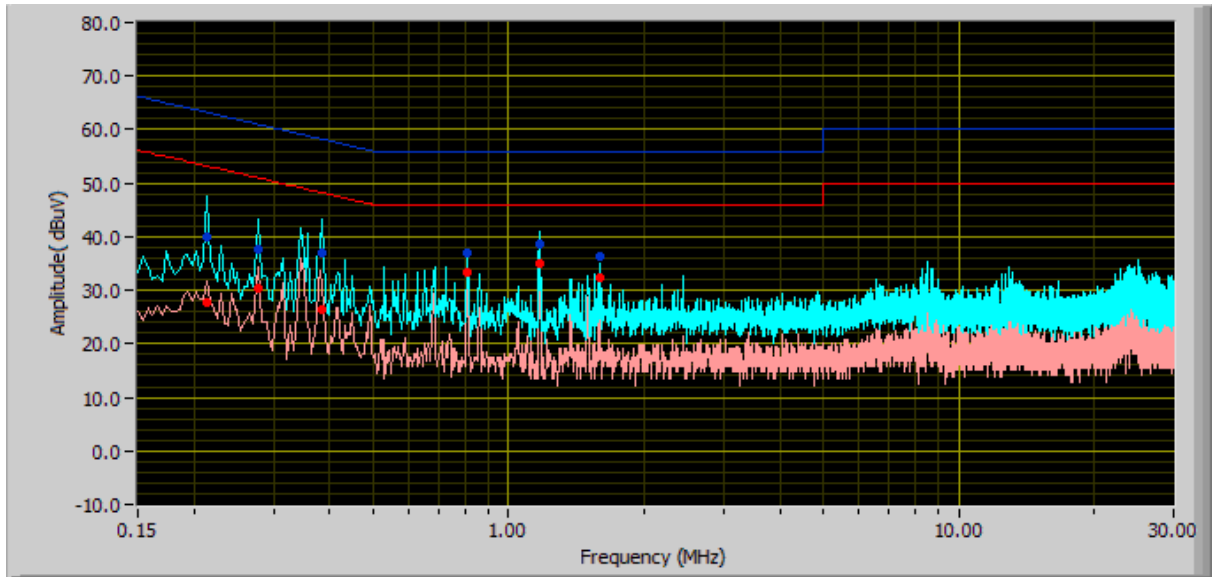

Quasi-Peak Limit

Average Limit

Phase Line Plot at 120Vac, 60Hz

Frequency (MHz)	QP Value (dBµV)	Class B Limit (dB)	Pass / Fail	Margin (dB)	Avg Value (dBµV)	Class B Limit (dB)	Pass / Fail	Margin (dB)	Line
1.17	38.64	56.00	PASS	-17.36	35.08	46.00	PASS	-10.92	Phase
0.39	37.07	58.19	PASS	-21.12	26.30	48.19	PASS	-21.88	Phase
0.21	40.06	63.18	PASS	-23.12	27.79	53.18	PASS	-25.39	Phase
0.28	37.58	60.97	PASS	-23.38	30.42	50.97	PASS	-20.54	Phase
0.81	36.94	56.00	PASS	-19.06	33.41	46.00	PASS	-12.59	Phase
1.59	36.46	56.00	PASS	-19.54	32.43	46.00	PASS	-13.57	Phase



SIEMIC, INC.

Accessing global markets

Title: RF Test Report of Avery Dennison Retail Information Services LLC
To: Model : 128921
FCC 15.247 2010 & RSS-210 Issue 8 : 2010

Serial# SL11031602-AVE-010_9906_FCC (WLAN) Rev1.0
Issue Date May 10th 2011
Page 15 of 55
www.siemec.com

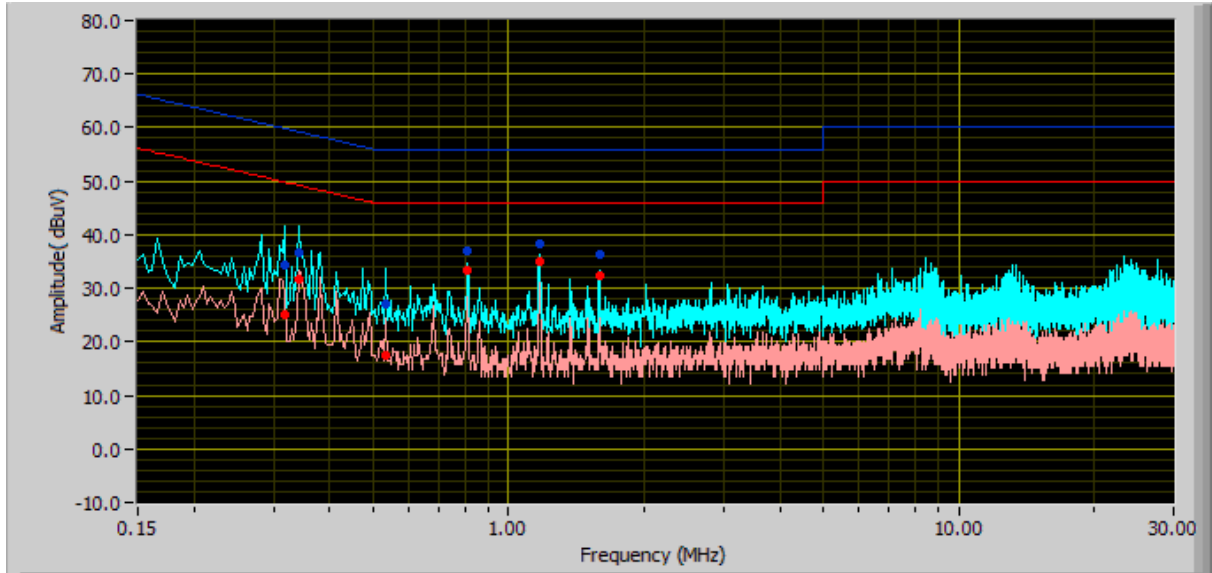

Quasi-Peak Limit

Average Limit

Neutral Line Plot at 120Vac, 60Hz

Frequency (MHz)	QP Value (dBμV)	Class B Limit (dB)	Pass / Fail	Margin (dB)	Avg Value (dBμV)	Class B Limit (dB)	Pass / Fail	Margin (dB)	Line
0.34	36.81	59.21	PASS	-22.41	31.58	49.21	PASS	-17.63	Neutral
0.32	34.30	59.83	PASS	-25.53	25.08	49.83	PASS	-24.74	Neutral
1.17	38.36	56.00	PASS	-17.64	34.87	46.00	PASS	-11.13	Neutral
0.81	37.02	56.00	PASS	-18.98	33.41	46.00	PASS	-12.59	Neutral
0.53	26.93	56.00	PASS	-29.07	17.39	46.00	PASS	-28.61	Neutral
1.59	36.19	56.00	PASS	-19.81	32.43	46.00	PASS	-13.57	Neutral

5.3 20dB & 99% Occupied Bandwidth

1. Conducted Measurement

EUT was set for low ,mid, high channel with modulated mode and highest RF output power.
The spectrum analyzer was connected to the antenna terminal.

2	Environmental Conditions	Temperature	24 °C
		Relative Humidity	50%
		Atmospheric Pressure	1019mbar

3 Conducted Emissions Measurement Uncertainty

All test measurements carried out are traceable to national standards. The uncertainty of the measurement at a confidence level of approximately 95% (in the case where distributions are normal), with a coverage factor of 2, in the range 30MHz – 40GHz is ± 1.5 dB.

4 Test Date : Apr 26th to May 10th 2011
Tested By :David Zhang

Requirement(s): 47 CFR §15.247(a)(1)

Procedures: The 20 dB bandwidths were measured conducted using a spectrum analyzer at low, mid, and hi channels. 20 dB Bandwidth Limit: > 500 kHz.

Results: Pass

Please see Original FCC Report SL09051203-PAX-002-E (FCC 15.247).

5.4 Peak Spectral Density

1. Conducted Measurement
EUT was set for low , mid, high channel with modulated mode and highest RF output power.
The spectrum analyzer was connected to the antenna terminal.
2. Conducted Emissions Measurement Uncertainty
All test measurements carried out are traceable to national standards. The uncertainty of the measurement at a confidence level of approximately 95% (in the case where distributions are normal), with a coverage factor of 2, in the range 30MHz – 40GHz is ± 1.5 dB.
3. Environmental Conditions
Temperature 24 °C
Relative Humidity 50%
Atmospheric Pressure 1019mbar
4. Test Date : Apr 26th to May 10th 2011
Tested By :David Zhang

Standard Requirement : 47 CFR §15.247(e)

For digitally modulated systems, the power spectral density conducted from the intentional radiator to the antenna shall not be greater than 8 dBm in any 3 kHz band during any time interval of continuous transmission

Procedures: The Peak Spectral density measurement was taken conducted using a spectrum analyzer.

RBW=3KHz, VBW > RBW , Sweep time to SPAN/RBW (sec)

Test Result: Pass

Please see Original FCC Report SL09051203-PAX-002-E (FCC 15.247).

5.10 Peak Output Power

1. Conducted Measurement
EUT was set for low , mid, high channel with modulated mode and highest RF output power.
The spectrum analyzer was connected to the antenna terminal.
2. Conducted Emissions Measurement Uncertainty
All test measurements carried out are traceable to national standards. The uncertainty of the measurement at a confidence level of approximately 95% (in the case where distributions are normal), with a coverage factor of 2, in the range 30MHz – 40GHz is ± 1.5 dB.
3. Environmental Conditions
Temperature 24 °C
Relative Humidity 50%
Atmospheric Pressure 1019mbar
4. Test Date : Apr 26th to May 10th 2011
Tested By :David Zhang

Standard Requirement: 47 CFR §15.247(b)

Procedures: The peak output power was measured conducted using a spectrum analyzer at low, mid, and hi channels. Peak detector was set to measure the power output. The power is converted from watt to dBm, therefore, 1 watt = 30 dBm. The highest antenna gain that will be used is 3 dBi.

Test Result: Pass

Please see Original FCC Report SL09051203-PAX-002-E (FCC 15.247).

5.10 Antenna Port Emission

1. Conducted Measurement
EUT was set for low , mid, high channel with modulated mode and highest RF output power.
The spectrum analyzer was connected to the antenna terminal.
2. Conducted Emissions Measurement Uncertainty
All test measurements carried out are traceable to national standards. The uncertainty of the measurement at a confidence level of approximately 95% (in the case where distributions are normal), with a coverage factor of 2, in the range 30MHz – 40GHz is $\pm 1.5\text{dB}$.
3. Environmental Conditions

Temperature	24 °C
Relative Humidity	50%
Atmospheric Pressure	1019mbar
4. Test Date : Apr 26th to May 10th 2011
 Tested By :David Zhang

Standard Requirement: 47 CFR §15.247(d)

Procedures: The conducted spurious emissions were measured conducted using a spectrum analyzer at low, mid, and hi channels. The limit was determined by attenuating 20 dB of the RF peak power output

Test Result: Pass

Please see Original FCC Report SL09051203-PAX-002-E (FCC 15.247).

5.10 Radiated Spurious Emission < 1GHz

1. All possible modes of operation were investigated. Only the 6 worst case emissions measured, using the correct CISPR detectors, are reported. All other emissions were relatively insignificant.
2. A "-ve" margin indicates a PASS as it refers to the margin present below the limit line at the particular frequency.
3. Radiated Emissions Measurement Uncertainty
All test measurements carried out are traceable to national standards. The uncertainty of the measurement at a confidence level of approximately 95% (in the case where distributions are normal), with a coverage factor of 2, in the range 30MHz – 1GHz (QP only @ 3m & 10m) is +5.6dB/-4.5dB (for EUTs < 0.5m X 0.5m X 0.5m).

4	Environmental Conditions	Temperature	24 °C
		Relative Humidity	50%
		Atmospheric Pressure	1019mbar

Test Date : Apr 26th to May 10th 2011

Tested By :David Zhang

Standard Requirement: 47 CFR §15.247(d)

Procedures: Radiated emissions were measured according to ANSI C63.4. The EUT was set to transmit at the highest output power. The EUT was set to transmit at mid channel. Note that setting the channel other than mid, the spurious emissions are the same.

The limit is converted from microvolts/meter to decibel microvolts/meter.

Sample Calculation: Corrected Amplitude = Raw Amplitude (dBµV/m) + ACF (dB) + Cable Loss(dB)

Test Result: Pass

Radiated Emission Plot - Transmit Mode

9906 with 802.11b/g and RFID module

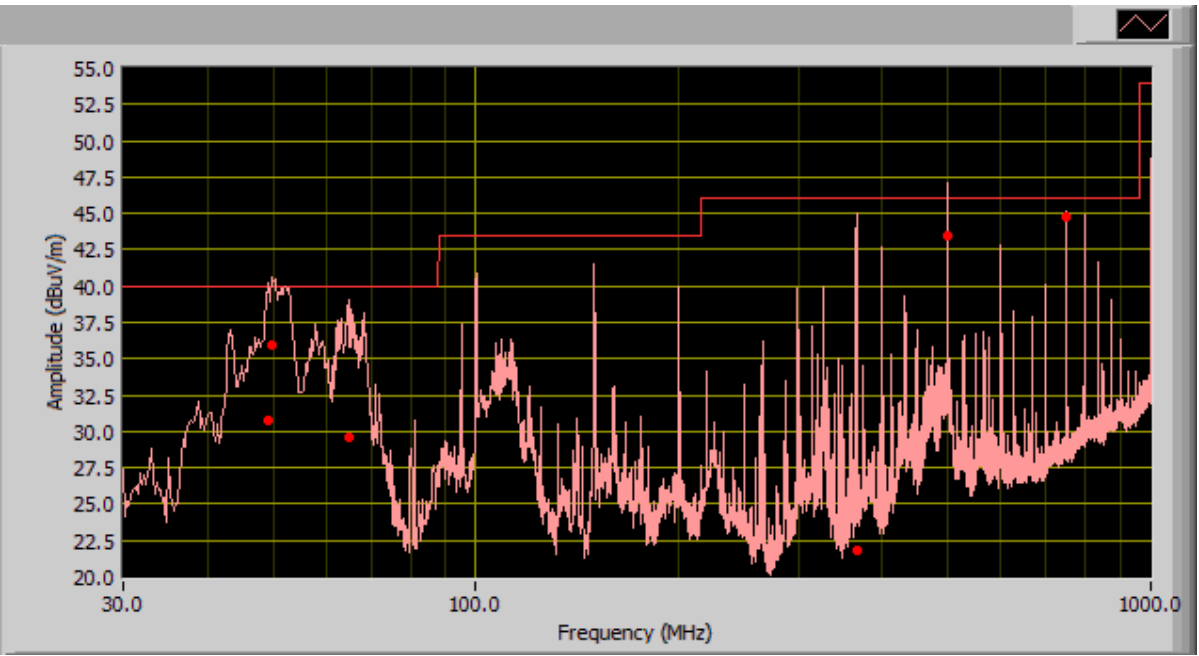

Limit

30MHz ~1000MHz @3m, Class B

Frequency (MHz)	Quasi-Peak (dBμV/m)	Antenna height (cm)	Polarity	Turntable position (deg)	Class B Limit (dBμV/m)	Margin (dB)
49.18	30.75	211.00	V	120.00	40.00	-9.25
50.01	35.95	110.00	V	210.00	40.00	-4.05
64.61	29.53	102.00	V	358.00	40.00	-10.47
366.41	21.83	206.00	V	113.00	46.00	-24.17
500.00	43.43	101.00	V	180.00	46.00	-2.57
750.00	44.71	103.00	V	149.00	46.00	-1.29



SIEMIC, INC.

Accessing global markets

Title: RF Test Report of Avery Dennison Retail Information Services LLC
Model : 128921
To: FCC 15.247 2010 & RSS-210 Issue 8 : 2010

Serial# SL11031602-AVE-010_9906_FCC (WLAN) Rev1.0
Issue Date May 10th 2011
Page 22 of 55
www.siemic.com

Radiated Emission Plot - Receive Mode

9906

Test Result: Pass

Note: No outstanding spurious emission from radio was found.

9906 with 802.11b/g and RFID module (Knife option)

802.11b @ 2412MHz & RFID @ 902.75 MHz@ 3 Meter (co-location emission result)

Frequency (GHz)	Reading (dBuV/m)	Direction (degree)	Height (m)	Polarity (H/V)	Antenna Loss (dB)	Cable Loss (dB)	Amplifier (dB)	Corrected Reading (dBuV/m)	15.247/15.209 Limit @ 3m (dBuV/m)	Margin (dBuV/m)	Detector (pk/avg)
1.441	49.53	113	100	V	24.80	1.82	31.99	44.16	74.00	-29.84	Peak
1.441	28.85	113	100	V	24.80	1.82	31.99	23.48	54.00	-30.52	Ave
1.441	47.86	202	100	H	24.80	1.82	31.99	42.49	74.00	-31.51	Peak
1.441	32.57	202	100	H	24.80	1.82	31.99	27.20	54.00	-26.80	Ave
1.665	59.23	58	100	V	25.70	2.16	31.98	55.11	74.00	-18.89	Peak
1.665	30.43	58	100	V	25.70	2.16	31.98	26.31	54.00	-27.69	Ave
1.665	51.95	192	100	H	25.70	2.16	31.98	47.83	74.00	-26.17	Peak
1.665	29.51	192	100	H	25.70	2.16	31.98	25.39	54.00	-28.61	Ave
1.806	51.74	203	100	V	25.70	2.16	31.98	47.62	74.00	-26.38	Peak
1.806	28.97	203	100	V	25.70	2.16	31.98	24.85	54.00	-29.15	Ave
1.806	45.32	89	100	H	25.70	2.16	31.98	41.20	74.00	-32.80	Peak
1.806	27.93	89	100	H	25.70	2.16	31.98	23.81	54.00	-30.19	Ave
2.400	48.42	337	100	V	27.50	2.50	32.04	46.38	74.00	-27.62	Peak
2.400	26.60	337	100	V	27.50	2.50	32.04	24.56	54.00	-29.44	Ave
2.400	45.78	115	100	H	27.50	2.50	32.04	43.74	74.00	-30.26	Peak
2.400	26.33	115	100	H	27.50	2.50	32.04	24.29	54.00	-29.71	Ave

Note: Emission was scanned up to 25GHz; no emissions were detected above the noise floor which was at least 20dB below the specification limit

802.11b @ 2437MHz & RFID @ 915.25 MHz@ 3 Meter(co-location emission result)

Frequency (GHz)	Reading (dBuV/m)	Direction (degree)	Height (m)	Polarity (H/V)	Antenna Loss (dB)	Cable Loss (dB)	Amplifier (dB)	Corrected Reading (dBuV/m)	15.247/15.209 Limit @ 3m (dBuV/m)	Margin (dBuV/m)	Detector (pk/avg)
1.431	45.10	104	100	V	24.80	1.82	31.99	39.73	74.00	-34.27	Peak
1.431	28.03	104	100	V	24.80	1.82	31.99	22.66	54.00	-31.34	Ave
1.431	44.53	218	101	H	24.80	1.82	31.99	39.16	74.00	-34.84	Peak
1.431	30.14	218	101	H	24.80	1.82	31.99	24.77	54.00	-29.23	Ave
1.665	60.78	124	101	V	25.70	2.16	31.98	56.66	74.00	-17.34	Peak
1.665	31.72	124	101	V	25.70	2.16	31.98	27.60	54.00	-26.40	Ave
1.665	55.66	94	100	H	25.70	2.16	31.98	51.54	74.00	-22.46	Peak
1.665	30.15	94	100	H	25.70	2.16	31.98	26.03	54.00	-27.97	Ave
3.980	39.74	23	136	V	31.20	3.44	32.37	42.00	74.00	-32.00	Peak
3.980	24.69	23	136	V	31.20	3.44	32.37	26.96	54.00	-27.04	Ave
3.980	39.66	292	158	H	31.20	3.44	32.37	41.93	74.00	-32.07	Peak
3.980	24.71	292	158	H	31.20	3.44	32.37	26.97	54.00	-27.03	Ave

Note: Emission was scanned up to 25GHz; no emissions were detected above the noise floor which was at least 20dB below the specification limit

802.11b @ 2462MHz & RFID @ 927.25 MHz @ 3 Meter @ 3 Meter(co-location emission result)

Frequency (GHz)	Reading (dBuV/m)	Direction (degree)	Height (m)	Polarity (H/V)	Antenna Loss (dB)	Cable Loss (dB)	Amplifier (dB)	Corrected Reading (dBuV/m)	15.247/15.209 Limit @ 3m (dBuV/m)	Margin (dBuV/m)	Detector (pk/avg)
1.663	56.64	110	100	V	25.70	2.16	31.98	52.52	74.00	-21.48	Peak
1.663	34.64	110	100	V	25.70	2.16	31.98	30.52	54.00	-23.48	Ave
1.663	54.23	71	102	H	25.70	2.16	31.98	50.11	74.00	-23.89	Peak
1.663	28.86	71	102	H	25.70	2.16	31.98	24.74	54.00	-29.26	Ave
2.778	63.77	160	100	V	28.80	2.72	32.08	63.21	74.00	-10.79	Peak
2.778	53.82	160	100	V	28.80	2.72	32.08	53.26	54.00	-0.74	Ave
2.778	71.21	310	154	H	28.80	2.72	32.08	70.65	74.00	-3.35	Peak
2.778	52.34	310	154	H	28.80	2.72	32.08	51.78	54.00	-2.22	Ave
4.637	51.79	26	100	V	32.20	4.13	32.49	55.62	74.00	-18.38	Peak
4.637	45.67	26	100	V	32.20	4.13	32.49	49.51	54.00	-4.49	Ave
4.637	51.44	45	100	H	32.20	4.13	32.49	55.28	74.00	-18.72	Peak
4.637	48.16	45	100	H	32.20	4.13	32.49	51.99	54.00	-2.01	Ave
2.484	50.29	144	101	V	27.50	2.50	32.04	48.25	74.00	-25.75	Peak
2.484	37.18	189	100	H	27.50	2.50	32.04	35.14	74.00	-38.86	Ave
2.484	50.64	144	101	V	27.50	2.50	32.04	48.60	54.00	-5.40	Peak
2.484	37.25	189	100	H	27.50	2.50	32.04	35.21	54.00	-18.79	Ave

Note: Emission was scanned up to 25GHz; no emissions were detected above the noise floor which was at least 20dB below the specification limit

802.11g @ 2412MHz & RFID @ 902.75 MHz @ 3 Meter(co-location emission result)

Frequency (GHz)	Reading (dBuV/m)	Direction (degree)	Height (m)	Polarity (H/V)	Antenna Loss (dB)	Cable Loss (dB)	Amplifier (dB)	Corrected Reading (dBuV/m)	15.247/15.209 Limit @ 3m (dBuV/m)	Margin (dBuV/m)	Detector (pk/avg)
1.665	57.63	114	103	V	25.70	2.16	31.98	53.51	74.00	-20.50	Peak
1.665	34.91	114	103	V	25.70	2.16	31.98	30.79	54.00	-23.21	Ave
1.665	58.52	107	109	H	25.70	2.16	31.98	54.40	74.00	-19.60	Peak
1.665	33.56	107	109	H	25.70	2.16	31.98	29.44	54.00	-24.56	Ave
1.894	45.12	165	100	V	25.70	2.16	31.98	41.00	74.00	-33.00	Peak
1.894	25.97	165	100	V	25.70	2.16	31.98	21.85	54.00	-32.15	Ave
1.894	46.59	218	100	H	25.70	2.16	31.98	42.47	74.00	-31.53	Peak
1.894	25.83	218	100	H	25.70	2.16	31.98	21.71	54.00	-32.29	Ave
3.218	40.37	176	134	V	30.30	2.94	32.34	41.27	74.00	-32.73	Peak
3.218	26.36	176	134	V	30.30	2.94	32.34	27.26	54.00	-26.74	Ave
3.218	41.14	146	100	H	30.30	2.94	32.34	42.04	74.00	-31.96	Peak
3.218	26.66	146	100	H	30.30	2.94	32.34	27.56	54.00	-26.44	Ave
2.400	56.12	337	100	V	27.50	2.50	32.04	54.08	74.00	-19.92	Peak
2.400	43.82	337	100	V	27.50	2.50	32.04	41.78	54.00	-12.22	Ave
2.400	59.50	115	100	H	27.50	2.50	32.04	57.46	74.00	-16.54	Peak
2.400	45.85	115	100	H	27.50	2.50	32.04	43.81	54.00	-10.19	Ave

Note: Emission was scanned up to 25GHz; no emissions were detected above the noise floor which was at least 20dB below the specification limit

802.11g @ 2437MHz & RFID @ 915.25 MHz@ 3 Meter(co-location emission result)

Frequency (GHz)	Reading (dBuV/m)	Direction (degree)	Height (m)	Polarity (H/V)	Antenna Loss (dB)	Cable Loss (dB)	Amplifier (dB)	Corrected Reading (dBuV/m)	15.247/15.209 Limit @ 3m (dBuV/m)	Margin (dBuV/m)	Detector (pk/avg)
1.453	47.20	101	100	V	24.80	1.82	31.99	41.83	74.00	-32.17	Peak
1.453	28.17	101	100	V	24.80	1.82	31.99	22.80	54.00	-31.20	Ave
1.453	45.39	175	100	H	24.80	1.82	31.99	40.02	74.00	-33.98	Peak
1.453	32.28	175	100	H	24.80	1.82	31.99	26.91	54.00	-27.09	Ave
2.000	50.65	250	100	V	27.50	2.50	32.04	48.61	74.00	-25.39	Peak
2.000	27.01	250	100	V	27.50	2.50	32.04	24.97	54.00	-29.03	Ave
2.000	46.57	118	100	H	27.50	2.50	32.04	44.53	74.00	-29.47	Peak
2.000	26.19	118	100	H	27.50	2.50	32.04	24.15	54.00	-29.85	Ave
3.218	40.37	176	134	V	30.30	2.94	32.34	41.27	74.00	-32.73	Peak
3.218	26.36	176	134	V	30.30	2.94	32.34	27.26	54.00	-26.74	Ave
3.218	41.14	146	100	H	30.30	2.94	32.34	42.04	74.00	-31.96	Peak
3.218	26.66	146	100	H	30.30	2.94	32.34	27.56	54.00	-26.44	Ave

Note: Emission was scanned up to 25GHz; no emissions were detected above the noise floor which was at least 20dB below the specification limit

802.11g @ 2462MHz & RFID @ 927.25 MHz@ 3 Meter @ 3 Meter(co-location emission result)

Frequency (GHz)	Reading (dBuV/m)	Direction (degree)	Height (m)	Polarity (H/V)	Antenna Loss (dB)	Cable Loss (dB)	Amplifier (dB)	Corrected Reading (dBuV/m)	15.247/15.209 Limit @ 3m (dBuV/m)	Margin (dBuV/m)	Detector (pk/avg)
1.375	44.19	113	111	V	24.80	1.82	31.99	38.82	74.00	-35.18	Peak
1.375	26.99	113	111	V	24.80	1.82	31.99	21.62	54.00	-32.38	Ave
1.375	42.73	48	100	H	24.80	1.82	31.99	37.36	74.00	-36.64	Peak
1.375	27.65	48	100	H	24.80	1.82	31.99	22.28	54.00	-31.72	Ave
2.778	65.17	155	117	V	28.80	2.72	32.08	64.61	74.00	-9.39	Peak
2.778	51.86	155	117	V	28.80	2.72	32.08	51.30	54.00	-2.70	Ave
2.778	69.59	315	131	H	28.80	2.72	32.08	69.03	74.00	-4.97	Peak
2.778	52.46	315	131	H	28.80	2.72	32.08	51.90	54.00	-2.10	Ave
3.218	40.37	176	134	V	30.30	2.94	32.34	41.27	74.00	-32.73	Peak
3.218	26.36	176	134	V	30.30	2.94	32.34	27.26	54.00	-26.74	Ave
3.218	41.14	146	100	H	30.30	2.94	32.34	42.04	74.00	-31.96	Peak
3.218	26.66	146	100	H	30.30	2.94	32.34	27.56	54.00	-26.44	Ave
2.484	52.64	337	100	V	27.50	2.50	32.04	50.60	74.00	-23.40	Peak
2.484	40.39	337	100	V	27.50	2.50	32.04	38.35	54.00	-15.65	Ave
2.484	55.71	115	100	H	27.50	2.50	32.04	53.67	74.00	-20.33	Peak
2.484	43.21	115	100	H	27.50	2.50	32.04	41.17	54.00	-12.83	Ave

Note: Emission was scanned up to 25GHz; no emissions were detected above the noise floor which was at least 20dB below the specification limit

9906 with 802.11b/g and RFID module (Rewinder option)

802.11b @ 2412MHz & RFID @ 902.75 MHz@ 3 Meter(co-location emission result)

Frequency (GHz)	Reading (dBuV/m)	Direction (degree)	Height (m)	Polarity (H/V)	Antenna Loss (dB)	Cable Loss (dB)	Amplifier (dB)	Corrected Reading (dBuV/m)	15.247/15.209 Limit @ 3m (dBuV/m)	Margin (dBuV/m)	Detector (pk/avg)
1.806	51.74	203	100	V	25.70	2.16	31.98	47.62	74.00	-26.38	Peak
1.806	28.97	203	100	V	25.70	2.16	31.98	24.85	54.00	-29.15	Ave
1.806	45.32	89	100	H	25.70	2.16	31.98	41.20	74.00	-32.80	Peak
1.806	27.93	89	100	H	25.70	2.16	31.98	23.81	54.00	-30.19	Ave
2.705	55.01	59	100	V	28.80	2.72	32.08	54.45	74.00	-19.55	Peak
2.705	46.76	59	100	V	28.80	2.72	32.08	46.20	54.00	-7.80	Ave
2.705	59.60	58	158	H	28.80	2.72	32.08	59.04	74.00	-14.96	Peak
2.705	52.46	58	158	H	28.80	2.72	32.08	51.90	54.00	-2.10	Ave
4.517	48.17	51	100	V	32.20	4.13	32.49	52.00	74.00	-22.00	Peak
4.517	39.61	51	100	V	32.20	4.13	32.49	43.45	54.00	-10.55	Ave
4.517	50.10	171	100	H	32.20	4.13	32.49	53.93	74.00	-20.07	Peak
4.517	42.74	171	100	H	32.20	4.13	32.49	46.58	54.00	-7.42	Ave
2.400	45.42	94	101	V	27.50	2.50	32.04	43.38	74.00	-30.62	Peak
2.400	28.66	94	101	V	27.50	2.50	32.04	26.62	54.00	-27.38	Ave
2.400	43.74	216	100	H	27.50	2.50	32.04	41.70	74.00	-32.30	Peak
2.400	26.67	216	100	H	27.50	2.50	32.04	24.63	54.00	-29.37	Ave

Note: Emission was scanned up to 25GHz; no emissions were detected above the noise floor which was at least 20dB below the specification limit

802.11b @ 2437MHz & RFID @ 915.25 MHz@ 3 Meter(co-location emission result)

Frequency (GHz)	Reading (dBuV/m)	Direction (degree)	Height (m)	Polarity (H/V)	Antenna Loss (dB)	Cable Loss (dB)	Amplifier (dB)	Corrected Reading (dBuV/m)	15.247/15.209 Limit @ 3m (dBuV/m)	Margin (dBuV/m)	Detector (pk/avg)
1.717	51.06	124	140	V	25.70	2.16	31.98	46.94	74.00	-27.06	Peak
1.717	27.34	124	140	V	25.70	2.16	31.98	23.22	54.00	-30.78	Ave
1.717	46.81	66	100	H	25.70	2.16	31.98	42.69	74.00	-31.31	Peak
1.717	27.57	66	100	H	25.70	2.16	31.98	23.45	54.00	-30.55	Ave
2.000	48.42	337	100	V	27.50	2.50	32.04	46.38	74.00	-27.62	Peak
2.000	26.60	337	100	V	27.50	2.50	32.04	24.56	54.00	-29.44	Ave
2.000	45.78	115	100	H	27.50	2.50	32.04	43.74	74.00	-30.26	Peak
2.000	26.33	115	100	H	27.50	2.50	32.04	24.29	54.00	-29.71	Ave
2.994	48.58	67	100	V	28.80	2.72	32.08	48.02	74.00	-25.98	Peak
2.994	25.76	67	100	V	28.80	2.72	32.08	25.20	54.00	-28.80	Ave
2.994	42.53	88	100	H	28.80	2.72	32.08	41.97	74.00	-32.03	Peak
2.994	25.69	88	100	H	28.80	2.72	32.08	25.13	54.00	-28.87	Ave

Note: Emission was scanned up to 25GHz; no emissions were detected above the noise floor which was at least 20dB below the specification limit

802.11b @ 2462MHz & RFID @ 927.25 MHz @ 3 Meter @ 3 Meter(co-location emission result)

Frequency (GHz)	Reading (dBuV/m)	Direction (degree)	Height (m)	Polarity (H/V)	Antenna Loss (dB)	Cable Loss (dB)	Amplifier (dB)	Corrected Reading (dBuV/m)	15.247/15.209 Limit @ 3m (dBuV/m)	Margin (dBuV/m)	Detector (pk/avg)
1.501	50.05	170	100	V	25.70	2.16	31.98	45.93	74.00	-28.07	Peak
1.501	36.56	170	100	V	25.70	2.16	31.98	32.44	54.00	-21.56	Ave
1.501	47.34	217	100	H	25.70	2.16	31.98	43.22	74.00	-30.78	Peak
1.501	32.09	217	100	H	25.70	2.16	31.98	27.97	54.00	-26.03	Ave
1.625	49.53	96	161	V	25.70	2.16	31.98	45.41	74.00	-28.59	Peak
1.625	29.82	96	161	V	25.70	2.16	31.98	25.70	54.00	-28.30	Ave
1.625	46.82	134	100	H	25.70	2.16	31.98	42.70	74.00	-31.30	Peak
1.625	30.08	134	100	H	25.70	2.16	31.98	25.96	54.00	-28.04	Ave
3.707	41.30	37	106	V	31.20	3.44	32.37	43.56	74.00	-30.44	Peak
3.707	28.49	37	106	V	31.20	3.44	32.37	30.76	54.00	-23.24	Ave
3.707	42.34	206	100	H	31.20	3.44	32.37	44.60	74.00	-29.40	Peak
3.707	31.64	206	100	H	31.20	3.44	32.37	33.90	54.00	-20.10	Ave
2.484	55.76	337	100	V	27.50	2.50	32.04	53.72	74.00	-20.28	Peak
2.484	37.84	337	100	V	27.50	2.50	32.04	35.80	54.00	-18.20	Ave
2.484	53.84	115	100	H	27.50	2.50	32.04	51.80	74.00	-22.20	Peak
2.484	38.41	115	100	H	27.50	2.50	32.04	36.37	54.00	-17.63	Ave

Note: Emission was scanned up to 25GHz; no emissions were detected above the noise floor which was at least 20dB below the specification limit

802.11g @ 2412MHz & RFID @ 902.75 MHz @ 3 Meter(co-location emission result)

Frequency (GHz)	Reading (dBuV/m)	Direction (degree)	Height (m)	Polarity (H/V)	Antenna Loss (dB)	Cable Loss (dB)	Amplifier (dB)	Corrected Reading (dBuV/m)	15.247/15.209 Limit @ 3m (dBuV/m)	Margin (dBuV/m)	Detector (pk/avg)
1.453	46.99	102	100	V	24.80	1.82	31.99	41.62	74.00	-32.38	Peak
1.453	28.65	102	100	V	24.80	1.82	31.99	23.28	54.00	-30.72	Ave
1.453	45.12	172	100	H	24.80	1.82	31.99	39.75	74.00	-34.25	Peak
1.453	31.09	172	100	H	24.80	1.82	31.99	25.72	54.00	-28.28	Ave
1.499	49.43	174	100	V	24.80	1.82	31.99	44.06	74.00	-29.94	Peak
1.499	35.19	174	100	V	24.80	1.82	31.99	29.82	54.00	-24.18	Ave
1.499	47.01	213	100	H	24.80	1.82	31.99	41.64	74.00	-32.36	Peak
1.499	29.94	213	100	H	24.80	1.82	31.99	24.57	54.00	-29.43	Ave
4.830	40.19	201	101	V	32.20	4.13	32.49	44.03	74.00	-29.98	Peak
4.830	27.88	201	101	V	32.20	4.13	32.49	31.72	54.00	-22.28	Ave
4.830	40.78	129	141	H	32.20	4.13	32.49	44.61	74.00	-29.39	Peak
4.830	29.09	129	141	H	32.20	4.13	32.49	32.92	54.00	-21.08	Ave
2.400	57.27	292	158	H	27.50	2.50	32.04	55.23	74.00	-18.77	Peak
2.400	38.41	129	100	V	27.50	2.50	32.04	36.37	54.00	-17.63	Ave
2.400	52.81	63	100	H	27.50	2.50	32.04	50.77	74.00	-23.23	Peak
2.400	40.41	63	100	H	27.50	2.50	32.04	38.37	54.00	-15.63	Ave

Note: Emission was scanned up to 25GHz; no emissions were detected above the noise floor which was at least 20dB below the specification limit

802.11g @ 2437MHz & RFID @ 915.25 MHz@ 3 Meter(co-location emission result)

Frequency (GHz)	Reading (dBuV/m)	Direction (degree)	Height (m)	Polarity (H/V)	Antenna Loss (dB)	Cable Loss (dB)	Amplifier (dB)	Corrected Reading (dBuV/m)	15.247/15.209 Limit @ 3m (dBuV/m)	Margin (dBuV/m)	Detector (pk/avg)
1.663	57.42	183	149	V	25.70	2.16	31.98	53.30	74.00	-20.70	Peak
1.663	32.72	183	149	V	25.70	2.16	31.98	28.60	54.00	-25.40	Ave
1.663	53.46	336	101	H	25.70	2.16	31.98	49.34	74.00	-24.66	Peak
1.663	28.87	336	101	H	25.70	2.16	31.98	24.75	54.00	-29.25	Ave
1.689	53.20	116	100	V	25.70	2.16	31.98	49.08	74.00	-24.92	Peak
1.689	29.28	116	100	V	25.70	2.16	31.98	25.16	54.00	-28.84	Ave
1.689	43.84	340	100	H	25.70	2.16	31.98	39.72	74.00	-34.28	Peak
1.689	27.11	340	100	H	25.70	2.16	31.98	22.99	54.00	-31.01	Ave
3.475	40.38	360	100	V	30.30	2.94	32.34	41.28	74.00	-32.72	Peak
3.475	25.34	360	100	V	30.30	2.94	32.34	26.24	54.00	-27.76	Ave
3.475	41.36	103	100	H	30.30	2.94	32.34	42.26	74.00	-31.74	Peak
3.475	25.34	103	100	H	30.30	2.94	32.34	26.24	54.00	-27.76	Ave

Note: Emission was scanned up to 25GHz; no emissions were detected above the noise floor which was at least 20dB below the specification limit

802.11g @ 2462MHz & RFID @ 927.25 MHz@ 3 Meter @ 3 Meter(co-location emission result)

Frequency (GHz)	Reading (dBuV/m)	Direction (degree)	Height (m)	Polarity (H/V)	Antenna Loss (dB)	Cable Loss (dB)	Amplifier (dB)	Corrected Reading (dBuV/m)	15.247/15.209 Limit @ 3m (dBuV/m)	Margin (dBuV/m)	Detector (pk/avg)
1.665	65.17	109	123	V	25.70	2.16	31.98	61.05	74.00	-12.95	Peak
1.665	36.55	109	123	V	25.70	2.16	31.98	32.43	54.00	-21.57	Ave
1.665	53.51	16	100	H	25.70	2.16	31.98	49.39	74.00	-24.62	Peak
1.665	28.78	16	100	H	25.70	2.16	31.98	24.66	54.00	-29.34	Ave
1.856	47.92	225	200	V	25.70	2.16	31.98	43.80	74.00	-30.20	Peak
1.856	28.65	225	200	V	25.70	2.16	31.98	24.53	54.00	-29.47	Ave
1.856	44.98	184	150	H	25.70	2.16	31.98	40.86	74.00	-33.14	Peak
1.856	33.95	184	150	H	25.70	2.16	31.98	29.83	54.00	-24.17	Ave
4.637	52.86	43	100	V	32.20	4.13	32.49	56.70	74.00	-17.30	Peak
4.637	41.57	43	100	V	32.20	4.13	32.49	45.40	54.00	-8.60	Ave
4.637	53.01	68	148	H	32.20	4.13	32.49	56.85	74.00	-17.15	Peak
4.637	46.20	68	148	H	32.20	4.13	32.49	50.03	54.00	-3.97	Ave
2.484	51.98	177	100	V	27.50	2.50	32.04	49.94	74.00	-24.06	Peak
2.484	40.13	177	100	V	27.50	2.50	32.04	38.09	54.00	-15.91	Ave
2.484	50.87	146	103	H	27.50	2.50	32.04	48.83	74.00	-25.17	Peak
2.484	41.72	146	103	H	27.50	2.50	32.04	39.68	54.00	-14.32	Ave

Note: Emission was scanned up to 25GHz; no emissions were detected above the noise floor which was at least 20dB below the specification limit

Annex A. TEST INSTRUMENT & METHOD

Annex A.i. TEST INSTRUMENTATION & GENERAL PROCEDURES

Instrument	Model	Calibration Due
AC Conducted Emissions		
R&S EMI Test Receiver	ESIB40	05/15/2012
R&S LISN	ESH2-Z5	05/18/2012
CHASE LISN	MN2050B	05/18/2012
Radiated Emissions		
Spectrum Analyzer	8564E	05/17/2012
EMI Receiver	ESIB 40	05/15/2012
R&S LISN	ESH2-Z5	06/02/2012
CHASE LISN	MN2050B	06/01/2012
Antenna(1 ~18GHz)	3115	06/18/2012
Antenna (30MHz~2GHz)	JB1	05/17/2012
Chamber	3m	10/13/2011
Hygro Hermograph	ST-50	06/04/2012
Pre-Amplifier(1 ~ 26GHz)	8449	05/17/2012*
Horn Antenna (18~40GHz)	AH-840	05/17/2012
Microwave Pre-Amp (18~40GHz)	PA-840	05/15/2012

Note: Functional Verification

Annex A.ii. CONDUCTED EMISSIONS TEST DESCRIPTION

Test Set-up

1. The EUT and supporting equipment were set up in accordance with the requirements of the standard on top of a 1.5m x 1m x 0.8m high, non-metallic table, as shown in Annex B.
2. The power supply for the EUT was fed through a 50Ω/50μH EUT LISN, connected to filtered mains.
3. The RF OUT of the EUT LISN was connected to the EMI test receiver via a low-loss coaxial cable.
4. All other supporting equipments were powered separately from another main supply.

Test Method

1. The EUT was switched on and allowed to warm up to its normal operating condition.
2. A scan was made on the NEUTRAL line (for AC mains) or Earth line (for DC power) over the required frequency range using an EMI test receiver.
3. High peaks, relative to the limit line, were then selected.
4. The EMI test receiver was then tuned to the selected frequencies and the necessary measurements made with a receiver bandwidth setting of 10 KHz. For FCC tests, only Quasi-peak measurements were made; while for CISPR/EN tests, both Quasi-peak and Average measurements were made.
5. Steps 2 to 4 were then repeated for the LIVE line (for AC mains) or DC line (for DC power).

Sample Calculation Example

At 20 MHz	limit = 250 μV = 47.96 dBμV
Transducer factor of LISN, pulse limiter & cable loss at 20 MHz = 11.20 dB	
Q-P reading obtained directly from EMI Receiver = 40.00 dBμV (Calibrated for system losses)	
Therefore, Q-P margin = 47.96 – 40.00 = 7.96	i.e. 7.96 dB below limit

Annex A. iii RADIATED EMISSIONS TEST DESCRIPTION

EUT Characterisation

EUT characterisation, over the frequency range from 30MHz to 1GHz (for FCC tests, until the 5th harmonic for operating frequencies \geq 108MHz), was done in order to minimise radiated emissions testing time while still maintaining high confidence in the test results.

The EUT was placed in the chamber, at a height of about 0.8m on a turntable. Its radiated emissions frequency profile was observed, using a spectrum analyzer /receiver with the appropriate broadband antenna placed 3m away from the EUT. Radiated emissions from the EUT were maximised by rotating the turntable manually, changing the antenna polarisation and manipulating the EUT cables while observing the frequency profile on the spectrum analyzer / receiver. Frequency points at which maximum emissions occurred, clock frequencies and operating frequencies were then noted for the formal radiated emissions test at the Open Area Test Site (OATS).

Test Set-up

1. The EUT and supporting equipment were set up in accordance with the requirements of the standard on top of a 1.5m X 1.0m X 0.8m high, non-metallic table as shown in Annex B.
2. The filtered power supply for the EUT and supporting equipment were tapped from the appropriate power sockets located on the turntable.
3. The relevant broadband antenna was set at the required test distance away from the EUT and supporting equipment boundary.

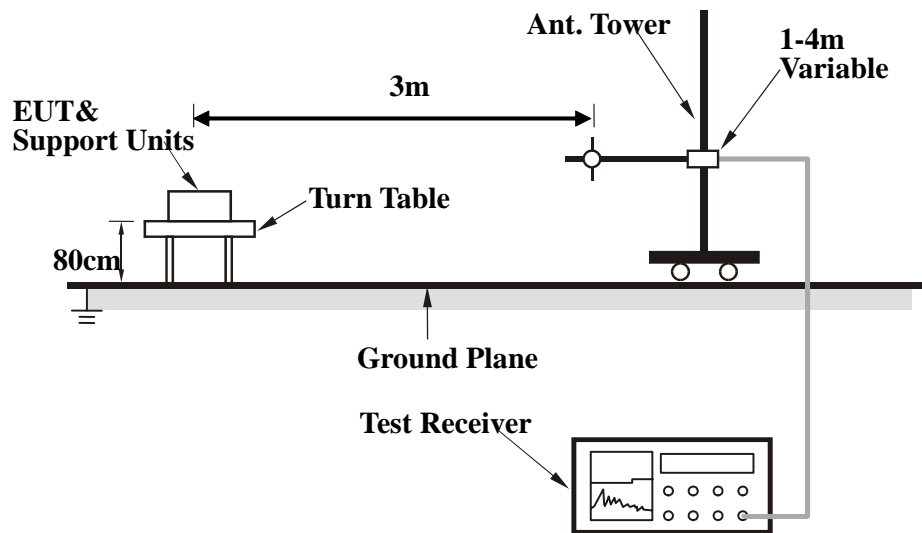

Test Method

The following procedure was performed to determine the maximum emission axis of EUT:

1. With the receiving antenna is H polarization, rotate the EUT in turns with three orthogonal axes to determine the axis of maximum emission.
2. With the receiving antenna is V polarization, rotate the EUT in turns with three orthogonal axes to determine the axis of maximum emission.
3. Compare the results derived from above two steps. So, the axis of maximum emission from EUT was determined and the configuration was used to perform the final measurement.

Final Radiated Emission Measurement

1. Setup the configuration according to figure 1. Turn on EUT and make sure that it is in normal function.
2. For emission frequencies measured below 1 GHz, a pre-scan is performed in a shielded chamber to determine the accurate frequencies of higher emissions will be checked on a open test site. As the same purpose, for emission frequencies measured above 1 GHz, a pre-scan also be performed with a 1 meter measuring distance before final test.
3. For emission frequencies measured below and above 1 GHz, set the spectrum analyzer on a 100 kHz and 1 MHz resolution bandwidth respectively for each frequency measured in step 2.
4. The search antenna is to be raised and lowered over a range from 1 to 4 meters in horizontally polarized orientation. Position the highness when the highest value is indicated on spectrum analyzer, then change the orientation of EUT on test table over a range from 0 ° to 360 ° with a speed as slow as possible, and keep the azimuth that highest emission is indicated on the spectrum analyzer. Vary the antenna position again and record the highest value as a final reading.
5. Repeat step 4 until all frequencies need to be measured were complete.
6. Repeat step 5 with search antenna in vertical polarized orientations.

During the radiated emission test, the Spectrum Analyzer was set with the following configurations:

Frequency Band (MHz)	Function	Resolution bandwidth	Video Bandwidth
30 to 1000	Peak	100 kHz	100 kHz
Above 1000	Peak	1 MHz	1 MHz
	Average	1 MHz	10 Hz

Sample Calculation Example

The field strength is calculated by adding the Antenna Factor and Cable Factor, and subtracting the Amplifier Gain (if any) from the measured reading. For the limit is employed average value, therefore the peak value can be transferred to average value by subtracting the duty factor. The basic equation with a sample calculation is as follows:

$$\text{Peak} = \text{Reading} + \text{Corrected Factor}$$

where

$$\text{Corr. Factor} = \text{Antenna Factor} + \text{Cable Factor} - \text{Amplifier Gain (if any)}$$

And the average value is

$$\text{Average} = \text{Peak Value} + \text{Duty Factor or}$$

$$\text{Set RBW} = 1\text{MHz, VBW} = 10\text{Hz.}$$

Note :

If the measured frequencies are fall in the restricted frequency band, the limit employed must be quasi peak value when frequencies are below or equal to 1 GHz. And the measuring instrument is set to quasi peak detector function.

Annex B EUT AND TEST SETUP PHOTOGRAPHS

Please see the attachment

Annex C. TEST SETUP AND SUPPORTING EQUIPMENT

EUT TEST CONDITIONS

Annex C. i. SUPPORTING EQUIPMENT DESCRIPTION

The following is a description of supporting equipment and details of cables used with the EUT.

Equipment Description (Including Brand Name)	Model & Serial Number	Cable Description (List Length, Type & Purpose)
PC Laptop / DELL	Latitude D600	Serial Cable, <3 meter Ethernet Cable 1, >3 meter USB Cable, <3 meter

Block Configuration Diagram for Radiated Emission

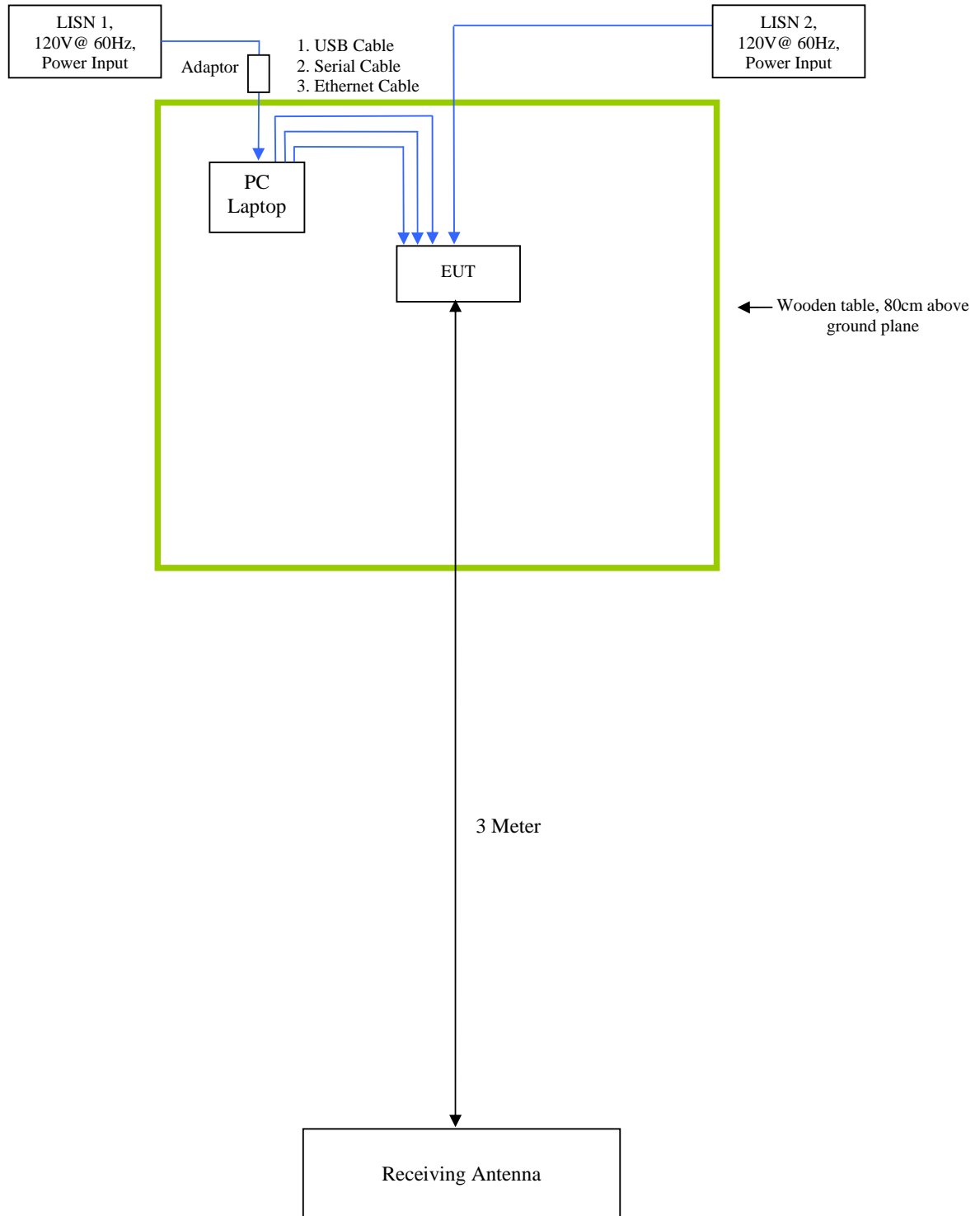

Block Configuration Diagram for Conducted Emission

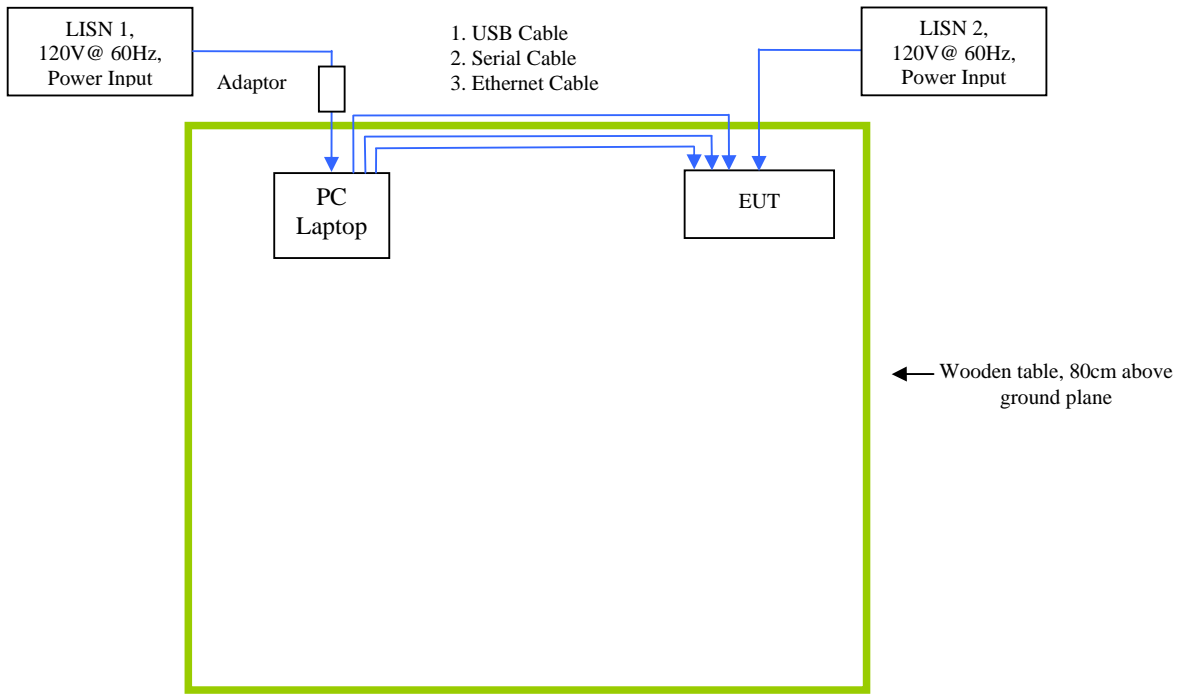

Annex C.ii. EUT OPERATING CONDITIONS

The following is the description of how the EUT is exercised during testing.

Test	Description Of Operation
Emissions Testing	The EUT was controlled via PC Laptop using Monarch Regulatory Utilities TestFCC-TM Test Console Command Program provided by applicant.
Others Testing	The EUT was controlled via PC Laptop using Monarch Regulatory Utilities TestFCC-TM Test Console Command Program provided by applicant.



SIEMIC, INC.

Accessing global markets

Title: RF Test Report of Avery Dennison Retail Information Services LLC
Model : 128921
To FCC 15.247 2010 & RSS-210 Issue 8 : 2010

Serial# SL11031602-AVE-010_9906_FCC (WLAN) Rev1.0
Issue Date May 10th 2011
Page 38 of 55
www.siemic.com

Annex D User Manual, Block Diagram, Circuit Diagram

Please see attachment

Annex E. SIEMIC ACCREDITATION CERTIFICATES

SIEMIC ACREDITATION DETAILS: A2LA Certificate Number: 2742.01





SIEMIC, INC.

Accessing global markets

Title: RF Test Report of Avery Dennison Retail Information Services LLC
Model : 128921
To: FCC 15.247 2010 & RSS-210 Issue 8 : 2010

Serial# SL11031602-AVE-010_9906_FCC (WLAN) Rev1.0
Issue Date May 10th 2011
Page 40 of 55
www.siemic.com



The American Association for Laboratory Accreditation

SCOPE OF ACCREDITATION TO ISO/IEC GUIDE 65:1996

SIEMIC INC.
2206 Ringwood Ave.
San Jose, CA 95131
Mr. Snell Leong (Authorized Representative) Phone: 408 526 1188
www.siemic.com

PRODUCT CERTIFICATION CONFORMITY ASSESSMENT BODY (CAB)

Valid to: September 30, 2012

Certificate Number: 2742.02

In recognition of the successful completion of the A2LA Certification Body Accreditation Program evaluation, including the US Federal Communications Commission (FCC), Industry Canada (IC), Singapore (IDA) and Hong Kong (OFTA) requirements for the indicated types of product certifications, accreditation is granted to this organization to perform the following product certification schemes:

Economy Scope

Federal Communication Commission - (FCC)

Unlicensed Radio Frequency Devices	A1, A2, A3, A4
Licensed Radio Frequency Devices	B1, B2, B3, B4
Telephone Terminal Equipment	C

**Please refer to FCC TCB Program Roles and Responsibilities, released July 22, 2010 detailing scopes, roles and responsibilities. <http://fialloss.fcc.gov/oetcf/kdb/forms/FTSSearchResultPage.cfm?id=44683&switch=P>*

Industry Canada - (IC)

Radio	Scope 1-Licence-Exempt Radio Frequency Devices; Scope 2-Licensed Personal Mobile Radio Services; Scope 3-Licensed General Mobile & Fixed Radio Services; Scope 4-Licensed Maritime & Aviation Radio Services; Scope 5-Licensed Fixed Microwave Radio Services;
-------	--

**Please refer to Industry Canada (IC) website at: <http://www.ic.gc.ca/etic/site/smt-gst-usf/eng/sf02S88.html>*

IDA – Singapore

Line Terminal Equipment	All Technical Specifications for Line Terminal Equipment – Table 1 of IDA MRA Recognition Scheme: 2009, Annex 2
Radio-Communication Equipment	All Technical Specifications for Radio-Communication Equipment – Table 2 of IDA MRA Recognition Scheme: 2009, Annex 2

**Please refer to Info-Communication Development Authority (IDA) Singapore website at: http://www.ida.gov.sg/doc/Policies%20and%20Regulation/Policies_and_Regulation_Level2/20060609145118/MRARecScheme.pdf*

(A2LA Cert. No. 2742.02) 11/23/2010

Page 1 of 2

SIEMIC ACREDITATION DETAILS: FCC Test Site Registration No. 783147

FEDERAL COMMUNICATIONS COMMISSION

**Laboratory Division
7435 Oakland Mills Road
Columbia, MD 21046**

December 20, 2007

Registration Number: 783147

SIEMIC Laboratories
2206 Ringwood Avenue,
San Jose, CA 95131

Attention: Leslie Bai

Re: Measurement facility located at San Jose
3 & 10 meter site
Date of Renewal: December 20, 2007

Dear Sir or Madam:

Your request for renewal of the registration of the subject measurement facility has been received. The information submitted has been placed in your file and the registration has been renewed. The name of your organization will remain on the list of facilities whose measurement data will be accepted in conjunction with applications for Certification under Parts 15 or 18 of the Commission's Rules. Please note that the file must be updated for any changes made to the facility and the registration must be renewed at least every three years.

Measurement facilities that have indicated that they are available to the public to perform measurement services on a fee basis may be found on the FCC website www.fcc.gov under E-Filing, OET Equipment Authorization Electronic Filing, Test Firms.

Sincerely,

Phyllis Parrish
Industry Analyst

SIEMIC ACREDITATION DETAILS: Industry of Canada CAB ID : US0160



UNITED STATES DEPARTMENT OF COMMERCE
National Institute of Standards and Technology
Gaithersburg, Maryland 20899-

March 4, 2009

Mr. Leslie Bai
SIEMIC, Inc.
2206 Ringwood Avenue
San Jose, CA 95131

Dear Mr. Bai:

NIST is pleased to inform you that your laboratory has been recognized by Industry Canada (IC), under the Asia Pacific Economic Cooperation for Telecommunications Equipment Mutual Recognition Arrangement (APEC Tel MRA). Your laboratory is now designated to act as a Conformity Assessment Body (CAB) under Appendix B, **Phase I** Procedures, of the APEC Tel MRA. The pertinent information about your laboratory's designation is as follows:

CAB Name: SIEMIC, Inc.
Physical Location: 2206 Ringwood Avenue, San Jose, CA 95131 USA
Identification No.: US0160
Recognized Scope: CS-03 Part I, II, V, VI, VII and VIII

You may submit test data to IC to verify that the equipment to be imported into Canada satisfies the applicable requirements. The designation of your organization will remain in force as long as its accreditation for the designated scope remains valid and comply with the designation requirements.

Recognized CABs are listed on the NIST website at <http://ts.nist.gov/mra>. Please contact Ms. Ramona Saar at (301) 975-5521 or ramona.saar@nist.gov if you have any questions.

Sincerely,

David F. Alderman
Group Leader, Standards Coordination and Conformity Group
Standards Services Division

Enclosure

cc: CAB Program Manager



SIEMIC, INC.
Accessing global markets

Title: RF Test Report of Avery Dennison Retail Information Services LLC
Model : 128921
To: FCC 15.247 2010 & RSS-210 Issue 8 : 2010

Serial# SL11031602-AVE-010_9906_FCC (WLAN) Rev1.0
Issue Date May 10th 2011
Page 43 of 55
www.siemic.com

SIEMIC ACREDITATION DETAILS: Industry of Canada Test Site Registration No. 4842-1



May 27, 2010

OUR FILE: 46405-4842
Submission No: 140856

Siemic Inc.
2206 Ringwood Ave
San Jose, CA, 95131
USA

Attention: Snell Leong

Dear Sir/Madame:

The Bureau has received your application for the renewal of a 3m alternative test site. Be advised that the information received was satisfactory to Industry Canada. The following number(s) is now associated to the site(s) for which registration / renewal was sought (**4842A-1**). Please reference the appropriate site number in the body of test reports containing measurements performed on the site. In addition, please keep for your records the following information;

- Your primary code is: **4842**
- The company number associated to the site(s) located at the above address is: **4842A**

Furthermore, to obtain or renew a unique site number, the applicant shall demonstrate that the site has been accredited to ANSI C63.4-2003 or later. A scope of accreditation indicating the accreditation by a recognized accreditation body to ANSI C63.4-2003 or later shall be accepted. Please indicate in a letter the previous assigned site number if applicable and the type of site (example: 3 metre OATS or 3 metre chamber). If the test facility is not accredited to ANSI C63.4-2003 or later, the test facility shall submit test data demonstrating full compliance with the ANSI standard. The Bureau will evaluate the filing to determine if recognition shall be granted.

The frequency for re-validation of the test site and the information that is required to be filed or retained by the testing party shall comply with the requirements established by the accrediting organization. However, in all cases, test site re-validation shall occur on an interval not to exceed two years. There is no fee or form associated with an OATS filing. OATS submissions are encouraged to be submitted electronically to the Bureau using the following URL;
http://strategis.ic.gc.ca/epic/internet/inceb-bhst.nsf/en/h_tt00052e.html

If you have any questions, you may contact the Bureau by e-mail at certification_bureau@ic.gc.ca Please reference our file and submission number above for all correspondence.

Yours sincerely,

Dalwinder Gill
For: Wireless Laboratory Manager
Certification and Engineering Bureau
3701 Carling Ave., Building 94
P.O. Box 11490, Station "H"
Ottawa, Ontario K2H 8S2
Email: dalwinder.gill@ic.gc.ca
Tel. No. (613) 998-8363
Fax. No. (613) 990-4752



SIEMIC, INC.

Accessing global markets

Title: RF Test Report of Avery Dennison Retail Information Services LLC
Model : 128921
To: FCC 15.247 2010 & RSS-210 Issue 8 : 2010

Serial# SL11031602-AVE-010_9906_FCC (WLAN) Rev1.0
Issue Date May 10th 2011
Page 44 of 55
www.siemic.com

SIEMIC ACREDITATION DETAILS: FCC DOC CAB Recognition : US1109

FEDERAL COMMUNICATIONS COMMISSION

**Laboratory Division
7435 Oakland Mills Road
Columbia, MD 21046**

August 28, 2008

Siemic Laboratories
2206 Ringwood Ave.,
San Jose, CA 95131

Attention: Leslie Bai

Re: Accreditation of Siemic Laboratories
Designation Number: US1109
Test Firm Registration #: 540430

Dear Sir or Madam:

We have been notified by American Association for Laboratory Accreditation that Siemic Laboratories has been accredited as a Conformity Assessment Body (CAB).

At this time Siemic Laboratories is hereby designated to perform compliance testing on equipment subject to Declaration Of Conformity (DOC) and Certification under Parts 15 and 18 of the Commission's Rules.

This designation will expire upon expiration of the accreditation or notification of withdrawal of designation.

Sincerely,

George Tannahill
Electronics Engineer

SIEMIC ACREDITATION DETAILS: Australia CAB ID : US0160



UNITED STATES DEPARTMENT OF COMMERCE
National Institute of Standards and Technology
Gaithersburg, Maryland 20899

November 20, 2008

Mr. Leslie Bai
SIEMIC, Inc.
2206 Ringwood Avenue
San Jose, CA 95131

Dear Mr. Bai:

NIST is pleased to inform you that your laboratory has been recognized by the Australian Communications and Media Authority (ACMA) under the Asia Pacific Economic Cooperation for Telecommunications Equipment Mutual Recognition Arrangement (APEC Tel MRA). Your laboratory is now designated to act as a Conformity Assessment Body (CAB) under Appendix B, **Phase I** Procedures, of the APEC Tel MRA. The pertinent information about your laboratory's designation is as follows:

CAB Name: Siemic, Inc.
Physical Location: 2206 Ringwood Avenue, San Jose, CA 95131
Identification No.: US0160
Recognized Scope: **EMC:** AS/NZS 4251.1 (until 5/31/2009), AS/NZS 4251.2 (until 5/31/2009), AS/NZS CISPR 11, AS/NZS CISPR 14.1, AS/NZS CISPR 22, AS/NZS 61000.6.3, AS/NZS 61000.6.4
Radiocommunications: AS/NZS 4281, AS/NZS 4268, AS/NZS 4280.1, AS/NZS 4280.2, AS/NZS 4295, AS/NZS 4582, AS/NZS 4583, AS/NZS 4769.1, AS/NZS 4769.2, AS/NZS 4770, AS/NZS 4771
Telecommunications: AS/ACIF S002:05, AS/ACIF S003:06, AS/ACIF S004:06, AS/ACIF S006:01, AS/ACIF S016:01, AS/ACIF S031:01, AS/ACIF S038:01, AS/ACIF S040:01, AS/ACIF S041:05, AS/ACIF S043.2:06, AS/NZS 60950.1

You may submit test data to ACMA to verify that the equipment to be imported into Australia satisfies the applicable requirements. The designation of your organization will remain in force as long as its accreditation for the designated scope remains valid and comply with the designation requirements. Recognized CABs are listed on the NIST website at <http://ts.nist.gov/mra>. Please contact Ms. Ramona Saar, at (301) 975-5521 or ramona.saar@nist.gov if you have questions.

Sincerely,

David F. Alderman
Group Leader, Standards Coordination and Conformity Group
Standards Services Division

Enclosure

cc: Snell Leong, Siemic, Inc.; Ramona Saar, NIST

SIEMIC ACREDITATION DETAILS: Korea CAB ID: US0160



UNITED STATES DEPARTMENT OF COMMERCE
National Institute of Standards and Technology
Gaithersburg, Maryland 20899.

October 1, 2008

Mr. Leslie Bai
SIEMIC, Inc.
2206 Ringwood Avenue
San Jose, CA 95131

Dear Mr. Bai:

NIST is pleased to inform you that your laboratory has been recognized by the Radio Research Agency (RRA) Korea Communications Commission (KCC) under the Asia Pacific Economic Cooperation for Telecommunications Equipment Mutual Recognition Arrangement (APEC Tel MRA). Your laboratory is now designated to act as a Conformity Assessment Body (CAB) under Appendix B, **Phase I** Procedures, of the APEC Tel MRA. The pertinent information about your laboratory's designation is as follows:

CAB Name: SIEMIC, Inc.
Physical Location: 2206 Ringwood Avenue, San Jose, CA 95131
Identification No.: US0160
Recognized Scope: **EMI:** KCC Notice 2008-39, RRL Notice 2008-3: CA Procedures for EMI
KN22: Test Method for EMI
EMS: KCC Notice 2008-38, RRL Notice 2008-4: CA Procedures for EMS
KN24, KN-61000-4-2, -4-3, -4-4, -4-5, -4-6, -4-8, -4-11: Test Method for EMS
Wireless: RRL Notice 2008-26, RRL Notice 2008-2, RRL Notice 2008-10,
RRL Notice 2007-49, RRL Notice 2007-20, RRL Notice 2007-21,
RRL Notice 2007-80, RRL Notice 2004-68
Wired: President Notice 20664, RRL Notice 2007-30,
RRL Notice 2008-7 with attachments 1, 3, 5, 6
President Notice 20664, RRL Notice 2008-7 with attachment 4

You may submit test data to RRA/KCC to verify that the equipment to be imported into Korea satisfies the applicable requirements. The designation of your organization will remain in force as long as its accreditation for the designated scope remains valid and comply with the designation requirements.

Recognized CABs are listed on the NIST website at <http://ts.nist.gov/mra>. If you have any questions please contact Ramona Saar at (301) 975-5521 or ramona.saar@nist.gov.

Sincerely,

David F. Alderman
Group Leader, Standards Coordination and Conformity Group
Standards Services Division

Enclosure

cc: Ramona Saar





SIEMIC, INC.

Accessing global markets

Title: RF Test Report of Avery Dennison Retail Information Services LLC
Model : 128921
To: FCC 15.247 2010 & RSS-210 Issue 8 : 2010

Serial# SL11031602-AVE-010_9906_FCC (WLAN) Rev1.0
Issue Date May 10th 2011
Page 47 of 55
www.sieminc.com

SIEMIC ACREDITATION DETAILS: Taiwan BSMI Accreditation No. SL2-IN-E-1130R



UNITED STATES DEPARTMENT OF COMMERCE
National Institute of Standards and Technology
Gaithersburg, Maryland 20899

May 3, 2006

Mr. Leslie Bai
SIEMIC Laboratories
2206 Ringwood Avenue
San Jose, CA 95131

Dear Mr. Bai:

I am pleased to inform you that your laboratory has been recognized by the Chinese Taipei's Bureau of Standards, Metrology, and Inspection (BSMI) under the Asia Pacific Economic Cooperation (APEC) Mutual Recognition Arrangement (MRA). Your laboratory is now designated to act as a Conformity Assessment Body (CAB) under Appendix B, **Phase I** Procedures, of the APEC Tel MRA. You may submit test data to BSMI to verify that the equipment to be imported into Chinese Taipei satisfies the applicable requirements. The designation of your organization will remain in force as long as its accreditation for the designated scope remains valid and comply with the designation requirements. The pertinent designation information is as follows:

- BSMI number: **SL2-IN-E-1130R** (Must be applied to the test reports)
- U.S. Identification No: **US0160**
- Scope of Designation: **CNS 13438**
- Authorized signatory: **Mr. Leslie Bai**

The names of all recognized CABs will be posted on the NIST website at <http://ts.nist.gov/mra>. If you have any questions, please contact Mr. Dhillon at 301-975-5521. We appreciate your continued interest in our international conformity assessment activities.

Sincerely,

David F. Alderman
Group Leader, Standards Coordination and Conformity Group

cc: Jogindar Dhillon

NIST

SIEMIC ACREDITATION DETAILS: Taiwan NCC CAB ID: US0160



UNITED STATES DEPARTMENT OF COMMERCE
National Institute of Standards and Technology
Gaithersburg, Maryland 20899

November 25, 2008

Mr. Leslie Bai
SIEMIC, Inc.
2206 Ringwood Avenue
San Jose, CA 95131

Dear Mr. Bai:

NIST is pleased to inform you that your laboratory has been recognized by the National Communications Commission (NCC) for the requested scope expansion under the Asia Pacific Economic Cooperation for Telecommunications Equipment Mutual Recognition Arrangement (APEC Tel MRA). Your laboratory is designated to act as a Conformity Assessment Body (CAB) under Appendix B, **Phase I** Procedures, of the APEC Tel MRA. The pertinent information about your laboratory's designation is as follows:

CAB Name: SIEMIC, Inc.
Physical Location: 2206 Ringwood Avenue, San Jose, CA 95131
Identification No.: US0160
Current Scope: LP0002
Additional Scope: PSTN01, ADSL01, ID0002, IS6100 and CNS 14336

You may submit test data to NCC to verify that the equipment to be imported into China satisfies the applicable requirements. The designation of your organization will remain in force as long as its accreditation for the designated scope remains valid and comply with the designation requirements.

Recognized CABs are listed on the NIST website at <http://ts.nist.gov/mra>. If you have any questions please contact Ramona Saar at (301) 975-5521 or ramona.saar@nist.gov.

Sincerely,

David F. Alderman
Group Leader, Standards Coordination and Conformity Group
Standards Services Division

Enclosure

cc: Ramona Saar

NIST



SIEMIC, INC.

Accessing global markets

Title: RF Test Report of Avery Dennison Retail Information Services LLC
Model : 128921
To: FCC 15.247 2010 & RSS-210 Issue 8 : 2010

Serial# SL11031602-AVE-010_9906_FCC (WLAN) Rev1.0
Issue Date May 10th 2011
Page 49 of 55
www.siemic.com

SIEMIC ACREDITATION DETAILS: Mexico NOM Recognition



CAMARA NACIONAL
DE LA INDUSTRIA
ELECTRONICA, DE
TELECOMUNICACIONES
E INFORMATICA

Laboratorio Valentín V. Rivero

México D.F. a 16 de octubre de 2006.

**LESLIE BAI
DIRECTOR OF CERTIFICATION
SIEMIC LABORATORIES, INC.
ACCESSING GLOBAL MARKETS
P R E S E N T E**

En contestación a su escrito de fecha 5 de septiembre del año en curso, le comento que estamos muy interesados en su intención de firmar un Acuerdo de Reconocimiento Mutuo, para lo cual adjunto a este escrito encontrara el Acuerdo en idioma inglés y español prellenado de los cuales le pido sea revisado y en su caso corregido, para que si esta de acuerdo poder firmarlo para mandarlo con las autoridades Mexicanas para su visto bueno y así poder ejercer dicho acuerdo.

Aprovecho este escrito para mencionarle que nuestro intermediario gestor será la empresa Isabel de México, S. A. de C. V., empresa que ha colaborado durante mucho tiempo con nosotros en lo relacionado a la evaluación de la conformidad y que cuenta con amplia experiencia en la gestoría de la certificación de cumplimiento con Normas Oficiales Mexicanas de producto en México.

Me despido de usted enviándole un cordial saludo y esperando sus comentarios al Acuerdo que nos ocupa.

Atentamente:

**Ing. Faustino Gómez González
Gerente Técnico del Laboratorio de
CANIETI.**

Callejón 71
Hidrotro Camteca
08100 Mérida, D.F.
Tel. 5264 6036 con 12 líneas
Fax 5264 6488
www.canieti.org

SIEMIC ACREDITATION DETAILS: Hong Kong OFTA CAB ID : US0160



UNITED STATES DEPARTMENT OF COMMERCE
National Institute of Standards and Technology
Gaithersburg, Maryland 20899

December 8, 2008

Mr. Leslie Bai
SIEMIC, Inc.
2206 Ringwood Avenue
San Jose, CA 95131

Dear Mr. Bai:

NIST is pleased to inform you that your laboratory has been recognized by the Office of the Telecommunications Authority (OFTA) under the Asia Pacific Economic Cooperation for Telecommunications Equipment Mutual Recognition Arrangement (APEC Tel MRA). Your laboratory is now designated to act as a Conformity Assessment Body (CAB) under Appendix B, **Phase I** Procedures, of the APEC Tel MRA. The pertinent information about your laboratory's designation is as follows:

CAB Name: SIEMIC, Inc.
Physical Location: 2206 Ringwood Avenue, San Jose, California 95131 USA
Identification No.: US0160
Recognized Scope: **Radio:** HKTA 1002, 1007, 1008, 1010, 1015, 1016, 1020, 1022, 1026, 1027, 1029, 1030, 1031, 1032, 1033, 1034, 1035, 1036, 1037, 1039, 1041, 1042, 1043, 1044, 1046, 1047, 1048, 1049, 1051
Telecom: HKTA 2011, 2012, 2013, 2014, 2017, 2018, 2022, 2024, 2026, 2027, 2028, 2029, 2030, 2031, 2032, 2033

You may submit test data to OFTA to verify that the equipment to be imported into Hong Kong satisfies the applicable requirements. The designation of your organization will remain in force as long as its accreditation for the designated scope remains valid and comply with the designation requirements.

Recognized CABs are listed on the NIST website at <http://ts.nist.gov/mra>. If you have any questions please contact Ramona Saar at (301) 975-5521 or ramona.saar@nist.gov.

Sincerely,

David F. Alderman
Group Leader, Standards Coordination and Conformity Group
Standards Services Division

Enclosure

cc: Ramona Saar

NIST

SIEMIC ACREDITATION DETAILS: Australia ACMA CAB ID: US0160



UNITED STATES DEPARTMENT OF COMMERCE
National Institute of Standards and Technology
Gaithersburg, Maryland 20899

November 20, 2008

Mr. Leslie Bai
SIEMIC, Inc.
2206 Ringwood Avenue
San Jose, CA 95131

Dear Mr. Bai:

NIST is pleased to inform you that your laboratory has been recognized by the Australian Communications and Media Authority (ACMA) under the Asia Pacific Economic Cooperation for Telecommunications Equipment Mutual Recognition Arrangement (APEC Tel MRA). Your laboratory is now designated to act as a Conformity Assessment Body (CAB) under Appendix B, **Phase I** Procedures, of the APEC Tel MRA. The pertinent information about your laboratory's designation is as follows:

CAB Name: Siemic, Inc.
Physical Location: 2206 Ringwood Avenue, San Jose, CA 95131
Identification No.: US0160
Recognized Scope: EMC: AS/NZS 4251.1 (until 5/31/2009), AS/NZS 4251.2 (until 5/31/2009), AS/NZS CISPR 11, AS/NZS CISPR 14.1, AS/NZS CISPR 22, AS/NZS 61000.6.3, AS/NZS 61000.6.4
Radiocommunications: AS/NZS 4281, AS/NZS 4268, AS/NZS 4280.1, AS/NZS 4280.2, AS/NZS 4295, AS/NZS 4582, AS/NZS 4583, AS/NZS 4769.1, AS/NZS 4769.2, AS/NZS 4770, AS/NZS 4771
Telecommunications: AS/ACIF S002:05, AS/ACIF S003:06, AS/ACIF S004:06, AS/ACIF S006:01, AS/ACIF S016:01, AS/ACIF S031:01, AS/ACIF S038:01, AS/ACIF S040:01, AS/ACIF S041:05, AS/ACIF S043.2:06, AS/NZS 60950.1

You may submit test data to ACMA to verify that the equipment to be imported into Australia satisfies the applicable requirements. The designation of your organization will remain in force as long as its accreditation for the designated scope remains valid and comply with the designation requirements. Recognized CABs are listed on the NIST website at <http://ts.nist.gov/mra>. Please contact Ms. Ramona Saar, at (301) 975-5521 or ramona.saar@nist.gov if you have questions.

Sincerely,

David F. Alderman
Group Leader, Standards Coordination and Conformity Group
Standards Services Division

Enclosure

cc: Snell Leong, Siemic, Inc.; Ramona Saar, NIST

NIST

SIEMIC ACREDITATION DETAILS: Australia NATA Recognition



Leslie Bai
SIEMIC, Inc.
2206 Ringwood Avenue
San Jose, CA 95131

November 4, 2008

Under Australian government legislation, the Australian Communications and Media Authority (ACMA) has determined the National Association of Testing Authorities, Australia (NATA) as an accreditation body as per Section 409(1) of the Telecommunications Act 1997 (Cth). Pursuant to Section 409(2) of the Telecommunications Act 1997 (Cth), I am pleased to advise that your laboratory has been determined as a Recognised Testing Authority (RTA).

This determination has been made on the basis of your accreditation by A2LA accreditation no. 2742.01 and the Mutual Recognition Agreement between NATA and A2LA. It is effective from 11 July 2008. RTA status applies only to the following standards and is contingent upon their continued inclusion in your laboratory's scope of accreditation.

**AS/ACIF S002, AS/ACIF S003, AS/ACIF S004,
AS/ACIF S006, AS/ACIF S016, AS/ACIF S031,
AS/ACIF S038, AS/ACIF S041 and
AS/ACIF S043.2**

As an RTA, your laboratory has the following obligations:

1. the laboratory shall continue to meet all of the accreditation criteria of A2LA;
2. the authorised representative of the laboratory shall notify NATA of changes to the staff or operations of the laboratory which would affect the performance of the tests for which the laboratory has been determined;
3. compliance of equipment shall be reported on test reports bearing the A2LA logo/endorsement.

Current information on the Australian Communications and Media Authority and regulatory requirements for telecommunications products within Australia can be obtained from the ACMA's web-site at "<http://www.acma.gov.au>". Further information about NATA may be gained by visiting "<http://www.nata.asn.au>".

Please note that AS/ACIF S040 and New Zealand standards do not form part of the RTA scheme.

Your RTA listing will appear on the NATA website shortly.

Kind Regards

Chris Norton,
Senior Scientific Officer
Measurement Science and Technology
National Association of Testing Authorities (NATA)
71-73 Flemington Road
North Melbourne Vic 3051
Australia
Ph: +61 3 9329 1633 Fx: +61 3 9326 5148
E-Mail: Christopher.Norton@nata.asn.au
Internet: www.nata.asn.au



SIEMIC, INC.

Accessing global markets

Title: RF Test Report of Avery Dennison Retail Information Services LLC
Model : 128921
To: FCC 15.247 2010 & RSS-210 Issue 8 : 2010

Serial# SL11031602-AVE-010_9906_FCC (WLAN) Rev1.0
Issue Date May 10th 2011
Page 54 of 55
www.siemic.com

SIEMIC ACREDITATION DETAILS: VCCI Conducted (Main Port) Test Site Registration No. C-3421

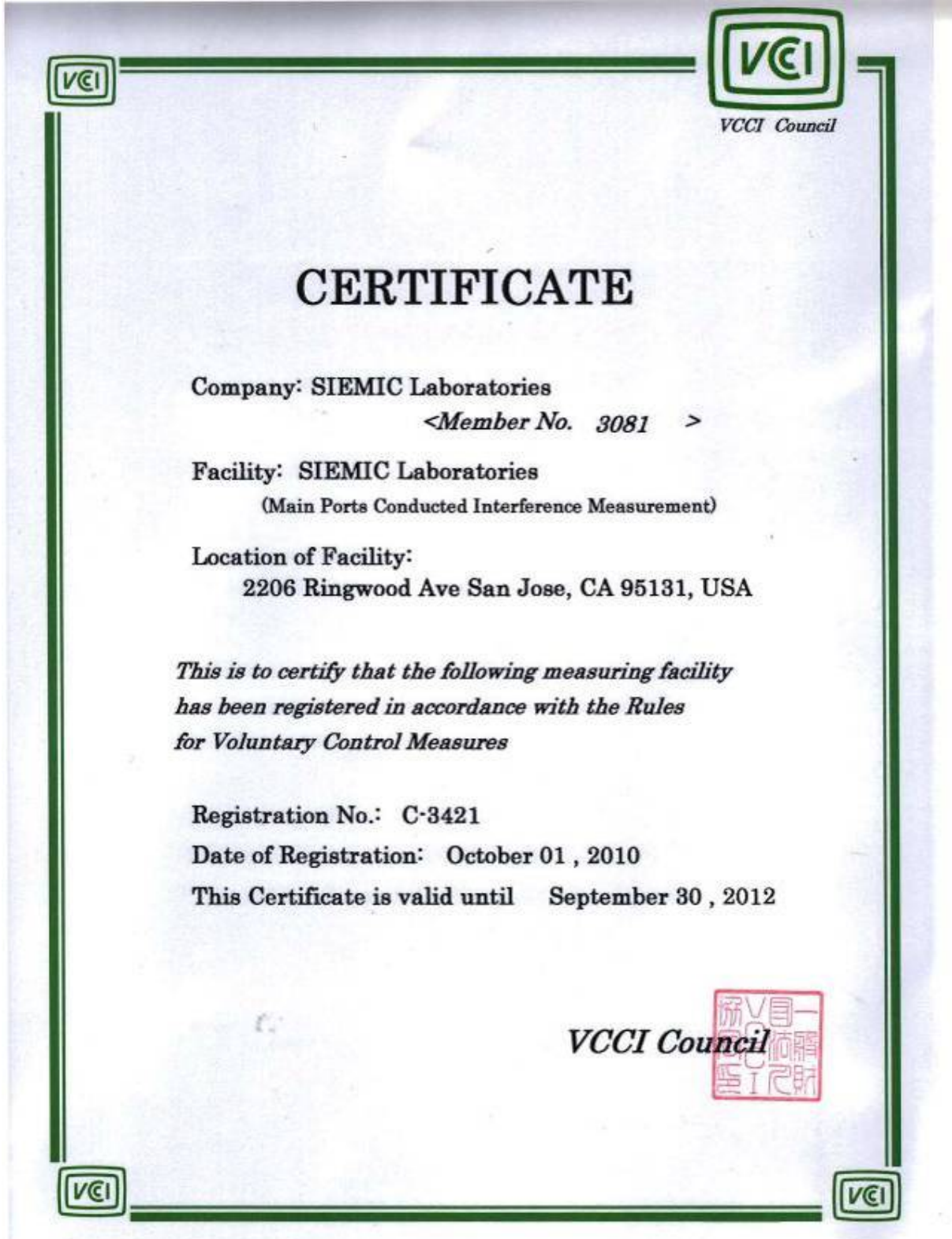

VCCI Council

CERTIFICATE

Company: SIEMIC Laboratories
<Member No. 3081 >

Facility: SIEMIC Laboratories
(Main Ports Conducted Interference Measurement)

Location of Facility:
2206 Ringwood Ave San Jose, CA 95131, USA

*This is to certify that the following measuring facility
has been registered in accordance with the Rules
for Voluntary Control Measures*

Registration No.: C-3421
Date of Registration: October 01 , 2010
This Certificate is valid until September 30 , 2012

VCCI Council





SIEMIC, INC.

Accessing global markets

Title: RF Test Report of Avery Dennison Retail Information Services LLC
Model : 128921
To: FCC 15.247 2010 & RSS-210 Issue 8 : 2010

Serial# SL11031602-AVE-010_9906_FCC (WLAN) Rev1.0
Issue Date May 10th 2011
Page 55 of 55
www.siemic.com

SIEMIC ACREDITATION DETAILS: VCCI Conducted (Telecom Port) Test Site Registration No. T-1597

 
VCCI Council

CERTIFICATE

Company: SIEMIC Laboratories
<Member No. 3081 >

Facility: SIEMIC Laboratories
(Telecommunication Ports Conducted Disturbance Measurement)

Location of Facility:
2206 Ringwood Ave San Jose, CA 95131, USA

*This is to certify that the following measuring facility
has been registered in accordance with the Rules
for Voluntary Control Measures*

Registration No.: T-1597
Date of Registration: October 01 , 2010
This Certificate is valid until September 30 , 2012

VCCI Council