



SAR EVALUATION REPORT

Equipment under test Mobile Printer

Model name 9485NP

FCC ID GU6-QUATECH1

Applicant Avery Dennison Retail Information Service LLC

Manufacturer SEWOO TECH CO., LTD.

Date of test(s) 2014.12.18 ~ 2014.12.18

Date of issue 2014.12.26

Issued to

Avery Dennison Retail Information Services LLC

170 Monarch Lane, Miamisburg,
 OH 45342, United States

Tel.: +1-937-865-2020 / Fax.: +1-937-865-2048



Issued by

KES Co., Ltd.

C-3701, Simin-daero 365-40, Dongan-gu, Anyang-si,
 Gyeonggi-do, 431-716, Korea

473-29, Gayeo-ro, Yeosu-si, Gyeonggi-do, Korea

Tel.: +82-31-425-6200 / Fax: +82-31-424-0450

Test and report completed by :	Report approval by :
	
Kwang-Yeol Choo Test engineer	Jeff Do Technical manager

This report shall not be reproduced except in full, without the written approval of KES Co., Ltd.
 The test results in the report only apply to the tested sample.



Revision history

Revision	Date of issue	Test report No.	Description
-	2014.12.26	KES-SR-14T0013	Initial

This report shall not be reproduced except in full, without the written approval of KES Co., Ltd.
The test results in the report only apply to the tested sample.

TABLE OF CONTENTS

1.	General information	4
1.1.	EUT description	4
1.2.	Information about derivative model	4
1.3.	Highest SAR summary	4
1.4.	Tune-up limits	5
1.5.	Guidance applied	6
1.6.	Test conditions	6
1.7.	SAR definition	6
1.8.	EUT antenna location	7
1.9.	SAR test exclusion applied	8
1.10.	Description of the Body setup	9
1.10.1.	Procedure for SAR testing	9
1.10.1.	Test mode	9
2.	SAR measurement system	10
2.1.	Robot	11
2.2.	Probe	11
2.3.	Data Acquisition Electronics (DAE)	12
2.4.	Phantoms	12
2.5.	Device holder	13
3.	SAR measurement procedure	14
4.	Tissue simulating liquids	16
5.	System verification and validation	17
5.1.	Procedure	17
5.2.	System verification	17
5.3.	System validation	18
6.	RF exposure limits	19
7.	Test results summary	20
7.1.	RF conducted power	20
7.1.1.	Power measurement procedures	20
7.1.2.	RF conducted power	20
7.2.	SAR results	21
7.2.1.	Measured and reported SAR	21
7.2.2.	WLAN 2.4 GHz band	22
8.	Measurement equipments	23
9.	Measurement Uncertainty	24
10.	Setup photo	25
	Appendix list	26
	Appendix A. DASY4 report	26
	Appendix B. Calibration certificate	26

1. General information

1.1. EUT description

Equipment under test	Mobile Printer
Model name	9485NP
Serial number	N/A
Frequency range	2 412 MHz ~ 2 462 MHz: 11 channel (802.11 b/g) 5 180 MHz ~ 5 240 MHz: 4 channel (11a_Non DFS) 5 260 MHz ~ 5 320 MHz: 4 channel (11a_DFS) 5 500 MHz ~ 5 700 MHz: 11 channel (11a_DFS) 5 745 MHz ~ 5 825 MHz: 5 channel (11a/n_HT20_Non DFS)
Body worn accessory	None
Antenna type & gain	Type : PCB antenna(I-PEX) Gain : 3.8 dBi(2.45 GHz), 4.7 dBi(4.9 GHz), 5.1 dBi(5.25 GHz), 4.5 dBi(5.875 GHz),
Power source	Battery (DC 7.4V)
Note	-

Notes:

1. Duty cycle is > 98 %.

1.2. Information about derivative model

- N/A

1.3. Highest SAR summary

Equipment class	Frequency band	Tissue type	Reported SAR value 1g-SAR (W/kg)
UNII	WLAN 5.6 GHz band	Body	0.084
Simultaneous transmission SAR per KDB 690783 D01v01r03			N/A

Notes:

1. This device is in compliance with Specific Absorption Rate (SAR) for general population/uncontrolled exposure limits (1.6 W/kg) specified in FCC 47 CFR part 2 (2.1093) and ANSI/IEEE C95.1-1992, and had been tested in accordance with the measurement methods and procedures specified in IEEE 1528-2003.

1.4. Tune-up limits

Band	Mode	Bandwidth (MHz)	Channel	Frequency (MHz)	Tune-up limits (dBm)
2.4 GHz	802.11b	20	1	2 412	15.50
			6	2 437	15.80
			11	2 462	15.10
	802.11g	20	1	2 412	9.33
			6	2 437	9.10
			11	2 462	9.30
5.2 GHz	802.11a	20	36	5 180	7.90
			40	5 200	7.90
			44	5 220	7.90
			48	5 240	7.90
5.3 GHz	802.11a	20	52	5 260	7.20
			56	5 280	7.20
			60	5 300	6.90
			64	5 320	7.60
5.6 GHz	802.11a	20	100	5 500	11.80
			104	5 520	12.60
			108	5 540	13.50
			112	5 560	13.70
			116	5 580	14.60
			120	5 600	15.40
			124	5 620	15.20
			128	5 640	15.40
			132	5 660	14.90
			136	5 680	14.80
5.8 GHz	802.11a	20	149	5 745	11.00
			153	5 765	11.00
			157	5 785	11.40
			161	5 805	11.30
			165	5 825	10.80

Note:

1. The device operates using the following maximum output power specifications. The reported SAR is measured SAR value adjusted for maximum output power tolerance.
2. Tune up tolerance is ± 1.0 dB.

1.5. Guidance applied

- FCC KDB Publication 865664 D01 v01r03- D02 v01r01 (SAR measurement up to 6 GHz)
- FCC KDB Publication 447498 D01 v05r02 (General SAR guidance)
- FCC KDB Publication 248227 D01 v01r02 (SAR considerations for 802.11 devices)
- FCC KDB Publication 865664 D02v01r01 (SAR reporting)

1.6. Test conditions

Ambient temperature	(22 ± 2) °C
Tissue simulating liquid	(22 ± 2) °C
Humidity	(55 ± 5) % R.H.

1.7. SAR definition

Specific Absorption Rate is defined as the time derivative (rate) of the incremental energy (dU) absorbed by (dissipated in) an incremental mass (dm) contained in a volume element (dV) of a given density (ρ). It is also defined as the rate of RF energy absorption per unit mass at a point in an absorbing body (see Figure 1).

$$SAR = \frac{d}{dt} \left(\frac{dU}{dm} \right) = \frac{d}{dt} \left(\frac{dU}{\rho dV} \right)$$

Figure 1. SAR Mathematical equation

SAR is expressed in units of Watts per Kilogram(W/kg)

$$SAR = \frac{\sigma E^2}{\rho}$$

Where:

- σ = Conductivity of the tissue-simulating material (S/m)
- ρ = Mass density of the tissue-simulating material (kg/m³)
- E = Total RMS electric field strength (V/m)

NOTE:

The primary factors that control rate of energy absorption were found to be the wavelength of the incident field in relations to the dimensions and geometry of the irradiated organism, the orientation of the organism in relation to the polarity of field vectors, the presence of reflecting surfaces, and whether conductive contact is made by the organism with a ground plane.

1.8. EUT antenna location

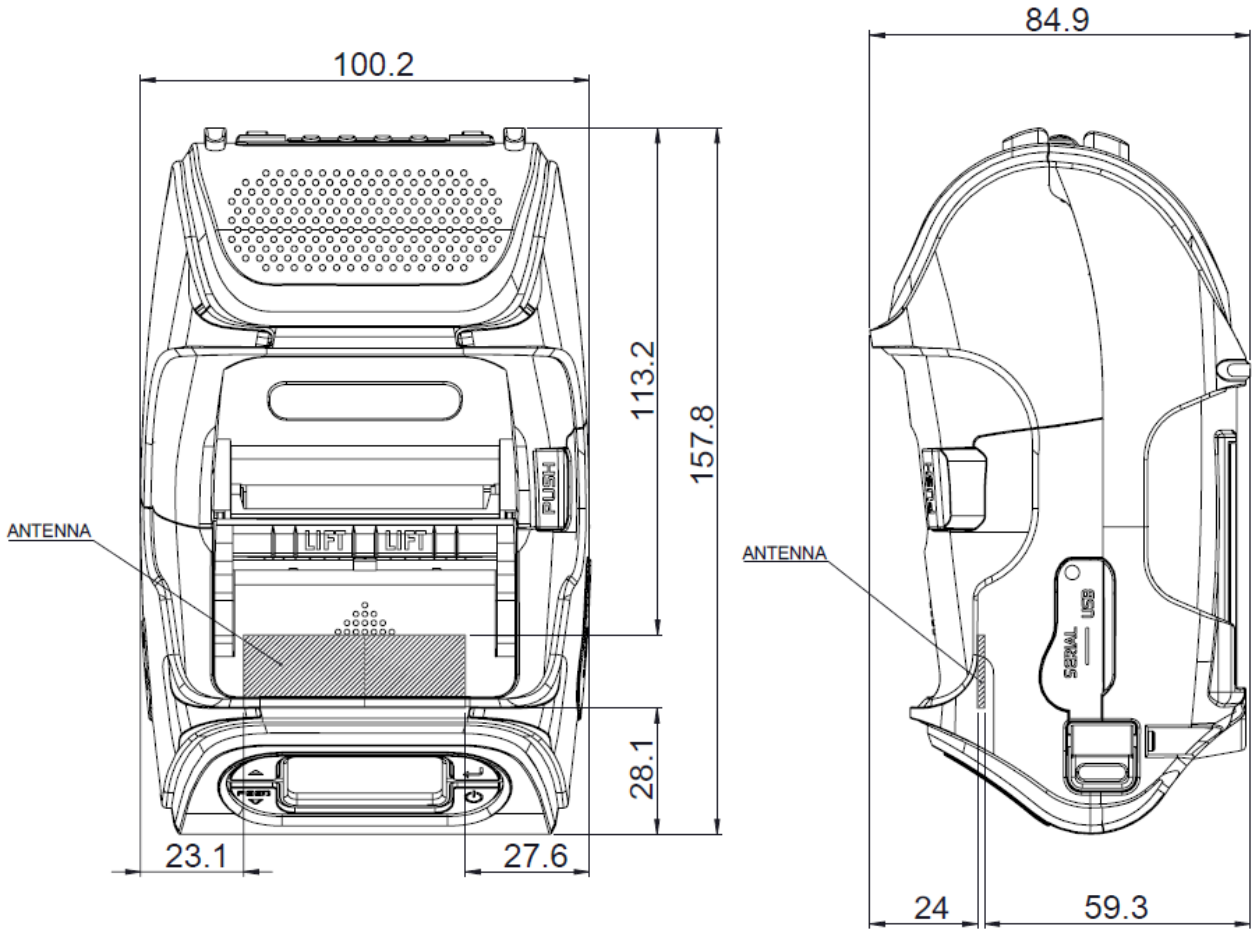

This report shall not be reproduced except in full, without the written approval of KES Co., Ltd.
The test results in the report only apply to the tested sample.

1.9. SAR test exclusion applied

Per FCC KDB 447498 D01v05, the SAR exclusion threshold for distances < 50mm is defined by the following equation:

$$\frac{\text{Max Power of Channel (mW)}}{\text{Test Separation Distance (mm)}} * \sqrt{\text{Frequency(GHz)}} \leq 3.0$$

Per FCC KDB 447498 D01v05, At 100 MHz to 6 GHz and for test separation distances > 50 mm, the SAR test exclusion threshold is determined according to the following

$$[(\text{Threshold at 50 mm in step 1}) + (\text{test separation distance} - 50 \text{ mm}) * 10] \text{ mW}$$

at > 1500 MHz and ≤ 6 GHz

Based on the maximum tune-up tolerance limit of WLAN the antenna to use separation distance Table “EXEMPT” SAR was not required and Table “Measure” SAR was is required.

Antenna	Tx	Frequency (MHz)	Output power ^{Note 2, 4}		Separation distances (mm) ^{Note 1 and 4}						SAR Exemption ^{Note 3 and 4}					
			dBm	mW	Front	Rear	Right side	Left side	Top side	Bottom side	Front	Rear	Right side	Left side	Top side	Bottom side
WiFi - Antenna																
802.11b 2.4 GHz	WiFi	2462	15.80	38.00	24.00	59.3	27.6	23.10	113.20	28.10	2.48 EXEMPT	189mW EXEMPT	2.13 EXEMPT	2.59 EXEMPT	728mW EXEMPT	2.13 EXEMPT
802.11g 2.4 GHz		2462	9.30	9.00	24.00	59.3	27.6	23.10	113.20	28.10	0.59 EXEMPT	189mW EXEMPT	0.50 EXEMPT	0.61 EXEMPT	728mW EXEMPT	0.50 EXEMPT
802.11a 5.2 GHz		5260	7.90	6.00	24.00	59.3	27.6	23.10	113.20	28.10	0.57 EXEMPT	158mW EXEMPT	0.49 EXEMPT	0.60 EXEMPT	697mW EXEMPT	0.49 EXEMPT
802.11a 5.3 GHz		5320	7.60	6.00	24.00	59.3	27.6	23.10	113.20	28.10	0.58 EXEMPT	158mW EXEMPT	0.49 EXEMPT	0.60 EXEMPT	697mW EXEMPT	0.49 EXEMPT
802.11a 5.5 GHz		5700	15.40	35.00	24.00	59.3	27.6	23.10	113.20	28.10	3.48 Measure	156mW EXEMPT	2.98 EXEMPT	3.63 Measure	695mW EXEMPT	2.98 EXEMPT
802.11a 5.8 GHz		5825	11.40	14.00	24.00	59.3	27.6	23.10	113.20	28.10	1.41 EXEMPT	155mW EXEMPT	1.21 EXEMPT	1.47 EXEMPT	694mW EXEMPT	1.21 EXEMPT

Note :

- For distances < 5mm, a distance of 5mm is used to determine SAR exclusion and estimated SAR value.
- Output power is the maximum rated power(+/- 1dB) (including tune-up or manufacturing tolerances).
- If the antenna separation distance is > 50mm then the value listed is the output power threshold, above which SAR measurement is required. For separation ≤ 50mm the value is the KDB 447498 calculated value and must be less than 3 for SAR exemption.
- Formulas round separation distance to nearest mm and power to nearest mW before calculating thresholds or exemption values.

1.10. Description of the Body setup

1.10.1. Procedure for SAR testing

- The tested procedure was performed according to the KDB447498 D01(Mobile and portable device RF Exposure Procedures and Equipment authorization policies)

1.10.1. Test mode

WLAN – Data transmission mode(11a_5.6 GHz)

No.	Position	Test distance (mm)	WLAN		
			Tested	Antenna	Separation from user(mm)
1	Front	0	<input checked="" type="checkbox"/>	Fixed	24.0
2	Rear	0	<input type="checkbox"/>	Fixed	59.3
3	Right side	0	<input type="checkbox"/>	Fixed	27.6
4	Left side	0	<input checked="" type="checkbox"/>	Fixed	23.1
5	Top side	0	<input type="checkbox"/>	Fixed	113.2
6	Bottom side	0	<input type="checkbox"/>	Fixed	28.1

2. SAR measurement system

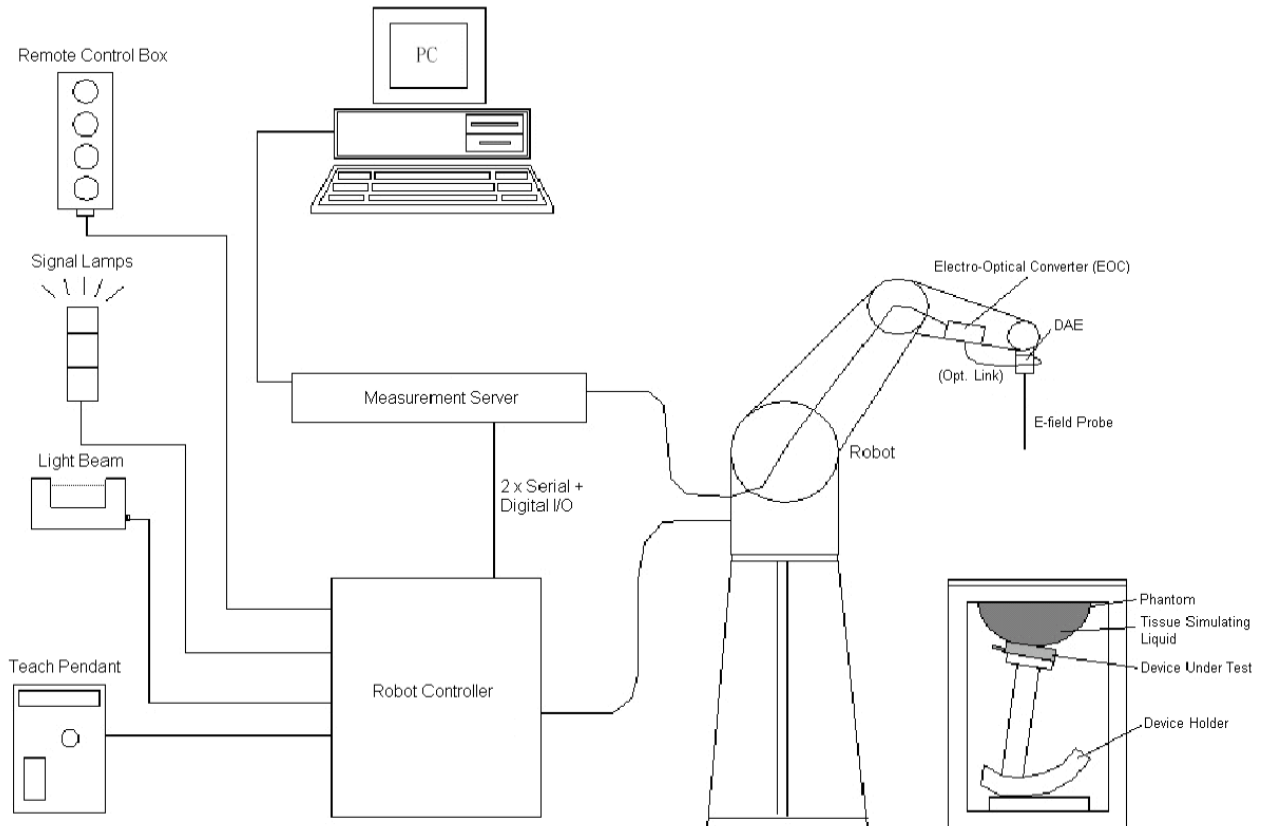

Figure 2. SPEAG DASY system configuration

The DASY system for performance compliance tests is illustrated above graphically. This system consists of the following items:

- A standard high precision 6-axis robot with controller, a teach pendant and software
- A data acquisition electronic (DAE) attached to the robot arm extension
- A dosimetric probe equipped with an optical surface detector system
- The electro-optical converter (EOC) performs the conversion between optical and electrical signals
- A measurement server performs the time critical tasks such as signal filtering, control of the robot operation and fast movement interrupts.
- A probe alignment unit which improves the accuracy of the probe positioning
- A computer operating Windows XP
- DASY software
- Remote control with teach pendant and additional circuitry for robot safety such as warning lamps, etc.
- The SAM twin phantom and/or ELI phantom
- A device holder
- Tissue simulating liquid
- Dipole for evaluating the proper functioning of the system

2.1. Robot

The DASY system uses the high precision robots from Stäubli SA (France). For the 6-axis controller system, the robot controller version from Stäubli is used. The Stäubli robot series have many features that are important for our application:

- High precision (repeatability ± 0.035 mm)
- High reliability (industrial design)
- Jerk-free straight movements
- Low ELF interference (the closed metallic construction shields against motor control fields)



Figure 3. SPEAG DASY 4

2.2. Probe

The SAR measurement is conducted with the dosimetric probe. The probe is specially designed and calibrated for use in liquid with high permittivity. The dosimetric probe has special calibration in liquid at different frequency.

Model	EX3DV4	
Construction	Symmetrical design with triangular core Built-in shielding against static charges PEEK enclosure material (resistant to organic solvents, e.g., DGBE)	
Frequency	10 MHz to > 6 GHz Linearity: ± 0.2 dB (30 MHz to 6 GHz)	
Directivity	± 0.3 dB in TSL (rotation around probe axis) ± 0.5 dB in TSL (rotation normal to probe axis)	
Dynamic Range	10 μ W/g to > 100 mW/g Linearity: ± 0.2 dB (noise: typically < 1 μ W/g)	
Dimensions	Overall length: 337 mm (Tip: 20 mm) Tip diameter: 2.5 mm (Body: 12 mm) Typical distance from probe tip to dipole centers: 1 mm	

Figure 4. Probe

2.3. Data Acquisition Electronics (DAE)

Model	DAE4	
Construction	Signal amplifier, multiplexer, A/D converter and control logic. Serial optical link for communication with DASY4/5 embedded system (fully remote controlled). Two step probe touch detector for mechanical surface detection and emergency robot stop.	
Measurement Range	-100 to +300 mV (16 bit resolution and two range settings: 4 mV, 400mV)	
Input Offset Voltage	± 0.2 dB in HSL (rotation around probe axis) ± 0.3 dB in tissue material (rotation normal to probe axis)	
Input Bias Current	< 50 fA	
Dimensions	60 x 60 x 68 mm	

Figure 5. DAE

2.4. Phantoms

Model	Twin SAM	
Construction	The shell corresponds to the specifications of the Specific Anthropomorphic Mannequin (SAM) phantom defined in IEEE 1528 and IEC 62209-1. It enables the dosimetric evaluation of left and right hand phone usage as well as body mounted usage at the flat phantom region. A cover prevents evaporation of the liquid. Reference markings on the phantom allow the complete setup of all predefined phantom positions and measurement grids by teaching three points with the robot.	
Material	Vinylester, glass fiber reinforced (VE-GF)	
Shell Thickness	2 ± 0.2 mm (6 ± 0.2 mm at ear point)	
Dimensions	Length: 1000 mm Width: 500 mm Height: adjustable feet	
Filling Volume	approx. 25 liters	

Figure 6. Twin SAM



Model	ELI	
Construction	Phantom for compliance testing of handheld and body-mounted wireless devices in the frequency range of 30 MHz to 6 GHz. ELI is fully compatible with the IEC 62209-2 standard and all known tissue simulating liquids. ELI has been optimized regarding its performance and can be integrated into our standard phantom tables. A cover prevents evaporation of the liquid. Reference markings on the phantom allow installation of the complete setup, including all predefined phantom positions and measurement grids, by teaching three points. The phantom is compatible with all SPEAG dosimetric probes and dipoles.	
Material	Vinylester, glass fiber reinforced (VE-GF)	
Shell Thickness	2.0 ± 0.2 mm (bottom plate)	
Dimensions	Major axis: 600 mm Minor axis: 400 mm	
Filling Volume	approx. 30 liters	

Figure 7. ELI

2.5. Device holder

Model	Mounting device	 Figure 8. Mounting device
Construction	In combination with the Twin SAM Phantom or ELI4, the Mounting Device enables the rotation of the mounted transmitter device in spherical coordinates. Rotation point is the ear opening point. Transmitter devices can be easily and accurately positioned according to IEC, IEEE, FCC or other specifications. The device holder can be locked for positioning at different phantom sections (left head, right head, flat).	
Material	POM	

Model	Laptop extensions kit	 Figure 9. Laptop extensions kit
Construction	Simple but effective and easy-to-use extension for Mounting Device that facilitates the testing of larger devices according to IEC 62209-2 (e.g., laptops, cameras, etc.). It is lightweight and fits easily on the upper part of the Mounting Device in place of the phone positioner.	
Material	POM, Acrylic glass, Foam	

3. SAR measurement procedure

Step 1: Power reference measurement

The power reference measurement and power reference measurements are for monitoring the power drift of the device under test in the batch process. The minimum distance of probe sensors to surface determines the closest measurement point to phantom surface. The minimum distance of probe sensors to surface is 2 mm. This distance cannot be smaller than the distance of sensor calibration points to probe tip as defined in the probe properties.

Step 2 and 3: Area scan & zoom scan procedures

The entire evaluation of the spatial peak values is performed within the post-processing engine (SEMCAD). The system always gives the maximum values for the 1 g and 10 g cubes. The algorithm to find the cube with highest averaged SAR is divided into the following stages:

1. The extraction of the measured data (grid and values) from the zoom scan.
2. The calculation of the SAR value at every measurement point based on all stored data (A/D values and measurement parameters)
3. The generation of a high-resolution mesh within the measured volume
4. The interpolation of all measured values from the measurement grid to the high-resolution grid
5. The extrapolation of the entire 3-D field distribution to the phantom surface over the distance from sensor to surface
6. The calculation of the averaged SAR within masses of 1 g and 10 g.

		≤ 3 GHz	> 3 GHz
Maximum distance from closest measurement point (geometric center of probe sensors) to phantom surface		$5 \pm 1 \text{ mm}$	$\frac{1}{2} \cdot \delta \cdot \ln(2) \pm 0.5 \text{ mm}$
Maximum probe angle from probe axis to phantom surface normal at the measurement location		$30^\circ \pm 1^\circ$	$20^\circ \pm 1^\circ$
Maximum area scan spatial resolution: $\Delta x_{\text{Area}}, \Delta y_{\text{Area}}$		$\leq 2 \text{ GHz}: \leq 15 \text{ mm}$ $2 - 3 \text{ GHz}: \leq 12 \text{ mm}$	$3 - 4 \text{ GHz}: \leq 12 \text{ mm}$ $4 - 6 \text{ GHz}: \leq 10 \text{ mm}$
		When the x or y dimension of the test device, in the measurement plane orientation, is smaller than the above, the measurement resolution must be \leq the corresponding x or y dimension of the test device with at least one measurement point on the test device.	
Maximum zoom scan spatial resolution: $\Delta x_{\text{Zoom}}, \Delta y_{\text{Zoom}}$		$\leq 2 \text{ GHz}: \leq 8 \text{ mm}$ $2 - 3 \text{ GHz}: \leq 5 \text{ mm}^*$	$3 - 4 \text{ GHz}: \leq 5 \text{ mm}^*$ $4 - 6 \text{ GHz}: \leq 4 \text{ mm}^*$
Maximum zoom scan spatial resolution, normal to phantom surface	uniform grid: $\Delta z_{\text{Zoom}}(n)$	$\leq 5 \text{ mm}$	$3 - 4 \text{ GHz}: \leq 4 \text{ mm}$ $4 - 5 \text{ GHz}: \leq 3 \text{ mm}$ $5 - 6 \text{ GHz}: \leq 2 \text{ mm}$
	graded grid	$\Delta z_{\text{Zoom}}(1)$: between 1 st two points closest to phantom surface	$\leq 4 \text{ mm}$
	$\Delta z_{\text{Zoom}}(n>1)$: between subsequent points	$\leq 1.5 \cdot \Delta z_{\text{Zoom}}(n-1)$	
Minimum zoom scan volume	x, y, z	$\geq 30 \text{ mm}$	$3 - 4 \text{ GHz}: \geq 28 \text{ mm}$ $4 - 5 \text{ GHz}: \geq 25 \text{ mm}$ $5 - 6 \text{ GHz}: \geq 22 \text{ mm}$
Note: δ is the penetration depth of a plane-wave at normal incidence to the tissue medium; see draft standard IEEE P1528-2011 for details. * When zoom scan is required and the <i>reported</i> SAR from the <i>area scan based 1-g SAR estimation</i> procedures of KDB 447498 is $\leq 1.4 \text{ W/kg}$, $\leq 8 \text{ mm}$, $\leq 7 \text{ mm}$ and $\leq 5 \text{ mm}$ zoom scan resolution may be applied, respectively, for 2 GHz to 3 GHz, 3 GHz to 4 GHz and 4 GHz to 6 GHz.			

Figure 10. Area and zoom scan resolutions per FCC KDB Publication 865664 D01v01r03

Step 4: Power drift measurement

The power drift measurement measures the field at the same location as the most recent power reference measurement within the same procedure, and with the same settings. The power drift measurement gives the field difference in dB from the reading conducted within the last power reference measurement. This allows a user to monitor the power drift of the device under test within a batch process. The measurement procedure is the same as Step 1.

4. Tissue simulating liquids

For the measurement of the field distribution inside the phantom with DASY, the phantom must be filled with around 25 liters of homogeneous body tissue simulating liquid. For body SAR testing, the liquid height from the center of the flat phantom to the liquid top surface is larger than 15 cm, which is shown in figure 11.

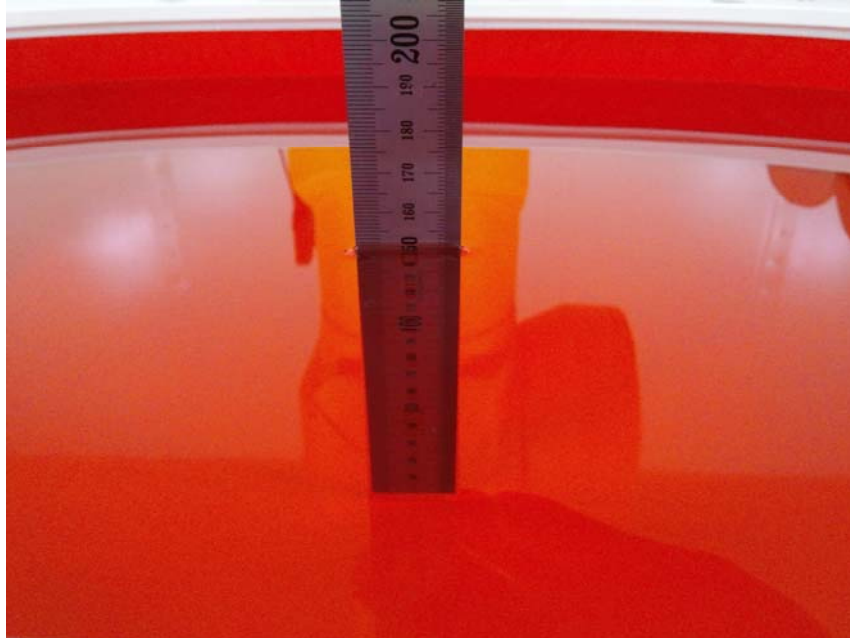

Figure 11. Liquid height photo

The dielectric parameters of the liquids were verified prior to the SAR evaluation using an Agilent dielectric probe kit and an Agilent network analyzer.

The following table shows the measuring results for simulating liquid.
 WLAN 5.6 GHz band

Frequency (MHz)	Tissue type	Liquid temp.(°C)	Parameters	Target value	Measured value	Deviation (%)	Limit (%)	Data
5 600	Body	22.0	Permittivity (ε _r)	48.5	46.5	-4.12	±5	2014.12.18
			Conductivity (σ)	5.77	5.57	-3.47	±5	2014.12.18

5. System verification and validation

5.1. Procedure

SAR measurement was prior to assessment, the system is verified to the $\pm 10\%$ of the specifications at each frequency band by using the system verification kit.

- Cabling the system, using the verification kit equipments.
- Generate about 100 mW or 250 mW input level from the signal generator to the dipole antenna.
- Dipole antenna was placed below the flat phantom.
- The measured one-gram SAR at the surface of the phantom above the dipole feed-point should be within 10 % of the target reference value.
- The results are normalized to 1 W input power.

Note;

SAR verification was performed according to the FCC KDB 865664 D01v01r03.



5.2. System verification

Frequency (MHz)	Tissue type	Probe (S/N)	Antenna (S/N)	1 W Target SAR _{1g} (W/kg)	Measured SAR _{1g} (W/kg)	1 W Normalized SAR _{1g} (W/kg)	Deviation (%)	Limit (%)	Data
5 600	Body	3879	1130	83.0	8.11	81.1	-2.29	± 10	2014.12.18



5.3. System validation

Per FCC KDB 865664 D02v01r01, SAR system validation status should be documented to confirm measurement accuracy. The SAR systems (including SAR probes, system components and software versions) used for this device were validated against its performance specifications prior to the SAR measurements. Reference dipoles were used with the require tissue-equivalent media for system validation, according to the procedures outlined in IEEE 1528-2003 and FCC KDB 865664 D01v01r03. Since frequency within the valid frequency range of the probe calibration point, using the system that normally operates with the probe for routine SAR measurements and according to the required tissue-equivalent media. A tabulated summary of the system validation status including the validation date(s), measurement frequencies, SAR probe and tissue dielectric parameters has been included.

f (MHz)	Date	Probe S/N	Probe cal. point	Tissue type	Dielectric parameters		CW validation			Modulated Validation		
					Permittivity	Conductivity	Sensitivity	Probe Linearity	Probe Isotropy	Mod. Type	Duty Factor	PAR
5 600	2014.12.18	3879	5 600	Body	46.5	5.57	Pass	Pass	Pass	OFDM	N/A	Pass

This report shall not be reproduced except in full, without the written approval of KES Co., Ltd.
The test results in the report only apply to the tested sample.

6. RF exposure limits

Uncontrolled environment

Uncontrolled environments are defined as locations where there is the exposure of individuals who have no knowledge or control of their exposure. The general population/uncontrolled exposure limits are applicable to situations in which the general public may be exposed or in which persons who are exposed as a consequence of their employment may not be made fully aware of the potential for exposure or cannot exercise control over their exposure. Members of the general public would come under this category when exposure is not employment-related; for example, in the case of a wireless transmitter that exposes persons in its vicinity.

Controlled environment

Controlled environments are defined as locations where there is exposure that may be incurred by persons who are aware of the potential for exposure, (i.e. as a result of employment or occupation). In general, occupational/controlled exposure limits are applicable to situations in which persons are exposed as a consequence of their employment, who have been made fully aware of the potential for exposure and can exercise control over their exposure. This exposure category is also applicable when the exposure is of a transient nature due to incidental passage through a location where the exposure levels may be higher than the general population/uncontrolled limits, but the exposed person is fully aware of the potential for exposure and can exercise control over his or her exposure by leaving the area or by some other appropriate means.

	Uncontrolled environment general population (W/kg) or (mW/g)	Controlled environment occupational (W/kg) or (mW/g)
Spatial peak SAR head	1.60	8.00
Spatial average SAR whole body	0.08	0.40
Spatial peak SAR hands, feet, ankles, wrists	4.00	20.00

Figure 12. RF exposure limits

7. Test results summary

7.1. RF conducted power

7.1.1. Power measurement procedures

The SAR measurement software calculates a reference point at the start and end of the test to check for power drifts. If conducted power deviations of more than 5 % occurred, the tests were repeated.

7.1.2. RF conducted power

Band	Mode	Bandwidth (MHz)	Channel	Data rate	Frequency (MHz)	Measured output power(dBm)
2.4 GHz	802.11b	20	1	1	2 412	15.41
			6	5.5	2 437	15.71
			11	11	2 462	15.04
	802.11g	20	1	36	2 412	9.32
			6	18	2 437	9.10
			11	48	2 462	9.25
5.2 GHz	802.11a	20	36	6	5 180	7.87
			40	6	5 200	7.87
			44	9	5 220	7.88
			48	6	5 240	7.81
5.3 GHz	802.11a	20	52	6	5 260	7.19
			56	18	5 280	7.14
			60	6	5 300	6.87
			64	18	5 320	7.51
5.6 GHz	802.11a	20	100	18	5 500	11.71
			104	18	5 520	12.58
			108	18	5 540	13.46
			112	6	5 560	13.62
			116	36	5 580	14.55
			120	18	5 600	15.38
			124	36	5 620	15.19
			128	18	5 640	15.35
			132	36	5 660	14.80
			136	9	5 680	14.72
5.8 GHz	802.11a	20	149	36	5 745	10.93
			153	18	5 765	10.96
			157	9	5 785	11.33
			161	18	5 805	11.28
			165	18	5 825	10.79

Note;

- All data rates were measured each band/bandwidth and the highest power data rates were reported.

7.2. SAR results

7.2.1. Measured and reported SAR

According to the FCC KDB publication 447498 D01v05r02, when SAR is not measured at the maximum power level allowed for production units, the results must be scaled to the maximum tune-up tolerance limit according to the power applied to the individual channels tested to determine compliance. If the device is possible simultaneous transmission, the measured aggregate SAR must be scaled according to the sum of the differences between the maximum tune-up tolerance and actual power used to test each transmitter. When SAR is measured at or scaled to the maximum tune-up tolerance limit, the results are referred to as reported SAR. The highest reported SAR results are identified on the grant of equipment authorization according to procedure in KDB 690783 D01v01r03

802.11 a/b/g and 4.9 GHz operating modes are tested independently according to the service requirements in each frequency band. 802.11 b/g modes are tested on channel 1, 6, and 11. 802.11a is tested for UNII operations on channels 36 and 48 in the 5.15 ~ 5.25 GHz band, channels 52 and 64 in the 5.25 ~ 5.35 GHz band, channels 104, 116, 124 and 136 in the 5.470 ~ 5.725 GHz band, and channels 149 and 161 in the 5.8 GHz band. When 5.8 GHz §15.247 is also available, channels 149, 157 and 165 should be tested instead of the UNII channels.

SAR is not required for 802.11g channels when the maximum average output power is less than ¼ dB higher than that measured on the corresponding 802.11b channels.

The average output power for 802.11a should be measured on all channels in each frequency band. When the maximum average output channel in each frequency band is not included in the “default test channels”, the maximum channel should be tested instead of an adjacent “default test channel”.

Mode	GHz	Channel	Turbo Channel	“Default Test Channels”		
				§15.247		UNII
				802.11b	802.11g	
802.11 b/g	2.412	1*		√	∇	
	2.437	6	6	√	∇	
	2.462	11*		√	∇	
802.11a	5.18	36				√
	5.20	40	42 (5.21 GHz)			*
	5.22	44				*
	5.24	48	50 (5.25 GHz)			√
	5.26	52				√
	5.28	56	58 (5.29 GHz)			*
	5.30	60				*
	5.32	64				√
	5.500	100	Unknown			*
	5.520	104				√
	5.540	108				*
	5.560	112				*
	5.580	116				√
	5.600	120				*
	5.620	124				√
	5.640	128			*	
	5.660	132			*	
5.680	136			√		
5.700	140			*		
UNII	5.745	149		√		√
	5.765	153	152 (5.76 GHz)		*	*
§15.247	5.785	157		√		*
	5.805	161	160 (5.80 GHz)		*	√
§15.247	5.825	165		√		

Table 1: “Default Test Channels”

- √ = “default test channels”
- * = possible 802.11a channels with maximum average output > the “default test channels”
- ∇ = possible 802.11g channels with maximum average output ¼ dB ≥ the “default test channels”
- * = when output power is reduced for channel 1 and/or 11 to meet restricted band requirements the highest output channels closest to each of these channels should be tested

This report shall not be reproduced except in full, without the written approval of KES Co., Ltd.
 The test results in the report only apply to the tested sample.

7.2.2. WLAN 2.4 GHz band

Test mode	Frequency (MHz)	Data rate	EUT position	Distance (mm)	Power drift(dB)	Power(dBm)		SAR _{1g} (W/kg)	
						Measured power	Tune up limit	Measured SAR	Scaled SAR
802.11a (Body)	5 600	6	Front	0	-0.082	14.94	15.40	0.076	0.084
	5 600	6	Left side	0	0.00	14.94	15.40	0.028	0.031
	5 600	18	Front	0	0.071	15.38	15.40	0.066	0.066
	5 600	18	Left side	0	0.00	15.38	15.40	0.026	0.026

Note:

1. The test data reported are worst case SAR values according to test procedure specified in IEEE 1528-2003, FCC KDB publication 865664 D01v01r03 and 447498 D01v05r02.
2. All mode of operation were investigated and worst case results are reported.
3. Battery is fully charged at the beginning of the SAR measurements
4. Liquid tissue depth was at least 15 cm for all frequencies.
5. The manufacturer has confirmed that device(s) tested have the same physical, mechanical and thermal characteristics and are within operational tolerances expected for production units.
6. According to the FCC KDB publication 865664 D01v01r03, variability SAR tests are required if the measured SAR results for the frequency band are more than 0.8 W/kg.
7. SAR results were scaled to the maximum allowed power to demonstrate compliance per FCC KDB publication 447498 D01v05r02.
8. Justification for reduced test configurations for WIFI channels per KDB Publication 248227 D01v01r02 and October 2012 FCC/TCB Meeting Notes for 2.4 GHz WIFI: Highest average RF output power channel for the lowest data rate was selected for SAR evaluation in 802.11b. Other IEEE 802.11 modes (including 802.11g/n) were not investigated since the average output powers over all channels and data rates were not more than 0.25 dB higher than the tested channel in the lowest data rate of IEEE 802.11b mode
9. Justification for reduced test configurations for WIFI channels per KDB Publication 248227 D01v01r02 and October 2012 FCC/TCB Meeting Notes for 5 GHz WIFI: Highest average RF output power channel for the lowest data rate was selected for SAR evaluation in 802.11a. Other IEEE 802.11 modes (including 802.11n) were not investigated since the average output powers over all channels and data rates were not more than 0.25 dB higher than the tested channel in the lowest data rate of IEEE 802.11a mode.
10. When the maximum extrapolated peak SAR of the zoom scan for the maximum output channel was <1.6 W/kg and the reported 1g averaged SAR is <0.8 W/kg, SAR testing on other default channels was required.



8. Measurement equipments

Equipment	Manufacturer	Model	Serial No.	Calibration interval	Calibration due.
Stäubli Robot Unit	Stäubli	RX90B	F02/5Q89A1/A/01	N/A	N/A
Data Acquisition Electronics	SPEAG	DAE4	1344	1year	2015.11.12
E-Field Probe	SPEAG	EX3DV4	3879	1year	2015.11.19
Electro Optical Converter	SPEAG	EOC5	N/A	N/A	N/A
2mm Oval Phantom EL15	SPEAG	QD OVA 002 AA	1190	N/A	N/A
Dipole Antenna	SPEAG	D5GHzV2	1130	3years	2017.05.22
S-Parameter Network Analyzer	Agilent	8753ES	MY40000210	1year	2015.07.24
Calibration Kit	Agilent	85033D	3423A02429	N/A	N/A
EPM Series Power Meter	HP	E4419B	GB37290599	1year	2015.07.23
E-Series AVG Power Sensor	HP	E9300H	MY41495967	1year	2015.07.23
E-Series AVG Power Sensor	HP	E9300H	US39215405	1year	2015.07.23
Wideband Power Sensor	R&S	NRP-Z81	1137.9009.02-101886-ds	1year	2015.01.07
Broadband High Power Amplifier	EM Power	1138	1030	1year	2015.07.23
Dual Directional Coupler	HP	11692D	1212A03523	1year	2015.07.24
Vector Signal Generator	R&S	SMBV100A	1407.6004K02	1year	2015.07.26
Signal Analyzer	R&S	FSV30	101389	1year	2015.04.30
Attenuator	HP	8494B	2630A12857	1year	2015.04.30
Hygro-Thermometer	BODYCOM	BJ5478	N/A	1year	2015.07.26
Dielectric Probe Kit	Agilent	85070E	MY44300696	N/A	N/A
Software	SPEAG	DASY4 V4.7	-	N/A	N/A

This report shall not be reproduced except in full, without the written approval of KES Co., Ltd.
The test results in the report only apply to the tested sample.

9. Measurement Uncertainty

DASY4 Uncertainty budget							
Error Description	Section in P1528	Uncertainty Value ± %	Prob. Dist.	Div.	c_i (1 g)	$u_i(y)$ (1 g) ± %	v_i or v_{eff}
Probe Calibration	E.2.1	6.55	N	1.00	1.00	6.55	∞
Axial Isotropy	E.2.2	0.50	R	1.73	0.71	0.20	∞
Hemispherical Isotropy	E.2.2	2.60	R	1.73	0.71	1.06	∞
Boundary Effect	E.2.3	2.00	R	1.73	1.00	1.16	∞
Linearity	E.2.4	0.60	R	1.73	1.00	0.35	∞
System Detection Limits	E.2.5	1.00	R	1.73	1.00	0.58	∞
Readout Electronics	E.2.6	0.30	N	1.00	1.00	0.30	∞
Response Time	E.2.7	0.50	R	1.73	1.00	0.29	∞
Integration Time	E.2.8	2.60	R	1.73	1.00	1.50	∞
RF Ambient Noise	E.6.1	3.00	R	1.73	1.00	1.73	∞
RF Ambient Reflections	E.6.1	3.00	R	1.73	1.00	1.73	∞
Probe Positioning Mechanical Tolerance	E.6.2	0.40	R	1.73	1.00	0.23	∞
Probe Positioning With Respect to Phantom	E.6.3	2.90	R	1.73	1.00	1.67	∞
Max. SAR Eval.	E.5.2	2.00	R	1.73	1.00	1.15	∞
Test sample positioning	E.4.2	2.30	N	1.00	1.00	2.30	9
Device Holder Uncertainty	E.4.1	3.60	N	1.00	1.00	3.60	∞
SAR Drift Measurement	6.6.3	5.00	R	1.73	1.00	2.89	∞
Phantom Uncertainty	E.3.1	6.10	R	1.73	1.00	3.52	∞
Liquid Conductivity(target)	E.3.2	5.00	R	1.73	0.64	1.85	∞
Liquid Conductivity(meas.)	E.3.2	0.30	N	1.00	0.64	0.19	5
Liquid Permittivity(target)	E.3.3	5.00	R	1.73	0.60	1.73	∞
Liquid Permittivity(meas.)	E.3.3	0.01	N	1.00	0.60	0.01	5
Combined Std. Uncertainty(RSS)						± 10.19 %	10 301.933
Expanded Uncertainty						± 20.38 %	k = 2

This report shall not be reproduced except in full, without the written approval of KES Co., Ltd.
 The test results in the report only apply to the tested sample.

10. Setup photo

-Front



-Left side



This report shall not be reproduced except in full, without the written approval of KES Co., Ltd.
The test results in the report only apply to the tested sample.



Appendix list
Appendix A. DASY4 report
Appendix B. Calibration certificate