



CTK Co., Ltd.  
The Prime Leader of Global Regulatory Certification

# CTK Co., Ltd.

386-1, Ho-dong, Cheoin-gu, Yongin-si, Gyeonggi-do, 449-100, Korea  
Tel: +82-31-339-9970 Fax: +82-31-339-9855  
www.e-ctk.com

## EMC TEST REPORT For FCC



Test Report No. : CTK-2012-00681

Date of Issue : July 11, 2012

FCC ID : GU6-MTT

Model/Type No. : 9485NP

Kind of Product : Mobile Printer

Applicant : Avery Dennison Retail Information Services LLC

Applicant Address : 170 Monarch Lane, Miamisburg, OH 45342

Manufacturer : SEWOO TECH CO., LTD.

Manufacturer Address : 28-6, Gajangsaneopdong-ro, Osan-si, Gyeonggi-do, 447-210, Korea

Contact Person : James A Bacher / Senior Engineer

Telephone : +1-937-865-2020

Received Date : April 10, 2012

Test period : Start : April 23, 2012 End : April 24, 2012

Test Results :  **In Compliance**  **Not in Compliance**

The test results presented in this report relate only to the object tested.

*Tested by*

Bong-jun, Jang  
EMC Test Engineer  
Date: July 11, 2012

*Reviewed by*

James Hong  
EMC Technical Manager  
Date: July 11, 2012



CTK Co., Ltd.  
The Prime Leader of Global Regulatory Certification

# CTK Co., Ltd.

386-1, Ho-dong, Cheoin-gu, Yongin-si, Gyeonggi-do, 449-100, Korea

Tel: +82-31-339-9970 Fax: +82-31-339-9855

www.e-ctk.com

## REPORT REVISION HISTORY

Date	Revision	Page No
July 11, 2012	Issued (CTK-2012-00681)	All

*This report shall not be reproduced except in full, without the written approval of CTK Co., Ltd. This document may be altered or revised by CTK Co., Ltd. personnel only, and shall be noted in the revision section of the document. Any alteration of this document not carried out by CTK Co., Ltd. will constitute fraud and shall nullify the document.*



CTK Co., Ltd.  
The Prime Leader of Global Regulatory Certification

# CTK Co., Ltd.

386-1, Ho-dong, Cheoin-gu, Yongin-si, Gyeonggi-do, 449-100, Korea

Tel: +82-31-339-9970 Fax: +82-31-339-9855

www.e-ctk.com

## TABLE OF CONTENTS

REPORT REVISION HISTORY .....	2
1.0 General Product Description .....	4
1.1 Model Differences .....	4
1.2 Device Modifications .....	4
1.3 EUT Configuration(s) .....	5
1.4 Test Software .....	6
1.5 EUT Operating Mode(s) .....	6
1.6 Configuration .....	7
1.7 Calibration Details of Equipment Used for Measurement .....	9
1.8 Test Facility .....	9
1.9 Measurement Procedure .....	9
1.10 Laboratory Accreditations and Listings .....	10
1.11 Measurement Uncertainty .....	10
2.0 Emissions Test Regulations .....	11
2.1 Conducted Voltage Emissions .....	12
2.2 Radiated Electric Field Emissions .....	13
APPENDIX A – TEST DATA .....	14
Conducted Voltage Emissions .....	14
Radiated Electric Field Emissions .....	22
APPENDIX B - Test Setup Photos and Configuration .....	26
Conducted Voltage Emissions .....	26
Radiated Electric Field Emissions .....	27
APPENDIX C – EUT Photographs .....	28
EUT Internal Photographs .....	31
PCB .....	32
Battery Charger 1&2 .....	35
Battery .....	37
Label and Location .....	38



CTK Co., Ltd.  
The Prime Leader of Global Regulatory Certification

## CTK Co., Ltd.

386-1, Ho-dong, Cheoin-gu, Yongin-si, Gyeonggi-do, 449-100, Korea

Tel: +82-31-339-9970 Fax: +82-31-339-9855

www.e-ctk.com

## 1.0 General Product Description

### 1.0.1 Tested Equipment

- Unless otherwise indicated, all tests were conducted on Model 9485NP.
- Tests performed on Model \_\_\_\_ were considered to be representative of Model \_\_\_\_.

### 1.0.2 Equipment Size, Mobility and Identification

Dimensions: 104(W) by 85(D) by 158(H)  mm  
Mobility:  Table-top  Floor-standing  Built-in  Portable  
Serial No.: Prototype

### 1.0.3 Electrical Ratings

[Battery Charger 1] Input: 100-240 Vac, 50-60 Hz, 400 mA  
Output: 8.4 Vdc, 0.8 A

[Battery Charger 2] Input: 100-250 Vac, 50-60 Hz, 0.5 A  
Output: 8.4 Vdc, 0.8 A

[EUT] Input : 8.4 Vdc  
Output : -

### 1.0.4 Test Voltage & Frequency

Unless indicated otherwise on the individual data sheet or test results, the test voltage and frequency was as indicated below.

Voltage: 120 Vac  
Frequency: 60 Hz

### 1.0.5 Clock & Other Frequencies Utilized

12 MHz

## 1.1 Model Differences

Not applicable

## 1.2 Device Modifications

The following modifications were necessary for compliance:

Not applicable



CTK Co., Ltd.  
The Prime Leader of Global Regulatory Certification

# CTK Co., Ltd.

386-1, Ho-dong, Cheoin-gu, Yongin-si, Gyeonggi-do, 449-100, Korea

Tel: +82-31-339-9970 Fax: +82-31-339-9855

www.e-ctk.com

## 1.3 EUT Configuration(s)

See Appendix B for individual test set-up configuration(s). The following peripheral devices and/or interface cables were connected during the measurement:

[USB/Serial Printing Mode]

Peripheral Devices

Device	Manufacturer	Model No.	Serial No.
Personal Computer	comwins	DB-P73	BL5497DQ300097T
LCD Monitor	Lite-On Technology Corp.	VS17	CNN5130QMC
Mouse	LOGITECH	M-U48a	LZC10705528
Keyboard	MONTEREY INTERNATIONAL CORP.	K6515	ZCH3011

Cable Description

#	Description	Ferrite Core	Length (m)	Other Details
1	AC power Cable, Unshielded	No	1.8	Connect to AC power
2	Mouse Cable, Shielded	No	1.5	Between a Personal Computer and a Mouse
3	Keyboard Cable, Shielded	No	1.5	Between a Personal Computer and a Keyboard
4	D-sub Cable, Unshielded	Yes	1.5	Between a Personal Computer and a LCD Monitor
5	USB Cable, Shielded	Yes	1.2	Between the EUT and a Personal Computer
6	Serial Cable, Shielded	No	1.2	Between the EUT and a Personal Computer

[Battery Charging Mode: Battery Charger 1]

Peripheral Devices

Device	Manufacturer	Model No.	Serial No.
Battery Charger 1	Dongguan Shilong Fuhua Electronic Co., Ltd.	UE09WCP-084080SPC	-

Cable Description

#	Description	Ferrite Core	Length (m)	Other Details
1	DC In Cable, Unshielded	No	1.2	Between the EUT and a Battery Charger 1
2	AC Power	-	-	Connect to AC power
3	USB Cable, Shielded	Yes	1.2	Connect to the EUT
4	Serial Cable, Shielded	No	1.2	Connect to the EUT

[Battery Charging Mode: Battery Charger 2]

Peripheral Devices

Device	Manufacturer	Model No.	Serial No.
Battery Charger 2	BridgePower Corp.	BL607080086100NK	-

Cable Description

#	Description	Ferrite Core	Length (m)	Other Details
1	DC In Cable, Unshielded	Yes	1.2	Between the EUT and a Battery Charger 2
2	AC Power	No	1.8	Connect to AC power
3	USB Cable, Shielded	Yes	1.2	Connect to the EUT
4	Serial Cable, Shielded	No	1.2	Connect to the EUT



CTK Co., Ltd.  
The Prime Leader of Global Regulatory Certification

## CTK Co., Ltd.

386-1, Ho-dong, Cheoin-gu, Yongin-si, Gyeonggi-do, 449-100, Korea

Tel: +82-31-339-9970 Fax: +82-31-339-9855

www.e-ctk.com

### 1.4 Test Software

- EMC Test V 1.0
- Display Test Patterns – V1.8
- Ping.exe
- LK-Pxx CPCL TEST Program (20120126)

### 1.5 EUT Operating Mode(s)

Equipment under test was operated during the measurement under the following conditions:

- |  |  |
|--|--|
| <input type="checkbox"/> Standby                         | <input type="checkbox"/> Scrolling 'H'             |
| <input type="checkbox"/> Display circles pattern         | <input type="checkbox"/> Display color bar pattern |
| <input checked="" type="checkbox"/> Practice operation – |  |
| 1) USB/Serial Printing Mode                              |  |
| 2) Battery Charging Mode                                 |  |

## 1.6 Configuration

[USB/Serial Printing Mode]

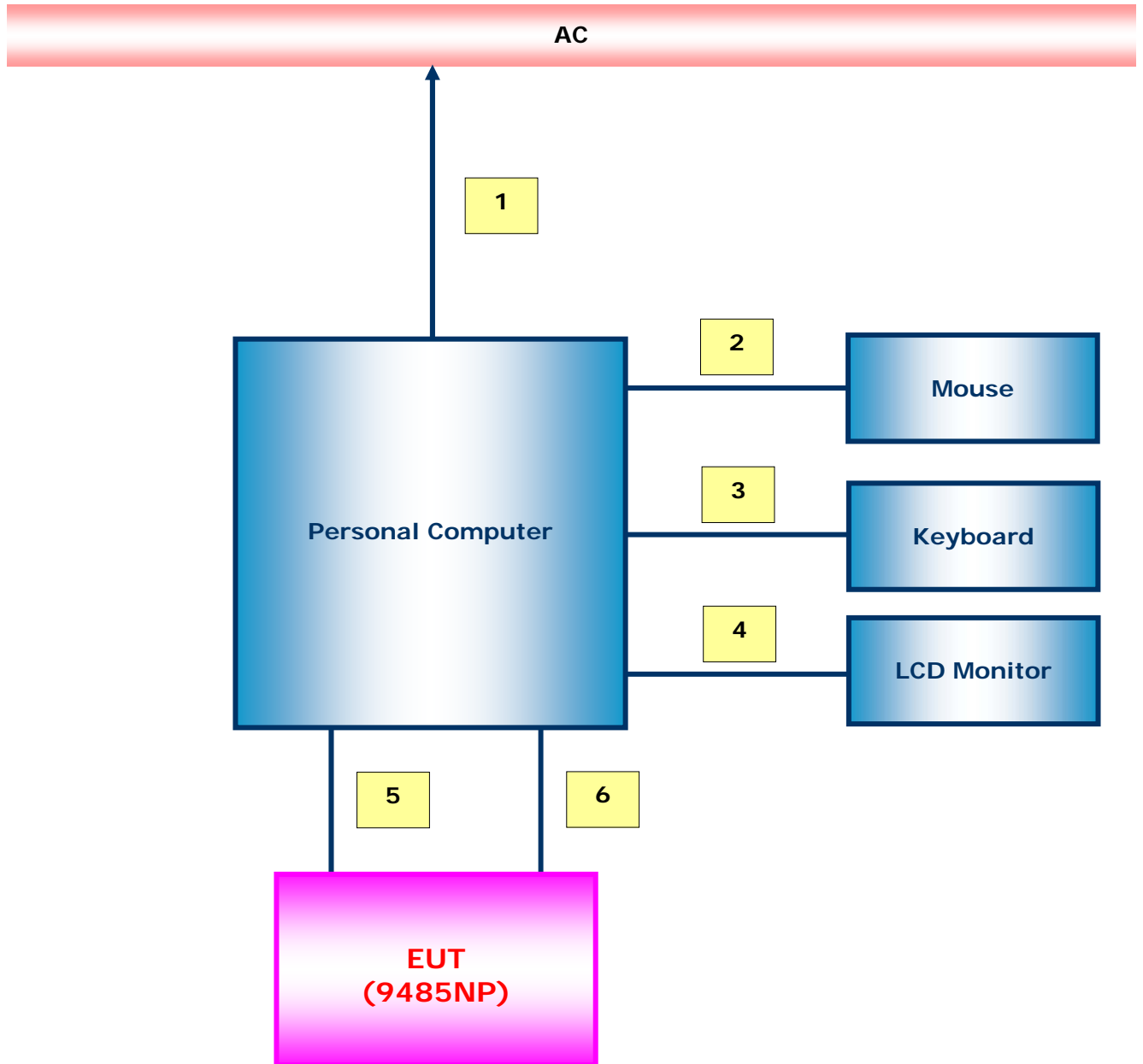

[Battery Charging Mode: Battery Charger 1]

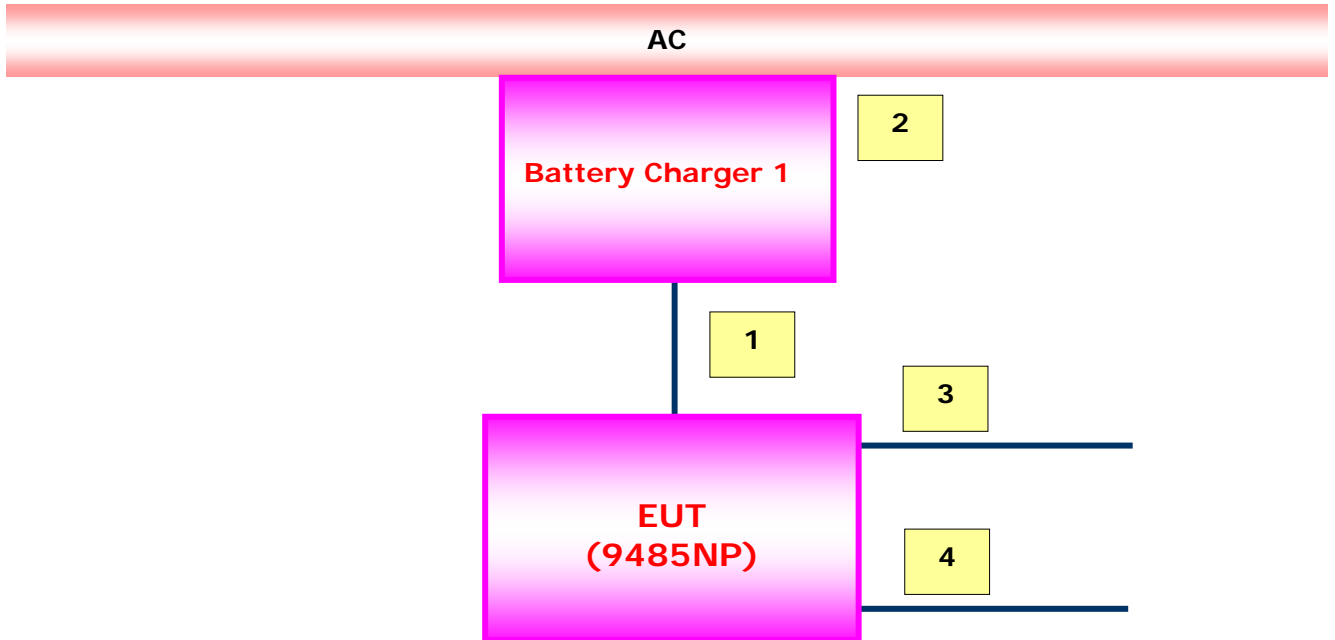

[Battery Charging Mode: Battery Charger 2]

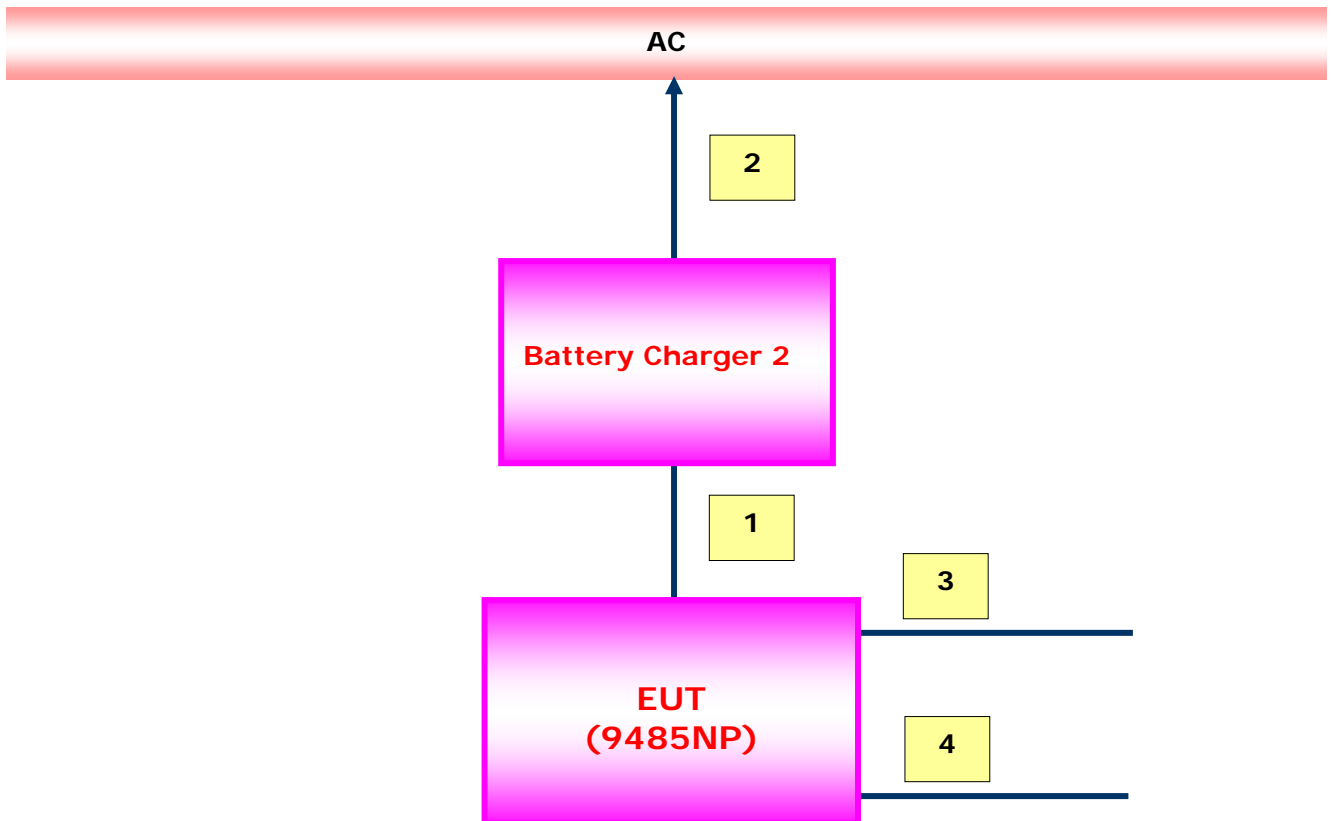





CTK Co., Ltd.  
The Prime Leader of Global Regulatory Certification

## CTK Co., Ltd.

386-1, Ho-dong, Cheoin-gu, Yongin-si, Gyeonggi-do, 449-100, Korea

Tel: +82-31-339-9970 Fax: +82-31-339-9855

www.e-ctk.com

### 1.7 Calibration Details of Equipment Used for Measurement

Test equipment and test accessories are calibrated on regular basis. The maximum time between calibrations is one year or what is recommended by the manufacturer, whichever is less. All test equipment calibrations are traceable to the Korea Research Institute of Standards and Science (KRISS), therefore, all test data recorded in this report is traceable to KRISS.

### 1.8 Test Facility

The measurement facility is located at 386-1, Ho-dong, Cheoin-gu, Yongin-si, Gyeonggi-do, 449-100, Korea. The sites are constructed in conformance with the requirements of ANSI C63.7, ANSI C63.4 and CISPR Publication 22.

### 1.9 Measurement Procedure

Preliminary AC power line conducted emissions tests were performed shielded room. To find worst mode, several typical mode and typical cable position were tested. Final AC power line conducted emissions test was performed shielded room. (location is same as Preliminary test)  
Based on the preliminary tests of the EUT, final test was proceeded worst case test mode and cable configuration.

Preliminary radiated emissions test were performed anechoic chamber (Distance of antenna and EUT was 3 m). To find worst mode, several typical mode and typical cable position were tested and peak level and frequency were recorded.

Final radiated emissions test was performed Open Area Test Site. Based on the preliminary tests of the EUT, final test was proceeded worst case test mode and cable configuration.

\* Measurement procedures was In accordance with ANSI C63.4-2003 7.2.3, 7.2.4, 8.3.1.1, 8.3.1.2

Note #1: Comparing this test result and FCC Part 18 limits, the emission of this product can also meet the FCC Part 18.305 Field Strength Limits and 18.307 Conduction Limits.

Note #2: These results are deemed satisfactory evidence of compliance with ICES-003 of The Canadian Interference-Causing Equipment Regulations.



CTK Co., Ltd.  
The Prime Leader of Global Regulatory Certification



## CTK Co., Ltd.

386-1, Ho-dong, Cheoin-gu, Yongin-si, Gyeonggi-do, 449-100, Korea

Tel: +82-31-339-9970 Fax: +82-31-339-9855

www.e-ctk.com

### 1.10 Laboratory Accreditations and Listings

Country	Agency	Scope of Accreditation	Logo
USA	FCC	3 m & 10 m OATS, 3 m & 10 m SAC and Conducted Test Site to perform FCC Part 15/18 measurements	 805871
JAPAN	VCCI	10 m OATS, 3 m & 10 m SAC and Conducted Test Site	 R-948, C-986, T-1843, R-3627, G-387
KOREA	KCC	EMI (10 m OATS, 10 m SAC and Conducted Test Site) EMS (ESD, RS, EFT/Burst, Surge, CS, Magnetic, Dips and Interruptions)	 No. 51, KR0025

### 1.11 Measurement Uncertainty

Compliance of the product is based on the measured value.

However, the measurement uncertainty is included for information purposes.

The measurement uncertainties given below are based on a standard uncertainty multiplied by a coverage factor of  $k=2$ , providing a level of confidence of approximately 95 %.

Measurement Type	Frequency Range	Expanded Uncertainty
Conducted Emission	150 kHz to 30 MHz	$\pm 2.48$ dB (C.L.: Approx. 95 %, $k=2$ )
Radiated Emission	30 MHz to 1000 MHz	$\pm 3.70$ dB (C.L.: Approx. 95 %, $k=2$ )



## 2.0 Emissions Test Regulations

The emissions tests were performed according to following regulations:

- |  |  |  |
|--|--|--|
| <input type="checkbox"/> EN 61000-6-3: 2007                  |  |  |
| <input type="checkbox"/> EN 61000-6-4: 2007                  |  |  |
| <input type="checkbox"/> EN 55011:2007 +A2:2007              | <input type="checkbox"/> Group 1<br><input type="checkbox"/> Class A | <input type="checkbox"/> Group 2<br><input type="checkbox"/> Class B |
| <input type="checkbox"/> EN 55013:2001 +A1:2003 +A2:2006     |  |  |
| <input type="checkbox"/> EN 55014-1:2006                     |  |  |
| <input type="checkbox"/> EN 55014-1:2006 +A1:2009            |  |  |
| <input type="checkbox"/> EN 55015:2006 +A1:2007 +A2:2009     |  |  |
| <input type="checkbox"/> EN 61204-3:2000                     | <input type="checkbox"/> Class A                                     | <input type="checkbox"/> Class B                                     |
| <input type="checkbox"/> EN 61131-2:2007                     |  |  |
| <input type="checkbox"/> EN 61326-1:2006                     | <input type="checkbox"/> Class A                                     | <input type="checkbox"/> Class B                                     |
| <input type="checkbox"/> EN 55022:2006 +A1:2007              | <input type="checkbox"/> Class A                                     | <input type="checkbox"/> Class B                                     |
| <input type="checkbox"/> EN 61000-3-2:2006 +A1:2009 +A2:2009 |  |  |
| <input type="checkbox"/> EN 61000-3-3:2008                   |  |  |
| <input type="checkbox"/> VCCI V-3/2011.04                    | <input type="checkbox"/> Class A                                     | <input type="checkbox"/> Class B                                     |
| <input type="checkbox"/> AS/NZS CISPR22:2009                 | <input type="checkbox"/> Class A                                     | <input type="checkbox"/> Class B                                     |
| <input checked="" type="checkbox"/> FCC Part 15 Subpart B    | <input type="checkbox"/> Class A                                     | <input checked="" type="checkbox"/> Class B                          |
| <input type="checkbox"/> CISPR 22: 2006                      | <input type="checkbox"/> Class A                                     | <input type="checkbox"/> Class B                                     |



CTK Co., Ltd.  
The Prime Leader of Global Regulatory Certification

# CTK Co., Ltd.

386-1, Ho-dong, Cheoin-gu, Yongin-si, Gyeonggi-do, 449-100, Korea

Tel: +82-31-339-9970 Fax: +82-31-339-9855

www.e-ctk.com

## 2.1 Conducted Voltage Emissions

### Test Date

April 23, 2012

### Test Location

Shielded Room

### Test Equipment

	Name of Equipment	Manufacturer	Model No.	Serial No.	Due Date
<input checked="" type="checkbox"/>	EMI TEST RECEIVER	Rohde & Schwarz	ESCI3	100032	2013-02-09
<input checked="" type="checkbox"/>	LISN	Rohde & Schwarz	ENV216	101235	2012-08-18
<input checked="" type="checkbox"/>	LISN	Rohde & Schwarz	ENV216	101236	2012-08-06
<input type="checkbox"/>	EMI Test Receiver	Rohde & Schwarz	ESHS30	828144/002	2013-02-09
<input type="checkbox"/>	LISN	Rohde & Schwarz	ENV216	101150	2013-02-09
<input type="checkbox"/>	LISN	Rohde & Schwarz	ENV216	101151	2012-03-09

### Frequency Range of Measurement

150 kHz to 30 MHz

### Instrument Settings

IF Band Width: 9 kHz

### Test Results

The requirements are:  MET  NOT MET  NOT APPLICABLE

Frequency (MHz)	Measured Data (dB $\mu$ V)	Margin (dB)	Remark
0.523 500	48.4	7.6	Quasi-peak (Battery Charging Mode: Battery Charger 1)

### Remarks

See Appendix A for test data.



CTK Co., Ltd.  
The Prime Leader of Global Regulatory Certification

# CTK Co., Ltd.

386-1, Ho-dong, Cheoin-gu, Yongin-si, Gyeonggi-do, 449-100, Korea

Tel: +82-31-339-9970 Fax: +82-31-339-9855

www.e-ctk.com

## 2.2 Radiated Electric Field Emissions

### Test Date

April 24, 2012

### Test Location

Testing was performed at a test distance of:

- 10 m OATS                       3 m OATS  
 10 m SAC                         3 m SAC

### Test Equipment

	Name of Equipment	Manufacturer	Model No.	Serial No.	Due Date
<input checked="" type="checkbox"/>	EMI TEST RECEIVER	Rohde & Schwarz	ESC17	100814	2012-12-13
<input checked="" type="checkbox"/>	ULTRA Broadband Antenna	Rohde & Schwarz	HL562	100203	2013-07-05
<input checked="" type="checkbox"/>	AMPLIFIER	Sonoma Instrument Co.	310	291721	2013-03-27
<input type="checkbox"/>	EMI TEST RECEIVER	Rohde & Schwarz	ESC17	100816	2012-12-16
<input type="checkbox"/>	Double Ridged Guide Antenna	ETS-Lindgren	3115	00078894	2013-03-22
<input type="checkbox"/>	PREAMPLIFIER	Agilent Technologies	8449B	3008A02307	2012-11-17

### Frequency Range of Measurement

- 30 MHz to 1 GHz  
 1 GHz to \_ GHz

### Instrument Settings

- IF Band Width: 120 kHz  
 IF Band Width: 1 MHz

### Test Results

The requirements are:  MET     NOT MET     NOT APPLICABLE

Frequency (MHz)	Measured Data (dB $\mu$ V/m)	Margin (dB)	Remark
32.183	35.6	4.4	Quasi-peak (USB Printing Mode)

### Remarks

See Appendix A for test data.



## APPENDIX A – TEST DATA

### Conducted Voltage Emissions

[USB Printing Mode: HOT]

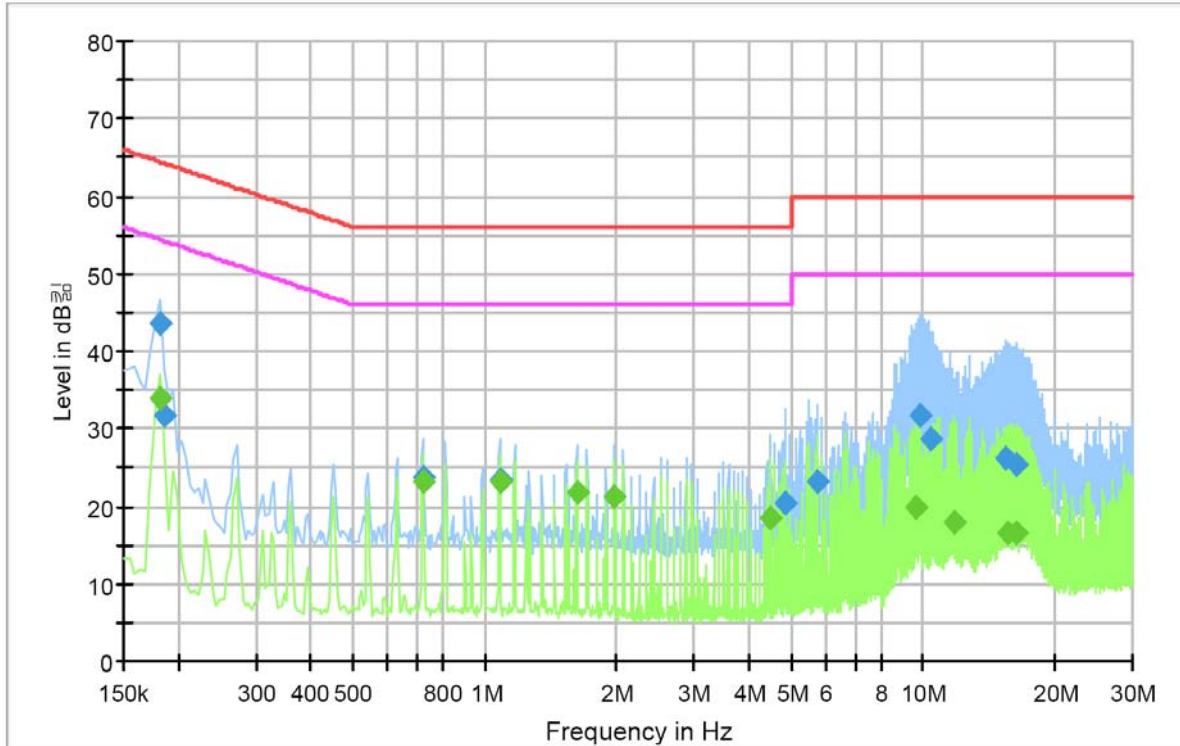

#### Final Result 1

Frequency (MHz)	QuasiPeak (dBμV)	Meas. Time (ms)	Bandwidth (kHz)	Filter	Line	Corr. (dB)	Margin (dB)	Limit (dBμV)
0.181500	43.6	1000.0	9.000	On	L1	10.0	20.9	64.4
0.186000	31.7	1000.0	9.000	On	L1	10.0	32.5	64.2
0.721500	23.6	1000.0	9.000	On	L1	10.1	32.4	56.0
1.081500	23.6	1000.0	9.000	On	L1	10.0	32.4	56.0
4.861500	20.4	1000.0	9.000	On	L1	9.8	35.6	56.0
5.761500	23.2	1000.0	9.000	On	L1	9.8	36.8	60.0
9.852000	31.7	1000.0	9.000	On	L1	9.7	28.3	60.0
10.459500	28.6	1000.0	9.000	On	L1	9.7	31.4	60.0
15.409500	26.3	1000.0	9.000	On	L1	9.8	33.7	60.0
16.417500	25.4	1000.0	9.000	On	L1	9.8	34.6	60.0

#### Final Result 2

Frequency (MHz)	Average (dBμV)	Meas. Time (ms)	Bandwidth (kHz)	Filter	Line	Corr. (dB)	Margin (dB)	Limit (dBμV)
0.181500	33.8	1000.0	9.000	On	L1	10.0	20.6	54.4
0.721500	23.3	1000.0	9.000	On	L1	10.1	22.7	46.0
1.081500	23.3	1000.0	9.000	On	L1	10.0	22.7	46.0
1.621500	21.8	1000.0	9.000	On	L1	9.9	24.2	46.0
1.981500	21.4	1000.0	9.000	On	L1	9.9	24.6	46.0
4.501500	18.6	1000.0	9.000	On	L1	9.8	27.4	46.0
9.631500	19.8	1000.0	9.000	On	L1	9.7	30.2	50.0
11.791500	17.9	1000.0	9.000	On	L1	9.7	32.1	50.0
15.711000	16.5	1000.0	9.000	On	L1	9.8	33.5	50.0
16.417500	16.4	1000.0	9.000	On	L1	9.8	33.6	50.0



# CTK Co., Ltd.

386-1, Ho-dong, Cheoin-gu, Yongin-si, Gyeonggi-do, 449-100, Korea

Tel: +82-31-339-9970 Fax: +82-31-339-9855

www.e-ctk.com

CTK Co., Ltd.  
The Prime Leader of Global Regulatory Certification

[USB Printing Mode: NEUTRAL]

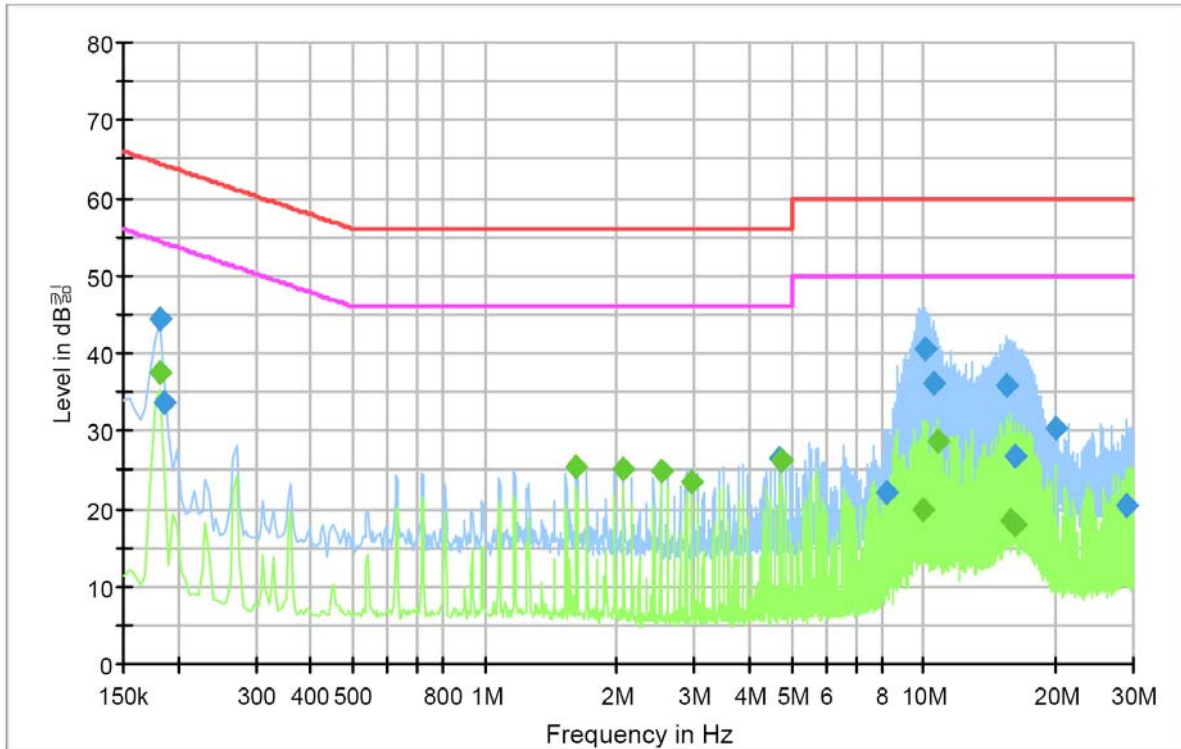

## Final Result 1

Frequency (MHz)	QuasiPeak (dB <sub>μV</sub> )	Meas. Time (ms)	Bandwidth (kHz)	Filter	Line	Corr. (dB)	Margin (dB)	Limit (dB <sub>μV</sub> )
0.181500	44.4	1000.0	9.000	On	N	10.0	20.0	64.4
0.186000	33.6	1000.0	9.000	On	N	10.1	30.6	64.2
4.672500	26.5	1000.0	9.000	On	N	9.8	29.5	56.0
8.268000	22.1	1000.0	9.000	On	N	9.7	37.9	60.0
10.077000	40.5	1000.0	9.000	On	N	9.7	19.5	60.0
10.482000	36.2	1000.0	9.000	On	N	9.7	23.8	60.0
15.517500	35.8	1000.0	9.000	On	N	9.8	24.2	60.0
16.224000	26.7	1000.0	9.000	On	N	9.8	33.3	60.0
20.035500	30.3	1000.0	9.000	On	N	9.9	29.7	60.0
29.044500	20.3	1000.0	9.000	On	N	10.2	39.7	60.0

## Final Result 2

Frequency (MHz)	Average (dB <sub>μV</sub> )	Meas. Time (ms)	Bandwidth (kHz)	Filter	Line	Corr. (dB)	Margin (dB)	Limit (dB <sub>μV</sub> )
0.181500	37.6	1000.0	9.000	On	N	10.0	16.8	54.4
1.617000	25.3	1000.0	9.000	On	N	9.9	20.7	46.0
2.067000	25.1	1000.0	9.000	On	N	9.9	20.9	46.0
2.517000	24.8	1000.0	9.000	On	N	9.9	21.2	46.0
2.967000	23.5	1000.0	9.000	On	N	9.9	22.5	46.0
4.762500	26.3	1000.0	9.000	On	N	9.8	19.7	46.0
9.978000	19.9	1000.0	9.000	On	N	9.7	30.1	50.0
10.783500	28.8	1000.0	9.000	On	N	9.7	21.2	50.0
15.769500	18.5	1000.0	9.000	On	N	9.8	31.5	50.0
16.224000	17.9	1000.0	9.000	On	N	9.8	32.1	50.0





# CTK Co., Ltd.

386-1, Ho-dong, Cheoin-gu, Yongin-si, Gyeonggi-do, 449-100, Korea

Tel: +82-31-339-9970 Fax: +82-31-339-9855

www.e-ctk.com

CTK Co., Ltd.  
The Prime Leader of Global Regulatory Certification

[Serial Printing Mode: HOT]

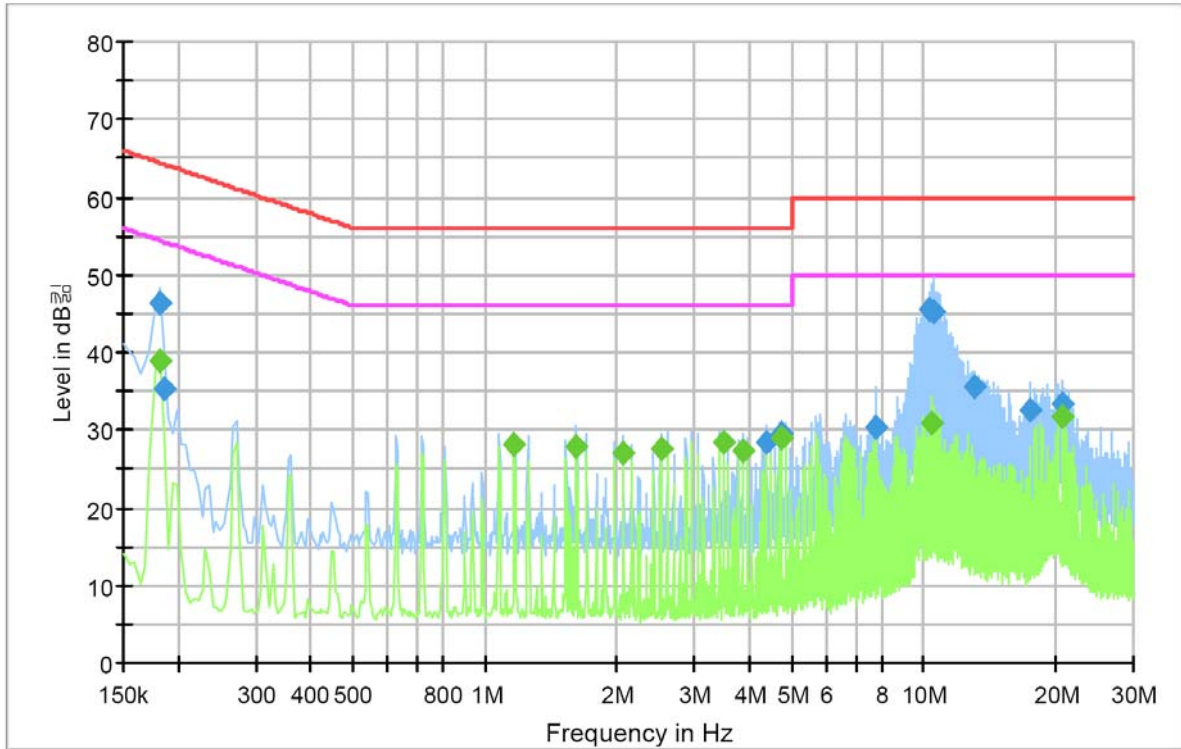

## Final Result 1

Frequency (MHz)	QuasiPeak (dBm)	Meas. Time (ms)	Bandwidth (kHz)	Filter	Line	Corr. (dB)	Margin (dB)	Limit (dBm)
0.181500	46.3	1000.0	9.000	On	L1	10.0	18.1	64.4
0.186000	35.2	1000.0	9.000	On	L1	10.0	29.0	64.2
4.398000	28.5	1000.0	9.000	On	L1	9.8	27.5	56.0
4.758000	29.4	1000.0	9.000	On	L1	9.8	26.6	56.0
7.813500	30.4	1000.0	9.000	On	L1	9.7	29.6	60.0
10.356000	45.6	1000.0	9.000	On	L1	9.7	14.4	60.0
10.509000	45.2	1000.0	9.000	On	L1	9.7	14.8	60.0
13.110000	35.5	1000.0	9.000	On	L1	9.8	24.5	60.0
17.511000	32.4	1000.0	9.000	On	L1	9.8	27.6	60.0
20.634000	33.4	1000.0	9.000	On	L1	9.8	26.6	60.0

## Final Result 2

Frequency (MHz)	Average (dBm)	Meas. Time (ms)	Bandwidth (kHz)	Filter	Line	Corr. (dB)	Margin (dB)	Limit (dBm)
0.181500	39.0	1000.0	9.000	On	L1	10.0	15.4	54.4
1.167000	28.0	1000.0	9.000	On	L1	10.0	18.0	46.0
1.617000	28.0	1000.0	9.000	On	L1	9.9	18.0	46.0
2.067000	27.1	1000.0	9.000	On	L1	9.9	18.9	46.0
2.512500	27.6	1000.0	9.000	On	L1	9.9	18.4	46.0
3.502500	28.3	1000.0	9.000	On	L1	9.8	17.7	46.0
3.862500	27.4	1000.0	9.000	On	L1	9.8	18.6	46.0
4.758000	29.1	1000.0	9.000	On	L1	9.8	16.9	46.0
10.459500	31.0	1000.0	9.000	On	L1	9.7	19.0	50.0
20.634000	31.8	1000.0	9.000	On	L1	9.8	18.2	50.0





CTK Co., Ltd.  
The Prime Leader of Global Regulatory Certification

# CTK Co., Ltd.

386-1, Ho-dong, Cheoin-gu, Yongin-si, Gyeonggi-do, 449-100, Korea

Tel: +82-31-339-9970 Fax: +82-31-339-9855

www.e-ctk.com

[Serial Printing Mode: NEUTRAL]

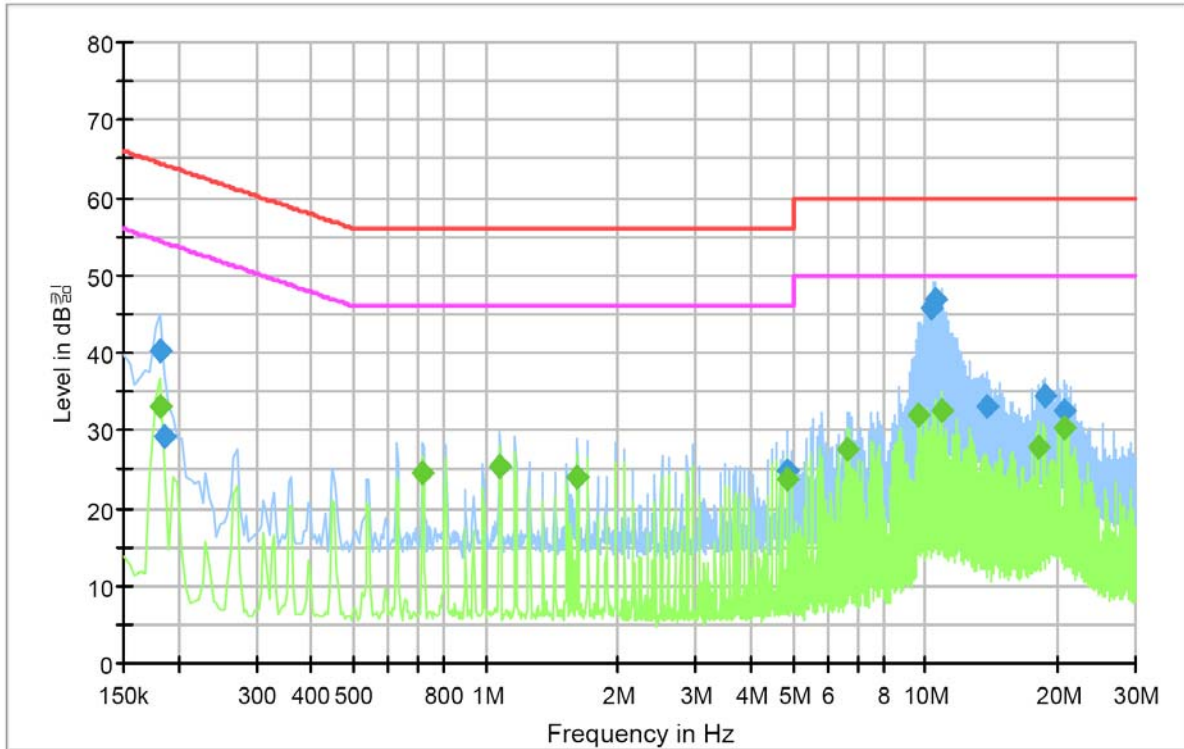

## Final Result 1

Frequency (MHz)	QuasiPeak (dB <sub>μV</sub> )	Meas. Time (ms)	Bandwidth (kHz)	Filter	Line	Corr. (dB)	Margin (dB)	Limit (dB <sub>μV</sub> )
0.181500	40.2	1000.0	9.000	On	N	10.0	24.2	64.4
0.186000	29.3	1000.0	9.000	On	N	10.1	35.0	64.2
1.077000	25.5	1000.0	9.000	On	N	10.0	30.5	56.0
1.617000	24.1	1000.0	9.000	On	N	9.9	31.9	56.0
4.848000	24.9	1000.0	9.000	On	N	9.8	31.1	56.0
10.356000	45.7	1000.0	9.000	On	N	9.7	14.3	60.0
10.509000	46.8	1000.0	9.000	On	N	9.7	13.2	60.0
13.861500	33.1	1000.0	9.000	On	N	9.8	26.9	60.0
18.762000	34.5	1000.0	9.000	On	N	9.9	25.5	60.0
20.638500	32.5	1000.0	9.000	On	N	9.9	27.5	60.0

## Final Result 2

Frequency (MHz)	Average (dB <sub>μV</sub> )	Meas. Time (ms)	Bandwidth (kHz)	Filter	Line	Corr. (dB)	Margin (dB)	Limit (dB <sub>μV</sub> )
0.181500	33.2	1000.0	9.000	On	N	10.0	21.2	54.4
0.717000	24.6	1000.0	9.000	On	N	10.1	21.4	46.0
1.077000	25.3	1000.0	9.000	On	N	10.0	20.7	46.0
1.617000	23.9	1000.0	9.000	On	N	9.9	22.1	46.0
4.848000	23.8	1000.0	9.000	On	N	9.8	22.2	46.0
6.643500	27.5	1000.0	9.000	On	N	9.7	22.5	50.0
9.604500	32.1	1000.0	9.000	On	N	9.7	17.9	50.0
10.860000	32.6	1000.0	9.000	On	N	9.7	17.4	50.0
18.136500	27.8	1000.0	9.000	On	N	9.9	22.2	50.0
20.638500	30.3	1000.0	9.000	On	N	9.9	19.7	50.0



# CTK Co., Ltd.

386-1, Ho-dong, Cheoin-gu, Yongin-si, Gyeonggi-do, 449-100, Korea

Tel: +82-31-339-9970 Fax: +82-31-339-9855

www.e-ctk.com

CTK Co., Ltd.  
The Prime Leader of Global Regulatory Certification

[Battery Charging Mode (Battery Charger 1): HOT]

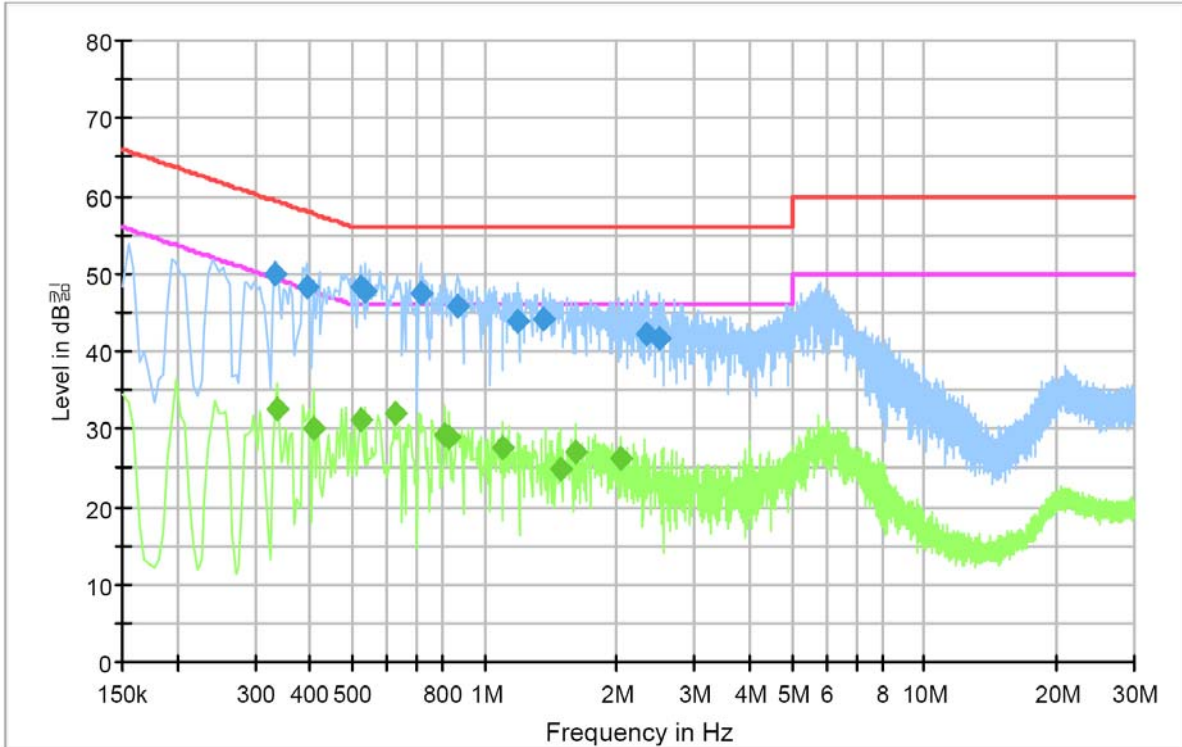

## Final Result 1

Frequency (MHz)	QuasiPeak (dB $\mu$ V)	Meas. Time (ms)	Bandwidth (kHz)	Filter	Line	Corr. (dB)	Margin (dB)	Limit (dB $\mu$ V)
0.334500	49.8	1000.0	9.000	On	L1	10.0	9.5	59.3
0.393000	48.3	1000.0	9.000	On	L1	10.0	9.7	58.0
0.523500	48.4	1000.0	9.000	On	L1	10.0	7.6	56.0
0.537000	47.8	1000.0	9.000	On	L1	10.0	8.2	56.0
0.712500	47.4	1000.0	9.000	On	L1	10.1	8.6	56.0
0.865500	45.9	1000.0	9.000	On	L1	10.0	10.1	56.0
1.194000	43.8	1000.0	9.000	On	L1	10.0	12.2	56.0
1.356000	44.0	1000.0	9.000	On	L1	10.0	12.0	56.0
2.328000	42.3	1000.0	9.000	On	L1	9.9	13.7	56.0
2.494500	41.8	1000.0	9.000	On	L1	9.9	14.2	56.0

## Final Result 2

Frequency (MHz)	Average (dB $\mu$ V)	Meas. Time (ms)	Bandwidth (kHz)	Filter	Line	Corr. (dB)	Margin (dB)	Limit (dB $\mu$ V)
0.339000	32.5	1000.0	9.000	On	L1	10.0	16.7	49.2
0.406500	30.1	1000.0	9.000	On	L1	10.0	17.6	47.7
0.523500	31.2	1000.0	9.000	On	L1	10.0	14.8	46.0
0.622500	32.0	1000.0	9.000	On	L1	10.1	14.0	46.0
0.811500	29.2	1000.0	9.000	On	L1	10.1	16.8	46.0
0.829500	29.0	1000.0	9.000	On	L1	10.1	17.0	46.0
1.104000	27.7	1000.0	9.000	On	L1	10.0	18.3	46.0
1.482000	24.9	1000.0	9.000	On	L1	9.9	21.1	46.0
1.612500	27.1	1000.0	9.000	On	L1	9.9	18.9	46.0
2.044500	26.3	1000.0	9.000	On	L1	9.9	19.7	46.0



CTK Co., Ltd.  
The Prime Leader of Global Regulatory Certification

# CTK Co., Ltd.

386-1, Ho-dong, Cheoin-gu, Yongin-si, Gyeonggi-do, 449-100, Korea

Tel: +82-31-339-9970 Fax: +82-31-339-9855

www.e-ctk.com

[Battery Charging Mode (Battery Charger 1): NEUTRAL]

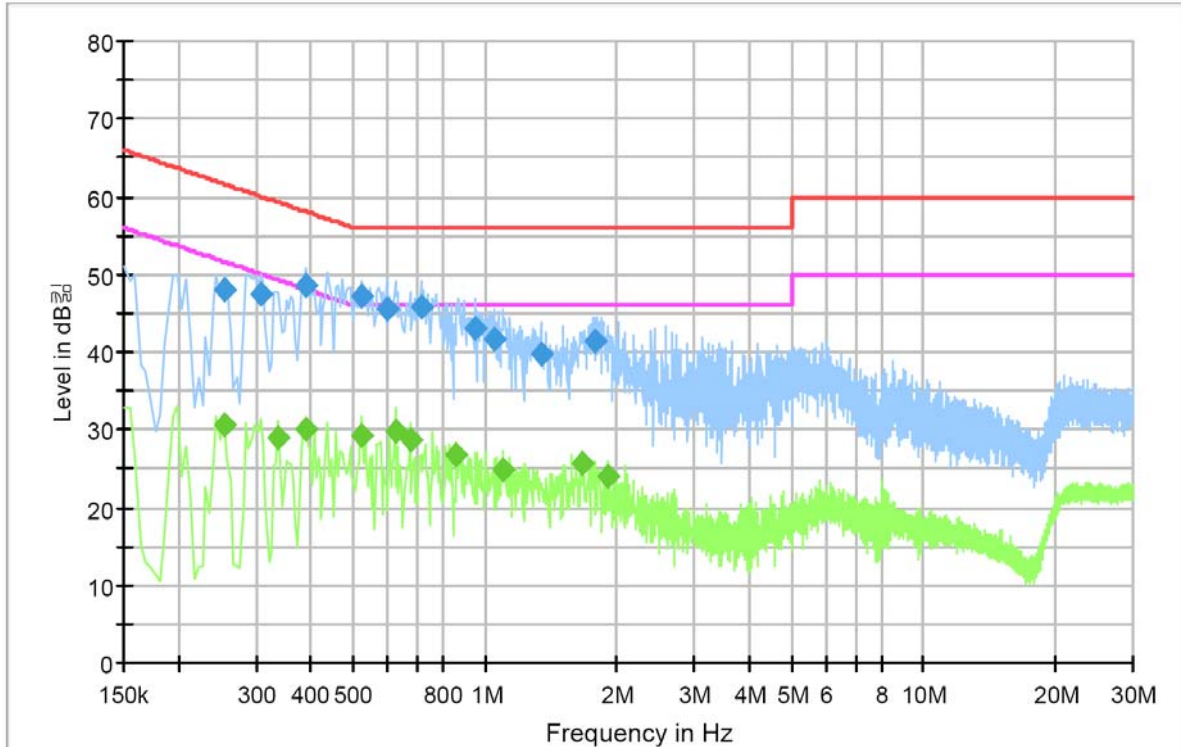

## Final Result 1

Frequency (MHz)	QuasiPeak (dB <sub>μV</sub> )	Meas. Time (ms)	Bandwidth (kHz)	Filter	Line	Corr. (dB)	Margin (dB)	Limit (dB <sub>μV</sub> )
0.253500	47.9	1000.0	9.000	On	N	10.1	13.7	61.6
0.307500	47.3	1000.0	9.000	On	N	10.1	12.7	60.0
0.388500	48.4	1000.0	9.000	On	N	10.0	9.6	58.1
0.523500	47.2	1000.0	9.000	On	N	9.9	8.8	56.0
0.595500	45.6	1000.0	9.000	On	N	10.0	10.4	56.0
0.712500	45.9	1000.0	9.000	On	N	10.1	10.1	56.0
0.951000	43.0	1000.0	9.000	On	N	10.0	13.0	56.0
1.050000	41.7	1000.0	9.000	On	N	10.0	14.3	56.0
1.338000	39.7	1000.0	9.000	On	N	10.0	16.3	56.0
1.774500	41.5	1000.0	9.000	On	N	9.9	14.5	56.0

## Final Result 2

Frequency (MHz)	Average (dB <sub>μV</sub> )	Meas. Time (ms)	Bandwidth (kHz)	Filter	Line	Corr. (dB)	Margin (dB)	Limit (dB <sub>μV</sub> )
0.253500	30.7	1000.0	9.000	On	N	10.1	21.0	51.6
0.339000	29.0	1000.0	9.000	On	N	10.0	20.2	49.2
0.388500	30.2	1000.0	9.000	On	N	10.0	17.9	48.1
0.523500	29.3	1000.0	9.000	On	N	9.9	16.7	46.0
0.622500	29.9	1000.0	9.000	On	N	10.0	16.1	46.0
0.676500	28.8	1000.0	9.000	On	N	10.1	17.2	46.0
0.861000	26.6	1000.0	9.000	On	N	10.0	19.4	46.0
1.099500	24.8	1000.0	9.000	On	N	10.0	21.2	46.0
1.662000	25.6	1000.0	9.000	On	N	9.9	20.4	46.0
1.909500	24.0	1000.0	9.000	On	N	9.9	22.0	46.0



# CTK Co., Ltd.

386-1, Ho-dong, Cheoin-gu, Yongin-si, Gyeonggi-do, 449-100, Korea

Tel: +82-31-339-9970 Fax: +82-31-339-9855

www.e-ctk.com

CTK Co., Ltd.  
The Prime Leader of Global Regulatory Certification

[Battery Charging Mode (Battery Charger 2): HOT]

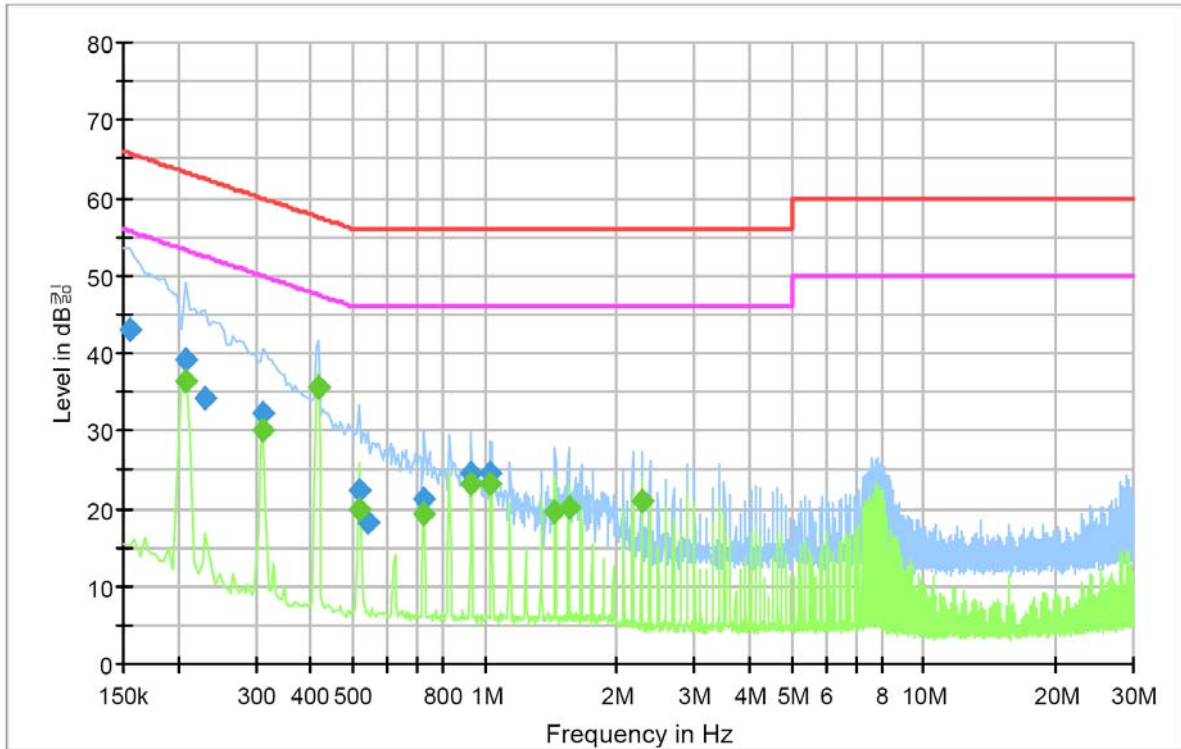

## Final Result 1

Frequency (MHz)	QuasiPeak (dB <sub>μV</sub> )	Meas. Time (ms)	Bandwidth (kHz)	Filter	Line	Corr. (dB)	Margin (dB)	Limit (dB <sub>μV</sub> )
0.154500	43.1	1000.0	9.000	On	L1	10.1	22.7	65.8
0.208500	39.2	1000.0	9.000	On	L1	10.1	24.1	63.3
0.231000	34.3	1000.0	9.000	On	L1	10.1	28.1	62.4
0.312000	32.3	1000.0	9.000	On	L1	10.1	27.6	59.9
0.415500	35.5	1000.0	9.000	On	L1	10.0	22.0	57.5
0.514500	22.2	1000.0	9.000	On	L1	10.0	33.8	56.0
0.541500	18.3	1000.0	9.000	On	L1	10.0	37.7	56.0
0.726000	21.2	1000.0	9.000	On	L1	10.1	34.8	56.0
0.928500	24.5	1000.0	9.000	On	L1	10.0	31.5	56.0
1.032000	24.5	1000.0	9.000	On	L1	10.0	31.5	56.0

## Final Result 2

Frequency (MHz)	Average (dB <sub>μV</sub> )	Meas. Time (ms)	Bandwidth (kHz)	Filter	Line	Corr. (dB)	Margin (dB)	Limit (dB <sub>μV</sub> )
0.208500	36.3	1000.0	9.000	On	L1	10.1	17.0	53.3
0.312000	30.1	1000.0	9.000	On	L1	10.1	19.8	49.9
0.415500	35.5	1000.0	9.000	On	L1	10.0	12.0	47.5
0.519000	19.7	1000.0	9.000	On	L1	10.0	26.3	46.0
0.726000	19.3	1000.0	9.000	On	L1	10.1	26.7	46.0
0.933000	23.1	1000.0	9.000	On	L1	10.0	22.9	46.0
1.032000	23.3	1000.0	9.000	On	L1	10.0	22.7	46.0
1.446000	19.5	1000.0	9.000	On	L1	9.9	26.5	46.0
1.549500	20.2	1000.0	9.000	On	L1	9.9	25.8	46.0
2.274000	21.0	1000.0	9.000	On	L1	9.9	25.0	46.0





# CTK Co., Ltd.

386-1, Ho-dong, Cheoin-gu, Yongin-si, Gyeonggi-do, 449-100, Korea

Tel: +82-31-339-9970 Fax: +82-31-339-9855

www.e-ctk.com

CTK Co., Ltd.  
The Prime Leader of Global Regulatory Certification

[Battery Charging Mode (Battery Charger 2): NEUTRAL]

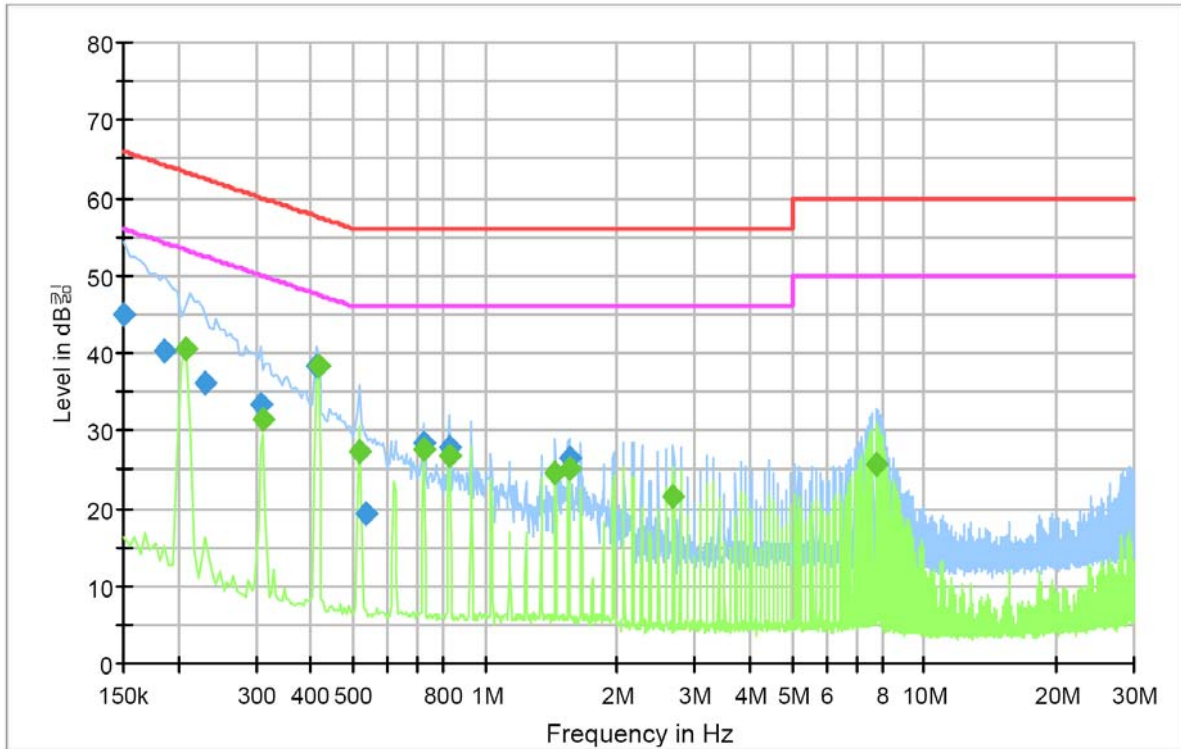

## Final Result 1

Frequency (MHz)	QuasiPeak (dB $\mu$ V)	Meas. Time (ms)	Bandwidth (kHz)	Filter	Line	Corr. (dB)	Margin (dB)	Limit (dB $\mu$ V)
0.150000	45.1	1000.0	9.000	On	N	10.2	20.9	66.0
0.186000	40.2	1000.0	9.000	On	N	10.1	24.0	64.2
0.231000	36.3	1000.0	9.000	On	N	10.2	26.1	62.4
0.307500	33.5	1000.0	9.000	On	N	10.1	26.6	60.0
0.411000	38.4	1000.0	9.000	On	N	10.0	19.2	57.6
0.519000	27.3	1000.0	9.000	On	N	9.9	28.7	56.0
0.537000	19.3	1000.0	9.000	On	N	9.9	36.7	56.0
0.721500	28.3	1000.0	9.000	On	N	10.1	27.7	56.0
0.825000	27.8	1000.0	9.000	On	N	10.1	28.2	56.0
1.549500	26.4	1000.0	9.000	On	N	9.9	29.6	56.0

## Final Result 2

Frequency (MHz)	Average (dB $\mu$ V)	Meas. Time (ms)	Bandwidth (kHz)	Filter	Line	Corr. (dB)	Margin (dB)	Limit (dB $\mu$ V)
0.208500	40.5	1000.0	9.000	On	N	10.2	12.8	53.3
0.312000	31.5	1000.0	9.000	On	N	10.1	18.4	49.9
0.415500	38.3	1000.0	9.000	On	N	10.0	9.2	47.5
0.514500	27.2	1000.0	9.000	On	N	9.9	18.8	46.0
0.721500	27.5	1000.0	9.000	On	N	10.1	18.6	46.0
0.825000	26.7	1000.0	9.000	On	N	10.1	19.3	46.0
1.446000	24.5	1000.0	9.000	On	N	9.9	21.5	46.0
1.549500	25.2	1000.0	9.000	On	N	9.9	20.8	46.0
2.683500	21.5	1000.0	9.000	On	N	9.9	24.5	46.0
7.746000	25.7	1000.0	9.000	On	N	9.7	24.3	50.0

## Radiated Electric Field Emissions

[USB Printing Mode]

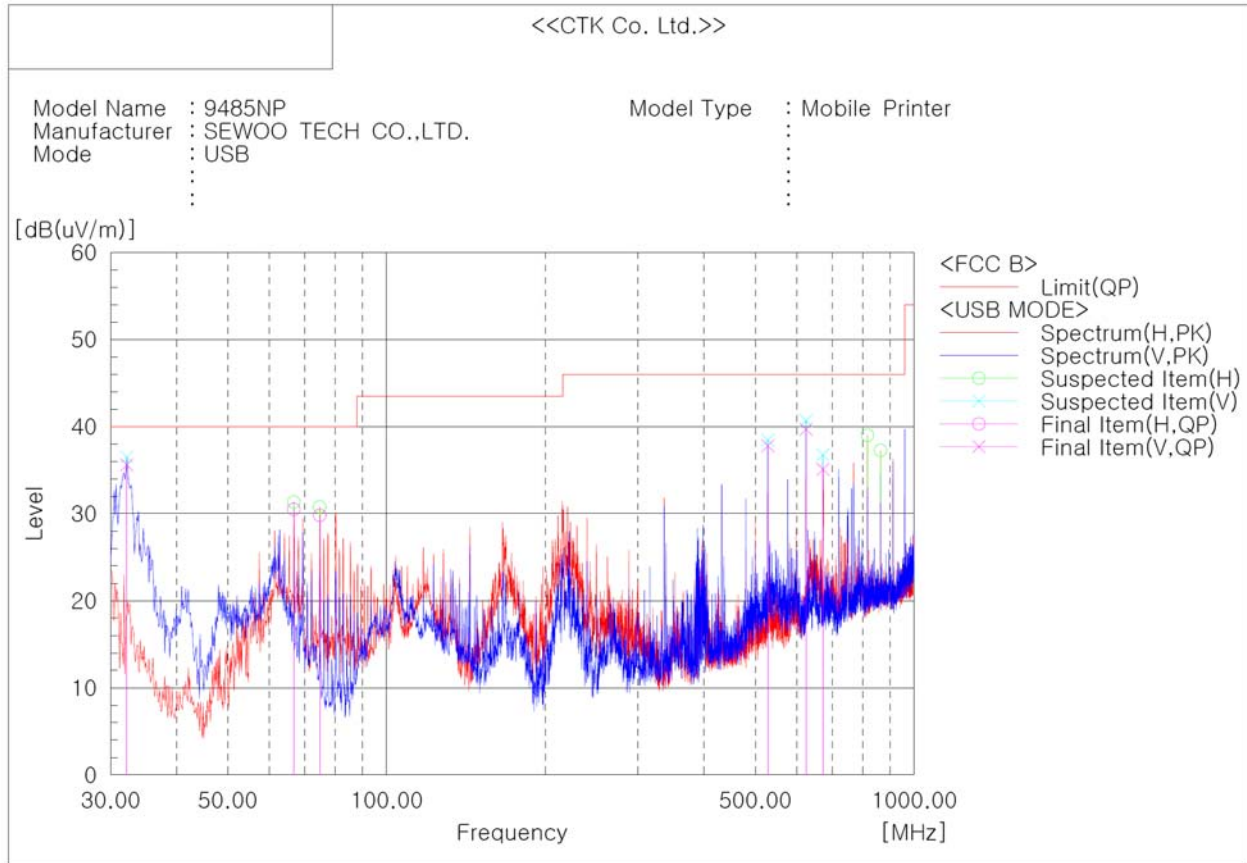

### Final Result

No.	Frequency [MHz]	(P)	Reading QP [dB(uV)]	c.f [dB(1/m)]	Result QP [dB(uV/m)]	Limit QP [dB(uV/m)]	Margin QP [dB]	Height [cm]	Angle [deg]
1	32.183	V	48.9	-13.3	35.6	40.0	4.4	100.0	108.0
2	66.739	H	55.6	-25.1	30.5	40.0	9.5	307.0	253.0
3	74.741	H	52.9	-23.1	29.8	40.0	10.2	209.0	330.0
4	528.095	V	47.6	-9.8	37.8	46.0	8.2	100.0	262.0
5	624.004	V	48.1	-8.4	39.7	46.0	6.3	100.0	224.0
6	672.019	V	42.4	-7.3	35.1	46.0	10.9	100.0	224.0



# CTK Co., Ltd.

386-1, Ho-dong, Cheoin-gu, Yongin-si, Gyeonggi-do, 449-100, Korea

Tel: +82-31-339-9970 Fax: +82-31-339-9855

www.e-ctk.com

CTK Co., Ltd.  
The Prime Leader of Global Regulatory Certification

[Serial Printing Mode]

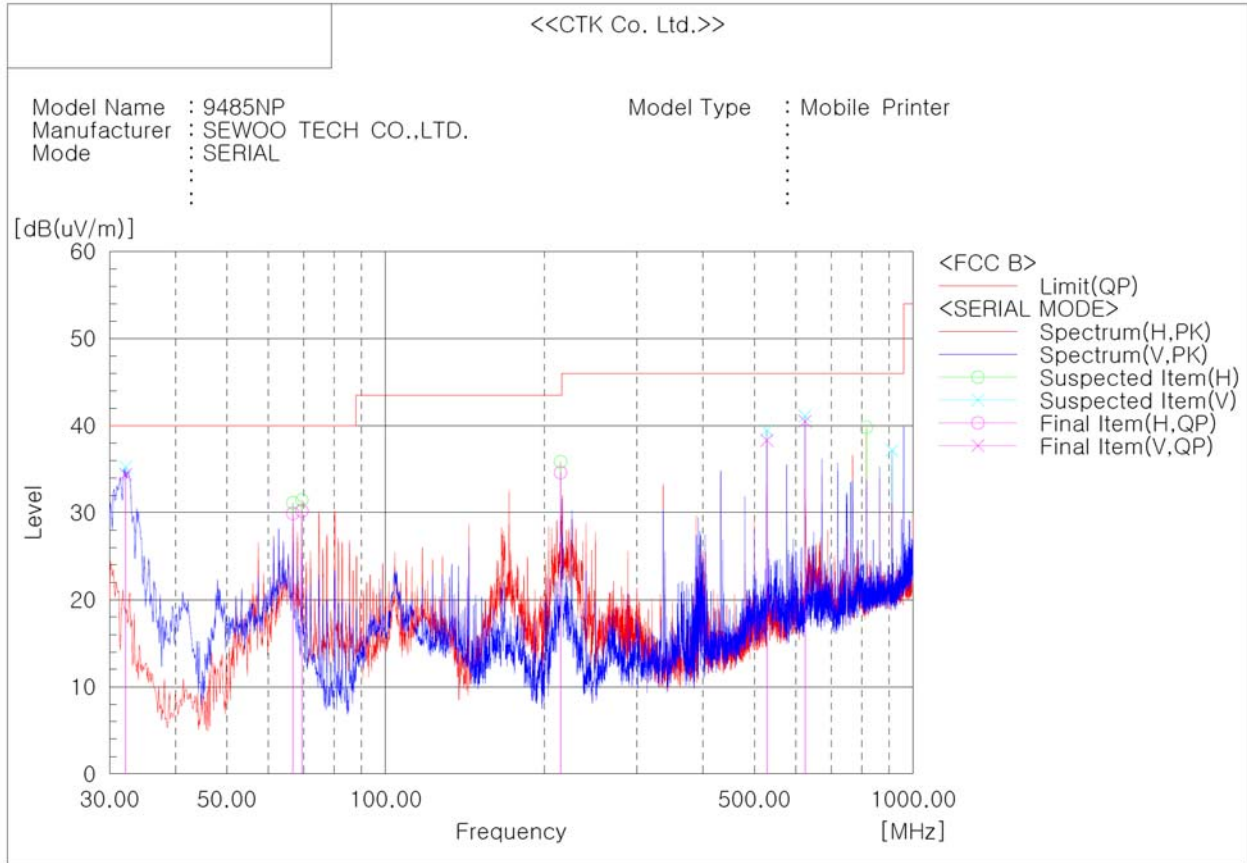

Final Result

No.	Frequency [MHz]	(P)	Reading QP [dB(uV)]	c.f [dB(1/m)]	Result QP [dB(uV/m)]	Limit QP [dB(uV/m)]	Margin QP [dB]	Height [cm]	Angle [deg]
1	32.183	V	47.7	-13.3	34.4	40.0	5.6	100.0	145.0
2	66.739	H	55.0	-25.1	29.9	40.0	10.1	400.0	296.0
3	69.406	H	54.6	-24.4	30.2	40.0	9.8	400.0	108.0
4	214.785	H	55.6	-21.0	34.6	43.5	8.9	209.0	258.0
5	528.095	V	48.1	-9.8	38.3	46.0	7.7	100.0	257.0
6	624.004	V	48.9	-8.4	40.5	46.0	5.5	100.0	220.0









CTK Co., Ltd.  
The Prime Leader of Global Regulatory Certification

# CTK Co., Ltd.

386-1, Ho-dong, Cheoin-gu, Yongin-si, Gyeonggi-do, 449-100, Korea

Tel: +82-31-339-9970 Fax: +82-31-339-9855

www.e-ctk.com

## APPENDIX B - Test Setup Photos and Configuration

### Conducted Voltage Emissions





CTK Co., Ltd.  
The Prime Leader of Global Regulatory Certification

# CTK Co., Ltd.

386-1, Ho-dong, Cheoin-gu, Yongin-si, Gyeonggi-do, 449-100, Korea

Tel: +82-31-339-9970 Fax: +82-31-339-9855

www.e-ctk.com

## Radiated Electric Field Emissions

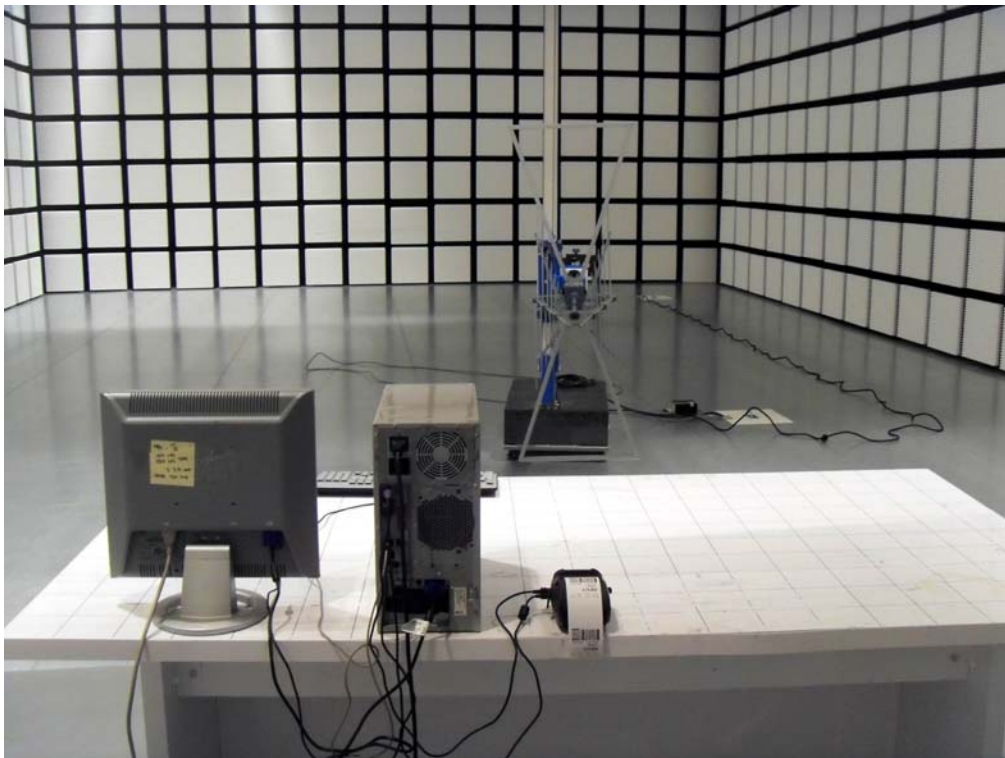
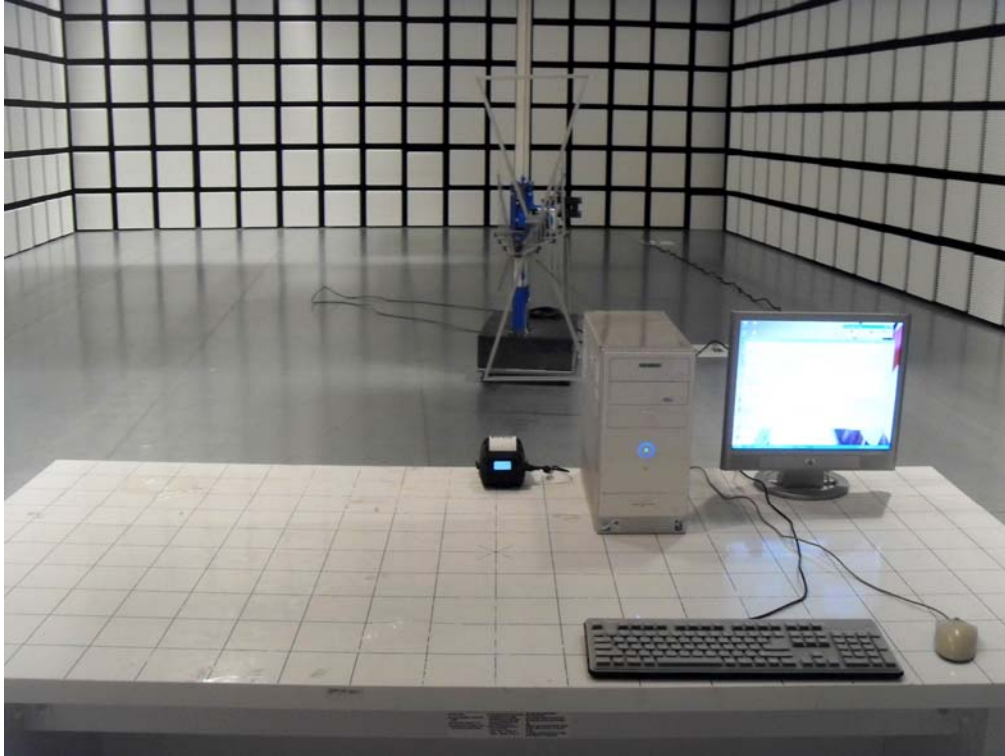



CTK Co., Ltd.  
The Prime Leader of Global Regulatory Certification

## CTK Co., Ltd.

386-1, Ho-dong, Cheoin-gu, Yongin-si, Gyeonggi-do, 449-100, Korea

Tel: +82-31-339-9970 Fax: +82-31-339-9855

www.e-ctk.com

---

## APPENDIX C – EUT Photographs





CTK Co., Ltd.  
The Prime Leader of Global Regulatory Certification

# CTK Co., Ltd.

386-1, Ho-dong, Cheoin-gu, Yongin-si, Gyeonggi-do, 449-100, Korea

Tel: +82-31-339-9970 Fax: +82-31-339-9855

www.e-ctk.com





CTK Co., Ltd.  
The Prime Leader of Global Regulatory Certification

# CTK Co., Ltd.

386-1, Ho-dong, Cheoin-gu, Yongin-si, Gyeonggi-do, 449-100, Korea

Tel: +82-31-339-9970 Fax: +82-31-339-9855

www.e-ctk.com





CTK Co., Ltd.  
The Prime Leader of Global Regulatory Certification

## CTK Co., Ltd.

386-1, Ho-dong, Cheoin-gu, Yongin-si, Gyeonggi-do, 449-100, Korea

Tel: +82-31-339-9970 Fax: +82-31-339-9855

www.e-ctk.com

### EUT Internal Photographs

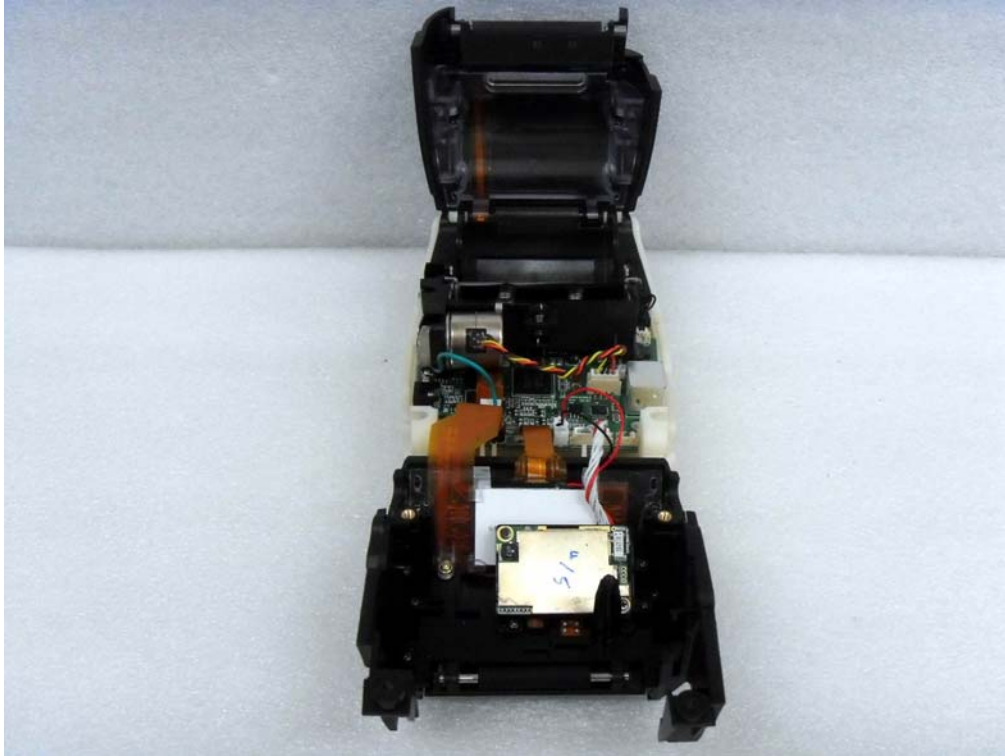





CTK Co., Ltd.  
The Prime Leader of Global Regulatory Certification

# CTK Co., Ltd.

386-1, Ho-dong, Cheoin-gu, Yongin-si, Gyeonggi-do, 449-100, Korea

Tel: +82-31-339-9970 Fax: +82-31-339-9855

www.e-ctk.com

## PCB

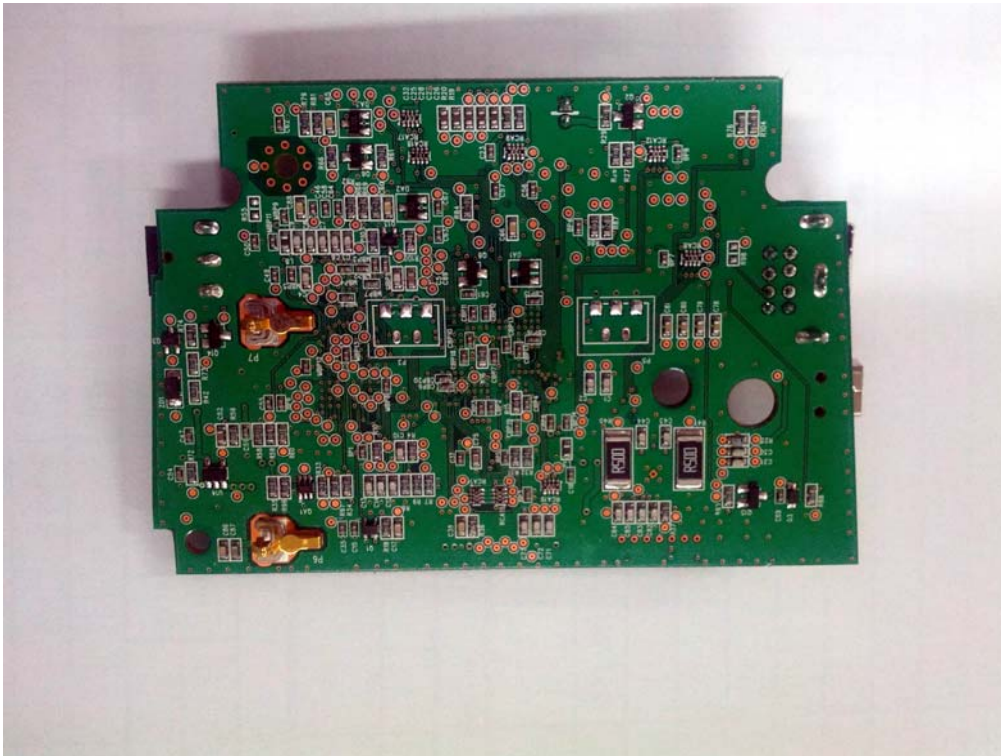





CTK Co., Ltd.  
The Prime Leader of Global Regulatory Certification

# CTK Co., Ltd.

386-1, Ho-dong, Cheoin-gu, Yongin-si, Gyeonggi-do, 449-100, Korea

Tel: +82-31-339-9970 Fax: +82-31-339-9855

www.e-ctk.com

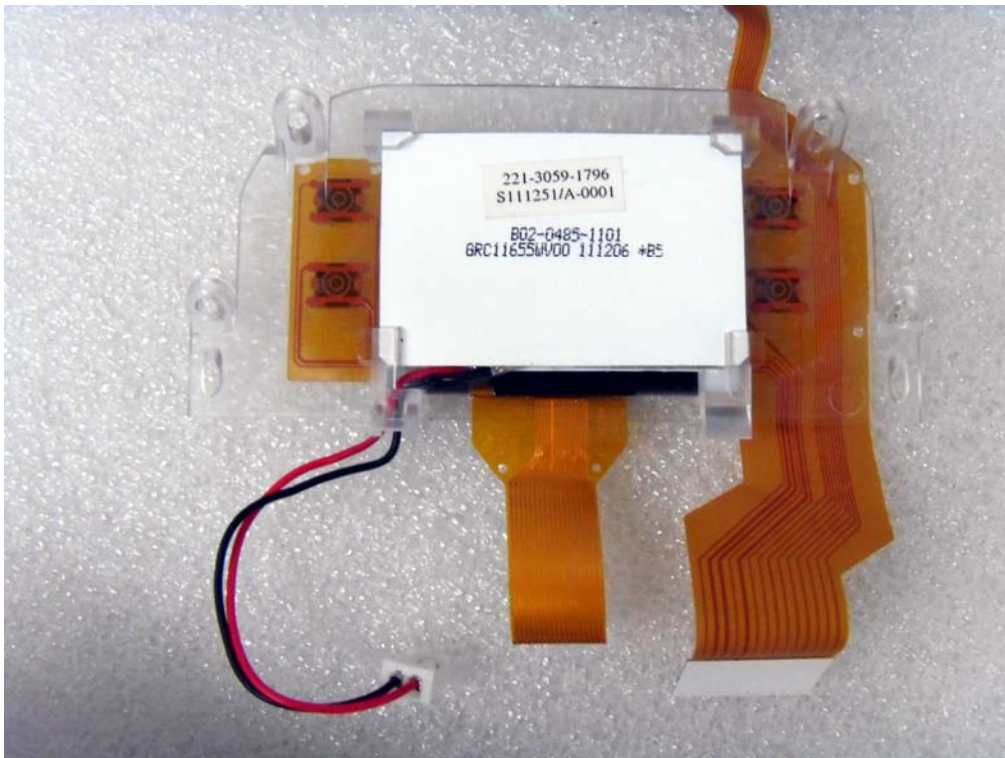
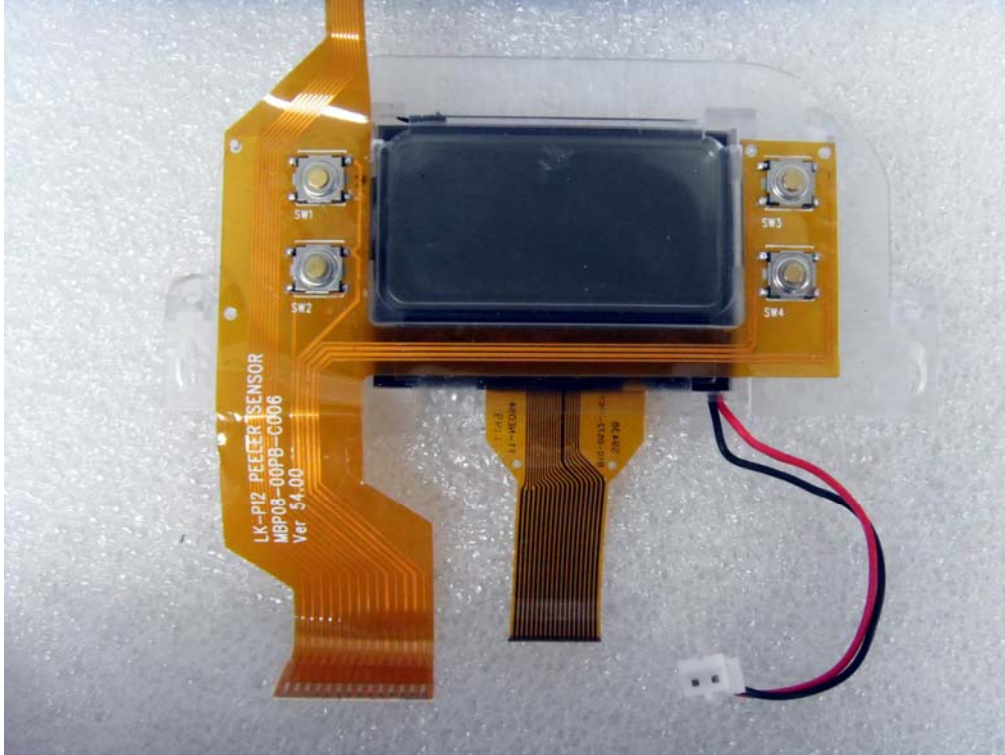



CTK Co., Ltd.  
The Prime Leader of Global Regulatory Certification

# CTK Co., Ltd.

386-1, Ho-dong, Cheoin-gu, Yongin-si, Gyeonggi-do, 449-100, Korea

Tel: +82-31-339-9970 Fax: +82-31-339-9855

www.e-ctk.com







CTK Co., Ltd.  
The Prime Leader of Global Regulatory Certification

# CTK Co., Ltd.

386-1, Ho-dong, Cheoin-gu, Yongin-si, Gyeonggi-do, 449-100, Korea

Tel: +82-31-339-9970 Fax: +82-31-339-9855

www.e-ctk.com

## Battery Charger 1&2

[Battery Charger 1]





CTK Co., Ltd.  
The Prime Leader of Global Regulatory Certification

# CTK Co., Ltd.

386-1, Ho-dong, Cheoin-gu, Yongin-si, Gyeonggi-do, 449-100, Korea

Tel: +82-31-339-9970 Fax: +82-31-339-9855

www.e-ctk.com

[Battery Charger 2]







CTK Co., Ltd.  
The Prime Leader of Global Regulatory Certification

# CTK Co., Ltd.

386-1, Ho-dong, Cheoin-gu, Yongin-si, Gyeonggi-do, 449-100, Korea

Tel: +82-31-339-9970 Fax: +82-31-339-9855

www.e-ctk.com

## Battery





CTK Co., Ltd.  
The Prime Leader of Global Regulatory Certification

# CTK Co., Ltd.

386-1, Ho-dong, Cheoin-gu, Yongin-si, Gyeonggi-do, 449-100, Korea  
Tel: +82-31-339-9970 Fax: +82-31-339-9855  
www.e-ctk.com

## Label and Location



	<b>AVERY DENNISON®</b>	<b>Monarch® 9485NP</b>
<p>This device complies with Part 15 of the FCC Rules. Operation is subject to the following two conditions: 1) this device may not cause harmful interference, and 2) this device must accept any interference that may cause undesired operations.</p> <p>This Class B digital apparatus meets all requirements of the Canadian Interference Causing Equipment Regulations. Cet appareil numérique de la classe B respecte toutes les exigences du Règlement sur le matériel brouilleur du Canada.</p>		
<p><b>DC Input:</b> DC 8.4V  0.8A    <b>CONTAINS FCC ID:</b> N34MK-815WM</p>		
<p><b>FCC ID:</b> GU6-MTT</p>		
<p><b>IC ID:</b> 1502A-MTT</p>		
<p> <b>UL</b> <b>US</b> <b>LISTED</b> L.T.E. 9M03 E147229</p>		<p> <b>2280</b> </p>
<p>Avery Dennison  </p> <p>Country of Origin : South Korea</p>		