

**SHARPER
IMAGE®**

Bluetooth speaker



User Guide
SBT633

In the Box

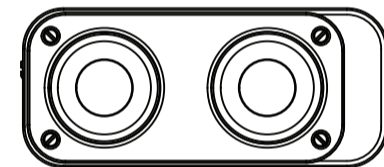

Wireless
Speaker

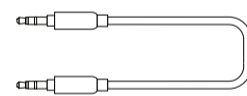

3.5mm
Auxiliary Cable

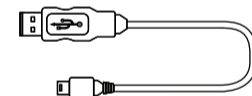

Micro USB
Charging Cable

Pairing the Speaker

1. Turn the speaker ON by switching the [POWER] switch to the ON position. A tone will be heard indicating the speaker has power and the LED indicator will quickly flash BLUE.
2. Set your Bluetooth-enabled device to search for Bluetooth devices. When the Bluetooth-enabled device finds the speaker, select "SBT633" from the list of found devices.
3. After a successful pairing, a tone will be heard indicating that the device is paired and the LED indicator will slowly flash BLUE.

i If a previously paired device is in range when the speaker is turned on, the speaker will connect to it automatically.

On an iOS or Android Device
• Go to **SETTINGS > BLUETOOTH**
(Make sure Bluetooth is turned ON)

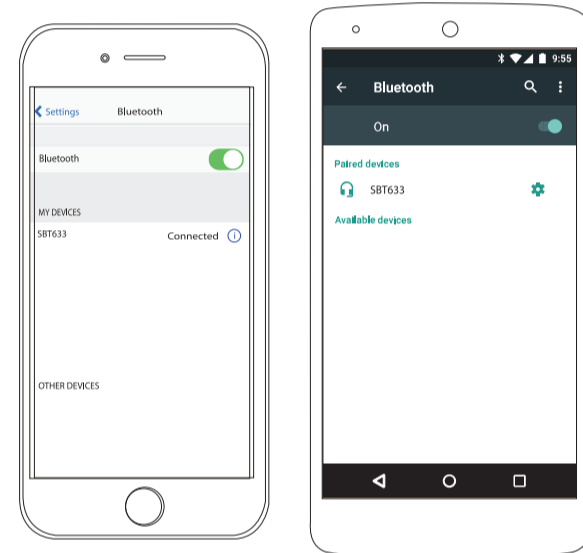

i The screenshots above are typical of many Bluetooth-enabled devices in the market today, and are used to assist in the explanation of the pairing process. Your Bluetooth-enabled device's interface and interaction with the speaker may differ slightly from the illustrations above.

Charging the Speaker

To charge the speaker, connect the small end of the supplied micro USB cable to the micro USB charging port on the side of the speaker and the other end to a computer or USB charging device. The LED indicator will turn RED while charging and turn off when charged.

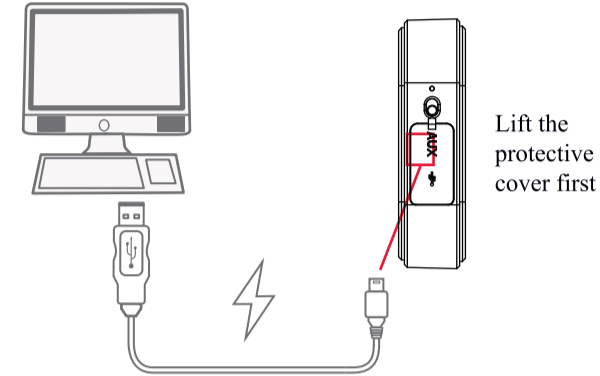

Lift the protective cover first

i Make sure you charge your speaker for at least 4 - 6 hours before using them for the first time.

Using as a Wired Speaker

To use the speaker as a wired device, lift the protective cover and connect one end of a 3.5mm auxiliary cable to the AUX jack on the side of the speaker. Attach the other end to the headphone jack on your media playing device. The LED indicator will flash BLUE.

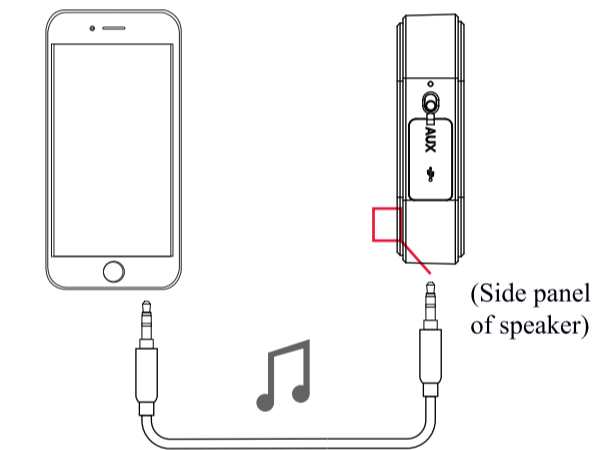

(Side panel of speaker)

i Connecting the audio cable will override Bluetooth mode if it is enabled. When the cable is disconnected, the speaker will automatically reconnect to the last paired device if Bluetooth

Location of Controls

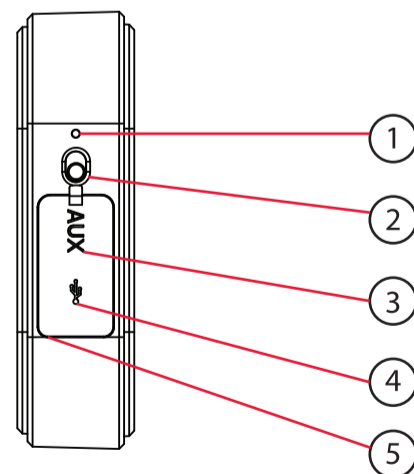

1. LED indicator
2. [POWER] switch
3. AUX-IN port
4. Micro USB charging port
5. Protective cover

(Side panel)

Using the Speaker

Powering ON/OFF

- To turn the speaker ON, flip the [POWER] switch to the ON position.
- To turn the speaker OFF, flip the [POWER] switch to the OFF position.

Playing Music

To enjoy music wirelessly on your speaker, make sure you are paired to a Bluetooth-enabled device. Once paired, you can control the media playback and volume adjustment with the controls on your paired device.

Questions and Customer Support

For further assistance or troubleshooting, please call our customer support line:

Phone: 1-877-768-8481
Monday-Friday 8AM-10PM (EST)

www.southern telecom.com
Click on "Product Support"

Legal Information

READ CAREFULLY AND KEEP THIS MANUAL

Note: This equipment has been tested and found to comply with the limits for a Class B digital device, pursuant to part 15 of the FCC Rules. These limits are designed to provide reasonable protection against harmful interference in a residential installation. This equipment generates, uses and can radiate radio frequency energy and, if not installed and used in accordance with the instructions, may cause harmful interference to radio communications. However, there is no guarantee that interference will not occur in a particular installation. If this equipment does cause harmful interference to radio or television reception, which can be determined by turning the equipment off and on, the user is encouraged to try to correct the interference by one or more of the following measures:

- Reorient or relocate the receiving antenna.
- Increase the separation between the equipment and receiver.
- Connect the equipment into an outlet on a circuit different from that to which the receiver is connected.
- Consult the dealer or an experienced radio/TV technician

Caution: Any changes or modifications to this device not explicitly approved by manufacturer could void your authority to operate this equipment.

This device complies with part 15 of the FCC Rules. Operation is subject to the following two conditions: (1) This device may not cause harmful interference, and (2) this device must accept any interference received, including interference that may cause undesired operation

The device has been evaluated to meet general RF exposure requirement. The device can be used in portable exposure condition without restriction.

Limited Warranty

90 Days Limited Warranty

In the unlikely event that this product is defective, or does not perform properly, you may within ninety (90) days from your original date of purchase return it to the authorized service center for repair or exchange.

TO OBTAIN WARRANTY SERVICE:

- Call the Customer Support number located below, or go to our website portal to receive an SRO number.
- Provide proof of the date of purchase within the package (dated bill of sale).
- Prepay all shipping costs to the authorized service center, and remember to insure your return.
- Include a return shipping address (no P.O. Boxes), a telephone contact number, and the defective unit within the package.
- Describe the defect or reason you are returning the product.

Your product will be repaired or replaced, at our option, for the same or similar model of equal value if examination by the service center determines this product is defective. Products received damaged as a result of shipping will require you to file a claim with the carrier.

The shipping address of the authorized service center is:

Customer Service Dept. 36
c/o Southern Telecom
400 Kennedy Drive
Sayreville, NJ 08872

Should you have any questions or problems concerning this product, please contact our customer service department at:
Customer Support:

Phone: 1-877-768-8481
Monday-Friday 8AM-10PM(EST)

www.southern telecom.com
Click on "Product Support"

Warranty service not provided

This warranty does not cover damage resulting from accident, misuse, abuse, improper installation or operation, lack of reasonable care, and unauthorized modification. This warranty is voided in the event any unauthorized person opens, alters or repairs this product. All products being returned to the authorized service center for repair must be suitably packaged.

Limitation of Warranty:

• THE WARRANTY STATED ABOVE IS THE ONLY WARRANTY APPLICABLE TO THIS PRODUCT. ALL OTHER WARRANTIES, EXPRESS OR IMPLIED (INCLUDING ALL IMPLIED WARRANTIES OF MERCHANTABILITY OR FITNESS FOR A PARTICULAR PURPOSE) ARE HEREBY DISCLAIMED. NO VERBAL OR WRITTEN INFORMATION GIVEN BY AIT, INC. ITS AGENTS, OR EMPLOYEES SHALL CREATE A WARRANTY OR IN ANY WAY INCREASE THE SCOPE OF THIS WARRANTY.

• REPAIR OR REPLACEMENT AS PROVIDED UNDER THIS WARRANTY IS THE EXCLUSIVE REMEDY OF THE CONSUMER. AIT, INC. SHALL NOT BE LIABLE FOR INCIDENTAL OR CONSEQUENTIAL DAMAGES RESULTING FROM THE USE OF THIS PRODUCT OR ARISING OUT OF ANY BREACH OF ANY EXPRESS OR IMPLIED WARRANTY ON THIS PRODUCT. THIS DISCLAIMER OF WARRANTIES AND LIMITED WARRANTY ARE GOVERNED BY THE LAWS OF THE STATE OF NEW YORK. EXCEPT TO THE EXTENT PROHIBITED BY APPLICABLE LAW, ANY IMPLIED WARRANTY OF MERCHANTABILITY OR FITNESS FOR A PARTICULAR PURPOSE ON THIS PRODUCT IS LIMITED TO THE APPLICABLE WARRANTY PERIOD SET FORTH ABOVE.

Some states do not allow the exclusion nor limitation of incidental or consequential damages, or limitations on how long an implied warranty lasts so the above limitations on exclusions may not apply to you. This warranty gives you specific legal rights, and you also may have other rights that vary from state to state.



Sharper Image® name and logo are registered trademarks. Manufactured and marketed by Southern Telecom under license. © Sharper Image. All Rights Reserved.

SHARPER IMAGE®