

FCC TEST REPORT

FOR

Shenzhen Linpa Technology Co.Ltd.

Bluetooth Speaker

Model No.: LBS51

Additional Model No.: Please refer to page 5.

Prepared for : Shenzhen Linpa Technology Co.Ltd.
Address : 114, C8, Flavor Commercial Street, Vanke Dream Town, Longgang District, Shenzhen City, China

Prepared by : Shenzhen LCS Compliance Testing Laboratory Ltd.
Address : 1/F., Xingyuan Industrial Park, Tongda Road, Bao'an Avenue, Bao'an District, Shenzhen, Guangdong, China

Tel : (+86)755-82591330
Fax : (+86)755-82591332
Web : www.LCS-cert.com
Mail : webmaster@LCS-cert.com

Date of receipt of test sample : January 11, 2016
Number of tested samples : 1
Serial number : Prototype
Date of Test : January 11, 2016 – January 18, 2016
Date of Report : January 18, 2016

FCC TEST REPORT
FCC CFR 47 PART 15 C(15.247): 2015

Report Reference No. : **LCS1512211996E**
Date of Issue : January 18, 2016

Testing Laboratory Name..... : **Shenzhen LCS Compliance Testing Laboratory Ltd.**
Address : 1/F., Xingyuan Industrial Park, Tongda Road, Bao'an Avenue,
Bao'an District, Shenzhen, Guangdong, China
Testing Location/ Procedure..... : Full application of Harmonised standards
Partial application of Harmonised standards
Other standard testing method

Applicant's Name : **Shenzhen Linpa Technology Co.Ltd.**
Address : 114, C8, Flavor Commercial Street, Vanke Dream Town,
Longgang District, Shenzhen City, China

Test Specification
Standard : FCC CFR 47 PART 15 C(15.247): 2015
Test Report Form No..... : LCSEMC-1.0
TRF Originator : Shenzhen LCS Compliance Testing Laboratory Ltd.
Master TRF..... : Dated 2011-03

Shenzhen LCS Compliance Testing Laboratory Ltd. All rights reserved.
This publication may be reproduced in whole or in part for non-commercial purposes as long as the Shenzhen LCS Compliance Testing Laboratory Ltd. is acknowledged as copyright owner and source of the material. Shenzhen LCS Compliance Testing Laboratory Ltd. takes no responsibility for and will not assume liability for damages resulting from the reader's interpretation of the reproduced material due to its placement and context.

Test Item Description. : **Bluetooth Speaker**
Trade Mark : Linpa World, Sharper Image, Polaroid, LIMITED TOO,
ART+SOUND
Model/ Type reference..... : LBS51
Ratings : DC 3.7V by battery(1200mAh)
Result : **Positive**

Compiled by:



Supervised by:



Approved by:



Kyle Yin/ File administrators

Glin Lu/ Technique principal

Gavin Liang/ Manager

FCC -- TEST REPORT

| | |
|---|---|
| Test Report No. : LCS1512211996E | <p style="text-align: center;">January 18, 2016 Date of issue</p> |
|---|---|

| |
|---|
| <p>Type / Model..... : LBS51</p> <p>EUT..... : Bluetooth Speaker</p> |
| <p>Applicant..... : Shenzhen Linpa Technology Co.Ltd.</p> <p>Address..... : 114, C8, Flavor Commercial Street, Vanke Dream Town, Longgang District, Shenzhen City, China</p> <p>Telephone..... : /</p> <p>Fax..... : /</p> |
| <p>Manufacturer..... : LINPA WORLD., Ltd</p> <p>Address..... : Three floor, B building, No 178, Jiaozhong Road, Shegu Bridge, tangxia, dongguan, GD</p> <p>Telephone..... : /</p> <p>Fax..... : /</p> |
| <p>Factory..... : LINPA WORLD., Ltd</p> <p>Address..... : Three floor, B building, No 178, Jiaozhong Road, Shegu Bridge, tangxia, dongguan, GD</p> <p>Telephone..... : /</p> <p>Fax..... : /</p> |

| | |
|--------------------|-----------------|
| Test Result | Positive |
|--------------------|-----------------|

The test report merely corresponds to the test sample.
It is not permitted to copy extracts of these test result without the written permission of the test laboratory.

TABLE OF CONTENTS

| Description | Page |
|--|-----------|
| 1. GENERAL INFORMATION | 5 |
| 1.1 Description of Device (EUT) | 5 |
| 1.2 Support equipment List | 5 |
| 1.3 External I/O Cable | 5 |
| 1.4 Description of Test Facility | 6 |
| 1.5 Statement of The Measurement Uncertainty | 6 |
| 1.6 Measurement Uncertainty | 7 |
| 1.7 Description Of Test Modes | 7 |
| 2. TEST METHODOLOGY | 8 |
| 2.1 EUT Configuration | 8 |
| 2.2 EUT Exercise | 8 |
| 2.3 General Test Procedures | 8 |
| 3. SYSTEM TEST CONFIGURATION | 9 |
| 3.1 Justification | 9 |
| 3.2 EUT Exercise Software | 9 |
| 3.3 Special Accessories | 9 |
| 3.4 Block Diagram/Schematics | 9 |
| 3.5 Equipment Modifications | 9 |
| 3.6 Test Setup | 9 |
| 4. SUMMARY OF TEST RESULTS | 10 |
| 5. SUMMARY OF TEST EQUIPMENT | 11 |
| 6. ANTENNA PORT MEASUREMENT | 12 |
| 6.1 Peak Power | 12 |
| 6.2 Frequency Separation And 20 dB Bandwidth | 13 |
| 6.3 Number Of Hopping Frequency | 19 |
| 6.4 Time Of Occupancy (Dwell Time) | 21 |
| 6.5 Conducted Spurious Emissions and Band Edges Test | 24 |
| 7. RADIATED MEASUREMENT | 31 |
| 7.1 Block Diagram of Test Setup | 31 |
| 7.2 Radiated Emission Limit | 32 |
| 7.3 Instruments Setting | 33 |
| 7.4 Test Procedures | 34 |
| 7.5 Results for Radiated Emissions | 37 |
| 7.6 Results for Band edge Testing (Radiated) | 40 |
| 7.7. Power line conducted emissions | 41 |
| 8. ANTENNA REQUIREMENT | 43 |
| 8.1 Standard Applicable | 43 |
| 8.2 Antenna Connected Construction | 43 |

1. GENERAL INFORMATION

1.1 Description of Device (EUT)

EUT : Bluetooth Speaker

Model No. : LBS51

Frequency Range : 2.402-2.480GHz

Channel Number : 79 channels

Channel frequency : 2402.00-2480.00MHz (Channel Number: 79,
Channel Frequency=2402+1(K-1), K=1, 2, 379);

Channel Spacing : 1MHz

Modulation Type : GFSK, π /4-DQPSK

Bluetooth Version : V2.1+EDR

Antenna Gain : Internal antenna, 0dBi(Max.)

Input Voltage : DC 3.7V by battery(1200mAh)

| Additional models No. | | | |
|---|----|----|----|
| PBT595 | -- | -- | -- |
| <i>Remark: PCB board, structure and internal of these model(s) are the same, So no additional models were tested.</i> | | | |

1.2 Support equipment List

| Manufacturer | Description | Model | Serial Number | Certificate |
|--------------|---------------|-----------|---------------|-------------|
| Lenovo | PC | B470 | -- | DOC |
| Lenovo | AC/DC ADAPTER | ADP-90DDB | -- | DOC |

1.3 External I/O Cable

| I/O Port Description | Quantity | Cable |
|----------------------|----------|-------|
| USB | 1 | N/A |
| AUX | 1 | N/A |

1.4 Description of Test Facility

Site Description

EMC Lab. : CNAS Registration Number. is L4595.
FCC Registration Number. is 899208.
Industry Canada Registration Number. is 9642A-1.
VCCI Registration Number. is C-4260 and R-3804.
ESMD Registration Number. is ARCB0108.
UL Registration Number. is 100571-492.
TUV SUD Registration Number. is SCN1081.
TUV RH Registration Number. is UA 50296516-001

1.5 Statement of The Measurement Uncertainty

The data and results referenced in this document are true and accurate. The reader is cautioned that there may be errors within the calibration limits of the equipment and facilities. The measurement uncertainty was calculated for all measurements listed in this test report acc. To CISPR 16 – 4 “Specification for radio disturbance and immunity measuring apparatus and methods – Part 4: Uncertainty in EMC Measurements” and is documented in the LCS quality system acc. To DIN EN ISO/IEC 17025. Furthermore, component and process variability of devices similar to that tested may result in additional deviation. The manufacturer has the sole responsibility of continued compliance of the device.

1.6 Measurement Uncertainty

| Test Item | Frequency Range | Uncertainty | Note |
|------------------------|-----------------|-------------|------|
| Radiation Uncertainty | 9KHz~30MHz | 3.10dB | (1) |
| | 30MHz~200MHz | 2.96dB | (1) |
| | 200MHz~1000MHz | 3.10dB | (1) |
| | 1GHz~26.5GHz | 3.80dB | (1) |
| | 26.5GHz~40GHz | 3.90dB | (1) |
| Conduction Uncertainty | 150kHz~30MHz | 1.63dB | (1) |
| Power disturbance | 30MHz~300MHz | 1.60dB | (1) |

(1). This uncertainty represents an expanded uncertainty expressed at approximately the 95% confidence level using a coverage factor of $k=2$.

1.7 Description Of Test Modes

Bluetooth operates in the unlicensed ISM Band at 2.4GHz. With the introduction of the enhanced data rate (EDR) feature, the data rates can be up to 2 Mb/s. An increase in the peak data rate beyond the basic rate of 1 Mb/s is achieved by modulating the RF carrier using GFSK techniques, resulting in an increase of two to three times the number of bits per symbol. The 2 Mb/s EDR packets use $\pi/4$ -DQPSK modulation. X, Y, Z position have been tested. The following operating modes were applied for the related test items. All test modes were tested, only the result of the worst case was recorded in the report.

| Mode of Operations | Frequency Range (MHz) | Data Rate (Mbps) |
|------------------------|-----------------------|------------------|
| GFSK | 2402 | 1 |
| | 2441 | 1 |
| | 2480 | 1 |
| $\pi/4$ DQPSK | 2402 | 2 |
| | 2441 | 2 |
| | 2480 | 2 |
| For Conducted Emission | | |
| Test Mode | TX Mode | |
| For Radiated Emission | | |
| Test Mode | TX Mode | |

Worst-case mode and channel used for 150kHz-30 MHz power line conducted emissions was the mode and channel with the highest output power, that was determined to be TX(1Mbps- Low Channel).

Worst-case mode and channel used for 9kHz-1000 MHz radiated emissions was the mode and channel with the highest output power, that was determined to be TX(1Mbps---Low Channel).

2. TEST METHODOLOGY

The tests documented in this report were performed in accordance with ANSI C63.10-2013, FCC CFR PART 15C 15.207, 15.209, 15.247 and DA 00-705.

2.1 EUT Configuration

The EUT configuration for testing is installed on RF field strength measurement to meet the Commissions requirement and operating in a manner that intends to maximize its emission characteristics in a continuous normal application.

2.2 EUT Exercise

The EUT was operated in the engineering mode to fix the TX frequency that was for the purpose of the measurements.

According to its specifications, the EUT must comply with the requirements of the Section 15.207, 15.209, 15.247 under the FCC Rules Part 15 Subpart C.

2.3 General Test Procedures

2.3.1 Conducted Emissions

The EUT is placed on the turntable, which is 0.8 m above ground plane. According to the requirements in Section 6.2.1 of ANSI C63.10-2013 Conducted emissions from the EUT measured in the frequency range between 0.15 MHz and 30MHz using Quasi-peak and average detector modes.

2.3.2 Radiated Emissions

The EUT is placed on a turn table 0.8 meter above ground for below 1GHz and 1.5m for above 1GHz. The turntable shall rotate 360 degrees to determine the position of maximum emission level. EUT is set 3m away from the receiving antenna, which varied from 1m to 4m to find out the highest emission. And also, each emission was to be maximized by changing the polarization of receiving antenna both horizontal and vertical. In order to find out the maximum emissions, exploratory radiated emission measurements were made according to the requirements in Section 6.3 of ANSI C63.10-2013

3. SYSTEM TEST CONFIGURATION

3.1 Justification

The system was configured for testing in a continuous transmit condition.

3.2 EUT Exercise Software

N/A.

3.3 Special Accessories

N/A.

3.4 Block Diagram/Schematics

Please refer to the related document.

3.5 Equipment Modifications

Shenzhen LCS Compliance Testing Laboratory Ltd. has not done any modification on the EUT.

3.6 Test Setup

Please refer to the test setup photo.

4. SUMMARY OF TEST RESULTS

| Applied Standard: FCC Part 15 Subpart C | | |
|---|--|-----------|
| FCC Rules | Description of Test | Result |
| §15.247(a) | Maximum Conducted Output Power | Compliant |
| §15.247(c) | Frequency Separation And 20 dB Bandwidth | Compliant |
| §15.247(a)(1)(ii) | Number Of Hopping Frequency | Compliant |
| §15.247(a)(1)(iii) | Time Of Occupancy (Dwell Time) | Compliant |
| §15.209, §15.205 | Conducted Spurious Emissions and Band Edges Test | Compliant |
| §15.209, §15.247(d) | Radiated and Conducted Spurious Emissions | Compliant |
| §15.205 | Emissions at Restricted Band | Compliant |
| §15.207(a) | Conducted Emissions | Compliant |
| §15.203 | Antenna Requirements | Compliant |
| §15.247(i) §2.1093 | RF Exposure | Compliant |

5. SUMMARY OF TEST EQUIPMENT

| Item | Equipment | Manufacturer | Model No. | Serial No. | Last Cal. | Next Cal. |
|------|--------------------------|--------------------|----------------------------------|-------------|------------|------------|
| 1 | Power Sensor | R&S | NRV-Z51 | 100458 | 2015-06-18 | 2016-06-17 |
| 2 | Power Sensor | R&S | NRV-Z32 | 10057 | 2015-06-18 | 2016-06-17 |
| 3 | Power Meter | R&S | NRVS | 100444 | 2015-06-18 | 2016-06-17 |
| 4 | DC Filter | MPE | 23872C | N/A | 2015-06-18 | 2016-06-17 |
| 5 | RF Cable | Harbour Industries | 1452 | N/A | 2015-06-18 | 2016-06-17 |
| 6 | SMA Connector | Harbour Industries | 9625 | N/A | 2015-06-18 | 2016-06-17 |
| 7 | Spectrum Analyzer | Agilent | N9020A | MY50510140 | 2015-10-27 | 2016-10-26 |
| 8 | Signal analyzer | Agilent | E4448A(External mixers to 40GHz) | US44300469 | 2015-06-16 | 2016-06-15 |
| 9 | RF Cable | Hubersuhne | Sucoflex104 | FP2RX2 | 2015-06-18 | 2016-06-17 |
| 10 | 3m Semi Anechoic Chamber | SIDT FRANKONIA | SAC-3M | 03CH03-HY | 2015-06-18 | 2016-06-17 |
| 11 | Amplifier | SCHAFFNER | COA9231A | 18667 | 2015-06-18 | 2016-06-17 |
| 12 | Amplifier | Agilent | 8449B | 3008A02120 | 2015-06-16 | 2016-06-15 |
| 13 | Amplifier | MITEQ | AMF-6F-260400 | 9121372 | 2015-06-16 | 2016-06-15 |
| 14 | Loop Antenna | R&S | HFH2-Z2 | 860004/001 | 2015-06-18 | 2016-06-17 |
| 15 | By-log Antenna | SCHWARZBECK | VULB9163 | 9163-470 | 2015-06-10 | 2016-06-09 |
| 16 | Horn Antenna | EMCO | 3115 | 6741 | 2015-06-10 | 2016-06-09 |
| 17 | Horn Antenna | SCHWARZBECK | BBHA9170 | BBHA9170154 | 2015-06-10 | 2016-06-09 |
| 18 | RF Cable-R03m | Jye Bao | RG142 | CB021 | 2015-06-18 | 2016-06-17 |
| 19 | RF Cable-HIGH | SUHNER | SUCOFLEX 106 | 03CH03-HY | 2015-06-18 | 2016-06-17 |
| 20 | EMI Test Receiver | ROHDE & SCHWARZ | ESCI | 101142 | 2015-06-18 | 2016-06-17 |
| 21 | EMI Test Receiver | ROHDE & SCHWARZ | ESPI | 101840 | 2015-06-18 | 2016-06-17 |
| 22 | Artificial Mains | ROHDE & SCHWARZ | ENV216 | 101288 | 2015-06-18 | 2016-06-17 |
| 23 | EMI Test Software | AUDIX | E3 | N/A | 2015-06-18 | 2016-06-17 |

6. ANTENNA PORT MEASUREMENT

6.1 Peak Power

6.1.1 Block Diagram of Test Setup

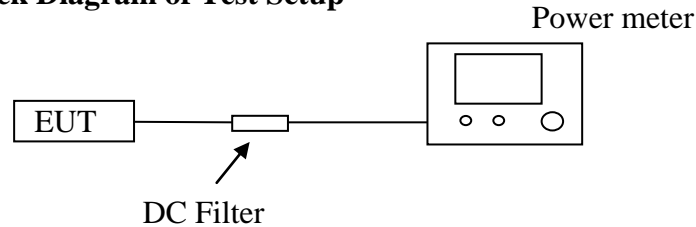

6.1.2 Limit

According to § 15.247(a)(1), For frequency hopping systems operating in the 2400-2483.5 MHz band may have hopping channel carrier frequencies that are separated by 25 kHz or two-thirds of the 20 dB bandwidth of the hopping channel, whichever is greater, provided the systems operate with an output power no greater than 125mW..

6.1.3 Test Procedure

The transmitter output is connected to the Power Meter.

6.1.4 Test Results

| Channel | Frequency (MHz) | Peak Output Power (dBm) | Peak Output Power (mW) | Limit (mW) | Result |
|--------------------|-----------------|-------------------------|------------------------|------------|--------|
| GFSK | 2402 | 4.36 | 2.73 | 1000 | Pass |
| | 2441 | 4.53 | 2.84 | 1000 | Pass |
| | 2480 | 4.45 | 2.79 | 1000 | Pass |
| π / 4-DQPSK | 2402 | 3.16 | 2.07 | 125 | Pass |
| | 2441 | 3.28 | 2.13 | 125 | Pass |
| | 2480 | 3.17 | 2.07 | 125 | Pass |

6.2 Frequency Separation And 20 dB Bandwidth

6.2.1 Limit

According to §15.247(c), in any 100 kHz bandwidth outside the frequency bands in which the spread spectrum intentional radiator is operating, the radio frequency power that is produced by the intentional radiator shall be at least 20dB below that in the 100kHz bandwidth within the band that contains the highest level of the desired power. In addition, radiated emissions which fall in the restricted bands, as defined in §15.205(a), must also comply with the radiated emission limits specified in 15.209(a).

6.2.2 Block Diagram of Test Setup

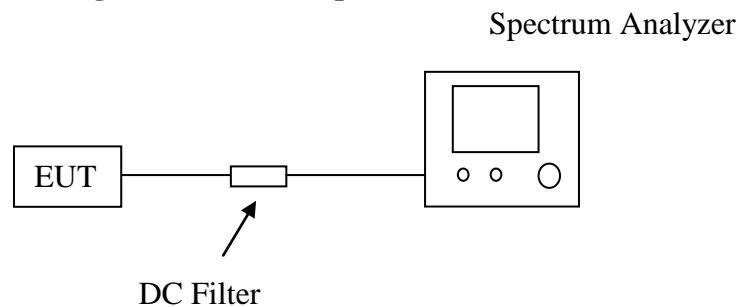

6.2.3 Test Procedure

Frequency separation test procedure:

- A. Place the EUT on the table and set it in transmitting mode.
- B. Remove the antenna from the EUT and then connect a low loss RF cable from the antenna port to the Spectrum Analyzer.
- C. Set center frequency of Spectrum Analyzer = middle of hopping channel.
- D. Set the Spectrum Analyzer as RBW = 100kHz, VBW = 300kHz, Span = wide enough to capture the peaks of two adjacent channels, Sweep = auto.
- E. Max hold, mark 2 peaks of hopping channel and record the 2 peaks frequency.

20dB bandwidth test procedure:

- A. Span = approximately 2 to 3 times the 20 dB bandwidth, centered on a hopping channel.
- B. $RBW \geq 1\%$ of the 20 dB bandwidth, $VBW \geq RBW$.
- C. Detector function = peak.
- D. Trace = max hold.

6.2.4 Test Results

| The Measurement Result With 1Mbps For GFSK Modulation | | | | |
|--|-----------------------------|---------------------------------|---------------------------|---------------|
| Channel | 20dB Bandwidth (KHz) | Channel Separation (MHz) | Limit (MHz) | Result |
| Low | 734.851 | 1.000 | ≥ 25 KHz or 20 dB BW | Pass |
| Middle | 821.810 | | ≥ 25 KHz or 20 dB BW | Pass |
| High | 830.958 | | ≥ 25 KHz or 20 dB BW | Pass |

| The Measurement Result With 2Mbps For $\pi/4$ DQPSK Modulation | | | | |
|--|-----------------------------|---------------------------------|-------------------------------|---------------|
| Channel | 20dB Bandwidth (MHz) | Channel Separation (MHz) | Limit (MHz) | Result |
| Low | 1.132 | 1.000 | ≥ 25 KHz or 2/3 20 dB BW | Pass |
| Middle | 1.129 | | ≥ 25 KHz or 2/3 20 dB BW | Pass |
| High | 1.126 | | ≥ 25 KHz or 2/3 20 dB BW | Pass |

The test data refer to the following page.

Test Plot Of Frequency Separation (1Mbps)

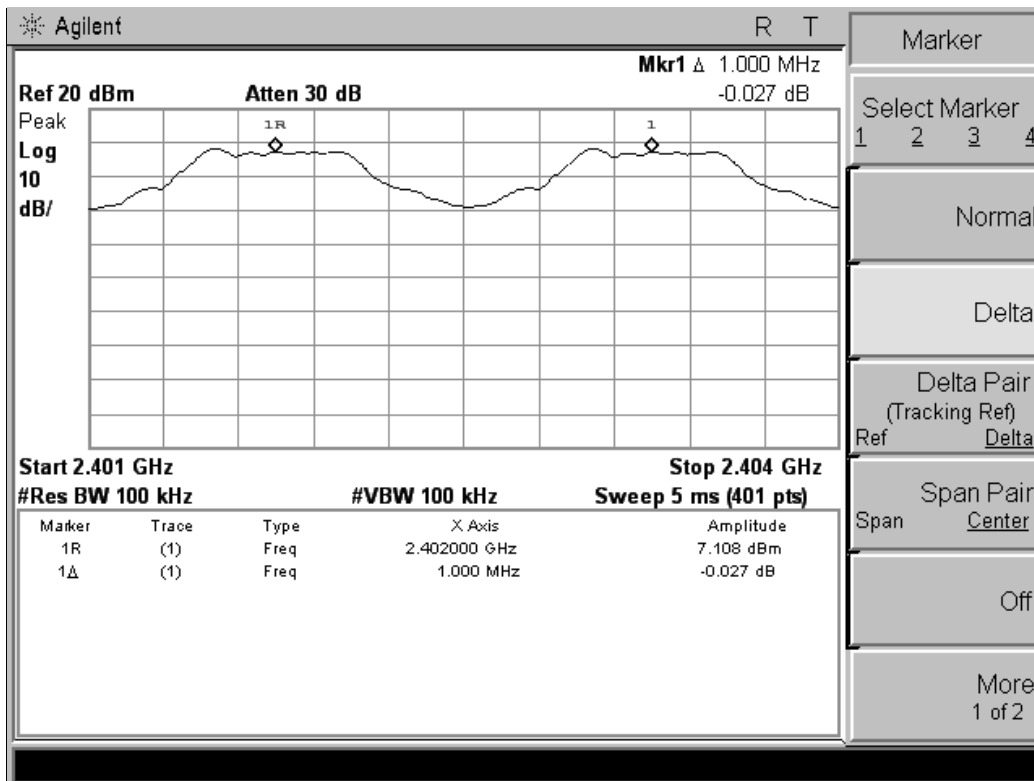

Test Plot Of Frequency Separation (2Mbps)

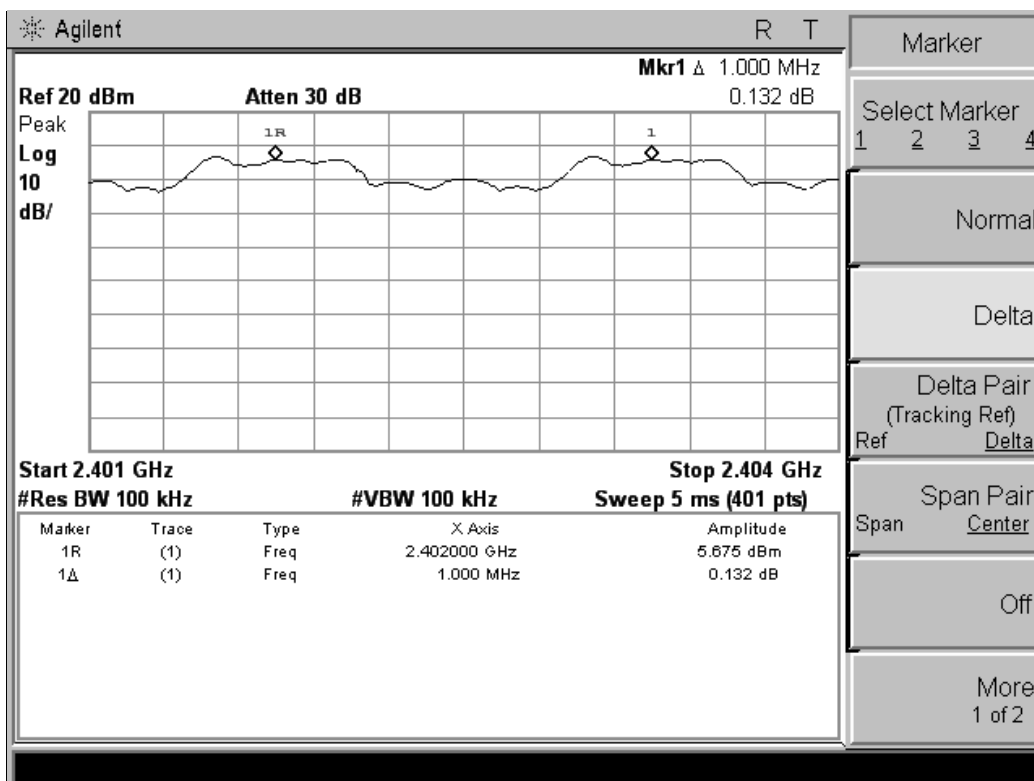

Measurement of 20dB Bandwidth

Test frequency: 2402MHz(1Mbps)

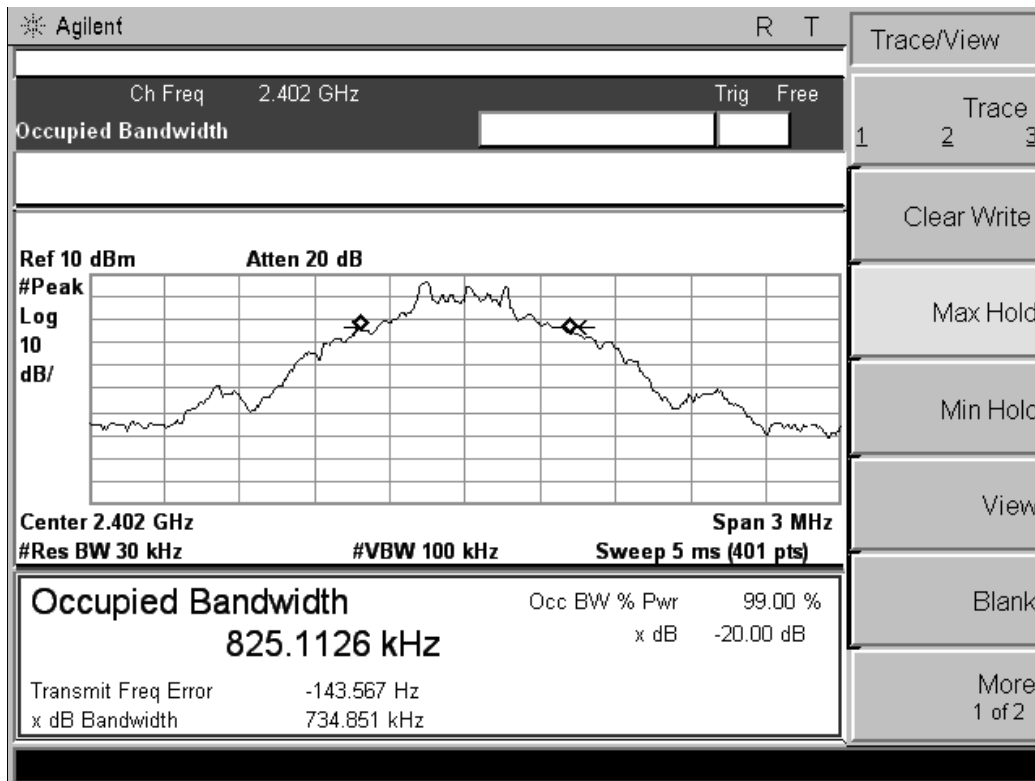

Test frequency: 2441MHz(1Mbps)

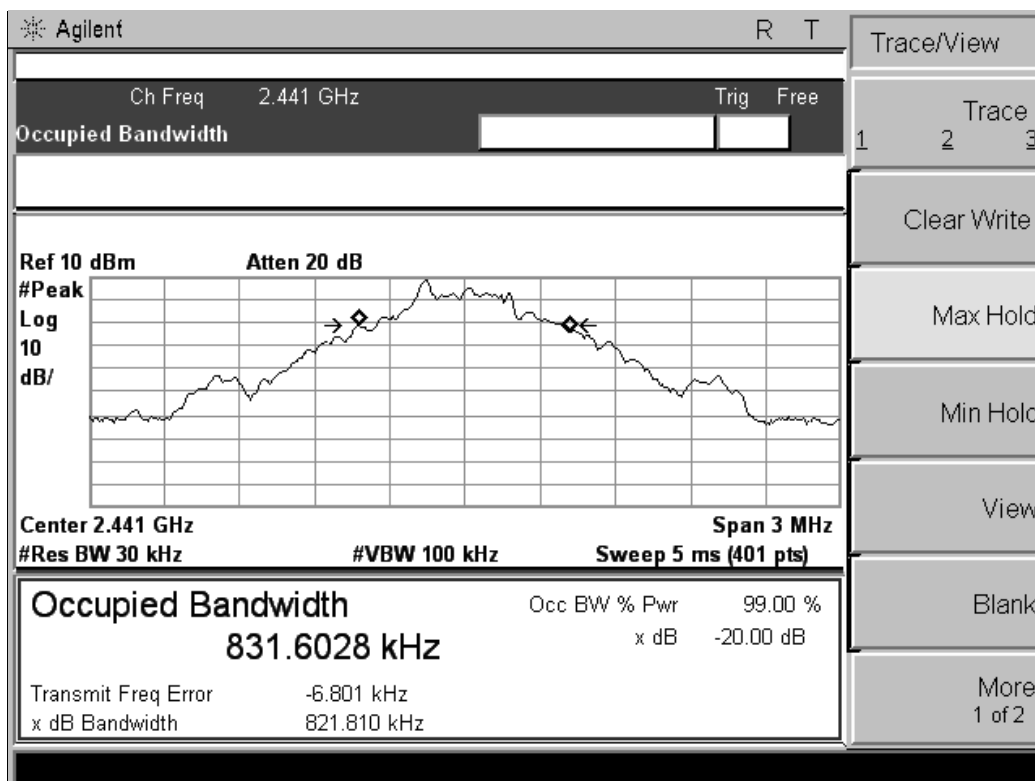

Test frequency: 2480MHz(1Mbps)

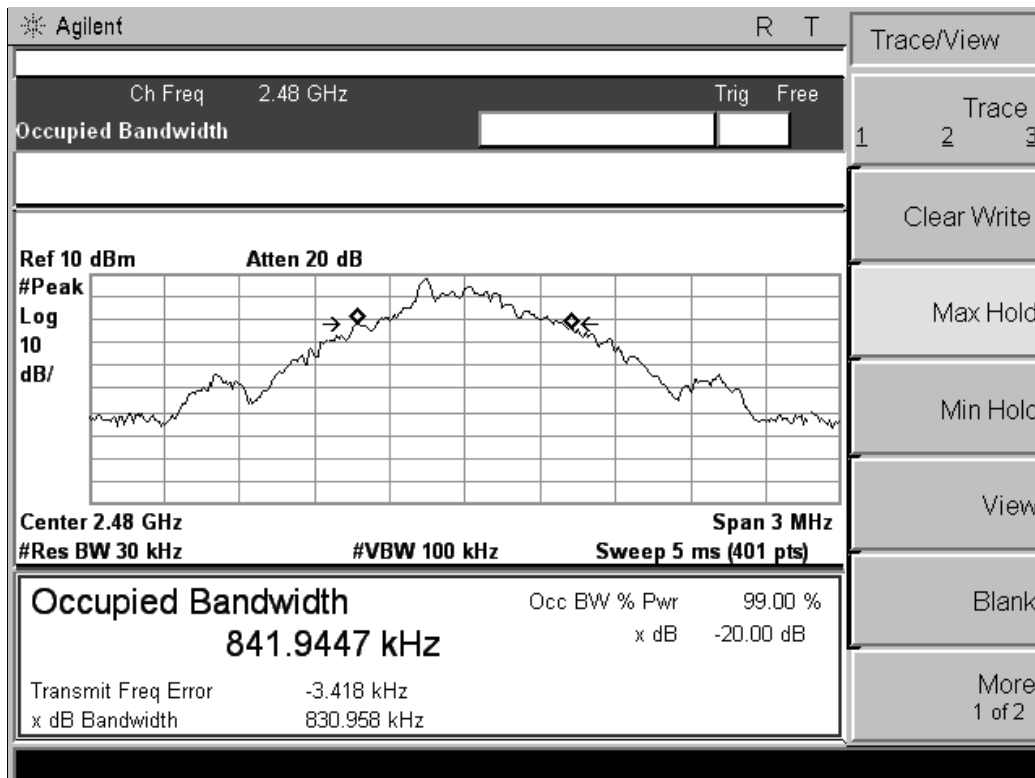

Test frequency: 2402MHz(2Mbps)

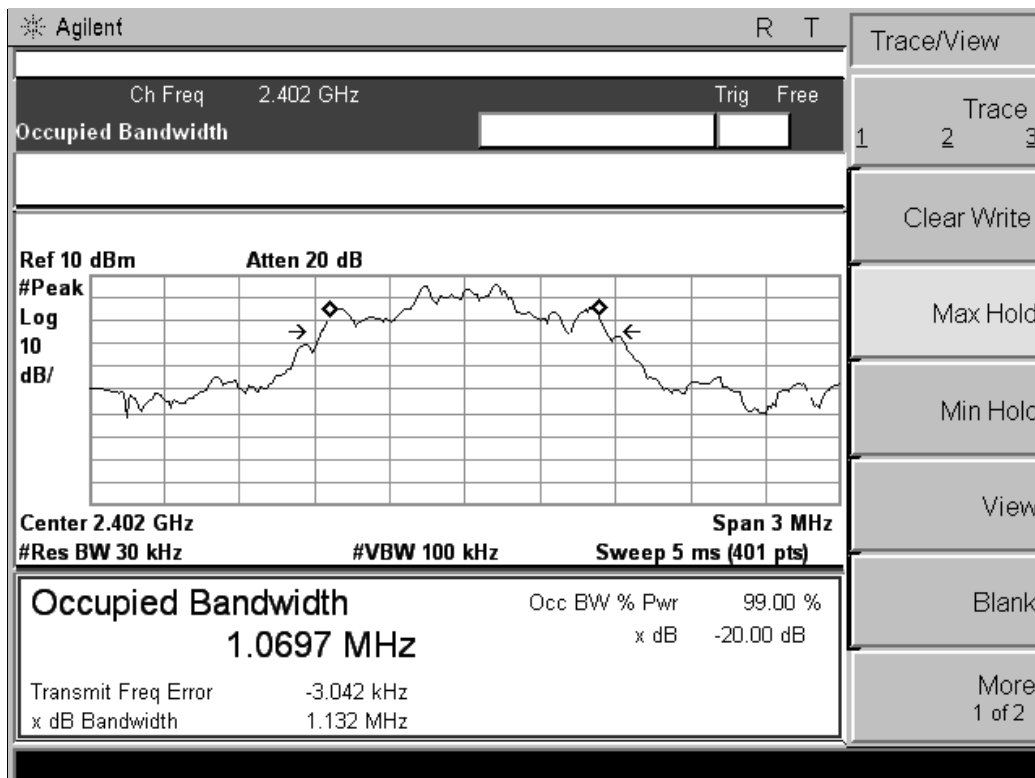

Test frequency: 2441MHz(2Mbps)

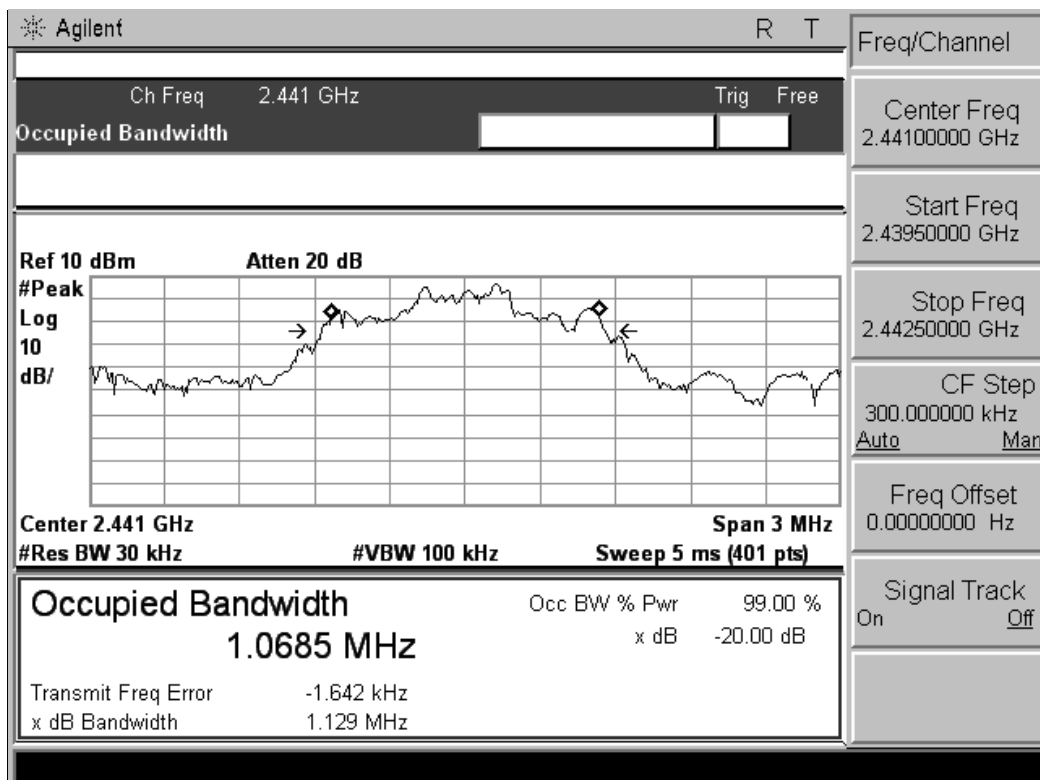

Test frequency: 2480MHz(2Mbps)

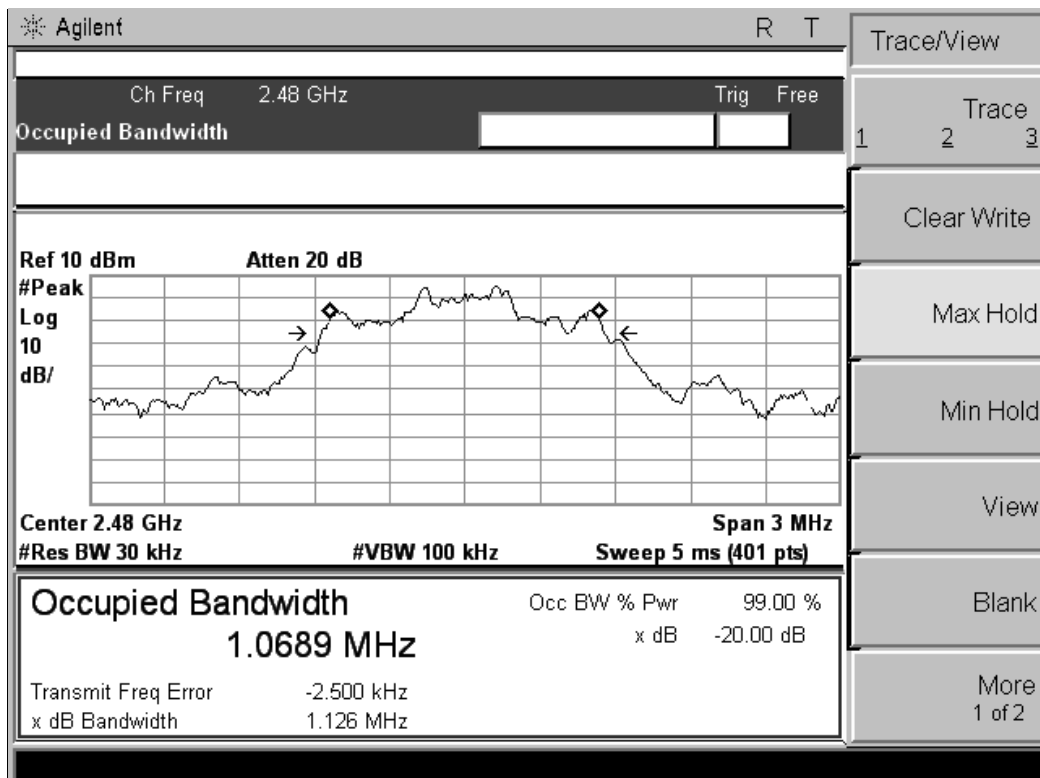

6.3 Number Of Hopping Frequency

6.3.1 Limit

According to § 15.247(a)(1)(ii), Frequency hopping systems operating in the band 2400-2483.5 MHz shall use at least 15 hopping channels.

6.3.2 Block Diagram of Test Setup

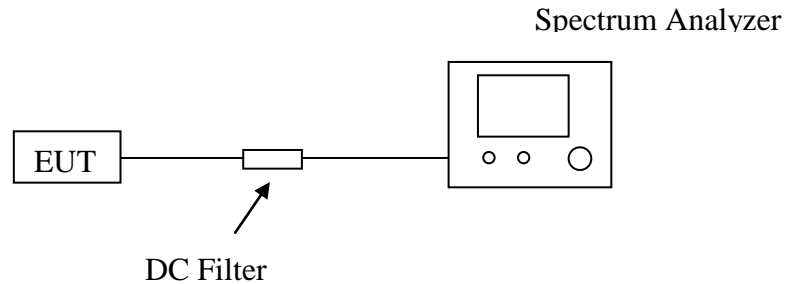

6.3.3 Test Procedure

- A. Place the EUT on the table and set it in transmitting mode.
- B. Remove the antenna from the EUT and then connect a low loss RF cable from the antenna port to the Spectrum Analyzer.
- C. Set Spectrum Analyzer Start=2400MHz, Stop = 2483.5MHz, Sweep = auto.
- D. Set the Spectrum Analyzer as RBW, VBW=1MHz.
- E. Max hold, view and count how many channel in the band.

6.3.4 Test Results

| The Measurement Result With The Worst Case of 1Mbps For GFSK Modulation | | | |
|---|--------------------------------|-------------|--------|
| Total No. of Hopping Channel | Measurement Result (No. of Ch) | Limit (MHz) | Result |
| | 79 | ≥15 | Pass |

The test data refer to the following page.

Test Plot- Number of Hopping Channel

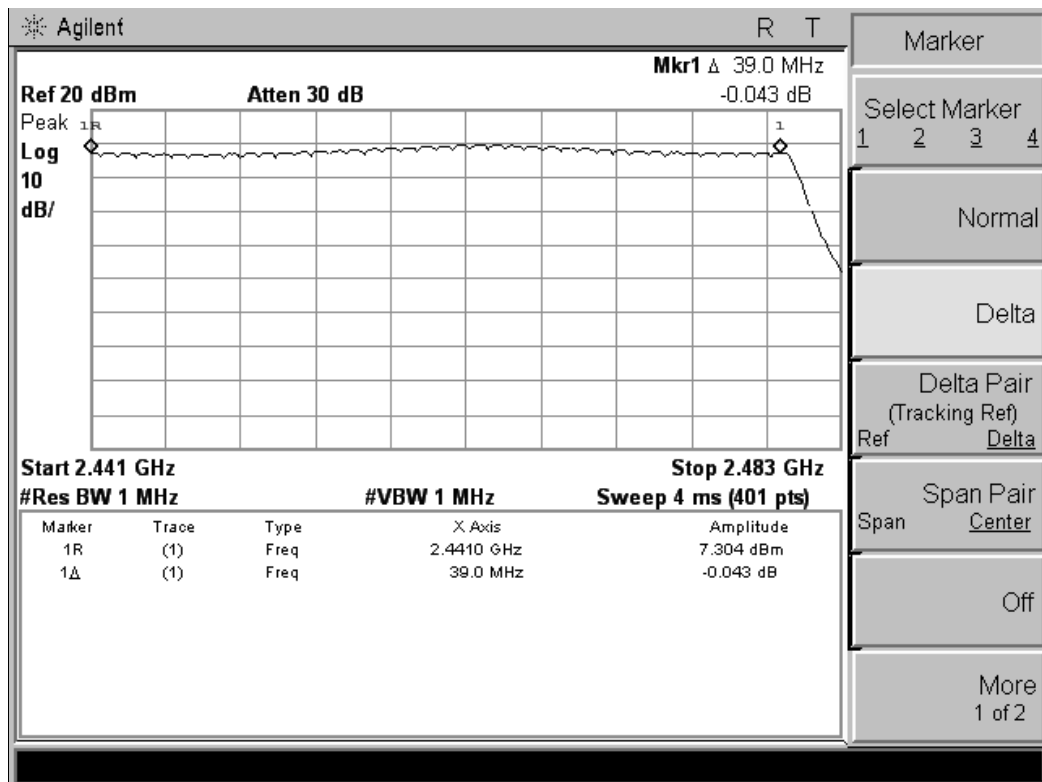
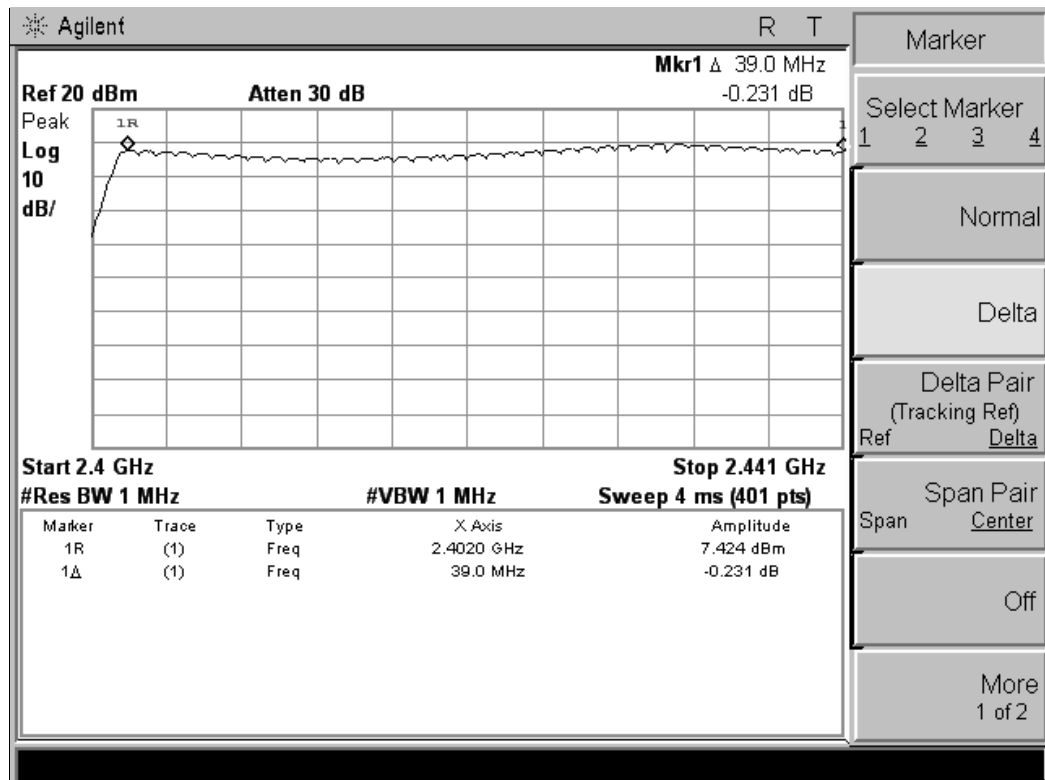

6.4 Time Of Occupancy (Dwell Time)

6.4.1 Limit

According to §15.247(a)(1)(iii), Frequency hopping systems operating in the 2400MHz-2483.5 MHz bands. The average time of occupancy on any channels shall not greater than 0.4 s within a period 0.4 s multiplied by the number of hopping channels employed.

6.4.2 Block Diagram of Test Setup

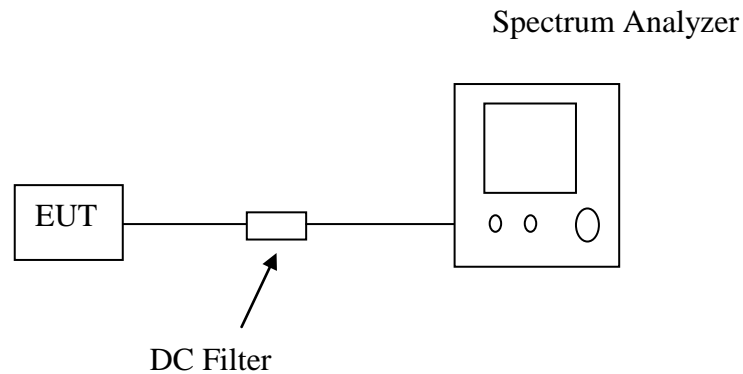

6.4.3 Test Procedure

- A. Place the EUT on the table and set it in transmitting mode.
- B. Remove the antenna from the EUT and then connect a low loss RF cable from the antenna port to the Spectrum Analyzer.
- C. Set center frequency of Spectrum Analyzer = operating frequency.
- D. Set the Spectrum Analyzer as RBW, VBW=1MHz, Span = 0Hz, Sweep = auto.
- E. Repeat above procedures until all frequency measured were complete.

6.4.4 Test Results

| The Measurement Result With The Worst Case of 1Mbps For GFSK Modulation | | | | |
|---|----------------------------|-----------------|-----------------|------------|
| Channel | Time of Pulse for DH5 (ms) | Period Time (s) | Sweep Time (ms) | Limit (ms) |
| Low | 2.85 | 31.6 | 304.0 | 400 |
| Middle | 2.82 | 31.6 | 305.1 | 400 |
| High | 2.82 | 31.6 | 302.9 | 400 |

Low Channel

$$2.85 * (1600/6) / 79 * 31.6 = 305.1 \text{ms}$$

Middle Channel

$$2.82 * (1600/6) / 79 * 31.6 = 300.8 \text{ms}$$

High Channel

$$2.82 * (1600/6) / 79 * 31.6 = 300.8 \text{ms}$$

The test data refer to the following:

Low Channel

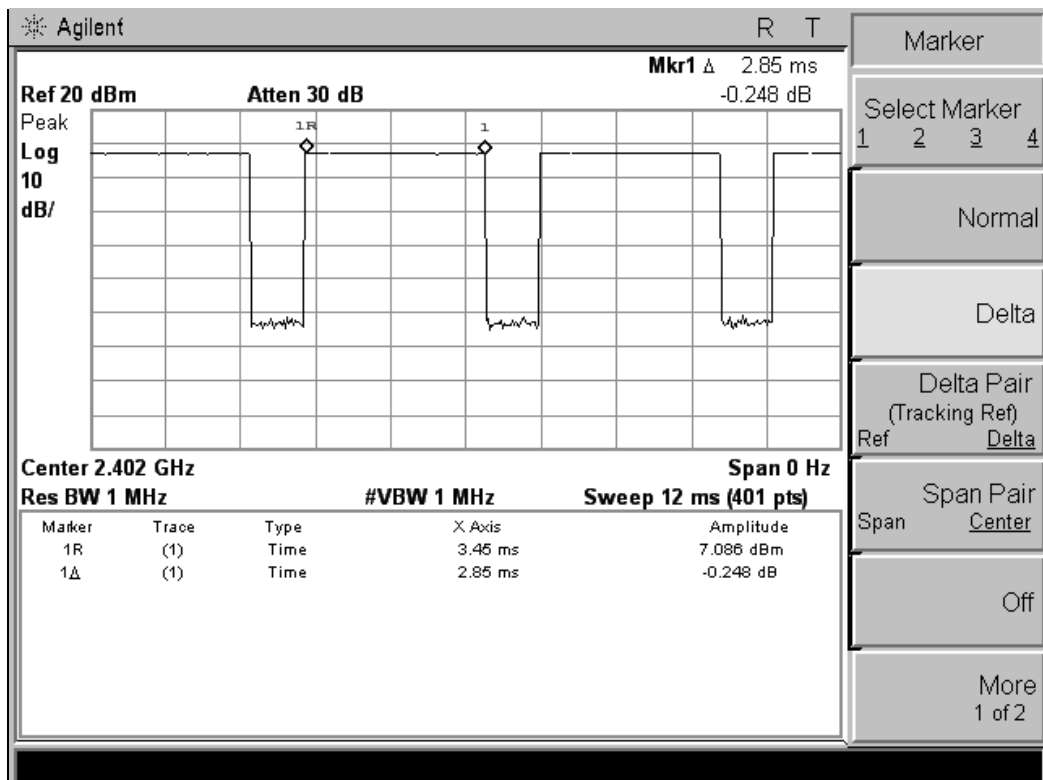

Middle Channel

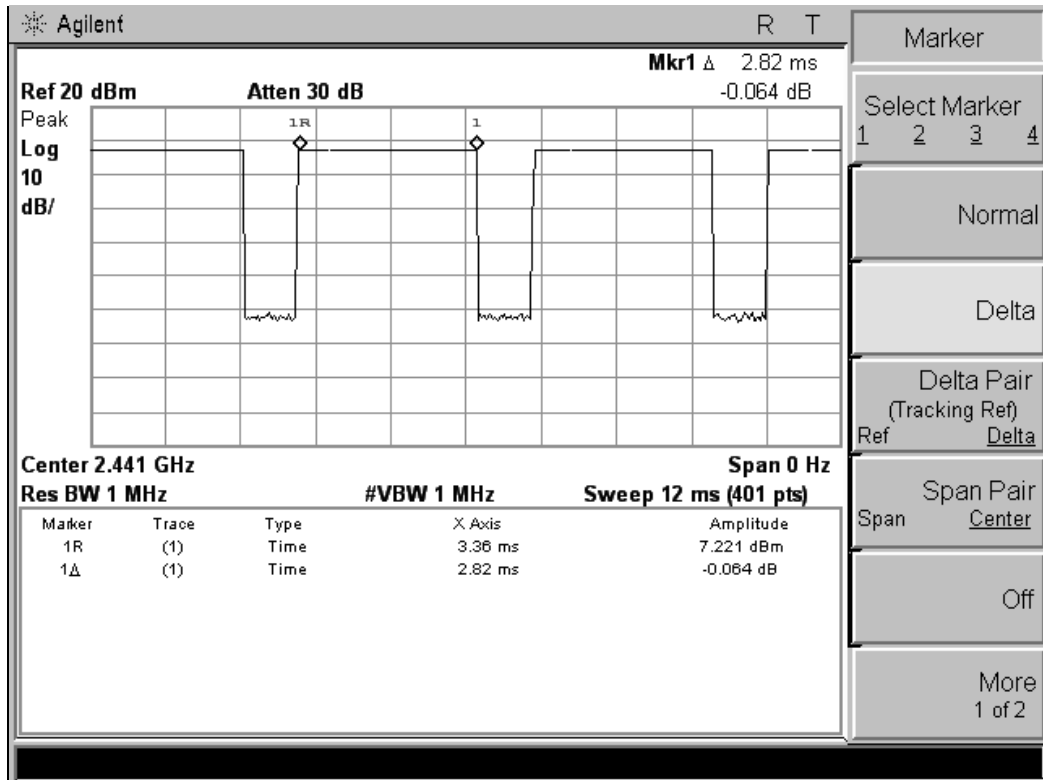

High Channel

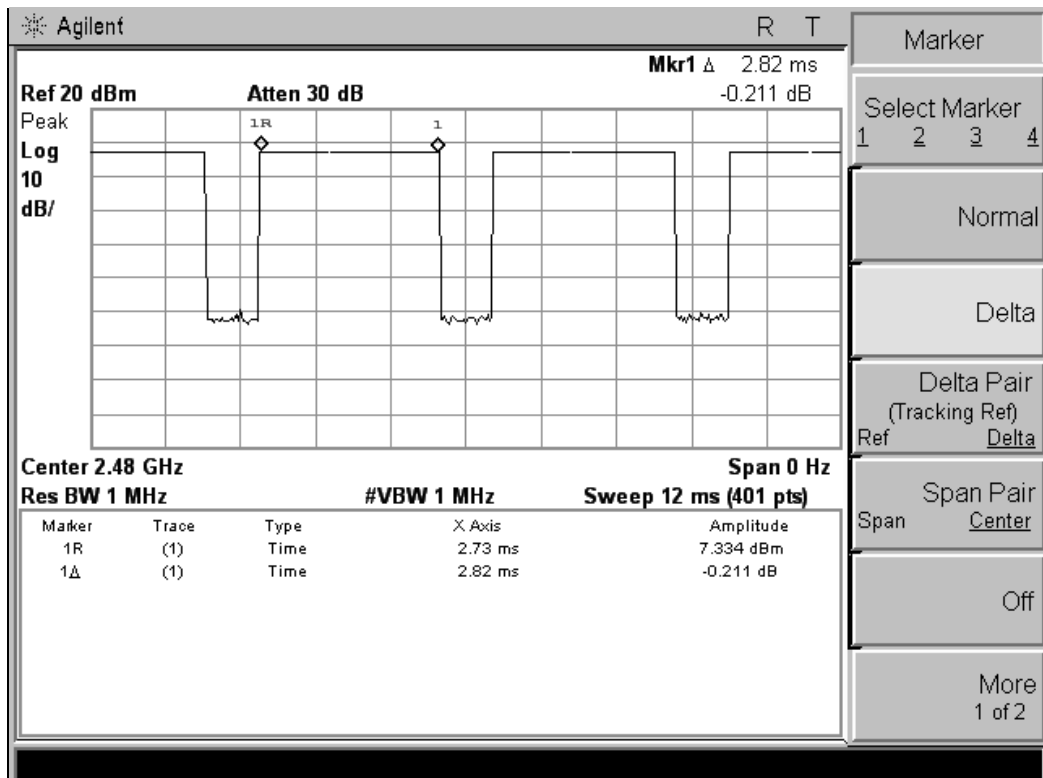

6.5 Conducted Spurious Emissions and Band Edges Test

6.5.1 Limit

In any 100 kHz bandwidth outside the frequency band in which the spread spectrum or digitally modulated intentional radiator is operating, the radio frequency power that is produced by the intentional radiator shall be at least 20 dB below that in the 100 kHz bandwidth within the band that contains the highest level of the desired power, based on either an RF conducted or a radiated measurement. Attenuation below the general limits specified in Section 15.209(a) is not required. In addition, radiated emissions which fall in the restricted bands, as defined in Section 15.205(a), must also comply with the radiated emission limits specified in Section 15.209(a) (see Section 15.205(c)).

6.5.2 Block Diagram of Test Setup

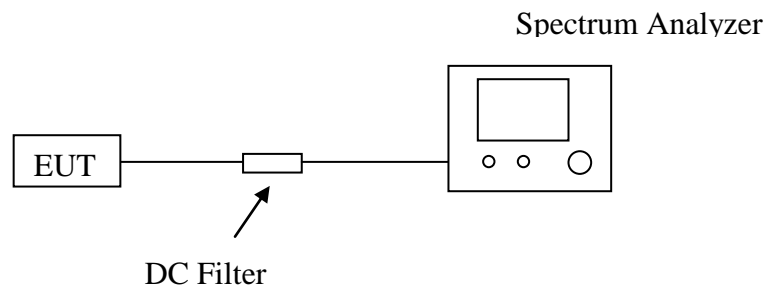

6.5.3 Test Procedure

Conducted RF measurements of the transmitter output were made to confirm that the EUT antenna port conducted emissions meet the specified limit and to identify any spurious signals that require further investigation or measurements on the radiated emissions site.

The transmitter output is connected to the spectrum analyzer. The resolution bandwidth is set to 100 KHz. The video bandwidth is set to 300 KHz.

Measurements are made over the 9kHz to 25GHz range with the transmitter set to the lowest, middle, and highest channels

6.5.4 Test Results of Conducted Spurious Emissions

No non-compliance noted. Only record the worst test result (TX-GFSK) in this report. The test data refer to the following page.

Test Plot

9KHz-25GHz Low Channel(GFSK)

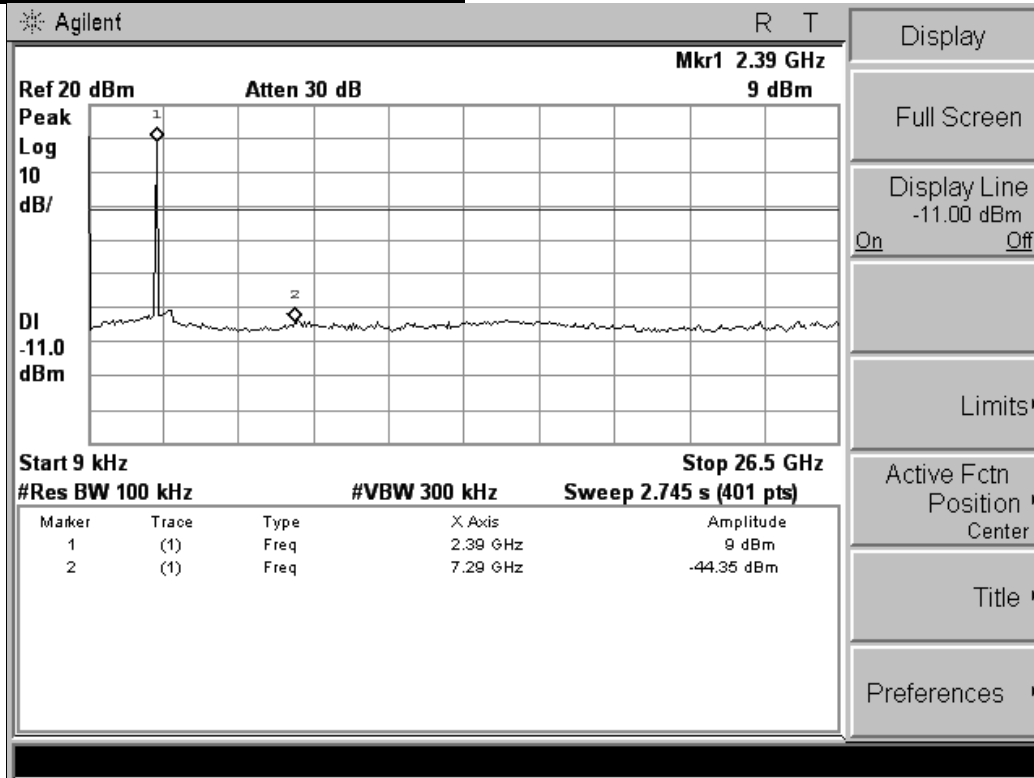

9KHz-25GHz Middle Channel(GFSK)

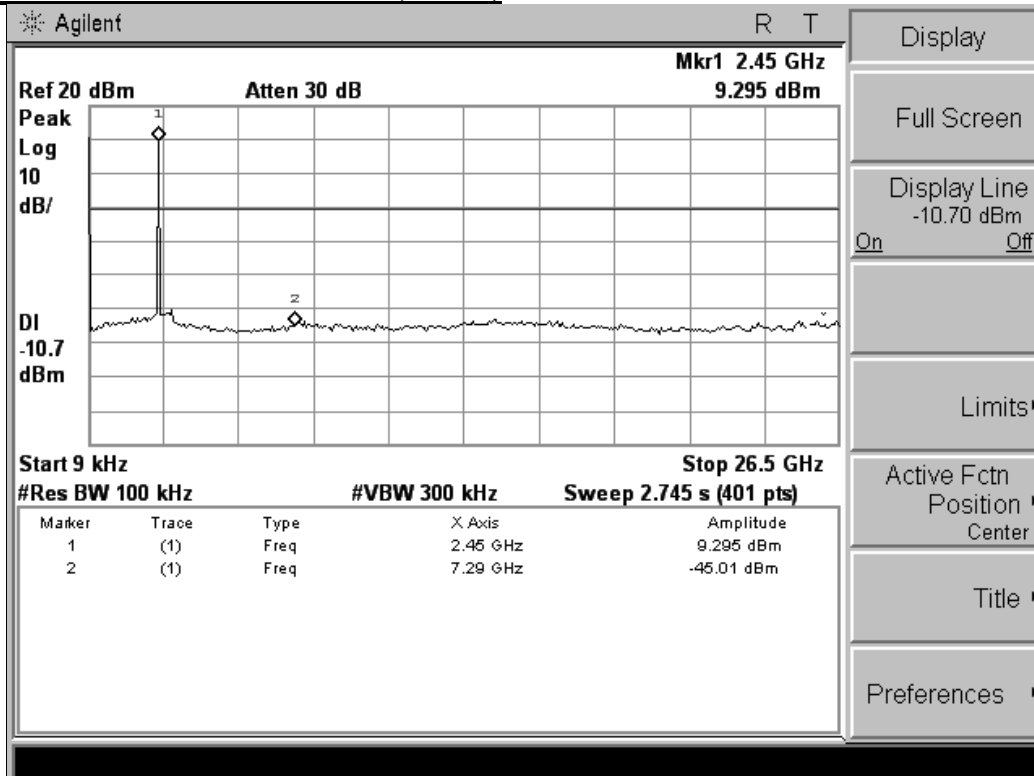

9KHz-25GHz High Channel(GFSK)

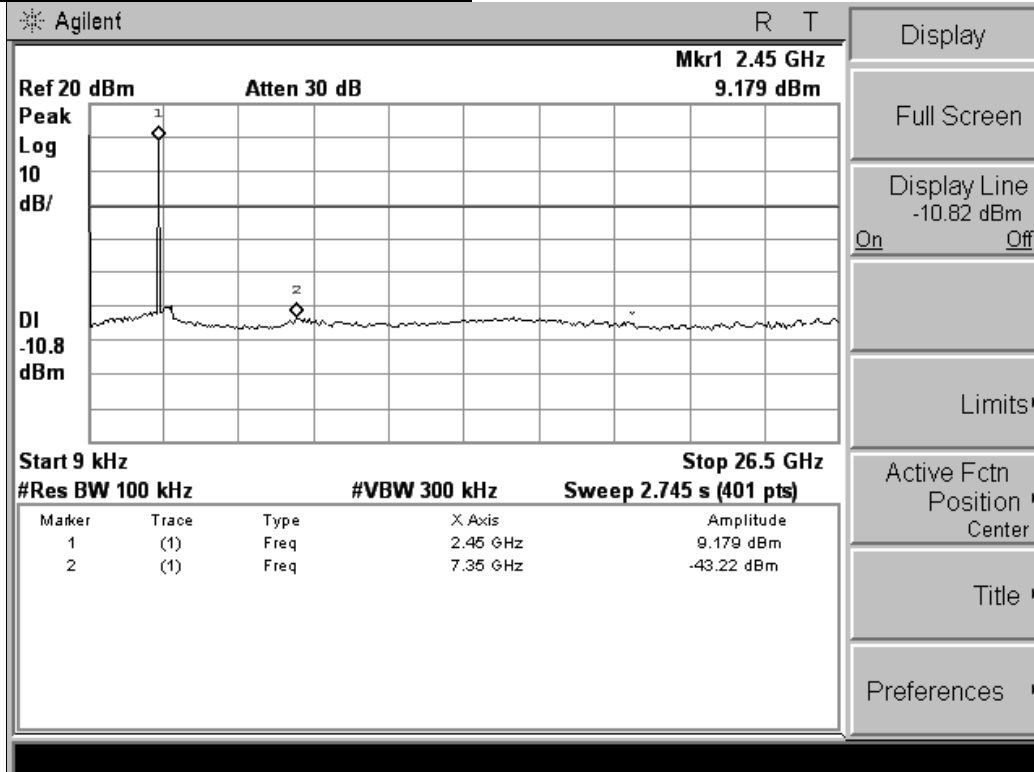

6.5.5 Test Results of Band Edges Test

No non-compliance noted. Only record the worst test result in this report. The test data refer to the following page.

Test Plot

Hopping On - (GFSK)

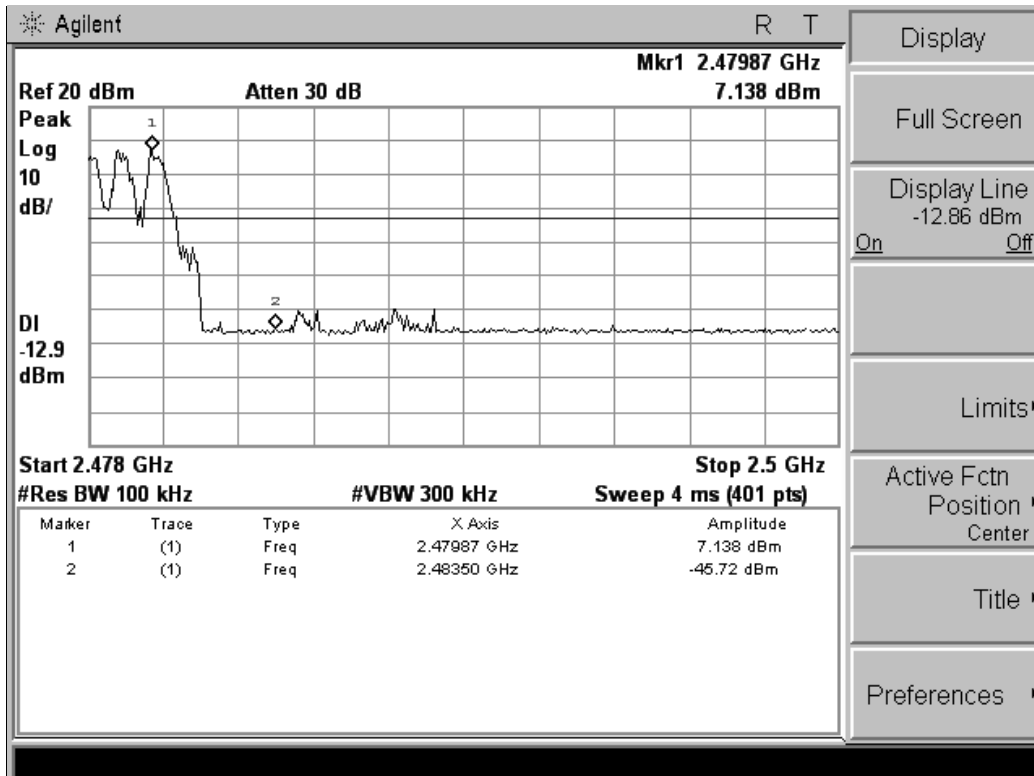
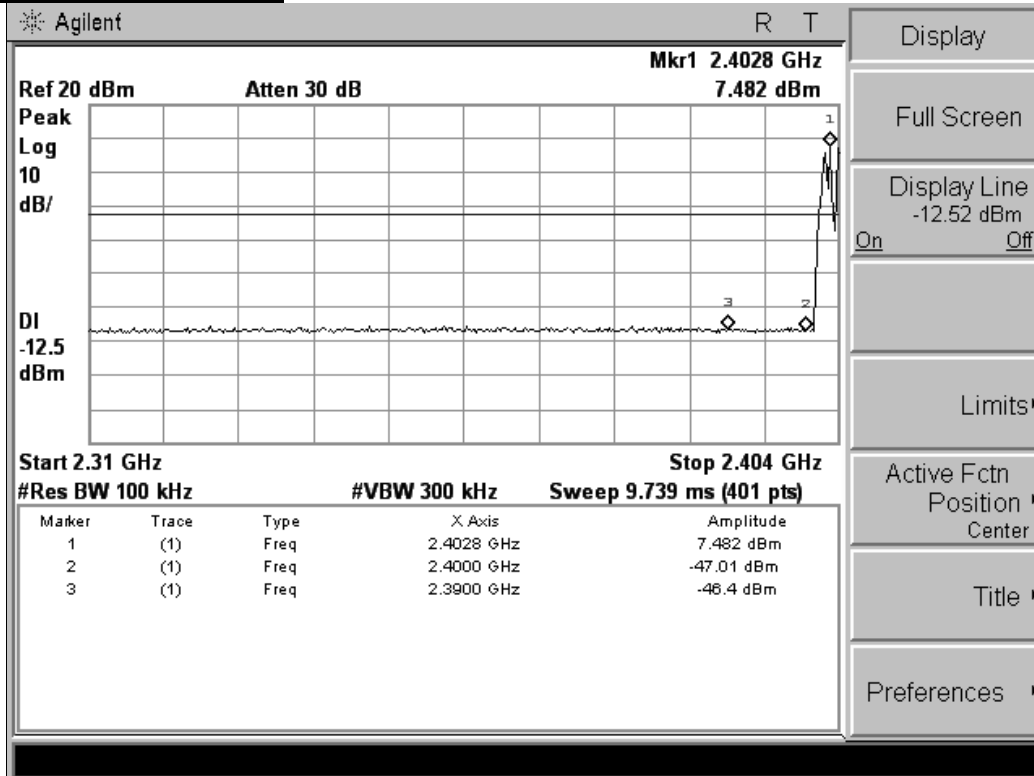

Hopping Off - (GFSK)

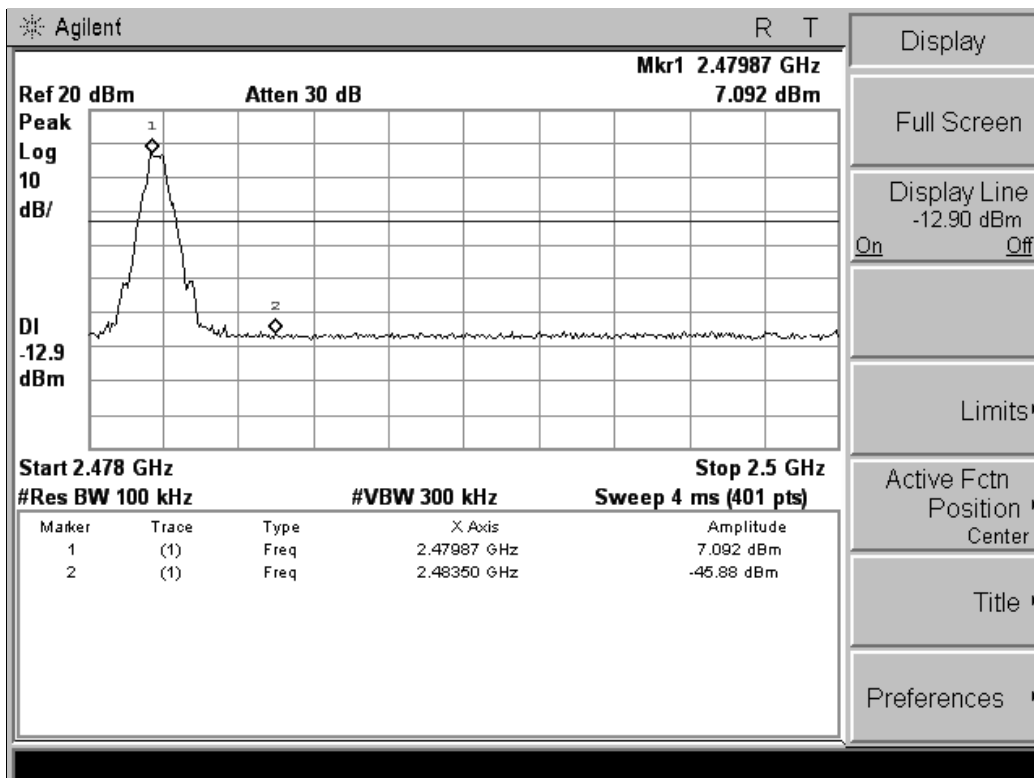
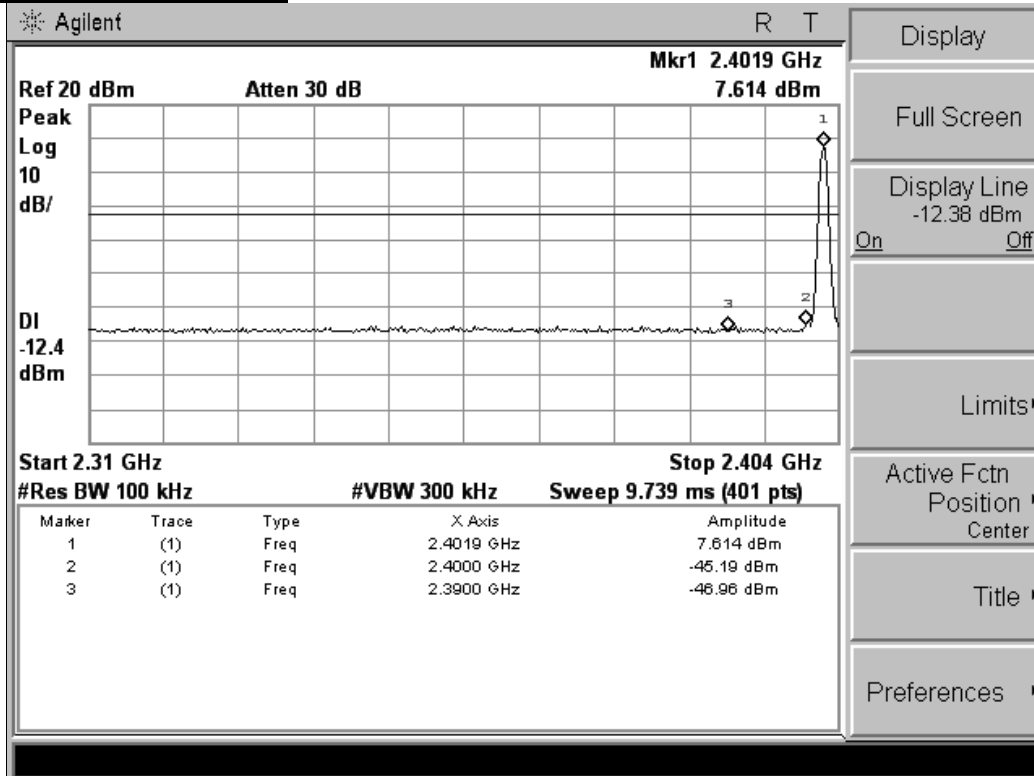

Hopping On - ($\pi/4$ -DQPSK)

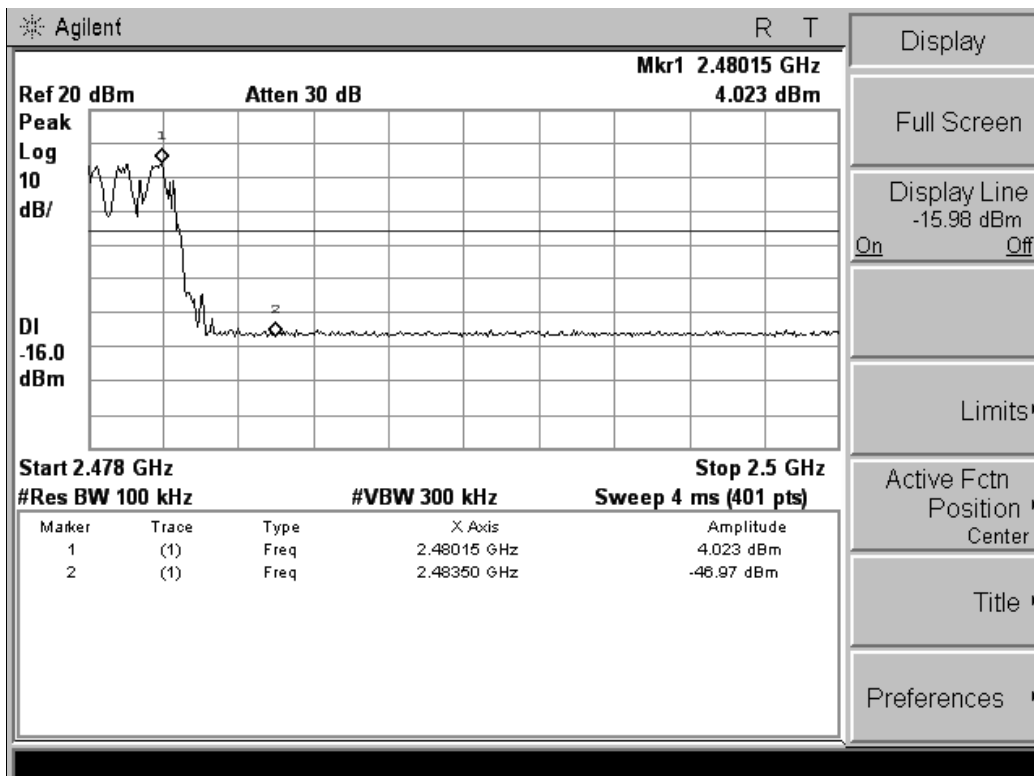
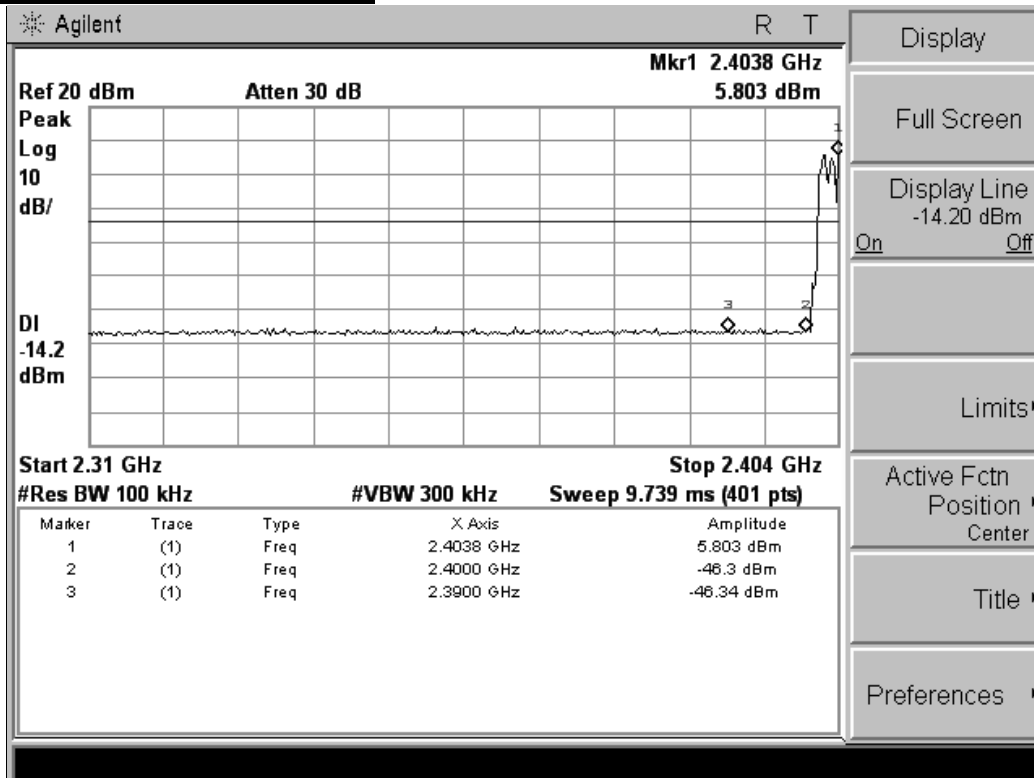

Hopping Off - ($\pi/4$ -DQPSK)

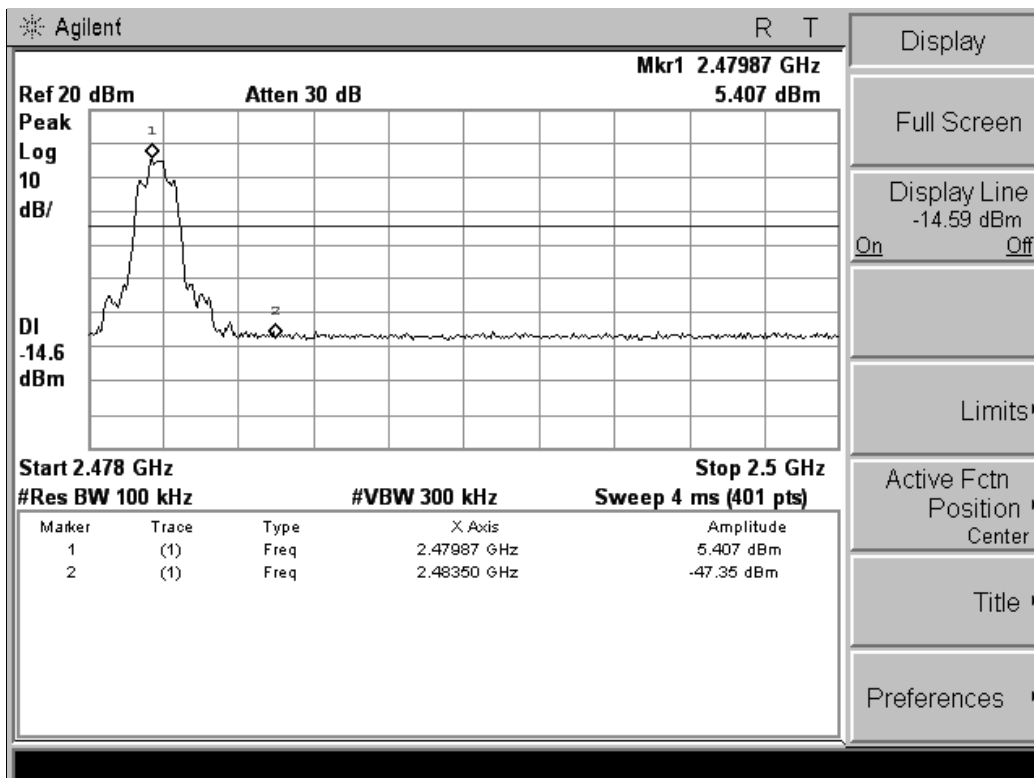
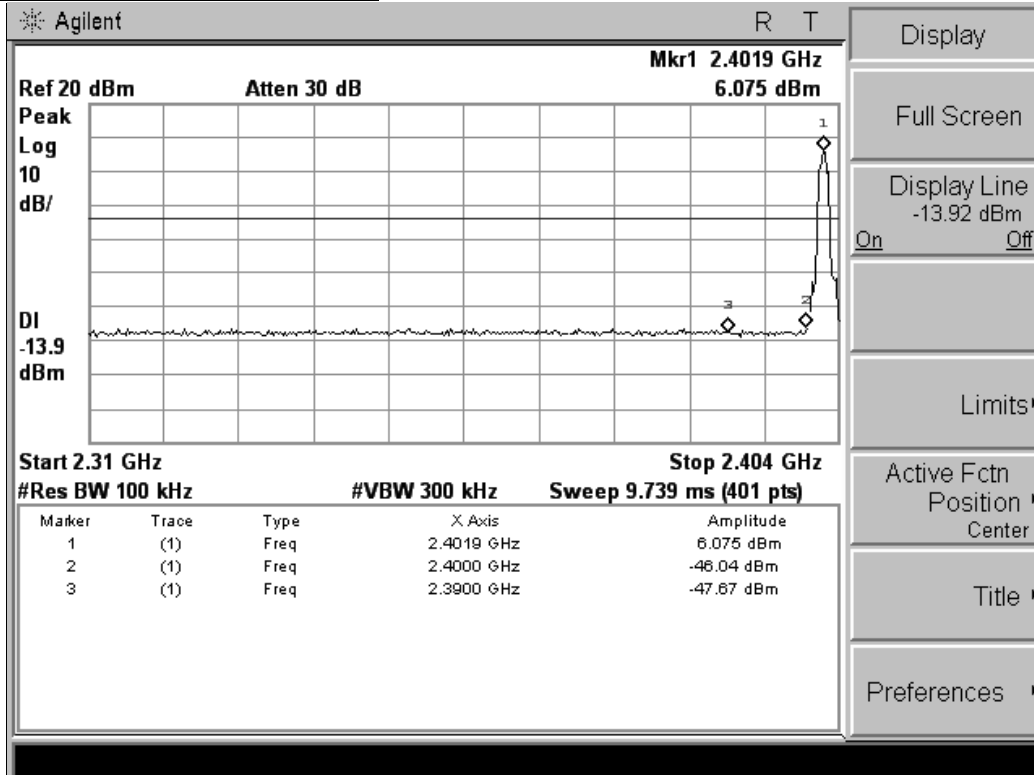

7. RADIATED MEASUREMENT

7.1 Block Diagram of Test Setup

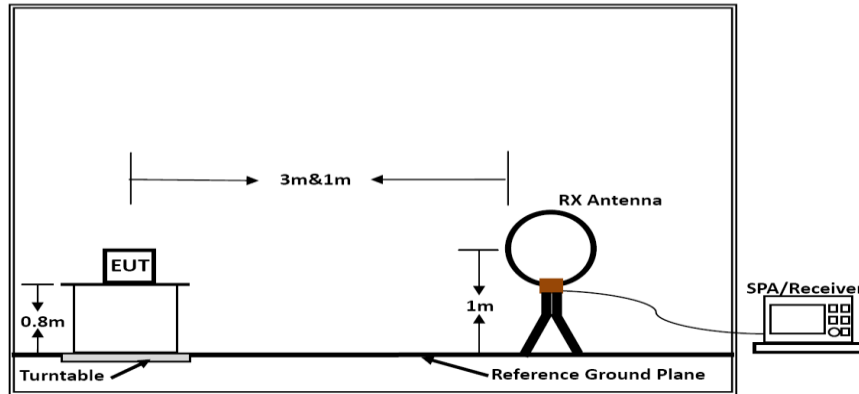

Below 30MHz

Below 30MHz

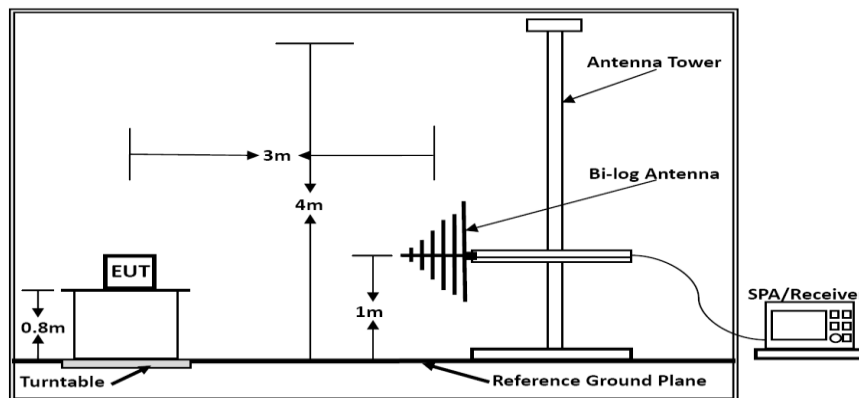

Below 1GHz

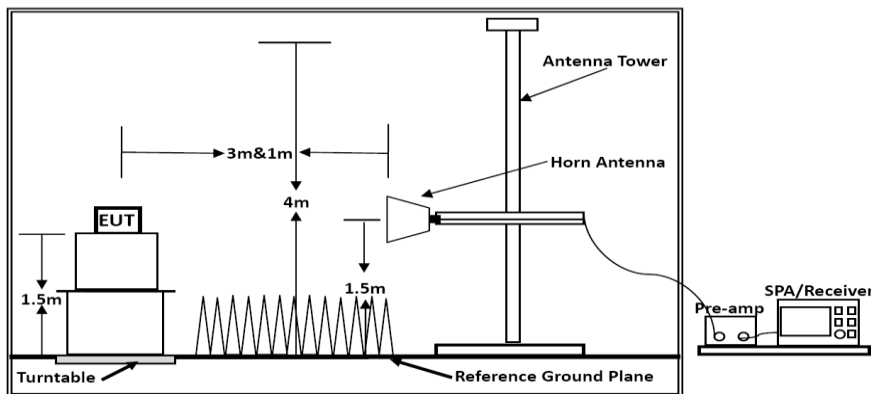

Above 1GHz

7.2 Radiated Emission Limit

15.205 (a) Except as shown in paragraph (d) of this section, only spurious emissions are permitted in any of the frequency bands listed below:

| MHz | MHz | MHz | GHz |
|-------------------|---------------------|---------------|-------------|
| 0.090-0.110 | 16.42-16.423 | 399.9-410 | 4.5-5.15 |
| \1\ 0.495-0.505 | 16.69475-16.69525 | 608-614 | 5.35-5.46 |
| 2.1735-2.1905 | 16.80425-16.80475 | 960-1240 | 7.25-7.75 |
| 4.125-4.128 | 25.5-25.67 | 1300-1427 | 8.025-8.5 |
| 4.17725-4.17775 | 37.5-38.25 | 1435-1626.5 | 9.0-9.2 |
| 4.20725-4.20775 | 73-74.6 | 1645.5-1646.5 | 9.3-9.5 |
| 6.215-6.218 | 74.8-75.2 | 1660-1710 | 10.6-12.7 |
| 6.26775-6.26825 | 108-121.94 | 1718.8-1722.2 | 13.25-13.4 |
| 6.31175-6.31225 | 123-138 | 2200-2300 | 14.47-14.5 |
| 8.291-8.294 | 149.9-150.05 | 2310-2390 | 15.35-16.2 |
| 8.362-8.366 | 156.52475-156.52525 | 2483.5-2500 | 17.7-21.4 |
| 8.37625-8.38675 | 156.7-156.9 | 2690-2900 | 22.01-23.12 |
| 8.41425-8.41475 | 162.0125-167.17 | 3260-3267 | 23.6-24.0 |
| 12.29-12.293. | 167.72-173.2 | 3332-3339 | 31.2-31.8 |
| 12.51975-12.52025 | 240-285 | 3345.8-3358 | 36.43-36.5 |
| 12.57675-12.57725 | 322-335.4 | 3600-4400 | (\2\) |
| 13.36-13.41 | | | |

\1\ Until February 1, 1999, this restricted band shall be 0.490-0.510 MHz.

\2\ Above 38.6

Part 15.205 (b) Except as provided in paragraphs (d) and (e), the field strength of emissions appearing within these frequency bands shall not exceed the limits shown in Section 15.209. At frequencies equal to or less than 1000 MHz, compliance with the limits in Section 15.209 shall be demonstrated using measurement instrumentation employing a CISPR quasi-peak detector.

Above 1000 MHz, compliance with the emission limits in Section 15.209 shall be demonstrated based on the average value of the measured emissions. The provisions in Section 15.35 apply to these measurements.

Part 15.209 (a) Except as provided elsewhere in this Subpart, the emissions from an intentional radiator shall not exceed the field strength levels specified in the following table:

| Frequency (MHz) | Field strength (microvolts/meter) | Measurement distance (meters) |
|-----------------|-----------------------------------|-------------------------------|
| 0.009-0.490 | 2400/F(kHz) | 300 |
| 0.490-1.705 | 24000/F(kHz) | 30 |
| 1.705-30.0 | 30 | 30 |
| 30-88 | 100** | 3 |
| 88-216 | 150** | 3 |
| 216-960 | 200** | 3 |
| Above 960 | 500 | 3 |

7.3 Instruments Setting

The following table is the setting of spectrum analyzer and receiver.

| Spectrum Parameter | Setting |
|---|--|
| Attenuation | Auto |
| Start Frequency | 1000 MHz |
| Stop Frequency | 10th carrier harmonic |
| RB / VB (Emission in restricted band) | 1MHz / 1MHz for Peak, 1 MHz / 10Hz for Average |
| RB / VB (Emission in non-restricted band) | 1MHz / 1MHz for Peak, 1 MHz / 10Hz for Average |

| Receiver Parameter | Setting |
|------------------------|----------------------------------|
| Attenuation | Auto |
| Start ~ Stop Frequency | 9kHz~150kHz / RB 200Hz for QP |
| Start ~ Stop Frequency | 150kHz~30MHz / RB 9kHz for QP |
| Start ~ Stop Frequency | 30MHz~1000MHz / RB 100kHz for QP |

7.4 Test Procedures

1) Sequence of testing 9 kHz to 30 MHz

Setup:

- The equipment was set up to simulate a typical usage like described in the user manual or described by manufacturer.
- If the EUT is a tabletop system, a rotatable table with 0.8 m height is used.
- If the EUT is a floor standing device, it is placed on the ground.
- Auxiliary equipment and cables were positioned to simulate normal operation conditions.
- The AC power port of the EUT (if available) is connected to a power outlet below the turntable.
- The measurement distance is 3 meter.
- The EUT was set into operation.

Premeasurement:

- The turntable rotates from 0 ° to 315 ° using 45 ° steps.
- The antenna height is 0.8 meter.
- At each turntable position the analyzer sweeps with peak detection to find the maximum of all emissions

Final measurement:

- Identified emissions during the premeasurement the software maximizes by rotating the turntable position (0 ° to 360 °) and by rotating the elevation axes (0 ° to 360 °).
- The final measurement will be done in the position (turntable and elevation) causing the highest emissions with QPK detector.
- The final levels, frequency, measuring time, bandwidth, turntable position, correction factor, margin to the limit and limit will be recorded. Also a plot with the graph of the premeasurement and the limit will be stored.

2) Sequence of testing 30 MHz to 1 GHz

Setup:

- The equipment was set up to simulate a typical usage like described in the user manual or described by manufacturer.
- If the EUT is a tabletop system, a table with 0.8 m height is used, which is placed on the ground plane.
- If the EUT is a floor standing device, it is placed on the ground plane with insulation between both.
- Auxiliary equipment and cables were positioned to simulate normal operation conditions
- The AC power port of the EUT (if available) is connected to a power outlet below the turntable.
- The measurement distance is 3 meter.
- The EUT was set into operation.

Premeasurement:

- The turntable rotates from 0 ° to 315 ° using 45 ° steps.
- The antenna is polarized vertical and horizontal.
- The antenna height changes from 1 to 3 meter.
- At each turntable position, antenna polarization and height the analyzer sweeps three times in peak to find the maximum of all emissions.

Final measurement:

- The final measurement will be performed with minimum the six highest peaks.
- According to the maximum antenna and turntable positions of premeasurement the software maximize the peaks by changing turntable position ($\pm 45^\circ$) and antenna movement between 1 and 4 meter.
- The final measurement will be done with QP detector with an EMI receiver.
- The final levels, frequency, measuring time, bandwidth, antenna height, antenna polarization, turntable angle, correction factor, margin to the limit and limit will be recorded. Also a plot with the graph of the premeasurement with marked maximum final measurements and the limit will be stored.

3) Sequence of testing 1 GHz to 18 GHz

Setup:

- The equipment was set up to simulate a typical usage like described in the user manual or described by manufacturer.
- If the EUT is a tabletop system, a rotatable table with 1.5 m height is used.
- If the EUT is a floor standing device, it is placed on the ground plane with insulation between both.
- Auxiliary equipment and cables were positioned to simulate normal operation conditions
- The AC power port of the EUT (if available) is connected to a power outlet below the turntable.
- The measurement distance is 3 meter.
- The EUT was set into operation.

Premeasurement:

- The turntable rotates from 0 ° to 315 ° using 45 ° steps.
- The antenna is polarized vertical and horizontal.
- The antenna height scan range is 1 meter to 2.5 meter.
- At each turntable position and antenna polarization the analyzer sweeps with peak detection to find the maximum of all emissions.

Final measurement:

- The final measurement will be performed with minimum the six highest peaks.
- According to the maximum antenna and turntable positions of premeasurement the software maximize the peaks by changing turntable position ($\pm 45^\circ$) and antenna movement between 1 and 4 meter. This procedure is repeated for both antenna polarizations.
- The final measurement will be done in the position (turntable, EUT-table and antenna polarization) causing the highest emissions with Peak and Average detector.
- The final levels, frequency, measuring time, bandwidth, turntable position, EUT-table position, antenna polarization, correction factor, margin to the limit and limit will be recorded. Also a plot with the graph of the premeasurement with marked maximum final measurements and the limit will be stored.

4) Sequence of testing above 18 GHz

Setup:

- The equipment was set up to simulate a typical usage like described in the user manual or described by manufacturer.
- If the EUT is a tabletop system, a rotatable table with 1.5 m height is used.
- If the EUT is a floor standing device, it is placed on the ground plane with insulation between both.
- Auxiliary equipment and cables were positioned to simulate normal operation conditions
- The AC power port of the EUT (if available) is connected to a power outlet below the turntable.
- The measurement distance is 1 meter.
- The EUT was set into operation.

Premeasurement:

- The antenna is moved spherical over the EUT in different polarizations of the antenna.

Final measurement:

- The final measurement will be performed at the position and antenna orientation for all detected emissions that were found during the premeasurements with Peak and Average detector.
- The final levels, frequency, measuring time, bandwidth, correction factor, margin to the limit and limit will be recorded. Also a plot with the graph of the premeasurement and the limit will be stored.

7.5 Results for Radiated Emissions

PASS.

Only record the worst test result in this report.

The test data please refer to following page:

Below 1GHz (Low Channel)

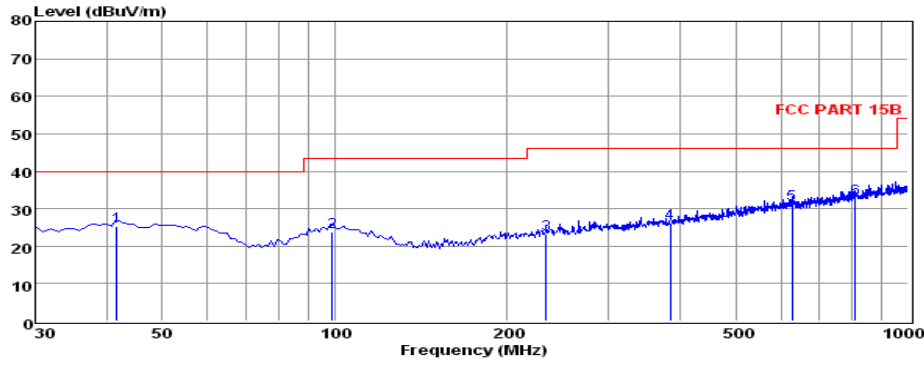

Env./Ins: 24°C/56%
 EUT: Bluetooth Speaker
 Power Rating: DC 3.7V
 Test Mode: TX-2402
 Operator: KYLE
 Memo:
 pol: HORIZONTAL

| | Freq | Reading | CabLos | Antfac | Measured | Limit | Over | Remark |
|---|--------|---------|--------|--------|----------|--------|--------|--------|
| | MHz | dBuV | dB | dB/m | dBuV/m | dBuV/m | dB | |
| 1 | 41.64 | 11.11 | 0.50 | 13.57 | 25.18 | 40.00 | -14.82 | QP |
| 2 | 98.87 | 10.08 | 0.61 | 13.09 | 23.78 | 43.50 | -19.72 | QP |
| 3 | 233.70 | 10.62 | 0.87 | 11.81 | 23.30 | 46.00 | -22.70 | QP |
| 4 | 385.02 | 10.02 | 1.32 | 14.71 | 26.05 | 46.00 | -19.95 | QP |
| 5 | 627.52 | 11.06 | 1.63 | 18.55 | 31.24 | 46.00 | -14.76 | QP |
| 6 | 807.94 | 10.86 | 1.76 | 20.14 | 32.76 | 46.00 | -13.24 | QP |

Note: 1. All readings are Quasi-peak values.
 2. Measured= Reading + Antenna Factor + Cable Loss
 3. The emission that are 20db below the official limit are not reported

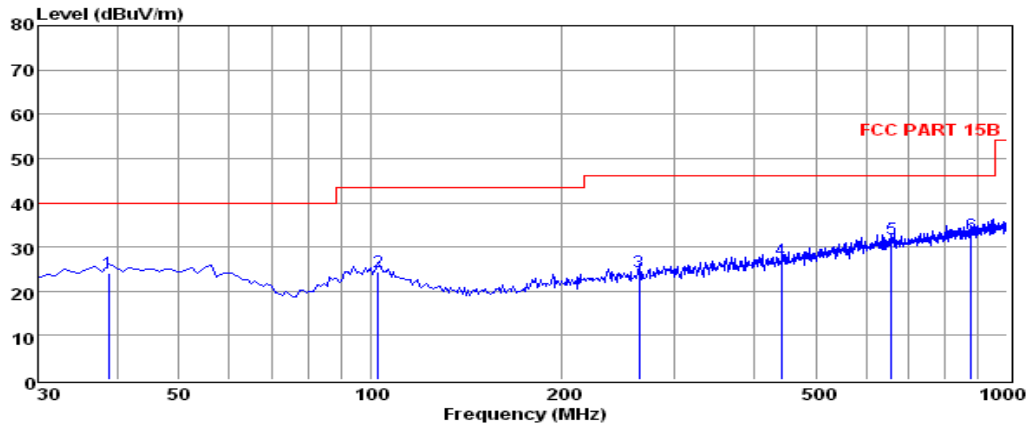

Env./Ins: 24°C/56%
 EUT: Bluetooth Speaker
 Power Rating: DC 3.7V
 Test Mode: TX-2402
 Operator: KYLE
 Memo:
 pol: VERTICAL

| | Freq | Reading | CabLos | Antfac | Measured | Limit | Over | Remark |
|---|--------|---------|--------|--------|----------|--------|--------|--------|
| | MHz | dBuV | dB | dB/m | dBuV/m | dBuV/m | dB | |
| 1 | 38.73 | 10.51 | 0.38 | 13.25 | 24.14 | 40.00 | -15.86 | QP |
| 2 | 102.75 | 10.83 | 0.60 | 12.91 | 24.34 | 43.50 | -19.16 | QP |
| 3 | 263.77 | 11.06 | 1.03 | 12.17 | 24.26 | 46.00 | -21.74 | QP |
| 4 | 442.25 | 10.24 | 1.25 | 15.56 | 27.05 | 46.00 | -18.95 | QP |
| 5 | 657.59 | 11.65 | 1.50 | 18.66 | 31.81 | 46.00 | -14.19 | QP |
| 6 | 878.75 | 10.11 | 1.88 | 20.87 | 32.86 | 46.00 | -13.14 | QP |

Note: 1. All readings are Quasi-peak values.
 2. Measured= Reading + Antenna Factor + Cable Loss
 3. The emission that are 20db below the official limit are not reported

Above 1GHz

The worst test result for GFSK, Tx-Low Channel:

| Freq. MHz | Reading dBuv | Ant. Fac dB/m | Pre. Fac. dB | Cab. Loss dB | Measured dBuv/m | Limit dBuv/m | Margin dB | Remark | Pol. |
|-----------|--------------|---------------|--------------|--------------|-----------------|--------------|-----------|---------|------------|
| 4804.00 | 41.19 | 33.06 | 35.04 | 3.94 | 43.15 | 74 | -30.85 | Peak | Horizontal |
| 4804.00 | 28.51 | 33.06 | 35.04 | 3.94 | 30.47 | 54 | -23.53 | Average | Horizontal |
| 4804.00 | 51.11 | 33.06 | 35.04 | 3.94 | 53.07 | 74 | -20.93 | Peak | Vertical |
| 4804.00 | 36.47 | 33.06 | 35.04 | 3.94 | 38.43 | 54 | -15.57 | Average | Vertical |

The worst test result for GFSK, Tx-Middle Channel:

| Freq. MHz | Reading Dbuv | Ant. Fac dB/m | Pre. Fac. dB | Cab. Loss dB | Measured dBuv/m | Limit dBuv/m | Margin dB | Remark | Pol. |
|-----------|--------------|---------------|--------------|--------------|-----------------|--------------|-----------|---------|------------|
| 4882.00 | 52.32 | 33.16 | 35.15 | 3.96 | 54.29 | 74 | -19.71 | Peak | Horizontal |
| 4882.00 | 25.73 | 33.16 | 35.15 | 3.96 | 27.70 | 54 | -26.30 | Average | Horizontal |
| 4882.00 | 47.61 | 33.16 | 35.15 | 3.96 | 49.58 | 74 | -24.42 | Peak | Vertical |
| 4882.00 | 33.07 | 33.16 | 35.15 | 3.96 | 35.04 | 54 | -18.96 | Average | Vertical |

The worst test result for GFSK, Tx-High Channel:

| Freq. MHz | Reading DBuv | Ant. Fac dB/m | Pre. Fac dB | Cab. Los dB | Measured dBuv/m | Limit dBuv/m | Margin dB | Remark | Pol. |
|-----------|--------------|---------------|-------------|-------------|-----------------|--------------|-----------|---------|------------|
| 4960.00 | 53.66 | 33.26 | 35.14 | 3.98 | 55.76 | 74 | -18.24 | Peak | Horizontal |
| 4960.00 | 28.69 | 33.26 | 35.14 | 3.98 | 30.79 | 54 | -23.21 | Average | Horizontal |
| 4960.00 | 45.09 | 33.26 | 35.14 | 3.98 | 47.19 | 74 | -26.81 | Peak | Vertical |
| 4960.00 | 30.77 | 33.26 | 35.14 | 3.98 | 32.87 | 54 | -21.13 | Average | Vertical |

Notes:

1. Measuring frequencies from 9k~10th harmonic (ex. 26GHz), No emission found between lowest internal used/generated frequency to 30 MHz.
2. Radiated emissions measured in frequency range from 9k~10th harmonic (ex. 26GHz) were made with an instrument using Peak detector mode.
3. 18~25GHz at least have 20dB margin. No recording in the test report.

7.6 Results for Band edge Testing (Radiated)

Only record the worst test case (Tx, GFSK, Non-hopping) as following:

Tx-2402, GFSK, Non-hopping

| Freq. MHz | Reading Level dBuV | Ant. Fac. dB/m | Pre. Fac. dB | Cab. Loss dB | Measured dBuV/m | Limit dBuV/m | Margin dB | Remark | Pol. |
|-----------|--------------------|----------------|--------------|--------------|-----------------|--------------|-----------|---------|------------|
| 2385.00 | 49.16 | 32.89 | 35.16 | 3.51 | 50.40 | 74 | -23.60 | Peak | Horizontal |
| 2385.00 | 37.49 | 32.89 | 35.16 | 3.51 | 38.74 | 54 | -15.26 | Average | Horizontal |
| 2400.00 | 55.33 | 32.92 | 35.16 | 3.54 | 56.63 | 74 | -17.37 | Peak | Horizontal |
| 2400.00 | 35.97 | 32.92 | 35.16 | 3.54 | 37.27 | 54 | -16.73 | Average | Horizontal |
| 2385.00 | 53.15 | 32.89 | 35.16 | 3.51 | 54.39 | 74 | -19.61 | Peak | Vertical |
| 2385.00 | 36.09 | 32.89 | 35.16 | 3.51 | 37.34 | 54 | -16.66 | Average | Vertical |
| 2400.00 | 44.12 | 32.92 | 35.16 | 3.54 | 45.42 | 74 | -28.58 | Peak | Vertical |
| 2400.00 | 35.11 | 32.92 | 35.16 | 3.54 | 36.41 | 54 | -17.59 | Average | Vertical |

Tx-2480, GFSK, Non-hopping

| Freq. MHz | Reading Level dBuV | Ant. Fac. dB/m | Pre. Fac. dB | Cab. Loss dB | Measured dBuV/m | Limit dBuV/m | Margin dB | Remark | Pol. |
|-----------|--------------------|----------------|--------------|--------------|-----------------|--------------|-----------|---------|------------|
| 2483.50 | 51.25 | 33.06 | 35.18 | 3.60 | 52.73 | 74 | -21.27 | Peak | Horizontal |
| 2483.50 | 36.56 | 33.06 | 35.18 | 3.60 | 38.04 | 54 | -15.96 | Average | Horizontal |
| 2483.50 | 50.86 | 33.06 | 35.18 | 3.60 | 52.34 | 74 | -21.66 | Peak | Vertical |
| 2483.50 | 38.11 | 33.06 | 35.18 | 3.60 | 39.59 | 54 | -14.41 | Average | Vertical |

7.7. Power line conducted emissions

7.7.1 Standard Applicable

According to §15.207 (a): For an intentional radiator which is designed to be connected to the public utility (AC) power line, the radio frequency voltage that is conducted back onto the AC power line on any frequency or frequencies within the band 150 kHz to 30 MHz shall not exceed 250 microvolts (The limit decreases linearly with the logarithm of the frequency in the range 0.15 MHz to 0.50 MHz). The limits at specific frequency range is listed as follows:

| Frequency Range (MHz) | Limits (dB μ V) | |
|-----------------------|---------------------|----------|
| | Quasi-peak | Average |
| 0.15 to 0.50 | 66 to 56 | 56 to 46 |
| 0.50 to 5 | 56 | 46 |
| 5 to 30 | 60 | 50 |

7.7.2 Block Diagram of Test Setup

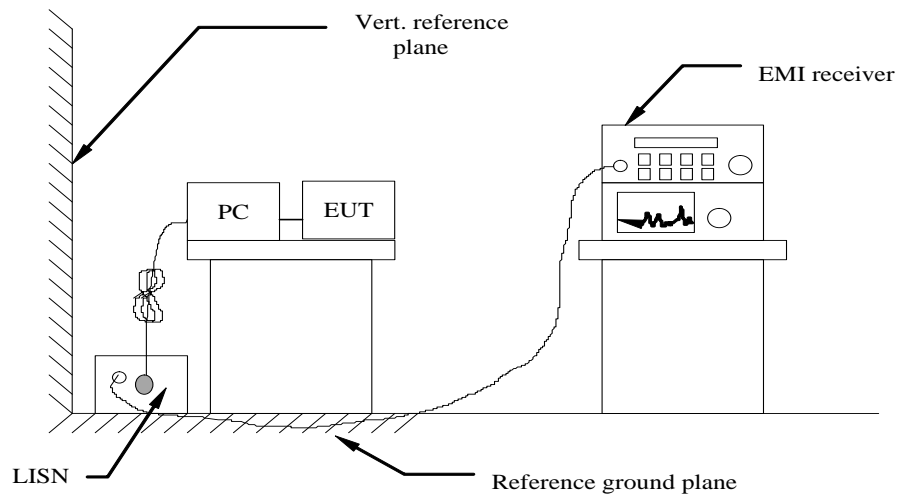

7.7.3 Test Results

PASS.

The test data please refer to following page.

Test result for GFSK (Low Chanel)

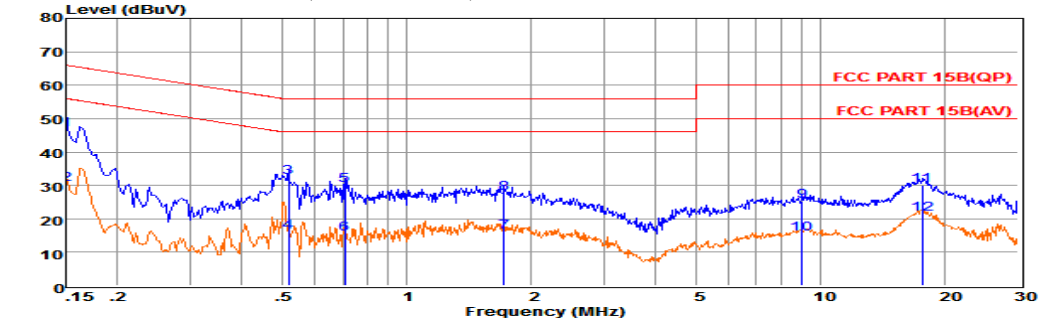

Env. Ins: 24*/56%
 EUT: Bluetooth Speaker
 Power Rating: AC 120V/60Hz
 Test Mode: TX-2402
 Operator: KYLE
 Memo:
 Pol: LINE

| | Freq | Reading | LisnFac | CabLos | Measured | Limit | Over | Remark |
|----|-------|---------|---------|--------|----------|-------|--------|---------|
| | MHz | dBpW | dB | dB | dBpW | dBpW | dB | |
| 1 | 0.15 | 26.99 | 9.57 | 0.02 | 46.58 | 66.00 | -19.42 | QP |
| 2 | 0.15 | 10.80 | 9.57 | 0.02 | 30.39 | 55.99 | -25.60 | Average |
| 3 | 0.52 | 12.77 | 9.62 | 0.04 | 32.43 | 56.00 | -23.57 | QP |
| 4 | 0.52 | -3.66 | 9.62 | 0.04 | 16.00 | 46.00 | -30.00 | Average |
| 5 | 0.71 | 10.42 | 9.64 | 0.04 | 30.10 | 56.00 | -25.90 | QP |
| 6 | 0.71 | -4.09 | 9.64 | 0.04 | 15.59 | 46.00 | -30.41 | Average |
| 7 | 1.72 | -3.63 | 9.64 | 0.05 | 16.06 | 46.00 | -29.94 | Average |
| 8 | 1.72 | 8.01 | 9.64 | 0.05 | 27.70 | 56.00 | -28.30 | QP |
| 9 | 9.01 | 5.53 | 9.69 | 0.08 | 25.30 | 60.00 | -34.70 | QP |
| 10 | 9.01 | -4.37 | 9.69 | 0.08 | 15.40 | 50.00 | -34.60 | Average |
| 11 | 17.57 | 10.21 | 9.74 | 0.11 | 30.06 | 60.00 | -29.94 | QP |
| 12 | 17.57 | 1.60 | 9.74 | 0.11 | 21.45 | 50.00 | -28.55 | Average |

Remarks: 1. Measured = Reading + Lisn Factor +Cable Loss.
 2. The emission levels that are 20dB below the official limit are not reported.

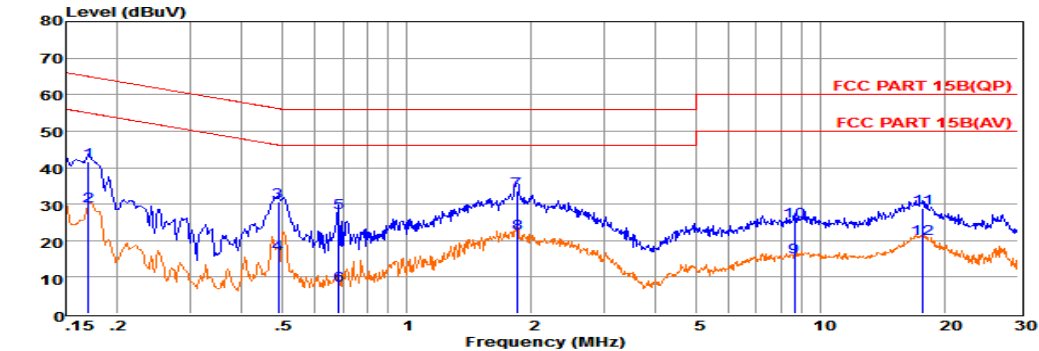

Env. Ins: 24*/56%
 EUT: Bluetooth Speaker
 Power Rating: AC 120V/60Hz
 Test Mode: TX-2402
 Operator: KYLE
 Memo:
 Pol: NEUTRAL

| | Freq | Reading | LisnFac | CabLos | Measured | Limit | Over | Remark |
|----|-------|---------|---------|--------|----------|-------|--------|---------|
| | MHz | dBpW | dB | dB | dBpW | dBpW | dB | |
| 1 | 0.17 | 21.98 | 9.65 | 0.02 | 41.65 | 64.94 | -23.29 | QP |
| 2 | 0.17 | 9.70 | 9.65 | 0.02 | 29.37 | 54.94 | -25.57 | Average |
| 3 | 0.49 | 11.03 | 9.62 | 0.04 | 30.69 | 56.19 | -25.50 | QP |
| 4 | 0.49 | -3.22 | 9.62 | 0.04 | 16.44 | 46.18 | -29.74 | Average |
| 5 | 0.69 | 7.96 | 9.63 | 0.04 | 27.63 | 56.00 | -28.37 | QP |
| 6 | 0.69 | -11.79 | 9.63 | 0.04 | 7.88 | 46.00 | -38.12 | Average |
| 7 | 1.85 | 14.02 | 9.63 | 0.05 | 33.70 | 56.00 | -22.30 | QP |
| 8 | 1.85 | 2.24 | 9.63 | 0.05 | 21.92 | 46.00 | -24.08 | Average |
| 9 | 8.64 | -4.32 | 9.71 | 0.08 | 15.47 | 50.00 | -34.53 | Average |
| 10 | 8.64 | 5.44 | 9.71 | 0.08 | 25.23 | 60.00 | -34.77 | QP |
| 11 | 17.66 | 9.04 | 9.79 | 0.11 | 28.94 | 60.00 | -31.06 | QP |
| 12 | 17.66 | 0.57 | 9.79 | 0.11 | 20.47 | 50.00 | -29.53 | Average |

Remarks: 1. Measured = Reading + Lisn Factor +Cable Loss.
 2. The emission levels that are 20dB below the official limit are not reported.

Note: Pre-scan all modes (AC 120V/60Hz&AC 240V/60Hz)and recorded the worst case results in this report.

8. ANTENNA REQUIREMENT

8.1 Standard Applicable

According to antenna requirement of §15.203.

An intentional radiator shall be designed to ensure that no antenna other than that furnished by the responsible party shall be used with the device. The use of a permanently attached antenna or of an antenna that uses a unique coupling to the intentional radiator shall be considered sufficient to comply with the provisions of this Section. The manufacturer may design the unit so that a broken antenna can be re-placed by the user, but the use of a standard antenna jack or electrical connector is prohibited. This requirement does not apply to carrier current devices or to devices operated under the provisions of Sections 15.211, 15.213, 15.217, 15.219, or 15.221. Further, this requirement does not apply to intentional radiators that must be professionally installed, such as perimeter protection systems and some field disturbance sensors, or to other intentional radiators which, in accordance with Section 15.31(d), must be measured at the installation site. However, the installer shall be responsible for ensuring that the proper antenna is employed so that the limits in this Part are not exceeded.

And according to §15.247(4)(1), system operating in the 2400-2483.5MHz bands that are used exclusively for fixed, point-to-point operations may employ transmitting antennas with directional gain greater than 6dBi provided the maximum peak output power of the intentional radiator is reduced by 1 dB for every 3 dB that the directional gain of the antenna exceeds 6dBi.

8.2 Antenna Connected Construction

8.2.1. Standard Applicable

According to § 15.203 & RSS-Gen, an intentional radiator shall be designed to ensure that no antenna other than that furnished by the responsible party shall be used with the device.

8.2.2. Antenna Connector Construction

The directional gains of antenna used for transmitting is 0.0dBi, and the antenna is connect to PCB board and no consideration of replacement. Please see EUT photo for details.

8.2.3. Results: Compliance.

-----THE END OF REPORT-----