

JVC

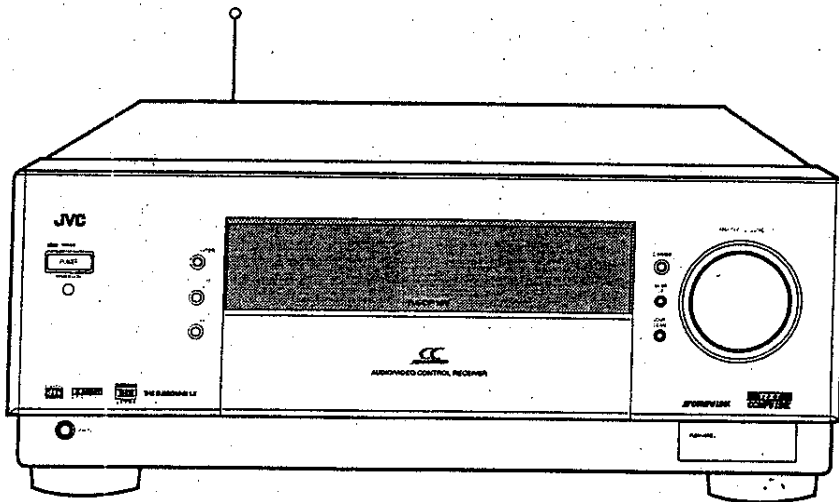

AUDIO/VIDEO CONTROL RECEIVER

RX-DP10VBK & RM-SRXDP10J

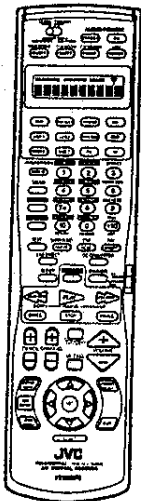

AV COMPU LINK

**TEXT
COMPU LINK**

DIGITAL
dts
SURROUND

DOLBY
DIGITAL

LUCASFILM
THX
ULTRA

THX SURROUND EX

INSTRUCTIONS

For Customer Use:

Enter below the Model No. and Serial No. which are located either on the rear, bottom or side of the cabinet. Retain this information for future reference.



Model No. _____

Serial No. _____

LVT0722-003A

[J]

Warnings, Cautions and Others/ Mises en garde, précautions et indications diverses

	CAUTION RISK OF ELECTRIC SHOCK DO NOT OPEN	
CAUTION: TO REDUCE THE RISK OF ELECTRIC SHOCK, DO NOT REMOVE COVER (OR BACK) NO USER SERVICEABLE PARTS INSIDE. REFER SERVICING TO QUALIFIED SERVICE PERSONNEL.		



The lightning flash with arrowhead symbol, within an equilateral triangle is intended to alert the user to the presence of uninsulated "dangerous voltage" within the product's enclosure that may be of sufficient magnitude to constitute a risk of electric shock to persons.



The exclamation point within an equilateral triangle is intended to alert the user to the presence of important operating and maintenance (servicing) instructions in the literature accompanying the appliance.

WARNING: TO REDUCE THE RISK OF FIRE OR ELECTRIC SHOCK, DO NOT EXPOSE THIS APPLIANCE TO RAIN OR MOISTURE.

CAUTION

To reduce the risk of electrical shocks, fire, etc.:

1. Do not remove screws, covers or cabinet.
2. Do not expose this appliance to rain or moisture.

ATTENTION

Afin d'éviter tout risque d'électrocution, d'incendie, etc.:

1. Ne pas enlever les vis ni les panneaux et ne pas ouvrir le coffret de l'appareil.
2. Ne pas exposer l'appareil à la pluie ni à l'humidité.

Note to CATV system installer:

This reminder is provided to call the CATV system installer's attention to Section 820-40 of the NEC which provides guidelines for proper grounding and, in particular, specifies that the cable ground shall be connected to the grounding system of the building, as close to the point of cable entry as practical.

Caution — POWER switch!

Disconnect the mains plug to shut the power off completely. The POWER switch in any position does not disconnect the mains line. The power can be remote controlled.

Attention — Commutateur POWER!

Déconnecter la fiche de secteur pour couper complètement le courant. Le commutateur POWER ne coupe jamais complètement la ligne de secteur, quelle que soit sa position. Le courant peut être télécommandé.

Caution — SPEAKER LOAD SELECTOR switch!

Match the position of SPEAKER LOAD SELECTOR switch on the back panel to the impedance of the speaker connected, to protect from overheating.

For the remote control:

This device complies with Part 15 of the FCC Rules. Operation is subject to the following two conditions: (1) This device may not cause harmful interference, and (2) this device must accept any interference received, including interference that may cause undesired operation.

Changes or modifications not expressly approved by the manufacturer for compliance could void the user's authority to operate the equipment.

For Canada/pour Le Canada

For the main unit / Pour l'appareil principal

THIS DIGITAL APPARATUS DOES NOT EXCEED THE CLASS B LIMITS FOR RADIO NOISE EMISSIONS FROM DIGITAL APPARATUS AS SET OUT IN THE INTERFERENCE-CAUSING EQUIPMENT STANDARD ENTITLED "DIGITAL APPARATUS," ICES-003 OF THE DEPARTMENT OF COMMUNICATIONS. CET APPAREIL NUMERIQUE RESPECTE LES LIMITES DE BRUITS RADIOELECTRIQUES APPLICABLES AUX APPAREILS NUMERIQUE DE CLASSE B PRESCRITES DANS LA NORME SUR LE MATERIEL BROUILLEUR; "APPAREILS NUMERIQUE", NMB-003 EDICTEE PAR LE MINISTRE DES COMMUNICATIONS.

For Canada/pour le Canada

CAUTION: TO PREVENT ELECTRIC SHOCK, MATCH WIDE BLADE OF PLUG TO WIDE SLOT, FULLY INSERT
ATTENTION: POUR EVITER LES CHOCS ELECTRIQUES INTRODUIRE LA LAME LA PLUS LARGE DE LA FICHE DANS LA BORNE CORRESPONDANTE DE LA PRISE ET POUSSER JUSQU'AU FOND

For the remote control / Pour la télécommande

This device complies with RSS-210 of Industry Canada Rules. Operation is subject to the following two conditions: (1) this device may not cause interference, and (2) this device must accept any interference, including interference that may cause undesired operation of the device.

Cet appareil est conforme au règlement CNR-210 de l'industrie du Canada. L'utilisation de ce dispositif est autorisée seulement aux conditions suivantes: (1) il ne doit pas produire de brouillage et (2) l'utilisateur du dispositif doit être prêt à accepter tout brouillage radioélectrique reçu, même si ce brouillage est susceptible de compromettre le fonctionnement du dispositif.

Caution: Proper Ventilation

To avoid risk of electric shock and fire and to protect from damage.

Locate the apparatus as follows:

- Front: No obstructions open spacing.
- Sides: No obstructions in 10 cm from the sides.
- Top: No obstructions in 10 cm from the top.
- Back: No obstructions in 15 cm from the back
- Bottom: No obstructions, place on the level surface.

In addition, maintain the best possible air circulation as illustrated.

Attention: Ventilation Correcte

Pour éviter les chocs électriques, l'incendie et tout autre dégât. Disposer l'appareil en tenant compte des impératifs suivants

- Avant: Rien ne doit gêner le dégagement
- Flancs: Laisser 10 cm de dégagement latéral
- Dessus: Laisser 10 cm de dégagement supérieur
- Arrière: Laisser 15 cm de dégagement arrière
- Dessous: Rien ne doit obstruer par dessous; poser l'appareil sur une surface plate.

Veiller également à ce que l'air circule le mieux possible comme illustré.

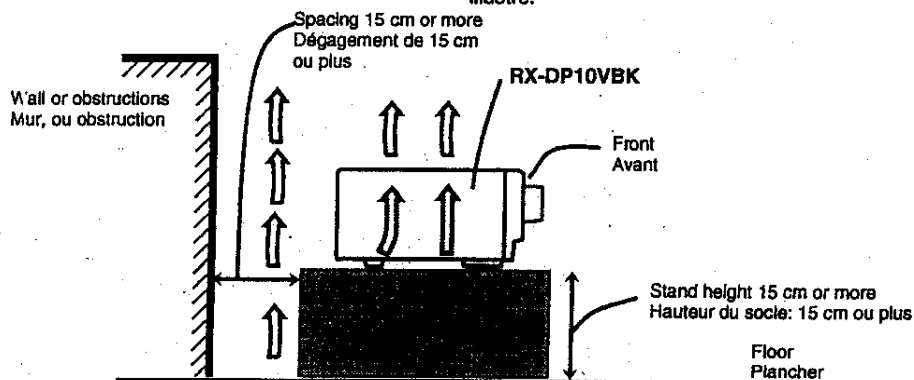

Remote Control

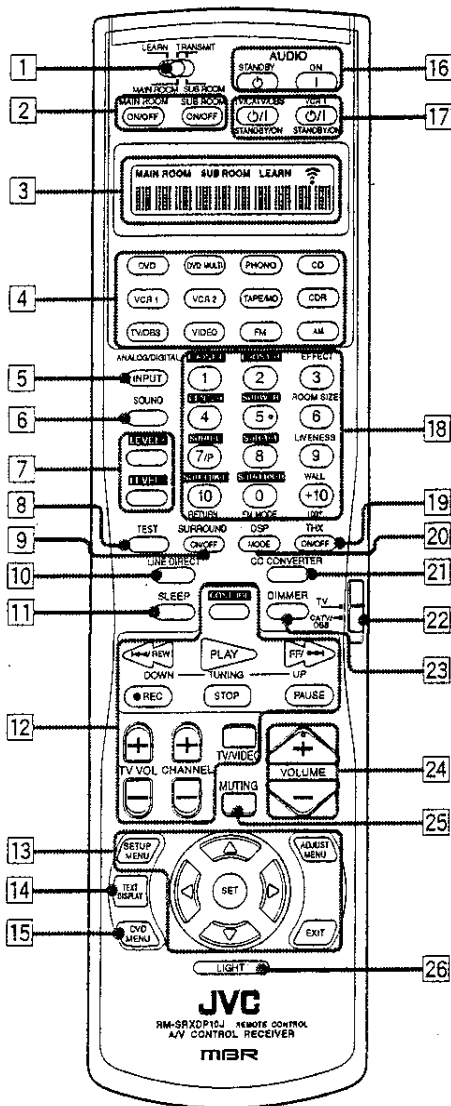

Remote's display window

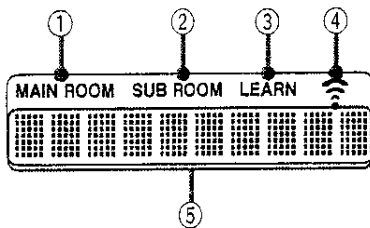

- 1 MAIN ROOM/SUB ROOM (LEARN/TRANSMIT) selector
- 2 MAIN ROOM ON/OFF button (21)
SUB ROOM ON/OFF button (28)
- 3 Display window
- 4 Source selecting buttons (18, 19, 21, 29)
 - DVD, DVD MULTI, PHONO, CD, VCR 1, VCR 2, TAPE/MD, CDR, TV/DBS, VIDEO, FM, AM

- 5 ANALOG/DIGITAL INPUT button (23)
- 6 SOUND button (49, 52, 64)
- 7 LEVEL +/- buttons (49, 64)
- 8 TEST button (49, 64)
- 9 SURROUND ON/OFF button (49, 64)
- 10 LINE DIRECT button (25)
- 11 SLEEP button (26)
- 12 Operating buttons for audio/video components (65 - 72)
- 13 On-screen operation buttons
 - SETUP MENU, ADJUST MENU, SET, EXIT, Δ (UP), ∇ (DOWN), ◀ (LEFT), ▶ (RIGHT) (34, 42, 57)
- 14 TEXT DISPLAY button (57)
- 15 DVD MENU button (66)
- 16 AUDIO buttons
 - STANDBY (⏻), ON (⏻) (18, 19, 20, 28)
- 17 TV/CATV/DBS STANDBY/ON (⏻/⏻) button (66 - 68)
VCR 1 STANDBY/ON (⏻/⏻) (66, 68, 69)
- 18
 - 10 keys for selecting preset channels (32)
 - 10 keys for adjusting sound (49)
 - 10 keys for adjusting DSP parameters (52)
 - 10 keys for operating audio/video components (64 - 72)
- 19 THX ON/OFF button (48)
- 20 DSP MODE button (52)
- 21 CC CONVERTER button (25)
- 22 TV operation mode selector (TV or CATV/DBS) (66 - 68, 72)
- 23 DIMMER button (25)
- 24 VOLUME +/- buttons (18, 19, 22, 29)
- 25 MUTING button (24, 30)
- 26 LIGHT button (16)

Remote's display window

- ① MAIN ROOM indicator
 - Lights up when you press a button on the remote control, with the MAIN ROOM/SUB ROOM (LEARN/TRANSMIT) selector is set to "MAIN ROOM." In this case, this remote control can be used only for main room operations.
- ② SUB ROOM indicator
 - Lights up when you press a button on the remote control, with the MAIN ROOM/SUB ROOM (LEARN/TRANSMIT) selector set to "SUB ROOM." In this case, this remote control can be used only for sub-room operations.
- ③ LEARN indicator
 - Lights up when you press a button on the remote control, with the MAIN ROOM/SUB ROOM (LEARN/TRANSMIT) selector set to "LEARN." In this case, this remote control cannot operate the receiver or other components, but can memorize IR signals.
- ④ Signal transmission indicator
 - Lights up when transmitting the remote control signals.
- ⑤ Remote control operation mode display
 - Remote control operation mode such as "DVD," "CD," "SOUND," etc. appears.
 - When the remote control operation mode changes, it is shown on this display for about 10 seconds.
 - (When showing the remote control operation mode just for confirmation, it is shown only for about 5 seconds—i.e. when pressing Number button 1 while the remote control operation mode is "CD," "CD" appears for about 5 seconds.)

Setting Up the RF Rod Antenna

The remote control supplied for this receiver can transmit both RF (Radio Frequency) signal as well as IR (infrared) signal. The RF rod antenna can receive the RF signals emitted from the remote control. So, with the RF rod antenna connected, you can operate the receiver at a distance of up to 15 m (50 feet) using RF signals sent from this receiver (more than twice as far as when using IR signals). Moreover, RF signals can go through walls and other objects in the house so you need not aim at the receiver directly.

However, if the antenna cannot receive signals stably, you cannot operate the receiver correctly.

- The signal-reachable distance may differ depending on the operating conditions and circumstances. To improve transmitting conditions, change the distance to the receiver and the direction to transmit while operating the remote control.
- Without the RF rod antenna connected, you can operate the receiver with the remote control, aiming the remote control directly at the remote sensor on the receiver.

To set up the RF rod antenna

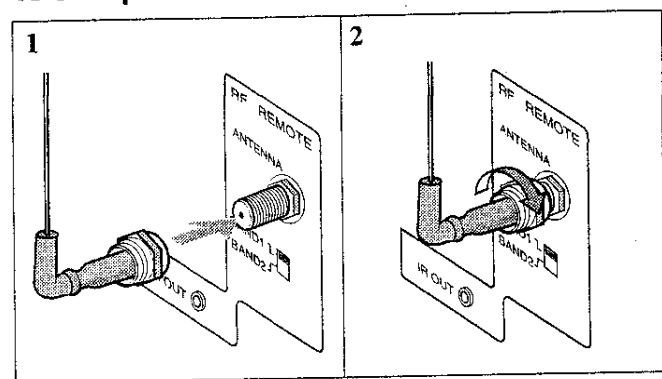

1. Insert the RF rod antenna to the RF REMOTE ANTENNA terminal.
2. Rotate the fixing nut to attach the RF rod antenna firmly.

Notes:

- To avoid a failure in the reception from the remote control, keep the connecting cables and the IR signal transmitter's cable away from the RF rod antenna.
- If your neighbour uses the same or similar RF remote control system, the receiver may happen to receive the RF signals sent from such an RF remote control system, which could cause your receiver to be operated unintentionally. If this happens, set the BAND selectors (both on the rear and on the remote control) to another band (either BAND 1 or BAND 2).

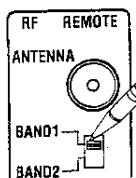

On the main unit's rear

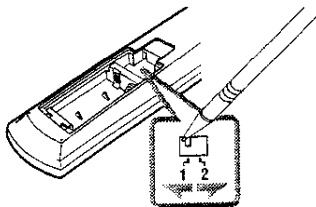

On remote control (Inside the battery compartment)

If the problem still persists, stop using the RF rod antenna and the remote control, and consult your JVC dealer or the nearest JVC Service Center.

The RF rod antenna and IR signal Transmitter

The combination of the RF rod antenna and the IR signal transmitter (below) allows you to use the Multi-room function more conveniently.

The remote control supplied for this receiver can transmit both RF signal and IR signal at the same time. This receiver catches the RF signals emitted from the remote control, and converts them into IR signals, then transmits the converted signals to the remote sensor on the other components through IR signal transmitter.

This means that you can control not only this receiver but also the other components from the sub-room.

Setting Up the IR Signal Transmitter

The IR signal transmitter can transmit the IR signals.

It allows you to use the AV COMPU LINK system, and to operate other manufacturers' components without aiming the remote control directly at the remote sensor on the target components. In addition, the IR signal transmitter reduces the possibility of malfunction.

- The IR signal transmitter may not operate the target components depending on the operating conditions and circumstances—including the aiming angle and direction of the IR signal transmitter at the remote sensors of the target components. If this occurs, changing its aiming angle and direction at the remote sensors may solve the problem.

To set up the IR signal transmitter

1. Find the place where you attach the IR signal transmitter.

- Place it where the signal can reach the remote sensor of the target components directly (in the line-of-sight).
- If the cord length of the IR signal transmitter is not long enough, use an extension cord (not supplied).

2. Attach the double-sided adhesive tape (supplied) to the IR signal transmitter.

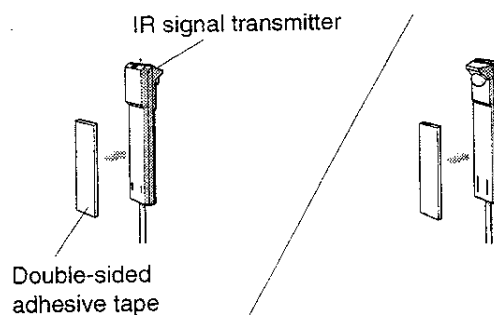

3. Connect the plug of the transmitter to the IR OUT jack of the receiver and attach the transmitter.

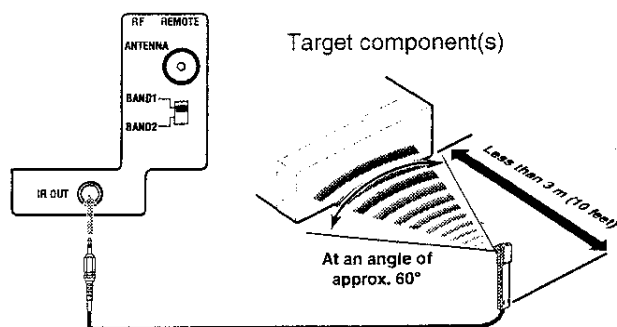

Signal-emitting angle of the transmitter

Horizontally: 60°

Vertically: 60°

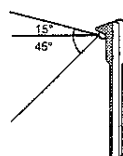
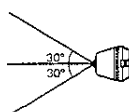

Connecting the Power Cord

Before plugging the receiver into an AC outlet, make sure that all connections have been made.

Plug the power cord into an AC outlet.

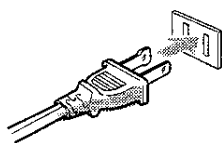

Keep the power cord away from the connecting cables and the antenna. The power cord may cause noise or screen interference. We recommend that you use a coaxial cable to connect the antenna, since it is well-shielded against interference.

Note:

The preset settings such as preset channels and sound adjustment may be erased in a few days in the following cases:

- When you unplug the power cord.
- When a power failure occurs.

CAUTIONS:

- Do not touch the power cord with wet hands.
- Do not pull on the power cord to unplug the cord. When unplugging the cord, always grasp the plug so as not to damage the cord.

Putting Batteries in the Remote Control

Before using the remote control, insert the two supplied batteries first.

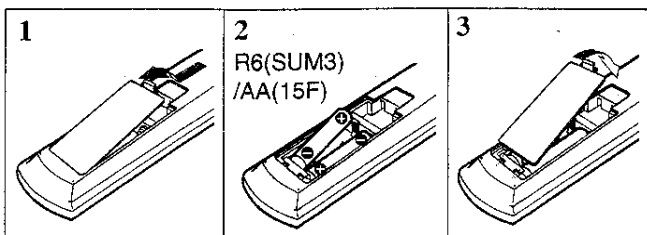

1. On the back of the remote control, remove the battery cover.

2. Insert the batteries.

- Make sure to match the polarity: (+) to (+) and (-) to (-).

3. Replace the cover.

If the remote control cannot transmit signals or operate the receiver correctly, replace the batteries. Use two R6(SUM3)/AA(15F) type dry-cell batteries.

- When the remote control transmits a signal, the signal transmission indicator on the remote's display lights up.

Notes:

- If you aim the remote control directly at the remote sensor on the receiver, you can operate the receiver at a distance of up to 7 m (23 feet).
- When replacing the batteries, finish it without delay; otherwise, the stored signals are all erased (see pages 67 and 71).

When using the remote control in the dark

Press LIGHT.

The buttons on the remote control are backlit while you are using the remote control.

If you do not press any button for about 5 seconds, the backlight will turn off.

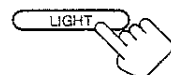

CAUTIONS:

Follow these precautions to avoid leaking or cracking cells:

- Place batteries in the remote control so they match the polarity: (+) to (+) and (-) to (-).
- Use the correct type of batteries. Batteries that look similar may differ in voltage.
- Always replace both batteries at the same time.
- Do not expose batteries to heat or flame.